

# NIST Handbook of Mathematical Functions

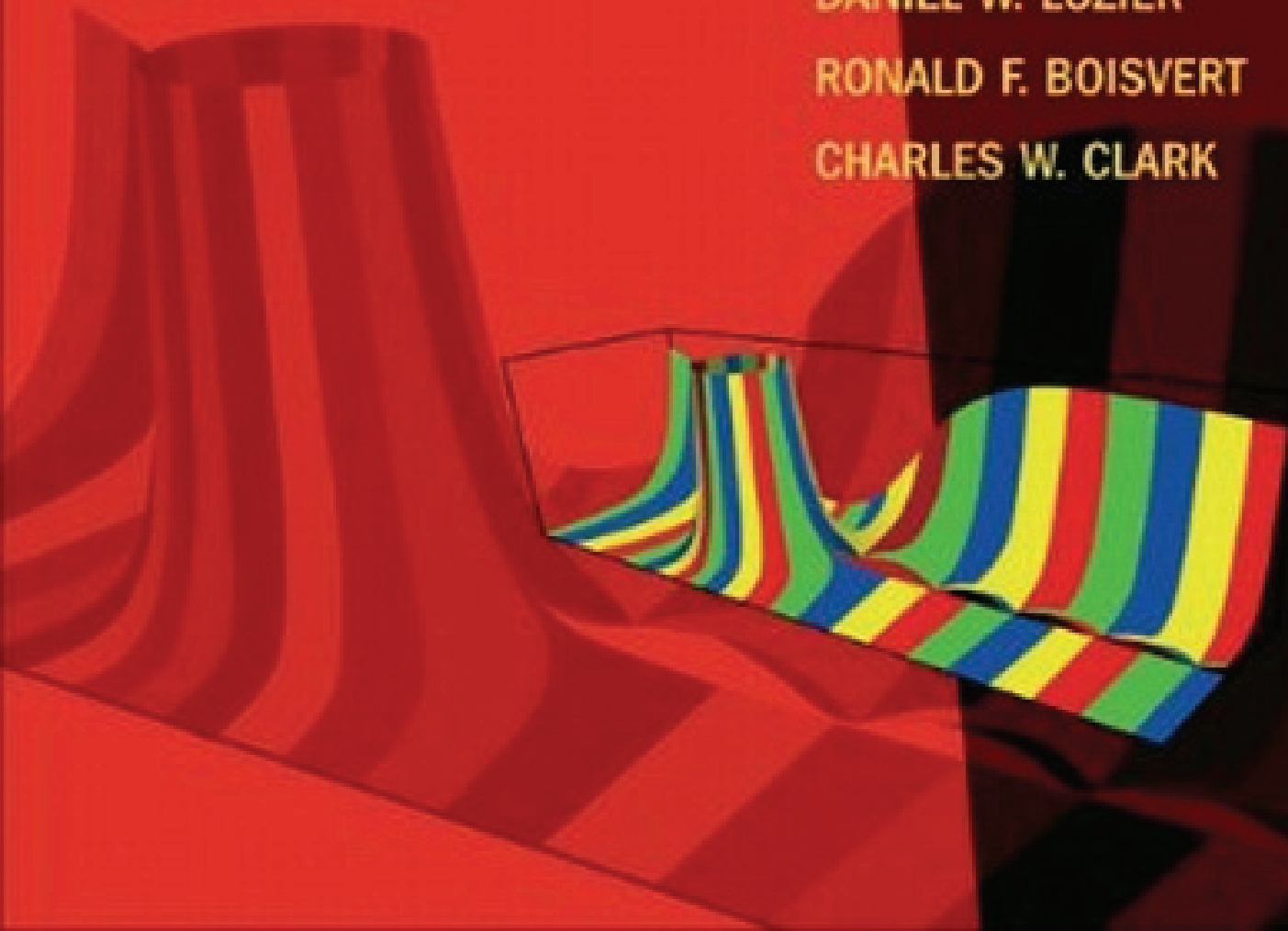
Edited by

FRANK W. J. OLVER

DANIEL W. LOZIER

RONALD F. BOISVERT

CHARLES W. CLARK



# NIST Handbook of Mathematical Functions

Modern developments in theoretical and applied science depend on knowledge of the properties of mathematical functions, from elementary trigonometric functions to the multitude of special functions. These functions appear whenever natural phenomena are studied, engineering problems are formulated, and numerical simulations are performed. They also crop up in statistics, financial models, and economic analysis. Using them effectively requires practitioners to have ready access to a reliable collection of their properties.

This handbook results from a 10-year project conducted by the National Institute of Standards and Technology with an international group of expert authors and validators. Printed in full color, it is destined to replace its predecessor, the classic but long-outdated *Handbook of Mathematical Functions*, edited by Abramowitz and Stegun. Included with every copy of the book is a CD with a searchable PDF.

Frank W. J. Olver is Professor Emeritus in the Institute for Physical Science and Technology and the Department of Mathematics at the University of Maryland. From 1961 to 1986 he was a Mathematician at the National Bureau of Standards in Washington, D.C. Professor Olver has published 76 papers in refereed and leading mathematics journals, and he is the author of *Asymptotics and Special Functions* (1974). He has served as editor of *SIAM Journal on Numerical Analysis*, *SIAM Journal on Mathematical Analysis*, *Mathematics of Computation*, *Methods and Applications of Analysis*, and the *NBS Journal of Research*.

Daniel W. Lozier leads the Mathematical Software Group in the Mathematical and Computational Sciences Division of NIST. He received his Ph.D. in applied mathematics from the University of Maryland in 1979 and has been at NIST since 1970. He is an active member of the SIAM Activity Group on Orthogonal Polynomials and Special Functions, having served two terms as chair and one as vice-chair, and currently is serving as secretary. He has been an editor of *Mathematics of Computation* and the *NIST Journal of Research*.

Ronald F. Boisvert leads the Mathematical and Computational Sciences Division of the Information Technology Laboratory at NIST. He received his Ph.D. in computer science from Purdue University in 1979 and has been at NIST since then. He has served as editor-in-chief of the *ACM Transactions on Mathematical Software*. He is currently co-chair of the Publications Board of the Association for Computing Machinery (ACM) and chair of the International Federation for Information Processing (IFIP) Working Group 2.5 (Numerical Software).

Charles W. Clark received his Ph.D. in physics from the University of Chicago in 1979. He is a member of the U.S. Senior Executive Service and Chief of the Electron and Optical Physics Division and acting Group Leader of the NIST Synchrotron Ultraviolet Radiation Facility (SURF III). Clark serves as Program Manager for Atomic and Molecular Physics at the U.S. Office of Naval Research and is a Fellow of the Joint Quantum Institute of NIST and the University of Maryland at College Park and a Visiting Professor at the National University of Singapore.

# Rainbow over Woolsthorpe Manor



From the frontispiece of the *Notes and Records of the Royal Society of London*, v. 36 (1981–82), with permission. Photograph by Dr. Roy L. Bishop, Physics Department, Acadia University, Nova Scotia, Canada, with permission.

## Commentary

The faint line below the main colored arc is a *supernumerary rainbow*, produced by the interference of different sun-rays traversing a raindrop and emerging in the same direction. For each color, the intensity profile across the rainbow is an Airy function. Airy invented his function in 1838 precisely to describe this phenomenon more accurately than Young had done in 1800 when pointing out that supernumerary rainbows require the wave theory of light and are impossible to explain with Newton's picture of light as a stream of independent corpuscles. The house in the picture is Newton's birthplace.

Sir Michael V. Berry  
H. H. Wills Physics Laboratory  
Bristol, United Kingdom

# NIST Handbook of Mathematical Functions

Frank W. J. Olver

*Editor-in-Chief and Mathematics Editor*

Daniel W. Lozier

*General Editor*

Ronald F. Boisvert

*Information Technology Editor*

Charles W. Clark

*Physical Sciences Editor*

**NIST**

**National Institute of  
Standards and Technology**  
U.S. Department of Commerce

and



**CAMBRIDGE**  
UNIVERSITY PRESS

CAMBRIDGE UNIVERSITY PRESS  
Cambridge, New York, Melbourne, Madrid, Cape Town, Singapore,  
São Paulo, Delhi, Dubai, Tokyo

Cambridge University Press  
32 Avenue of the Americas, New York, NY 10013-2473, USA

www.cambridge.org  
Information on this title: www.cambridge.org/9780521140638

© National Institute of Standards and Technology 2010

Pursuant to Title 17 USC 105, the National Institute of Standards and Technology (NIST), United States Department of Commerce, is authorized to receive and hold copyrights transferred to it by assignment or otherwise. Authors of the work appearing in this publication have assigned copyright to the work to NIST, United States Department of Commerce, as represented by the Secretary of Commerce. These works are owned by NIST.

Limited copying and internal distribution of the content of this publication is permitted for research and teaching. Reproduction, copying, or distribution for any commercial purpose is strictly prohibited. Bulk copying, reproduction, or redistribution in any form is not permitted. Questions regarding this copyright policy should be directed to NIST.

While NIST has made every effort to ensure the accuracy and reliability of the information in this publication, it is expressly provided "as is." NIST and Cambridge University Press together and separately make no warranty of any type, including warranties of merchantability or fitness for a particular purpose. NIST and Cambridge University Press together and separately make no warranties or representations as to the correctness, accuracy, or reliability of the information. As a condition of using it, you explicitly release NIST and Cambridge University Press from any and all liability for any damage of any type that may result from errors or omissions.

Certain products, commercial and otherwise, are mentioned in this publication. These mentions are for informational purposes only, and do not imply recommendation or endorsement by NIST.

All rights reserved.

This publication is in copyright. Subject to statutory exception and to the provisions of relevant collective licensing agreements, no reproduction of any part may take place without the written permission of Cambridge University Press.

First published 2010

Printed in the United States of America

*A catalog record for this publication is available from the British Library.*

ISBN 978-0-521-19225-5 Hardback  
ISBN 978-0-521-14063-8 Paperback

Additional resources for this publication at <http://dlmf.nist.gov/>.

Cambridge University Press and the National Institute of Standards and Technology have no responsibility for the persistence or accuracy of URLs for external or third-party Internet Web sites referred to in this publication and do not guarantee that any content on such Web sites is, or will remain, accurate or appropriate.

# Contents

	<b>Foreword</b> . . . . .	vii			
	<b>Preface</b> . . . . .	ix			
	<b>Mathematical Introduction</b> . . . . .	xiii			
1	<b>Algebraic and Analytic Methods</b>				
	R. Roy, F. W. J. Olver, R. A. Askey, R. Wong	1			
2	<b>Asymptotic Approximations</b>				
	F. W. J. Olver, R. Wong	41			
3	<b>Numerical Methods</b>				
	N. M. Temme	71			
4	<b>Elementary Functions</b>				
	R. Roy, F. W. J. Olver	103			
5	<b>Gamma Function</b>				
	R. A. Askey, R. Roy	135			
6	<b>Exponential, Logarithmic, Sine, and Cosine Integrals</b>				
	N. M. Temme	149			
7	<b>Error Functions, Dawson's and Fresnel Integrals</b>				
	N. M. Temme	159			
8	<b>Incomplete Gamma and Related Functions</b>				
	R. B. Paris	173			
9	<b>Airy and Related Functions</b>				
	F. W. J. Olver	193			
10	<b>Bessel Functions</b>				
	F. W. J. Olver, L. C. Maximon	215			
11	<b>Struve and Related Functions</b>				
	R. B. Paris	287			
12	<b>Parabolic Cylinder Functions</b>				
	N. M. Temme	303			
13	<b>Confluent Hypergeometric Functions</b>				
	A. B. Olde Daalhuis	321			
14	<b>Legendre and Related Functions</b>				
	T. M. Dunster	351			
15	<b>Hypergeometric Function</b>				
	A. B. Olde Daalhuis	383			
16	<b>Generalized Hypergeometric Functions and Meijer <math>G</math>-Function</b>				
	R. A. Askey, A. B. Olde Daalhuis	403			
17	<b><math>q</math>-Hypergeometric and Related Functions</b>				
	G. E. Andrews	419			
18	<b>Orthogonal Polynomials</b>				
	T. H. Koornwinder, R. Wong, R. Koekoek, R. F. Swarttouw	435			
19	<b>Elliptic Integrals</b>				
	B. C. Carlson	485			
20	<b>Theta Functions</b>				
	W. P. Reinhardt, P. L. Walker	523			
21	<b>Multidimensional Theta Functions</b>				
	B. Deconinck	537			
22	<b>Jacobian Elliptic Functions</b>				
	W. P. Reinhardt, P. L. Walker	549			
23	<b>Weierstrass Elliptic and Modular Functions</b>				
	W. P. Reinhardt, P. L. Walker	569			
24	<b>Bernoulli and Euler Polynomials</b>				
	K. Dilcher	587			
25	<b>Zeta and Related Functions</b>				
	T. M. Apostol	601			
26	<b>Combinatorial Analysis</b>				
	D. M. Bressoud	617			
27	<b>Functions of Number Theory</b>				
	T. M. Apostol	637			
28	<b>Mathieu Functions and Hill's Equation</b>				
	G. Wolf	651			
29	<b>Lamé Functions</b>				
	H. Volkmer	683			
30	<b>Spheroidal Wave Functions</b>				
	H. Volkmer	697			
31	<b>Heun Functions</b>				
	B. D. Sleeman, V. B. Kuznetsov	709			
32	<b>Painlevé Transcendents</b>				
	P. A. Clarkson	723			
33	<b>Coulomb Functions</b>				
	I. J. Thompson	741			
34	<b><math>3j, 6j, 9j</math> Symbols</b>				
	L. C. Maximon	757			
35	<b>Functions of Matrix Argument</b>				
	D. St. P. Richards	767			
36	<b>Integrals with Coalescing Saddles</b>				
	M. V. Berry, C. J. Howls	775			
	<b>Bibliography</b> . . . . .	795			
	<b>Notations</b> . . . . .	873			
	<b>Index</b> . . . . .	887			



# Foreword

In 1964 the National Institute of Standards and Technology<sup>1</sup> published the *Handbook of Mathematical Functions with Formulas, Graphs, and Mathematical Tables*, edited by Milton Abramowitz and Irene A. Stegun. That 1046-page tome proved to be an invaluable reference for the many scientists and engineers who use the special functions of applied mathematics in their day-to-day work, so much so that it became the most widely distributed and most highly cited NIST publication in the first 100 years of the institution's existence.<sup>2</sup> The success of the original handbook, widely referred to as "Abramowitz and Stegun" ("A&S"), derived not only from the fact that it provided critically useful scientific data in a highly accessible format, but also because it served to standardize definitions and notations for special functions. The provision of standard reference data of this type is a core function of NIST.

Much has changed in the years since A&S was published. Certainly, advances in applied mathematics have continued unabated. However, we have also seen the birth of a new age of computing technology, which has not only changed how we utilize special functions, but also how we communicate technical information. The document you are now holding, or the Web page you are now reading, represents an effort to extend the legacy of A&S well into the 21st century. The new printed volume, the *NIST Handbook of Mathematical Functions*, serves a similar function as the original A&S, though it is heavily updated and extended. The online version, the *NIST Digital Library of Mathematical Functions (DLMF)*, presents the same technical information along with extensions and innovative interactive features consistent with the new medium. The DLMF may well serve as a model for the effective presentation of highly mathematical reference material on the Web.

The production of these new resources has been a very complex undertaking some 10 years in the making. This could not have been done without the cooperation of many mathematicians, information technologists, and physical scientists both within NIST and externally. Their unflinching dedication is acknowledged deeply and gratefully. Particular attention is called to the generous support of the National Science Foundation, which made possible the participation of experts from academia and research institutes worldwide.

*Dr. Patrick D. Gallagher*  
*Director, NIST*  
November 20, 2009  
Gaithersburg, Maryland

---

<sup>1</sup>Then known as the National Bureau of Standards.

<sup>2</sup>D. R. Lide (ed.), *A Century of Excellence in Measurement, Standards, and Technology*, CRC Press, 2001.





# Preface

The *NIST Handbook of Mathematical Functions*, together with its Web counterpart, the *NIST Digital Library of Mathematical Functions (DLMF)*, is the culmination of a project that was conceived in 1996 at the National Institute of Standards and Technology (NIST). The project had two equally important goals: to develop an authoritative replacement for the highly successful *Handbook of Mathematical Functions with Formulas, Graphs, and Mathematical Tables*, published in 1964 by the National Bureau of Standards (M. Abramowitz and I. A. Stegun, editors); and to disseminate essentially the same information from a public Web site operated by NIST. The new Handbook and DLMF are the work of many hands: editors, associate editors, authors, validators, and numerous technical experts. A summary of the responsibilities of these groups may help in understanding the structure and results of this project.

Executive responsibility was vested in the editors: Frank W. J. Olver (University of Maryland, College Park, and NIST), Daniel W. Lozier (NIST), Ronald F. Boisvert (NIST), and Charles W. Clark (NIST). Olver was responsible for organizing and editing the mathematical content after receiving it from the authors; for communicating with the associate editors, authors, validators, and other technical experts; and for assembling the **Notations** section and the **Index**. In addition, Olver was author or co-author of five chapters. Lozier directed the NIST research, technical, and support staff associated with the project, administered grants and contracts, together with Boisvert compiled the **Software** sections for the Web version of the chapters, conducted editorial and staff meetings, represented the project within NIST and at professional meetings in the United States and abroad, and together with Olver carried out the day-to-day development of the project. Boisvert and Clark were responsible for advising and assisting in matters related to the use of information technology and applications of special functions in the physical sciences (and elsewhere); they also participated in the resolution of major administrative problems when they arose.

The associate editors are eminent domain experts who were recruited to advise the project on strategy, execution, subject content, format, and presentation, and to help identify and recruit suitable candidate authors and validators. The associate editors were:

Richard A. Askey  
University of Wisconsin, Madison

Michael V. Berry  
University of Bristol

Walter Gautschi (resigned 2002)  
Purdue University

Leonard C. Maximon  
George Washington University

Morris Newman  
University of California, Santa Barbara

Ingram Olkin  
Stanford University

Peter Paule  
Johannes Kepler University

William P. Reinhardt  
University of Washington

Nico M. Temme  
Centrum voor Wiskunde en Informatica

Jet Wimp (resigned 2001)  
Drexel University

The technical information provided in the Handbook and DLMF was prepared by subject experts from around the world. They are identified on the title pages of the chapters for which they served as authors and in the table of Contents.

The validators played a critical role in the project, one that was absent in its 1964 counterpart: to provide critical, independent reviews during the development of each chapter, with attention to accuracy and appropriateness of subject coverage. These reviews have contributed greatly to the quality of the product. The validators were:

T. M. Apostol  
California Institute of Technology

A. R. Barnett  
University of Waikato, New Zealand

A. I. Bobenko  
Technische Universität, Berlin

B. B. L. Braaksma  
University of Groningen

D. M. Bressoud  
Macalester College

B. C. Carlson  
Iowa State University

B. Deconinck  
University of Washington

T. M. Dunster  
University of California, San Diego

A. Gil  
Universidad de Cantabria

A. R. Its  
Indiana University–Purdue University, Indianapolis

B. R. Judd  
Johns Hopkins University

R. Koekoek  
Delft University of Technology

T. H. Koornwinder  
University of Amsterdam

R. J. Muirhead  
Pfizer Global R&D

E. Neuman  
University of Illinois, Carbondale

A. B. Olde Daalhuis  
University of Edinburgh

R. B. Paris  
University of Abertay Dundee

R. Roy  
Beloit College

S. N. M. Ruijsenaars  
University of Leeds

J. Segura  
Universidad de Cantabria

R. F. Swarttouw  
Vrije Universiteit Amsterdam

N. M. Temme  
Centrum voor Wiskunde en Informatica

H. Volkmer  
University of Wisconsin, Milwaukee

G. Wolf  
Universität Duisberg-Essen

R. Wong  
City University of Hong Kong

All of the mathematical information contained in the Handbook is also contained in the DLMF, along with additional features such as more graphics, expanded tables, and higher members of some families of formulas; in consequence, in the Handbook there are occasional gaps in the numbering sequences of equations, tables, and figures. The Web address where additional DLMF content can be found is printed in blue at appropriate places in the Handbook. The home page of the DLMF is accessible at <http://dlmf.nist.gov/>.

The DLMF has been constructed specifically for effective Web usage and contains features unique to Web presentation. The Web pages contain many active links, for example, to the definitions of symbols within the DLMF, and to external sources of reviews, full texts of articles, and items of mathematical software. Advanced capabilities have been developed at NIST for the DLMF, and also as part of a larger research effort intended to promote the use of the Web as a tool for doing mathematics. Among these capabilities are: a facility to allow users to download LaTeX and MathML encodings of every formula into document processors and software packages (eventually, a fully semantic downloading capability may be possible); a search engine that allows users to locate formulas based on queries expressed in mathematical notation; and user-manipulable 3-dimensional color graphics.

Production of the Handbook and DLMF was a mammoth undertaking, made possible by the dedicated leadership of Bruce R. Miller (NIST), Bonita V. Saunders (NIST), and Abdou S. Youssef (George Washington University and NIST). Miller was responsible for information architecture, specializing LaTeX for the needs of the project, translation from LaTeX to MathML, and the search interface. Saunders was responsible for mesh generation for curves and surfaces, data computation and validation, graphics production, and interactive Web visualization. Youssef was responsible for mathematics search indexing and query processing. They were assisted by the following NIST staff: Marjorie A. McClain (LaTeX, bibliography), Joyce E. Conlon (bibliography), Gloria Wiersma (LaTeX), Qiming Wang (graphics generation, graphics viewers), and Brian Antonishek (graphics viewers).

The editors acknowledge the many other individuals who contributed to the project in a variety of ways. Among the research, technical, and support staff at NIST these are B. K. Alpert, T. M. G. Arrington, R. Bickel, B. Blaser, P. T. Boggs, S. Burley, G. Chu, A. Dienstfrey, M. J. Donahue, K. R. Eberhardt, B. R. Fabijonas, M. Fancher, S. Fletcher, J. Fowler, S. P. Frechette, C. M. Furlani, K. B. Gebbie, C. R. Hagwood, A. N. Heckert, M. Huber, P. K. Janert, R. N. Kacker, R. F. Kayser, P. M. Ketcham, E. Kim, M. J. Lieber-

man, R. R. Lipman, M. S. Madsen, E. A. P. Mai, W. Mehuron, P. J. Mohr, S. Olver, D. R. Penn, S. Phoha, A. Possolo, S. P. Ressler, M. Rubin, J. Rumble, C. A. Schanzle, B. I. Schneider, N. Sedransk, E. L. Shirley, G. W. Stewart, C. P. Sturrock, G. Thakur, S. Wakid, and S. F. Zevin. Individuals from outside NIST are S. S. Antman, A. M. Ashton, C. M. Bender, J. J. Benedetto, R. L. Bishop, J. M. Borwein, H. W. Braden, C. Brezinski, F. Chyzak, J. N. L. Connor, R. Cools, A. Cuyt, I. Daubechies, P. J. Davis, C. F. Dunkl, J. P. Goedbloed, B. Gordon, J. W. Jenkins, L. H. Kellogg, C. D. Kemp, K. S. Kölbig, S. G. Krantz, M. D. Kruskal, W. Lay, D. A. Lutz, E. L. Mansfield, G. Marsaglia, B. M. McCoy, W. Miller, Jr., M. E. Muldoon, S. P. Novikov, P. J. Olver, W. C. Parke, M. Petkovsek, W. H. Reid, B. Salvy, C. Schneider, M. J. Seaton, N. C. Severo, I. A. Stegun, F. Stenger, M. Steuerwalt, W. G. Strang, P. R. Turner, J. Van Deun, M. Vuorinen, E. J. Weniger, H. Wiersma, R. C. Winther, D. B. Zagier, and M. Zelen. Undoubtedly, the editors have overlooked some individuals who contributed, as is inevitable in a large long-lasting project. Any oversight is unintentional, and the editors apologize in advance.

The project was funded in part by NSF Award 9980036, administered by the NSF's Knowledge and Distributed Intelligence Program. Within NIST financial resources and staff were committed by the Informa-

tion Technology Laboratory, Physics Laboratory, Systems Integration for Manufacturing Applications Program of the Manufacturing Engineering Laboratory, Standard Reference Data Program, and Advanced Technology Program.

Notwithstanding the great care that has been exercised by the editors, authors, validators, and the NIST staff, it is almost inevitable that in a work of the magnitude and scope of the NIST Handbook and DLMF errors will still be present. Users need to be aware that none of these individuals nor the National Institute of Standards and Technology can assume responsibility for any possible consequences of such errors.

Lastly, the editors appreciate the skill, and long experience, that was brought to bear by the publisher, Cambridge University Press, on the production and publication of the new Handbook.

Frank W. J. Olver

*Editor-in-Chief and Mathematics Editor*

Daniel W. Lozier

*General Editor*

Ronald F. Boisvert

*Information Technology Editor*

Charles W. Clark

*Physical Sciences Editor*



# Mathematical Introduction

## Organization and Objective

The mathematical content of the *NIST Handbook of Mathematical Functions* has been produced over a ten-year period. This part of the project has been carried out by a team comprising the mathematics editor, authors, validators, and the NIST professional staff. Also, valuable initial advice on all aspects of the project was provided by ten external associate editors.

The NIST Handbook has essentially the same objective as the *Handbook of Mathematical Functions* that was issued in 1964 by the National Bureau of Standards as Number 55 in the NBS Applied Mathematics Series (AMS). This objective is to provide a reference tool for researchers and other users in applied mathematics, the physical sciences, engineering, and elsewhere who encounter special functions in the course of their everyday work.

The mathematical project team has endeavored to take into account the hundreds of research papers and numerous books on special functions that have appeared since 1964. As a consequence, in addition to providing more information about the special functions that were covered in AMS 55, the NIST Handbook includes several special functions that have appeared in the interim in applied mathematics, the physical sciences, and engineering, as well as in other areas. See, for example, Chapters 16, 17, 18, 19, 21, 27, 29, 31, 32, 34, 35, and 36.

Two other ways in which this Handbook differs from AMS 55, and other handbooks, are as follows.

First, the editors instituted a validation process for the whole technical content of each chapter. This process greatly extended normal editorial checking procedures. All chapters went through several drafts (nine in some cases) before the authors, validators, and editors were fully satisfied.

Secondly, as described in the **Preface**, a Web version (the NIST DLMF) is also available.

## Methodology

The first three chapters of the NIST Handbook and DLMF are methodology chapters that provide detailed coverage of, and references for, mathematical topics that are especially important in the theory, computation, and application of special functions. (These chapters can also serve as background material for university

graduate courses in complex variables, classical analysis, and numerical analysis.)

Particular care is taken with topics that are not dealt with sufficiently thoroughly from the standpoint of this Handbook in the available literature. These include, for example, multivalued functions of complex variables, for which new definitions of branch points and principal values are supplied (§§1.10(vi), 4.2(i)); the Dirac delta (or delta function), which is introduced in a more readily comprehensible way for mathematicians (§1.17); numerically satisfactory solutions of differential and difference equations (§§2.7(iv), 2.9(i)); and numerical analysis for complex variables (Chapter 3).

In addition, there is a comprehensive account of the great variety of analytical methods that are used for deriving and applying the extremely important asymptotic properties of the special functions, including double asymptotic properties (Chapter 2 and §§10.41(iv), 10.41(v)).

## Notation for the Special Functions

The first section in each of the special function chapters (Chapters 5–36) lists notation that has been adopted for the functions in that chapter. This section may also include important alternative notations that have appeared in the literature. With a few exceptions the adopted notations are the same as those in standard applied mathematics and physics literature.

The exceptions are ones for which the existing notations have drawbacks. For example, for the hypergeometric function we often use the notation  $\mathbf{F}(a, b; c; z)$  (§15.2(i)) in place of the more conventional  ${}_2F_1(a, b; c; z)$  or  $F(a, b; c; z)$ . This is because  $\mathbf{F}$  is akin to the notation used for Bessel functions (§10.2(ii)), inasmuch as  $\mathbf{F}$  is an entire function of each of its parameters  $a$ ,  $b$ , and  $c$ : this results in fewer restrictions and simpler equations. Similarly in the case of confluent hypergeometric functions (§13.2(i)).

Other examples are: (a) the notation for the Ferrers functions—also known as associated Legendre functions on the cut—for which existing notations can easily be confused with those for other associated Legendre functions (§14.1); (b) the spherical Bessel functions for which existing notations are unsymmetric and inelegant (§§10.47(i) and 10.47(ii)); and (c) elliptic integrals for which both Legendre’s forms and the more recent symmetric forms are treated fully (Chapter 19).

The **Notations** section beginning on p. 873 includes all the notations for the special functions adopted in this Handbook. In the corresponding section for the DLMF some of the alternative notations that appear in the first section of the special function chapters are also included.

## Common Notations and Definitions

$\mathbb{C}$	complex plane (excluding infinity).
D	decimal places.
det	determinant.
$\delta_{j,k}$ or $\delta_{jk}$	Kronecker delta: 0 if $j \neq k$ ; 1 if $j = k$ .
$\Delta$ (or $\Delta_x$ )	forward difference operator: $\Delta f(x) = f(x+1) - f(x)$ .
$\nabla$ (or $\nabla_x$ )	backward difference operator: $\nabla f(x) = f(x) - f(x-1)$ . (See also del operator in the <b>Notations</b> section.)
empty sums	zero.
empty products	unity.
$\in$	element of.
$\notin$	not an element of.
$\forall$	for every.
$\implies$	implies.
$\iff$	is equivalent to.
$n!$	factorial: $1 \cdot 2 \cdot 3 \cdots n$ if $n = 1, 2, 3, \dots$ ; 1 if $n = 0$ .
$n!!$	double factorial: $2 \cdot 4 \cdot 6 \cdots n$ if $n = 2, 4, 6, \dots$ ; $1 \cdot 3 \cdot 5 \cdots n$ if $n = 1, 3, 5, \dots$ ; 1 if $n = 0, -1$ .
$\lfloor x \rfloor$	floor or integer part: the integer such that $x - 1 < \lfloor x \rfloor \leq x$ , with $x$ real.
$\lceil x \rceil$	ceiling: the integer such that $x \leq \lceil x \rceil < x + 1$ , with $x$ real.
$f(z) _C = 0$	$f(z)$ is continuous at all points of a simple closed contour $C$ in $\mathbb{C}$ .
$< \infty$	is finite, or converges.
$\gg$	much greater than.
$\Im$	imaginary part.
iff	if and only if.
inf	greatest lower bound (infimum).
sup	least upper bound (supremum).
$\cap$	intersection.
$\cup$	union.
$(a, b)$	open interval in $\mathbb{R}$ , or open straight-line segment joining $a$ and $b$ in $\mathbb{C}$ .
$[a, b]$	closed interval in $\mathbb{R}$ , or closed straight-line segment joining $a$ and $b$ in $\mathbb{C}$ .
$(a, b]$ or $[a, b)$	half-closed intervals.

$\subset$	is contained in.
$\subseteq$	is, or is contained in.
lim inf	least limit point.
$[a_{j,k}]$ or $[a_{jk}]$	matrix with $(j, k)$ th element $a_{j,k}$ or $a_{jk}$ .
$\mathbf{A}^{-1}$	inverse of matrix $\mathbf{A}$ .
tr $\mathbf{A}$	trace of matrix $\mathbf{A}$ .
$\mathbf{A}^T$	transpose of matrix $\mathbf{A}$ .
$\mathbf{I}$	unit matrix.
mod or modulo	$m \equiv n \pmod{p}$ means $p$ divides $m - n$ , where $m, n$ , and $p$ are positive integers with $m > n$ .
$\mathbb{N}$	set of all positive integers.
$(\alpha)_n$	Pochhammer's symbol: $\alpha(\alpha+1)(\alpha+2)\cdots(\alpha+n-1)$ if $n = 1, 2, 3, \dots$ ; 1 if $n = 0$ .
$\mathbb{Q}$	set of all rational numbers.
$\mathbb{R}$	real line (excluding infinity).
$\Re$	real part.
res	residue.
S	significant figures.
sign $x$	-1 if $x < 0$ ; 0 if $x = 0$ ; 1 if $x > 0$ .
$\setminus$	set subtraction.
$\mathbb{Z}$	set of all integers.
$n\mathbb{Z}$	set of all integer multiples of $n$ .

## Graphics

Special functions with one real variable are depicted graphically with conventional two-dimensional (2D) line graphs. See, for example, Figures 10.3.1–10.3.4.

With two real variables, special functions are depicted as 3D surfaces, with vertical height corresponding to the value of the function, and coloring added to emphasize the 3D nature. See Figures 10.3.5–10.3.8 for examples.

Special functions with a complex variable are depicted as colored 3D surfaces in a similar way to functions of two real variables, but with the vertical height corresponding to the modulus (absolute value) of the function. See, for example, Figures 5.3.4–5.3.6. However, in many cases the coloring of the surface is chosen instead to indicate the quadrant of the plane to which the phase of the function belongs, thereby achieving a 4D effect. In these cases the phase colors that correspond to the 1st, 2nd, 3rd, and 4th quadrants are arranged in alphabetical order: blue, green, red, and yellow, respectively, and a “Quadrant Colors” icon appears alongside the figure. See, for example, Figures 10.3.9–10.3.16.

Lastly, users may notice some lack of smoothness in the color boundaries of some of the 4D-type surfaces; see, for example, Figure 10.3.9. This nonsmoothness arises because the mesh that was used to generate the

figure was optimized only for smoothness of the surface, and not for smoothness of the color boundaries.

## Applications

All of the special function chapters include sections devoted to mathematical, physical, and sometimes other applications of the main functions in the chapter. The purpose of these sections is simply to illustrate the importance of the functions in other disciplines; no attempt is made to provide exhaustive coverage.

## Computation

All of the special function chapters contain sections that describe available methods for computing the main functions in the chapter, and most also provide references to numerical tables of, and approximations for, these functions. In addition, the DLMF provides references to research papers in which software is developed, together with links to sites where the software can be obtained.

In referring to the numerical tables and approximations we use notation typified by  $x = 0(.05)1$ , 8D or 8S. This means that the variable  $x$  ranges from 0 to 1 in intervals of 0.05, and the corresponding function values are tabulated to 8 decimal places or 8 significant figures.

Another numerical convention is that decimals followed by dots are unrounded; without the dots they are rounded. For example, to 4D  $\pi$  is 3.1415... (unrounded) and 3.1416 (rounded).

## Verification

For all equations and other technical information this Handbook and the DLMF either provide references to the literature for proof or describe steps that can be followed to construct a proof. In the Handbook this information is grouped at the section level and appears under the heading **Sources** in the **References** section. In the DLMF this information is provided in pop-up windows at the subsection level.

For equations or other technical information that appeared previously in AMS 55, the DLMF usually includes the corresponding AMS 55 equation number, or other form of reference, together with corrections, if needed. However, none of these citations are to be regarded as supplying proofs.

## Special Acknowledgment

I pay tribute to my friend and predecessor Milton Abramowitz. His genius in the creation of the *National Bureau of Standards Handbook of Mathematical Functions* paid enormous dividends to the world's scientific, mathematical, and engineering communities, and paved the way for the development of the *NIST Handbook of Mathematical Functions* and *NIST Digital Library of Mathematical Functions*.

Frank W. J. Olver, *Mathematics Editor*





## Chapter 1

# Algebraic and Analytic Methods

R. Roy<sup>1</sup>, F. W. J. Olver<sup>2</sup>, R. A. Askey<sup>3</sup> and R. Wong<sup>4</sup>

<b>Notation</b>	<b>2</b>	1.10 Functions of a Complex Variable . . . . .	18
1.1 Special Notation . . . . .	2	1.11 Zeros of Polynomials . . . . .	22
<b>Areas</b>	<b>2</b>	1.12 Continued Fractions . . . . .	24
1.2 Elementary Algebra . . . . .	2	1.13 Differential Equations . . . . .	25
1.3 Determinants . . . . .	3	1.14 Integral Transforms . . . . .	27
1.4 Calculus of One Variable . . . . .	4	1.15 Summability Methods . . . . .	33
1.5 Calculus of Two or More Variables . . . . .	7	1.16 Distributions . . . . .	35
1.6 Vectors and Vector-Valued Functions . . . . .	9	1.17 Integral and Series Representations of the Dirac Delta . . . . .	37
1.7 Inequalities . . . . .	12	<b>References</b>	<b>39</b>
1.8 Fourier Series . . . . .	13		
1.9 Calculus of a Complex Variable . . . . .	14		

<sup>1</sup>Department of Mathematics and Computer Science, Beloit College, Beloit, Wisconsin.

<sup>2</sup>Institute for Physical Science and Technology and Department of Mathematics, University of Maryland, College Park, Maryland.

<sup>3</sup>Department of Mathematics, University of Wisconsin, Madison, Wisconsin.

<sup>4</sup>Liu Bie Ju Centre for Mathematical Sciences, City University of Hong Kong, Kowloon, Hong Kong.

**Acknowledgments:** The authors thank Leonard Maximon and William Parke for their assistance with the writing of §1.17.

**Copyright** © 2009 National Institute of Standards and Technology. All rights reserved.

## Notation

### 1.1 Special Notation

(For other notation see pp. xiv and 873.)

$x, y$	real variables.
$z$	real variable in §§1.5–1.6.
$z, w$	complex variables in §§1.9–1.11.
$j, k, \ell$	integers.
$m, n$	nonnegative integers, unless specified otherwise.
$\langle f, g \rangle$	distribution.
deg	degree.
primes	derivatives with respect to the variable, except where indicated otherwise.

## Areas

### 1.2 Elementary Algebra

#### 1.2(i) Binomial Coefficients

In (1.2.1)–(1.2.5)  $k$  and  $n$  are nonnegative integers and  $k \leq n$ .

$$1.2.1 \quad \binom{n}{k} = \frac{n!}{(n-k)!k!} = \binom{n}{n-k}.$$

#### Binomial Theorem

$$1.2.2 \quad (a+b)^n = a^n + \binom{n}{1}a^{n-1}b + \binom{n}{2}a^{n-2}b^2 + \cdots + \binom{n}{n-1}ab^{n-1} + b^n.$$

$$1.2.3 \quad \binom{n}{0} + \binom{n}{1} + \cdots + \binom{n}{n} = 2^n.$$

$$1.2.4 \quad \binom{n}{0} - \binom{n}{1} + \cdots + (-1)^n \binom{n}{n} = 0.$$

$$1.2.5 \quad \binom{n}{0} + \binom{n}{2} + \binom{n}{4} + \cdots + \binom{n}{k} = 2^{n-1},$$

where  $k$  is  $n$  or  $n-1$  according as  $n$  is even or odd.

In (1.2.6)–(1.2.9)  $k$  and  $m$  are nonnegative integers and  $n$  is unrestricted.

$$1.2.6 \quad \binom{n}{k} = \frac{n(n-1)\cdots(n-k+1)}{k!} \\ = \frac{(-1)^k (-n)_k}{k!} = (-1)^k \binom{k-n-1}{k}.$$

$$1.2.7 \quad \binom{n+1}{k} = \binom{n}{k} + \binom{n}{k-1}.$$

$$1.2.8 \quad \sum_{k=0}^m \binom{n+k}{k} = \binom{n+m+1}{m}.$$

$$1.2.9 \quad \binom{n}{0} - \binom{n}{1} + \cdots + (-1)^m \binom{n}{m} = (-1)^m \binom{n-1}{m}.$$

#### 1.2(ii) Finite Series

##### Arithmetic Progression

$$1.2.10 \quad a + (a+d) + (a+2d) + \cdots + (a+(n-1)d) \\ = na + \frac{1}{2}n(n-1)d = \frac{1}{2}n(a+\ell),$$

where  $\ell$  = last term of the series =  $a + (n-1)d$ .

##### Geometric Progression

$$1.2.11 \quad a + ax + ax^2 + \cdots + ax^{n-1} \\ = \frac{a(1-x^n)}{1-x}, \quad x \neq 1.$$

#### 1.2(iii) Partial Fractions

Let  $\alpha_1, \alpha_2, \dots, \alpha_n$  be distinct constants, and  $f(x)$  be a polynomial of degree less than  $n$ . Then

$$1.2.12 \quad \frac{f(x)}{(x-\alpha_1)(x-\alpha_2)\cdots(x-\alpha_n)} \\ = \frac{A_1}{x-\alpha_1} + \frac{A_2}{x-\alpha_2} + \cdots + \frac{A_n}{x-\alpha_n},$$

where

$$1.2.13 \quad A_j = \frac{f(\alpha_j)}{\prod_{k \neq j} (\alpha_j - \alpha_k)}.$$

Also,

$$1.2.14 \quad \frac{f(x)}{(x-\alpha_1)^n} = \frac{B_1}{x-\alpha_1} + \frac{B_2}{(x-\alpha_1)^2} + \cdots + \frac{B_n}{(x-\alpha_1)^n},$$

where

$$1.2.15 \quad B_j = \frac{f^{(n-j)}(\alpha_1)}{(n-j)!},$$

and  $f^{(k)}$  is the  $k$ -th derivative of  $f$  (§1.4(iii)).

If  $m_1, m_2, \dots, m_n$  are positive integers and  $\deg f < \sum_{j=1}^n m_j$ , then there exist polynomials  $f_j(x)$ ,  $\deg f_j < m_j$ , such that

$$1.2.16 \quad \frac{f(x)}{(x-\alpha_1)^{m_1}(x-\alpha_2)^{m_2}\cdots(x-\alpha_n)^{m_n}} \\ = \frac{f_1(x)}{(x-\alpha_1)^{m_1}} + \frac{f_2(x)}{(x-\alpha_2)^{m_2}} + \cdots + \frac{f_n(x)}{(x-\alpha_n)^{m_n}}.$$

To find the polynomials  $f_j(x)$ ,  $j = 1, 2, \dots, n$ , multiply both sides by the denominator of the left-hand side and equate coefficients. See Chrystal (1959, pp. 151–159).

**1.2(iv) Means**

The *arithmetic mean* of  $n$  numbers  $a_1, a_2, \dots, a_n$  is

$$1.2.17 \quad A = \frac{a_1 + a_2 + \dots + a_n}{n}.$$

The *geometric mean*  $G$  and *harmonic mean*  $H$  of  $n$  positive numbers  $a_1, a_2, \dots, a_n$  are given by

$$1.2.18 \quad G = (a_1 a_2 \dots a_n)^{1/n},$$

$$1.2.19 \quad \frac{1}{H} = \frac{1}{n} \left( \frac{1}{a_1} + \frac{1}{a_2} + \dots + \frac{1}{a_n} \right).$$

If  $r$  is a nonzero real number, then the *weighted mean*  $M(r)$  of  $n$  nonnegative numbers  $a_1, a_2, \dots, a_n$ , and  $n$  positive numbers  $p_1, p_2, \dots, p_n$  with

$$1.2.20 \quad p_1 + p_2 + \dots + p_n = 1,$$

is defined by

$$1.2.21 \quad M(r) = (p_1 a_1^r + p_2 a_2^r + \dots + p_n a_n^r)^{1/r},$$

with the exception

$$1.2.22 \quad M(r) = 0, \quad r < 0 \text{ and } a_1 a_2 \dots a_n = 0.$$

$$1.2.23 \quad \lim_{r \rightarrow \infty} M(r) = \max(a_1, a_2, \dots, a_n),$$

$$1.2.24 \quad \lim_{r \rightarrow -\infty} M(r) = \min(a_1, a_2, \dots, a_n).$$

For  $p_j = 1/n$ ,  $j = 1, 2, \dots, n$ ,

$$1.2.25 \quad M(1) = A, \quad M(-1) = H,$$

and

$$1.2.26 \quad \lim_{r \rightarrow 0} M(r) = G.$$

The last two equations require  $a_j > 0$  for all  $j$ .

**1.3 Determinants****1.3(i) Definitions and Elementary Properties**

$$1.3.1 \quad \det[a_{jk}] = \begin{vmatrix} a_{11} & a_{12} \\ a_{21} & a_{22} \end{vmatrix} = a_{11}a_{22} - a_{12}a_{21}.$$

1.3.2

$$\begin{aligned} \det[a_{jk}] &= \begin{vmatrix} a_{11} & a_{12} & a_{13} \\ a_{21} & a_{22} & a_{23} \\ a_{31} & a_{32} & a_{33} \end{vmatrix} \\ &= a_{11} \begin{vmatrix} a_{22} & a_{23} \\ a_{32} & a_{33} \end{vmatrix} - a_{12} \begin{vmatrix} a_{21} & a_{23} \\ a_{31} & a_{33} \end{vmatrix} + a_{13} \begin{vmatrix} a_{21} & a_{22} \\ a_{31} & a_{32} \end{vmatrix} \\ &= a_{11}a_{22}a_{33} - a_{11}a_{23}a_{32} - a_{12}a_{21}a_{33} \\ &\quad + a_{12}a_{23}a_{31} + a_{13}a_{21}a_{32} - a_{13}a_{22}a_{31}. \end{aligned}$$

Higher-order determinants are natural generalizations. The *minor*  $M_{jk}$  of the entry  $a_{jk}$  in the  $n$ th-order determinant  $\det[a_{jk}]$  is the  $(n-1)$ th-order determinant derived from  $\det[a_{jk}]$  by deleting the  $j$ th row and the  $k$ th column. The *cofactor*  $A_{jk}$  of  $a_{jk}$  is

$$1.3.3 \quad A_{jk} = (-1)^{j+k} M_{jk}.$$

An  $n$ th-order determinant expanded by its  $j$ th row is given by

$$1.3.4 \quad \det[a_{jk}] = \sum_{\ell=1}^n a_{j\ell} A_{j\ell}.$$

If two rows (or columns) of a determinant are interchanged, then the determinant changes sign. If two rows (columns) of a determinant are identical, then the determinant is zero. If all the elements of a row (column) of a determinant are multiplied by an arbitrary factor  $\mu$ , then the result is a determinant which is  $\mu$  times the original. If  $\mu$  times a row (column) of a determinant is added to another row (column), then the value of the determinant is unchanged.

$$1.3.5 \quad \det[a_{jk}]^T = \det[a_{jk}],$$

$$1.3.6 \quad \det[a_{jk}]^{-1} = \frac{1}{\det[a_{jk}]},$$

$$1.3.7 \quad \det([a_{jk}][b_{jk}]) = (\det[a_{jk}])(\det[b_{jk}]).$$

**Hadamard's Inequality**

For real-valued  $a_{jk}$ ,

$$1.3.8 \quad \begin{vmatrix} a_{11} & a_{12} \\ a_{21} & a_{22} \end{vmatrix}^2 \leq (a_{11}^2 + a_{12}^2)(a_{21}^2 + a_{22}^2),$$

$$1.3.9 \quad \det[a_{jk}]^2 \leq \left( \sum_{k=1}^n a_{1k}^2 \right) \left( \sum_{k=1}^n a_{2k}^2 \right) \dots \left( \sum_{k=1}^n a_{nk}^2 \right).$$

Compare also (1.3.7) for the left-hand side. Equality holds iff

$$1.3.10 \quad a_{j1}a_{k1} + a_{j2}a_{k2} + \dots + a_{jn}a_{kn} = 0$$

for every distinct pair of  $j, k$ , or when one of the factors  $\sum_{k=1}^n a_{jk}^2$  vanishes.

**1.3(ii) Special Determinants**

An *alternant* is a determinant function of  $n$  variables which changes sign when two of the variables are interchanged. Examples:

$$1.3.11 \quad \det[f_k(x_j)], \quad j = 1, \dots, n; \quad k = 1, \dots, n,$$

$$1.3.12 \quad \det[f(x_j, y_k)], \quad j = 1, \dots, n; \quad k = 1, \dots, n.$$

**Vandermonde Determinant or Vandermondian**

$$1.3.13 \quad \begin{vmatrix} 1 & x_1 & x_1^2 & \dots & x_1^{n-1} \\ 1 & x_2 & x_2^2 & \dots & x_2^{n-1} \\ \vdots & \vdots & \vdots & \ddots & \vdots \\ 1 & x_n & x_n^2 & \dots & x_n^{n-1} \end{vmatrix} = \prod_{1 \leq j < k \leq n} (x_k - x_j).$$

### Cauchy Determinant

1.3.14

$$\det \left[ \frac{1}{a_j - b_k} \right] = (-1)^{n(n-1)/2} \times \prod_{1 \leq j < k \leq n} (a_k - a_j)(b_k - b_j) \bigg/ \prod_{j,k=1}^n (a_j - b_k).$$

### Circulant

$$1.3.15 \quad \begin{vmatrix} a_1 & a_2 & \cdots & a_n \\ a_n & a_1 & \cdots & a_{n-1} \\ \vdots & \vdots & \ddots & \vdots \\ a_2 & a_3 & \cdots & a_1 \end{vmatrix} = \prod_{k=1}^n (a_1 + a_2 \omega_k + a_3 \omega_k^2 + \cdots + a_n \omega_k^{n-1}),$$

where  $\omega_1, \omega_2, \dots, \omega_n$  are the  $n$ th roots of unity (1.11.21).

### Krattenthaler's Formula

For

$$1.3.16 \quad t_{jk} = (x_j + a_n)(x_j + a_{n-1}) \cdots (x_j + a_{k+1}) \times (x_j + b_k)(x_j + b_{k-1}) \cdots (x_j + b_2),$$

$$1.3.17 \quad \det[t_{jk}] = \prod_{1 \leq j < k \leq n} (x_j - x_k) \prod_{2 \leq j \leq k \leq n} (b_j - a_k).$$

### 1.3(iii) Infinite Determinants

Let  $a_{j,k}$  be defined for all integer values of  $j$  and  $k$ , and  $D_n[a_{j,k}]$  denote the  $(2n+1) \times (2n+1)$  determinant

1.3.18

$$D_n[a_{j,k}] = \begin{vmatrix} a_{-n,-n} & a_{-n,-n+1} & \cdots & a_{-n,n} \\ a_{-n+1,-n} & a_{-n+1,-n+1} & \cdots & a_{-n+1,n} \\ \vdots & \vdots & \ddots & \vdots \\ a_{n,-n} & a_{n,-n+1} & \cdots & a_{n,n} \end{vmatrix}.$$

If  $D_n[a_{j,k}]$  tends to a limit  $L$  as  $n \rightarrow \infty$ , then we say that the *infinite determinant*  $D_\infty[a_{j,k}]$  converges and  $D_\infty[a_{j,k}] = L$ .

Of importance for special functions are infinite determinants of *Hill's type*. These have the property that the double series

$$1.3.19 \quad \sum_{j,k=-\infty}^{\infty} |a_{j,k} - \delta_{j,k}|$$

converges (§1.9(vii)). Here  $\delta_{j,k}$  is the Kronecker delta. Hill-type determinants always converge.

For further information see [Whittaker and Watson \(1927, pp. 36–40\)](#) and [Magnus and Winkler \(1966, §2.3\)](#).

## 1.4 Calculus of One Variable

### 1.4(i) Monotonicity

If  $f(x_1) \leq f(x_2)$  for every pair  $x_1, x_2$  in an interval  $I$  such that  $x_1 < x_2$ , then  $f(x)$  is *nondecreasing* on  $I$ . If the  $\leq$  sign is replaced by  $<$ , then  $f(x)$  is *increasing* (also called *strictly increasing*) on  $I$ . Similarly for *nonincreasing* and *decreasing* (*strictly decreasing*) functions. Each of the preceding four cases is classified as *monotonic*; sometimes *strictly monotonic* is used for the strictly increasing or strictly decreasing cases.

### 1.4(ii) Continuity

A function  $f(x)$  is *continuous on the right* (or *from above*) at  $x = c$  if

$$1.4.1 \quad f(c+) \equiv \lim_{x \rightarrow c+} f(x) = f(c),$$

that is, for every arbitrarily small positive constant  $\epsilon$  there exists  $\delta (> 0)$  such that

$$1.4.2 \quad |f(c + \alpha) - f(c)| < \epsilon,$$

for all  $\alpha$  such that  $0 \leq \alpha < \delta$ . Similarly, it is *continuous on the left* (or *from below*) at  $x = c$  if

$$1.4.3 \quad f(c-) \equiv \lim_{x \rightarrow c-} f(x) = f(c).$$

And  $f(x)$  is *continuous at  $c$*  when both (1.4.1) and (1.4.3) apply.

If  $f(x)$  is continuous at each point  $c \in (a, b)$ , then  $f(x)$  is *continuous on the interval  $(a, b)$*  and we write  $f \in C(a, b)$ . If also  $f(x)$  is continuous on the right at  $x = a$ , and continuous on the left at  $x = b$ , then  $f(x)$  is *continuous on the interval  $[a, b]$* , and we write  $f(x) \in C[a, b]$ .

A *removable singularity* of  $f(x)$  at  $x = c$  occurs when  $f(c+) = f(c-)$  but  $f(c)$  is undefined. For example,  $f(x) = (\sin x)/x$  with  $c = 0$ .

A *simple discontinuity* of  $f(x)$  at  $x = c$  occurs when  $f(c+)$  and  $f(c-)$  exist, but  $f(c+) \neq f(c-)$ . If  $f(x)$  is continuous on an interval  $I$  save for a finite number of simple discontinuities, then  $f(x)$  is *piecewise* (or *sectionally*) continuous on  $I$ . For an example, see Figure 1.4.1

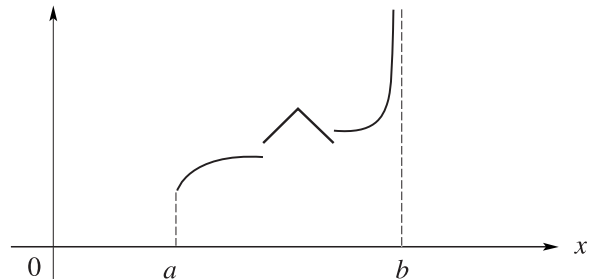


Figure 1.4.1: Piecewise continuous function on  $[a, b]$ .

**1.4(iii) Derivatives**

The *derivative*  $f'(x)$  of  $f(x)$  is defined by

$$1.4.4 \quad f'(x) = \frac{df}{dx} = \lim_{h \rightarrow 0} \frac{f(x+h) - f(x)}{h}.$$

When this limit exists  $f$  is *differentiable* at  $x$ .

$$1.4.5 \quad (f+g)'(x) = f'(x) + g'(x),$$

$$1.4.6 \quad (fg)'(x) = f'(x)g(x) + f(x)g'(x),$$

$$1.4.7 \quad \left(\frac{f}{g}\right)'(x) = \frac{f'(x)g(x) - f(x)g'(x)}{(g(x))^2}.$$

**Higher Derivatives**

$$1.4.8 \quad f^{(2)}(x) = \frac{d^2 f}{dx^2} = \frac{d}{dx} \left(\frac{df}{dx}\right),$$

$$1.4.9 \quad f^{(n)} = f^{(n)}(x) = \frac{d}{dx} f^{(n-1)}(x).$$

If  $f^{(n)}$  exists and is continuous on an interval  $I$ , then we write  $f \in C^n(I)$ . When  $n \geq 1$ ,  $f$  is *continuously differentiable* on  $I$ . When  $n$  is unbounded,  $f$  is *infinitely differentiable* on  $I$  and we write  $f \in C^\infty(I)$ .

**Chain Rule**

For  $h(x) = f(g(x))$ ,

$$1.4.10 \quad h'(x) = f'(g(x))g'(x).$$

**Maxima and Minima**

A necessary condition that a differentiable function  $f(x)$  has a *local maximum* (*minimum*) at  $x = c$ , that is,  $f(x) \leq f(c)$ , ( $f(x) \geq f(c)$ ) in a *neighborhood*  $c - \delta \leq x \leq c + \delta$  ( $\delta > 0$ ) of  $c$ , is  $f'(c) = 0$ .

**Mean Value Theorem**

If  $f(x)$  is continuous on  $[a, b]$  and differentiable on  $(a, b)$ , then there exists a point  $c \in (a, b)$  such that

$$1.4.11 \quad f(b) - f(a) = (b - a)f'(c).$$

If  $f'(x) \geq 0$  ( $\leq 0$ ) ( $= 0$ ) for all  $x \in (a, b)$ , then  $f$  is nondecreasing (nonincreasing) (constant) on  $(a, b)$ .

**Leibniz's Formula**

$$1.4.12 \quad (fg)^{(n)} = f^{(n)}g + \binom{n}{1}f^{(n-1)}g' + \dots + \binom{n}{k}f^{(n-k)}g^{(k)} + \dots + fg^{(n)}.$$

**Faà Di Bruno's Formula**

$$1.4.13 \quad \frac{d^n}{dx^n} f(g(x)) = \sum \left( \frac{n!}{m_1!m_2!\dots m_n!} \right) f^{(k)}(g(x)) \times \left( \frac{g'(x)}{1!} \right)^{m_1} \left( \frac{g''(x)}{2!} \right)^{m_2} \dots \left( \frac{g^{(n)}(x)}{n!} \right)^{m_n},$$

where the sum is over all nonnegative integers  $m_1, m_2, \dots, m_n$  that satisfy  $m_1 + 2m_2 + \dots + nm_n = n$ , and  $k = m_1 + m_2 + \dots + m_n$ .

**L'Hôpital's Rule**

If

$$1.4.14 \quad \lim_{x \rightarrow a} f(x) = \lim_{x \rightarrow a} g(x) = 0 \text{ (or } \infty),$$

then

$$1.4.15 \quad \lim_{x \rightarrow a} \frac{f(x)}{g(x)} = \lim_{x \rightarrow a} \frac{f'(x)}{g'(x)},$$

when the last limit exists.

**1.4(iv) Indefinite Integrals**

If  $F'(x) = f(x)$ , then  $\int f dx = F(x) + C$ , where  $C$  is a constant.

**Integration by Parts**

$$1.4.16 \quad \int fg dx = \left(\int f dx\right)g - \int \left(\int f dx\right) \frac{dg}{dx} dx.$$

$$1.4.17 \quad \int x^n dx = \begin{cases} \frac{x^{n+1}}{n+1} + C, & n \neq -1, \\ \ln|x| + C, & n = -1. \end{cases}$$

For the function  $\ln$  see §4.2(i).

See §§4.10, 4.26(ii), 4.26(iv), 4.40(ii), and 4.40(iv) for indefinite integrals involving the elementary functions.

For extensive tables of integrals, see Apelblat (1983), Bierens de Haan (1867), Gradshteyn and Ryzhik (2000), Gröbner and Hofreiter (1949, 1950), and Prudnikov *et al.* (1986a,b, 1990, 1992a,b).

**1.4(v) Definite Integrals**

Suppose  $f(x)$  is defined on  $[a, b]$ . Let  $a = x_0 < x_1 < \dots < x_n = b$ , and  $\xi_j$  denote any point in  $[x_j, x_{j+1}]$ ,  $j = 0, 1, \dots, n-1$ . Then

$$1.4.18 \quad \int_a^b f(x) dx = \lim_{\max(x_{j+1} - x_j) \rightarrow 0} \sum_{j=0}^{n-1} f(\xi_j)(x_{j+1} - x_j)$$

as  $\max(x_{j+1} - x_j) \rightarrow 0$ . Continuity, or piecewise continuity, of  $f(x)$  on  $[a, b]$  is sufficient for the limit to exist.

**1.4.19**

$$\int_a^b (cf(x) + dg(x)) dx = c \int_a^b f(x) dx + d \int_a^b g(x) dx,$$

$c$  and  $d$  constants.

$$1.4.20 \quad \int_a^b f(x) dx = - \int_b^a f(x) dx.$$

$$1.4.21 \quad \int_a^b f(x) dx = \int_a^c f(x) dx + \int_c^b f(x) dx.$$

### Infinite Integrals

$$1.4.22 \quad \int_a^\infty f(x) dx = \lim_{b \rightarrow \infty} \int_a^b f(x) dx.$$

Similarly for  $\int_{-\infty}^a$ . Next, if  $f(b) = \pm\infty$ , then

$$1.4.23 \quad \int_a^b f(x) dx = \lim_{c \rightarrow b^-} \int_a^c f(x) dx.$$

Similarly when  $f(a) = \pm\infty$ .

When the limits in (1.4.22) and (1.4.23) exist, the integrals are said to be *convergent*. If the limits exist with  $f(x)$  replaced by  $|f(x)|$ , then the integrals are *absolutely convergent*. Absolute convergence also implies convergence.

### Cauchy Principal Values

Let  $c \in (a, b)$  and assume that  $\int_a^{c-\epsilon} f(x) dx$  and  $\int_{c+\epsilon}^b f(x) dx$  exist when  $0 < \epsilon < \min(c - a, b - c)$ , but not necessarily when  $\epsilon = 0$ . Then we define

$$1.4.24 \quad \int_a^b f(x) dx = P \int_a^b f(x) dx \\ = \lim_{\epsilon \rightarrow 0^+} \left( \int_a^{c-\epsilon} f(x) dx + \int_{c+\epsilon}^b f(x) dx \right),$$

when this limit exists.

Similarly, assume that  $\int_{-b}^b f(x) dx$  exists for all finite values of  $b (> 0)$ , but not necessarily when  $b = \infty$ . Then we define

$$1.4.25 \quad \int_{-\infty}^\infty f(x) dx = P \int_{-\infty}^\infty f(x) dx = \lim_{b \rightarrow \infty} \int_{-b}^b f(x) dx,$$

when this limit exists.

### Fundamental Theorem of Calculus

For  $F'(x) = f(x)$  with  $f(x)$  continuous,

$$1.4.26 \quad \int_a^b f(x) dx = F(b) - F(a),$$

$$1.4.27 \quad \frac{d}{dx} \int_a^x f(t) dt = f(x).$$

### Change of Variables

If  $\phi'(x)$  is continuous or piecewise continuous, then

$$1.4.28 \quad \int_a^b f(\phi(x))\phi'(x) dx = \int_{\phi(a)}^{\phi(b)} f(t) dt.$$

### First Mean Value Theorem

For  $f(x)$  continuous and  $\phi(x) \geq 0$  and integrable on  $[a, b]$ , there exists  $c \in [a, b]$ , such that

$$1.4.29 \quad \int_a^b f(x)\phi(x) dx = f(c) \int_a^b \phi(x) dx.$$

### Second Mean Value Theorem

For  $f(x)$  monotonic and  $\phi(x)$  integrable on  $[a, b]$ , there exists  $c \in [a, b]$ , such that

$$1.4.30 \quad \int_a^b f(x)\phi(x) dx = f(a) \int_a^c \phi(x) dx + f(b) \int_c^b \phi(x) dx.$$

### Repeated Integrals

If  $f(x)$  is continuous or piecewise continuous on  $[a, b]$ , then

$$1.4.31 \quad \int_a^b dx_n \int_a^{x_n} dx_{n-1} \cdots \int_a^{x_2} dx_1 \int_a^{x_1} f(x) dx \\ = \frac{1}{n!} \int_a^b (b-x)^n f(x) dx.$$

### Square-Integrable Functions

A function  $f(x)$  is *square-integrable* if

$$1.4.32 \quad \|f\|_2^2 \equiv \int_a^b |f(x)|^2 dx < \infty.$$

### Functions of Bounded Variation

With  $a < b$ , the *total variation* of  $f(x)$  on a finite or infinite interval  $(a, b)$  is

$$1.4.33 \quad \mathcal{V}_{a,b}(f) = \sup \sum_{j=1}^n |f(x_j) - f(x_{j-1})|,$$

where the supremum is over all sets of points  $x_0 < x_1 < \cdots < x_n$  in the *closure* of  $(a, b)$ , that is,  $(a, b)$  with  $a, b$  added when they are finite. If  $\mathcal{V}_{a,b}(f) < \infty$ , then  $f(x)$  is of *bounded variation* on  $(a, b)$ . In this case,  $g(x) = \mathcal{V}_{a,x}(f)$  and  $h(x) = \mathcal{V}_{a,x}(f) - f(x)$  are nondecreasing bounded functions and  $f(x) = g(x) - h(x)$ .

If  $f(x)$  is continuous on the closure of  $(a, b)$  and  $f'(x)$  is continuous on  $(a, b)$ , then

$$1.4.34 \quad \mathcal{V}_{a,b}(f) = \int_a^b |f'(x) dx|,$$

whenever this integral exists.

Lastly, whether or not the real numbers  $a$  and  $b$  satisfy  $a < b$ , and whether or not they are finite, we *define*  $\mathcal{V}_{a,b}(f)$  by (1.4.34) whenever this integral exists. This definition also applies when  $f(x)$  is a complex function of the real variable  $x$ . For further information on total variation see Olver (1997b, pp. 27–29).

### 1.4(vi) Taylor's Theorem for Real Variables

If  $f(x) \in C^{n+1}[a, b]$ , then

$$1.4.35 \quad f(x) = \sum_{k=0}^n \frac{f^{(k)}(a)}{k!} (x-a)^k + R_n,$$

$$1.4.36 \quad R_n = \frac{f^{(n+1)}(c)}{(n+1)!} (x-a)^{n+1}, \quad a < c < x,$$

and

$$1.4.37 \quad R_n = \frac{1}{n!} \int_a^x (x-t)^n f^{(n+1)}(t) dt.$$

### 1.4(vii) Maxima and Minima

If  $f(x)$  is twice-differentiable, and if also  $f'(x_0) = 0$  and  $f''(x_0) < 0$  ( $> 0$ ), then  $x = x_0$  is a local maximum (minimum) (§1.4(iii)) of  $f(x)$ . The overall maximum (minimum) of  $f(x)$  on  $[a, b]$  will either be at a local maximum (minimum) or at one of the end points  $a$  or  $b$ .

### 1.4(viii) Convex Functions

A function  $f(x)$  is *convex* on  $(a, b)$  if

$$1.4.38 \quad f((1-t)c + td) \leq (1-t)f(c) + tf(d)$$

for any  $c, d \in (a, b)$ , and  $t \in [0, 1]$ . See Figure 1.4.2. A similar definition applies to closed intervals  $[a, b]$ .

If  $f(x)$  is twice differentiable, then  $f(x)$  is convex iff  $f''(x) \geq 0$  on  $(a, b)$ . A continuously differentiable function is convex iff the curve does not lie below its tangent at any point.

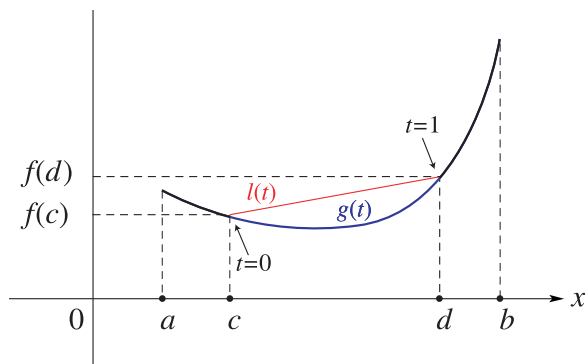


Figure 1.4.2: Convex function  $f(x)$ .  $g(t) = f((1-t)c + td)$ ,  $l(t) = (1-t)f(c) + tf(d)$ ,  $c, d \in (a, b)$ ,  $0 \leq t \leq 1$ .

## 1.5 Calculus of Two or More Variables

### 1.5(i) Partial Derivatives

A function  $f(x, y)$  is *continuous at a point*  $(a, b)$  if

$$1.5.1 \quad \lim_{(x,y) \rightarrow (a,b)} f(x, y) = f(a, b),$$

that is, for every arbitrarily small positive constant  $\epsilon$  there exists  $\delta$  ( $> 0$ ) such that

$$1.5.2 \quad |f(a + \alpha, b + \beta) - f(a, b)| < \epsilon,$$

for all  $\alpha$  and  $\beta$  that satisfy  $|\alpha|, |\beta| < \delta$ .

A function is *continuous on a point set*  $D$  if it is continuous at all points of  $D$ . A function  $f(x, y)$  is *piecewise continuous* on  $I_1 \times I_2$ , where  $I_1$  and  $I_2$  are intervals, if it is piecewise continuous in  $x$  for each  $y \in I_2$  and piecewise continuous in  $y$  for each  $x \in I_1$ .

$$1.5.3 \quad \frac{\partial f}{\partial x} = D_x f = f_x = \lim_{h \rightarrow 0} \frac{f(x+h, y) - f(x, y)}{h},$$

$$1.5.4 \quad \frac{\partial f}{\partial y} = D_y f = f_y = \lim_{h \rightarrow 0} \frac{f(x, y+h) - f(x, y)}{h}.$$

$$1.5.5 \quad \frac{\partial^2 f}{\partial x \partial y} = \frac{\partial}{\partial x} \left( \frac{\partial f}{\partial y} \right), \quad \frac{\partial^2 f}{\partial y \partial x} = \frac{\partial}{\partial y} \left( \frac{\partial f}{\partial x} \right).$$

The function  $f(x, y)$  is *continuously differentiable* if  $f$ ,  $\partial f/\partial x$ , and  $\partial f/\partial y$  are continuous, and *twice-continuously differentiable* if also  $\partial^2 f/\partial x^2$ ,  $\partial^2 f/\partial y^2$ ,  $\partial^2 f/\partial x \partial y$ , and  $\partial^2 f/\partial y \partial x$  are continuous. In the latter event

$$1.5.6 \quad \frac{\partial^2 f}{\partial x \partial y} = \frac{\partial^2 f}{\partial y \partial x}.$$

### Chain Rule

$$1.5.7 \quad \frac{d}{dt} f(x(t), y(t)) = \frac{\partial f}{\partial x} \frac{dx}{dt} + \frac{\partial f}{\partial y} \frac{dy}{dt},$$

$$1.5.8 \quad \frac{\partial}{\partial u} f(x(u, v), y(u, v)) = \frac{\partial f}{\partial x} \frac{\partial x}{\partial u} + \frac{\partial f}{\partial y} \frac{\partial y}{\partial u},$$

$$1.5.9 \quad \begin{aligned} \frac{\partial}{\partial v} f(x(u, v), y(u, v), z(u, v)) \\ = \frac{\partial f}{\partial x} \frac{\partial x}{\partial v} + \frac{\partial f}{\partial y} \frac{\partial y}{\partial v} + \frac{\partial f}{\partial z} \frac{\partial z}{\partial v}. \end{aligned}$$

### Implicit Function Theorem

If  $F(x, y)$  is continuously differentiable,  $F(a, b) = 0$ , and  $\partial F/\partial y \neq 0$  at  $(a, b)$ , then in a *neighborhood* of  $(a, b)$ , that is, an open disk centered at  $a, b$ , the equation  $F(x, y) = 0$  defines a continuously differentiable function  $y = g(x)$  such that  $F(x, g(x)) = 0$ ,  $b = g(a)$ , and  $g'(x) = -F_x/F_y$ .

## 1.5(ii) Coordinate Systems

### Polar Coordinates

With  $0 \leq r < \infty$ ,  $0 \leq \phi \leq 2\pi$ ,

$$1.5.10 \quad x = r \cos \phi, \quad y = r \sin \phi,$$

$$1.5.11 \quad \frac{\partial}{\partial x} = \cos \phi \frac{\partial}{\partial r} - \frac{\sin \phi}{r} \frac{\partial}{\partial \phi},$$

$$1.5.12 \quad \frac{\partial}{\partial y} = \sin \phi \frac{\partial}{\partial r} + \frac{\cos \phi}{r} \frac{\partial}{\partial \phi}.$$

The *Laplacian* is given by

$$1.5.13 \quad \nabla^2 f = \frac{\partial^2 f}{\partial x^2} + \frac{\partial^2 f}{\partial y^2} = \frac{\partial^2 f}{\partial r^2} + \frac{1}{r} \frac{\partial f}{\partial r} + \frac{1}{r^2} \frac{\partial^2 f}{\partial \phi^2}.$$

### Cylindrical Coordinates

With  $0 \leq r < \infty$ ,  $0 \leq \phi \leq 2\pi$ ,  $-\infty < z < \infty$ ,

$$1.5.14 \quad x = r \cos \phi, \quad y = r \sin \phi, \quad z = z.$$

Equations (1.5.11) and (1.5.12) still apply, but

$$1.5.15 \quad \nabla^2 f = \frac{\partial^2 f}{\partial x^2} + \frac{\partial^2 f}{\partial y^2} + \frac{\partial^2 f}{\partial z^2} = \frac{\partial^2 f}{\partial r^2} + \frac{1}{r} \frac{\partial f}{\partial r} + \frac{1}{r^2} \frac{\partial^2 f}{\partial \phi^2} + \frac{\partial^2 f}{\partial z^2}.$$



**Spherical Coordinates**

With  $0 \leq \rho < \infty$ ,  $0 \leq \phi \leq 2\pi$ ,  $0 \leq \theta \leq \pi$ ,

$$1.5.16 \quad x = \rho \sin \theta \cos \phi, \quad y = \rho \sin \theta \sin \phi, \quad z = \rho \cos \theta.$$

The Laplacian is given by

$$1.5.17 \quad \begin{aligned} \nabla^2 f &= \frac{\partial^2 f}{\partial x^2} + \frac{\partial^2 f}{\partial y^2} + \frac{\partial^2 f}{\partial z^2} \\ &= \frac{1}{\rho^2} \frac{\partial}{\partial \rho} \left( \rho^2 \frac{\partial f}{\partial \rho} \right) + \frac{1}{\rho^2 \sin^2 \theta} \frac{\partial^2 f}{\partial \phi^2} \\ &\quad + \frac{1}{\rho^2 \sin \theta} \frac{\partial}{\partial \theta} \left( \sin \theta \frac{\partial f}{\partial \theta} \right). \end{aligned}$$

For applications and other coordinate systems see §§12.17, 14.19(i), 14.30(iv), 28.32, 29.18, 30.13, 30.14. See also Morse and Feshbach (1953a, pp. 655-666).

**1.5(iii) Taylor's Theorem; Maxima and Minima**

If  $f$  is  $n + 1$  times continuously differentiable, then

$$1.5.18 \quad \begin{aligned} f(a + \lambda, b + \mu) &= f + \left( \lambda \frac{\partial}{\partial x} + \mu \frac{\partial}{\partial y} \right) f + \dots \\ &\quad + \frac{1}{n!} \left( \lambda \frac{\partial}{\partial x} + \mu \frac{\partial}{\partial y} \right)^n f + R_n, \end{aligned}$$

where  $f$  and its partial derivatives on the right-hand side are evaluated at  $(a, b)$ , and  $R_n/(\lambda^2 + \mu^2)^{n/2} \rightarrow 0$  as  $(\lambda, \mu) \rightarrow (0, 0)$ .

$f(x, y)$  has a *local minimum (maximum)* at  $(a, b)$  if

$$1.5.19 \quad \frac{\partial f}{\partial x} = \frac{\partial f}{\partial y} = 0 \quad \text{at } (a, b),$$

and the second-order term in (1.5.18) is *positive definite (negative definite)*, that is,

$$1.5.20 \quad \frac{\partial^2 f}{\partial x^2} > 0 \quad (< 0) \quad \text{at } (a, b),$$

and

$$1.5.21 \quad \frac{\partial^2 f}{\partial x^2} \frac{\partial^2 f}{\partial y^2} - \left( \frac{\partial^2 f}{\partial x \partial y} \right)^2 > 0 \quad \text{at } (a, b).$$

**1.5(iv) Leibniz's Theorem for Differentiation of Integrals****Finite Integrals****1.5.22**

$$\begin{aligned} \frac{d}{dx} \int_{\alpha(x)}^{\beta(x)} f(x, y) dy &= f(x, \beta(x))\beta'(x) - f(x, \alpha(x))\alpha'(x) \\ &\quad + \int_{\alpha(x)}^{\beta(x)} \frac{\partial f}{\partial x} dy. \end{aligned}$$

Sufficient conditions for validity are: (a)  $f$  and  $\partial f/\partial x$  are continuous on a rectangle  $a \leq x \leq b$ ,  $c \leq y \leq d$ ; (b) when  $x \in [a, b]$  both  $\alpha(x)$  and  $\beta(x)$  are continuously differentiable and lie in  $[c, d]$ .

**Infinite Integrals**

Suppose that  $a, b, c$  are finite,  $d$  is finite or  $+\infty$ , and  $f(x, y)$ ,  $\partial f/\partial x$  are continuous on the partly-closed rectangle or infinite strip  $[a, b] \times [c, d)$ . Suppose also that  $\int_c^d f(x, y) dy$  converges and  $\int_c^d (\partial f/\partial x) dy$  converges uniformly on  $a \leq x \leq b$ , that is, given any positive number  $\epsilon$ , however small, we can find a number  $c_0 \in [c, d)$  that is independent of  $x$  and is such that

$$1.5.23 \quad \left| \int_{c_1}^d (\partial f/\partial x) dy \right| < \epsilon,$$

for all  $c_1 \in [c_0, d)$  and all  $x \in [a, b]$ . Then

$$1.5.24 \quad \frac{d}{dx} \int_c^d f(x, y) dy = \int_c^d \frac{\partial f}{\partial x} dy, \quad a < x < b.$$

**1.5(v) Multiple Integrals****Double Integrals**

Let  $f(x, y)$  be defined on a closed rectangle  $R = [a, b] \times [c, d]$ . For

$$1.5.25 \quad a = x_0 < x_1 < \dots < x_n = b,$$

$$1.5.26 \quad c = y_0 < y_1 < \dots < y_m = d,$$

let  $(\xi_j, \eta_k)$  denote any point in the rectangle  $[x_j, x_{j+1}] \times [y_k, y_{k+1}]$ ,  $j = 0, \dots, n-1$ ,  $k = 0, \dots, m-1$ . Then the *double integral* of  $f(x, y)$  over  $R$  is defined by

$$1.5.27 \quad \begin{aligned} \iint_R f(x, y) dA &= \lim \sum_{j,k} f(\xi_j, \eta_k)(x_{j+1} - x_j)(y_{k+1} - y_k) \end{aligned}$$

as  $\max((x_{j+1} - x_j) + (y_{k+1} - y_k)) \rightarrow 0$ . Sufficient conditions for the limit to exist are that  $f(x, y)$  is continuous, or piecewise continuous, on  $R$ .

For  $f(x, y)$  defined on a point set  $D$  contained in a rectangle  $R$ , let

$$1.5.28 \quad f^*(x, y) = \begin{cases} f(x, y), & \text{if } (x, y) \in D, \\ 0, & \text{if } (x, y) \in R \setminus D. \end{cases}$$

Then

$$1.5.29 \quad \iint_D f(x, y) dA = \iint_R f^*(x, y) dA,$$

provided the latter integral exists.

If  $f(x, y)$  is continuous, and  $D$  is the set

$$1.5.30 \quad a \leq x \leq b, \quad \phi_1(x) \leq y \leq \phi_2(x),$$

with  $\phi_1(x)$  and  $\phi_2(x)$  continuous, then

$$1.5.31 \quad \iint_D f(x, y) dA = \int_a^b \int_{\phi_1(x)}^{\phi_2(x)} f(x, y) dy dx,$$

where the right-hand side is interpreted as the repeated integral

$$1.5.32 \quad \int_a^b \left( \int_{\phi_1(x)}^{\phi_2(x)} f(x, y) dy \right) dx.$$

In particular,  $\phi_1(x)$  and  $\phi_2(x)$  can be constants.

Similarly, if  $D$  is the set

$$1.5.33 \quad c \leq y \leq d, \quad \psi_1(y) \leq x \leq \psi_2(y),$$

with  $\psi_1(y)$  and  $\psi_2(y)$  continuous, then

$$1.5.34 \quad \iint_D f(x, y) dA = \int_c^d \int_{\psi_1(y)}^{\psi_2(y)} f(x, y) dx dy.$$

### Change of Order of Integration

If  $D$  can be represented in both forms (1.5.30) and (1.5.33), and  $f(x, y)$  is continuous on  $D$ , then

$$1.5.35 \quad \int_a^b \int_{\phi_1(x)}^{\phi_2(x)} f(x, y) dy dx = \int_c^d \int_{\psi_1(y)}^{\psi_2(y)} f(x, y) dx dy.$$

### Infinite Double Integrals

Infinite double integrals occur when  $f(x, y)$  becomes infinite at points in  $D$  or when  $D$  is unbounded. In the cases (1.5.30) and (1.5.33) they are defined by taking limits in the repeated integrals (1.5.32) and (1.5.34) in an analogous manner to (1.4.22)–(1.4.23).

Moreover, if  $a, b, c, d$  are finite or infinite constants and  $f(x, y)$  is piecewise continuous on the set  $(a, b) \times (c, d)$ , then

$$1.5.36 \quad \int_a^b \int_c^d f(x, y) dy dx = \int_c^d \int_a^b f(x, y) dx dy,$$

whenever both repeated integrals exist and at least one is absolutely convergent.

### Triple Integrals

Finite and infinite integrals can be defined in a similar way. Often the  $(x, y, z)$  sets are of the form

$$1.5.37 \quad a \leq x \leq b, \quad \phi_1(x) \leq y \leq \phi_2(x), \\ \psi_1(x, y) \leq z \leq \psi_2(x, y).$$

## 1.5(vi) Jacobians and Change of Variables

### Jacobian

$$1.5.38 \quad \frac{\partial(f, g)}{\partial(x, y)} = \begin{vmatrix} \partial f / \partial x & \partial f / \partial y \\ \partial g / \partial x & \partial g / \partial y \end{vmatrix},$$

$$1.5.39 \quad \frac{\partial(x, y)}{\partial(r, \phi)} = r \quad (\text{polar coordinates}).$$

$$1.5.40 \quad \frac{\partial(f, g, h)}{\partial(x, y, z)} = \begin{vmatrix} \partial f / \partial x & \partial f / \partial y & \partial f / \partial z \\ \partial g / \partial x & \partial g / \partial y & \partial g / \partial z \\ \partial h / \partial x & \partial h / \partial y & \partial h / \partial z \end{vmatrix},$$

$$1.5.41 \quad \frac{\partial(x, y, z)}{\partial(\rho, \theta, \phi)} = \rho^2 \sin \theta \quad (\text{spherical coordinates}).$$

### Change of Variables

$$1.5.42 \quad \iint_D f(x, y) dx dy \\ = \iint_{D^*} f(x(u, v), y(u, v)) \left| \frac{\partial(x, y)}{\partial(u, v)} \right| du dv,$$

where  $D$  is the image of  $D^*$  under a mapping  $(u, v) \rightarrow (x(u, v), y(u, v))$  which is one-to-one except perhaps for a set of points of area zero.

$$1.5.43 \quad \iiint_D f(x, y, z) dx dy dz \\ = \iiint_{D^*} f(x(u, v, w), y(u, v, w), z(u, v, w)) \\ \times \left| \frac{\partial(x, y, z)}{\partial(u, v, w)} \right| du dv dw.$$

Again the mapping is one-to-one except perhaps for a set of points of volume zero.

## 1.6 Vectors and Vector-Valued Functions

### 1.6(i) Vectors

$$1.6.1 \quad \mathbf{a} = (a_1, a_2, a_3), \quad \mathbf{b} = (b_1, b_2, b_3).$$

#### Dot Product (or Scalar Product)

$$1.6.2 \quad \mathbf{a} \cdot \mathbf{b} = a_1 b_1 + a_2 b_2 + a_3 b_3.$$

#### Magnitude and Angle of Vector $\mathbf{a}$

$$1.6.3 \quad \|\mathbf{a}\| = \sqrt{\mathbf{a} \cdot \mathbf{a}},$$

$$1.6.4 \quad \cos \theta = \frac{\mathbf{a} \cdot \mathbf{b}}{\|\mathbf{a}\| \|\mathbf{b}\|};$$

$\theta$  is the angle between  $\mathbf{a}$  and  $\mathbf{b}$ .

#### Unit Vectors

$$1.6.5 \quad \mathbf{i} = (1, 0, 0), \quad \mathbf{j} = (0, 1, 0), \quad \mathbf{k} = (0, 0, 1),$$

$$1.6.6 \quad \mathbf{a} = a_1 \mathbf{i} + a_2 \mathbf{j} + a_3 \mathbf{k}.$$

#### Cross Product (or Vector Product)

$$1.6.7 \quad \mathbf{i} \times \mathbf{j} = \mathbf{k}, \quad \mathbf{j} \times \mathbf{k} = \mathbf{i}, \quad \mathbf{k} \times \mathbf{i} = \mathbf{j},$$

$$1.6.8 \quad \mathbf{j} \times \mathbf{i} = -\mathbf{k}, \quad \mathbf{k} \times \mathbf{j} = -\mathbf{i}, \quad \mathbf{i} \times \mathbf{k} = -\mathbf{j}.$$

#### 1.6.9

$$\mathbf{a} \times \mathbf{b} = \begin{vmatrix} \mathbf{i} & \mathbf{j} & \mathbf{k} \\ a_1 & a_2 & a_3 \\ b_1 & b_2 & b_3 \end{vmatrix} \\ = (a_2 b_3 - a_3 b_2) \mathbf{i} + (a_3 b_1 - a_1 b_3) \mathbf{j} + (a_1 b_2 - a_2 b_1) \mathbf{k} \\ = \|\mathbf{a}\| \|\mathbf{b}\| (\sin \theta) \mathbf{n},$$

where  $\mathbf{n}$  is the unit vector normal to  $\mathbf{a}$  and  $\mathbf{b}$  whose direction is determined by the right-hand rule; see Figure 1.6.1.

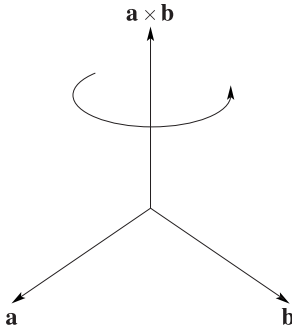


Figure 1.6.1: Vector notation. Right-hand rule for cross products.

Area of parallelogram with vectors  $\mathbf{a}$  and  $\mathbf{b}$  as sides =  $\|\mathbf{a} \times \mathbf{b}\|$ .

Volume of a parallelepiped with vectors  $\mathbf{a}$ ,  $\mathbf{b}$ , and  $\mathbf{c}$  as edges =  $|\mathbf{a} \cdot (\mathbf{b} \times \mathbf{c})|$ .

$$1.6.10 \quad \mathbf{a} \times (\mathbf{b} \times \mathbf{c}) = \mathbf{b}(\mathbf{a} \cdot \mathbf{c}) - \mathbf{c}(\mathbf{a} \cdot \mathbf{b}),$$

$$1.6.11 \quad (\mathbf{a} \times \mathbf{b}) \times \mathbf{c} = \mathbf{b}(\mathbf{a} \cdot \mathbf{c}) - \mathbf{a}(\mathbf{b} \cdot \mathbf{c}).$$

### 1.6(ii) Vectors: Alternative Notations

The following notations are often used in the physics literature; see for example Lorentz *et al.* (1923, pp. 122–123).

#### Einstein Summation Convention

Much vector algebra involves summation over suffices of products of vector components. In almost all cases of repeated suffices, we can suppress the summation notation entirely, if it is understood that an implicit sum is to be taken over any repeated suffix. Thus pairs of indefinite suffices in an expression are resolved by being summed over (or “traced” over).

#### Example

$$1.6.12 \quad a_j b_j = \sum_{j=1}^3 a_j b_j = \mathbf{a} \cdot \mathbf{b}.$$

Next,

$$1.6.13 \quad \mathbf{e}_1 = (1, 0, 0), \quad \mathbf{e}_2 = (0, 1, 0), \quad \mathbf{e}_3 = (0, 0, 1);$$

compare (1.6.5). Thus  $a_j \mathbf{e}_j = \mathbf{a}$ .

#### Levi-Civita Symbol

$$1.6.14 \quad \epsilon_{jkl} = \begin{cases} +1, & \text{if } j, k, l \text{ is even permutation of } 1, 2, 3, \\ -1, & \text{if } j, k, l \text{ is odd permutation of } 1, 2, 3, \\ 0, & \text{otherwise.} \end{cases}$$

#### Examples

$$1.6.15 \quad \epsilon_{123} = \epsilon_{312} = 1, \quad \epsilon_{213} = \epsilon_{321} = -1, \quad \epsilon_{221} = 0.$$

$$1.6.16 \quad \epsilon_{jkl} \epsilon_{lmn} = \delta_{j,m} \delta_{k,n} - \delta_{j,n} \delta_{k,m},$$

where  $\delta_{j,k}$  is the Kronecker delta.

$$1.6.17 \quad \mathbf{e}_j \times \mathbf{e}_k = \epsilon_{jkl} \mathbf{e}_l;$$

compare (1.6.8).

$$1.6.18 \quad a_j \mathbf{e}_j \times b_k \mathbf{e}_k = \epsilon_{jkl} a_j b_k \mathbf{e}_l;$$

compare (1.6.7)–(1.6.8).

Lastly, the volume of a parallelepiped with vectors  $\mathbf{a}$ ,  $\mathbf{b}$ , and  $\mathbf{c}$  as edges is  $|\epsilon_{jkl} a_j b_k c_l|$ .

### 1.6(iii) Vector-Valued Functions

#### Del Operator

$$1.6.19 \quad \nabla = \mathbf{i} \frac{\partial}{\partial x} + \mathbf{j} \frac{\partial}{\partial y} + \mathbf{k} \frac{\partial}{\partial z}.$$

The *gradient* of a differentiable scalar function  $f(x, y, z)$  is

$$1.6.20 \quad \text{grad } f = \nabla f = \frac{\partial f}{\partial x} \mathbf{i} + \frac{\partial f}{\partial y} \mathbf{j} + \frac{\partial f}{\partial z} \mathbf{k}.$$

The *divergence* of a differentiable vector-valued function  $\mathbf{F} = F_1 \mathbf{i} + F_2 \mathbf{j} + F_3 \mathbf{k}$  is

$$1.6.21 \quad \text{div } \mathbf{F} = \nabla \cdot \mathbf{F} = \frac{\partial F_1}{\partial x} + \frac{\partial F_2}{\partial y} + \frac{\partial F_3}{\partial z}.$$

The *curl* of  $\mathbf{F}$  is

$$1.6.22 \quad \begin{aligned} \text{curl } \mathbf{F} = \nabla \times \mathbf{F} &= \begin{vmatrix} \mathbf{i} & \mathbf{j} & \mathbf{k} \\ \frac{\partial}{\partial x} & \frac{\partial}{\partial y} & \frac{\partial}{\partial z} \\ F_1 & F_2 & F_3 \end{vmatrix} \\ &= \left( \frac{\partial F_3}{\partial y} - \frac{\partial F_2}{\partial z} \right) \mathbf{i} + \left( \frac{\partial F_1}{\partial z} - \frac{\partial F_3}{\partial x} \right) \mathbf{j} \\ &\quad + \left( \frac{\partial F_2}{\partial x} - \frac{\partial F_1}{\partial y} \right) \mathbf{k}. \end{aligned}$$

$$1.6.23 \quad \nabla(fg) = f \nabla g + g \nabla f,$$

$$1.6.24 \quad \nabla(f/g) = (g \nabla f - f \nabla g)/g^2,$$

$$1.6.25 \quad \nabla \cdot (f \mathbf{F}) = f(\nabla \cdot \mathbf{F}) + \mathbf{F} \cdot \nabla f,$$

$$1.6.26 \quad \nabla \cdot (\mathbf{F} \times \mathbf{G}) = \mathbf{G} \cdot (\nabla \times \mathbf{F}) - \mathbf{F} \cdot (\nabla \times \mathbf{G}),$$

$$1.6.27 \quad \nabla \cdot (\nabla \times \mathbf{F}) = \text{div curl } \mathbf{F} = 0,$$

$$1.6.28 \quad \nabla \times (f \mathbf{F}) = f(\nabla \times \mathbf{F}) + (\nabla f) \times \mathbf{F},$$

$$1.6.29 \quad \nabla \times (\nabla f) = \text{curl grad } f = 0,$$

$$1.6.30 \quad \nabla^2 f = \nabla \cdot (\nabla f),$$

$$1.6.31 \quad \nabla^2(fg) = f \nabla^2 g + g \nabla^2 f + 2(\nabla f \cdot \nabla g),$$

$$1.6.32 \quad \nabla \cdot (\nabla f \times \nabla g) = 0,$$

$$1.6.33 \quad \nabla \cdot (f \nabla g - g \nabla f) = f \nabla^2 g - g \nabla^2 f,$$

$$1.6.34 \quad \nabla \times (\nabla \times \mathbf{F}) = \text{curl curl } \mathbf{F} = \nabla(\nabla \cdot \mathbf{F}) - \nabla^2 \mathbf{F}.$$

### 1.6(iv) Path and Line Integrals

Note: The terminology *open* and *closed sets* and *boundary points* in the  $(x, y)$  plane that is used in this subsection and §1.6(v) is analogous to that introduced for the complex plane in §1.9(ii).

$\mathbf{c}(t) = (x(t), y(t), z(t))$ , with  $t$  ranging over an interval and  $x(t), y(t), z(t)$  differentiable, defines a *path*.

$$1.6.35 \quad \mathbf{c}'(t) = (x'(t), y'(t), z'(t)).$$

The *length* of a path for  $a \leq t \leq b$  is

$$1.6.36 \quad \int_a^b \|\mathbf{c}'(t)\| dt.$$

The *path integral* of a continuous function  $f(x, y, z)$  is

$$1.6.37 \quad \int_{\mathbf{c}} f ds = \int_a^b f(x(t), y(t), z(t)) \|\mathbf{c}'(t)\| dt.$$

The *line integral* of a vector-valued function  $\mathbf{F} = F_1\mathbf{i} + F_2\mathbf{j} + F_3\mathbf{k}$  along  $\mathbf{c}$  is given by

$$\begin{aligned} \int_{\mathbf{c}} \mathbf{F} \cdot d\mathbf{s} &= \int_a^b \mathbf{F}(\mathbf{c}(t)) \cdot \mathbf{c}'(t) dt \\ 1.6.38 \quad &= \int_a^b \left( F_1 \frac{dx}{dt} + F_2 \frac{dy}{dt} + F_3 \frac{dz}{dt} \right) dt \\ &= \int_{\mathbf{c}} F_1 dx + F_2 dy + F_3 dz. \end{aligned}$$

A path  $\mathbf{c}_1(t)$ ,  $t \in [a, b]$ , is a *reparametrization* of  $\mathbf{c}(t')$ ,  $t' \in [a', b']$ , if  $\mathbf{c}_1(t) = \mathbf{c}(t')$  and  $t' = h(t)$  with  $h(t)$  differentiable and monotonic. If  $h(a) = a'$  and  $h(b) = b'$ , then the reparametrization is called *orientation-preserving*, and

$$1.6.39 \quad \int_{\mathbf{c}} \mathbf{F} \cdot d\mathbf{s} = \int_{\mathbf{c}_1} \mathbf{F} \cdot d\mathbf{s}.$$

If  $h(a) = b'$  and  $h(b) = a'$ , then the reparametrization is *orientation-reversing* and

$$1.6.40 \quad \int_{\mathbf{c}} \mathbf{F} \cdot d\mathbf{s} = - \int_{\mathbf{c}_1} \mathbf{F} \cdot d\mathbf{s}.$$

In either case

$$1.6.41 \quad \int_{\mathbf{c}} f ds = \int_{\mathbf{c}_1} f ds,$$

when  $f$  is continuous, and

$$1.6.42 \quad \int_{\mathbf{c}} \nabla f \cdot d\mathbf{s} = f(\mathbf{c}(b)) - f(\mathbf{c}(a)),$$

when  $f$  is continuously differentiable.

The geometrical image  $C$  of a path  $\mathbf{c}$  is called a *simple closed curve* if  $\mathbf{c}$  is one-to-one, with the exception  $\mathbf{c}(a) = \mathbf{c}(b)$ . The curve  $C$  is *piecewise differentiable* if  $\mathbf{c}$  is piecewise differentiable. Note that  $C$  can be given an orientation by means of  $\mathbf{c}$ .

### Green's Theorem

Let

$$1.6.43 \quad \mathbf{F}(x, y) = F_1(x, y)\mathbf{i} + F_2(x, y)\mathbf{j}$$

and  $S$  be the closed and bounded point set in the  $(x, y)$  plane having a simple closed curve  $C$  as boundary. If  $C$  is oriented in the positive (anticlockwise) sense, then

$$1.6.44 \quad \iint_S \left( \frac{\partial F_2}{\partial x} - \frac{\partial F_1}{\partial y} \right) dA = \int_C \mathbf{F} \cdot d\mathbf{s} = \int_C F_1 dx + F_2 dy.$$

Sufficient conditions for this result to hold are that  $F_1(x, y)$  and  $F_2(x, y)$  are continuously differentiable on  $S$ , and  $C$  is piecewise differentiable.

The area of  $S$  can be found from (1.6.44) by taking  $\mathbf{F}(x, y) = -y\mathbf{i}, x\mathbf{j}$ , or  $-\frac{1}{2}y\mathbf{i} + \frac{1}{2}x\mathbf{j}$ .

### 1.6(v) Surfaces and Integrals over Surfaces

A *parametrized surface*  $S$  is defined by

$$1.6.45 \quad \Phi(u, v) = (x(u, v), y(u, v), z(u, v))$$

with  $(u, v) \in D$ , an open set in the plane.

For  $x, y$ , and  $z$  continuously differentiable, the vectors

$$1.6.46 \quad \mathbf{T}_u = \frac{\partial x}{\partial u}(u_0, v_0)\mathbf{i} + \frac{\partial y}{\partial u}(u_0, v_0)\mathbf{j} + \frac{\partial z}{\partial u}(u_0, v_0)\mathbf{k}$$

and

$$1.6.47 \quad \mathbf{T}_v = \frac{\partial x}{\partial v}(u_0, v_0)\mathbf{i} + \frac{\partial y}{\partial v}(u_0, v_0)\mathbf{j} + \frac{\partial z}{\partial v}(u_0, v_0)\mathbf{k}$$

are tangent to the surface at  $\Phi(u_0, v_0)$ . The surface is *smooth* at this point if  $\mathbf{T}_u \times \mathbf{T}_v \neq 0$ . A surface is *smooth* if it is smooth at every point. The vector  $\mathbf{T}_u \times \mathbf{T}_v$  at  $(u_0, v_0)$  is normal to the surface at  $\Phi(u_0, v_0)$ .

The *area*  $A(S)$  of a parametrized smooth surface is given by

$$1.6.48 \quad A(S) = \iint_D \|\mathbf{T}_u \times \mathbf{T}_v\| du dv,$$

and

$$\begin{aligned} &\|\mathbf{T}_u \times \mathbf{T}_v\| \\ 1.6.49 \quad &= \sqrt{\left( \frac{\partial(x, y)}{\partial(u, v)} \right)^2 + \left( \frac{\partial(y, z)}{\partial(u, v)} \right)^2 + \left( \frac{\partial(x, z)}{\partial(u, v)} \right)^2}. \end{aligned}$$

The area is independent of the parametrizations.

For a sphere  $x = \rho \sin \theta \cos \phi$ ,  $y = \rho \sin \theta \sin \phi$ ,  $z = \rho \cos \theta$ ,

$$1.6.50 \quad \|\mathbf{T}_\theta \times \mathbf{T}_\phi\| = \rho^2 |\sin \theta|.$$

For a surface  $z = f(x, y)$ ,

$$1.6.51 \quad A(S) = \iint_D \sqrt{1 + \left( \frac{\partial f}{\partial x} \right)^2 + \left( \frac{\partial f}{\partial y} \right)^2} dA.$$

For a surface of revolution,  $y = f(x)$ ,  $x \in [a, b]$ , about the  $x$ -axis,

$$1.6.52 \quad A(S) = 2\pi \int_a^b |f(x)| \sqrt{1 + (f'(x))^2} dx,$$

and about the  $y$ -axis,

$$1.6.53 \quad A(S) = 2\pi \int_a^b |x| \sqrt{1 + (f'(x))^2} dx.$$

The integral of a continuous function  $f(x, y, z)$  over a surface  $S$  is

$$1.6.54 \quad \iint_S f(x, y, z) dS = \iint_D f(\Phi(u, v)) \|\mathbf{T}_u \times \mathbf{T}_v\| du dv.$$

For a vector-valued function  $\mathbf{F}$ ,

$$1.6.55 \quad \iint_S \mathbf{F} \cdot d\mathbf{S} = \iint_D \mathbf{F} \cdot (\mathbf{T}_u \times \mathbf{T}_v) du dv,$$

where  $d\mathbf{S}$  is the surface element with an attached normal direction  $\mathbf{T}_u \times \mathbf{T}_v$ .

A surface is *orientable* if a continuously varying normal can be defined at all points of the surface. An orientable surface is *oriented* if suitable normals have been chosen. A parametrization  $\Phi(u, v)$  of an oriented surface  $S$  is *orientation preserving* if  $\mathbf{T}_u \times \mathbf{T}_v$  has the same direction as the chosen normal at each point of  $S$ , otherwise it is *orientation reversing*.

If  $\Phi_1$  and  $\Phi_2$  are both orientation preserving or both orientation reversing parametrizations of  $S$  defined on open sets  $D_1$  and  $D_2$  respectively, then

$$1.6.56 \quad \iint_{\Phi_1(D_1)} \mathbf{F} \cdot d\mathbf{S} = \iint_{\Phi_2(D_2)} \mathbf{F} \cdot d\mathbf{S};$$

otherwise, one is the negative of the other.

### Stokes's Theorem

Suppose  $S$  is an oriented surface with boundary  $\partial S$  which is oriented so that its direction is clockwise relative to the normals of  $S$ . Then

$$1.6.57 \quad \iint_S (\nabla \times \mathbf{F}) \cdot d\mathbf{S} = \int_{\partial S} \mathbf{F} \cdot d\mathbf{s},$$

when  $\mathbf{F}$  is a continuously differentiable vector-valued function.

### Gauss's (or Divergence) Theorem

Suppose  $S$  is a piecewise smooth surface which forms the complete boundary of a bounded closed point set  $V$ , and  $S$  is oriented by its normal being outwards from  $V$ . Then

$$1.6.58 \quad \iiint_V (\nabla \cdot \mathbf{F}) dV = \iint_S \mathbf{F} \cdot d\mathbf{S},$$

when  $\mathbf{F}$  is a continuously differentiable vector-valued function.

### Green's Theorem (for Volume)

For  $f$  and  $g$  twice-continuously differentiable functions

$$1.6.59 \quad \iiint_V (f\nabla^2 g + \nabla f \cdot \nabla g) dV = \iint_S f \frac{\partial g}{\partial n} dA,$$

and

$$1.6.60 \quad \iiint_V (f\nabla^2 g - g\nabla^2 f) dV = \iint_S \left( f \frac{\partial g}{\partial n} - g \frac{\partial f}{\partial n} \right) dA,$$

where  $\partial g / \partial n = \nabla g \cdot \mathbf{n}$  is the derivative of  $g$  normal to the surface outwards from  $V$  and  $\mathbf{n}$  is the unit outer normal vector.

## 1.7 Inequalities

### 1.7(i) Finite Sums

In this subsection  $A$  and  $B$  are positive constants.

#### Cauchy-Schwarz Inequality

$$1.7.1 \quad \left( \sum_{j=1}^n a_j b_j \right)^2 \leq \left( \sum_{j=1}^n a_j^2 \right) \left( \sum_{j=1}^n b_j^2 \right).$$

Equality holds iff  $a_j = cb_j$ ,  $\forall j$ ;  $c = \text{constant}$ .

Conversely, if  $\left( \sum_{j=1}^n a_j b_j \right)^2 \leq AB$  for all  $b_j$  such that  $\sum_{j=1}^n b_j^2 \leq B$ , then  $\sum_{j=1}^n a_j^2 \leq A$ .

#### Hölder's Inequality

For  $p > 1$ ,  $\frac{1}{p} + \frac{1}{q} = 1$ ,  $a_j \geq 0$ ,  $b_j \geq 0$ ,

$$1.7.2 \quad \sum_{j=1}^n a_j b_j \leq \left( \sum_{j=1}^n a_j^p \right)^{1/p} \left( \sum_{j=1}^n b_j^q \right)^{1/q}.$$

Equality holds iff  $a_j^p = cb_j^q$ ,  $\forall j$ ;  $c = \text{constant}$ .

Conversely, if  $\sum_{j=1}^n a_j b_j \leq A^{1/p} B^{1/q}$  for all  $b_j$  such that  $\sum_{j=1}^n b_j^q \leq B$ , then  $\sum_{j=1}^n a_j^p \leq A$ .

#### Minkowski's Inequality

For  $p > 1$ ,  $a_j \geq 0$ ,  $b_j \geq 0$ ,

$$1.7.3 \quad \left( \sum_{j=1}^n (a_j + b_j)^p \right)^{1/p} \leq \left( \sum_{j=1}^n a_j^p \right)^{1/p} + \left( \sum_{j=1}^n b_j^p \right)^{1/p}.$$

The direction of the inequality is reversed, that is,  $\geq$ , when  $0 < p < 1$ . Equality holds iff  $a_j = cb_j$ ,  $\forall j$ ;  $c = \text{constant}$ .

### 1.7(ii) Integrals

In this subsection  $a$  and  $b$  ( $> a$ ) are real constants that can be  $\mp\infty$ , provided that the corresponding integrals converge. Also  $A$  and  $B$  are constants that are not simultaneously zero.

**Cauchy–Schwarz Inequality**

1.7.4

$$\left( \int_a^b f(x)g(x) dx \right)^2 \leq \int_a^b (f(x))^2 dx \int_a^b (g(x))^2 dx.$$

Equality holds iff  $Af(x) = Bg(x)$  for all  $x$ .**Hölder's Inequality**For  $p > 1$ ,  $\frac{1}{p} + \frac{1}{q} = 1$ ,  $f(x) \geq 0$ ,  $g(x) \geq 0$ ,

$$\int_a^b f(x)g(x) dx \leq \left( \int_a^b (f(x))^p dx \right)^{1/p} \left( \int_a^b (g(x))^q dx \right)^{1/q}.$$

Equality holds iff  $A(f(x))^p = B(g(x))^q$  for all  $x$ .**Minkowski's Inequality**For  $p > 1$ ,  $f(x) \geq 0$ ,  $g(x) \geq 0$ ,

1.7.6

$$\left( \int_a^b (f(x) + g(x))^p dx \right)^{1/p} \leq \left( \int_a^b (f(x))^p dx \right)^{1/p} + \left( \int_a^b (g(x))^p dx \right)^{1/p}.$$

The direction of the inequality is reversed, that is,  $\geq$ , when  $0 < p < 1$ . Equality holds iff  $Af(x) = Bg(x)$  for all  $x$ .**1.7(iii) Means**

For the notation, see §1.2(iv).

1.7.7

$$H \leq G \leq A,$$

with equality iff  $a_1 = a_2 = \dots = a_n$ .1.7.8  $\min(a_1, a_2, \dots, a_n) \leq M(r) \leq \max(a_1, a_2, \dots, a_n)$ ,with equality iff  $a_1 = a_2 = \dots = a_n$ , or  $r < 0$  and some  $a_j = 0$ .

1.7.9

$$M(r) \leq M(s), \quad r < s,$$

with equality iff  $a_1 = a_2 = \dots = a_n$ , or  $s \leq 0$  and some  $a_j = 0$ .**1.7(iv) Jensen's Inequality**For  $f$  integrable on  $[0, 1]$ ,  $a < f(x) < b$ , and  $\phi$  convex on  $(a, b)$  (§1.4(viii)),

$$\phi \left( \int_0^1 f(x) dx \right) \leq \int_0^1 \phi(f(x)) dx,$$

$$\exp \left( \int_0^1 \ln(f(x)) dx \right) < \int_0^1 f(x) dx.$$

For exp and ln see §4.2.

**1.8 Fourier Series****1.8(i) Definitions and Elementary Properties**

Formally,

$$1.8.1 \quad f(x) = \frac{1}{2}a_0 + \sum_{n=1}^{\infty} (a_n \cos(nx) + b_n \sin(nx)),$$

$$a_n = \frac{1}{\pi} \int_{-\pi}^{\pi} f(x) \cos(nx) dx, \quad n = 0, 1, 2, \dots,$$

$$1.8.2 \quad b_n = \frac{1}{\pi} \int_{-\pi}^{\pi} f(x) \sin(nx) dx, \quad n = 1, 2, \dots$$

The series (1.8.1) is called the *Fourier series* of  $f(x)$ , and  $a_n, b_n$  are the *Fourier coefficients* of  $f(x)$ .If  $f(-x) = f(x)$ , then  $b_n = 0$  for all  $n$ .If  $f(-x) = -f(x)$ , then  $a_n = 0$  for all  $n$ .**Alternative Form**

$$1.8.3 \quad f(x) = \sum_{n=-\infty}^{\infty} c_n e^{inx},$$

$$1.8.4 \quad c_n = \frac{1}{2\pi} \int_{-\pi}^{\pi} f(x) e^{-inx} dx.$$

**Bessel's Inequality**

$$1.8.5 \quad \frac{1}{2}a_0^2 + \sum_{n=1}^{\infty} (a_n^2 + b_n^2) \leq \frac{1}{\pi} \int_{-\pi}^{\pi} (f(x))^2 dx.$$

$$1.8.6 \quad \sum_{n=-\infty}^{\infty} |c_n|^2 \leq \frac{1}{2\pi} \int_{-\pi}^{\pi} |f(x)|^2 dx.$$

**Asymptotic Estimates of Coefficients**If  $f(x)$  is of period  $2\pi$ , and  $f^{(m)}(x)$  is piecewise continuous, then

$$1.8.7 \quad a_n, b_n, c_n = o(n^{-m}), \quad n \rightarrow \infty.$$

**Uniqueness of Fourier Series**If  $f(x)$  and  $g(x)$  are continuous, have the same period and same Fourier coefficients, then  $f(x) = g(x)$  for all  $x$ .**Lebesgue Constants**

$$1.8.8 \quad L_n = \frac{1}{\pi} \int_0^{\pi} \frac{|\sin(n + \frac{1}{2})t|}{\sin(\frac{1}{2}t)} dt, \quad n = 0, 1, \dots$$

As  $n \rightarrow \infty$ 

$$1.8.9 \quad L_n \sim (4/\pi^2) \ln n;$$

see Frenzen and Wong (1986).

**Riemann–Lebesgue Lemma**

For  $f(x)$  piecewise continuous on  $[a, b]$  and real  $\lambda$ ,

$$1.8.10 \quad \int_a^b f(x)e^{i\lambda x} dx \rightarrow 0, \quad \text{as } \lambda \rightarrow \infty.$$

(1.8.10) continues to apply if either  $a$  or  $b$  or both are infinite and/or  $f(x)$  has finitely many singularities in  $(a, b)$ , provided that the integral converges uniformly (§1.5(iv)) at  $a, b$ , and the singularities for all sufficiently large  $\lambda$ .

**1.8(ii) Convergence**

Let  $f(x)$  be an absolutely integrable function of period  $2\pi$ , and continuous except at a finite number of points in any bounded interval. Then the series (1.8.1) converges to the sum

$$1.8.11 \quad \frac{1}{2}f(x-) + \frac{1}{2}f(x+)$$

at every point at which  $f(x)$  has both a left-hand derivative (that is, (1.4.4) applies when  $h \rightarrow 0-$ ) and a right-hand derivative (that is, (1.4.4) applies when  $h \rightarrow 0+$ ). The convergence is non-uniform, however, at points where  $f(x-) \neq f(x+)$ ; see §6.16(i).

For other tests for convergence see Titchmarsh (1962, pp. 405–410).

**1.8(iii) Integration and Differentiation**

If  $a_n$  and  $b_n$  are the Fourier coefficients of a piecewise continuous function  $f(x)$  on  $[0, 2\pi]$ , then

$$1.8.12 \quad \int_0^x (f(t) - \frac{1}{2}a_0) dt = \sum_{n=1}^{\infty} \frac{a_n \sin(nx) + b_n(1 - \cos(nx))}{n},$$

$$0 \leq x \leq 2\pi.$$

If a function  $f(x) \in C^2 [0, 2\pi]$  is periodic, with period  $2\pi$ , then the series obtained by differentiating the Fourier series for  $f(x)$  term by term converges at every point to  $f'(x)$ .

**1.8(iv) Transformations****Parseval's Formula**

$$1.8.13 \quad \frac{1}{\pi} \int_{-\pi}^{\pi} f(x)g(x) dx = \frac{1}{2}a_0a'_0 + \sum_{n=1}^{\infty} (a_n a'_n + b_n b'_n),$$

when  $f(x)$  and  $g(x)$  are square-integrable and  $a_n, b_n$  and  $a'_n, b'_n$  are their respective Fourier coefficients.

**Poisson's Summation Formula**

Suppose that  $f(x)$  is twice continuously differentiable and  $f(x)$  and  $|f''(x)|$  are integrable over  $(-\infty, \infty)$ . Then

$$1.8.14 \quad \sum_{n=-\infty}^{\infty} f(x+n) = \sum_{n=-\infty}^{\infty} e^{2\pi i n x} \int_{-\infty}^{\infty} f(t)e^{-2\pi i n t} dt.$$

An alternative formulation is as follows. Suppose that  $f(x)$  is continuous and of bounded variation on  $[0, \infty)$ . Suppose also that  $f(x)$  is integrable on  $[0, \infty)$  and  $f(x) \rightarrow 0$  as  $x \rightarrow \infty$ . Then

$$1.8.15 \quad \frac{1}{2}f(0) + \sum_{n=1}^{\infty} f(n) = \int_0^{\infty} f(x) dx$$

$$+ 2 \sum_{n=1}^{\infty} \int_0^{\infty} f(x) \cos(2\pi n x) dx.$$

As a special case

$$1.8.16 \quad \sum_{n=-\infty}^{\infty} e^{-(n+x)^2 \omega}$$

$$= \sqrt{\frac{\pi}{\omega}} \left( 1 + 2 \sum_{n=1}^{\infty} e^{-n^2 \pi^2 / \omega} \cos(2n\pi x) \right),$$

$$\Re \omega > 0.$$

**1.8(v) Examples**

For collections of Fourier-series expansions see Prudnikov *et al.* (1986a, v. 1, pp. 725–740), Gradshteyn and Ryzhik (2000, pp. 45–49), and Oberhettinger (1973).

**1.9 Calculus of a Complex Variable****1.9(i) Complex Numbers**

$$1.9.1 \quad z = x + iy, \quad x, y \in \mathbb{R}.$$

**Real and Imaginary Parts**

$$1.9.2 \quad \Re z = x, \quad \Im z = y.$$

**Polar Representation**

$$1.9.3 \quad x = r \cos \theta, \quad y = r \sin \theta,$$

where

$$1.9.4 \quad r = (x^2 + y^2)^{1/2},$$

and when  $z \neq 0$ ,

$$1.9.5 \quad \theta = \omega, \pi - \omega, -\pi + \omega, \text{ or } -\omega,$$

according as  $z$  lies in the 1st, 2nd, 3rd, or 4th quadrants. Here

$$1.9.6 \quad \omega = \arctan(|y/x|) \in [0, \frac{1}{2}\pi].$$

**Modulus and Phase**

1.9.7  $|z| = r, \quad \text{ph } z = \theta + 2n\pi, \quad n \in \mathbb{Z}.$

The *principal value* of  $\text{ph } z$  corresponds to  $n = 0$ , that is,  $-\pi \leq \text{ph } z \leq \pi$ . It is single-valued on  $\mathbb{C} \setminus \{0\}$ , except on the interval  $(-\infty, 0)$  where it is discontinuous and two-valued. *Unless indicated otherwise*, these principal values are assumed throughout this Handbook. (However, if we require a principal value to be single-valued, then we can restrict  $-\pi < \text{ph } z \leq \pi$ .)

1.9.8  $|\Re z| \leq |z|, \quad |\Im z| \leq |z|,$

1.9.9  $z = re^{i\theta},$

where

1.9.10  $e^{i\theta} = \cos \theta + i \sin \theta;$

see §4.14.

**Complex Conjugate**

1.9.11  $\bar{z} = x - iy,$

1.9.12  $|\bar{z}| = |z|,$

1.9.13  $\text{ph } \bar{z} = -\text{ph } z.$

**Arithmetic Operations**

If  $z_1 = x_1 + iy_1, z_2 = x_2 + iy_2$ , then

1.9.14  $z_1 \pm z_2 = x_1 \pm x_2 + i(y_1 \pm y_2),$

1.9.15  $z_1 z_2 = x_1 x_2 - y_1 y_2 + i(x_1 y_2 + x_2 y_1),$

1.9.16  $\frac{z_1}{z_2} = \frac{z_1 \bar{z}_2}{|z_2|^2} = \frac{x_1 x_2 + y_1 y_2 + i(x_2 y_1 - x_1 y_2)}{x_2^2 + y_2^2},$

provided that  $z_2 \neq 0$ . Also,

1.9.17  $|z_1 z_2| = |z_1| |z_2|,$

1.9.18  $\text{ph}(z_1 z_2) = \text{ph } z_1 + \text{ph } z_2,$

1.9.19  $\left| \frac{z_1}{z_2} \right| = \frac{|z_1|}{|z_2|},$

1.9.20  $\text{ph } \frac{z_1}{z_2} = \text{ph } z_1 - \text{ph } z_2.$

Equations (1.9.18) and (1.9.20) hold for general values of the phases, but not necessarily for the principal values.

**Powers**

1.9.21 
$$z^n = \left( x^n - \binom{n}{2} x^{n-2} y^2 + \binom{n}{4} x^{n-4} y^4 - \dots \right) + i \left( \binom{n}{1} x^{n-1} y - \binom{n}{3} x^{n-3} y^3 + \dots \right),$$

$$n = 1, 2, \dots$$

**DeMoivre's Theorem**

1.9.22  $\cos n\theta + i \sin n\theta = (\cos \theta + i \sin \theta)^n, \quad n \in \mathbb{Z}.$

**Triangle Inequality**

1.9.23  $||z_1| - |z_2|| \leq |z_1 + z_2| \leq |z_1| + |z_2|.$

**1.9(ii) Continuity, Point Sets, and Differentiation**

**Continuity**

A function  $f(z)$  is *continuous* at a point  $z_0$  if  $\lim_{z \rightarrow z_0} f(z) = f(z_0)$ . That is, given any positive number  $\epsilon$ , however small, we can find a positive number  $\delta$  such that  $|f(z) - f(z_0)| < \epsilon$  for all  $z$  in the open disk  $|z - z_0| < \delta$ .

A function of two complex variables  $f(z, w)$  is *continuous* at  $(z_0, w_0)$  if  $\lim_{(z,w) \rightarrow (z_0,w_0)} f(z, w) = f(z_0, w_0)$ ; compare (1.5.1) and (1.5.2).

**Point Sets in  $\mathbb{C}$**

A *neighborhood* of a point  $z_0$  is a disk  $|z - z_0| < \delta$ . An *open set* in  $\mathbb{C}$  is one in which each point has a neighborhood that is contained in the set.

A point  $z_0$  is a *limit point* (*limiting point* or *accumulation point*) of a set of points  $S$  in  $\mathbb{C}$  (or  $\mathbb{C} \cup \infty$ ) if every neighborhood of  $z_0$  contains a point of  $S$  distinct from  $z_0$ . ( $z_0$  may or may not belong to  $S$ .) As a consequence, every neighborhood of a limit point of  $S$  contains an infinite number of points of  $S$ . Also, the union of  $S$  and its limit points is the *closure* of  $S$ .

A *domain*  $D$ , say, is an open set in  $\mathbb{C}$  that is *connected*, that is, any two points can be joined by a polygonal arc (a finite chain of straight-line segments) lying in the set. Any point whose neighborhoods always contain members and nonmembers of  $D$  is a *boundary point* of  $D$ . When its boundary points are added the domain is said to be *closed*, but unless specified otherwise a domain is assumed to be open.

A *region* is an open domain together with none, some, or all of its boundary points. Points of a region that are not boundary points are called *interior points*.

A function  $f(z)$  is *continuous on a region*  $R$  if for each point  $z_0$  in  $R$  and any given number  $\epsilon (> 0)$  we can find a neighborhood of  $z_0$  such that  $|f(z) - f(z_0)| < \epsilon$  for all points  $z$  in the intersection of the neighborhood with  $R$ .

**Differentiation**

A function  $f(z)$  is *differentiable* at a point  $z$  if the following limit exists:

1.9.24  $f'(z) = \frac{df}{dz} = \lim_{h \rightarrow 0} \frac{f(z+h) - f(z)}{h}.$

Differentiability automatically implies continuity.



**Cauchy–Riemann Equations**

If  $f'(z)$  exists at  $z = x + iy$  and  $f(z) = u(x, y) + iv(x, y)$ , then

$$1.9.25 \quad \frac{\partial u}{\partial x} = \frac{\partial v}{\partial y}, \quad \frac{\partial u}{\partial y} = -\frac{\partial v}{\partial x}$$

at  $(x, y)$ .

Conversely, if at a given point  $(x, y)$  the partial derivatives  $\partial u/\partial x$ ,  $\partial u/\partial y$ ,  $\partial v/\partial x$ , and  $\partial v/\partial y$  exist, are continuous, and satisfy (1.9.25), then  $f(z)$  is differentiable at  $z = x + iy$ .

**Analyticity**

A function  $f(z)$  is said to be *analytic (holomorphic)* at  $z = z_0$  if it is differentiable in a neighborhood of  $z_0$ .

A function  $f(z)$  is *analytic in a domain  $D$*  if it is analytic at each point of  $D$ . A function analytic at every point of  $\mathbb{C}$  is said to be *entire*.

If  $f(z)$  is analytic in an open domain  $D$ , then each of its derivatives  $f'(z)$ ,  $f''(z)$ , ... exists and is analytic in  $D$ .

**Harmonic Functions**

If  $f(z) = u(x, y) + iv(x, y)$  is analytic in an open domain  $D$ , then  $u$  and  $v$  are *harmonic* in  $D$ , that is,

$$1.9.26 \quad \frac{\partial^2 u}{\partial x^2} + \frac{\partial^2 u}{\partial y^2} = \frac{\partial^2 v}{\partial x^2} + \frac{\partial^2 v}{\partial y^2} = 0,$$

or in polar form ((1.9.3))  $u$  and  $v$  satisfy

$$1.9.27 \quad \frac{\partial^2 u}{\partial r^2} + \frac{1}{r} \frac{\partial u}{\partial r} + \frac{1}{r^2} \frac{\partial^2 u}{\partial \theta^2} = 0$$

at all points of  $D$ .

**1.9(iii) Integration**

An *arc  $C$*  is given by  $z(t) = x(t) + iy(t)$ ,  $a \leq t \leq b$ , where  $x$  and  $y$  are continuously differentiable. If  $x(t)$  and  $y(t)$  are continuous and  $x'(t)$  and  $y'(t)$  are piecewise continuous, then  $z(t)$  defines a *contour*.

A contour is *simple* if it contains no multiple points, that is, for every pair of distinct values  $t_1, t_2$  of  $t$ ,  $z(t_1) \neq z(t_2)$ . A *simple closed contour* is a simple contour, except that  $z(a) = z(b)$ .

Next,

$$1.9.28 \quad \int_C f(z) dz = \int_a^b f(z(t))(x'(t) + iy'(t)) dt,$$

for a contour  $C$  and  $f(z(t))$  continuous,  $a \leq t \leq b$ . If  $f(z(t_0)) = \infty$ ,  $a \leq t_0 \leq b$ , then the integral is defined analogously to the infinite integrals in §1.4(v). Similarly when  $a = -\infty$  or  $b = +\infty$ .

**Jordan Curve Theorem**

Any simple closed contour  $C$  divides  $\mathbb{C}$  into two open domains that have  $C$  as common boundary. One of these domains is bounded and is called the *interior domain of  $C$* ; the other is unbounded and is called the *exterior domain of  $C$* .

**Cauchy's Theorem**

If  $f(z)$  is continuous within and on a simple closed contour  $C$  and analytic within  $C$ , then

$$1.9.29 \quad \int_C f(z) dz = 0.$$

**Cauchy's Integral Formula**

If  $f(z)$  is continuous within and on a simple closed contour  $C$  and analytic within  $C$ , and if  $z_0$  is a point within  $C$ , then

$$1.9.30 \quad f(z_0) = \frac{1}{2\pi i} \int_C \frac{f(z)}{z - z_0} dz,$$

and

$$1.9.31 \quad f^{(n)}(z_0) = \frac{n!}{2\pi i} \int_C \frac{f(z)}{(z - z_0)^{n+1}} dz, \quad n = 1, 2, 3, \dots,$$

provided that in both cases  $C$  is described in the positive rotational (anticlockwise) sense.

**Liouville's Theorem**

Any bounded entire function is a constant.

**Winding Number**

If  $C$  is a closed contour, and  $z_0 \notin C$ , then

$$1.9.32 \quad \frac{1}{2\pi i} \int_C \frac{1}{z - z_0} dz = \mathcal{N}(C, z_0),$$

where  $\mathcal{N}(C, z_0)$  is an integer called the *winding number of  $C$  with respect to  $z_0$* . If  $C$  is simple and oriented in the positive rotational sense, then  $\mathcal{N}(C, z_0)$  is 1 or 0 depending whether  $z_0$  is inside or outside  $C$ .

**Mean Value Property**

For  $u(z)$  harmonic,

$$1.9.33 \quad u(z) = \frac{1}{2\pi} \int_0^{2\pi} u(z + re^{i\phi}) d\phi.$$

**Poisson Integral**

If  $h(w)$  is continuous on  $|w| = R$ , then with  $z = re^{i\theta}$

$$1.9.34 \quad u(re^{i\theta}) = \frac{1}{2\pi} \int_0^{2\pi} \frac{(R^2 - r^2)h(Re^{i\phi}) d\phi}{R^2 - 2Rr \cos(\phi - \theta) + r^2}$$

is harmonic in  $|z| < R$ . Also with  $|w| = R$ ,  $\lim_{z \rightarrow w} u(z) = h(w)$  as  $z \rightarrow w$  within  $|z| < R$ .

**1.9(iv) Conformal Mapping**

The *extended complex plane*,  $\mathbb{C} \cup \{\infty\}$ , consists of the points of the complex plane  $\mathbb{C}$  together with an ideal point  $\infty$  called the *point at infinity*. A system of *open disks around infinity* is given by

$$1.9.35 \quad S_r = \{z \mid |z| > 1/r\} \cup \{\infty\}, \quad 0 < r < \infty.$$

Each  $S_r$  is a *neighborhood* of  $\infty$ . Also,

$$1.9.36 \quad \infty \pm z = z \pm \infty = \infty,$$

$$1.9.37 \quad \infty \cdot z = z \cdot \infty = \infty, \quad z \neq 0,$$

$$1.9.38 \quad z/\infty = 0,$$

$$1.9.39 \quad z/0 = \infty, \quad z \neq 0.$$

A function  $f(z)$  is *analytic at  $\infty$*  if  $g(z) = f(1/z)$  is analytic at  $z = 0$ , and we set  $f'(\infty) = g'(0)$ .

### Conformal Transformation

Suppose  $f(z)$  is analytic in a domain  $D$  and  $C_1, C_2$  are two arcs in  $D$  passing through  $z_0$ . Let  $C'_1, C'_2$  be the images of  $C_1$  and  $C_2$  under the mapping  $w = f(z)$ . The *angle between  $C_1$  and  $C_2$*  at  $z_0$  is the angle between the tangents to the two arcs at  $z_0$ , that is, the difference of the signed angles that the tangents make with the positive direction of the real axis. If  $f'(z_0) \neq 0$ , then the angle between  $C_1$  and  $C_2$  equals the angle between  $C'_1$  and  $C'_2$  both in magnitude and sense. We then say that the mapping  $w = f(z)$  is *conformal* (angle-preserving) at  $z_0$ .

The *linear transformation*  $f(z) = az + b$ ,  $a \neq 0$ , has  $f'(z) = a$  and  $w = f(z)$  maps  $\mathbb{C}$  conformally onto  $\mathbb{C}$ .

### Bilinear Transformation

$$1.9.40 \quad w = f(z) = \frac{az + b}{cz + d}, \quad ad - bc \neq 0, \quad c \neq 0.$$

$$1.9.41 \quad f(-d/c) = \infty, \quad f(\infty) = a/c.$$

$$1.9.42 \quad f'(z) = \frac{ad - bc}{(cz + d)^2}, \quad z \neq -d/c.$$

$$1.9.43 \quad f'(\infty) = \frac{bc - ad}{c^2}.$$

$$1.9.44 \quad z = \frac{dw - b}{-cw + a}.$$

The transformation (1.9.40) is a one-to-one conformal mapping of  $\mathbb{C} \cup \{\infty\}$  onto itself.

The *cross ratio* of  $z_1, z_2, z_3, z_4 \in \mathbb{C} \cup \{\infty\}$  is defined by

$$1.9.45 \quad \frac{(z_1 - z_2)(z_3 - z_4)}{(z_1 - z_4)(z_3 - z_2)},$$

or its limiting form, and is invariant under bilinear transformations.

Other names for the bilinear transformation are *fractional linear transformation*, *homographic transformation*, and *Möbius transformation*.

### 1.9(v) Infinite Sequences and Series

A sequence  $\{z_n\}$  *converges* to  $z$  if  $\lim_{n \rightarrow \infty} z_n = z$ . For  $z_n = x_n + iy_n$ , the sequence  $\{z_n\}$  converges iff the sequences  $\{x_n\}$  and  $\{y_n\}$  separately converge. A *series*  $\sum_{n=0}^{\infty} z_n$  *converges* if the sequence  $s_n = \sum_{k=0}^n z_k$  converges. The series is *divergent* if  $s_n$  does not converge. The series converges *absolutely* if  $\sum_{n=0}^{\infty} |z_n|$  converges.

A series  $\sum_{n=0}^{\infty} z_n$  converges (diverges) absolutely when  $\lim_{n \rightarrow \infty} |z_n|^{1/n} < 1$  ( $> 1$ ), or when  $\lim_{n \rightarrow \infty} |z_{n+1}/z_n| < 1$  ( $> 1$ ). Absolutely convergent series are also convergent.

Let  $\{f_n(z)\}$  be a sequence of functions defined on a set  $S$ . This sequence *converges pointwise* to a function  $f(z)$  if

$$1.9.46 \quad f(z) = \lim_{n \rightarrow \infty} f_n(z)$$

for each  $z \in S$ . The sequence *converges uniformly* on  $S$ , if for every  $\epsilon > 0$  there exists an integer  $N$ , independent of  $z$ , such that

$$1.9.47 \quad |f_n(z) - f(z)| < \epsilon$$

for all  $z \in S$  and  $n \geq N$ .

A series  $\sum_{n=0}^{\infty} f_n(z)$  *converges uniformly* on  $S$ , if the sequence  $s_n(z) = \sum_{k=0}^n f_k(z)$  converges uniformly on  $S$ .

### Weierstrass M-test

Suppose  $\{M_n\}$  is a sequence of real numbers such that  $\sum_{n=0}^{\infty} M_n$  converges and  $|f_n(z)| \leq M_n$  for all  $z \in S$  and all  $n \geq 0$ . Then the series  $\sum_{n=0}^{\infty} f_n(z)$  converges uniformly on  $S$ .

A doubly-infinite series  $\sum_{n=-\infty}^{\infty} f_n(z)$  converges (uniformly) on  $S$  iff each of the series  $\sum_{n=0}^{\infty} f_n(z)$  and  $\sum_{n=1}^{\infty} f_{-n}(z)$  converges (uniformly) on  $S$ .

### 1.9(vi) Power Series

For a series  $\sum_{n=0}^{\infty} a_n(z - z_0)^n$  there is a number  $R$ ,  $0 \leq R \leq \infty$ , such that the series converges for all  $z$  in  $|z - z_0| < R$  and diverges for  $z$  in  $|z - z_0| > R$ . The circle  $|z - z_0| = R$  is called the *circle of convergence* of the series, and  $R$  is the *radius of convergence*. Inside the circle the sum of the series is an analytic function  $f(z)$ . For  $z$  in  $|z - z_0| \leq \rho$  ( $< R$ ), the convergence is absolute and uniform. Moreover,

$$1.9.48 \quad a_n = \frac{f^{(n)}(z_0)}{n!},$$

and

$$1.9.49 \quad R = \liminf_{n \rightarrow \infty} |a_n|^{-1/n}.$$

For the converse of this result see §1.10(i).

### Operations

When  $\sum a_n z^n$  and  $\sum b_n z^n$  both converge

$$1.9.50 \quad \sum_{n=0}^{\infty} (a_n \pm b_n) z^n = \sum_{n=0}^{\infty} a_n z^n \pm \sum_{n=0}^{\infty} b_n z^n,$$

and

$$1.9.51 \quad \left( \sum_{n=0}^{\infty} a_n z^n \right) \left( \sum_{n=0}^{\infty} b_n z^n \right) = \sum_{n=0}^{\infty} c_n z^n,$$

where

$$1.9.52 \quad c_n = \sum_{k=0}^n a_k b_{n-k}.$$

Next, let

$$1.9.53 \quad f(z) = a_0 + a_1 z + a_2 z^2 + \cdots, \quad a_0 \neq 0.$$

Then the expansions (1.9.54), (1.9.57), and (1.9.60) hold for all sufficiently small  $|z|$ .

$$1.9.54 \quad \frac{1}{f(z)} = b_0 + b_1 z + b_2 z^2 + \cdots,$$

where

$$1.9.55 \quad b_0 = 1/a_0, \quad b_1 = -a_1/a_0^2, \quad b_2 = (a_1^2 - a_0 a_2)/a_0^3,$$

$$1.9.56 \quad b_n = -(a_1 b_{n-1} + a_2 b_{n-2} + \cdots + a_n b_0)/a_0, \quad n \geq 1.$$

With  $a_0 = 1$ ,

$$1.9.57 \quad \ln f(z) = q_1 z + q_2 z^2 + q_3 z^3 + \cdots,$$

(principal value), where

$$1.9.58 \quad q_1 = a_1, \quad q_2 = (2a_2 - a_1^2)/2, \\ q_3 = (3a_3 - 3a_1 a_2 + a_1^3)/3,$$

and

$$1.9.59 \quad q_n = (n a_n - (n-1) a_1 q_{n-1} - (n-2) a_2 q_{n-2} - \cdots \\ - a_{n-1} q_1)/n, \\ n \geq 2.$$

Also,

$$1.9.60 \quad (f(z))^\nu = p_0 + p_1 z + p_2 z^2 + \cdots,$$

(principal value), where  $\nu \in \mathbb{C}$ ,

$$1.9.61 \quad p_0 = 1, \quad p_1 = \nu a_1, \quad p_2 = \nu((\nu-1)a_1^2 + 2a_2)/2,$$

and

$$1.9.62 \quad p_n = ((\nu-n+1)a_1 p_{n-1} + (2\nu-n+2)a_2 p_{n-2} + \cdots \\ + ((n-1)\nu-1)a_{n-1} p_1 + n \nu a_n)/n, \\ n \geq 1.$$

For the definitions of the principal values of  $\ln f(z)$  and  $(f(z))^\nu$  see §§4.2(i) and 4.2(iv).

Lastly, a power series can be differentiated any number of times within its circle of convergence:

$$1.9.63 \quad f^{(m)}(z) = \sum_{n=0}^{\infty} (n+1)_m a_{n+m} (z-z_0)^n, \\ |z-z_0| < R, \quad m = 0, 1, 2, \dots$$

## 1.9(vii) Inversion of Limits

### Double Sequences and Series

A set of complex numbers  $\{z_{m,n}\}$  where  $m$  and  $n$  take all positive integer values is called a *double sequence*. It *converges to  $z$*  if for every  $\epsilon > 0$ , there is an integer  $N$  such that

$$1.9.64 \quad |z_{m,n} - z| < \epsilon$$

for all  $m, n \geq N$ . Suppose  $\{z_{m,n}\}$  converges to  $z$  and the repeated limits

$$1.9.65 \quad \lim_{m \rightarrow \infty} \left( \lim_{n \rightarrow \infty} z_{m,n} \right), \quad \lim_{n \rightarrow \infty} \left( \lim_{m \rightarrow \infty} z_{m,n} \right)$$

exist. Then both repeated limits equal  $z$ .

A *double series* is the limit of the double sequence

$$1.9.66 \quad z_{p,q} = \sum_{m=0}^p \sum_{n=0}^q \zeta_{m,n}.$$

If the limit exists, then the double series is *convergent*; otherwise it is *divergent*. The double series is *absolutely convergent* if it is convergent when  $\zeta_{m,n}$  is replaced by  $|\zeta_{m,n}|$ .

If a double series is absolutely convergent, then it is also convergent and its sum is given by either of the repeated sums

$$1.9.67 \quad \sum_{m=0}^{\infty} \left( \sum_{n=0}^{\infty} \zeta_{m,n} \right), \quad \sum_{n=0}^{\infty} \left( \sum_{m=0}^{\infty} \zeta_{m,n} \right).$$

### Term-by-Term Integration

Suppose the series  $\sum_{n=0}^{\infty} f_n(z)$ , where  $f_n(z)$  is continuous, converges uniformly on every *compact set* of a domain  $D$ , that is, every closed and bounded set in  $D$ . Then

$$1.9.68 \quad \int_C \sum_{n=0}^{\infty} f_n(z) dz = \sum_{n=0}^{\infty} \int_C f_n(z) dz$$

for any finite contour  $C$  in  $D$ .

### Dominated Convergence Theorem

Let  $(a, b)$  be a finite or infinite interval, and  $f_0(t), f_1(t), \dots$  be real or complex continuous functions,  $t \in (a, b)$ . Suppose  $\sum_{n=0}^{\infty} f_n(t)$  converges uniformly in any compact interval in  $(a, b)$ , and at least one of the following two conditions is satisfied:

$$1.9.69 \quad \int_a^b \sum_{n=0}^{\infty} |f_n(t)| dt < \infty,$$

$$1.9.70 \quad \sum_{n=0}^{\infty} \int_a^b |f_n(t)| dt < \infty.$$

Then

$$1.9.71 \quad \int_a^b \sum_{n=0}^{\infty} f_n(t) dt = \sum_{n=0}^{\infty} \int_a^b f_n(t) dt.$$

## 1.10 Functions of a Complex Variable

### 1.10(i) Taylor's Theorem for Complex Variables

Let  $f(z)$  be analytic on the disk  $|z - z_0| < R$ . Then

$$1.10.1 \quad f(z) = \sum_{n=0}^{\infty} \frac{f^{(n)}(z_0)}{n!} (z - z_0)^n.$$

The right-hand side is the *Taylor series* for  $f(z)$  at  $z = z_0$ , and its radius of convergence is at least  $R$ .

**Examples**

$$1.10.2 \quad e^z = 1 + \frac{z}{1!} + \frac{z^2}{2!} + \cdots, \quad |z| < \infty,$$

$$1.10.3 \quad \ln(1+z) = z - \frac{z^2}{2} + \frac{z^3}{3} - \cdots, \quad |z| < 1,$$

$$1.10.4 \quad (1-z)^{-\alpha} = 1 + \alpha z + \frac{\alpha(\alpha+1)}{2!} z^2 + \frac{\alpha(\alpha+1)(\alpha+2)}{3!} z^3 + \cdots, \quad |z| < 1.$$

Again, in these examples  $\ln(1+z)$  and  $(1-z)^{-\alpha}$  have their principal values; see §§4.2(i) and 4.2(iv).

**Zeros**

An analytic function  $f(z)$  has a *zero of order* (or *multiplicity*)  $m$  ( $\geq 1$ ) at  $z_0$  if the first nonzero coefficient in its Taylor series at  $z_0$  is that of  $(z-z_0)^m$ . When  $m=1$  the zero is *simple*.

**1.10(ii) Analytic Continuation**

Let  $f_1(z)$  be analytic in a domain  $D_1$ . If  $f_2(z)$ , analytic in  $D_2$ , equals  $f_1(z)$  on an arc in  $D = D_1 \cap D_2$ , or on just an infinite number of points with a limit point in  $D$ , then they are equal throughout  $D$  and  $f_2(z)$  is called an *analytic continuation* of  $f_1(z)$ . We write  $(f_1, D_1)$ ,  $(f_2, D_2)$  to signify this continuation.

Suppose  $z(t) = x(t) + iy(t)$ ,  $a \leq t \leq b$ , is an arc and  $a = t_0 < t_1 < \cdots < t_n = b$ . Suppose the subarc  $z(t)$ ,  $t \in [t_{j-1}, t_j]$  is contained in a domain  $D_j$ ,  $j = 1, \dots, n$ . The function  $f_1(z)$  on  $D_1$  is said to be *analytically continued along the path*  $z(t)$ ,  $a \leq t \leq b$ , if there is a chain  $(f_1, D_1), (f_2, D_2), \dots, (f_n, D_n)$ .

Analytic continuation is a powerful aid in establishing transformations or functional equations for complex variables, because it enables the problem to be reduced to: (a) deriving the transformation (or functional equation) with real variables; followed by (b) finding the domain on which the transformed function is analytic.

**Schwarz Reflection Principle**

Let  $C$  be a simple closed contour consisting of a segment  $AB$  of the real axis and a contour in the upper half-plane joining the ends of  $AB$ . Also, let  $f(z)$  be analytic within  $C$ , continuous within and on  $C$ , and real on  $AB$ . Then  $f(z)$  can be continued analytically across  $AB$  by *reflection*, that is,

$$1.10.5 \quad f(\bar{z}) = \overline{f(z)}.$$

**1.10(iii) Laurent Series**

Suppose  $f(z)$  is analytic in the *annulus*  $r_1 < |z - z_0| < r_2$ ,  $0 \leq r_1 < r_2 \leq \infty$ , and  $r \in (r_1, r_2)$ . Then

$$1.10.6 \quad f(z) = \sum_{n=-\infty}^{\infty} a_n (z - z_0)^n,$$

where

$$1.10.7 \quad a_n = \frac{1}{2\pi i} \int_{|z-z_0|=r} \frac{f(z)}{(z-z_0)^{n+1}} dz,$$

and the integration contour is described once in the positive sense. The series (1.10.6) converges uniformly and absolutely on compact sets in the annulus.

Let  $r_1 = 0$ , so that the annulus becomes the *punctured neighborhood*  $N$ :  $0 < |z - z_0| < r_2$ , and assume that  $f(z)$  is analytic in  $N$ , but not at  $z_0$ . Then  $z = z_0$  is an *isolated singularity* of  $f(z)$ . This singularity is *removable* if  $a_n = 0$  for all  $n < 0$ , and in this case the Laurent series becomes the Taylor series. Next,  $z_0$  is a *pole* if  $a_n \neq 0$  for at least one, but only finitely many, negative  $n$ . If  $-n$  is the first negative integer (counting from  $-\infty$ ) with  $a_{-n} \neq 0$ , then  $z_0$  is a *pole of order* (or *multiplicity*)  $n$ . Lastly, if  $a_n \neq 0$  for infinitely many negative  $n$ , then  $z_0$  is an *isolated essential singularity*.

The singularities of  $f(z)$  at infinity are classified in the same way as the singularities of  $f(1/z)$  at  $z = 0$ .

An isolated singularity  $z_0$  is always removable when  $\lim_{z \rightarrow z_0} f(z)$  exists, for example  $(\sin z)/z$  at  $z = 0$ .

The coefficient  $a_{-1}$  of  $(z-z_0)^{-1}$  in the Laurent series for  $f(z)$  is called the *residue* of  $f(z)$  at  $z_0$ , and denoted by  $\text{res}_{z=z_0}[f(z)]$ ,  $\text{res}_{z=z_0}[f(z)]$ , or (when there is no ambiguity)  $\text{res}[f(z)]$ .

A function whose only singularities, other than the point at infinity, are poles is called a *meromorphic function*. If the poles are infinite in number, then the point at infinity is called an *essential singularity*: it is the limit point of the poles.

**Picard's Theorem**

In any neighborhood of an isolated essential singularity, however small, an analytic function assumes every value in  $\mathbb{C}$  with at most one exception.

**1.10(iv) Residue Theorem**

If  $f(z)$  is analytic within a simple closed contour  $C$ , and continuous within and on  $C$ —except in both instances for a finite number of singularities within  $C$ —then

$$1.10.8 \quad \frac{1}{2\pi i} \int_C f(z) dz = \text{sum of the residues of } f(z) \text{ within } C.$$

Here and elsewhere in this subsection the path  $C$  is described in the positive sense.

**Phase (or Argument) Principle**

If the singularities within  $C$  are poles and  $f(z)$  is analytic and nonvanishing on  $C$ , then

$$1.10.9 \quad N - P = \frac{1}{2\pi i} \int_C \frac{f'(z)}{f(z)} dz = \frac{1}{2\pi} \Delta_C(\text{ph } f(z)),$$

where  $N$  and  $P$  are respectively the numbers of zeros and poles, counting multiplicity, of  $f$  within  $C$ , and  $\Delta_C(\text{ph } f(z))$  is the change in any continuous branch of  $\text{ph}(f(z))$  as  $z$  passes once around  $C$  in the positive sense. For examples of applications see Olver (1997b, pp. 252–254).

In addition,

$$1.10.10 \quad \frac{1}{2\pi i} \int_C \frac{zf'(z)}{f(z)} dz = (\text{sum of locations of zeros}) - (\text{sum of locations of poles}),$$

each location again being counted with multiplicity equal to that of the corresponding zero or pole.

**Rouché’s Theorem**

If  $f(z)$  and  $g(z)$  are analytic on and inside a simple closed contour  $C$ , and  $|g(z)| < |f(z)|$  on  $C$ , then  $f(z)$  and  $f(z) + g(z)$  have the same number of zeros inside  $C$ .

**1.10(v) Maximum-Modulus Principle**

**Analytic Functions**

If  $f(z)$  is analytic in a domain  $D$ ,  $z_0 \in D$  and  $|f(z)| \leq |f(z_0)|$  for all  $z \in D$ , then  $f(z)$  is a constant in  $D$ .

Let  $D$  be a bounded domain with boundary  $\partial D$  and let  $\bar{D} = D \cup \partial D$ . If  $f(z)$  is continuous on  $\bar{D}$  and analytic in  $D$ , then  $|f(z)|$  attains its maximum on  $\partial D$ .

**Harmonic Functions**

If  $u(z)$  is harmonic in  $D$ ,  $z_0 \in D$ , and  $u(z) \leq u(z_0)$  for all  $z \in D$ , then  $u(z)$  is constant in  $D$ . Moreover, if  $D$  is bounded and  $u(z)$  is continuous on  $\bar{D}$  and harmonic in  $D$ , then  $u(z)$  is maximum at some point on  $\partial D$ .

**Schwarz’s Lemma**

In  $|z| < R$ , if  $f(z)$  is analytic,  $|f(z)| \leq M$ , and  $f(0) = 0$ , then

$$1.10.11 \quad |f(z)| \leq \frac{M|z|}{R} \quad \text{and} \quad |f'(0)| \leq \frac{M}{R}.$$

Equalities hold iff  $f(z) = Az$ , where  $A$  is a constant such that  $|A| = M/R$ .

**1.10(vi) Multivalued Functions**

Functions which have more than one value at a given point  $z$  are called *multivalued* (or *many-valued*) functions. Let  $F(z)$  be a multivalued function and  $D$  be a domain. If we can assign a unique value  $f(z)$  to  $F(z)$  at each point of  $D$ , and  $f(z)$  is analytic on  $D$ , then  $f(z)$  is a *branch* of  $F(z)$ .

**Example**

$F(z) = \sqrt{z}$  is two-valued for  $z \neq 0$ . If  $D = \mathbb{C} \setminus (-\infty, 0]$  and  $z = re^{i\theta}$ , then one branch is  $\sqrt{r}e^{i\theta/2}$ , the other branch is  $-\sqrt{r}e^{i\theta/2}$ , with  $-\pi < \theta < \pi$  in both cases. Similarly if  $D = \mathbb{C} \setminus [0, \infty)$ , then one branch is  $\sqrt{r}e^{i\theta/2}$ , the other branch is  $-\sqrt{r}e^{i\theta/2}$ , with  $0 < \theta < 2\pi$  in both cases.

A *cut domain* is one from which the points on finitely many nonintersecting simple contours (§1.9(iii)) have been removed. Each contour is called a *cut*. A *cut neighborhood* is formed by deleting a ray emanating from the center. (Or more generally, a simple contour that starts at the center and terminates on the boundary.)

Suppose  $F(z)$  is multivalued and  $a$  is a point such that there exists a branch of  $F(z)$  in a cut neighborhood of  $a$ , but there does not exist a branch of  $F(z)$  in any punctured neighborhood of  $a$ . Then  $a$  is a *branch point* of  $F(z)$ . For example,  $z = 0$  is a branch point of  $\sqrt{z}$ .

Branches can be constructed in two ways:

(a) By introducing appropriate cuts from the branch points and restricting  $F(z)$  to be single-valued in the cut plane (or domain).

(b) By specifying the value of  $F(z)$  at a point  $z_0$  (not a branch point), and requiring  $F(z)$  to be continuous on any path that begins at  $z_0$  and does not pass through any branch points or other singularities of  $F(z)$ .

If the path circles a branch point at  $z = a$   $k$  times in the positive sense, and returns to  $z_0$  without encircling any other branch point, then its value is denoted conventionally as  $F((z_0 - a)e^{2k\pi i} + a)$ .

**Example**

Let  $\alpha$  and  $\beta$  be real or complex numbers that are not integers. The function  $F(z) = (1 - z)^\alpha(1 + z)^\beta$  is many-valued with branch points at  $\pm 1$ . Branches of  $F(z)$  can be defined, for example, in the cut plane  $D$  obtained from  $\mathbb{C}$  by removing the real axis from 1 to  $\infty$  and from  $-1$  to  $-\infty$ ; see Figure 1.10.1. One such branch is obtained by assigning  $(1 - z)^\alpha$  and  $(1 + z)^\beta$  their principal values (§4.2(iv)).

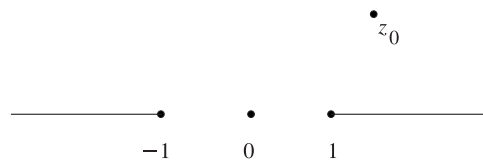


Figure 1.10.1: Domain  $D$ .

Alternatively, take  $z_0$  to be any point in  $D$  and set  $F(z_0) = e^{\alpha \ln(1-z_0)} e^{\beta \ln(1+z_0)}$  where the logarithms assume their principal values. (Thus if  $z_0$  is in the interval  $(-1, 1)$ , then the logarithms are real.) Then the value of  $F(z)$  at any other point is obtained by analytic continuation.

Thus if  $F(z)$  is continued along a path that circles  $z = 1$   $m$  times in the positive sense and returns to  $z_0$  without circling  $z = -1$ , then  $F((z_0 - 1)e^{2m\pi i} + 1) = e^{\alpha \ln(1-z_0)} e^{\beta \ln(1+z_0)} e^{2\pi i m \alpha}$ . If the path also circles  $z = -1$   $n$  times in the clockwise or negative sense before returning to  $z_0$ , then the value of  $F(z_0)$  becomes  $e^{\alpha \ln(1-z_0)} e^{\beta \ln(1+z_0)} e^{2\pi i m \alpha} e^{-2\pi i n \beta}$ .

### 1.10(vii) Inverse Functions

#### Lagrange Inversion Theorem

Suppose  $f(z)$  is analytic at  $z = z_0$ ,  $f'(z_0) \neq 0$ , and  $f(z_0) = w_0$ . Then the equation

$$1.10.12 \quad f(z) = w$$

has a unique solution  $z = F(w)$  analytic at  $w = w_0$ , and

$$1.10.13 \quad F(w) = z_0 + \sum_{n=1}^{\infty} F_n(w - w_0)^n$$

in a neighborhood of  $w_0$ , where  $nF_n$  is the residue of  $1/(f(z) - f(z_0))^n$  at  $z = z_0$ . (In other words  $nF_n$  is the coefficient of  $(z - z_0)^{-1}$  in the Laurent expansion of  $1/(f(z) - f(z_0))^n$  in powers of  $(z - z_0)$ ; compare §1.10(iii).)

Furthermore, if  $g(z)$  is analytic at  $z_0$ , then

$$1.10.14 \quad g(F(w)) = g(z_0) + \sum_{n=1}^{\infty} G_n(w - w_0)^n,$$

where  $nG_n$  is the residue of  $g'(z)/(f(z) - f(z_0))^n$  at  $z = z_0$ .

#### Extended Inversion Theorem

Suppose that

$$1.10.15 \quad f(z) = f(z_0) + \sum_{n=0}^{\infty} f_n(z - z_0)^{\mu+n},$$

where  $\mu > 0$ ,  $f_0 \neq 0$ , and the series converges in a neighborhood of  $z_0$ . (For example, when  $\mu$  is an integer  $f(z) - f(z_0)$  has a zero of order  $\mu$  at  $z_0$ .) Let  $w_0 = f(z_0)$ . Then (1.10.12) has a solution  $z = F(w)$ , where

$$1.10.16 \quad F(w) = z_0 + \sum_{n=1}^{\infty} F_n(w - w_0)^{n/\mu},$$

in a neighborhood of  $w_0$ ,  $nF_n$  being the residue of  $1/(f(z) - f(z_0))^{n/\mu}$  at  $z = z_0$ .

It should be noted that different branches of  $(w - w_0)^{1/\mu}$  used in forming  $(w - w_0)^{n/\mu}$  in (1.10.16) give rise to different solutions of (1.10.12). Also, if in addition  $g(z)$  is analytic at  $z_0$ , then

$$1.10.17 \quad g(F(w)) = g(z_0) + \sum_{n=1}^{\infty} G_n(w - w_0)^{n/\mu},$$

where  $nG_n$  is the residue of  $g'(z)/(f(z) - f(z_0))^{n/\mu}$  at  $z = z_0$ .

### 1.10(viii) Functions Defined by Contour Integrals

Let  $D$  be a domain and  $[a, b]$  be a closed finite segment of the real axis. Assume that for each  $t \in [a, b]$ ,  $f(z, t)$  is an analytic function of  $z$  in  $D$ , and also that  $f(z, t)$  is a continuous function of both variables. Then

$$1.10.18 \quad F(z) = \int_a^b f(z, t) dt$$

is analytic in  $D$  and its derivatives of all orders can be found by differentiating under the sign of integration.

This result is also true when  $b = \infty$ , or when  $f(z, t)$  has a singularity at  $t = b$ , with the following conditions. For each  $t \in [a, b)$ ,  $f(z, t)$  is analytic in  $D$ ;  $f(z, t)$  is a continuous function of both variables when  $z \in D$  and  $t \in [a, b)$ ; the integral (1.10.18) converges at  $b$ , and this convergence is uniform with respect to  $z$  in every compact subset  $S$  of  $D$ .

The last condition means that given  $\epsilon (> 0)$  there exists a number  $a_0 \in [a, b)$  that is independent of  $z$  and is such that

$$1.10.19 \quad \left| \int_{a_1}^b f(z, t) dt \right| < \epsilon,$$

for all  $a_1 \in [a_0, b)$  and all  $z \in S$ ; compare §1.5(iv).

#### M-test

If  $|f(z, t)| \leq M(t)$  for  $z \in S$  and  $\int_a^b M(t) dt$  converges, then the integral (1.10.18) converges uniformly and absolutely in  $S$ .

### 1.10(ix) Infinite Products

Let  $p_{k,m} = \prod_{n=k}^m (1 + a_n)$ . If for some  $k \geq 1$ ,  $p_{k,m} \rightarrow p_k \neq 0$  as  $m \rightarrow \infty$ , then we say that the infinite product  $\prod_{n=1}^{\infty} (1 + a_n)$  converges. (The integer  $k$  may be greater than one to allow for a finite number of zero factors.) The convergence of the product is *absolute* if  $\prod_{n=1}^{\infty} (1 + |a_n|)$  converges. The product  $\prod_{n=1}^{\infty} (1 + a_n)$ , with  $a_n \neq -1$  for all  $n$ , converges iff  $\sum_{n=1}^{\infty} \ln(1 + a_n)$  converges; and it converges absolutely iff  $\sum_{n=1}^{\infty} |a_n|$  converges.

Suppose  $a_n = a_n(z)$ ,  $z \in D$ , a domain. The convergence of the infinite product is *uniform* if the sequence of partial products converges uniformly.

#### M-test

Suppose that  $a_n(z)$  are analytic functions in  $D$ . If there is an  $N$ , independent of  $z \in D$ , such that

$$1.10.20 \quad |\ln(1 + a_n(z))| \leq M_n, \quad n \geq N,$$

and

$$1.10.21 \quad \sum_{n=1}^{\infty} M_n < \infty,$$

then the product  $\prod_{n=1}^{\infty} (1 + a_n(z))$  converges uniformly to an analytic function  $p(z)$  in  $D$ , and  $p(z) = 0$  only

when at least one of the factors  $1 + a_n(z)$  is zero in  $D$ . This conclusion remains true if, in place of (1.10.20),  $|a_n(z)| \leq M_n$  for all  $n$ , and again  $\sum_{n=1}^{\infty} M_n < \infty$ .

### Weierstrass Product

If  $\{z_n\}$  is a sequence such that  $\sum_{n=1}^{\infty} |z_n^{-2}|$  is convergent, then

$$1.10.22 \quad P(z) = \prod_{n=1}^{\infty} \left(1 - \frac{z}{z_n}\right) e^{z/z_n}$$

is an entire function with zeros at  $z_n$ .

### 1.10(x) Infinite Partial Fractions

Suppose  $D$  is a domain, and

$$1.10.23 \quad F(z) = \prod_{n=1}^{\infty} a_n(z), \quad z \in D,$$

where  $a_n(z)$  is analytic for all  $n \geq 1$ , and the convergence of the product is uniform in any compact subset of  $D$ . Then  $F(z)$  is analytic in  $D$ .

If, also,  $a_n(z) \neq 0$  when  $n \geq 1$  and  $z \in D$ , then  $F(z) \neq 0$  on  $D$  and

$$1.10.24 \quad \frac{F'(z)}{F(z)} = \sum_{n=1}^{\infty} \frac{a'_n(z)}{a_n(z)}.$$

### Mittag-Leffler's Expansion

If  $\{a_n\}$  and  $\{z_n\}$  are sequences such that  $z_m \neq z_n$  ( $m \neq n$ ) and  $\sum_{n=1}^{\infty} |a_n z_n^{-2}|$  is convergent, then

$$1.10.25 \quad f(z) = \sum_{n=1}^{\infty} a_n \left( \frac{1}{z - z_n} + \frac{1}{z_n} \right)$$

is analytic in  $\mathbb{C}$ , except for simple poles at  $z = z_n$  of residue  $a_n$ .

## 1.11 Zeros of Polynomials

### 1.11(i) Division Algorithm

#### Horner's Scheme

Let

$$1.11.1 \quad f(z) = a_n z^n + a_{n-1} z^{n-1} + \cdots + a_0.$$

Then

$$1.11.2 \quad f(z) = (z - \alpha)(b_n z^{n-1} + b_{n-1} z^{n-2} + \cdots + b_1) + b_0,$$

where  $b_n = a_n$ ,

$$1.11.3 \quad b_k = \alpha b_{k+1} + a_k, \quad k = n-1, n-2, \dots, 0,$$

$$1.11.4 \quad f(\alpha) = b_0.$$

### Extended Horner Scheme

With  $b_k$  as in (1.11.1)–(1.11.3) let  $c_n = a_n$  and

$$1.11.5 \quad c_k = \alpha c_{k+1} + b_k, \quad k = n-1, n-2, \dots, 1.$$

Then

$$1.11.6 \quad f'(\alpha) = c_1.$$

More generally, for polynomials  $f(z)$  and  $g(z)$ , there are polynomials  $q(z)$  and  $r(z)$ , found by equating coefficients, such that

$$1.11.7 \quad f(z) = g(z)q(z) + r(z),$$

where  $0 \leq \deg r(z) < \deg g(z)$ .

### 1.11(ii) Elementary Properties

A polynomial of degree  $n$  with real or complex coefficients has exactly  $n$  real or complex zeros counting multiplicity. Every *monic* (coefficient of highest power is one) polynomial of odd degree with real coefficients has at least one real zero with sign opposite to that of the constant term. A monic polynomial of even degree with real coefficients has at least two zeros of opposite signs when the constant term is negative.

#### Descartes' Rule of Signs

The number of positive zeros of a polynomial with real coefficients cannot exceed the number of times the coefficients change sign, and the two numbers have same parity. A similar relation holds for the changes in sign of the coefficients of  $f(-z)$ , and hence for the number of negative zeros of  $f(z)$ .

#### Example

$$1.11.8 \quad \begin{aligned} f(z) &= z^8 + 10z^3 + z - 4, \\ f(-z) &= z^8 - 10z^3 - z - 4. \end{aligned}$$

Both polynomials have one change of sign; hence for each polynomial there is one positive zero, one negative zero, and six complex zeros.

Next, let  $f(z) = a_n z^n + a_{n-1} z^{n-1} + \cdots + a_0$ . The zeros of  $z^n f(1/z) = a_0 z^n + a_1 z^{n-1} + \cdots + a_n$  are reciprocals of the zeros of  $f(z)$ .

The *discriminant* of  $f(z)$  is defined by

$$1.11.9 \quad D = a_n^{2n-2} \prod_{j < k} (z_j - z_k)^2,$$

where  $z_1, z_2, \dots, z_n$  are the zeros of  $f(z)$ . The *elementary symmetric functions* of the zeros are (with  $a_n \neq 0$ )

$$1.11.10 \quad \begin{aligned} z_1 + z_2 + \cdots + z_n &= -a_{n-1}/a_n, \\ \sum_{1 \leq j < k \leq n} z_j z_k &= a_{n-2}/a_n, \\ &\vdots \\ z_1 z_2 \cdots z_n &= (-1)^n a_0/a_n. \end{aligned}$$

### 1.11(iii) Polynomials of Degrees Two, Three, and Four

#### Quadratic Equations

The roots of  $az^2 + bz + c = 0$  are

$$1.11.11 \quad \frac{-b \pm \sqrt{D}}{2a}, \quad D = b^2 - 4ac.$$

The sum and product of the roots are respectively  $-b/a$  and  $c/a$ .

#### Cubic Equations

Set  $z = w - \frac{1}{3}a$  to reduce  $f(z) = z^3 + az^2 + bz + c$  to  $g(w) = w^3 + pw + q$ , with  $p = (3b - a^2)/3$ ,  $q = (2a^3 - 9ab + 27c)/27$ . The discriminant of  $g(w)$  is

$$1.11.12 \quad D = -4p^3 - 27q^2.$$

Let

$$1.11.13 \quad A = \sqrt[3]{-\frac{27}{2}q + \frac{3}{2}\sqrt{-3D}}, \quad B = -3p/A.$$

The roots of  $g(w) = 0$  are

$$1.11.14 \quad \frac{1}{3}(A + B), \quad \frac{1}{3}(\rho A + \rho^2 B), \quad \frac{1}{3}(\rho^2 A + \rho B),$$

with

$$1.11.15 \quad \rho = -\frac{1}{2} + \frac{1}{2}\sqrt{-3} = e^{2\pi i/3}, \quad \rho^2 = e^{-2\pi i/3}.$$

Addition of  $-\frac{1}{3}a$  to each of these roots gives the roots of  $f(z) = 0$ .

#### Example

$f(z) = z^3 - 6z^2 + 6z - 2$ ,  $g(w) = w^3 - 6w - 6$ ,  $A = 3\sqrt[3]{4}$ ,  $B = 3\sqrt[3]{2}$ . Roots of  $f(z) = 0$  are  $2 + \sqrt[3]{4} + \sqrt[3]{2}$ ,  $2 + \sqrt[3]{4}\rho + \sqrt[3]{2}\rho^2$ ,  $2 + \sqrt[3]{4}\rho^2 + \sqrt[3]{2}\rho$ .

For another method see §4.43.

#### Quartic Equations

Set  $z = w - \frac{1}{4}a$  to reduce  $f(z) = z^4 + az^3 + bz^2 + cz + d$  to

$$g(w) = w^4 + pw^2 + qw + r,$$

$$1.11.16 \quad p = (-3a^2 + 8b)/8, \quad q = (a^3 - 4ab + 8c)/8, \\ r = (-3a^4 + 16a^2b - 64ac + 256d)/256.$$

The discriminant of  $g(w)$  is

$$1.11.17 \quad D = 16p^4r - 4p^3q^2 - 128p^2r^2 + 144pq^2r - 27q^4 + 256r^3.$$

For the roots  $\alpha_1, \alpha_2, \alpha_3, \alpha_4$  of  $g(w) = 0$  and the roots  $\theta_1, \theta_2, \theta_3$  of the *resolvent cubic equation*

$$1.11.18 \quad z^3 - 2pz^2 + (p^2 - 4r)z + q^2 = 0,$$

we have

$$1.11.19 \quad \begin{aligned} 2\alpha_1 &= \sqrt{-\theta_1} + \sqrt{-\theta_2} + \sqrt{-\theta_3}, \\ 2\alpha_2 &= \sqrt{-\theta_1} - \sqrt{-\theta_2} - \sqrt{-\theta_3}, \\ 2\alpha_3 &= -\sqrt{-\theta_1} + \sqrt{-\theta_2} - \sqrt{-\theta_3}, \\ 2\alpha_4 &= -\sqrt{-\theta_1} - \sqrt{-\theta_2} + \sqrt{-\theta_3}. \end{aligned}$$

The square roots are chosen so that

$$1.11.20 \quad \sqrt{-\theta_1} \sqrt{-\theta_2} \sqrt{-\theta_3} = -q.$$

Add  $-\frac{1}{4}a$  to the roots of  $g(w) = 0$  to get those of  $f(z) = 0$ .

#### Example

$f(z) = z^4 - 4z^3 + 5z + 2$ ,  $g(w) = w^4 - 6w^2 - 3w + 4$ . Resolvent cubic is  $z^3 + 12z^2 + 20z + 9 = 0$  with roots  $\theta_1 = -1$ ,  $\theta_2 = -\frac{1}{2}(11 + \sqrt{85})$ ,  $\theta_3 = -\frac{1}{2}(11 - \sqrt{85})$ , and  $\sqrt{-\theta_1} = 1$ ,  $\sqrt{-\theta_2} = \frac{1}{2}(\sqrt{17} + \sqrt{5})$ ,  $\sqrt{-\theta_3} = \frac{1}{2}(\sqrt{17} - \sqrt{5})$ . So  $2\alpha_1 = 1 + \sqrt{17}$ ,  $2\alpha_2 = 1 - \sqrt{17}$ ,  $2\alpha_3 = -1 + \sqrt{5}$ ,  $2\alpha_4 = -1 - \sqrt{5}$ , and the roots of  $f(z) = 0$  are  $\frac{1}{2}(3 \pm \sqrt{17})$ ,  $\frac{1}{2}(1 \pm \sqrt{5})$ .

### 1.11(iv) Roots of Unity and of Other Constants

The roots of

$$1.11.21 \quad z^n - 1 = (z - 1)(z^{n-1} + z^{n-2} + \cdots + z + 1) = 0$$

are  $1, e^{2\pi i/n}, e^{4\pi i/n}, \dots, e^{(2n-2)\pi i/n}$ , and of  $z^n + 1 = 0$  they are  $e^{\pi i/n}, e^{3\pi i/n}, \dots, e^{(2n-1)\pi i/n}$ .

The roots of

$$1.11.22 \quad z^n = a + ib, \quad a, b \text{ real,}$$

are

$$1.11.23 \quad \sqrt[n]{R} \left( \cos\left(\frac{\alpha + 2k\pi}{n}\right) + i \sin\left(\frac{\alpha + 2k\pi}{n}\right) \right),$$

where  $R = (a^2 + b^2)^{1/2}$ ,  $\alpha = \text{ph}(a + ib)$ , with the principal value of phase (§1.9(i)), and  $k = 0, 1, \dots, n - 1$ .

### 1.11(v) Stable Polynomials

$$1.11.24 \quad f(z) = a_0 + a_1z + \cdots + a_nz^n,$$

with real coefficients, is called *stable* if the real parts of all the zeros are strictly negative.

#### Hurwitz Criterion

Let

1.11.25

$$D_1 = a_1, \quad D_2 = \begin{vmatrix} a_1 & a_3 \\ a_0 & a_2 \end{vmatrix}, \quad D_3 = \begin{vmatrix} a_1 & a_3 & a_5 \\ a_0 & a_2 & a_4 \\ 0 & a_1 & a_3 \end{vmatrix},$$

and

$$1.11.26 \quad D_k = \det[h_k^{(1)}, h_k^{(3)}, \dots, h_k^{(2k-1)}],$$

where the column vector  $h_k^{(m)}$  consists of the first  $k$  members of the sequence  $a_m, a_{m-1}, a_{m-2}, \dots$  with  $a_j = 0$  if  $j < 0$  or  $j > n$ .

Then  $f(z)$ , with  $a_n \neq 0$ , is stable iff  $a_0 \neq 0$ ;  $D_{2k} > 0$ ,  $k = 1, \dots, \lfloor \frac{1}{2}n \rfloor$ ;  $\text{sign } D_{2k+1} = \text{sign } a_0$ ,  $k = 0, 1, \dots, \lfloor \frac{1}{2}n - \frac{1}{2} \rfloor$ .



## 1.12 Continued Fractions

### 1.12(i) Notation

The notation used throughout this Handbook for the continued fraction

$$1.12.1 \quad b_0 + \frac{a_1}{b_1 + \frac{a_2}{b_2 + \dots}}$$

is

$$1.12.2 \quad b_0 + \frac{a_1}{b_1 +} \frac{a_2}{b_2 +} \dots$$

### 1.12(ii) Convergents

$$1.12.3 \quad C = b_0 + \frac{a_1}{b_1 +} \frac{a_2}{b_2 +} \dots, \quad a_n \neq 0,$$

$$1.12.4 \quad C_n = b_0 + \frac{a_1}{b_1 +} \frac{a_2}{b_2 +} \dots \frac{a_n}{b_n} = \frac{A_n}{B_n}.$$

$C_n$  is called the  $n$ th approximant or convergent to  $C$ .  $A_n$  and  $B_n$  are called the  $n$ th (canonical) numerator and denominator respectively.

#### Recurrence Relations

$$1.12.5 \quad A_k = b_k A_{k-1} + a_k A_{k-2}, \quad B_k = b_k B_{k-1} + a_k B_{k-2}, \\ k = 1, 2, 3, \dots,$$

$$1.12.6 \quad A_{-1} = 1, \quad A_0 = b_0, \quad B_{-1} = 0, \quad B_0 = 1.$$

Formally,

$$1.12.17 \quad b_0 + \frac{a_1}{b_1 +} \frac{a_2}{b_2 +} \frac{a_3}{b_3 +} \dots = b_0 + \frac{a_1/b_1}{1 +} \frac{a_2/(b_1 b_2)}{1 +} \frac{a_3/(b_2 b_3)}{1 +} \dots \frac{a_n/(b_{n-1} b_n)}{1 +} \dots \\ = b_0 + \frac{1}{(1/a_1)b_1 +} \frac{1}{(a_1/a_2)b_2 +} \frac{1}{(a_2/(a_1 a_3))b_3 +} \frac{1}{(a_1 a_3/(a_2 a_4))b_4 +} \dots$$

#### Series

$$1.12.18 \quad p_0 + \sum_{k=1}^n p_1 p_2 \dots p_k = p_0 + \frac{p_1}{1 -} \frac{p_2}{1 + p_2 -} \frac{p_3}{1 + p_3 -} \dots \frac{p_n}{1 + p_n}, \quad n = 0, 1, 2, \dots,$$

when  $p_k \neq 0$ ,  $k = 1, 2, 3, \dots$

$$1.12.19 \quad \sum_{k=0}^n c_k x^k = c_0 + \frac{c_1 x}{1 -} \frac{(c_2/c_1)x}{1 + (c_2/c_1)x -} \frac{(c_3/c_2)x}{1 + (c_3/c_2)x -} \dots \frac{(c_n/c_{n-1})x}{1 + (c_n/c_{n-1})x}, \quad n = 0, 1, 2, \dots,$$

when  $c_k \neq 0$ ,  $k = 1, 2, 3, \dots$

#### Determinant Formula

##### 1.12.7

$$A_n B_{n-1} - B_n A_{n-1} = (-1)^{n-1} \prod_{k=1}^n a_k, \quad n = 0, 1, 2, \dots$$

$$1.12.8 \quad C_n - C_{n-1} = \frac{(-1)^{n-1} \prod_{k=1}^n a_k}{B_{n-1} B_n}, \quad n = 1, 2, 3, \dots,$$

$$1.12.9 \quad C_n = b_0 + \frac{a_1}{B_0 B_1} - \dots + (-1)^{n-1} \frac{\prod_{k=1}^n a_k}{B_{n-1} B_n}.$$

$$1.12.10 \quad a_n = \frac{A_{n-1} B_n - A_n B_{n-1}}{A_{n-1} B_{n-2} - A_{n-2} B_{n-1}}, \quad n = 1, 2, 3, \dots,$$

$$1.12.11 \quad a_n = \frac{B_n}{B_{n-2}} \frac{C_{n-1} - C_n}{C_{n-1} - C_{n-2}}, \quad n = 2, 3, 4, \dots,$$

$$1.12.12 \quad b_n = \frac{A_n B_{n-2} - A_{n-2} B_n}{A_{n-1} B_{n-2} - A_{n-2} B_{n-1}}, \quad n = 1, 2, 3, \dots,$$

$$1.12.13 \quad b_n = \frac{B_n}{B_{n-1}} \frac{C_n - C_{n-2}}{C_{n-1} - C_{n-2}}, \quad n = 2, 3, 4, \dots,$$

$$1.12.14 \quad b_0 = A_0 = C_0, \quad b_1 = B_1, \quad a_1 = A_1 - A_0 B_1.$$

#### Equivalence

Two continued fractions are *equivalent* if they have the same convergents.

$b_0 + \frac{a_1}{b_1 +} \frac{a_2}{b_2 +} \dots$  is equivalent to  $b'_0 + \frac{a'_1}{b'_1 +} \frac{a'_2}{b'_2 +} \dots$  if there is a sequence  $\{d_n\}_{n=0}^{\infty}$ ,  $d_0 = 1$ ,  $d_n \neq 0$ , such that

$$1.12.15 \quad a'_n = d_n d_{n-1} a_n, \quad n = 1, 2, 3, \dots, \\ \text{and}$$

$$1.12.16 \quad b'_n = d_n b_n, \quad n = 0, 1, 2, \dots$$

**Fractional Transformations**

Define

1.12.20 
$$C_n(w) = b_0 + \frac{a_1}{b_1 +} \frac{a_2}{b_2 +} \cdots \frac{a_n}{b_n + w}.$$

Then

1.12.21 
$$C_n(w) = \frac{A_n + A_{n-1}w}{B_n + B_{n-1}w}, \quad C_n(0) = C_n, \quad C_n(\infty) = C_{n-1} = \frac{A_{n-1}}{B_{n-1}}.$$

**1.12(iii) Existence of Convergents**

A sequence  $\{C_n\}$  in the extended complex plane,  $\mathbb{C} \cup \{\infty\}$ , can be a sequence of convergents of the continued fraction (1.12.3) iff

1.12.22 
$$C_0 \neq \infty, \quad C_n \neq C_{n-1}, \quad n = 1, 2, 3, \dots$$

**1.12(iv) Contraction and Extension**

A *contraction* of a continued fraction  $C$  is a continued fraction  $C'$  whose convergents  $\{C'_n\}$  form a subsequence of the convergents  $\{C_n\}$  of  $C$ . Conversely,  $C$  is called an *extension* of  $C'$ . If  $C'_n = C_{2n}$ ,  $n = 0, 1, 2, \dots$ , then  $C'$  is called the *even part* of  $C$ . The even part of  $C$  exists iff  $b_{2k} \neq 0$ ,  $k = 1, 2, \dots$ , and up to equivalence is given by

1.12.23 
$$b_0 + \frac{a_1 b_2}{a_2 + b_1 b_2 -} \frac{a_2 a_3 b_4}{a_3 b_4 + b_2(a_4 + b_3 b_4) -} \frac{a_4 a_5 b_2 b_6}{a_5 b_6 + b_4(a_6 + b_5 b_6) -} \frac{a_6 a_7 b_4 b_8}{a_7 b_8 + b_6(a_8 + b_7 b_8) -} \cdots$$

If  $C'_n = C_{2n+1}$ ,  $n = 0, 1, 2, \dots$ , then  $C'$  is called the *odd part* of  $C$ . The odd part of  $C$  exists iff  $b_{2k+1} \neq 0$ ,  $k = 0, 1, 2, \dots$ , and up to equivalence is given by

1.12.24 
$$\frac{a_1 + b_0 b_1}{b_1} - \frac{a_1 a_2 b_3 / b_1}{a_2 b_3 + b_1(a_3 + b_2 b_3) -} \frac{a_3 a_4 b_1 b_5}{a_4 b_5 + b_3(a_5 + b_4 b_5) -} \frac{a_5 a_6 b_3 b_7}{a_6 b_7 + b_5(a_7 + b_6 b_7) -} \cdots$$

**1.12(v) Convergence**

A continued fraction *converges* if the convergents  $C_n$  tend to a finite limit as  $n \rightarrow \infty$ .

**Pringsheim's Theorem**

The continued fraction  $\frac{a_1}{b_1 +} \frac{a_2}{b_2 +} \cdots$  converges when

1.12.25 
$$|b_n| \geq |a_n| + 1, \quad n = 1, 2, 3, \dots$$

With these conditions the convergents  $C_n$  satisfy  $|C_n| < 1$  and  $C_n \rightarrow C$  with  $|C| \leq 1$ .

**Van Vleck's Theorem**

Let the elements of the continued fraction  $\frac{1}{b_1 +} \frac{1}{b_2 +} \cdots$  satisfy

1.12.26 
$$-\frac{1}{2}\pi + \delta < \text{ph } b_n < \frac{1}{2}\pi - \delta, \quad n = 1, 2, 3, \dots,$$

where  $\delta$  is an arbitrary small positive constant. Then the convergents  $C_n$  satisfy

1.12.27 
$$-\frac{1}{2}\pi + \delta < \text{ph } C_n < \frac{1}{2}\pi - \delta, \quad n = 1, 2, 3, \dots,$$

and the even and odd parts of the continued fraction converge to finite values. The continued fraction converges iff, in addition,

1.12.28 
$$\sum_{n=1}^{\infty} |b_n| = \infty.$$

In this case  $|\text{ph } C| \leq \frac{1}{2}\pi$ .

**1.12(vi) Applications**

For analytical and numerical applications of continued fractions to special functions see §3.10.

**1.13 Differential Equations**

**1.13(i) Existence of Solutions**

A domain in the complex plane is *simply-connected* if it has no "holes"; more precisely, if its complement in the extended plane  $\mathbb{C} \cup \{\infty\}$  is connected.

The equation

1.13.1 
$$\frac{d^2 w}{dz^2} + f(z) \frac{dw}{dz} + g(z)w = 0,$$

where  $z \in D$ , a simply-connected domain, and  $f(z)$ ,  $g(z)$  are analytic in  $D$ , has an infinite number of analytic solutions in  $D$ . A solution becomes unique, for example, when  $w$  and  $dw/dz$  are prescribed at a point in  $D$ .

**Fundamental Pair**

Two solutions  $w_1(z)$  and  $w_2(z)$  are called a *fundamental pair* if any other solution  $w(z)$  is expressible as

$$1.13.2 \quad w(z) = Aw_1(z) + Bw_2(z),$$

where  $A$  and  $B$  are constants. A fundamental pair can be obtained, for example, by taking any  $z_0 \in D$  and requiring that

$$1.13.3 \quad w_1(z_0) = 1, \quad w_1'(z_0) = 0, \quad w_2(z_0) = 0, \quad w_2'(z_0) = 1.$$

**Wronskian**

The *Wronskian* of  $w_1(z)$  and  $w_2(z)$  is defined by

$$1.13.4 \quad \mathscr{W}\{w_1(z), w_2(z)\} = w_1(z)w_2'(z) - w_2(z)w_1'(z).$$

Then

$$1.13.5 \quad \mathscr{W}\{w_1(z), w_2(z)\} = ce^{-\int f(z) dz},$$

where  $c$  is independent of  $z$ . If  $f(z) = 0$ , then the Wronskian is constant.

The following three statements are equivalent:  $w_1(z)$  and  $w_2(z)$  comprise a fundamental pair in  $D$ ;  $\mathscr{W}\{w_1(z), w_2(z)\}$  does not vanish in  $D$ ;  $w_1(z)$  and  $w_2(z)$  are *linearly independent*, that is, the only constants  $A$  and  $B$  such that

$$1.13.6 \quad Aw_1(z) + Bw_2(z) = 0, \quad \forall z \in D, \\ \text{are } A = B = 0.$$

**1.13(ii) Equations with a Parameter**

Assume that in the equation

$$1.13.7 \quad \frac{d^2w}{dz^2} + f(u, z)\frac{dw}{dz} + g(u, z)w = 0,$$

$u$  and  $z$  belong to domains  $U$  and  $D$  respectively, the coefficients  $f(u, z)$  and  $g(u, z)$  are continuous functions of both variables, and for each fixed  $u$  (fixed  $z$ ) the two functions are analytic in  $z$  (in  $u$ ). Suppose also that at (a fixed)  $z_0 \in D$ ,  $w$  and  $\partial w/\partial z$  are analytic functions of  $u$ . Then at each  $z \in D$ ,  $w$ ,  $\partial w/\partial z$  and  $\partial^2 w/\partial z^2$  are analytic functions of  $u$ .

**1.13(iii) Inhomogeneous Equations**

The *inhomogeneous* (or *nonhomogeneous*) equation

$$1.13.8 \quad \frac{d^2w}{dz^2} + f(z)\frac{dw}{dz} + g(z)w = r(z)$$

with  $f(z)$ ,  $g(z)$ , and  $r(z)$  analytic in  $D$  has infinitely many analytic solutions in  $D$ . If  $w_0(z)$  is any one solution, and  $w_1(z)$ ,  $w_2(z)$  are a fundamental pair of solutions of the corresponding homogeneous equation (1.13.1), then every solution of (1.13.8) can be expressed as

$$1.13.9 \quad w(z) = w_0(z) + Aw_1(z) + Bw_2(z),$$

where  $A$  and  $B$  are constants.

**Variation of Parameters**

With the notation of (1.13.8) and (1.13.9)

$$1.13.10 \quad w_0(z) = w_2(z) \int \frac{w_1(z)r(z)}{\mathscr{W}\{w_1(z), w_2(z)\}} dz \\ - w_1(z) \int \frac{w_2(z)r(z)}{\mathscr{W}\{w_1(z), w_2(z)\}} dz.$$

**1.13(iv) Change of Variables****Transformation of the Point at Infinity**

The substitution  $\xi = 1/z$  in (1.13.1) gives

$$1.13.11 \quad \frac{d^2W}{d\xi^2} + F(\xi)\frac{dW}{d\xi} + G(\xi)W = 0,$$

where

$$1.13.12 \quad W(\xi) = w\left(\frac{1}{\xi}\right), \\ F(\xi) = \frac{2}{\xi} - \frac{1}{\xi^2}f\left(\frac{1}{\xi}\right), \\ G(\xi) = \frac{1}{\xi^4}g\left(\frac{1}{\xi}\right).$$

**Elimination of First Derivative by Change of Dependent Variable**

The substitution

$$1.13.13 \quad w(z) = W(z) \exp\left(-\frac{1}{2} \int f(z) dz\right)$$

in (1.13.1) gives

$$1.13.14 \quad \frac{d^2W}{dz^2} - H(z)W = 0,$$

where

$$1.13.15 \quad H(z) = \frac{1}{4}f^2(z) + \frac{1}{2}f'(z) - g(z).$$

**Elimination of First Derivative by Change of Independent Variable**

In (1.13.1) substitute

$$1.13.16 \quad \eta = \int \exp\left(-\int f(z) dz\right) dz.$$

Then

$$1.13.17 \quad \frac{d^2w}{d\eta^2} + g(z) \exp\left(2 \int f(z) dz\right) w = 0.$$

**Liouville Transformation**

Let  $W(z)$  satisfy (1.13.14),  $\zeta(z)$  be any thrice-differentiable function of  $z$ , and

$$1.13.18 \quad U(z) = (\zeta'(z))^{1/2}W(z).$$

Then

$$1.13.19 \quad \frac{d^2U}{d\zeta^2} = \left(\zeta^2 H(z) - \frac{1}{2}\{z, \zeta\}\right) U.$$

Here dots denote differentiations with respect to  $\zeta$ , and  $\{z, \zeta\}$  is the *Schwarzian derivative*:

$$1.13.20 \quad \{z, \zeta\} = -2\dot{z}^{1/2} \frac{d^2}{d\zeta^2} (\dot{z}^{-1/2}) = \frac{\ddot{z}}{\dot{z}} - \frac{3}{2} \left( \frac{\ddot{z}}{\dot{z}} \right)^2.$$

#### Cayley's Identity

For arbitrary  $\xi$  and  $\zeta$ ,

$$1.13.21 \quad \{z, \zeta\} = (d\xi/d\zeta)^2 \{z, \xi\} + \{\xi, \zeta\}.$$

$$1.13.22 \quad \{z, \zeta\} = -(dz/d\zeta)^2 \{\zeta, z\}.$$

### 1.13(v) Products of Solutions

The product of any two solutions of (1.13.1) satisfies

#### 1.13.23

$$\frac{d^3 w}{dz^3} + 3f \frac{d^2 w}{dz^2} + (2f^2 + f' + 4g) \frac{dw}{dz} + (4fg + 2g')w = 0.$$

If  $U(z)$  and  $V(z)$  are respectively solutions of

$$1.13.24 \quad \frac{d^2 U}{dz^2} + IU = 0, \quad \frac{d^2 V}{dz^2} + JV = 0,$$

then  $W = UV$  is a solution of

#### 1.13.25

$$\frac{d}{dz} \left( \frac{W''' + 2(I+J)W' + (I' + J')W}{I - J} \right) = -(I - J)W.$$

### 1.13(vi) Singularities

For classification of singularities of (1.13.1) and expansions of solutions in the neighborhoods of singularities, see §2.7.

### 1.13(vii) Closed-Form Solutions

For an extensive collection of solutions of differential equations of the first, second, and higher orders see Kamke (1977).

## 1.14 Integral Transforms

### 1.14(i) Fourier Transform

The *Fourier transform* of a real- or complex-valued function  $f(t)$  is defined by

$$1.14.1 \quad F(x) = \frac{1}{\sqrt{2\pi}} \int_{-\infty}^{\infty} f(t) e^{ixt} dt.$$

(Some references replace  $ixt$  by  $-ixt$ .)

If  $f(t)$  is absolutely integrable on  $(-\infty, \infty)$ , then  $F(x)$  is continuous,  $F(x) \rightarrow 0$  as  $x \rightarrow \pm\infty$ , and

$$1.14.2 \quad |F(x)| \leq \frac{1}{\sqrt{2\pi}} \int_{-\infty}^{\infty} |f(t)| dt.$$

### Inversion

Suppose that  $f(t)$  is absolutely integrable on  $(-\infty, \infty)$  and of bounded variation in a neighborhood of  $t = u$  (§1.4(v)). Then

$$1.14.3 \quad \frac{1}{2}(f(u+) + f(u-)) = \frac{1}{\sqrt{2\pi}} \int_{-\infty}^{\infty} F(x) e^{-ixu} dx,$$

where the last integral denotes the Cauchy principal value (1.4.25).

In many applications  $f(t)$  is absolutely integrable and  $f'(t)$  is continuous on  $(-\infty, \infty)$ . Then

$$1.14.4 \quad f(t) = \frac{1}{\sqrt{2\pi}} \int_{-\infty}^{\infty} F(x) e^{-ixt} dx.$$

### Convolution

For Fourier transforms, the *convolution*  $(f * g)(t)$  of two functions  $f(t)$  and  $g(t)$  defined on  $(-\infty, \infty)$  is given by

$$1.14.5 \quad (f * g)(t) = \frac{1}{\sqrt{2\pi}} \int_{-\infty}^{\infty} f(t-s)g(s) ds.$$

If  $f(t)$  and  $g(t)$  are absolutely integrable on  $(-\infty, \infty)$ , then so is  $(f * g)(t)$ , and its Fourier transform is  $F(x)G(x)$ , where  $G(x)$  is the Fourier transform of  $g(t)$ .

### Parseval's Formula

Suppose  $f(t)$  and  $g(t)$  are absolutely integrable on  $(-\infty, \infty)$ , and  $F(x)$  and  $G(x)$  are their respective Fourier transforms. Then

$$1.14.6 \quad (f * g)(t) = \frac{1}{\sqrt{2\pi}} \int_{-\infty}^{\infty} F(x)G(x)e^{-itx} dx,$$

$$1.14.7 \quad \int_{-\infty}^{\infty} F(x)G(x) dx = \int_{-\infty}^{\infty} f(t)g(-t) dt,$$

$$1.14.8 \quad \int_{-\infty}^{\infty} |F(x)|^2 dx = \int_{-\infty}^{\infty} |f(t)|^2 dt.$$

(1.14.8) is *Parseval's formula*.

### Uniqueness

If  $f(t)$  and  $g(t)$  are continuous and absolutely integrable on  $(-\infty, \infty)$ , and  $F(x) = G(x)$  for all  $x$ , then  $f(t) = g(t)$  for all  $t$ .

### 1.14(ii) Fourier Cosine and Sine Transforms

These are defined respectively by

$$1.14.9 \quad F_c(x) = \sqrt{\frac{2}{\pi}} \int_0^{\infty} f(t) \cos(xt) dt,$$

$$1.14.10 \quad F_s(x) = \sqrt{\frac{2}{\pi}} \int_0^{\infty} f(t) \sin(xt) dt.$$

**Inversion**

If  $f(t)$  is absolutely integrable on  $[0, \infty)$  and of bounded variation (§1.4(v)) in a neighborhood of  $t = u$ , then

$$1.14.11 \quad \frac{1}{2}(f(u+) + f(u-)) = \sqrt{\frac{2}{\pi}} \int_0^\infty F_c(x) \cos(ux) dx,$$

$$1.14.12 \quad \frac{1}{2}(f(u+) - f(u-)) = \sqrt{\frac{2}{\pi}} \int_0^\infty F_s(x) \sin(ux) dx.$$

**Parseval's Formula**

If  $\int_0^\infty |f(t)| dt < \infty$ ,  $g(t)$  is of bounded variation on  $(0, \infty)$  and  $g(t) \rightarrow 0$  as  $t \rightarrow \infty$ , then

$$1.14.13 \quad \int_0^\infty F_c(x)G_c(x) dx = \int_0^\infty f(t)g(t) dt,$$

$$1.14.14 \quad \int_0^\infty F_s(x)G_s(x) dx = \int_0^\infty f(t)g(t) dt,$$

$$1.14.15 \quad \int_0^\infty (F_c(x))^2 dx = \int_0^\infty (f(t))^2 dt,$$

$$1.14.16 \quad \int_0^\infty (F_s(x))^2 dx = \int_0^\infty (f(t))^2 dt,$$

where  $G_c(x)$  and  $G_s(x)$  are respectively the cosine and sine transforms of  $g(t)$ .

**1.14(iii) Laplace Transform**

Suppose  $f(t)$  is a real- or complex-valued function and  $s$  is a real or complex parameter. The *Laplace transform* of  $f$  is defined by

$$1.14.17 \quad \mathcal{L}(f(t); s) = \int_0^\infty e^{-st} f(t) dt.$$

Alternative notations are  $\mathcal{L}(f(t))$ ,  $\mathcal{L}(f; s)$ , or even  $\mathcal{L}(f)$ , when it is not important to display all the variables.

**Convergence and Analyticity**

Assume that on  $[0, \infty)$   $f(t)$  is piecewise continuous and of *exponential growth*, that is, constants  $M$  and  $\alpha$  exist such that

$$1.14.18 \quad |f(t)| \leq Me^{\alpha t}, \quad 0 \leq t < \infty.$$

Then  $\mathcal{L}(f(t); s)$  is an analytic function of  $s$  for  $\Re s > \alpha$ . Moreover,

$$1.14.19 \quad \mathcal{L}(f(t); s) \rightarrow 0, \quad \Re s \rightarrow \infty.$$

Throughout the remainder of this subsection we assume (1.14.18) is satisfied and  $\Re s > \alpha$ .

**Inversion**

If  $f(t)$  is continuous and  $f'(t)$  is piecewise continuous on  $[0, \infty)$ , then

$$1.14.20 \quad f(t) = \frac{1}{2\pi i} \lim_{T \rightarrow \infty} \int_{\sigma - iT}^{\sigma + iT} e^{ts} \mathcal{L}(f(t); s) ds, \quad \sigma > \alpha.$$

Moreover, if  $\mathcal{L}(f(t); s) = O(s^{-K})$  in some half-plane  $\Re s \geq \gamma$  and  $K > 1$ , then (1.14.20) holds for  $\sigma > \gamma$ .

**Translation**

If  $\Re s > \max(\Re(a + \alpha), \alpha)$ , then

$$1.14.21 \quad \mathcal{L}(f(t); s - a) = \mathcal{L}(e^{at} f(t); s).$$

Also, if  $a \geq 0$  then

$$1.14.22 \quad \mathcal{L}(H(t - a)f(t - a); s) = e^{-as} \mathcal{L}(f(t); s),$$

where  $H$  is the Heaviside function; see (1.16.13).

**Differentiation and Integration**

If  $f(t)$  is piecewise continuous, then

$$1.14.23 \quad \frac{d^n}{ds^n} \mathcal{L}(f(t); s) = \mathcal{L}((-t)^n f(t); s), \quad n = 1, 2, 3, \dots$$

If also  $\lim_{t \rightarrow 0+} f(t)/t$  exists, then

$$1.14.24 \quad \int_s^\infty \mathcal{L}(f(t); u) du = \mathcal{L}\left(\frac{f(t)}{t}; s\right).$$

**Periodic Functions**

If  $a > 0$  and  $f(t + a) = f(t)$  for  $t > 0$ , then

$$1.14.25 \quad \mathcal{L}(f(t); s) = \frac{1}{1 - e^{-as}} \int_0^a e^{-st} f(t) dt.$$

Alternatively if  $f(t + a) = -f(t)$  for  $t > 0$ , then

$$1.14.26 \quad \mathcal{L}(f(t); s) = \frac{1}{1 + e^{-as}} \int_0^a e^{-st} f(t) dt.$$

**Derivatives**

If  $f(t)$  is continuous on  $[0, \infty)$  and  $f'(t)$  is piecewise continuous on  $(0, \infty)$ , then

$$1.14.27 \quad \mathcal{L}(f'(t); s) = s \mathcal{L}(f(t); s) - f(0+).$$

If  $f(t)$  and  $f'(t)$  are piecewise continuous on  $[0, \infty)$  with discontinuities at  $(0 =) t_0 < t_1 < \dots < t_n$ , then

$$1.14.28 \quad \begin{aligned} \mathcal{L}(f'(t); s) &= s \mathcal{L}(f(t); s) - f(0+) \\ &\quad - \sum_{k=1}^n e^{-st_k} (f(t_k+) - f(t_k-)). \end{aligned}$$

Next, assume  $f(t)$ ,  $f'(t)$ ,  $\dots$ ,  $f^{(n-1)}(t)$  are continuous and each satisfies (1.14.18). Also assume that  $f^{(n)}(t)$  is piecewise continuous on  $[0, \infty)$ . Then

$$1.14.29 \quad \begin{aligned} \mathcal{L}(f^{(n)}(t); s) &= s^n \mathcal{L}(f(t); s) - s^{n-1} f(0+) \\ &\quad - s^{n-2} f'(0+) - \dots - f^{(n-1)}(0+). \end{aligned}$$

**Convolution**

For Laplace transforms, the *convolution* of two functions  $f(t)$  and  $g(t)$ , defined on  $[0, \infty)$ , is

$$1.14.30 \quad (f * g)(t) = \int_0^t f(u)g(t - u) du.$$

If  $f(t)$  and  $g(t)$  are piecewise continuous, then

$$1.14.31 \quad \mathcal{L}(f * g) = \mathcal{L}(f) \mathcal{L}(g).$$

**Uniqueness**

If  $f(t)$  and  $g(t)$  are continuous and  $\mathcal{L}(f) = \mathcal{L}(g)$ , then  $f(t) = g(t)$ .

**1.14(iv) Mellin Transform**

The *Mellin transform* of a real- or complex-valued function  $f(x)$  is defined by

$$1.14.32 \quad \mathcal{M}(f; s) = \int_0^\infty x^{s-1} f(x) dx.$$

Alternative notations for  $\mathcal{M}(f; s)$  are  $\mathcal{M}(f(x); s)$  and  $\mathcal{M}(f)$ .

If  $x^{\sigma-1}f(x)$  is integrable on  $(0, \infty)$  for all  $\sigma$  in  $a < \sigma < b$ , then the integral (1.14.32) converges and  $\mathcal{M}(f; s)$  is an analytic function of  $s$  in the vertical strip  $a < \Re s < b$ . Moreover, for  $a < \sigma < b$ ,

$$1.14.33 \quad \lim_{t \rightarrow \pm\infty} \mathcal{M}(f; \sigma + it) = 0.$$

Note: If  $f(x)$  is continuous and  $\alpha$  and  $\beta$  are real numbers such that  $f(x) = O(x^\alpha)$  as  $x \rightarrow 0+$  and  $f(x) = O(x^\beta)$  as  $x \rightarrow \infty$ , then  $x^{\sigma-1}f(x)$  is integrable on  $(0, \infty)$  for all  $\sigma \in (-\alpha, -\beta)$ .

**Inversion**

Suppose the integral (1.14.32) is absolutely convergent on the line  $\Re s = \sigma$  and  $f(x)$  is of bounded variation in a neighborhood of  $x = u$ . Then

$$1.14.34 \quad \frac{1}{2}(f(u+) + f(u-)) = \frac{1}{2\pi i} \lim_{T \rightarrow \infty} \int_{\sigma-iT}^{\sigma+iT} u^{-s} \mathcal{M}(f; s) ds.$$

If  $f(x)$  is continuous on  $(0, \infty)$  and  $\mathcal{M}(f; \sigma + it)$  is integrable on  $(-\infty, \infty)$ , then

$$1.14.35 \quad f(x) = \frac{1}{2\pi i} \int_{\sigma-i\infty}^{\sigma+i\infty} x^{-s} \mathcal{M}(f; s) ds.$$

**Parseval-type Formulas**

Suppose  $x^{-\sigma}f(x)$  and  $x^{\sigma-1}g(x)$  are absolutely integrable on  $(0, \infty)$  and either  $\mathcal{M}(g; \sigma + it)$  or  $\mathcal{M}(f; 1 - \sigma - it)$  is absolutely integrable on  $(-\infty, \infty)$ . Then for  $y > 0$ ,

$$1.14.36 \quad \int_0^\infty f(x)g(yx) dx = \frac{1}{2\pi i} \int_{\sigma-i\infty}^{\sigma+i\infty} y^{-s} \mathcal{M}(f; 1-s) \mathcal{M}(g; s) ds,$$

$$1.14.37 \quad \int_0^\infty f(x)g(x) dx = \frac{1}{2\pi i} \int_{\sigma-i\infty}^{\sigma+i\infty} \mathcal{M}(f; 1-s) \mathcal{M}(g; s) ds.$$

When  $f$  is real and  $\sigma = \frac{1}{2}$ ,

$$1.14.38 \quad \int_0^\infty (f(x))^2 dx = \frac{1}{2\pi} \int_{-\infty}^\infty |\mathcal{M}(f; \frac{1}{2} + it)|^2 dt.$$

**Convolution**

Let

$$1.14.39 \quad (f * g)(x) = \int_0^\infty f(y)g\left(\frac{x}{y}\right) \frac{dy}{y}.$$

If  $x^{\sigma-1}f(x)$  and  $x^{\sigma-1}g(x)$  are absolutely integrable on  $(0, \infty)$ , then for  $s = \sigma + it$ ,

$$1.14.40 \quad \int_0^\infty x^{s-1}(f * g)(x) dx = \mathcal{M}(f; s) \mathcal{M}(g; s).$$

**1.14(v) Hilbert Transform**

The *Hilbert transform* of a real-valued function  $f(t)$  is defined in the following equivalent ways:

$$1.14.41 \quad \mathcal{H}(f; x) = \mathcal{H}(f(t); x) = \mathcal{H}(f) = \frac{1}{\pi} \int_{-\infty}^\infty \frac{f(t)}{t-x} dt,$$

$$1.14.42 \quad \mathcal{H}(f; x) = \lim_{y \rightarrow 0+} \frac{1}{\pi} \int_{-\infty}^\infty \frac{t-x}{(t-x)^2 + y^2} f(t) dt,$$

$$1.14.43 \quad \mathcal{H}(f; x) = \lim_{\epsilon \rightarrow 0+} \frac{1}{\pi} \int_\epsilon^\infty \frac{f(x+t) - f(x-t)}{t} dt.$$

**Inversion**

Suppose  $f(t)$  is continuously differentiable on  $(-\infty, \infty)$  and vanishes outside a bounded interval. Then

$$1.14.44 \quad f(x) = -\frac{1}{\pi} \int_{-\infty}^\infty \frac{\mathcal{H}(f; u)}{u-x} du.$$

**Inequalities**

If  $|f(t)|^p$ ,  $p > 1$ , is integrable on  $(-\infty, \infty)$ , then so is  $|\mathcal{H}(f; x)|^p$  and

$$1.14.45 \quad \int_{-\infty}^\infty |\mathcal{H}(f; x)|^p dx \leq A_p \int_{-\infty}^\infty |f(t)|^p dt,$$

where  $A_p = \tan(\frac{1}{2}\pi/p)$  when  $1 < p \leq 2$ , or  $\cot(\frac{1}{2}\pi/p)$  when  $p \geq 2$ . These bounds are sharp, and equality holds when  $p = 2$ .

**Fourier Transform**

When  $f(t)$  satisfies the same conditions as those for (1.14.44),

$$1.14.46 \quad \frac{1}{\sqrt{2\pi}} \int_{-\infty}^\infty \mathcal{H}(f; t)e^{ixt} dt = -i(\text{sign } x)F(x),$$

where  $F(x)$  is given by (1.14.1).

**1.14(vi) Stieltjes Transform**

The *Stieltjes transform* of a real-valued function  $f(t)$  is defined by

$$1.14.47 \quad \mathcal{S}(f; s) = \mathcal{S}(f(t); s) = \mathcal{S}(f) = \int_0^\infty \frac{f(t)}{s+t} dt.$$

Sufficient conditions for the integral to converge are that  $s$  is a positive real number, and  $f(t) = O(t^{-\delta})$  as  $t \rightarrow \infty$ , where  $\delta > 0$ .

If the integral converges, then it converges uniformly in any compact domain in the complex  $s$ -plane not containing any point of the interval  $(-\infty, 0]$ . In this case,  $\mathcal{S}(f; s)$  represents an analytic function in the  $s$ -plane cut along the negative real axis, and

$$\mathbf{1.14.48} \quad \frac{d^m}{ds^m} \mathcal{S}(f; s) = (-1)^m m! \int_0^\infty \frac{f(t) dt}{(s+t)^{m+1}},$$

$$m = 0, 1, 2, \dots$$

#### Inversion

If  $f(t)$  is absolutely integrable on  $[0, R]$  for every finite  $R$ , and the integral (1.14.47) converges, then

$$\mathbf{1.14.49} \quad \lim_{t \rightarrow 0^+} \frac{\mathcal{S}(f; -\sigma - it) - \mathcal{S}(f; -\sigma + it)}{2\pi i}$$

$$= \frac{1}{2}(f(\sigma+) + f(\sigma-)),$$

for all values of the positive constant  $\sigma$  for which the right-hand side exists.

#### Laplace Transform

If  $f(t)$  is piecewise continuous on  $[0, \infty)$  and the integral (1.14.47) converges, then

$$\mathbf{1.14.50} \quad \mathcal{S}(f) = \mathcal{L}(\mathcal{L}(f)).$$

### 1.14(vii) Tables

Table 1.14.1: Fourier transforms.

$f(t)$	$\frac{1}{\sqrt{2\pi}} \int_{-\infty}^{\infty} f(t) e^{ixt} dt$
$\begin{cases} 1, &  t  < a, \\ 0, & \text{otherwise} \end{cases}$	$\sqrt{\frac{2}{\pi}} \frac{\sin(ax)}{x}$
$e^{-a t }$	$\sqrt{\frac{2}{\pi}} \frac{a}{a^2 + x^2}, \quad a > 0$
$te^{-a t }$	$\sqrt{\frac{2}{\pi}} \frac{2iax}{(a^2 + x^2)^2}, \quad a > 0$
$ t e^{-a t }$	$\sqrt{\frac{2}{\pi}} \frac{a^2 - x^2}{(a^2 + x^2)^2}, \quad a > 0$
$\frac{e^{-a t }}{ t ^{1/2}}$	$\frac{(a + (a^2 + x^2)^{1/2})^{1/2}}{(a^2 + x^2)^{1/2}}, \quad a > 0$
$\frac{\sinh(at)}{\sinh(\pi t)}$	$\frac{1}{\sqrt{2\pi}} \frac{\sin a}{\cosh x + \cos a}, \quad \begin{matrix} -\pi < \\ a < \pi \end{matrix}$
$\frac{\cosh(at)}{\cosh(\pi t)}$	$\sqrt{\frac{2}{\pi}} \frac{\cos(\frac{1}{2}a) \cosh(\frac{1}{2}x)}{\cosh x + \cos a}, \quad \begin{matrix} -\pi < \\ a < \pi \end{matrix}$
$e^{-at^2}$	$\frac{1}{\sqrt{2a}} e^{-x^2/(4a)}, \quad a > 0$
$\sin(at^2)$	$-\frac{1}{\sqrt{2a}} \sin\left(\frac{x^2}{4a} - \frac{\pi}{4}\right), \quad a > 0$
$\cos(at^2)$	$\frac{1}{\sqrt{2a}} \cos\left(\frac{x^2}{4a} - \frac{\pi}{4}\right), \quad a > 0$

Table 1.14.2: Fourier cosine transforms.

$f(t)$	$\sqrt{\frac{2}{\pi}} \int_0^\infty f(t) \cos(xt) dt, \quad x > 0$	
$\begin{cases} 1, & 0 < t \leq a, \\ 0, & \text{otherwise} \end{cases}$	$\sqrt{\frac{2}{\pi}} \frac{\sin(ax)}{x}$	
$\frac{1}{a^2 + t^2}$	$\sqrt{\frac{\pi}{2}} \frac{e^{-ax}}{a}, \quad \Re a > 0$	
$\frac{1}{(a^2 + t^2)^2}$	$\sqrt{\frac{\pi}{2}} \frac{(1 + ax)e^{-ax}}{2a^3}, \quad \Re a > 0$	
$\frac{4a^3}{4a^4 + t^4}$	$\sqrt{\pi} e^{-ax} \sin\left(ax + \frac{1}{4}\pi\right), \quad \Re a > 0$	
$e^{-at}$	$\sqrt{\frac{2}{\pi}} \frac{a}{a^2 + x^2}, \quad \Re a > 0$	
$e^{-at^2}$	$\frac{1}{\sqrt{2a}} e^{-x^2/(4a)}, \quad \Re a > 0$	
$\sin(at^2)$	$-\frac{1}{\sqrt{2a}} \sin\left(\frac{x^2}{4a} - \frac{\pi}{4}\right), \quad a > 0$	
$\cos(at^2)$	$\frac{1}{\sqrt{2a}} \cos\left(\frac{x^2}{4a} - \frac{\pi}{4}\right), \quad a > 0$	
$\ln\left(1 + \frac{a^2}{t^2}\right)$	$\sqrt{2\pi} \frac{1 - e^{-ax}}{x}, \quad \Re a > 0$	
$\ln\left(\frac{a^2 + t^2}{b^2 + t^2}\right)$	$\sqrt{2\pi} \frac{e^{-bx} - e^{-ax}}{x}, \quad \Re a > 0, \quad \Re b > 0$	

Table 1.14.3: Fourier sine transforms.

$f(t)$	$\sqrt{\frac{2}{\pi}} \int_0^\infty f(t) \sin(xt) dt, \quad x > 0$	
$t^{-1}$	$\sqrt{\frac{\pi}{2}}$	
$t^{-1/2}$	$x^{-1/2}$	
$t^{-3/2}$	$2x^{1/2}$	
$\frac{t}{a^2 + t^2}$	$\sqrt{\frac{\pi}{2}} e^{-ax}, \quad \Re a > 0$	
$\frac{t}{(a^2 + t^2)^2}$	$\sqrt{\frac{\pi}{8}} \frac{x}{a} e^{-ax}, \quad \Re a > 0$	
$\frac{1}{t(a^2 + t^2)}$	$\sqrt{\frac{\pi}{2}} \frac{1 - e^{-ax}}{a^2}, \quad \Re a > 0$	
$\frac{e^{-at}}{t}$	$\sqrt{\frac{2}{\pi}} \arctan\left(\frac{x}{a}\right), \quad \Re a > 0$	
$e^{-at}$	$\sqrt{\frac{2}{\pi}} \frac{x}{a^2 + x^2}, \quad \Re a > 0$	
$te^{-at}$	$\sqrt{\frac{2}{\pi}} \frac{2ax}{(a^2 + x^2)^2}, \quad \Re a > 0$	
$te^{-at^2}$	$(2a)^{-3/2} x e^{-x^2/(4a)}, \quad  \text{ph } a  < \frac{1}{2}\pi$	
$\frac{\sin(at)}{t}$	$\frac{1}{\sqrt{2\pi}} \ln \left  \frac{x+a}{x-a} \right , \quad a > 0$	
$\arctan\left(\frac{t}{a}\right)$	$\sqrt{\frac{\pi}{2}} \frac{e^{-ax}}{x}, \quad a > 0$	
$\ln \left  \frac{t+a}{t-a} \right $	$\sqrt{2\pi} \frac{\sin(ax)}{x}, \quad a > 0$	



Table 1.14.4: Laplace transforms.

$f(t)$	$\int_0^\infty e^{-st} f(t) dt$	
1	$\frac{1}{s}$ ,	$\Re s > 0$
$\frac{t^n}{n!}$	$\frac{1}{s^{n+1}}$ ,	$\Re s > 0$
$\frac{1}{\sqrt{\pi t}}$	$\frac{1}{\sqrt{s}}$ ,	$\Re s > 0$
$e^{-at}$	$\frac{1}{s+a}$ ,	$\Re(s+a) > 0$
$\frac{t^n e^{-at}}{n!}$	$\frac{1}{(s+a)^{n+1}}$ ,	$\Re(s+a) > 0$
$\frac{e^{-at} - e^{-bt}}{b-a}$	$\frac{1}{(s+a)(s+b)}$ ,	$a \neq b,$ $\Re s > -\Re a,$ $\Re s > -\Re b$
$\sin(at)$	$\frac{a}{s^2 + a^2}$ ,	$\Re s >  \Im a $
$\cos(at)$	$\frac{s}{s^2 + a^2}$ ,	$\Re s >  \Im a $
$\sinh(at)$	$\frac{a}{s^2 - a^2}$ ,	$\Re s >  \Re a $
$\cosh(at)$	$\frac{s}{s^2 - a^2}$ ,	$\Re s >  \Re a $
$t \sin(at)$	$\frac{2as}{(s^2 + a^2)^2}$ ,	$\Re s >  \Im a $
$t \cos(at)$	$\frac{s^2 - a^2}{(s^2 + a^2)^2}$ ,	$\Re s >  \Im a $
$\frac{e^{-bt} - e^{-at}}{t}$	$\ln\left(\frac{s+a}{s+b}\right)$ ,	$\Re s > -\Re a,$ $\Re s > -\Re b$
$\frac{2(1 - \cosh(at))}{t}$	$\ln\left(1 - \frac{a^2}{s^2}\right)$ ,	$\Re(s+a) > 0$
$\frac{2(1 - \cos(at))}{t}$	$\ln\left(1 + \frac{a^2}{s^2}\right)$ ,	$\Re s > 0$
$\frac{\sin(at)}{t}$	$\arctan\left(\frac{a}{s}\right)$ ,	$\Re s > 0$

Table 1.14.5: Mellin transforms.

$f(x)$	$\int_0^\infty x^{s-1} f(x) dx$	
$\begin{cases} 1, & x < a, \\ 0, & x \geq a \end{cases}$	$\frac{a^s}{s}$ ,	$a \geq 0, \Re s > 0$
$\begin{cases} \ln(a/x), & x < a, \\ 0, & x \geq a \end{cases}$	$\frac{a^s}{s^2}$ ,	$a \geq 0, \Re s > 1$
$\frac{1}{1-x}$	$\pi \cot(s\pi)$ ,	$0 < \Re s < 1,$ (Cauchy p. v.)
$\frac{1}{1+x}$	$\pi \csc(s\pi)$ ,	$0 < \Re s < 1$
$\ln(1+ax)$	$\frac{\pi \csc(s\pi)}{sa^s}$ ,	$ \text{ph } a  < \pi,$ $-1 < \Re s < 0$
$\ln\left \frac{1+x}{1-x}\right $	$\frac{\pi \tan(\frac{1}{2}s\pi)}{s}$ ,	$-1 < \Re s < 1$
$\frac{\ln(1+x)}{x}$	$\frac{\pi \csc(s\pi)}{1-s}$ ,	$0 < \Re s < 1$
$\arctan x$	$-\frac{\pi \sec(\frac{1}{2}s\pi)}{2s}$ ,	$-1 < \Re s < 0$
$\text{arccot } x$	$\frac{\pi \sec(\frac{1}{2}s\pi)}{2s}$ ,	$0 < \Re s < 1$
$\frac{1+x \cos \theta}{1+2x \cos \theta + x^2}$	$\frac{\pi \cos(s\theta)}{\sin(s\pi)}$ ,	$-\pi < \theta < \pi,$ $0 < \Re s < 1$
$\frac{x \sin \theta}{1+2x \cos \theta + x^2}$	$\frac{\pi \sin(s\theta)}{\sin(s\pi)}$ ,	$-\pi < \theta < \pi,$ $0 < \Re s < 1$

### 1.14(viii) Compendia

For more extensive tables of the integral transforms of this section and tables of other integral transforms, see Erdélyi *et al.* (1954a,b), Gradshteyn and Ryzhik (2000), Marichev (1983), Oberhettinger (1972, 1974, 1990), Oberhettinger and Badii (1973), Oberhettinger and Higgins (1961), Prudnikov *et al.* (1986a,b, 1990, 1992a,b).

## 1.15 Summability Methods

### 1.15(i) Definitions for Series

$$1.15.1 \quad s_n = \sum_{k=0}^n a_k.$$

#### Abel Summability

$$1.15.2 \quad \sum_{n=0}^{\infty} a_n = s \quad (A),$$

if

$$1.15.3 \quad \lim_{x \rightarrow 1^-} \sum_{n=0}^{\infty} a_n x^n = s.$$

#### Cesàro Summability

$$1.15.4 \quad \sum_{n=0}^{\infty} a_n = s \quad (C,1),$$

if

$$1.15.5 \quad \lim_{n \rightarrow \infty} \frac{s_0 + s_1 + \cdots + s_n}{n+1} = s.$$

#### General Cesàro Summability

For  $\alpha > -1$ ,

$$1.15.6 \quad \sum_{n=0}^{\infty} a_n = s \quad (C,\alpha),$$

if

$$1.15.7 \quad \lim_{n \rightarrow \infty} \frac{n!}{(\alpha+1)_n} \sum_{k=0}^n \frac{(\alpha+1)_k}{k!} a_{n-k} = s.$$

#### Borel Summability

$$1.15.8 \quad \sum_{n=0}^{\infty} a_n = s \quad (B),$$

if

$$1.15.9 \quad \lim_{t \rightarrow \infty} e^{-t} \sum_{n=0}^{\infty} \frac{s_n}{n!} t^n = s.$$

### 1.15(ii) Regularity

Methods of summation are *regular* if they are consistent with conventional summation. All of the methods described in §1.15(i) are regular. For example if

$$1.15.10 \quad \sum_{n=0}^{\infty} a_n = s,$$

then

$$1.15.11 \quad \sum_{n=0}^{\infty} a_n = s \quad (A).$$

### 1.15(iii) Summability of Fourier Series

#### Poisson Kernel

##### 1.15.12

$$P(r, \theta) = \frac{1-r^2}{1-2r \cos \theta + r^2} = \sum_{n=-\infty}^{\infty} r^{|n|} e^{in\theta}, \quad 0 \leq r < 1,$$

$$1.15.13 \quad \frac{1}{2\pi} \int_0^{2\pi} P(r, \theta) d\theta = 1.$$

As  $r \rightarrow 1^-$

$$1.15.14 \quad P(r, \theta) \rightarrow 0,$$

uniformly for  $\theta \in [\delta, 2\pi - \delta]$ . (Here and elsewhere in this subsection  $\delta$  is a constant such that  $0 < \delta < \pi$ .)

#### Fejér Kernel

For  $n = 0, 1, 2, \dots$ ,

$$1.15.15 \quad K_n(\theta) = \frac{1}{n+1} \left( \frac{\sin(\frac{1}{2}(n+1)\theta)}{\sin(\frac{1}{2}\theta)} \right)^2,$$

$$1.15.16 \quad \frac{1}{2\pi} \int_0^{2\pi} K_n(\theta) d\theta = 1.$$

As  $n \rightarrow \infty$

$$1.15.17 \quad K_n(\theta) \rightarrow 0,$$

uniformly for  $\theta \in [\delta, 2\pi - \delta]$ .

#### Abel Means

$$1.15.18 \quad A(r, \theta) = \sum_{n=-\infty}^{\infty} r^{|n|} F(n) e^{in\theta},$$

where

$$1.15.19 \quad F(n) = \frac{1}{2\pi} \int_0^{2\pi} f(t) e^{-int} dt.$$

$A(r, \theta)$  is a harmonic function in polar coordinates ((1.9.27)), and

$$1.15.20 \quad A(r, \theta) = \frac{1}{2\pi} \int_0^{2\pi} P(r, \theta - t) f(t) dt.$$

#### Cesàro (or (C,1)) Means

Let

$$1.15.21 \quad \sigma_n(\theta) = \frac{s_0(\theta) + s_1(\theta) + \cdots + s_n(\theta)}{n+1},$$

$n = 0, 1, 2, \dots$ , where

$$1.15.22 \quad s_n(\theta) = \sum_{k=-n}^n F(k) e^{ik\theta}.$$

Then

$$1.15.23 \quad \sigma_n(\theta) = \frac{1}{2\pi} \int_0^{2\pi} K_n(\theta - t) f(t) dt.$$

**Convergence**

If  $f(\theta)$  is periodic and integrable on  $[0, 2\pi]$ , then as  $n \rightarrow \infty$  the Abel means  $A(r, \theta)$  and the  $(C, 1)$  means  $\sigma_n(\theta)$  converge to

$$1.15.24 \quad \frac{1}{2}(f(\theta+) + f(\theta-))$$

at every point  $\theta$  where both limits exist. If  $f(\theta)$  is also continuous, then the convergence is uniform for all  $\theta$ .

For real-valued  $f(\theta)$ , if

$$1.15.25 \quad \sum_{n=-\infty}^{\infty} F(n)e^{in\theta}$$

is the Fourier series of  $f(\theta)$ , then the series

$$1.15.26 \quad F(0) + 2 \sum_{n=1}^{\infty} F(n)e^{in\theta}$$

can be extended to the interior of the unit circle as an analytic function

$$1.15.27 \quad \begin{aligned} G(z) &= G(x + iy) = u(x, y) + iv(x, y) \\ &= F(0) + 2 \sum_{n=1}^{\infty} F(n)z^n. \end{aligned}$$

Here  $u(x, y) = A(r, \theta)$  is the *Abel* (or *Poisson*) *sum* of  $f(\theta)$ , and  $v(x, y)$  has the series representation

$$1.15.28 \quad - \sum_{n=-\infty}^{\infty} i(\text{sign } n)F(n)r^{|n|}e^{in\theta};$$

compare §1.15(v).

**1.15(iv) Definitions for Integrals****Abel Summability**

$\int_{-\infty}^{\infty} f(t) dt$  is *Abel summable* to  $L$ , or

$$1.15.29 \quad \int_{-\infty}^{\infty} f(t) dt = L \quad (A),$$

when

$$1.15.30 \quad \lim_{\epsilon \rightarrow 0+} \int_{-\infty}^{\infty} e^{-\epsilon|t|} f(t) dt = L.$$

**Cesàro Summability**

$\int_{-\infty}^{\infty} f(t) dt$  is  $(C, 1)$  *summable* to  $L$ , or

$$1.15.31 \quad \int_{-\infty}^{\infty} f(t) dt = L \quad (C, 1),$$

when

$$1.15.32 \quad \lim_{R \rightarrow \infty} \int_{-R}^R \left(1 - \frac{|t|}{R}\right) f(t) dt = L.$$

If  $\int_{-\infty}^{\infty} f(t) dt$  converges and equals  $L$ , then the integral is Abel and Cesàro summable to  $L$ .

**1.15(v) Summability of Fourier Integrals****Poisson Kernel**

$$1.15.33 \quad P(x, y) = \frac{2y}{x^2 + y^2}, \quad y > 0, \quad -\infty < x < \infty.$$

$$1.15.34 \quad \frac{1}{2\pi} \int_{-\infty}^{\infty} P(x, y) dx = 1.$$

For each  $\delta > 0$ ,

$$1.15.35 \quad \int_{|x| \geq \delta} P(x, y) dx \rightarrow 0, \quad \text{as } y \rightarrow 0.$$

Let

$$1.15.36 \quad h(x, y) = \frac{1}{\sqrt{2\pi}} \int_{-\infty}^{\infty} e^{-y|t|} e^{-ixt} F(t) dt,$$

where  $F(t)$  is the Fourier transform of  $f(x)$  (§1.14(i)).

Then

$$1.15.37 \quad h(x, y) = \frac{1}{2\pi} \int_{-\infty}^{\infty} f(t) P(x - t, y) dt$$

is the *Poisson integral* of  $f(t)$ .

If  $f(x)$  is integrable on  $(-\infty, \infty)$ , then

$$1.15.38 \quad \lim_{y \rightarrow 0+} \int_{-\infty}^{\infty} |h(x, y) - f(x)| dx = 0.$$

Suppose now  $f(x)$  is real-valued and integrable on  $(-\infty, \infty)$ . Let

$$1.15.39 \quad \Phi(z) = \Phi(x + iy) = \frac{i}{\pi} \int_{-\infty}^{\infty} f(t) \frac{1}{(x - t) + iy} dt,$$

where  $y > 0$  and  $-\infty < x < \infty$ . Then  $\Phi(z)$  is an analytic function in the upper half-plane and its real part is the Poisson integral  $h(x, y)$ ; compare (1.9.34). The imaginary part

$$1.15.40 \quad \Im \Phi(x + iy) = \frac{1}{\pi} \int_{-\infty}^{\infty} f(t) \frac{x - t}{(x - t)^2 + y^2} dt$$

is the *conjugate Poisson integral* of  $f(x)$ . Moreover,  $\lim_{y \rightarrow 0+} \Im \Phi(x + iy)$  is the Hilbert transform of  $f(x)$  (§1.14(v)).

**Fejér Kernel**

$$1.15.41 \quad K_R(s) = \frac{1}{\pi R} \frac{1 - \cos(Rs)}{s^2},$$

$$1.15.42 \quad \int_{-\infty}^{\infty} K_R(s) ds = 1.$$

For each  $\delta > 0$ ,

$$1.15.43 \quad \int_{|s| \geq \delta} K_R(s) ds \rightarrow 0, \quad \text{as } R \rightarrow \infty.$$

Let

$$1.15.44 \quad \sigma_R(\theta) = \frac{1}{\sqrt{2\pi}} \int_{-R}^R \left(1 - \frac{|t|}{R}\right) e^{-i\theta t} F(t) dt,$$

then

$$1.15.45 \quad \sigma_R(\theta) = \int_{-\infty}^{\infty} f(t) K_R(\theta - t) dt.$$

If  $f(\theta)$  is integrable on  $(-\infty, \infty)$ , then

$$1.15.46 \quad \lim_{R \rightarrow \infty} \int_{-\infty}^{\infty} |\sigma_R(\theta) - f(\theta)| d\theta = 0.$$

### 1.15(vi) Fractional Integrals

For  $\Re\alpha > 0$ , the *fractional integral operator of order  $\alpha$*  is defined by

$$1.15.47 \quad I^\alpha f(x) = \frac{1}{\Gamma(\alpha)} \int_0^x (x-t)^{\alpha-1} f(t) dt.$$

For  $\Gamma(\alpha)$  see §5.2, and compare (1.4.31) in the case when  $\alpha$  is a positive integer.

$$1.15.48 \quad I^\alpha I^\beta = I^{\alpha+\beta}, \quad \Re\alpha > 0, \Re\beta > 0.$$

For extensions of (1.15.48) see Love (1972b).

If

$$1.15.49 \quad f(x) = \sum_{k=0}^{\infty} a_k x^k,$$

then

$$1.15.50 \quad I^\alpha f(x) = \sum_{k=0}^{\infty} \frac{k!}{\Gamma(k+\alpha+1)} a_k x^{k+\alpha}.$$

### 1.15(vii) Fractional Derivatives

For  $0 < \Re\alpha < n$ ,  $n$  an integer,

$$1.15.51 \quad D^\alpha f(x) = \frac{d^n}{dx^n} I^{n-\alpha} f(x),$$

$$1.15.52 \quad D^k I^\alpha = D^n I^{\alpha+n-k}, \quad k = 1, 2, \dots, n.$$

When none of  $\alpha$ ,  $\beta$ , and  $\alpha + \beta$  is an integer

$$1.15.53 \quad D^\alpha D^\beta = D^{\alpha+\beta}.$$

Note that  $D^{1/2} D \neq D^{3/2}$ . See also Love (1972b).

### 1.15(viii) Tauberian Theorems

If

$$1.15.54 \quad \sum_{n=0}^{\infty} a_n = s \quad (A), \quad a_n > -\frac{K}{n}, \quad n > 0, K > 0,$$

then

$$1.15.55 \quad \sum_{n=0}^{\infty} a_n = s.$$

If

$$1.15.56 \quad \lim_{x \rightarrow 1^-} (1-x) \sum_{n=0}^{\infty} a_n x^n = s,$$

and either  $|a_n| \leq K$  or  $a_n \geq 0$ , then

$$1.15.57 \quad \lim_{n \rightarrow \infty} \frac{a_0 + a_1 + \dots + a_n}{n+1} = s.$$

## 1.16 Distributions

### 1.16(i) Test Functions

Let  $\phi$  be a function defined on an open interval  $I = (a, b)$ , which can be infinite. The closure of the set of points where  $\phi \neq 0$  is called the *support* of  $\phi$ . If the support of  $\phi$  is a compact set (§1.9(vii)), then  $\phi$  is called a *function of compact support*. A *test function* is an infinitely differentiable function of compact support.

A sequence  $\{\phi_n\}$  of test functions *converges* to a test function  $\phi$  if the support of every  $\phi_n$  is contained in a fixed compact set  $K$  and as  $n \rightarrow \infty$  the sequence  $\{\phi_n^{(k)}\}$  converges uniformly on  $K$  to  $\phi^{(k)}$  for  $k = 0, 1, 2, \dots$ .

The linear space of all test functions with the above definition of convergence is called a *test function space*. We denote it by  $\mathcal{D}(I)$ .

A mapping  $\Lambda$  on  $\mathcal{D}(I)$  is a *linear functional* if it takes complex values and

$$1.16.1 \quad \Lambda(\alpha_1 \phi_1 + \alpha_2 \phi_2) = \alpha_1 \Lambda(\phi_1) + \alpha_2 \Lambda(\phi_2),$$

where  $\alpha_1$  and  $\alpha_2$  are real or complex constants.  $\Lambda : \mathcal{D}(I) \rightarrow \mathbb{C}$  is called a *distribution* if it is a continuous linear functional on  $\mathcal{D}(I)$ , that is, it is a linear functional and for every  $\phi_n \rightarrow \phi$  in  $\mathcal{D}(I)$ ,

$$1.16.2 \quad \lim_{n \rightarrow \infty} \Lambda(\phi_n) = \Lambda(\phi).$$

From here on we write  $\langle \Lambda, \phi \rangle$  for  $\Lambda(\phi)$ . The space of all distributions will be denoted by  $\mathcal{D}^*(I)$ . A distribution  $\Lambda$  is called *regular* if there is a function  $f$  on  $I$ , which is absolutely integrable on every compact subset of  $I$ , such that

$$1.16.3 \quad \langle \Lambda, \phi \rangle = \int_I f(x) \phi(x) dx.$$

We denote a regular distribution by  $\Lambda_f$ , or simply  $f$ , where  $f$  is the function giving rise to the distribution. (If a distribution is not regular, it is called *singular*.)

Define

$$1.16.4 \quad \langle \Lambda_1 + \Lambda_2, \phi \rangle = \langle \Lambda_1, \phi \rangle + \langle \Lambda_2, \phi \rangle,$$

$$1.16.5 \quad \langle c\Lambda, \phi \rangle = c \langle \Lambda, \phi \rangle = \langle \Lambda, c\phi \rangle,$$

where  $c$  is a constant. More generally, if  $\alpha(x)$  is an infinitely differentiable function, then

$$1.16.6 \quad \langle \alpha\Lambda, \phi \rangle = \langle \Lambda, \alpha\phi \rangle.$$

We say that a sequence of distributions  $\{\Lambda_n\}$  *converges* to a distribution  $\Lambda$  in  $\mathcal{D}^*$  if

$$1.16.7 \quad \lim_{n \rightarrow \infty} \langle \Lambda_n, \phi \rangle = \langle \Lambda, \phi \rangle$$

for all  $\phi \in \mathcal{D}(I)$ .

### 1.16(ii) Derivatives of a Distribution

The *derivative*  $\Lambda'$  of a distribution is defined by

$$1.16.8 \quad \langle \Lambda', \phi \rangle = - \langle \Lambda, \phi' \rangle, \quad \phi \in \mathcal{D}(I).$$

Similarly

$$1.16.9 \quad \langle \Lambda^{(k)}, \phi \rangle = (-1)^k \langle \Lambda, \phi^{(k)} \rangle, \quad k = 1, 2, \dots$$

For any locally integrable function  $f$ , its *distributional derivative* is  $Df = \Lambda'_f$ .

### 1.16(iii) Dirac Delta Distribution

$$1.16.10 \quad \langle \delta, \phi \rangle = \phi(0), \quad \phi \in \mathcal{D}(I),$$

$$1.16.11 \quad \langle \delta_{x_0}, \phi \rangle = \phi(x_0), \quad \phi \in \mathcal{D}(I),$$

$$1.16.12 \quad \langle \delta_{x_0}^{(n)}, \phi \rangle = (-1)^n \phi^{(n)}(x_0), \quad \phi \in \mathcal{D}(I).$$

The Dirac delta distribution is singular.

### 1.16(iv) Heaviside Function

$$1.16.13 \quad H(x) = \begin{cases} 1, & x > 0, \\ 0, & x \leq 0. \end{cases}$$

$$1.16.14 \quad H(x - x_0) = \begin{cases} 1, & x > x_0, \\ 0, & x \leq x_0. \end{cases}$$

$$1.16.15 \quad DH = \delta,$$

$$1.16.16 \quad DH(x - x_0) = \delta_{x_0}.$$

Suppose  $f(x)$  is infinitely differentiable except at  $x_0$ , where left and right derivatives of all orders exist, and

$$1.16.17 \quad \sigma_n = f^{(n)}(x_0+) - f^{(n)}(x_0-).$$

Then

$$1.16.18 \quad D^m f = f^{(m)} + \sigma_0 \delta_{x_0}^{(m-1)} + \sigma_1 \delta_{x_0}^{(m-2)} + \dots + \sigma_{m-1} \delta_{x_0}, \quad m = 1, 2, \dots$$

For  $\alpha > -1$ ,

$$1.16.19 \quad x_+^\alpha = x^\alpha H(x) = \begin{cases} x^\alpha, & x > 0, \\ 0, & x \leq 0. \end{cases}$$

For  $\alpha > 0$ ,

$$1.16.20 \quad Dx_+^\alpha = \alpha x_+^{\alpha-1}.$$

For  $\alpha < -1$  and  $\alpha$  not an integer, define

$$1.16.21 \quad x_+^\alpha = \frac{1}{(\alpha+1)_n} D^n x_+^{\alpha+n},$$

where  $n$  is an integer such that  $\alpha + n > -1$ . Similarly, we write

$$1.16.22 \quad \ln_+ x = H(x) \ln x = \begin{cases} \ln x, & x > 0, \\ 0, & x \leq 0, \end{cases}$$

and define

$$1.16.23 \quad (-1)^n n! x_+^{-1-n} = D^{(n+1)} \ln_+ x, \quad n = 0, 1, 2, \dots$$

### 1.16(v) Tempered Distributions

The space  $\mathcal{T}(\mathbb{R})$  of test functions for tempered distributions consists of all infinitely-differentiable functions such that the function and all its derivatives are  $O(|x|^{-N})$  as  $|x| \rightarrow \infty$  for all  $N$ .

A sequence  $\{\phi_n\}$  of functions in  $\mathcal{T}$  is said to *converge* to a function  $\phi \in \mathcal{T}$  as  $n \rightarrow \infty$  if the sequence  $\{\phi_n^{(k)}\}$  converges uniformly to  $\phi^{(k)}$  on every finite interval and if the constants  $c_{k,N}$  in the inequalities

$$1.16.24 \quad |x^N \phi_n^{(k)}| \leq c_{k,N}$$

do not depend on  $n$ .

A *tempered distribution* is a continuous linear functional  $\Lambda$  on  $\mathcal{T}$ . (See the definition of a distribution in §1.16(i).) The set of tempered distributions is denoted by  $\mathcal{T}^*$ .

A sequence of tempered distributions  $\Lambda_n$  *converges* to  $\Lambda$  in  $\mathcal{T}^*$  if

$$1.16.25 \quad \lim_{n \rightarrow \infty} \langle \Lambda_n, \phi \rangle = \langle \Lambda, \phi \rangle,$$

for all  $\phi \in \mathcal{T}$ .

The derivatives of tempered distributions are defined in the same way as derivatives of distributions.

For a detailed discussion of tempered distributions see Lighthill (1958).

### 1.16(vi) Distributions of Several Variables

Let  $\mathcal{D}(\mathbb{R}^n) = \mathcal{D}_n$  be the set of all infinitely differentiable functions in  $n$  variables,  $\phi(x_1, x_2, \dots, x_n)$ , with compact support in  $\mathbb{R}^n$ . If  $k = (k_1, \dots, k_n)$  is a multi-index and  $x = (x_1, \dots, x_n) \in \mathbb{R}^n$ , then we write  $x^k = x_1^{k_1} \dots x_n^{k_n}$  and  $\phi^{(k)}(x) = \partial^k \phi / (\partial x_1^{k_1} \dots \partial x_n^{k_n})$ . A sequence  $\{\phi_m\}$  of functions in  $\mathcal{D}_n$  *converges* to a function  $\phi \in \mathcal{D}_n$  if the supports of  $\phi_m$  lie in a fixed compact subset  $K$  of  $\mathbb{R}^n$  and  $\phi_m^{(k)}$  converges uniformly to  $\phi^{(k)}$  in  $K$  for every multi-index  $k = (k_1, k_2, \dots, k_n)$ . A *distribution* in  $\mathbb{R}^n$  is a continuous linear functional on  $\mathcal{D}_n$ .

The partial derivatives of distributions in  $\mathbb{R}^n$  can be defined as in §1.16(ii). A locally integrable function  $f(x) = f(x_1, x_2, \dots, x_n)$  gives rise to a distribution  $\Lambda_f$  defined by

$$1.16.26 \quad \langle \Lambda_f, \phi \rangle = \int_{\mathbb{R}^n} f(x) \phi(x) dx, \quad \phi \in \mathcal{D}_n.$$

The *distributional derivative*  $D^k f$  of  $f$  is defined by

1.16.27

$$\langle D^k f, \phi \rangle = (-1)^{|k|} \int_{\mathbb{R}^n} f(x) \phi^{(k)}(x) dx, \quad \phi \in \mathcal{D}_n,$$

where  $k$  is a multi-index and  $|k| = k_1 + k_2 + \dots + k_n$ .

For tempered distributions the space of test functions  $\mathcal{T}_n$  is the set of all infinitely-differentiable functions  $\phi$  of  $n$  variables that satisfy

$$1.16.28 \quad |x^m \phi^{(k)}(x)| \leq c_{m,k}, \quad x \in \mathbb{R}^n.$$

Here  $m = (m_1, m_2, \dots, m_n)$  and  $k = (k_1, k_2, \dots, k_n)$  are multi-indices, and  $c_{m,k}$  are constants. Tempered distributions are continuous linear functionals on this space of test functions. The space of tempered distributions is denoted by  $\mathcal{T}_n^*$ .

### 1.16(vii) Fourier Transforms of Distributions

Suppose  $\phi$  is a test function in  $\mathcal{T}_n$ . Then its *Fourier transform* is

$$1.16.29 \quad F(\mathbf{x}) = F = \frac{1}{(2\pi)^{n/2}} \int_{\mathbb{R}^n} \phi(\mathbf{t}) e^{i\mathbf{x}\cdot\mathbf{t}} d\mathbf{t},$$

where  $\mathbf{x} = (x_1, x_2, \dots, x_n)$  and  $\mathbf{x} \cdot \mathbf{t} = x_1 t_1 + \dots + x_n t_n$ .  $F(\mathbf{x})$  is also in  $\mathcal{T}_n$ . For a multi-index  $\alpha = (\alpha_1, \alpha_2, \dots, \alpha_n)$ , set  $|\alpha| = \alpha_1 + \alpha_2 + \dots + \alpha_n$  and

$$1.16.30 \quad D_\alpha = i^{-|\alpha|} D^\alpha = \left( \frac{1}{i} \frac{\partial}{\partial x_1} \right)^{\alpha_1} \cdots \left( \frac{1}{i} \frac{\partial}{\partial x_n} \right)^{\alpha_n},$$

$$1.16.31 \quad P(\mathbf{x}) = P = \sum c_\alpha \mathbf{x}^\alpha = \sum c_\alpha x_1^{\alpha_1} \cdots x_n^{\alpha_n},$$

and

$$1.16.32 \quad P(D) = \sum c_\alpha D_\alpha.$$

Then

$$1.16.33 \quad \frac{1}{(2\pi)^{n/2}} \int_{\mathbb{R}^n} (P(D)\phi)(\mathbf{t}) e^{i\mathbf{x}\cdot\mathbf{t}} d\mathbf{t} = P(-\mathbf{x})F(\mathbf{x}),$$

and

$$1.16.34 \quad \frac{1}{(2\pi)^{n/2}} \int_{\mathbb{R}^n} P(\mathbf{t})\phi(\mathbf{t}) e^{i\mathbf{x}\cdot\mathbf{t}} d\mathbf{t} = P(D)F(\mathbf{x}).$$

If  $u \in \mathcal{T}_n^*$  is a tempered distribution, then its *Fourier transform*  $\mathcal{F}(u)$  is defined by

$$1.16.35 \quad \langle \mathcal{F}(u), \phi \rangle = \langle u, F \rangle, \quad \phi \in \mathcal{T}_n,$$

where  $F$  is given by (1.16.29). The *Fourier transform*  $\mathcal{F}(u)$  of a tempered distribution is again a tempered distribution, and

$$1.16.36 \quad \mathcal{F}(P(D)u) = P(-\mathbf{x})\mathcal{F}(u),$$

$$1.16.37 \quad \mathcal{F}(Pu) = P(D)\mathcal{F}(u).$$

In (1.16.36) and (1.16.37) the derivatives in  $P(D)$  are understood to be in the sense of distributions.

## 1.17 Integral and Series Representations of the Dirac Delta

### 1.17(i) Delta Sequences

In applications in physics and engineering, the Dirac delta distribution (§1.16(iii)) is historically and customarily replaced by the *Dirac delta* (or *Dirac delta function*)  $\delta(x)$ . This is an operator with the properties:

$$1.17.1 \quad \delta(x) = 0, \quad x \in \mathbb{R}, x \neq 0,$$

and

$$1.17.2 \quad \int_{-\infty}^{\infty} \delta(x-a)\phi(x) dx = \phi(a), \quad a \in \mathbb{R},$$

subject to certain conditions on the function  $\phi(x)$ . From the mathematical standpoint the left-hand side of (1.17.2) can be interpreted as a generalized integral in the sense that

$$1.17.3 \quad \lim_{n \rightarrow \infty} \int_{-\infty}^{\infty} \delta_n(x-a)\phi(x) dx = \phi(a),$$

for a suitably chosen sequence of functions  $\delta_n(x)$ ,  $n = 1, 2, \dots$ . Such a sequence is called a *delta sequence* and we write, symbolically,

$$1.17.4 \quad \lim_{n \rightarrow \infty} \delta_n(x) = \delta(x), \quad x \in \mathbb{R}.$$

An example of a delta sequence is provided by

$$1.17.5 \quad \delta_n(x-a) = \sqrt{\frac{n}{\pi}} e^{-n(x-a)^2}.$$

In this case

$$1.17.6 \quad \lim_{n \rightarrow \infty} \sqrt{\frac{n}{\pi}} \int_{-\infty}^{\infty} e^{-n(x-a)^2} \phi(x) dx = \phi(a),$$

for all functions  $\phi(x)$  that are continuous when  $x \in (-\infty, \infty)$ , and for each  $a$ ,  $\int_{-\infty}^{\infty} e^{-n(x-a)^2} \phi(x) dx$  converges absolutely for all sufficiently large values of  $n$ . The last condition is satisfied, for example, when  $\phi(x) = O(e^{\alpha x^2})$  as  $x \rightarrow \pm\infty$ , where  $\alpha$  is a real constant.

More generally, assume  $\phi(x)$  is piecewise continuous (§1.4(ii)) when  $x \in [-c, c]$  for any finite positive real value of  $c$ , and for each  $a$ ,  $\int_{-\infty}^{\infty} e^{-n(x-a)^2} \phi(x) dx$  converges absolutely for all sufficiently large values of  $n$ . Then

$$1.17.7 \quad \lim_{n \rightarrow \infty} \sqrt{\frac{n}{\pi}} \int_{-\infty}^{\infty} e^{-n(x-a)^2} \phi(x) dx = \frac{1}{2} \phi(a-) + \frac{1}{2} \phi(a+).$$

### 1.17(ii) Integral Representations

Formal interchange of the order of integration in the Fourier integral formula ((1.14.1) and (1.14.4)):

$$1.17.8 \quad \frac{1}{2\pi} \int_{-\infty}^{\infty} e^{-iat} \left( \int_{-\infty}^{\infty} \phi(x) e^{itx} dx \right) dt = \phi(a)$$

yields

$$1.17.9 \quad \int_{-\infty}^{\infty} \left( \frac{1}{2\pi} \int_{-\infty}^{\infty} e^{i(x-a)t} dt \right) \phi(x) dx = \phi(a).$$

The inner integral does not converge. However, for  $n = 1, 2, \dots$ ,

$$1.17.10 \quad \frac{1}{2\pi} \int_{-\infty}^{\infty} e^{-t^2/(4n)} e^{i(x-a)t} dt = \sqrt{\frac{n}{\pi}} e^{-n(x-a)^2}.$$

Hence comparison with (1.17.5) shows that (1.17.9) can be interpreted as a generalized integral (1.17.3) with

$$1.17.11 \quad \delta_n(x-a) = \frac{1}{2\pi} \int_{-\infty}^{\infty} e^{-t^2/(4n)} e^{i(x-a)t} dt,$$

provided that  $\phi(x)$  is continuous when  $x \in (-\infty, \infty)$ , and for each  $a$ ,  $\int_{-\infty}^{\infty} e^{-n(x-a)^2} \phi(x) dx$  converges absolutely for all sufficiently large values of  $n$  (as in the case of (1.17.6)). Then comparison of (1.17.2) and (1.17.9) yields the formal integral representation

$$1.17.12 \quad \delta(x-a) = \frac{1}{2\pi} \int_{-\infty}^{\infty} e^{i(x-a)t} dt.$$

Other similar integral representations of the Dirac delta that appear in the physics literature include the following:

**Bessel Functions and Spherical Bessel Functions**  
(§§10.2(ii), 10.47(ii))

$$1.17.13 \quad \delta(x-a) = x \int_0^{\infty} t J_{\nu}(xt) J_{\nu}(at) dt, \\ \Re \nu > -1, x > 0, a > 0,$$

$$1.17.14 \quad \delta(x-a) = \frac{2xa}{\pi} \int_0^{\infty} t^2 j_{\ell}(xt) j_{\ell}(at) dt, \quad x > 0, a > 0.$$

See Arfken and Weber (2005, Eq. (11.59)) and Konopinski (1981, p. 242). For a generalization of (1.17.14) see Maximon (1991).

**Coulomb Functions** (§33.14(iv))

$$1.17.15 \quad \delta(x-a) = \int_0^{\infty} s(x, \ell; r) s(a, \ell; r) dr, \quad a > 0, x > 0.$$

See Seaton (2002).

**Airy Functions** (§9.2)

$$1.17.16 \quad \delta(x-a) = \int_{-\infty}^{\infty} \text{Ai}(t-x) \text{Ai}(t-a) dt.$$

See Vallée and Soares (2004, §3.5.3).

**1.17(iii) Series Representations**

Formal interchange of the order of summation and integration in the Fourier summation formula ((1.8.3) and (1.8.4)):

$$1.17.17 \quad \frac{1}{2\pi} \sum_{k=-\infty}^{\infty} e^{-ika} \left( \int_{-\pi}^{\pi} \phi(x) e^{ikx} dx \right) = \phi(a),$$

yields

$$1.17.18 \quad \int_{-\pi}^{\pi} \phi(x) \left( \frac{1}{2\pi} \sum_{k=-\infty}^{\infty} e^{ik(x-a)} \right) dx = \phi(a).$$

The sum  $\sum_{k=-\infty}^{\infty} e^{ik(x-a)}$  does not converge, but (1.17.18) can be interpreted as a generalized integral in the sense that

$$1.17.19 \quad \lim_{n \rightarrow \infty} \int_{-\pi}^{\pi} \delta_n(x-a) \phi(x) dx = \phi(a),$$

where

$$1.17.20 \quad \delta_n(x-a) = \frac{1}{2\pi} \sum_{k=-n}^n e^{ik(x-a)} \left( = \frac{\sin((n+\frac{1}{2})(x-a))}{2\pi \sin(\frac{1}{2}(x-a))} \right),$$

provided that  $\phi(x)$  is continuous and of period  $2\pi$ ; see §1.8(ii).

By analogy with §1.17(ii) we have the formal series representation

$$1.17.21 \quad \delta(x-a) = \frac{1}{2\pi} \sum_{k=-\infty}^{\infty} e^{ik(x-a)}.$$

Other similar series representations of the Dirac delta that appear in the physics literature include the following:

**Legendre Polynomials** (§§14.7(i) and 18.3)

$$1.17.22 \quad \delta(x-a) = \sum_{k=0}^{\infty} (k+\frac{1}{2}) P_k(x) P_k(a).$$

**Laguerre Polynomials** (§18.3)

$$1.17.23 \quad \delta(x-a) = e^{-(x+a)/2} \sum_{k=0}^{\infty} L_k(x) L_k(a).$$

**Hermite Polynomials** (§18.3)

$$1.17.24 \quad \delta(x-a) = \frac{e^{-(x^2+a^2)/2}}{\sqrt{\pi}} \sum_{k=0}^{\infty} \frac{H_k(x) H_k(a)}{2^k k!}.$$

**Spherical Harmonics** (§14.30)

$$\delta(\cos \theta_1 - \cos \theta_2) \delta(\phi_1 - \phi_2) \\ 1.17.25 \quad = \sum_{\ell=0}^{\infty} \sum_{m=-\ell}^{\ell} Y_{\ell,m}(\theta_1, \phi_1) Y_{\ell,m}^*(\theta_2, \phi_2).$$

(1.17.22)–(1.17.24) are special cases of Morse and Feshbach (1953a, Eq. (6.3.11)). For (1.17.25) see Arfken and Weber (2005, p. 792).

**1.17(iv) Mathematical Definitions**

The references given in §§1.17(ii)–1.17(iii) are from the physics literature. For mathematical interpretations of (1.17.13), (1.17.15), (1.17.16) and (1.17.22)–(1.17.25) that resemble those given in §§1.17(ii) and 1.17(iii) for (1.17.12) and (1.17.21), see Li and Wong (2008). For (1.17.14) combine (1.17.13) and (10.47.3).

## References

### Sources

The following list gives the references or other indications of proofs that were used in constructing the various sections of this chapter. These sources supplement the references that are quoted in the text.

- §1.2 Chrystal (1959, pp. 62–70, 482–483, 489), Hardy *et al.* (1967, pp. 12–15).
- §1.3 Vein and Dale (1999, pp. 3–12, 33–34, 51–52, 57, 79–81), For (1.3.17) see Bressoud (1999, p. 67).
- §1.4 Hardy (1952, Chapters 5–7, and pp. 234–235, 247–248, 258, 285–292, 327–328), Olver (1997b, pp. 28, 73), Rudin (1976, Chapter 5), Hardy *et al.* (1967, pp. 70–77). For (1.4.13) see Riordan (1958, pp. 35–36) and Knuth (1968, p. 50). For (1.4.31) integrate by parts.
- §1.5 Marsden and Tromba (1996, Chapters 2, 3, 5, 6, and pp. 358–371), Davis and Snider (1987, Chapter 5), Protter and Morrey (1991, pp. 288, 298) For (1.5.36) see Love (1970, 1972a).
- §1.6 Marsden and Tromba (1996, Chapter 1 and pp. 144–147, 273–283, 396–417, 421–459, 470, 485, 506). For (1.6.9) see Hubbard and Hubbard (2002, pp. 82–84).
- §1.7 Hardy *et al.* (1967, pp. 1–32, 130–147, 151).
- §1.8 Protter and Morrey (1991, Chapter 10), Tolstov (1962, Chapter 1 and p. 77), Titchmarsh (1962, Chapter 13 and pp. 419, 421). For the Riemann–Lebesgue lemma see Olver (1997b, p. 73). For Poisson’s summation formula see Rademacher (1973, pp. 71–75), Titchmarsh (1986a, p. 61). For (1.8.16) set  $f(x) = e^{-\omega x^2}$  in (1.8.14).
- §1.9 Copson (1935, Chapters 1–3 and pp. 56–69, 92–98), Levinson and Redheffer (1970, Chapters 1–3, and pp. 259–277, 349–351, 360), Markushevich (1983, pp. 14–18, 41–46, 131–135), Markushevich (1985, vol. 1, §34), Ahlfors (1966, pp. 168–169). For a proof of the Jordan Curve Theorem see, for example, Dienes (1931, pp. 177–197). The theorem is valid with less restrictive conditions than those assumed here. For the operations on series, see Henrici (1974, Chapter 1) or Olver (1997b, pp. 19–22). For (1.9.69)–(1.9.71), see Titchmarsh (1962, §1.77).
- §1.10 Copson (1935, pp. 72–81, 106–113, 117–120, 192–193, 438–440), Levinson and Redheffer (1970, pp. 64–77, 140–143, 162–170, 392–395, 398–402), Markushevich (1983, pp. 106–121, 234–245), Titchmarsh (1962, pp. 13–19, 165–169, 246–250). For (1.10.13) and (1.10.14) see Copson (1935, §6.23). See also Andrews *et al.* (1999, pp. 629–631) and Henrici (1974, pp. 57–59). The Extended Inversion Theorem is proved in a similar way.
- §1.11 Burnside and Panton (1960, Chapter 2 and pp. 80–81), Dummit and Foote (1999, pp. 300–301, 591–595, 611–616), Henrici (1977, vol. 2, pp. 555–559). For the Horner scheme, see Burnside and Panton (1960, pp. 8–9). The double Horner scheme is derived similarly.
- §1.12 Jones and Thron (1980, pp. 20, 31–37, 42–43, 88, 92), Lorentzen and Waadeland (1992, pp. 8–9, 30, 32, 84–85).
- §1.13 Olver (1997b, pp. 141–142, 145–147, 190–191), Temme (1996a, pp. 84, 103), Watson (1944, pp. 145–146). For (1.13.10) see Simmons (1972, pp. 90–92).
- §1.14 Titchmarsh (1986a, pp. 3–15, 42, 50–60, 119–132, and 176–210), Schiff (1999, pp. 12–57, 91–93, 151–157, and 209–218), Paris and Kaminski (2001, pp. 79–89), Wong (1989, pp. 147–152 and 192–194), Henrici (1986, vol. 3, pp. 197–202), Widder (1941, pp. 325–328, 340–341), Davies (1984, pp. 11–13, 103–108, 152–153, 209–211), Pinkus and Zafrany (1997, pp. 147–149). For (1.14.46) see Sneddon (1972, p. 234).
- §1.15 Hardy (1949, pp. 10, 154–155), Weiss (1965, pp. 131–135, 143–148), Andrews *et al.* (1999, pp. 111–114, 602–607), Wong (1989, pp. 197–198), Widder (1941, Chapter 5). For (1.15.24) see Körner (1989, Chapters 2, 27).
- §1.16 Wong (1989, pp. 241–254, 261–279).
- §1.17 (1.17.6) is a special case of Theorem 7.1 of Olver (1997b, Chapter 3) when  $\phi(a) \neq 0$ . This theorem also extends straightforwardly to cover  $\phi(a) = 0$ . (1.17.7) is proved in a similar manner. For (1.17.10) complete the square in the total power of  $e$ , make the change of variable  $\tau = (t/(2\sqrt{n}) - i(x-a)\sqrt{n})$ , and use  $\int_{-\infty}^{\infty} e^{-\tau^2} d\tau = \sqrt{\pi}$ .





## Chapter 2

# Asymptotic Approximations

F. W. J. Olver<sup>1</sup> and R. Wong<sup>2</sup>

<b>Areas</b>	<b>42</b>	2.7	Differential Equations . . . . .	55	
2.1	Definitions and Elementary Properties . .	42	2.8	Differential Equations with a Parameter .	58
2.2	Transcendental Equations . . . . .	43	2.9	Difference Equations . . . . .	61
2.3	Integrals of a Real Variable . . . . .	43	2.10	Sums and Sequences . . . . .	63
2.4	Contour Integrals . . . . .	46	2.11	Remainder Terms; Stokes Phenomenon .	66
2.5	Mellin Transform Methods . . . . .	48	<b>References</b>	<b>69</b>	
2.6	Distributional Methods . . . . .	51			

<sup>1</sup>Institute for Physical Science and Technology and Department of Mathematics, University of Maryland, College Park, Maryland.

<sup>2</sup>Liu Bie Ju Centre for Mathematical Sciences, City University of Hong Kong, Kowloon, Hong Kong.

Copyright © 2009 National Institute of Standards and Technology. All rights reserved.

## Areas

### 2.1 Definitions and Elementary Properties

#### 2.1(i) Asymptotic and Order Symbols

Let  $\mathbf{X}$  be a point set with a limit point  $c$ . As  $x \rightarrow c$  in  $\mathbf{X}$

$$2.1.1 \quad f(x) \sim \phi(x) \iff f(x)/\phi(x) \rightarrow 1.$$

$$2.1.2 \quad f(x) = o(\phi(x)) \iff f(x)/\phi(x) \rightarrow 0.$$

$$2.1.3 \quad f(x) = O(\phi(x)) \iff |f(x)/\phi(x)| \text{ is bounded.}$$

The symbol  $O$  can also apply to the whole set  $\mathbf{X}$ , and not just as  $x \rightarrow c$ .

#### Examples

$$2.1.4 \quad \tanh x \sim x, \quad x \rightarrow 0 \text{ in } \mathbb{C}.$$

$$2.1.5 \quad e^{-x} = o(1), \quad x \rightarrow +\infty \text{ in } \mathbb{R}.$$

$$2.1.6 \quad \sin(\pi x + x^{-1}) = O(x^{-1}), \quad x \rightarrow \pm\infty \text{ in } \mathbb{Z}.$$

$$2.1.7 \quad e^{ix} = O(1), \quad x \in \mathbb{R}.$$

In (2.1.5)  $\mathbb{R}$  can be replaced by any fixed ray in the sector  $|\text{ph } x| < \frac{1}{2}\pi$ , or by the whole of the sector  $|\text{ph } x| \leq \frac{1}{2}\pi - \delta$ . (Here and elsewhere in this chapter  $\delta$  is an arbitrary small positive constant.) But (2.1.5) does not hold as  $x \rightarrow \infty$  in  $|\text{ph } x| < \frac{1}{2}\pi$  (for example, set  $x = 1 + it$  and let  $t \rightarrow \pm\infty$ .)

If  $\sum_{s=0}^{\infty} a_s z^s$  converges for all sufficiently small  $|z|$ , then for each nonnegative integer  $n$

$$2.1.8 \quad \sum_{s=n}^{\infty} a_s z^s = O(z^n), \quad z \rightarrow 0 \text{ in } \mathbb{C}.$$

#### Example

$$2.1.9 \quad e^z = 1 + z + O(z^2), \quad z \rightarrow 0 \text{ in } \mathbb{C}.$$

The symbols  $o$  and  $O$  can be used generically. For example,

$$2.1.10 \quad o(\phi) = O(\phi), \quad o(\phi) + o(\phi) = o(\phi),$$

it being understood that these equalities are not reversible. (In other words = here really means  $\subseteq$ .)

#### 2.1(ii) Integration and Differentiation

Integration of asymptotic and order relations is permissible, subject to obvious convergence conditions. For example, suppose  $f(x)$  is continuous and  $f(x) \sim x^\nu$  as  $x \rightarrow +\infty$  in  $\mathbb{R}$ , where  $\nu \in \mathbb{C}$  is a constant. Then

$$2.1.11 \quad \int_x^\infty f(t) dt \sim -\frac{x^{\nu+1}}{\nu+1}, \quad \Re \nu < -1,$$

$$2.1.12 \quad \int f(x) dx \sim \begin{cases} \text{a constant,} & \Re \nu < -1, \\ \ln x, & \nu = -1, \\ x^{\nu+1}/(\nu+1), & \Re \nu > -1. \end{cases}$$

Differentiation requires extra conditions. For example, if  $f(z)$  is analytic for all sufficiently large  $|z|$  in a sector  $\mathbf{S}$  and  $f(z) = O(z^\nu)$  as  $z \rightarrow \infty$  in  $\mathbf{S}$ ,  $\nu$  being real, then  $f'(z) = O(z^{\nu-1})$  as  $z \rightarrow \infty$  in any closed sector properly interior to  $\mathbf{S}$  and with the same vertex (*Ritt's theorem*). This result also holds with both  $O$ 's replaced by  $o$ 's.

#### 2.1(iii) Asymptotic Expansions

Let  $\sum a_s x^{-s}$  be a formal power series (convergent or divergent) and for each positive integer  $n$ ,

$$2.1.13 \quad f(x) = \sum_{s=0}^{n-1} a_s x^{-s} + O(x^{-n})$$

as  $x \rightarrow \infty$  in an unbounded set  $\mathbf{X}$  in  $\mathbb{R}$  or  $\mathbb{C}$ . Then  $\sum a_s x^{-s}$  is a *Poincaré asymptotic expansion*, or simply *asymptotic expansion*, of  $f(x)$  as  $x \rightarrow \infty$  in  $\mathbf{X}$ . Symbolically,

$$2.1.14 \quad f(x) \sim a_0 + a_1 x^{-1} + a_2 x^{-2} + \dots, \quad x \rightarrow \infty \text{ in } \mathbf{X}.$$

Condition (2.1.13) is equivalent to

$$2.1.15 \quad x^n \left( f(x) - \sum_{s=0}^{n-1} a_s x^{-s} \right) \rightarrow a_n, \quad x \rightarrow \infty \text{ in } \mathbf{X},$$

for each  $n = 0, 1, 2, \dots$ . If  $\sum a_s x^{-s}$  converges for all sufficiently large  $|x|$ , then it is automatically the asymptotic expansion of its sum as  $x \rightarrow \infty$  in  $\mathbb{C}$ .

If  $c$  is a finite limit point of  $\mathbf{X}$ , then

#### 2.1.16

$f(x) \sim a_0 + a_1(x-c) + a_2(x-c)^2 + \dots, \quad x \rightarrow c$  in  $\mathbf{X}$ , means that for each  $n$ , the difference between  $f(x)$  and the  $n$ th partial sum on the right-hand side is  $O((x-c)^n)$  as  $x \rightarrow c$  in  $\mathbf{X}$ .

Most operations on asymptotic expansions can be carried out in exactly the same manner as for convergent power series. These include addition, subtraction, multiplication, and division. Substitution, logarithms, and powers are also permissible; compare [Olver \(1997b, pp. 19–22\)](#). Differentiation, however, requires the kind of extra conditions needed for the  $O$  symbol (§2.1(ii)). For reversion see §2.2.

Asymptotic expansions of the forms (2.1.14), (2.1.16) are unique. But for any given set of coefficients  $a_0, a_1, a_2, \dots$ , and suitably restricted  $\mathbf{X}$  there is an infinity of analytic functions  $f(x)$  such that (2.1.14) and (2.1.16) apply. For (2.1.14)  $\mathbf{X}$  can be the positive real axis or any unbounded sector in  $\mathbb{C}$  of finite angle. As an example, in the sector  $|\text{ph } z| \leq \frac{1}{2}\pi - \delta$  ( $< \frac{1}{2}\pi$ ) each of the functions  $0, e^{-z}$ , and  $e^{-\sqrt{z}}$  (principal value) has the null asymptotic expansion

$$2.1.17 \quad 0 + 0 \cdot z^{-1} + 0 \cdot z^{-2} + \dots, \quad z \rightarrow \infty.$$

**2.1(iv) Uniform Asymptotic Expansions**

If the set  $\mathbf{X}$  in §2.1(iii) is a closed sector  $\alpha \leq \text{ph } x \leq \beta$ , then by definition the asymptotic property (2.1.13) holds uniformly with respect to  $\text{ph } x \in [\alpha, \beta]$  as  $|x| \rightarrow \infty$ . The asymptotic property may also hold uniformly with respect to parameters. Suppose  $u$  is a parameter (or set of parameters) ranging over a point set (or sets)  $\mathbf{U}$ , and for each nonnegative integer  $n$

$$\left| x^n \left( f(u, x) - \sum_{s=0}^{n-1} a_s(u) x^{-s} \right) \right|$$

is bounded as  $x \rightarrow \infty$  in  $\mathbf{X}$ , uniformly for  $u \in \mathbf{U}$ . (The coefficients  $a_s(u)$  may now depend on  $u$ .) Then

**2.1.18** 
$$f(u, x) \sim \sum_{s=0}^{\infty} a_s(u) x^{-s}$$

as  $x \rightarrow \infty$  in  $\mathbf{X}$ , uniformly with respect to  $u \in \mathbf{U}$ .

Similarly for finite limit point  $c$  in place of  $\infty$ .

**2.1(v) Generalized Asymptotic Expansions**

Let  $\phi_s(x)$ ,  $s = 0, 1, 2, \dots$ , be a sequence of functions defined in  $\mathbf{X}$  such that for each  $s$

**2.1.19** 
$$\phi_{s+1}(x) = o(\phi_s(x)), \quad x \rightarrow c \text{ in } \mathbf{X},$$
 where  $c$  is a finite, or infinite, limit point of  $\mathbf{X}$ . Then  $\{\phi_s(x)\}$  is an *asymptotic sequence* or *scale*. Suppose also that  $f(x)$  and  $f_s(x)$  satisfy

**2.1.20** 
$$f(x) = \sum_{s=0}^{n-1} f_s(x) + O(\phi_n(x)), \quad x \rightarrow c \text{ in } \mathbf{X},$$

for  $n = 0, 1, 2, \dots$ . Then  $\sum f_s(x)$  is a *generalized asymptotic expansion* of  $f(x)$  with respect to the scale  $\{\phi_s(x)\}$ . Symbolically,

**2.1.21** 
$$f(x) \sim \sum_{s=0}^{\infty} f_s(x); \{\phi_s(x)\}, \quad x \rightarrow c \text{ in } \mathbf{X}.$$

As in §2.1(iv), generalized asymptotic expansions can also have uniformity properties with respect to parameters. For an example see §14.15(i).

Care is needed in understanding and manipulating generalized asymptotic expansions. Many properties enjoyed by Poincaré expansions (for example, multiplication) do not always carry over. It can even happen that a generalized asymptotic expansion converges, but its sum is not the function being represented asymptotically; for an example see §18.15(iii).

**2.2 Transcendental Equations**

Let  $f(x)$  be continuous and strictly increasing when  $a < x < \infty$  and

**2.2.1** 
$$f(x) \sim x, \quad x \rightarrow \infty.$$

Then for  $y > f(a)$  the equation  $f(x) = y$  has a unique root  $x = x(y)$  in  $(a, \infty)$ , and

**2.2.2** 
$$x(y) \sim y, \quad y \rightarrow \infty.$$

**Example**

**2.2.3** 
$$t^2 - \ln t = y.$$

With  $x = t^2$ ,  $f(x) = x - \frac{1}{2} \ln x$ . We may take  $a = \frac{1}{2}$ . From (2.2.2)

**2.2.4** 
$$t = y^{\frac{1}{2}} (1 + o(1)), \quad y \rightarrow \infty.$$

Higher approximations are obtainable by successive re-substitutions. For example

**2.2.5** 
$$t^2 = y + \ln t = y + \frac{1}{2} \ln y + o(1),$$

and hence

**2.2.6** 
$$t = y^{\frac{1}{2}} \left( 1 + \frac{1}{4} y^{-1} \ln y + o(y^{-1}) \right), \quad y \rightarrow \infty.$$

An important case is the reversion of asymptotic expansions for zeros of special functions. In place of (2.2.1) assume that

**2.2.7** 
$$f(x) \sim x + f_0 + f_1 x^{-1} + f_2 x^{-2} + \dots, \quad x \rightarrow \infty.$$

Then

**2.2.8** 
$$x \sim y - F_0 - F_1 y^{-1} - F_2 y^{-2} - \dots, \quad y \rightarrow \infty,$$

where  $F_0 = f_0$  and  $sF_s$  ( $s \geq 1$ ) is the coefficient of  $x^{-1}$  in the asymptotic expansion of  $(f(x))^s$  (*Lagrange's formula for the reversion of series*). Conditions for the validity of the reversion process in  $\mathbb{C}$  are derived in Olver (1997b, pp. 14–16). Applications to real and complex zeros of Airy functions are given in Fabijonas and Olver (1999). For other examples see de Bruijn (1961, Chapter 2).

**2.3 Integrals of a Real Variable**

**2.3(i) Integration by Parts**

Assume that the Laplace transform

**2.3.1** 
$$\int_0^{\infty} e^{-xt} q(t) dt$$

converges for all sufficiently large  $x$ , and  $q(t)$  is infinitely differentiable in a neighborhood of the origin. Then

**2.3.2** 
$$\int_0^{\infty} e^{-xt} q(t) dt \sim \sum_{s=0}^{\infty} \frac{q^{(s)}(0)}{x^{s+1}}, \quad x \rightarrow +\infty.$$

If, in addition,  $q(t)$  is infinitely differentiable on  $[0, \infty)$  and

**2.3.3** 
$$\sigma_n = \sup_{(0, \infty)} (t^{-1} \ln |q^{(n)}(t)/q^{(n)}(0)|)$$

is finite and bounded for  $n = 0, 1, 2, \dots$ , then the  $n$ th *error term* (that is, the difference between the integral and  $n$ th partial sum in (2.3.2)) is bounded in absolute value by  $|q^{(n)}(0)/(x^n(x - \sigma_n))|$  when  $x$  exceeds both 0 and  $\sigma_n$ .

For the Fourier integral

$$\int_a^b e^{ixt} q(t) dt$$

assume  $a$  and  $b$  are finite, and  $q(t)$  is infinitely differentiable on  $[a, b]$ . Then

$$\begin{aligned} \int_a^b e^{ixt} q(t) dt &\sim e^{iax} \sum_{s=0}^{\infty} q^{(s)}(a) \left(\frac{i}{x}\right)^{s+1} \\ &\quad - e^{ibx} \sum_{s=0}^{\infty} q^{(s)}(b) \left(\frac{i}{x}\right)^{s+1}, \end{aligned} \quad x \rightarrow +\infty.$$

Alternatively, assume  $b = \infty$ ,  $q(t)$  is infinitely differentiable on  $[a, \infty)$ , and each of the integrals  $\int e^{ixt} q^{(s)}(t) dt$ ,  $s = 0, 1, 2, \dots$ , converges as  $t \rightarrow \infty$  uniformly for all sufficiently large  $x$ . Then

$$\int_a^{\infty} e^{ixt} q(t) dt \sim e^{iax} \sum_{s=0}^{\infty} q^{(s)}(a) \left(\frac{i}{x}\right)^{s+1}, \quad x \rightarrow +\infty.$$

In both cases the  $n$ th error term is bounded in absolute value by  $x^{-n} \mathcal{V}_{a,b}(q^{(n-1)}(t))$ , where the *variational operator*  $\mathcal{V}_{a,b}$  is defined by

$$\mathcal{V}_{a,b}(f(t)) = \int_a^b |f'(t)| dt;$$

see §1.4(v). For other examples, see Wong (1989, Chapter 1).

### 2.3(ii) Watson's Lemma

Assume again that the integral (2.3.1) converges for all sufficiently large  $x$ , but now

$$q(t) \sim \sum_{s=0}^{\infty} a_s t^{(s+\lambda-\mu)/\mu}, \quad t \rightarrow 0+,$$

where  $\lambda$  and  $\mu$  are positive constants. Then the series obtained by substituting (2.3.7) into (2.3.1) and integrating formally term by term yields an asymptotic expansion:

$$\int_0^{\infty} e^{-xt} q(t) dt \sim \sum_{s=0}^{\infty} \Gamma\left(\frac{s+\lambda}{\mu}\right) \frac{a_s}{x^{(s+\lambda)/\mu}}, \quad x \rightarrow +\infty.$$

For the function  $\Gamma$  see §5.2(i).

This result is probably the most frequently used method for deriving asymptotic expansions of special functions. Since  $q(t)$  need not be continuous (as long as the integral converges), the case of a finite integration range is included.

Other types of singular behavior in the integrand can be treated in an analogous manner. For example,

$$\begin{aligned} \int_0^{\infty} e^{-xt} q(t) \ln t dt &\sim \sum_{s=0}^{\infty} \Gamma'\left(\frac{s+\lambda}{\mu}\right) \frac{a_s}{x^{(s+\lambda)/\mu}} \\ &\quad - (\ln x) \sum_{s=0}^{\infty} \Gamma\left(\frac{s+\lambda}{\mu}\right) \frac{a_s}{x^{(s+\lambda)/\mu}}, \end{aligned}$$

provided that the integral on the left-hand side of (2.3.9) converges for all sufficiently large values of  $x$ . (In other words, differentiation of (2.3.8) with respect to the parameter  $\lambda$  (or  $\mu$ ) is legitimate.)

Another extension is to more general factors than the exponential function. In addition to (2.3.7) assume that  $f(t)$  and  $q(t)$  are piecewise continuous (§1.4(ii)) on  $(0, \infty)$ , and

$$|f(t)| \leq A \exp(-at^\kappa), \quad 0 \leq t < \infty,$$

$$q(t) = O(\exp(bt^\kappa)), \quad t \rightarrow +\infty,$$

where  $A, a, b, \kappa$  are positive constants. Then

$$\int_0^{\infty} f(xt) q(t) dt \sim \sum_{s=0}^{\infty} \mathcal{M}\left(f; \frac{s+\lambda}{\mu}\right) \frac{a_s}{x^{(s+\lambda)/\mu}}, \quad x \rightarrow +\infty,$$

where  $\mathcal{M}(f; \alpha)$  is the *Mellin transform* of  $f(t)$  (§2.5(i)).

For a more detailed treatment of the integral (2.3.12) see §§2.5, 2.6.

### 2.3(iii) Laplace's Method

When  $p(t)$  is real and  $x$  is a large positive parameter, the main contribution to the integral

$$I(x) = \int_a^b e^{-xp(t)} q(t) dt$$

derives from the neighborhood of the minimum of  $p(t)$  in the integration range. Without loss of generality, we assume that this minimum is at the left endpoint  $a$ . Furthermore:

- $p'(t)$  and  $q(t)$  are continuous in a neighborhood of  $a$ , save possibly at  $a$ , and the minimum of  $p(t)$  in  $[a, b]$  is approached only at  $a$ .
- As  $t \rightarrow a+$

$$p(t) \sim p(a) + \sum_{s=0}^{\infty} p_s (t-a)^{s+\mu},$$

2.3.14

$$q(t) \sim \sum_{s=0}^{\infty} q_s (t-a)^{s+\lambda-1},$$

and the expansion for  $p(t)$  is differentiable. Again  $\lambda$  and  $\mu$  are positive constants. Also  $p_0 > 0$  (consistent with (a)).

- The integral (2.3.13) converges absolutely for all sufficiently large  $x$ .

Then

**2.3.15**

$$\int_a^b e^{-xp(t)} q(t) dt \sim e^{-xp(a)} \sum_{s=0}^{\infty} \Gamma\left(\frac{s+\lambda}{\mu}\right) \frac{b_s}{x^{(s+\lambda)/\mu}},$$

$x \rightarrow +\infty,$

where the coefficients  $b_s$  are defined by the expansion

$$\frac{q(t)}{p'(t)} \sim \sum_{s=0}^{\infty} b_s v^{(s+\lambda-\mu)/\mu}, \quad v \rightarrow 0+,$$

in which  $v = p(t) - p(a)$ . For example,

$$\begin{aligned} b_0 &= \frac{q_0}{\mu p_0^{\lambda/\mu}}, \\ b_1 &= \left( \frac{q_1}{\mu} - \frac{(\lambda+1)p_1 q_0}{\mu^2 p_0} \right) \frac{1}{p_0^{(\lambda+1)/\mu}}, \\ b_2 &= \left( \frac{q_2}{\mu} - \frac{(\lambda+2)(p_1 q_1 + p_2 q_0)}{\mu^2 p_0} \right. \\ &\quad \left. + \frac{(\lambda+2)(\lambda+\mu+2)p_1^2 q_0}{2\mu^3 p_0^2} \right) \frac{1}{p_0^{(\lambda+2)/\mu}}. \end{aligned}$$

In general

**2.3.18**

$$b_s = \frac{1}{\mu} \operatorname{res}_{t=a} \left[ \frac{q(t)}{(p(t) - p(a))^{(\lambda+s)/\mu}} \right], \quad s = 0, 1, 2, \dots$$

Watson's lemma can be regarded as a special case of this result.

For error bounds for Watson's lemma and Laplace's method see Boyd (1993) and Olver (1997b, Chapter 3). These references and Wong (1989, Chapter 2) also contain examples.

### 2.3(iv) Method of Stationary Phase

When the parameter  $x$  is large the contributions from the real and imaginary parts of the integrand in

$$I(x) = \int_a^b e^{ixp(t)} q(t) dt$$

oscillate rapidly and cancel themselves over most of the range. However, cancellation does not take place near the endpoints, owing to lack of symmetry, nor in the neighborhoods of zeros of  $p'(t)$  because  $p(t)$  changes relatively slowly at these stationary points.

The first result is the analog of Watson's lemma (§2.3(ii)). Assume that  $q(t)$  again has the expansion (2.3.7) and this expansion is infinitely differentiable,  $q(t)$  is infinitely differentiable on  $(0, \infty)$ , and each of the integrals  $\int e^{ixt} q^{(s)}(t) dt$ ,  $s = 0, 1, 2, \dots$ , converges at  $t = \infty$ , uniformly for all sufficiently large  $x$ . Then

$$\begin{aligned} &\int_0^{\infty} e^{ixt} q(t) dt \\ \text{2.3.20} \quad &\sim \sum_{s=0}^{\infty} \exp\left(\frac{(s+\lambda)\pi i}{2\mu}\right) \Gamma\left(\frac{s+\lambda}{\mu}\right) \frac{a_s}{x^{(s+\lambda)/\mu}}, \end{aligned}$$

$x \rightarrow +\infty,$

where the coefficients  $a_s$  are given by (2.3.7).

For the more general integral (2.3.19) we assume, without loss of generality, that the stationary point (if any) is at the left endpoint. Furthermore:

- (a) On  $(a, b)$ ,  $p(t)$  and  $q(t)$  are infinitely differentiable and  $p'(t) > 0$ .
- (b) As  $t \rightarrow a+$  the asymptotic expansions (2.3.14) apply, and each is infinitely differentiable. Again  $\lambda$ ,  $\mu$ , and  $p_0$  are positive.
- (c) If the limit  $p(b)$  of  $p(t)$  as  $t \rightarrow b-$  is finite, then each of the functions

$$\text{2.3.21} \quad P_s(t) = \left( \frac{1}{p'(t)} \frac{d}{dt} \right)^s \frac{q(t)}{p'(t)}, \quad s = 0, 1, 2, \dots,$$

tends to a finite limit  $P_s(b)$ .

- (d) If  $p(b) = \infty$ , then  $P_0(b) = 0$  and each of the integrals

$$\text{2.3.22} \quad \int e^{ixp(t)} P_s(t) p'(t) dt, \quad s = 0, 1, 2, \dots,$$

converges at  $t = b$  uniformly for all sufficiently large  $x$ .

If  $p(b)$  is finite, then both endpoints contribute:

**2.3.23**

$$\begin{aligned} &\int_a^b e^{ixp(t)} q(t) dt \\ &\sim e^{ixp(a)} \sum_{s=0}^{\infty} \exp\left(\frac{(s+\lambda)\pi i}{2\mu}\right) \Gamma\left(\frac{s+\lambda}{\mu}\right) \frac{b_s}{x^{(s+\lambda)/\mu}} \\ &\quad - e^{ixp(b)} \sum_{s=0}^{\infty} P_s(b) \left(\frac{i}{x}\right)^{s+1}, \end{aligned}$$

$x \rightarrow +\infty.$

But if (d) applies, then the second sum is absent. The coefficients  $b_s$  are defined as in §2.3(iii).

For proofs of the results of this subsection, error bounds, and an example, see Olver (1974). For other estimates of the error term see Lyness (1971). For extensions to oscillatory integrals with logarithmic singularities see Wong and Lin (1978).

### 2.3(v) Coalescing Peak and Endpoint: Bleistein's Method

In the integral

$$\text{2.3.24} \quad I(\alpha, x) = \int_0^k e^{-xp(\alpha, t)} q(\alpha, t) t^{\lambda-1} dt$$

$k$  ( $\leq \infty$ ) and  $\lambda$  are positive constants,  $\alpha$  is a variable parameter in an interval  $\alpha_1 \leq \alpha \leq \alpha_2$  with  $\alpha_1 \leq 0$  and  $0 < \alpha_2 \leq k$ , and  $x$  is a large positive parameter. Assume also that  $\partial^2 p(\alpha, t) / \partial t^2$  and  $q(\alpha, t)$  are continuous in  $\alpha$  and  $t$ , and for each  $\alpha$  the minimum value of  $p(\alpha, t)$

in  $[0, k]$  is at  $t = \alpha$ , at which point  $\partial p(\alpha, t)/\partial t$  vanishes, but both  $\partial^2 p(\alpha, t)/\partial t^2$  and  $q(\alpha, t)$  are nonzero. When  $x \rightarrow +\infty$  Laplace's method (§2.3(iii)) applies, but the form of the resulting approximation is discontinuous at  $\alpha = 0$ . In consequence, the approximation is nonuniform with respect to  $\alpha$  and deteriorates severely as  $\alpha \rightarrow 0$ .

A uniform approximation can be constructed by quadratic change of integration variable:

$$2.3.25 \quad p(\alpha, t) = \frac{1}{2}w^2 - aw + b,$$

where  $a$  and  $b$  are functions of  $\alpha$  chosen in such a way that  $t = 0$  corresponds to  $w = 0$ , and the stationary points  $t = \alpha$  and  $w = a$  correspond. Thus

$$2.3.26 \quad a = (2p(\alpha, 0) - 2p(\alpha, \alpha))^{1/2}, \quad b = p(\alpha, 0),$$

2.3.27

$w = (2p(\alpha, 0) - 2p(\alpha, \alpha))^{1/2} \pm (2p(\alpha, t) - 2p(\alpha, \alpha))^{1/2}$ , the upper or lower sign being taken according as  $t \gtrless \alpha$ . The relationship between  $t$  and  $w$  is one-to-one, and because

$$2.3.28 \quad \frac{dw}{dt} = \pm \frac{1}{(2p(\alpha, t) - 2p(\alpha, \alpha))^{1/2}} \frac{\partial p(\alpha, t)}{\partial t}$$

it is free from singularity at  $t = \alpha$ .

The integral (2.3.24) transforms into

2.3.29

$$I(\alpha, x) = e^{-xp(\alpha, 0)} \times \int_0^\kappa \exp(-x(\frac{1}{2}w^2 - aw)) f(\alpha, w) w^{\lambda-1} dw,$$

where

$$2.3.30 \quad f(\alpha, w) = q(\alpha, t) \left(\frac{t}{w}\right)^{\lambda-1} \frac{dt}{dw},$$

$\kappa = \kappa(\alpha)$  being the value of  $w$  at  $t = k$ . We now expand  $f(\alpha, w)$  in a Taylor series centered at the peak value  $w = a$  of the exponential factor in the integrand:

$$2.3.31 \quad f(\alpha, w) = \sum_{s=0}^{\infty} \phi_s(\alpha) (w-a)^s,$$

with the coefficients  $\phi_s(\alpha)$  continuous at  $\alpha = 0$ . The desired uniform expansion is then obtained formally as in Watson's lemma and Laplace's method. We replace the limit  $\kappa$  by  $\infty$  and integrate term-by-term:

$$2.3.32 \quad I(\alpha, x) \sim \frac{e^{-xp(\alpha, 0)}}{x^{\lambda/2}} \sum_{s=0}^{\infty} \phi_s(\alpha) \frac{F_s(a\sqrt{x})}{x^{s/2}}, \quad x \rightarrow \infty,$$

where

$$2.3.33 \quad F_s(y) = \int_0^\infty \exp(-\frac{1}{2}\tau^2 + y\tau) (\tau - y)^s \tau^{\lambda-1} d\tau.$$

For examples and proofs see Olver (1997b, Chapter 9), Bleistein (1966), Bleistein and Handelsman (1975, Chapter 9), and Wong (1989, Chapter 7).

## 2.4 Contour Integrals

### 2.4(i) Watson's Lemma

The result in §2.3(ii) carries over to a complex parameter  $z$ . Except that  $\lambda$  is now permitted to be complex, with  $\Re \lambda > 0$ , we assume the same conditions on  $q(t)$  and also that the Laplace transform in (2.3.8) converges for all sufficiently large values of  $\Re z$ . Then

$$2.4.1 \quad \int_0^\infty e^{-zt} q(t) dt \sim \sum_{s=0}^{\infty} \Gamma\left(\frac{s+\lambda}{\mu}\right) \frac{a_s}{z^{(s+\lambda)/\mu}}$$

as  $z \rightarrow \infty$  in the sector  $|\text{ph } z| \leq \frac{1}{2}\pi - \delta$  ( $< \frac{1}{2}\pi$ ), with  $z^{(s+\lambda)/\mu}$  assigned its principal value.

If  $q(t)$  is analytic in a sector  $\alpha_1 < \text{ph } t < \alpha_2$  containing  $\text{ph } t = 0$ , then the region of validity may be increased by rotation of the integration paths. We assume that in any closed sector with vertex  $t = 0$  and properly interior to  $\alpha_1 < \text{ph } t < \alpha_2$ , the expansion (2.3.7) holds as  $t \rightarrow 0$ , and  $q(t) = O(e^{\sigma|t|})$  as  $t \rightarrow \infty$ , where  $\sigma$  is a constant. Then (2.4.1) is valid in any closed sector with vertex  $z = 0$  and properly interior to  $-\alpha_2 - \frac{1}{2}\pi < \text{ph } z < -\alpha_1 + \frac{1}{2}\pi$ . (The branches of  $t^{(s+\lambda-\mu)/\mu}$  and  $z^{(s+\lambda)/\mu}$  are extended by continuity.)

For examples and extensions (including uniformity and loop integrals) see Olver (1997b, Chapter 4), Wong (1989, Chapter 1), and Temme (1985).

### 2.4(ii) Inverse Laplace Transforms

On the interval  $0 < t < \infty$  let  $q(t)$  be differentiable and  $e^{-ct}q(t)$  be absolutely integrable, where  $c$  is a real constant. Then the Laplace transform

$$2.4.2 \quad Q(z) = \int_0^\infty e^{-zt} q(t) dt$$

is continuous in  $\Re z \geq c$  and analytic in  $\Re z > c$ , and by inversion (§1.14(iii))

$$2.4.3 \quad q(t) = \frac{1}{2\pi i} \lim_{\eta \rightarrow \infty} \int_{\sigma-i\eta}^{\sigma+i\eta} e^{tz} Q(z) dz, \quad 0 < t < \infty,$$

where  $\sigma$  ( $\geq c$ ) is a constant.

Now assume that  $c > 0$  and we are given a function  $Q(z)$  that is both analytic and has the expansion

$$2.4.4 \quad Q(z) \sim \sum_{s=0}^{\infty} \Gamma\left(\frac{s+\lambda}{\mu}\right) \frac{a_s}{z^{(s+\lambda)/\mu}}, \quad z \rightarrow \infty,$$

in the half-plane  $\Re z \geq c$ . Here  $\Re \lambda > 0$ ,  $\mu > 0$ , and  $z^{(s+\lambda)/\mu}$  has its principal value. Assume also (2.4.4) is differentiable. Then by integration by parts the integral

$$2.4.5 \quad q(t) = \frac{1}{2\pi i} \int_{\sigma-i\infty}^{\sigma+i\infty} e^{tz} Q(z) dz, \quad 0 < t < \infty,$$

is seen to converge absolutely at each limit, and be independent of  $\sigma \in [c, \infty)$ . Furthermore, as  $t \rightarrow 0+$ ,  $q(t)$  has the expansion (2.3.7).

For large  $t$ , the asymptotic expansion of  $q(t)$  may be obtained from (2.4.3) by *Haar's method*. This depends on the availability of a comparison function  $F(z)$  for  $Q(z)$  that has an inverse transform

$$2.4.6 \quad f(t) = \frac{1}{2\pi i} \lim_{\eta \rightarrow \infty} \int_{\sigma - i\eta}^{\sigma + i\eta} e^{tz} F(z) dz$$

with known asymptotic behavior as  $t \rightarrow +\infty$ . By subtraction from (2.4.3)

$$2.4.7 \quad q(t) - f(t) = \frac{e^{\sigma t}}{2\pi} \lim_{\eta \rightarrow \infty} \int_{-\eta}^{\eta} e^{it\tau} (Q(\sigma + i\tau) - F(\sigma + i\tau)) d\tau.$$

If this integral converges uniformly at each limit for all sufficiently large  $t$ , then by the Riemann–Lebesgue lemma (§1.8(i))

$$2.4.8 \quad q(t) = f(t) + o(e^{ct}), \quad t \rightarrow +\infty.$$

If, in addition, the corresponding integrals with  $Q$  and  $F$  replaced by their derivatives  $Q^{(j)}$  and  $F^{(j)}$ ,  $j = 1, 2, \dots, m$ , converge uniformly, then by repeated integrations by parts

$$2.4.9 \quad q(t) = f(t) + o(t^{-m} e^{ct}), \quad t \rightarrow +\infty.$$

The most successful results are obtained on moving the integration contour as far to the left as possible. For examples see Olver (1997b, pp. 315–320).

### 2.4(iii) Laplace's Method

Let  $\mathcal{P}$  denote the path for the contour integral

$$2.4.10 \quad I(z) = \int_a^b e^{-zp(t)} q(t) dt,$$

in which  $a$  is finite,  $b$  is finite or infinite, and  $\omega$  is the angle of slope of  $\mathcal{P}$  at  $a$ , that is,  $\lim(\text{ph}(t-a))$  as  $t \rightarrow a$  along  $\mathcal{P}$ . Assume that  $p(t)$  and  $q(t)$  are analytic on an open domain  $\mathbf{T}$  that contains  $\mathcal{P}$ , with the possible exceptions of  $t = a$  and  $t = b$ . Other assumptions are:

- (a) In a neighborhood of  $a$

$$p(t) = p(a) + \sum_{s=0}^{\infty} p_s (t-a)^{s+\mu},$$

2.4.11

$$q(t) = \sum_{s=0}^{\infty} q_s (t-a)^{s+\lambda-1},$$

with  $\Re\lambda > 0$ ,  $\mu > 0$ ,  $p_0 \neq 0$ , and the branches of  $(t-a)^\lambda$  and  $(t-a)^\mu$  continuous and constructed with  $\text{ph}(t-a) \rightarrow \omega$  as  $t \rightarrow a$  along  $\mathcal{P}$ .

- (b)  $z$  ranges along a ray or over an annular sector  $\theta_1 \leq \theta \leq \theta_2$ ,  $|z| \geq Z$ , where  $\theta = \text{ph} z$ ,  $\theta_2 - \theta_1 < \pi$ , and  $Z > 0$ .  $I(z)$  converges at  $b$  absolutely and uniformly with respect to  $z$ .

- (c) Excluding  $t = a$ ,  $\Re(e^{i\theta} p(t) - e^{i\theta} p(a))$  is positive when  $t \in \mathcal{P}$ , and is bounded away from zero uniformly with respect to  $\theta \in [\theta_1, \theta_2]$  as  $t \rightarrow b$  along  $\mathcal{P}$ .

Then

$$2.4.12 \quad I(z) \sim e^{-zp(a)} \sum_{s=0}^{\infty} \Gamma\left(\frac{s+\lambda}{\mu}\right) \frac{b_s}{z^{(s+\lambda)/\mu}}$$

as  $z \rightarrow \infty$  in the sector  $\theta_1 \leq \text{ph} z \leq \theta_2$ . The coefficients  $b_s$  are determined as in §2.3(iii), the branch of  $\text{ph} p_0$  being chosen to satisfy

$$2.4.13 \quad |\theta + \mu\omega + \text{ph} p_0| \leq \frac{1}{2}\pi.$$

For examples see Olver (1997b, Chapter 4). For error bounds see Boyd (1993).

### 2.4(iv) Saddle Points

Now suppose that in (2.4.10) the minimum of  $\Re(zp(t))$  on  $\mathcal{P}$  occurs at an interior point  $t_0$ . Temporarily assume that  $\theta (= \text{ph} z)$  is fixed, so that  $t_0$  is independent of  $z$ . We may subdivide

$$2.4.14 \quad I(z) = \int_{t_0}^b e^{-zp(t)} q(t) dt - \int_{t_0}^a e^{-zp(t)} q(t) dt,$$

and apply the result of §2.4(iii) to each integral on the right-hand side, the role of the series (2.4.11) being played by the Taylor series of  $p(t)$  and  $q(t)$  at  $t = t_0$ . If  $p'(t_0) \neq 0$ , then  $\mu = 1$ ,  $\lambda$  is a positive integer, and the two resulting asymptotic expansions are identical. Thus the right-hand side of (2.4.14) reduces to the error terms. However, if  $p'(t_0) = 0$ , then  $\mu \geq 2$  and different branches of some of the fractional powers of  $p_0$  are used for the coefficients  $b_s$ ; again see §2.3(iii). In consequence, the asymptotic expansion obtained from (2.4.14) is no longer null.

Zeros of  $p'(t)$  are called *saddle points* (or *cols*) owing to the shape of the surface  $|p(t)|$ ,  $t \in \mathbb{C}$ , in their vicinity. Cases in which  $p'(t_0) \neq 0$  are usually handled by deforming the integration path in such a way that the minimum of  $\Re(zp(t))$  is attained at a saddle point or at an endpoint. Additionally, it may be advantageous to arrange that  $\Im(zp(t))$  is constant on the path: this will usually lead to greater regions of validity and sharper error bounds. Paths on which  $\Im(zp(t))$  is constant are also the ones on which  $|\exp(-zp(t))|$  decreases most rapidly. For this reason the name *method of steepest descents* is often used. However, for the purpose of simply deriving the asymptotic expansions the use of steepest descent paths is not essential.

In the commonest case the interior minimum  $t_0$  of  $\Re(zp(t))$  is a simple zero of  $p'(t)$ . The final expansion



then has the form

**2.4.15**

$$\int_a^b e^{-zp(t)} q(t) dt \sim 2e^{-zp(t_0)} \sum_{s=0}^{\infty} \Gamma(s + \frac{1}{2}) \frac{b_{2s}}{z^{s+(1/2)}},$$

in which

**2.4.16**

$$b_0 = \frac{q}{(2p'')^{1/2}},$$

$$b_2 = \left( 2q'' - \frac{2p'''q'}{p''} + \left( \frac{5(p''')^2}{6(p'')^2} - \frac{p^{iv}}{2p''} \right) q \right) \frac{1}{(2p'')^{3/2}},$$

with  $p, q$  and their derivatives evaluated at  $t_0$ . The branch of  $\omega_0 = \text{ph}(p''(t_0))$  is the one satisfying  $|\theta + 2\omega + \omega_0| \leq \frac{1}{2}\pi$ , where  $\omega$  is the limiting value of  $\text{ph}(t - t_0)$  as  $t \rightarrow t_0$  from  $b$ .

Higher coefficients  $b_{2s}$  in (2.4.15) can be found from (2.3.18) with  $\lambda = 1$ ,  $\mu = 2$ , and  $s$  replaced by  $2s$ . For integral representations of the  $b_{2s}$  and their asymptotic behavior as  $s \rightarrow \infty$  see Boyd (1995). The last reference also includes examples, as do Olver (1997b, Chapter 4), Wong (1989, Chapter 2), and Bleistein and Handelsman (1975, Chapter 7).

### 2.4(v) Coalescing Saddle Points: Chester, Friedman, and Ursell's Method

Consider the integral

$$2.4.17 \quad I(\alpha, z) = \int_{\mathcal{P}} e^{-zp(\alpha, t)} q(\alpha, t) dt$$

in which  $z$  is a large real or complex parameter,  $p(\alpha, t)$  and  $q(\alpha, t)$  are analytic functions of  $t$  and continuous in  $t$  and a second parameter  $\alpha$ . Suppose that on the integration path  $\mathcal{P}$  there are two simple zeros of  $\partial p(\alpha, t)/\partial t$  that coincide for a certain value  $\hat{\alpha}$  of  $\alpha$ . The problem of obtaining an asymptotic approximation to  $I(\alpha, z)$  that is uniform with respect to  $\alpha$  in a region containing  $\hat{\alpha}$  is similar to the problem of a coalescing endpoint and saddle point outlined in §2.3(v).

The change of integration variable is given by

$$2.4.18 \quad p(\alpha, t) = \frac{1}{3}w^3 + aw^2 + bw + c,$$

with  $a$  and  $b$  chosen so that the zeros of  $\partial p(\alpha, t)/\partial t$  correspond to the zeros  $w_1(\alpha), w_2(\alpha)$ , say, of the quadratic  $w^2 + 2aw + b$ . Then

**2.4.19**

$$I(\alpha, z) = e^{-cz} \int_{\mathcal{Q}} \exp(-z(\frac{1}{3}w^3 + aw^2 + bw)) f(\alpha, w) dw,$$

where  $\mathcal{Q}$  is the  $w$ -map of  $\mathcal{P}$ , and

$$2.4.20 \quad f(\alpha, w) = q(\alpha, t) \frac{dt}{dw} = q(\alpha, t) \frac{w^2 + 2aw + b}{\partial p(\alpha, t)/\partial t}.$$

The function  $f(\alpha, w)$  is analytic at  $w = w_1(\alpha)$  and  $w = w_2(\alpha)$  when  $\alpha \neq \hat{\alpha}$ , and at the confluence of these

points when  $\alpha = \hat{\alpha}$ . For large  $|z|$ ,  $I(\alpha, z)$  is approximated uniformly by the integral that corresponds to (2.4.19) when  $f(\alpha, w)$  is replaced by a constant. By making a further change of variable

$$2.4.21 \quad w = z^{-1/3}v - a,$$

and assigning an appropriate value to  $c$  to modify the contour, the approximating integral is reducible to an Airy function or a Scorer function (§§9.2, 9.12).

For examples, proofs, and extensions see Olver (1997b, Chapter 9), Wong (1989, Chapter 7), Olde Daalhuis and Temme (1994), Chester *et al.* (1957), and Bleistein and Handelsman (1975, Chapter 9).

For a symbolic method for evaluating the coefficients in the asymptotic expansions see Vidūnas and Temme (2002).

### 2.4(vi) Other Coalescing Critical Points

The problems sketched in §§2.3(v) and 2.4(v) involve only two of many possibilities for the coalescence of endpoints, saddle points, and singularities in integrals associated with the special functions. For a coalescing saddle point and a pole see Wong (1989, Chapter 7) and van der Waerden (1951); in this case the uniform approximants are complementary error functions. For a coalescing saddle point and endpoint see Olver (1997b, Chapter 9) and Wong (1989, Chapter 7); if the endpoint is an algebraic singularity then the uniform approximants are parabolic cylinder functions with fixed parameter, and if the endpoint is not a singularity then the uniform approximants are complementary error functions.

For two coalescing saddle points and an endpoint see Leubner and Ritsch (1986). For two coalescing saddle points and an algebraic singularity see Temme (1986), Jin and Wong (1998). For a coalescing saddle point, a pole, and a branch point see Ciarkowski (1989). For many coalescing saddle points see §36.12. For double integrals with two coalescing stationary points see Qiu and Wong (2000).

## 2.5 Mellin Transform Methods

### 2.5(i) Introduction

Let  $f(t)$  be a *locally integrable* function on  $(0, \infty)$ , that is,  $\int_{\rho}^T f(t) dt$  exists for all  $\rho$  and  $T$  satisfying  $0 < \rho < T < \infty$ . The *Mellin transform* of  $f(t)$  is defined by

$$2.5.1 \quad \mathcal{M}(f; z) = \int_0^{\infty} t^{z-1} f(t) dt,$$

when this integral converges. The domain of analyticity of  $\mathcal{M}(f; z)$  is usually an infinite strip  $a < \Re z < b$  parallel to the imaginary axis. The inversion formula is given by

$$2.5.2 \quad f(t) = \frac{1}{2\pi i} \int_{c-i\infty}^{c+i\infty} t^{-z} \mathcal{M}(f; z) dz,$$

with  $a < c < b$ .

One of the two convolution integrals associated with the Mellin transform is of the form

$$2.5.3 \quad I(x) = \int_0^\infty f(t) h(xt) dt, \quad x > 0,$$

and

$$2.5.4 \quad \mathcal{M}(I; z) = \mathcal{M}(f; 1-z) \mathcal{M}(h; z).$$

If  $\mathcal{M}(f; 1-z)$  and  $\mathcal{M}(h; z)$  have a common strip of analyticity  $a < \Re z < b$ , then

$$2.5.5 \quad I(x) = \frac{1}{2\pi i} \int_{c-i\infty}^{c+i\infty} x^{-z} \mathcal{M}(f; 1-z) \mathcal{M}(h; z) dz,$$

where  $a < c < b$ . When  $x = 1$ , this identity is a Parseval-type formula; compare §1.14(iv).

If  $\mathcal{M}(f; 1-z)$  and  $\mathcal{M}(h; z)$  can be continued analytically to meromorphic functions in a left half-plane, and if the contour  $\Re z = c$  can be translated to  $\Re z = d$  with  $d < c$ , then

$$2.5.6 \quad I(x) = \sum_{d < \Re z < c} \operatorname{res} [x^{-z} \mathcal{M}(f; 1-z) \mathcal{M}(h; z)] + E(x),$$

where

$$2.5.7 \quad E(x) = \frac{1}{2\pi i} \int_{d-i\infty}^{d+i\infty} x^{-z} \mathcal{M}(f; 1-z) \mathcal{M}(h; z) dz.$$

The sum in (2.5.6) is taken over all poles of  $x^{-z} \mathcal{M}(f; 1-z) \mathcal{M}(h; z)$  in the strip  $d < \Re z < c$ , and it provides the asymptotic expansion of  $I(x)$  for small values of  $x$ . Similarly, if  $\mathcal{M}(f; 1-z)$  and  $\mathcal{M}(h; z)$  can be continued analytically to meromorphic functions in a right half-plane, and if the vertical line of integration can be translated to the right, then we obtain an asymptotic expansion for  $I(x)$  for large values of  $x$ .

**Example**

$$2.5.8 \quad I(x) = \int_0^\infty \frac{J_\nu^2(xt)}{1+t} dt, \quad \nu > -\frac{1}{2},$$

where  $J_\nu$  denotes the Bessel function (§10.2(ii)), and  $x$  is a large positive parameter. Let  $h(t) = J_\nu^2(t)$  and  $f(t) = 1/(1+t)$ . Then from Table 1.14.5 and Watson (1944, p. 403)

$$2.5.9 \quad \mathcal{M}(f; 1-z) = \frac{\pi}{\sin(\pi z)}, \quad 0 < \Re z < 1,$$

$$2.5.10 \quad \mathcal{M}(h; z) = \frac{2^{z-1} \Gamma(\nu + \frac{1}{2}z)}{\Gamma^2(1 - \frac{1}{2}z) \Gamma(1 + \nu - \frac{1}{2}z)} \frac{\pi}{\Gamma(z) \sin(\pi z)}, \quad -2\nu < \Re z < 1.$$

In the half-plane  $\Re z > \max(0, -2\nu)$ , the product  $\mathcal{M}(f; 1-z) \mathcal{M}(h; z)$  has a pole of order two at each positive integer, and

$$2.5.11 \quad \operatorname{res}_{z=n} [x^{-z} \mathcal{M}(f; 1-z) \mathcal{M}(h; z)] = (a_n \ln x + b_n) x^{-n},$$

where

$$2.5.12 \quad a_n = \frac{2^{n-1} \Gamma(\nu + \frac{1}{2}n)}{\Gamma^2(1 - \frac{1}{2}n) \Gamma(1 + \nu - \frac{1}{2}n) \Gamma(n)},$$

$$2.5.13 \quad b_n = -a_n (\ln 2 + \frac{1}{2} \psi(\nu + \frac{1}{2}n) + \psi(1 - \frac{1}{2}n) + \frac{1}{2} \psi(1 + \nu - \frac{1}{2}n) - \psi(n)),$$

and  $\psi$  is the logarithmic derivative of the gamma function (§5.2(i)).

We now apply (2.5.5) with  $\max(0, -2\nu) < c < 1$ , and then translate the integration contour to the right. This is allowable in view of the asymptotic formula

$$2.5.14 \quad |\Gamma(x + iy)| = \sqrt{2\pi} e^{-\pi|y|/2} |y|^{x-(1/2)} (1 + o(1)),$$

as  $y \rightarrow \pm\infty$ , uniformly for bounded  $|x|$ ; see (5.11.9). Then as in (2.5.6) and (2.5.7), with  $d = 2n + 1 - \epsilon$  ( $0 < \epsilon < 1$ ), we obtain

$$2.5.15 \quad I(x) = - \sum_{s=0}^{2n} (a_s \ln x + b_s) x^{-s} + O(x^{-2n-1+\epsilon}), \quad n = 0, 1, 2, \dots$$

From (2.5.12) and (2.5.13), it is seen that  $a_s = b_s = 0$  when  $s$  is even. Hence

$$2.5.16 \quad I(x) = \sum_{s=0}^{n-1} (c_s \ln x + d_s) x^{-2s-1} + O(x^{-2n-1+\epsilon}),$$

where  $c_s = -a_{2s+1}$ ,  $d_s = -b_{2s+1}$ .

**2.5(ii) Extensions**

Let  $f(t)$  and  $h(t)$  be locally integrable on  $(0, \infty)$  and

$$2.5.17 \quad f(t) \sim \sum_{s=0}^{\infty} a_s t^{\alpha_s}, \quad t \rightarrow 0+,$$

where  $\Re \alpha_s > \Re \alpha_{s'}$  for  $s > s'$ , and  $\Re \alpha_s \rightarrow +\infty$  as  $s \rightarrow \infty$ . Also, let

$$2.5.18 \quad h(t) \sim \exp(i\kappa t^p) \sum_{s=0}^{\infty} b_s t^{-\beta_s}, \quad t \rightarrow +\infty,$$

where  $\kappa$  is real,  $p > 0$ ,  $\Re \beta_s > \Re \beta_{s'}$  for  $s > s'$ , and  $\Re \beta_s \rightarrow +\infty$  as  $s \rightarrow \infty$ . To ensure that the integral (2.5.3) converges we assume that

$$2.5.19 \quad f(t) = O(t^{-b}), \quad t \rightarrow +\infty,$$

with  $b + \Re \beta_0 > 1$ , and

$$2.5.20 \quad h(t) = O(t^c), \quad t \rightarrow 0+,$$

with  $c + \Re \alpha_0 > -1$ . To apply the Mellin transform method outlined in §2.5(i), we require the transforms  $\mathcal{M}(f; 1-z)$  and  $\mathcal{M}(h; z)$  to have a common strip of analyticity. This, in turn, requires  $-b < \Re \alpha_0$ ,  $-c < \Re \beta_0$ , and either  $-c < \Re \alpha_0 + 1$  or  $1 - b < \Re \beta_0$ . Following Handelsman and Lew (1970, 1971) we now give an extension of this method in which none of these conditions is required.

First, we introduce the truncated functions  $f_1(t)$  and  $f_2(t)$  defined by

$$2.5.21 \quad f_1(t) = \begin{cases} f(t), & 0 < t \leq 1, \\ 0, & 1 < t < \infty, \end{cases}$$

$$2.5.22 \quad f_2(t) = f(t) - f_1(t).$$

Similarly,

$$2.5.23 \quad h_1(t) = \begin{cases} h(t), & 0 < t \leq 1, \\ 0, & 1 < t < \infty, \end{cases}$$

$$2.5.24 \quad h_2(t) = h(t) - h_1(t).$$

With these definitions and the conditions (2.5.17)–(2.5.20) the Mellin transforms converge absolutely and define analytic functions in the half-planes shown in Table 2.5.1.

Table 2.5.1: Domains of convergence for Mellin transforms.

Transform	Domain of Convergence
$\mathcal{M}(f_1; z)$	$\Re z > -\Re \alpha_0$
$\mathcal{M}(f_2; z)$	$\Re z < b$
$\mathcal{M}(h_1; z)$	$\Re z > -c$
$\mathcal{M}(h_2; z)$	$\Re z < \Re \beta_0$

Furthermore,  $\mathcal{M}(f_1; z)$  can be continued analytically to a meromorphic function on the entire  $z$ -plane, whose singularities are simple poles at  $-\alpha_s$ ,  $s = 0, 1, 2, \dots$ , with principal part

$$2.5.25 \quad a_s / (z + \alpha_s).$$

By Table 2.5.1,  $\mathcal{M}(f_2; z)$  is an analytic function in the half-plane  $\Re z < b$ . Hence we can extend the definition of the Mellin transform of  $f$  by setting

$$2.5.26 \quad \mathcal{M}(f; z) = \mathcal{M}(f_1; z) + \mathcal{M}(f_2; z)$$

for  $\Re z < b$ . The extended transform  $\mathcal{M}(f; z)$  has the same properties as  $\mathcal{M}(f_1; z)$  in the half-plane  $\Re z < b$ .

Similarly, if  $\kappa = 0$  in (2.5.18), then  $\mathcal{M}(h_2; z)$  can be continued analytically to a meromorphic function on the entire  $z$ -plane with simple poles at  $\beta_s$ ,  $s = 0, 1, 2, \dots$ , with principal part

$$2.5.27 \quad -b_s / (z - \beta_s).$$

Alternatively, if  $\kappa \neq 0$  in (2.5.18), then  $\mathcal{M}(h_2; z)$  can be continued analytically to an entire function.

Since  $\mathcal{M}(h_1; z)$  is analytic for  $\Re z > -c$  by Table 2.5.1, the analytically-continued  $\mathcal{M}(h_2; z)$  allows us to extend the Mellin transform of  $h$  via

$$2.5.28 \quad \mathcal{M}(h; z) = \mathcal{M}(h_1; z) + \mathcal{M}(h_2; z)$$

in the same half-plane. From (2.5.26) and (2.5.28), it follows that both  $\mathcal{M}(f; 1 - z)$  and  $\mathcal{M}(h; z)$  are defined in the half-plane  $\Re z > \max(1 - b, -c)$ .

We are now ready to derive the asymptotic expansion of the integral  $I(x)$  in (2.5.3) as  $x \rightarrow \infty$ . First we note that

$$2.5.29 \quad I(x) = \sum_{j,k=1}^2 I_{jk}(x),$$

where

$$2.5.30 \quad I_{jk}(x) = \int_0^\infty f_j(t) h_k(xt) dt.$$

By direct computation

$$2.5.31 \quad I_{21}(x) = 0, \quad \text{for } x \geq 1.$$

Next from Table 2.5.1 we observe that the integrals for the transform pair  $\mathcal{M}(f_j; 1 - z)$  and  $\mathcal{M}(h_k; z)$  are absolutely convergent in the domain  $D_{jk}$  specified in Table 2.5.2, and these domains are nonempty as a consequence of (2.5.19) and (2.5.20).

Table 2.5.2: Domains of analyticity for Mellin transforms.

Transform Pair	Domain $D_{jk}$
$\mathcal{M}(f_1; 1 - z), \mathcal{M}(h_1; z)$	$-c < \Re z < 1 + \Re \alpha_0$
$\mathcal{M}(f_1; 1 - z), \mathcal{M}(h_2; z)$	$\Re z < \min(1 + \Re \alpha_0, \Re \beta_0)$
$\mathcal{M}(f_2; 1 - z), \mathcal{M}(h_1; z)$	$\max(-c, 1 - b) < \Re z$
$\mathcal{M}(f_2; 1 - z), \mathcal{M}(h_2; z)$	$1 - b < \Re z < \Re \beta_0$

For simplicity, write

$$2.5.32 \quad G_{jk}(z) = \mathcal{M}(f_j; 1 - z) \mathcal{M}(h_k; z).$$

From Table 2.5.2, we see that each  $G_{jk}(z)$  is analytic in the domain  $D_{jk}$ . Furthermore, each  $G_{jk}(z)$  has an analytic or meromorphic extension to a half-plane containing  $D_{jk}$ . Now suppose that there is a real number  $p_{jk}$  in  $D_{jk}$  such that the Parseval formula (2.5.5) applies and

$$2.5.33 \quad I_{jk}(x) = \frac{1}{2\pi i} \int_{p_{jk}-i\infty}^{p_{jk}+i\infty} x^{-z} G_{jk}(z) dz.$$

If, in addition, there exists a number  $q_{jk} > p_{jk}$  such that

$$2.5.34 \quad \sup_{p_{jk} \leq x \leq q_{jk}} |G_{jk}(x + iy)| \rightarrow 0, \quad y \rightarrow \pm\infty,$$

then

$$2.5.35 \quad I_{jk}(x) = \sum_{p_{jk} < \Re z < q_{jk}} \text{res}[-x^{-z} G_{jk}(z)] + E_{jk}(x),$$

where

$$2.5.36 \quad E_{jk}(x) = \frac{1}{2\pi i} \int_{q_{jk}-i\infty}^{q_{jk}+i\infty} x^{-z} G_{jk}(z) dz = o(x^{-q_{jk}})$$

as  $x \rightarrow +\infty$ . (The last order estimate follows from the Riemann–Lebesgue lemma, §1.8(i).) The asymptotic expansion of  $I(x)$  is then obtained from (2.5.29).

For further discussion of this method and examples, see Wong (1989, Chapter 3), Paris and Kaminski (2001, Chapter 5), and Bleistein and Handelsman (1975, Chapters 4 and 6). The first reference also contains explicit

expressions for the error terms, as do Soni (1980) and Carlson and Gustafson (1985).

The Mellin transform method can also be extended to derive asymptotic expansions of multidimensional integrals having algebraic or logarithmic singularities, or both; see Wong (1989, Chapter 3), Paris and Kaminski (2001, Chapter 7), and McClure and Wong (1987). See also Brüning (1984) for a different approach.

### 2.5(iii) Laplace Transforms with Small Parameters

Let  $h(t)$  satisfy (2.5.18) and (2.5.20) with  $c > -1$ , and consider the Laplace transform

$$2.5.37 \quad \mathcal{L}(h; \zeta) = \int_0^\infty h(t)e^{-\zeta t} dt.$$

Put  $x = 1/\zeta$  and break the integration range at  $t = 1$ , as in (2.5.23) and (2.5.24). Then

$$2.5.38 \quad \zeta \mathcal{L}(h; \zeta) = I_1(x) + I_2(x),$$

where

$$2.5.39 \quad I_j(x) = \int_0^\infty e^{-t} h_j(xt) dt, \quad j = 1, 2.$$

Since  $\mathcal{M}(e^{-t}; z) = \Gamma(z)$ , by the Parseval formula (2.5.5), there are real numbers  $p_1$  and  $p_2$  such that  $-c < p_1 < 1$ ,  $p_2 < \min(1, \Re\beta_0)$ , and

$$2.5.40 \quad I_j(x) = \frac{1}{2\pi i} \int_{p_j-i\infty}^{p_j+i\infty} x^{-z} \Gamma(1-z) \mathcal{M}(h_j; z) dz, \quad j = 1, 2.$$

Since  $\mathcal{M}(h; z)$  is analytic for  $\Re z > -c$ , by (2.5.14),

$$2.5.41 \quad I_1(x) = \mathcal{M}(h_1; 1)x^{-1} + \frac{1}{2\pi i} \int_{\rho-i\infty}^{\rho+i\infty} x^{-z} \Gamma(1-z) \mathcal{M}(h_1; z) dz,$$

for any  $\rho$  satisfying  $1 < \rho < 2$ . Similarly, since  $\mathcal{M}(h_2; z)$  can be continued analytically to a meromorphic function (when  $\kappa = 0$ ) or to an entire function (when  $\kappa \neq 0$ ), we can choose  $\rho$  so that  $\mathcal{M}(h_2; z)$  has no poles in  $1 < \Re z \leq \rho < 2$ . Thus

$$2.5.42 \quad I_2(x) = \sum_{\Re\beta_0 \leq \Re z \leq 1} \operatorname{res} [-x^{-z} \Gamma(1-z) \mathcal{M}(h_2; z)] + \frac{1}{2\pi i} \int_{\rho-i\infty}^{\rho+i\infty} x^{-z} \Gamma(1-z) \mathcal{M}(h_2; z) dz.$$

On substituting (2.5.41) and (2.5.42) into (2.5.38), we obtain

$$2.5.43 \quad \begin{aligned} \mathcal{L}(h; \zeta) &= \mathcal{M}(h_1; 1) \\ &+ \sum_{\Re\beta_0 \leq \Re z \leq 1} \operatorname{res} [-\zeta^{-z-1} \Gamma(1-z) \mathcal{M}(h_2; z)] \\ &+ \sum_{1 < \Re z < l} \operatorname{res} [-\zeta^{-z-1} \Gamma(1-z) \mathcal{M}(h; z)] \\ &+ \frac{1}{2\pi i} \int_{l-\delta-i\infty}^{l-\delta+i\infty} \zeta^{-z-1} \Gamma(1-z) \mathcal{M}(h; z) dz, \end{aligned}$$

where  $l (\geq 2)$  is an arbitrary integer and  $\delta$  is an arbitrary small positive constant. The last term is clearly  $O(\zeta^{l-\delta-1})$  as  $\zeta \rightarrow 0+$ .

If  $\kappa = 0$  in (2.5.18) and  $c > -1$  in (2.5.20), and if none of the exponents in (2.5.18) are positive integers, then the expansion (2.5.43) gives the following useful result:

$$2.5.44 \quad \begin{aligned} \mathcal{L}(h; \zeta) &\sim \sum_{n=0}^{\infty} b_n \Gamma(1-\beta_n) \zeta^{\beta_n-1} \\ &+ \sum_{n=0}^{\infty} \frac{(-\zeta)^n}{n!} \mathcal{M}(h; n+1), \quad \zeta \rightarrow 0+. \end{aligned}$$

**Example**

$$2.5.45 \quad \mathcal{L}(h; \zeta) = \int_0^\infty \frac{e^{-\zeta t}}{1+t} dt, \quad \Re\zeta > 0.$$

With  $h(t) = 1/(1+t)$ , we have  $\mathcal{M}(h; z) = \pi \csc(\pi z)$  for  $0 < \Re z < 1$ . In the notation of (2.5.18) and (2.5.20),  $\kappa = 0$ ,  $\beta_s = s + 1$ , and  $c = 0$ . Straightforward calculation gives

$$2.5.46 \quad \begin{aligned} &\operatorname{res}_{z=k} [-\zeta^{z-1} \Gamma(1-z) \pi \csc(\pi z)] \\ &= (-\ln \zeta + \psi(k)) \frac{\zeta^{k-1}}{(k-1)!}, \end{aligned}$$

where  $\psi(z) = \Gamma'(z)/\Gamma(z)$ . From (2.5.28)

$$2.5.47 \quad \begin{aligned} &\operatorname{res}_{z=1} [-\zeta^{z-1} \Gamma(1-z) \mathcal{M}(h_2; z)] \\ &= (-\ln \zeta - \gamma) - \mathcal{M}(h_1; 1), \end{aligned}$$

where  $\gamma$  is Euler's constant (§5.2(ii)). Insertion of these results into (2.5.43) yields

$$2.5.48 \quad \mathcal{L}(h; \zeta) \sim (-\ln \zeta) \sum_{k=0}^{\infty} \frac{\zeta^k}{k!} + \sum_{k=0}^{\infty} \psi(k+1) \frac{\zeta^k}{k!}, \quad \zeta \rightarrow 0+.$$

To verify (2.5.48) we may use

$$2.5.49 \quad \mathcal{L}(h; \zeta) = e^\zeta E_1(\zeta);$$

compare (6.2.2) and (6.6.3).

For examples in which the integral defining the Mellin transform  $\mathcal{M}(h; z)$  does not exist for any value of  $z$ , see Wong (1989, Chapter 3), Bleistein and Handelsman (1975, Chapter 4), and Handelsman and Lew (1970).

## 2.6 Distributional Methods

### 2.6(i) Divergent Integrals

Consider the integral

$$2.6.1 \quad S(x) = \int_0^\infty \frac{1}{(1+t)^{1/3}(x+t)} dt,$$

where  $x > 0$ . For  $t > 1$ ,

$$2.6.2 \quad (1+t)^{-1/3} = \sum_{s=0}^{\infty} \binom{-\frac{1}{3}}{s} t^{-s-(1/3)}.$$

Motivated by Watson's lemma (§2.3(ii)), we substitute (2.6.2) in (2.6.1), and integrate term by term. This leads to integrals of the form

$$2.6.3 \quad \int_0^\infty \frac{t^{-s-(1/\beta)}}{x+t} dt, \quad s = 1, 2, 3, \dots$$

Although divergent, these integrals may be interpreted in a generalized sense. For instance, we have

$$2.6.4 \quad \int_0^\infty \frac{t^{\alpha-1}}{(x+t)^{\alpha+\beta}} dt = \frac{\Gamma(\alpha)\Gamma(\beta)}{\Gamma(\alpha+\beta)} \frac{1}{x^\beta}, \quad \Re\alpha > 0, \Re\beta > 0.$$

But the right-hand side is meaningful for all values of  $\alpha$  and  $\beta$ , other than nonpositive integers. We may therefore define the integral on the left-hand side of (2.6.4) by the value on the right-hand side, except when  $\alpha, \beta = 0, -1, -2, \dots$ . With this interpretation

$$2.6.5 \quad \int_0^\infty \frac{t^{-s-(1/3)}}{x+t} dt = \frac{2\pi}{\sqrt{3}} \frac{(-1)^s}{x^{s+(1/3)}}, \quad s = 0, 1, 2, \dots$$

Inserting (2.6.2) into (2.6.1) and integrating formally term-by-term, we obtain

$$2.6.6 \quad S(x) \sim \frac{2\pi}{\sqrt{3}} \sum_{s=0}^\infty (-1)^s \binom{-\frac{1}{3}}{s} x^{-s-(1/3)}, \quad x \rightarrow \infty.$$

However this result is incorrect. The correct result is given by

$$2.6.7 \quad S(x) \sim \frac{2\pi}{\sqrt{3}} \sum_{s=0}^\infty (-1)^s \binom{-\frac{1}{3}}{s} x^{-s-(1/3)} - \sum_{s=1}^\infty \frac{3^s(s-1)!}{2 \cdot 5 \cdots (3s-1)} x^{-s};$$

see §2.6(ii).

The fact that expansion (2.6.6) misses all the terms in the second series in (2.6.7) raises the question: what went wrong with our process of reaching (2.6.6)? In the following subsections, we use some elementary facts of distribution theory (§1.16) to study the proper use of divergent integrals. An important asset of the distribution method is that it gives explicit expressions for the remainder terms associated with the resulting asymptotic expansions.

For an introduction to distribution theory, see Wong (1989, Chapter 5). For more advanced discussions, see Gel'fand and Shilov (1964) and Rudin (1973).

## 2.6(ii) Stieltjes Transform

Let  $f(t)$  be locally integrable on  $[0, \infty)$ . The *Stieltjes transform* of  $f(t)$  is defined by

$$2.6.8 \quad \mathcal{S}(f; z) = \int_0^\infty \frac{f(t)}{t+z} dt.$$

To derive an asymptotic expansion of  $\mathcal{S}(f; z)$  for large values of  $|z|$ , with  $|\text{ph } z| < \pi$ , we assume that  $f(t)$  possesses an asymptotic expansion of the form

$$2.6.9 \quad f(t) \sim \sum_{s=0}^\infty a_s t^{-s-\alpha}, \quad t \rightarrow +\infty,$$

with  $0 < \alpha \leq 1$ . For each  $n = 1, 2, 3, \dots$ , set

$$2.6.10 \quad f(t) = \sum_{s=0}^{n-1} a_s t^{-s-\alpha} + f_n(t).$$

To each function in this equation, we shall assign a *tempered distribution* (i.e., a continuous linear functional) on the space  $\mathcal{T}$  of rapidly decreasing functions on  $\mathbb{R}$ . Since  $f(t)$  is locally integrable on  $[0, \infty)$ , it defines a distribution by

$$2.6.11 \quad \langle f, \phi \rangle = \int_0^\infty f(t)\phi(t) dt, \quad \phi \in \mathcal{T}.$$

In particular,

$$2.6.12 \quad \langle t^{-\alpha}, \phi \rangle = \int_0^\infty t^{-\alpha}\phi(t) dt, \quad \phi \in \mathcal{T},$$

when  $0 < \alpha < 1$ . Since the functions  $t^{-s-\alpha}$ ,  $s = 1, 2, \dots$ , are not locally integrable on  $[0, \infty)$ , we cannot assign distributions to them in a similar manner. However, they are multiples of the derivatives of  $t^{-\alpha}$ . Motivated by the definition of distributional derivatives, we can assign them the distributions defined by

$$2.6.13 \quad \langle t^{-s-\alpha}, \phi \rangle = \frac{1}{(\alpha)_s} \int_0^\infty t^{-\alpha}\phi^{(s)}(t) dt, \quad \phi \in \mathcal{T},$$

where  $(\alpha)_s = \alpha(\alpha+1)\cdots(\alpha+s-1)$ . Similarly, in the case  $\alpha = 1$ , we define

$$2.6.14 \quad \langle t^{-s-1}, \phi \rangle = -\frac{1}{s!} \int_0^\infty (\ln t)\phi^{(s+1)}(t) dt, \quad \phi \in \mathcal{T}.$$

To assign a distribution to the function  $f_n(t)$ , we first let  $f_{n,n}(t)$  denote the  $n$ th repeated integral (§1.4(v)) of  $f_n$ :

$$2.6.15 \quad f_{n,n}(t) = \frac{(-1)^n}{(n-1)!} \int_t^\infty (\tau-t)^{n-1} f_n(\tau) d\tau.$$

For  $0 < \alpha < 1$ , it is easily seen that  $f_{n,n}(t)$  is bounded on  $[0, R]$  for any positive constant  $R$ , and is  $O(t^{-\alpha})$  as  $t \rightarrow \infty$ . For  $\alpha = 1$ , we have  $f_{n,n}(t) = O(t^{-1})$  as  $t \rightarrow \infty$  and  $f_{n,n}(t) = O(\ln t)$  as  $t \rightarrow 0+$ . In either case, we define the distribution associated with  $f_n(t)$  by

$$2.6.16 \quad \langle f_n, \phi \rangle = (-1)^n \int_0^\infty f_{n,n}(t)\phi^{(n)}(t) dt, \quad \phi \in \mathcal{T},$$

since the  $n$ th derivative of  $f_{n,n}$  is  $f_n$ .

We have now assigned a distribution to each function in (2.6.10). A natural question is: what is the exact relation between these distributions? The answer is provided by the identities (2.6.17) and (2.6.20) given below.

For  $0 < \alpha < 1$  and  $n \geq 1$ , we have

**2.6.17**

$$\langle f, \phi \rangle = \sum_{s=0}^{n-1} a_s \langle t^{-s-\alpha}, \phi \rangle - \sum_{s=1}^n c_s \langle \delta^{(s-1)}, \phi \rangle + \langle f_n, \phi \rangle$$

for any  $\phi \in \mathcal{T}$ , where

$$\mathbf{2.6.18} \quad c_s = \frac{(-1)^s}{(s-1)!} \mathcal{M}(f; s),$$

$\mathcal{M}(f; z)$  being the Mellin transform of  $f(t)$  or its analytic continuation (§2.5(ii)). The Dirac delta distribution in (2.6.17) is given by

$$\mathbf{2.6.19} \quad \langle \delta^{(s)}, \phi \rangle = (-1)^s \phi^{(s)}(0), \quad s = 0, 1, 2, \dots;$$

compare §1.16(iii).

For  $\alpha = 1$

**2.6.20**

$$\langle f, \phi \rangle = \sum_{s=0}^{n-1} a_s \langle t^{-s-1}, \phi \rangle - \sum_{s=1}^n d_s \langle \delta^{(s-1)}, \phi \rangle + \langle f_n, \phi \rangle$$

for any  $\phi \in \mathcal{T}$ , where

$$\mathbf{2.6.21} \quad (-1)^{s+1} d_{s+1} = \frac{a_s}{s!} \sum_{k=1}^s \frac{1}{k} + \frac{1}{s!} \lim_{z \rightarrow s+1} \left( \mathcal{M}(f; z) + \frac{a_s}{z-s-1} \right),$$

for  $s = 0, 1, 2, \dots$ .

To apply the results (2.6.17) and (2.6.20) to the Stieltjes transform (2.6.8), we take a specific function  $\phi \in \mathcal{T}$ . Let  $\varepsilon$  be a positive number, and

$$\mathbf{2.6.22} \quad \phi_\varepsilon(t) = \frac{e^{-\varepsilon t}}{t+z}, \quad t \in (0, \infty).$$

From (2.6.13) and (2.6.14)

$$\mathbf{2.6.23} \quad \lim_{\varepsilon \rightarrow 0} \langle t^{-s-\alpha}, \phi_\varepsilon \rangle = \frac{\pi}{\sin(\pi\alpha)} \frac{(-1)^s}{z^{s+\alpha}},$$

$$\mathbf{2.6.24} \quad \lim_{\varepsilon \rightarrow 0} \langle t^{-s-1}, \phi_\varepsilon \rangle = \frac{(-1)^{s+1}}{z^{s+1}} \sum_{k=1}^s \frac{1}{k} + \frac{(-1)^s}{z^{s+1}} \ln z,$$

with  $s = 0, 1, 2, \dots$ . From (2.6.11) and (2.6.16), we also have

$$\mathbf{2.6.25} \quad \lim_{\varepsilon \rightarrow 0} \langle f, \phi_\varepsilon \rangle = \mathcal{S}(f; z),$$

$$\mathbf{2.6.26} \quad \lim_{\varepsilon \rightarrow 0} \langle f_n, \phi_\varepsilon \rangle = n! \int_0^\infty \frac{f_{n,n}(t)}{(t+z)^{n+1}} dt.$$

On substituting (2.6.15) into (2.6.26) and interchanging the order of integration, the right-hand side of (2.6.26) becomes

$$\frac{(-1)^n}{z^n} \int_0^\infty \frac{\tau^n f_n(\tau)}{\tau+z} d\tau.$$

To summarize,

$$\mathbf{2.6.27} \quad \mathcal{S}(f; z) = \frac{\pi}{\sin(\pi\alpha)} \sum_{s=0}^{n-1} (-1)^s \frac{a_s}{z^{s+\alpha}} - \sum_{s=1}^n (s-1)! \frac{c_s}{z^s} + R_n(z),$$

if  $\alpha \in (0, 1)$  in (2.6.9), or

**2.6.28**

$$\mathcal{S}(f; z) = \ln z \sum_{s=0}^{n-1} (-1)^s \frac{a_s}{z^{s+1}} + \sum_{s=0}^{n-1} (-1)^s \frac{\tilde{d}_s}{z^{s+1}} + R_n(z),$$

if  $\alpha = 1$  in (2.6.9). Here  $c_s$  is given by (2.6.18),

$$\mathbf{2.6.29} \quad \tilde{d}_s = \lim_{z \rightarrow s+1} \left( \mathcal{M}(f; z) + \frac{a_s}{z-s-1} \right),$$

and

$$\mathbf{2.6.30} \quad R_n(z) = \frac{(-1)^n}{z^n} \int_0^\infty \frac{\tau^n f_n(\tau)}{\tau+z} d\tau.$$

The expansion (2.6.7) follows immediately from (2.6.27) with  $z = x$  and  $f(t) = (1+t)^{-(1/3)}$ ; its region of validity is  $|\operatorname{ph} x| \leq \pi - \delta$  ( $< \pi$ ). The distribution method outlined here can be extended readily to functions  $f(t)$  having an asymptotic expansion of the form

$$\mathbf{2.6.31} \quad f(t) \sim e^{ict} \sum_{s=0}^\infty a_s t^{-s-\alpha}, \quad t \rightarrow +\infty,$$

where  $c$  ( $\neq 0$ ) is real, and  $0 < \alpha \leq 1$ . For a more detailed discussion of the derivation of asymptotic expansions of Stieltjes transforms by the distribution method, see McClure and Wong (1978) and Wong (1989, Chapter 6). Corresponding results for the *generalized Stieltjes transform*

$$\mathbf{2.6.32} \quad \int_0^\infty \frac{f(t)}{(t+z)^\rho} dt, \quad \rho > 0,$$

can be found in Wong (1979). An application has been given by López (2000) to derive asymptotic expansions of standard symmetric elliptic integrals, complete with error bounds; see §19.27(vi).

## 2.6(iii) Fractional Integrals

The Riemann–Liouville *fractional integral* of order  $\mu$  is defined by

$$\mathbf{2.6.33} \quad I^\mu f(x) = \frac{1}{\Gamma(\mu)} \int_0^x (x-t)^{\mu-1} f(t) dt, \quad \mu > 0;$$

see §1.15(vi). We again assume  $f(t)$  is locally integrable on  $[0, \infty)$  and satisfies (2.6.9). We now derive an asymptotic expansion of  $I^\mu f(x)$  for large positive values of  $x$ .

In terms of the *convolution product*

$$\mathbf{2.6.34} \quad (f * g)(x) = \int_0^x f(x-t)g(t) dt$$

of two locally integrable functions on  $[0, \infty)$ , (2.6.33) can be written

$$\mathbf{2.6.35} \quad I^\mu f(x) = \frac{1}{\Gamma(\mu)} (t^{\mu-1} * f)(x).$$

The replacement of  $f(t)$  by its asymptotic expansion (2.6.9), followed by term-by-term integration leads to convolution integrals of the form

$$2.6.36 \quad (t^{\mu-1} * t^{-s-\alpha})(x) = \int_0^x (x-t)^{\mu-1} t^{-s-\alpha} dt, \\ s = 0, 1, 2, \dots$$

Of course, except when  $s = 0$  and  $0 < \alpha < 1$ , none of these integrals exists in the usual sense. However, the left-hand side can be considered as the convolution of the two distributions associated with the functions  $t^{\mu-1}$  and  $t^{-s-\alpha}$ , given by (2.6.12) and (2.6.13).

To define convolutions of distributions, we first introduce the space  $K^+$  of all distributions of the form  $D^n f$ , where  $n$  is a nonnegative integer,  $f$  is a locally integrable function on  $\mathbb{R}$  which vanishes on  $(-\infty, 0]$ , and  $D^n f$  denotes the  $n$ th derivative of the distribution associated with  $f$ . For  $F = D^n f$  and  $G = D^m g$  in  $K^+$ , we define

$$2.6.37 \quad F * G = D^{n+m}(f * g).$$

It is easily seen that  $K^+$  forms a commutative, associative linear algebra. Furthermore,  $K^+$  contains the distributions  $H$ ,  $\delta$ , and  $t^\lambda$ ,  $t > 0$ , for any real (or complex) number  $\lambda$ , where  $H$  is the distribution associated with the Heaviside function  $H(t)$  (§1.16(iv)), and  $t^\lambda$  is the distribution defined by (2.6.12)–(2.6.14), depending on the value of  $\lambda$ . Since  $\delta = DH$ , it follows that for  $\mu \neq 1, 2, \dots$ ,

$$2.6.38 \quad t^{\mu-1} * \delta^{(s-1)} = \frac{\Gamma(\mu)}{\Gamma(\mu+1-s)} t^{\mu-s}, \quad t > 0.$$

Using (5.12.1), we can also show that when  $\mu \neq 1, 2, \dots$  and  $\mu - \alpha$  is not a nonnegative integer,

$$2.6.39 \quad t^{\mu-1} * t^{-s-\alpha} = \frac{\Gamma(\mu) \Gamma(1-s-\alpha)}{\Gamma(\mu+1-s-\alpha)} t^{\mu-s-\alpha}, \quad t > 0,$$

and

$$2.6.40 \quad t^{\mu-1} * t^{-s-1} = \frac{(-1)^s}{\mu \cdot s!} D^{s+1} (t^\mu (\ln t - \gamma - \psi(\mu+1))), \\ t > 0,$$

where  $\gamma$  is Euler's constant (§5.2(ii)).

To derive the asymptotic expansion of  $I^\mu f(x)$ , we recall equations (2.6.17) and (2.6.20). In the sense of distributions, they can be written

$$2.6.41 \quad f = \sum_{s=0}^{n-1} a_s t^{-s-\alpha} - \sum_{s=1}^n c_s \delta^{(s-1)} + f_n,$$

and

$$2.6.42 \quad f = \sum_{s=0}^{n-1} a_s t^{-s-1} - \sum_{s=1}^n d_s \delta^{(s-1)} + f_n.$$

Substituting into (2.6.35) and using (2.6.38)–(2.6.40), we obtain

$$2.6.43 \quad t^{\mu-1} * f = \sum_{s=0}^{n-1} a_s \frac{\Gamma(\mu) \Gamma(1-s-\alpha)}{\Gamma(\mu+1-s-\alpha)} t^{\mu-s-\alpha} \\ - \sum_{s=1}^n c_s \frac{\Gamma(\mu)}{\Gamma(\mu-s+1)} t^{\mu-s} + t^{\mu-1} * f_n$$

when  $0 < \alpha < 1$ , or

$$2.6.44 \quad t^{\mu-1} * f = \sum_{s=0}^{n-1} \frac{(-1)^s a_s}{\mu \cdot s!} D^{s+1} (t^\mu (\ln t - \gamma - \psi(\mu+1))) \\ - \sum_{s=1}^n d_s \frac{\Gamma(\mu)}{\Gamma(\mu-s+1)} t^{\mu-s} + t^{\mu-1} * f_n$$

when  $\alpha = 1$ . These equations again hold only in the sense of distributions. Since the function  $t^\mu (\ln t - \gamma - \psi(\mu+1))$  and all its derivatives are locally absolutely continuous in  $(0, \infty)$ , the distributional derivatives in the first sum in (2.6.44) can be replaced by the corresponding ordinary derivatives. Furthermore, since  $f_{n,n}^{(n)}(t) = f_n(t)$ , it follows from (2.6.37) that the remainder terms  $t^{\mu-1} * f_n$  in the last two equations can be associated with a locally integrable function in  $(0, \infty)$ . On replacing the distributions by their corresponding functions, (2.6.43) and (2.6.44) give

$$2.6.45 \quad I^\mu f(x) = \sum_{s=0}^{n-1} a_s \frac{\Gamma(1-s-\alpha)}{\Gamma(\mu+1-s-\alpha)} x^{\mu-s-\alpha} \\ - \sum_{s=1}^n \frac{c_s}{\Gamma(\mu+1-s)} x^{\mu-s} + \frac{1}{x^n} \delta_n(x),$$

when  $0 < \alpha < 1$ , or

$$2.6.46 \quad I^\mu f(x) = \sum_{s=0}^{n-1} \frac{(-1)^s a_s}{s! \Gamma(\mu+1)} \frac{d^{s+1}}{dx^{s+1}} (x^\mu (\ln x - \gamma - \psi(\mu+1))) \\ - \sum_{s=1}^n \frac{d_s}{\Gamma(\mu-s+1)} x^{\mu-s} + \frac{1}{x^n} \delta_n(x),$$

when  $\alpha = 1$ , where

$$2.6.47 \quad \delta_n(x) = \sum_{j=0}^n \binom{n}{j} \frac{\Gamma(\mu+1)}{\Gamma(\mu+1-j)} I^\mu (t^{n-j} f_{n,j})(x),$$

$f_{n,j}(t)$  being the  $j$ th repeated integral of  $f_n$ ; compare (2.6.15).

#### Example

Let  $f(t) = t^{1-\alpha}/(1+t)$ ,  $0 < \alpha < 1$ . Then

$$2.6.48 \quad I^\mu f(x) = \frac{1}{\Gamma(\mu)} \int_0^x (x-t)^{\mu-1} t^{1-\alpha} (1+t)^{-1} dt,$$

where  $\mu > 0$ . For  $0 < t < \infty$

$$2.6.49 \quad f(t) = \sum_{s=0}^{n-1} (-1)^s t^{-s-\alpha} + (-1)^n \frac{t^{1-n-\alpha}}{1+t}.$$

In the notation of (2.6.10),  $a_s = (-1)^s$  and

$$2.6.50 \quad f_n(t) = (-1)^n \frac{t^{1-n-\alpha}}{1+t}.$$

Since

$$2.6.51 \quad \mathcal{M}(f; s) = (-1)^s \pi / \sin(\pi\alpha),$$

from (2.6.45) it follows that

$$2.6.52 \quad \begin{aligned} I^\mu f(x) &= \sum_{s=0}^{n-1} (-1)^s \frac{\Gamma(1-s-\alpha)}{\Gamma(\mu+1-s-\alpha)} x^{\mu-s-\alpha} \\ &- \frac{\pi}{\sin(\pi\alpha)} \sum_{s=1}^n \frac{1}{\Gamma(\mu+1-s)} \frac{x^{\mu-s}}{(s-1)!} \\ &+ \frac{1}{x^n} \delta_n(x). \end{aligned}$$

Moreover,

$$2.6.53 \quad \begin{aligned} |\delta_n(x)| &\leq \frac{\Gamma(\mu+1)\Gamma(1-\alpha)}{\Gamma(\mu+1-\alpha)\Gamma(n+\alpha)} \\ &\times \sum_{j=0}^n \binom{n}{j} \frac{\Gamma(n+\alpha-j)}{|\Gamma(\mu+1-j)|} x^{\mu-\alpha} \end{aligned}$$

for  $x > 0$ .

It may be noted that the integral (2.6.48) can be expressed in terms of the hypergeometric function  ${}_2F_1(1, 2-\alpha; 2-\alpha+\mu; -x)$ ; see §15.2(i).

For proofs and other examples, see McClure and Wong (1979) and Wong (1989, Chapter 6). If both  $f$  and  $g$  in (2.6.34) have asymptotic expansions of the form (2.6.9), then the distribution method can also be used to derive an asymptotic expansion of the convolution  $f * g$ ; see Li and Wong (1994).

### 2.6(iv) Regularization

The method of distributions can be further extended to derive asymptotic expansions for convolution integrals:

$$2.6.54 \quad I(x) = \int_0^\infty f(t)h(xt) dt.$$

We assume that for each  $n = 1, 2, 3, \dots$ ,

$$2.6.55 \quad f(t) = \sum_{s=0}^{n-1} a_s t^{s+\alpha-1} + f_n(t),$$

where  $0 < \alpha \leq 1$  and  $f_n(t) = O(t^{n+\alpha-1})$  as  $t \rightarrow 0+$ . Also,

$$2.6.56 \quad h(t) = \sum_{s=0}^{n-1} b_s t^{-s-\beta} + h_n(t),$$

where  $0 < \beta \leq 1$ , and  $h_n(t) = O(t^{-n-\beta})$  as  $t \rightarrow \infty$ . Multiplication of these expansions leads to

2.6.57

$$\begin{aligned} f(t)h(xt) &= \sum_{j=0}^{n-1} \sum_{k=0}^{n-1} a_j b_k t^{j+\alpha-1-k-\beta} x^{-k-\beta} \\ &+ \sum_{j=0}^{n-1} a_j t^{j+\alpha-1} h_n(xt) \\ &+ \sum_{k=0}^{n-1} b_k x^{-k-\beta} t^{-k-\beta} f_n(t) + f_n(t)h_n(xt). \end{aligned}$$

On inserting this identity into (2.6.54), we immediately encounter divergent integrals of the form

$$2.6.58 \quad \int_0^\infty t^\lambda dt, \quad \lambda \in \mathbb{R}.$$

However, in the theory of *generalized functions* (distributions), there is a method, known as “regularization”, by which these integrals can be interpreted in a meaningful manner. In this sense

$$2.6.59 \quad \int_0^\infty t^\lambda dt = 0, \quad \lambda \in \mathbb{C}.$$

From (2.6.55) and (2.6.59)

$$2.6.60 \quad \mathcal{M}(f; z) = \mathcal{M}(f_n; z),$$

where  $\mathcal{M}(f; z)$  is the Mellin transform of  $f$  or its analytic continuation. Also, when  $\alpha \neq \beta$ ,

$$2.6.61 \quad \mathcal{M}(h_x; j+\alpha) = x^{-j-\alpha} \mathcal{M}(h; j+\alpha),$$

where  $h_x(t) = h(xt)$ . Inserting (2.6.57) into (2.6.54), we obtain from (2.6.59)–(2.6.61)

$$2.6.62 \quad \begin{aligned} I(x) &= \sum_{j=0}^{n-1} a_j \mathcal{M}(h; j+\alpha) x^{-j-\alpha} \\ &+ \sum_{k=0}^{n-1} b_k \mathcal{M}(f; 1-k-\beta) x^{-k-\beta} + \delta_n(x) \end{aligned}$$

when  $\alpha \neq \beta$ , where

$$\delta_n(x) = \int_0^\infty f_n(t)h_n(xt) dt.$$

There is a similar expansion, involving logarithmic terms, when  $\alpha = \beta$ . For rigorous derivations of these results and also order estimates for  $\delta_n(x)$ , see Wong (1979) and Wong (1989, Chapter 6).

## 2.7 Differential Equations

### 2.7(i) Regular Singularities: Fuchs–Frobenius Theory

An *ordinary point* of the differential equation

$$2.7.1 \quad \frac{d^2 w}{dz^2} + f(z) \frac{dw}{dz} + g(z)w = 0$$



is one at which the coefficients  $f(z)$  and  $g(z)$  are analytic. All solutions are analytic at an ordinary point, and their Taylor-series expansions are found by equating coefficients.

Other points  $z_0$  are *singularities* of the differential equation. If both  $(z - z_0)f(z)$  and  $(z - z_0)^2g(z)$  are analytic at  $z_0$ , then  $z_0$  is a *regular singularity* (or *singularity of the first kind*). All other singularities are classified as *irregular*.

In a punctured neighborhood  $\mathbf{N}$  of a regular singularity  $z_0$

$$2.7.2 \quad f(z) = \sum_{s=0}^{\infty} f_s(z - z_0)^{s-1}, \quad g(z) = \sum_{s=0}^{\infty} g_s(z - z_0)^{s-2},$$

with at least one of the coefficients  $f_0, g_0, g_1$  nonzero. Let  $\alpha_1, \alpha_2$  denote the *indices* or *exponents*, that is, the roots of the *indicial equation*

$$2.7.3 \quad Q(\alpha) \equiv \alpha(\alpha - 1) + f_0\alpha + g_0 = 0.$$

Provided that  $\alpha_1 - \alpha_2$  is not zero or an integer, equation (2.7.1) has independent solutions  $w_j(z)$ ,  $j = 1, 2$ , such that

$$2.7.4 \quad w_j(z) = (z - z_0)^{\alpha_j} \sum_{s=0}^{\infty} a_{s,j}(z - z_0)^s, \quad z \in \mathbf{N},$$

with  $a_{0,j} = 1$ , and

$$2.7.5 \quad Q(\alpha_j + s)a_{s,j} = - \sum_{r=0}^{s-1} ((\alpha_j + r)f_{s-r} + g_{s-r}) a_{r,j},$$

when  $s = 1, 2, 3, \dots$

If  $\alpha_1 - \alpha_2 = 0, 1, 2, \dots$ , then (2.7.4) applies only in the case  $j = 1$ . But there is an independent solution

$$2.7.6 \quad w_2(z) = (z - z_0)^{\alpha_2} \sum_{\substack{s=0 \\ s \neq \alpha_1 - \alpha_2}}^{\infty} b_s(z - z_0)^s + cw_1(z) \ln(z - z_0), \quad z \in \mathbf{N}.$$

The coefficients  $b_s$  and constant  $c$  are again determined by equating coefficients in the differential equation, beginning with  $c = 1$  when  $\alpha_1 - \alpha_2 = 0$ , or with  $b_0 = 1$  when  $\alpha_1 - \alpha_2 = 1, 2, 3, \dots$

The radii of convergence of the series (2.7.4), (2.7.6) are not less than the distance of the next nearest singularity of the differential equation from  $z_0$ .

To include the point at infinity in the foregoing classification scheme, we transform it into the origin by replacing  $z$  in (2.7.1) with  $1/z$ ; see Olver (1997b, pp. 153–154). For corresponding definitions, together with examples, for linear differential equations of arbitrary order see §§16.8(i)–16.8(ii).

## 2.7(ii) Irregular Singularities of Rank 1

If the singularities of  $f(z)$  and  $g(z)$  at  $z_0$  are no worse than poles, then  $z_0$  has *rank*  $\ell - 1$ , where  $\ell$  is the least

integer such that  $(z - z_0)^\ell f(z)$  and  $(z - z_0)^{2\ell} g(z)$  are analytic at  $z_0$ . Thus a regular singularity has rank 0. The most common type of irregular singularity for special functions has rank 1 and is located at infinity. Then

$$2.7.7 \quad f(z) = \sum_{s=0}^{\infty} \frac{f_s}{z^s}, \quad g(z) = \sum_{s=0}^{\infty} \frac{g_s}{z^s},$$

these series converging in an annulus  $|z| > a$ , with at least one of  $f_0, g_0, g_1$  nonzero.

Formal solutions are

$$2.7.8 \quad e^{\lambda_j z} z^{\mu_j} \sum_{s=0}^{\infty} \frac{a_{s,j}}{z^s}, \quad j = 1, 2,$$

where  $\lambda_1, \lambda_2$  are the roots of the *characteristic equation*

$$2.7.9 \quad \lambda^2 + f_0\lambda + g_0 = 0,$$

$$2.7.10 \quad \mu_j = -(f_1\lambda_j + g_1)/(f_0 + 2\lambda_j),$$

$a_{0,j} = 1$ , and

$$(f_0 + 2\lambda_j)sa_{s,j} = (s - \mu_j)(s - 1 - \mu_j)a_{s-1,j}$$

$$2.7.11 \quad + \sum_{r=1}^s (\lambda_j f_{r+1} + g_{r+1} - (s - r - \mu_j)f_r) a_{s-r,j},$$

when  $s = 1, 2, \dots$ . The construction fails iff  $\lambda_1 = \lambda_2$ , that is, when  $f_0^2 = 4g_0$ : this case is treated below.

For large  $s$ ,

$$a_{s,1} \sim \frac{\Lambda_1}{(\lambda_1 - \lambda_2)^s}$$

$$2.7.12 \quad \times \sum_{j=0}^{\infty} a_{j,2} (\lambda_1 - \lambda_2)^j \Gamma(s + \mu_2 - \mu_1 - j),$$

$$a_{s,2} \sim \frac{\Lambda_2}{(\lambda_2 - \lambda_1)^s}$$

$$2.7.13 \quad \times \sum_{j=0}^{\infty} a_{j,1} (\lambda_2 - \lambda_1)^j \Gamma(s + \mu_1 - \mu_2 - j),$$

where  $\Lambda_1$  and  $\Lambda_2$  are constants, and the  $J$ th remainder terms in the sums are  $O(\Gamma(s + \mu_2 - \mu_1 - J))$  and  $O(\Gamma(s + \mu_1 - \mu_2 - J))$ , respectively (Olver (1994a)). Hence unless the series (2.7.8) terminate (in which case the corresponding  $\Lambda_j$  is zero) they diverge. However, there are unique and linearly independent solutions  $w_j(z)$ ,  $j = 1, 2$ , such that

$$2.7.14 \quad w_j(z) \sim e^{\lambda_j z} ((\lambda_2 - \lambda_1)z)^{\mu_j} \sum_{s=0}^{\infty} \frac{a_{s,j}}{z^s}$$

as  $z \rightarrow \infty$  in the sectors

$$2.7.15 \quad -\frac{3}{2}\pi + \delta \leq \text{ph}((\lambda_2 - \lambda_1)z) \leq \frac{3}{2}\pi - \delta, \quad j = 1,$$

$$2.7.16 \quad -\frac{1}{2}\pi + \delta \leq \text{ph}((\lambda_2 - \lambda_1)z) \leq \frac{5}{2}\pi - \delta, \quad j = 2,$$

$\delta$  being an arbitrary small positive constant.

Although the expansions (2.7.14) apply only in the sectors (2.7.15) and (2.7.16), each solution  $w_j(z)$  can

be continued analytically into any other sector. Typical connection formulas are

$$\begin{aligned} 2.7.17 \quad w_1(z) &= e^{2\pi i\mu_1} w_1(ze^{-2\pi i}) + C_1 w_2(z), \\ w_2(z) &= e^{-2\pi i\mu_2} w_2(ze^{2\pi i}) + C_2 w_1(z), \end{aligned}$$

in which  $C_1, C_2$  are constants, the so-called *Stokes multipliers*. In combination with (2.7.14) these formulas yield asymptotic expansions for  $w_1(z)$  in  $\frac{1}{2}\pi + \delta \leq \text{ph}((\lambda_2 - \lambda_1)z) \leq \frac{5}{2}\pi - \delta$ , and  $w_2(z)$  in  $-\frac{3}{2}\pi + \delta \leq \text{ph}((\lambda_2 - \lambda_1)z) \leq \frac{1}{2}\pi - \delta$ . Furthermore,

$$2.7.18 \quad \Lambda_1 = -ie^{(\mu_2 - \mu_1)\pi i} C_1 / (2\pi), \quad \Lambda_2 = iC_2 / (2\pi).$$

Note that the coefficients in the expansions (2.7.12), (2.7.13) for the “late” coefficients, that is,  $a_{s,1}, a_{s,2}$  with  $s$  large, are the “early” coefficients  $a_{j,2}, a_{j,1}$  with  $j$  small. This phenomenon is an example of *resurgence*, a classification due to Écalle (1981a,b). See §2.11(v) for other examples.

The exceptional case  $f_0^2 = 4g_0$  is handled by *Fabry’s transformation*:

$$2.7.19 \quad w = e^{-f_0 z/2} W, \quad t = z^{1/2}.$$

The transformed differential equation either has a regular singularity at  $t = \infty$ , or its characteristic equation has unequal roots.

For error bounds for (2.7.14) see Olver (1997b, Chapter 7). For the calculation of Stokes multipliers see Olde Daalhuis and Olver (1995b). For extensions to singularities of higher rank see Olver and Stenger (1965). For extensions to higher-order differential equations see Stenger (1966a,b), Olver (1997a, 1999), and Olde Daalhuis and Olver (1998).

### 2.7(iii) Liouville–Green (WKBJ) Approximation

For irregular singularities of nonclassifiable rank, a powerful tool for finding the asymptotic behavior of solutions, complete with error bounds, is as follows:

#### Liouville–Green Approximation Theorem

In a finite or infinite interval  $(a_1, a_2)$  let  $f(x)$  be real, positive, and twice-continuously differentiable, and  $g(x)$  be continuous. Then in  $(a_1, a_2)$  the differential equation

$$2.7.20 \quad \frac{d^2 w}{dx^2} = (f(x) + g(x))w$$

has twice-continuously differentiable solutions

$$2.7.21 \quad w_1(x) = f^{-1/4}(x) \exp\left(\int f^{1/2}(x) dx\right) (1 + \epsilon_1(x)),$$

2.7.22

$$w_2(x) = f^{-1/4}(x) \exp\left(-\int f^{1/2}(x) dx\right) (1 + \epsilon_2(x)),$$

such that

$$2.7.23 \quad |\epsilon_j(x)|, \quad \frac{1}{2} f^{-1/2}(x) |\epsilon'_j(x)| \leq \exp\left(\frac{1}{2} \mathcal{V}_{a_j, x}(F)\right) - 1, \\ j = 1, 2,$$

provided that  $\mathcal{V}_{a_j, x}(F) < \infty$ . Here  $F(x)$  is the *error-control function*

$$2.7.24 \quad F(x) = \int \left( \frac{1}{f^{1/4}} \frac{d^2}{dx^2} \left( \frac{1}{f^{1/4}} \right) - \frac{g}{f^{1/2}} \right) dx,$$

and  $\mathcal{V}$  denotes the variational operator (§2.3(i)). Thus

2.7.25

$$\mathcal{V}_{a_j, x}(F) = \int_{a_j}^x \left| \left( \frac{1}{f^{1/4}(t)} \frac{d^2}{dt^2} \left( \frac{1}{f^{1/4}(t)} \right) - \frac{g(t)}{f^{1/2}(t)} \right) dt \right|.$$

Assuming also  $\mathcal{V}_{a_1, a_2}(F) < \infty$ , we have

2.7.26

$$w_1(x) \sim f^{-1/4}(x) \exp\left(\int f^{1/2}(x) dx\right), \quad x \rightarrow a_1+,$$

2.7.27

$$w_2(x) \sim f^{-1/4}(x) \exp\left(-\int f^{1/2}(x) dx\right), \quad x \rightarrow a_2-.$$

Suppose in addition  $|\int f^{1/2}(x) dx|$  is unbounded as  $x \rightarrow a_1+$  and  $x \rightarrow a_2-$ . Then there are solutions  $w_3(x), w_4(x)$ , such that

2.7.28

$$w_3(x) \sim f^{-1/4}(x) \exp\left(\int f^{1/2}(x) dx\right), \quad x \rightarrow a_2-,$$

2.7.29

$$w_4(x) \sim f^{-1/4}(x) \exp\left(-\int f^{1/2}(x) dx\right), \quad x \rightarrow a_1+.$$

The solutions with the properties (2.7.26), (2.7.27) are unique, but not those with the properties (2.7.28), (2.7.29). In fact, since

2.7.30

$$w_1(x)/w_4(x) \rightarrow 0, \quad x \rightarrow a_1+,$$

$w_1(x)$  is a *recessive* (or *subdominant*) solution as  $x \rightarrow a_1+$ , and  $w_4(x)$  is a *dominant* solution as  $x \rightarrow a_1+$ . Similarly for  $w_2(x)$  and  $w_3(x)$  as  $x \rightarrow a_2-$ .

**Example**

$$2.7.31 \quad \frac{d^2 w}{dx^2} = (x + \ln x)w, \quad 0 < x < \infty.$$

We cannot take  $f = x$  and  $g = \ln x$  because  $\int g f^{-1/2} dx$  would diverge as  $x \rightarrow +\infty$ . Instead set  $f = x + \ln x, g = 0$ . By approximating

$$2.7.32 \quad f^{1/2} = x^{1/2} + \frac{1}{2} x^{-1/2} \ln x + O\left(x^{-3/2} (\ln x)^2\right),$$

we arrive at

$$2.7.33 \quad w_2(x) \sim x^{-(1/4) - \sqrt{x}} \exp\left(2x^{1/2} - \frac{2}{3}x^{3/2}\right),$$

$$2.7.34 \quad w_3(x) \sim x^{-(1/4) + \sqrt{x}} \exp\left(\frac{2}{3}x^{3/2} - 2x^{1/2}\right),$$

as  $x \rightarrow +\infty, w_2(x)$  being recessive and  $w_3(x)$  dominant.

For other examples, and also the corresponding results when  $f(x)$  is negative, see Olver (1997b, Chapter 6), Olver (1980a), Taylor (1978, 1982), and Smith (1986). The first of these references includes extensions to complex variables and reversions for zeros.

## 2.7(iv) Numerically Satisfactory Solutions

One pair of independent solutions of the equation

$$2.7.35 \quad d^2w/dz^2 = w$$

is  $w_1(z) = e^z$ ,  $w_2(z) = e^{-z}$ . Another is  $w_3(z) = \cosh z$ ,  $w_4(z) = \sinh z$ . In theory either pair may be used to construct any other solution

$$2.7.36 \quad w(z) = Aw_1(z) + Bw_2(z),$$

or

$$2.7.37 \quad w(z) = Cw_3(z) + Dw_4(z),$$

where  $A, B, C, D$  are constants. From the numerical standpoint, however, the pair  $w_3(z)$  and  $w_4(z)$  has the drawback that severe numerical cancellation can occur with certain combinations of  $C$  and  $D$ , for example if  $C$  and  $D$  are equal, or nearly equal, and  $z$ , or  $\Re z$ , is large and negative. This kind of cancellation cannot take place with  $w_1(z)$  and  $w_2(z)$ , and for this reason, and following Miller (1950), we call  $w_1(z)$  and  $w_2(z)$  a *numerically satisfactory pair* of solutions.

The solutions  $w_1(z)$  and  $w_2(z)$  are respectively recessive and dominant as  $\Re z \rightarrow -\infty$ , and *vice versa* as  $\Re z \rightarrow +\infty$ . This is characteristic of numerically satisfactory pairs. In a neighborhood, or sectorial neighborhood of a singularity, one member has to be recessive. In consequence, if a differential equation has more than one singularity in the extended plane, then usually more than two standard solutions need to be chosen in order to have numerically satisfactory representations everywhere.

In oscillatory intervals, and again following Miller (1950), we call a pair of solutions numerically satisfactory if asymptotically they have the same amplitude and are  $\frac{1}{2}\pi$  out of phase.

## 2.8 Differential Equations with a Parameter

### 2.8(i) Classification of Cases

Many special functions satisfy an equation of the form

$$2.8.1 \quad d^2w/dz^2 = (u^2f(z) + g(z))w,$$

in which  $u$  is a real or complex parameter, and asymptotic solutions are needed for large  $|u|$  that are uniform with respect to  $z$  in a point set  $\mathbf{D}$  in  $\mathbb{R}$  or  $\mathbb{C}$ . For example,  $u$  can be the order of a Bessel function or degree of an orthogonal polynomial. The form of the asymptotic expansion depends on the nature of the *transition points* in  $\mathbf{D}$ , that is, points at which  $f(z)$  has a zero or singularity. Zeros of  $f(z)$  are also called *turning points*.

There are three main cases. In Case I there are no transition points in  $\mathbf{D}$  and  $g(z)$  is analytic. In Case II  $f(z)$  has a simple zero at  $z_0$  and  $g(z)$  is analytic at  $z_0$ . In Case III  $f(z)$  has a simple pole at  $z_0$  and  $(z - z_0)^2g(z)$  is analytic at  $z_0$ .

The same approach is used in all three cases. First we apply the *Liouville transformation* (§1.13(iv)) to (2.8.1). This introduces new variables  $W$  and  $\xi$ , related by

$$2.8.2 \quad W = \dot{z}^{-1/2}w,$$

dots denoting differentiations with respect to  $\xi$ . Then

$$2.8.3 \quad \frac{d^2W}{d\xi^2} = (u^2\dot{z}^2f(z) + \psi(\xi))W,$$

where

$$2.8.4 \quad \psi(\xi) = \dot{z}^2g(z) + \dot{z}^{1/2} \frac{d^2}{d\xi^2}(\dot{z}^{-1/2}).$$

The transformation is now specialized in such a way that: (a)  $\xi$  and  $z$  are analytic functions of each other at the transition point (if any); (b) the approximating differential equation obtained by neglecting  $\psi(\xi)$  (or part of  $\psi(\xi)$ ) has solutions that are functions of a single variable. The actual choices are as follows:

$$2.8.5 \quad \dot{z}^2f(z) = 1, \quad \xi = \int f^{1/2}(z) dz,$$

for Case I,

$$2.8.6 \quad \dot{z}^2f(z) = \xi, \quad \frac{2}{3}\xi^{3/2} = \int_{z_0}^z f^{1/2}(t) dt,$$

for Case II,

$$2.8.7 \quad \dot{z}^2f(z) = 1/\xi, \quad 2\xi^{1/2} = \int_{z_0}^z f^{1/2}(t) dt,$$

for Case III.

The transformed equation has the form

$$2.8.8 \quad d^2W/d\xi^2 = (u^2\xi^m + \psi(\xi))W,$$

with  $m = 0$  (Case I),  $m = 1$  (Case II),  $m = -1$  (Case III). In Cases I and II the asymptotic solutions are in terms of the functions that satisfy (2.8.8) with  $\psi(\xi) = 0$ . These are elementary functions in Case I, and Airy functions (§9.2) in Case II. In Case III the approximating equation is

$$2.8.9 \quad \frac{d^2W}{d\xi^2} = \left( \frac{u^2}{\xi} + \frac{\rho}{\xi^2} \right) W,$$

where  $\rho = \lim(\xi^2\psi(\xi))$  as  $\xi \rightarrow 0$ . Solutions are Bessel functions, or modified Bessel functions, of order  $\pm(1 + 4\rho)^{1/2}$  (§§10.2, 10.25).

For another approach to these problems based on convergent inverse factorial series expansions see Dunster *et al.* (1993) and Dunster (2001a, 2004).

**2.8(ii) Case I: No Transition Points**

The transformed differential equation is

**2.8.10** 
$$d^2W/d\xi^2 = (u^2 + \psi(\xi))W,$$

in which  $\xi$  ranges over a bounded or unbounded interval or domain  $\Delta$ , and  $\psi(\xi)$  is  $C^\infty$  or analytic on  $\Delta$ . The parameter  $u$  is assumed to be real and positive. Corresponding to each positive integer  $n$  there are solutions  $W_{n,j}(u, \xi)$ ,  $j = 1, 2$ , that depend on arbitrarily chosen reference points  $\alpha_j$ , are  $C^\infty$  or analytic on  $\Delta$ , and as  $u \rightarrow \infty$

**2.8.11**

$$W_{n,1}(u, \xi) = e^{u\xi} \left( \sum_{s=0}^{n-1} \frac{A_s(\xi)}{u^s} + O\left(\frac{1}{u^n}\right) \right), \quad \xi \in \Delta_1(\alpha_1),$$

**2.8.12**

$$W_{n,2}(u, \xi) = e^{-u\xi} \left( \sum_{s=0}^{n-1} (-1)^s \frac{A_s(\xi)}{u^s} + O\left(\frac{1}{u^n}\right) \right), \quad \xi \in \Delta_2(\alpha_2),$$

with  $A_0(\xi) = 1$  and

**2.8.13**

$$A_{s+1}(\xi) = -\frac{1}{2}A'_s(\xi) + \frac{1}{2} \int \psi(\xi)A_s(\xi) d\xi, \quad s = 0, 1, 2, \dots,$$

(the constants of integration being arbitrary). The expansions (2.8.11) and (2.8.12) are both uniform and differentiable with respect to  $\xi$ . The regions of validity  $\Delta_j(\alpha_j)$  comprise those points  $\xi$  that can be joined to  $\alpha_j$  in  $\Delta$  by a path  $\mathcal{Q}_j$  along which  $\Re v$  is nondecreasing ( $j = 1$ ) or nonincreasing ( $j = 2$ ) as  $v$  passes from  $\alpha_j$  to  $\xi$ . In addition,  $\mathcal{V}_{\mathcal{Q}_j}(A_1)$  and  $\mathcal{V}_{\mathcal{Q}_j}(A_n)$  must be bounded on  $\Delta_j(\alpha_j)$ .

For error bounds, extensions to pure imaginary or complex  $u$ , an extension to inhomogeneous differential equations, and examples, see Olver (1997b, Chapter 10). This reference also supplies sufficient conditions to ensure that the solutions  $W_{n,1}(u, \xi)$  and  $W_{n,2}(u, \xi)$  having the properties (2.8.11) and (2.8.12) are independent of  $n$ .

**2.8(iii) Case II: Simple Turning Point**

The transformed differential equation is

**2.8.14** 
$$d^2W/d\xi^2 = (u^2\xi + \psi(\xi))W,$$

and for simplicity  $\xi$  is assumed to range over a finite or infinite interval  $(\alpha_1, \alpha_2)$  with  $\alpha_1 < 0$ ,  $\alpha_2 > 0$ . Again,  $u > 0$  and  $\psi(\xi)$  is  $C^\infty$  on  $(\alpha_1, \alpha_2)$ . Corresponding to each positive integer  $n$  there are solutions  $W_{n,j}(u, \xi)$ ,  $j = 1, 2$ , that are  $C^\infty$  on  $(\alpha_1, \alpha_2)$ , and as  $u \rightarrow \infty$

---

**2.8.15** 
$$W_{n,1}(u, \xi) = \text{Ai}(u^{2/3}\xi) \left( \sum_{s=0}^{n-1} \frac{A_s(\xi)}{u^{2s}} + O\left(\frac{1}{u^{2n-1}}\right) \right) + \text{Ai}'(u^{2/3}\xi) \left( \sum_{s=0}^{n-2} \frac{B_s(\xi)}{u^{2s+(4/3)}} + O\left(\frac{1}{u^{2n-1}}\right) \right),$$

**2.8.16** 
$$W_{n,2}(u, \xi) = \text{Bi}(u^{2/3}\xi) \left( \sum_{s=0}^{n-1} \frac{A_s(\xi)}{u^{2s}} + O\left(\frac{1}{u^{2n-1}}\right) \right) + \text{Bi}'(u^{2/3}\xi) \left( \sum_{s=0}^{n-2} \frac{B_s(\xi)}{u^{2s+(4/3)}} + O\left(\frac{1}{u^{2n-1}}\right) \right).$$

Here  $A_0(\xi) = 1$ ,

**2.8.17** 
$$B_s(\xi) = \begin{cases} \frac{1}{2\xi^{1/2}} \int_0^\xi (\psi(v)A_s(v) - A_s''(v)) \frac{dv}{v^{1/2}}, & \xi > 0, \\ \frac{1}{2(-\xi)^{1/2}} \int_\xi^0 (\psi(v)A_s(v) - A_s''(v)) \frac{dv}{(-v)^{1/2}}, & \xi < 0, \end{cases}$$

and

**2.8.18** 
$$A_{s+1}(\xi) = -\frac{1}{2}B'_s(\xi) + \frac{1}{2} \int \psi(\xi)B_s(\xi) d\xi,$$

when  $s = 0, 1, 2, \dots$ . For Ai and Bi see §9.2. The expansions (2.8.15) and (2.8.16) are both uniform and differentiable with respect to  $\xi$ . These results are valid when  $\mathcal{V}_{\alpha_1, \alpha_2}(|\xi|^{1/2}B_0)$  and  $\mathcal{V}_{\alpha_1, \alpha_2}(|\xi|^{1/2}B_{n-1})$  are finite.

An alternative way of representing the error terms in (2.8.15) and (2.8.16) is as follows. Let  $c = -0.36604\dots$  be the real root of the equation

**2.8.19** 
$$\text{Ai}(x) = \text{Bi}(x)$$

of smallest absolute value, and define the envelopes of

$\text{Ai}(x)$  and  $\text{Bi}(x)$  by

**2.8.20** 
$$\text{env Ai}(x) = \text{env Bi}(x) = (\text{Ai}^2(x) + \text{Bi}^2(x))^{1/2}, \quad -\infty < x \leq c,$$

**2.8.21** 
$$\text{env Ai}(x) = \sqrt{2} \text{Ai}(x), \quad \text{env Bi}(x) = \sqrt{2} \text{Bi}(x), \quad c \leq x < \infty.$$

These envelopes are continuous functions of  $x$ , and as  $u \rightarrow \infty$

$$\begin{aligned}
2.8.22 \quad W_{n,1}(u, \xi) &= \text{Ai}\left(u^{2/3}\xi\right) \sum_{s=0}^{n-1} \frac{A_s(\xi)}{u^{2s}} \\
&+ \text{Ai}'\left(u^{2/3}\xi\right) \sum_{s=0}^{n-2} \frac{B_s(\xi)}{u^{2s+(4/3)}} \\
&+ \text{env Ai}\left(u^{2/3}\xi\right) O\left(\frac{1}{u^{2n-1}}\right),
\end{aligned}$$

$$\begin{aligned}
2.8.23 \quad W_{n,2}(u, \xi) &= \text{Bi}\left(u^{2/3}\xi\right) \sum_{s=0}^{n-1} \frac{A_s(\xi)}{u^{2s}} \\
&+ \text{Bi}'\left(u^{2/3}\xi\right) \sum_{s=0}^{n-2} \frac{B_s(\xi)}{u^{2s+(4/3)}} \\
&+ \text{env Bi}\left(u^{2/3}\xi\right) O\left(\frac{1}{u^{2n-1}}\right),
\end{aligned}$$

uniformly with respect to  $\xi \in (\alpha_1, \alpha_2)$ .

For error bounds, more delicate error estimates, extensions to complex  $\xi$  and  $u$ , zeros, connection formulas, extensions to inhomogeneous equations, and examples,

see Olver (1997b, Chapters 11, 13), Olver (1964b), Reid (1974a,b), Boyd (1987), and Baldwin (1991).

For other examples of uniform asymptotic approximations and expansions of special functions in terms of Airy functions see especially §10.20 and §§12.10(vii), 12.10(viii); also §§12.14(ix), 13.20(v), 13.21(iii), 13.21(iv), 15.12(iii), 18.15(iv), 30.9(i), 30.9(ii), 32.11(ii), 32.11(iii), 33.12(i), 33.12(ii), 33.20(iv), 36.12(ii), 36.13.

### 2.8(iv) Case III: Simple Pole

The transformed equation (2.8.8) is renormalized as

$$2.8.24 \quad \frac{d^2 W}{d\xi^2} = \left( \frac{u^2}{4\xi} + \frac{\nu^2 - 1}{4\xi^2} + \frac{\psi(\xi)}{\xi} \right) W.$$

We again assume  $\xi \in (\alpha_1, \alpha_2)$  with  $-\infty \leq \alpha_1 < 0$ ,  $0 < \alpha_2 \leq \infty$ . Also,  $\psi(\xi)$  is  $C^\infty$  on  $(\alpha_1, \alpha_2)$ , and  $u > 0$ . The constant  $\nu (= \sqrt{1+4\rho})$  is real and nonnegative.

There are two cases:  $\xi \in (0, \alpha_2)$  and  $\xi \in (\alpha_1, 0)$ . In the former, corresponding to any positive integer  $n$  there are solutions  $W_{n,j}(u, \xi)$ ,  $j = 1, 2$ , that are  $C^\infty$  on  $(0, \alpha_2)$ , and as  $u \rightarrow \infty$

$$2.8.25 \quad W_{n,1}(u, \xi) = \xi^{1/2} I_\nu(u\xi^{1/2}) \sum_{s=0}^{n-1} \frac{A_s(\xi)}{u^{2s}} + \xi I_{\nu+1}(u\xi^{1/2}) \sum_{s=0}^{n-2} \frac{B_s(\xi)}{u^{2s+1}} + \xi^{1/2} I_\nu(u\xi^{1/2}) O\left(\frac{1}{u^{2n-1}}\right),$$

$$2.8.26 \quad W_{n,2}(u, \xi) = \xi^{1/2} K_\nu(u\xi^{1/2}) \sum_{s=0}^{n-1} \frac{A_s(\xi)}{u^{2s}} - \xi K_{\nu+1}(u\xi^{1/2}) \sum_{s=0}^{n-2} \frac{B_s(\xi)}{u^{2s+1}} + \xi^{1/2} K_\nu(u\xi^{1/2}) O\left(\frac{1}{u^{2n-1}}\right).$$

Here  $A_0(\xi) = 1$ ,

$$2.8.27 \quad B_s(\xi) = -A'_s(\xi) + \frac{1}{\xi^{1/2}} \int_0^\xi (\psi(v)A_s(v) - (\nu + \frac{1}{2})A'_s(v)) \frac{dv}{v^{1/2}},$$

$$2.8.28 \quad A_{s+1}(\xi) = \nu B_s(\xi) - \xi B'_s(\xi) + \int \psi(\xi)B_s(\xi) d\xi,$$

$s = 0, 1, 2, \dots$ . For  $I_\nu$  and  $K_\nu$  see §10.25(ii). The expansions (2.8.25) and (2.8.26) are both uniform and differentiable with respect to  $\xi$ . These results are valid when  $\mathcal{V}_{0,\alpha_2}(\xi^{1/2}B_0)$  and  $\mathcal{V}_{0,\alpha_2}(\xi^{1/2}B_{n-1})$  are finite.

If  $\xi \in (\alpha_1, 0)$ , then there are solutions  $W_{n,j}(u, \xi)$ ,  $j = 3, 4$ , that are  $C^\infty$  on  $(\alpha_1, 0)$ , and as  $u \rightarrow \infty$

$$2.8.29 \quad W_{n,3}(u, \xi) = |\xi|^{1/2} J_\nu(u|\xi|^{1/2}) \left( \sum_{s=0}^{n-1} \frac{A_s(\xi)}{u^{2s}} + O\left(\frac{1}{u^{2n-1}}\right) \right) - |\xi| J_{\nu+1}(u|\xi|^{1/2}) \left( \sum_{s=0}^{n-2} \frac{B_s(\xi)}{u^{2s+1}} + O\left(\frac{1}{u^{2n-2}}\right) \right),$$

$$2.8.30 \quad W_{n,4}(u, \xi) = |\xi|^{1/2} Y_\nu(u|\xi|^{1/2}) \left( \sum_{s=0}^{n-1} \frac{A_s(\xi)}{u^{2s}} + O\left(\frac{1}{u^{2n-1}}\right) \right) - |\xi| Y_{\nu+1}(u|\xi|^{1/2}) \left( \sum_{s=0}^{n-2} \frac{B_s(\xi)}{u^{2s+1}} + O\left(\frac{1}{u^{2n-2}}\right) \right).$$

Here  $A_0(\xi) = 1$ ,

$$2.8.31 \quad B_s(\xi) = -A'_s(\xi) + \frac{1}{|\xi|^{1/2}} \int_\xi^0 (\psi(v)A_s(v) - (\nu + \frac{1}{2})A'_s(v)) \frac{dv}{|v|^{1/2}},$$

$s = 0, 1, 2, \dots$ , and (2.8.28) again applies. For  $J_\nu$  and  $Y_\nu$  see §10.2(ii). The expansions (2.8.29) and (2.8.30) are both uniform and differentiable with respect to  $\xi$ . These results are valid when  $\mathcal{V}_{\alpha_1,0}(|\xi|^{1/2}B_0)$  and  $\mathcal{V}_{\alpha_1,0}(|\xi|^{1/2}B_{n-1})$  are finite.

Again, an alternative way of representing the error terms in (2.8.29) and (2.8.30) is by means of envelope functions. Let  $x = X_\nu$  be the smallest positive root of the equation

$$2.8.32 \quad J_\nu(x) + Y_\nu(x) = 0.$$

Define

$$2.8.33 \quad \text{env } J_\nu(x) = \sqrt{2} J_\nu(x), \quad \text{env } Y_\nu(x) = \sqrt{2} |Y_\nu(x)|, \quad 0 < x \leq X_\nu,$$

$$2.8.34 \quad \text{env } J_\nu(x) = \text{env } Y_\nu(x) = (J_\nu^2(x) + Y_\nu^2(x))^{1/2}, \quad X_\nu \leq x < \infty.$$

Then as  $u \rightarrow \infty$

$$2.8.35 \quad W_{n,3}(u, \xi) = |\xi|^{1/2} J_\nu(u|\xi|^{1/2}) \sum_{s=0}^{n-1} \frac{A_s(\xi)}{u^{2s}} - |\xi| J_{\nu+1}(u|\xi|^{1/2}) \sum_{s=0}^{n-2} \frac{B_s(\xi)}{u^{2s+1}} + |\xi|^{1/2} \text{env } J_\nu(u|\xi|^{1/2}) O\left(\frac{1}{u^{2n-1}}\right),$$

$$2.8.36 \quad W_{n,4}(u, \xi) = |\xi|^{1/2} Y_\nu(u|\xi|^{1/2}) \sum_{s=0}^{n-1} \frac{A_s(\xi)}{u^{2s}} - |\xi| Y_{\nu+1}(u|\xi|^{1/2}) \sum_{s=0}^{n-2} \frac{B_s(\xi)}{u^{2s+1}} + |\xi|^{1/2} \text{env } Y_\nu(u|\xi|^{1/2}) O\left(\frac{1}{u^{2n-1}}\right),$$

uniformly with respect to  $\xi \in (\alpha_1, 0)$ .

For error bounds, more delicate error estimates, extensions to complex  $\xi$ ,  $\nu$ , and  $u$ , zeros, and examples see Olver (1997b, Chapter 12), Boyd (1990a), and Dunster (1990a).

For other examples of uniform asymptotic approximations and expansions of special functions in terms of Bessel functions or modified Bessel functions of fixed order see §§13.8(iii), 13.21(i), 13.21(iv), 14.15(i), 14.15(iii), 14.20(vii), 15.12(iii), 18.15(i), 18.15(iv), 18.24, 33.20(iv).

## 2.8(v) Multiple and Fractional Turning Points

The approach used in preceding subsections for equation (2.8.1) also succeeds when  $z_0$  is a *multiple* or *fractional turning point*. For the former  $f(z)$  has a zero of multiplicity  $\lambda = 2, 3, 4, \dots$  and  $g(z)$  is analytic. For the latter  $(z - z_0)^{-\lambda} f(z)$  and  $g(z)$  are both analytic at  $z_0$ ,  $\lambda (> -2)$  being a real constant. In both cases uniform asymptotic approximations are obtained in terms of Bessel functions of order  $1/(\lambda + 2)$ . More generally,  $g(z)$  can have a simple or double pole at  $z_0$ . (In the case of the double pole the order of the approximating Bessel functions is fixed but no longer  $1/(\lambda + 2)$ .) However, in all cases with  $\lambda > -2$  and  $\lambda \neq 0$  or  $\pm 1$ , only uniform asymptotic approximations are available, not uniform asymptotic expansions. For results, including error bounds, see Olver (1977c).

For connection formulas for Liouville–Green approximations across these transition points see Olver (1977b,a, 1978).

## 2.8(vi) Coalescing Transition Points

Corresponding to the problems for integrals outlined in §§2.3(v), 2.4(v), and 2.4(vi), there are analogous problems for differential equations.

For two coalescing turning points see Olver (1975a, 1976) and Dunster (1996a); in this case the uniform

approximants are parabolic cylinder functions. (For envelope functions for parabolic cylinder functions see §14.15(v)).

For a coalescing turning point and double pole see Boyd and Dunster (1986) and Dunster (1990b); in this case the uniform approximants are Bessel functions of variable order.

For a coalescing turning point and simple pole see Nestor (1984) and Dunster (1994b); in this case the uniform approximants are Whittaker functions (§13.14(i)) with a fixed value of the second parameter.

For further examples of uniform asymptotic approximations in terms of parabolic cylinder functions see §§13.20(iii), 13.20(iv), 14.15(v), 15.12(iii), 18.24.

For further examples of uniform asymptotic approximations in terms of Bessel functions or modified Bessel functions of variable order see §§13.21(ii), 14.15(ii), 14.15(iv), 14.20(viii), 30.9(i), 30.9(ii).

For examples of uniform asymptotic approximations in terms of Whittaker functions with fixed second parameter see §18.15(i) and §28.8(iv).

Lastly, for an example of a fourth-order differential equation, see Wong and Zhang (2007).

## 2.9 Difference Equations

### 2.9(i) Distinct Characteristic Values

Many special functions that depend on parameters satisfy a three-term linear recurrence relation

$$2.9.1 \quad w(n+2) + f(n)w(n+1) + g(n)w(n) = 0, \\ n = 0, 1, 2, \dots,$$

or equivalently the second-order homogeneous linear difference equation

$$2.9.2 \quad \Delta^2 w(n) + (2 + f(n)) \Delta w(n) \\ + (1 + f(n) + g(n))w(n) = 0, \quad n = 0, 1, 2, \dots,$$

in which  $\Delta$  is the forward difference operator (§3.6(i)).

Often  $f(n)$  and  $g(n)$  can be expanded in series

$$2.9.3 \quad f(n) \sim \sum_{s=0}^{\infty} \frac{f_s}{n^s}, \quad g(n) \sim \sum_{s=0}^{\infty} \frac{g_s}{n^s}, \quad n \rightarrow \infty,$$

with  $g_0 \neq 0$ . (For the case  $g_0 = 0$  see the final paragraph of §2.9(ii) with  $Q$  negative.) This situation is analogous to second-order homogeneous linear differential equations with an irregular singularity of rank 1 at

$$2.9.7 \quad \rho_j(f_0 + 2\rho_j)sa_{s,j} = \sum_{r=1}^s \left( \rho_j^2 2^{r+1} \binom{\alpha_j + r - s}{r+1} \right) + \rho_j \sum_{q=0}^{r+1} \binom{\alpha_j + r - s}{r+1 - q} f_q + g_{r+1} \Big) a_{s-r,j},$$

$s = 1, 2, 3, \dots$ . The construction fails iff  $\rho_1 = \rho_2$ , that is, when  $f_0^2 = 4g_0$ .

When  $f_0^2 \neq 4g_0$ , there are linearly independent solutions  $w_j(n)$ ,  $j = 1, 2$ , such that

$$2.9.8 \quad w_j(n) \sim \rho_j^n n^{\alpha_j} \sum_{s=0}^{\infty} \frac{a_{s,j}}{n^s}, \quad n \rightarrow \infty.$$

If  $|\rho_2| > |\rho_1|$ , or if  $|\rho_2| = |\rho_1|$  and  $\Re\alpha_2 > \Re\alpha_1$ , then  $w_1(n)$  is recessive and  $w_2(n)$  is dominant as  $n \rightarrow \infty$ . As in the case of differential equations (§§2.7(iii), 2.7(iv)) recessive solutions are unique and dominant solutions are not; furthermore, one member of a numerically satisfactory pair has to be recessive. When  $|\rho_2| = |\rho_1|$  and  $\Re\alpha_2 = \Re\alpha_1$  neither solution is dominant and both are unique.

For proofs see Wong and Li (1992a). For error bounds see Zhang *et al.* (1996). See also Olver (1967b).

For asymptotic expansions in inverse factorial series see Olde Daalhuis (2004a).

## 2.9(ii) Coincident Characteristic Values

When the roots of (2.9.5) are equal we denote them both by  $\rho$ . Assume first  $2g_1 \neq f_0f_1$ . Then (2.9.1) has independent solutions  $w_j(n)$ ,  $j = 1, 2$ , such that

$$2.9.9 \quad w_j(n) \sim \rho^n \exp((-1)^j \kappa \sqrt{n}) n^\alpha \sum_{s=0}^{\infty} (-1)^{js} \frac{c_s}{n^{s/2}},$$

where

$$2.9.10 \quad \sqrt{g_0\kappa} = \sqrt{2f_0f_1 - 4g_1}, \quad 4g_0\alpha = g_0 + 2g_1, \quad c_0 = 1, \text{ and higher coefficients are determined by formal substitution.}$$

Alternatively, suppose that  $2g_1 = f_0f_1$ . Then the indices  $\alpha_1, \alpha_2$  are the roots of

$$2.9.11 \quad 2g_0\alpha^2 - (f_0f_1 + 2g_0)\alpha + 2g_2 - f_0f_2 = 0.$$

infinity (§2.7(ii)). Formal solutions are

$$2.9.4 \quad \rho_j^n n^{\alpha_j} \sum_{s=0}^{\infty} \frac{a_{s,j}}{n^s}, \quad j = 1, 2,$$

where  $\rho_1, \rho_2$  are the roots of the characteristic equation

$$2.9.5 \quad \rho^2 + f_0\rho + g_0 = 0,$$

$$2.9.6 \quad \alpha_j = (f_1\rho_j + g_1)/(f_0\rho_j + 2g_0), \quad a_{0,j} = 1, \text{ and}$$

Provided that  $\alpha_2 - \alpha_1$  is not zero or an integer, (2.9.1) has independent solutions  $w_j(n)$ ,  $j = 1, 2$ , of the form

$$2.9.12 \quad w_j(n) \sim \rho^n n^{\alpha_j} \sum_{s=0}^{\infty} \frac{a_{s,j}}{n^s}, \quad n \rightarrow \infty,$$

with  $a_{0,j} = 1$  and higher coefficients given by (2.9.7) (in the present case the coefficients of  $a_{s,j}$  and  $a_{s-1,j}$  are zero).

If  $\alpha_2 - \alpha_1 = 0, 1, 2, \dots$ , then (2.9.12) applies only in the case  $j = 1$ . But there is an independent solution

$$2.9.13 \quad w_2(n) \sim \rho^n n^{\alpha_2} \sum_{\substack{s=0 \\ s \neq \alpha_2 - \alpha_1}}^{\infty} \frac{b_s}{n^s} + cw_1(n) \ln n, \quad n \rightarrow \infty.$$

The coefficients  $b_s$  and constant  $c$  are again determined by formal substitution, beginning with  $c = 1$  when  $\alpha_2 - \alpha_1 = 0$ , or with  $b_0 = 1$  when  $\alpha_2 - \alpha_1 = 1, 2, 3, \dots$  (Compare (2.7.6).)

For proofs and examples, see Wong and Li (1992a). For error bounds see Zhang *et al.* (1996).

For analogous results for difference equations of the form

$$2.9.14 \quad w(n+2) + n^P f(n)w(n+1) + n^Q g(n)w(n) = 0, \text{ in which } P \text{ and } Q \text{ are any integers see Wong and Li (1992b).}$$

## 2.9(iii) Other Approximations

For asymptotic approximations to solutions of second-order difference equations analogous to the Liouville–Green (WKBJ) approximation for differential equations (§2.7(iii)) see Spigler and Vianello (1992, 1997) and Spigler *et al.* (1999). Error bounds and applications are included.

For discussions of turning points, transition points, and uniform asymptotic expansions for solutions of linear difference equations of the second order see Wang and Wong (2003, 2005).

For an introduction to, and references for, the general asymptotic theory of linear difference equations of arbitrary order, see Wimp (1984, Appendix B).

## 2.10 Sums and Sequences

### 2.10(i) Euler–Maclaurin Formula

As in §24.2, let  $B_n$  and  $B_n(x)$  denote the  $n$ th Bernoulli number and polynomial, respectively, and  $\tilde{B}_n(x)$  the  $n$ th Bernoulli periodic function  $B_n(x - [x])$ .

Assume that  $a, m$ , and  $n$  are integers such that  $n > a$ ,  $m > 0$ , and  $f^{(2m)}(x)$  is absolutely integrable over  $[a, n]$ . Then

$$\begin{aligned} 2.10.1 \quad \sum_{j=a}^n f(j) &= \int_a^n f(x) dx + \frac{1}{2}f(a) + \frac{1}{2}f(n) \\ &+ \sum_{s=1}^{m-1} \frac{B_{2s}}{(2s)!} \left( f^{(2s-1)}(n) - f^{(2s-1)}(a) \right) \\ &+ \int_a^n \frac{B_{2m} - \tilde{B}_{2m}(x)}{(2m)!} f^{(2m)}(x) dx. \end{aligned}$$

This is the *Euler–Maclaurin formula*. Another version is the *Abel–Plana formula*:

$$\begin{aligned} 2.10.2 \quad \sum_{j=a}^n f(j) &= \int_a^n f(x) dx + \frac{1}{2}f(a) + \frac{1}{2}f(n) \\ &- 2 \int_0^\infty \frac{\Im(f(a + iy))}{e^{2\pi y} - 1} dy \\ &+ \sum_{s=1}^m \frac{B_{2s}}{(2s)!} f^{(2s-1)}(n) \\ &+ 2 \frac{(-1)^m}{(2m)!} \int_0^\infty \Im(f^{(2m)}(n + i\vartheta_n y)) \frac{y^{2m} dy}{e^{2\pi y} - 1}, \end{aligned}$$

$\vartheta_n$  being some number in the interval  $(0, 1)$ . Sufficient conditions for the validity of this second result are:

- (a) On the strip  $a \leq \Re z \leq n$ ,  $f(z)$  is analytic in its interior,  $f^{(2m)}(z)$  is continuous on its closure, and  $f(z) = o(e^{2\pi|\Im z|})$  as  $\Im z \rightarrow \pm\infty$ , uniformly with respect to  $\Re z \in [a, n]$ .
- (b)  $f(z)$  is real when  $a \leq z \leq n$ .
- (c) The first infinite integral in (2.10.2) converges.

### Example

$$2.10.3 \quad S(n) = \sum_{j=1}^n j \ln j$$

for large  $n$ . From (2.10.1)

$$\begin{aligned} 2.10.4 \quad S(n) &= \frac{1}{2}n^2 \ln n - \frac{1}{4}n^2 + \frac{1}{2}n \ln n + \frac{1}{12} \ln n + C \\ &+ \sum_{s=2}^{m-1} \frac{(-B_{2s})}{2s(2s-1)(2s-2)} \frac{1}{n^{2s-2}} + R_m(n), \end{aligned}$$

where  $m (\geq 2)$  is arbitrary,  $C$  is a constant, and

$$2.10.5 \quad R_m(n) = \int_n^\infty \frac{\tilde{B}_{2m}(x) - B_{2m}}{2m(2m-1)x^{2m-1}} dx.$$

From §24.12(i), (24.2.2), and (24.4.27),  $\tilde{B}_{2m}(x) - B_{2m}$  is of constant sign  $(-1)^m$ . Thus  $R_m(n)$  and  $R_{m+1}(n)$  are of opposite signs, and since their difference is the term corresponding to  $s = m$  in (2.10.4),  $R_m(n)$  is bounded in absolute value by this term and has the same sign.

Formula (2.10.2) is useful for evaluating the constant term in expansions obtained from (2.10.1). In the present example it leads to

$$2.10.6 \quad C = \frac{\gamma + \ln(2\pi)}{12} - \frac{\zeta'(2)}{2\pi^2} = \frac{1}{12} - \zeta'(-1),$$

where  $\gamma$  is Euler's constant (§5.2(ii)) and  $\zeta'$  is the derivative of the Riemann zeta function (§25.2(i)).  $e^C$  is sometimes called *Glaisher's constant*. For further information on  $C$  see §5.17.

Other examples that can be verified in a similar way are:

$$2.10.7 \quad \sum_{j=1}^{n-1} j^\alpha \sim \zeta(-\alpha) + \frac{n^{\alpha+1}}{\alpha+1} \sum_{s=0}^\infty \binom{\alpha+1}{s} \frac{B_s}{n^s}, \quad n \rightarrow \infty,$$

where  $\alpha (\neq -1)$  is a real constant, and

$$2.10.8 \quad \sum_{j=1}^{n-1} \frac{1}{j} \sim \ln n + \gamma - \frac{1}{2n} - \sum_{s=1}^\infty \frac{B_{2s}}{2s} \frac{1}{n^{2s}}, \quad n \rightarrow \infty.$$

In both expansions the remainder term is bounded in absolute value by the first neglected term in the sum, and has the same sign, provided that in the case of (2.10.7), truncation takes place at  $s = 2m - 1$ , where  $m$  is any positive integer satisfying  $m \geq \frac{1}{2}(\alpha + 1)$ .

For extensions of the Euler–Maclaurin formula to functions  $f(x)$  with singularities at  $x = a$  or  $x = n$  (or both) see Sidi (2004). See also Weniger (2007).

For an extension to integrals with Cauchy principal values see Elliott (1998).

### 2.10(ii) Summation by Parts

The formula for summation by parts is

$$2.10.9 \quad \sum_{j=1}^{n-1} u_j v_j = U_{n-1} v_n + \sum_{j=1}^{n-1} U_j (v_j - v_{j+1}),$$



where

**2.10.10** 
$$U_j = u_1 + u_2 + \cdots + u_j.$$

This identity can be used to find asymptotic approximations for large  $n$  when the factor  $v_j$  changes slowly with  $j$ , and  $u_j$  is oscillatory; compare the approximation of Fourier integrals by integration by parts in §2.3(i).

**Example**

**2.10.11** 
$$S(\alpha, \beta, n) = \sum_{j=1}^{n-1} e^{ij\beta} j^\alpha,$$

where  $\alpha$  and  $\beta$  are real constants with  $e^{i\beta} \neq 1$ .

As a first estimate for large  $n$

**2.10.12**

$$|S(\alpha, \beta, n)| \leq \sum_{j=1}^{n-1} j^\alpha = O(1), O(\ln n), \text{ or } O(n^{\alpha+1}),$$

according as  $\alpha < -1$ ,  $\alpha = -1$ , or  $\alpha > -1$ ; see (2.10.7), (2.10.8). With  $u_j = e^{ij\beta}$ ,  $v_j = j^\alpha$ ,

**2.10.13** 
$$U_j = e^{i\beta}(e^{ij\beta} - 1)/(e^{i\beta} - 1),$$

and

**2.10.14** 
$$S(\alpha, \beta, n) = \frac{e^{i\beta}}{e^{i\beta} - 1} \left( e^{i(n-1)\beta} n^\alpha - 1 + \sum_{j=1}^{n-1} e^{ij\beta} (j^\alpha - (j+1)^\alpha) \right).$$

Since

**2.10.15**  $j^\alpha - (j+1)^\alpha = -\alpha j^{\alpha-1} + \alpha(\alpha-1)O(j^{\alpha-2})$  for any real constant  $\alpha$  and the set of all positive integers  $j$ , we derive

**2.10.16**

$$S(\alpha, \beta, n) = \frac{e^{i\beta}}{e^{i\beta} - 1} \left( e^{i(n-1)\beta} n^\alpha - \alpha S(\alpha-1, \beta, n) + O(n^{\alpha-1}) + O(1) \right).$$

From this result and (2.10.12)

**2.10.17** 
$$S(\alpha, \beta, n) = O(n^\alpha) + O(1).$$

Then replacing  $\alpha$  by  $\alpha - 1$  and resubstituting in (2.10.16), we have

**2.10.18**

$$S(\alpha, \beta, n) = \frac{e^{in\beta}}{e^{i\beta} - 1} n^\alpha + O(n^{\alpha-1}) + O(1), \quad n \rightarrow \infty,$$

which is a useful approximation when  $\alpha > 0$ .

For extensions to  $\alpha \leq 0$ , higher terms, and other examples, see Olver (1997b, Chapter 8).

**2.10(iii) Asymptotic Expansions of Entire Functions**

The asymptotic behavior of entire functions defined by Maclaurin series can be approached by converting the sum into a contour integral by use of the residue theorem and applying the methods of §§2.4 and 2.5.

**Example**

From §§16.2(i)–16.2(ii)

**2.10.19** 
$${}_0F_2(-; 1, 1; x) = \sum_{j=0}^{\infty} \frac{x^j}{(j!)^3}.$$

We seek the behavior as  $x \rightarrow +\infty$ . From (1.10.8)

**2.10.20** 
$$\sum_{j=0}^{n-1} \frac{x^j}{(j!)^3} = \frac{1}{2i} \int_{\mathcal{C}} \frac{x^t}{(\Gamma(t+1))^3} \cot(\pi t) dt,$$

where  $\mathcal{C}$  comprises the two semicircles and two parts of the imaginary axis depicted in Figure 2.10.1.

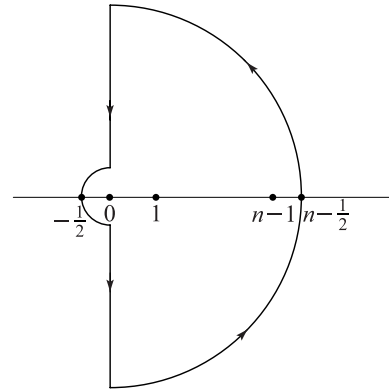


Figure 2.10.1:  $t$ -plane. Contour  $\mathcal{C}$ .

From the identities

**2.10.21** 
$$\frac{\cot(\pi t)}{2i} = -\frac{1}{2} - \frac{1}{e^{-2\pi it} - 1} = \frac{1}{2} + \frac{1}{e^{2\pi it} - 1},$$

and Cauchy's theorem, we have

**2.10.22** 
$$\sum_{j=0}^{n-1} \frac{x^j}{(j!)^3} = \int_{-1/2}^{n-(1/2)} \frac{x^t}{(\Gamma(t+1))^3} dt - \int_{\mathcal{C}_1} \frac{x^t}{(\Gamma(t+1))^3} \frac{dt}{e^{-2\pi it} - 1} + \int_{\mathcal{C}_2} \frac{x^t}{(\Gamma(t+1))^3} \frac{dt}{e^{2\pi it} - 1},$$

where  $\mathcal{C}_1, \mathcal{C}_2$  denote respectively the upper and lower halves of  $\mathcal{C}$ . (5.11.7) shows that the integrals around the large quarter circles vanish as  $n \rightarrow \infty$ . Hence

**2.10.23**

$$\begin{aligned} {}_0F_2(-; 1, 1; x) &= \int_{-1/2}^{\infty} \frac{x^t}{(\Gamma(t+1))^3} dt \\ &+ 2\Re \int_{-1/2}^{i\infty} \frac{x^t}{(\Gamma(t+1))^3} \frac{dt}{e^{-2\pi it} - 1} \\ &= \int_0^{\infty} \frac{x^t}{(\Gamma(t+1))^3} dt + O(1), \end{aligned}$$

$x \rightarrow +\infty,$

the last step following from  $|x^t| \leq 1$  when  $t$  is on the interval  $[-\frac{1}{2}, 0]$ , the imaginary axis, or the small semi-circle. By application of Laplace's method (§2.3(iii)) and use again of (5.11.7), we obtain

$$2.10.24 \quad {}_0F_2(-; 1, 1; x) \sim \frac{\exp(3x^{1/3})}{2\pi 3^{1/2} x^{1/3}}, \quad x \rightarrow +\infty.$$

For generalizations and other examples see Olver (1997b, Chapter 8), Ford (1960), and Berndt and Evans (1984). See also Paris and Kaminski (2001, Chapter 5) and §§16.11(i)–16.11(ii).

**2.10(iv) Taylor and Laurent Coefficients:  
Darboux's Method**

Let  $f(z)$  be analytic on the annulus  $0 < |z| < r$ , with Laurent expansion

$$2.10.25 \quad f(z) = \sum_{n=-\infty}^{\infty} f_n z^n, \quad 0 < |z| < r.$$

What is the asymptotic behavior of  $f_n$  as  $n \rightarrow \infty$  or  $n \rightarrow -\infty$ ? More specially, what is the behavior of the higher coefficients in a Taylor-series expansion?

These problems can be brought within the scope of §2.4 by means of Cauchy's integral formula

$$2.10.26 \quad f_n = \frac{1}{2\pi i} \int_{\mathcal{C}} \frac{f(z)}{z^{n+1}} dz,$$

where  $\mathcal{C}$  is a simple closed contour in the annulus that encloses  $z = 0$ . For examples see Olver (1997b, Chapters 8, 9).

However, if  $r$  is finite and  $f(z)$  has algebraic or logarithmic singularities on  $|z| = r$ , then *Darboux's method* is usually easier to apply. We need a "comparison function"  $g(z)$  with the properties:

- (a)  $g(z)$  is analytic on  $0 < |z| < r$ .
- (b)  $f(z) - g(z)$  is continuous on  $0 < |z| \leq r$ .
- (c) The coefficients in the Laurent expansion

$$2.10.27 \quad g(z) = \sum_{n=-\infty}^{\infty} g_n z^n, \quad 0 < |z| < r,$$

have known asymptotic behavior as  $n \rightarrow \pm\infty$ .

By allowing the contour in Cauchy's formula to expand, we find that

$$2.10.28 \quad \begin{aligned} f_n - g_n &= \frac{1}{2\pi i} \int_{|z|=r} \frac{f(z) - g(z)}{z^{n+1}} dz \\ &= \frac{1}{2\pi r^n} \int_0^{2\pi} (f(re^{i\theta}) - g(re^{i\theta})) e^{-ni\theta} d\theta. \end{aligned}$$

Hence by the Riemann–Lebesgue lemma (§1.8(i))

$$2.10.29 \quad f_n = g_n + o(r^{-n}), \quad n \rightarrow \pm\infty.$$

This result is refinable in two important ways. First, the conditions can be weakened. It is unnecessary for  $f(z) - g(z)$  to be continuous on  $|z| = r$ : it suffices that the integrals in (2.10.28) converge uniformly. For example, Condition (b) can be replaced by:

- (b') On the circle  $|z| = r$ , the function  $f(z) - g(z)$  has a finite number of singularities, and at each singularity  $z_j$ , say,

$$2.10.30 \quad f(z) - g(z) = O((z - z_j)^{\sigma_j - 1}), \quad z \rightarrow z_j,$$

where  $\sigma_j$  is a positive constant.

Secondly, when  $f(z) - g(z)$  is  $m$  times continuously differentiable on  $|z| = r$  the result (2.10.29) can be strengthened. In these circumstances the integrals in (2.10.28) are integrable by parts  $m$  times, yielding

$$2.10.31 \quad f_n = g_n + o(r^{-n} |n|^{-m}), \quad n \rightarrow \pm\infty.$$

Furthermore, (2.10.31) remains valid with the weaker condition

$$2.10.32 \quad f^{(m)}(z) - g^{(m)}(z) = O((z - z_j)^{\sigma_j - 1}),$$

in the neighborhood of each singularity  $z_j$ , again with  $\sigma_j > 0$ .

**Example**

Let  $\alpha$  be a constant in  $(0, 2\pi)$  and  $P_n$  denote the Legendre polynomial of degree  $n$ . From §14.7(iv)

$$2.10.33 \quad \begin{aligned} f(z) &\equiv \frac{1}{(1 - 2z \cos \alpha + z^2)^{1/2}} \\ &= \sum_{n=0}^{\infty} P_n(\cos \alpha) z^n, \quad |z| < 1. \end{aligned}$$

The singularities of  $f(z)$  on the unit circle are branch points at  $z = e^{\pm i\alpha}$ . To match the limiting behavior of  $f(z)$  at these points we set

$$2.10.34 \quad \begin{aligned} g(z) &= e^{-\pi i/4} (2 \sin \alpha)^{-1/2} (e^{-i\alpha} - z)^{-1/2} \\ &\quad + e^{\pi i/4} (2 \sin \alpha)^{-1/2} (e^{i\alpha} - z)^{-1/2}. \end{aligned}$$

Here the branch of  $(e^{-i\alpha} - z)^{-1/2}$  is continuous in the  $z$ -plane cut along the outward-drawn ray through  $z = e^{-i\alpha}$  and equals  $e^{i\alpha/2}$  at  $z = 0$ . Similarly for  $(e^{i\alpha} - z)^{-1/2}$ . In Condition (c) we have

$$2.10.35 \quad g_n = \left( \frac{2}{\pi \sin \alpha} \right)^{1/2} \frac{\Gamma(n + \frac{1}{2})}{n!} \cos(n\alpha + \frac{1}{2}\alpha - \frac{1}{4}\pi),$$

and in the supplementary conditions we may set  $m = 1$ . Then from (2.10.31) and (5.11.7)

$$2.10.36 \quad P_n(\cos \alpha) = \left( \frac{2}{\pi n \sin \alpha} \right)^{1/2} \cos(n\alpha + \frac{1}{2}\alpha - \frac{1}{4}\pi) + o(n^{-1}).$$

For higher terms see §18.15(iii).

For uniform expansions when two singularities coalesce on the circle of convergence see Wong and Zhao (2005).

For other examples and extensions see Olver (1997b, Chapter 8), Olver (1970), Wong (1989, Chapter 2), and Wong and Wyman (1974). See also Flajolet and Odlyzko (1990).

## 2.11 Remainder Terms; Stokes Phenomenon

### 2.11(i) Numerical Use of Asymptotic Expansions

When a rigorous bound or reliable estimate for the remainder term is unavailable, it is unsafe to judge the accuracy of an asymptotic expansion merely from the numerical rate of decrease of the terms at the point of truncation. Even when the series converges this is unwise: the tail needs to be majorized rigorously before the result can be guaranteed. For divergent expansions the situation is even more difficult. First, it is impossible to bound the tail by majorizing its terms. Secondly, the asymptotic series represents an infinite class of functions, and the remainder depends on which member we have in mind.

As an example consider

$$2.11.1 \quad I(m) = \int_0^\pi \frac{\cos(mt)}{t^2 + 1} dt,$$

with  $m$  a large integer. By integration by parts (§2.3(i))

$$2.11.2 \quad I(m) \sim (-1)^m \sum_{s=1}^{\infty} \frac{q_s(\pi)}{m^{2s}}, \quad m \rightarrow \infty,$$

with

$$2.11.3 \quad \begin{aligned} q_1(t) &= -\frac{2t}{(t^2 + 1)^2}, & q_2(t) &= \frac{24(t^3 - t)}{(t^2 + 1)^4}, \\ q_3(t) &= -\frac{240(3t^5 - 10t^3 + 3t)}{(t^2 + 1)^6}. \end{aligned}$$

On rounding to 5D, we have  $q_1(\pi) = -0.05318$ ,  $q_2(\pi) = 0.04791$ ,  $q_3(\pi) = -0.08985$ . Hence

$$2.11.4 \quad \begin{aligned} I(10) &\sim -0.00053 \ 18 + 0.00000 \ 48 - 0.00000 \ 01 \\ &= -0.00052 \ 71. \end{aligned}$$

But this answer is incorrect: to 7D  $I(10) = -0.00045 \ 58$ . The error term is, in fact, approximately 700 times the last term obtained in (2.11.4). The explanation is that (2.11.2) is a more accurate expansion for the function  $I(m) - \frac{1}{2}\pi e^{-m}$  than it is for  $I(m)$ ; see Olver (1997b, pp. 76–78).

In order to guard against this kind of error remaining undetected, the wanted function may need to be computed by another method (preferably nonasymptotic) for the smallest value of the (large) asymptotic variable

$x$  that is intended to be used. If the results agree within  $S$  significant figures, then it is likely—but *not certain*—that the truncated asymptotic series will yield at least  $S$  correct significant figures for larger values of  $x$ . For further discussion see Bosley (1996).

In  $\mathbb{C}$  both the modulus and phase of the asymptotic variable  $z$  need to be taken into account. Suppose an asymptotic expansion holds as  $z \rightarrow \infty$  in any closed sector within  $\alpha < \text{ph } z < \beta$ , say, but not in  $\alpha \leq \text{ph } z \leq \beta$ . Then numerical accuracy will disintegrate as the boundary rays  $\text{ph } z = \alpha$ ,  $\text{ph } z = \beta$  are approached. In consequence, practical application needs to be confined to a sector  $\alpha' \leq \text{ph } z \leq \beta'$  well within the sector of validity, and independent evaluations carried out on the boundaries for the smallest value of  $|z|$  intended to be used. The choice of  $\alpha'$  and  $\beta'$  is facilitated by a knowledge of the relevant Stokes lines; see §2.11(iv) below.

However, regardless whether we can bound the remainder, the accuracy achievable by direct numerical summation of a divergent asymptotic series is always limited. The rest of this section is devoted to general methods for increasing this accuracy.

### 2.11(ii) Connection Formulas

From §8.19(i) the generalized exponential integral is given by

$$2.11.5 \quad E_p(z) = \frac{e^{-z} z^{p-1}}{\Gamma(p)} \int_0^\infty \frac{e^{-zt} t^{p-1}}{1+t} dt$$

when  $\Re p > 0$  and  $|\text{ph } z| < \frac{1}{2}\pi$ , and by analytic continuation for other values of  $p$  and  $z$ . Application of Watson's lemma (§2.4(i)) yields

$$2.11.6 \quad E_p(z) \sim \frac{e^{-z}}{z} \sum_{s=0}^{\infty} (-1)^s \frac{(p)_s}{z^s}$$

when  $p$  is fixed and  $z \rightarrow \infty$  in any closed sector within  $|\text{ph } z| < \frac{3}{2}\pi$ . As noted in §2.11(i), poor accuracy is yielded by this expansion as  $\text{ph } z$  approaches  $\frac{3}{2}\pi$  or  $-\frac{3}{2}\pi$ . However, on combining (2.11.6) with the connection formula (8.19.18), with  $m = 1$ , we derive

$$2.11.7 \quad E_p(z) \sim \frac{2\pi i e^{-p\pi i}}{\Gamma(p)} z^{p-1} + \frac{e^{-z}}{z} \sum_{s=0}^{\infty} (-1)^s \frac{(p)_s}{z^s},$$

valid as  $z \rightarrow \infty$  in any closed sector within  $\frac{1}{2}\pi < \text{ph } z < \frac{3}{2}\pi$ ; compare (8.20.3). Since the ray  $\text{ph } z = \frac{3}{2}\pi$  is well away from the new boundaries, the compound expansion (2.11.7) yields much more accurate results when  $\text{ph } z \rightarrow \frac{3}{2}\pi$ . In effect, (2.11.7) “corrects” (2.11.6) by introducing a term that is relatively exponentially small in the neighborhood of  $\text{ph } z = \pi$ , is increasingly significant as  $\text{ph } z$  passes from  $\pi$  to  $\frac{3}{2}\pi$ , and becomes the dominant contribution after  $\text{ph } z$  passes  $\frac{3}{2}\pi$ . See also §2.11(iv).

### 2.11(iii) Exponentially-Improved Expansions

The procedure followed in §2.11(ii) enabled  $E_p(z)$  to be computed with as much accuracy in the sector  $\pi \leq \text{ph } z \leq 3\pi$  as the original expansion (2.11.6) in  $|\text{ph } z| \leq \pi$ . We now increase substantially the accuracy of (2.11.6) in  $|\text{ph } z| \leq \pi$  by re-expanding the remainder term.

Optimum truncation in (2.11.6) takes place at  $s = n - 1$ , with  $|p + n - 1| = |z|$ , approximately. Thus

$$2.11.8 \quad n = \rho - p + \alpha,$$

where  $z = \rho e^{i\theta}$ , and  $|\alpha|$  is bounded as  $n \rightarrow \infty$ . From (2.11.5) and the identity

$$2.11.9 \quad \frac{1}{1+t} = \sum_{s=0}^{n-1} (-1)^s t^s + (-1)^n \frac{t^n}{1+t}, \quad t \neq -1,$$

we have

2.11.10

$$E_p(z) = \frac{e^{-z}}{z} \sum_{s=0}^{n-1} (-1)^s \frac{(p)_s}{z^s} + (-1)^n \frac{2\pi}{\Gamma(p)} z^{p-1} F_{n+p}(z),$$

where

2.11.11

$$F_{n+p}(z) = \frac{e^{-z}}{2\pi} \int_0^\infty \frac{e^{-zt} t^{n+p-1}}{1+t} dt = \frac{\Gamma(n+p)}{2\pi} \frac{E_{n+p}(z)}{z^{n+p-1}}.$$

With  $n$  given by (2.11.8), we have

2.11.12

$$F_{n+p}(z) = \frac{e^{-z}}{2\pi} \int_0^\infty \exp(-\rho (te^{i\theta} - \ln t)) \frac{t^{\alpha-1}}{1+t} dt.$$

For large  $\rho$  the integrand has a saddle point at  $t = e^{-i\theta}$ . Following §2.4(iv), we rotate the integration path through an angle  $-\theta$ , which is valid by analytic continuation when  $-\pi < \theta < \pi$ . Then by application of Laplace's method (§§2.4(iii) and 2.4(iv)), we have

2.11.13

$$F_{n+p}(z) \sim \frac{e^{-i(\rho+\alpha)\theta}}{1+e^{-i\theta}} \frac{e^{-\rho-z}}{(2\pi\rho)^{1/2}} \sum_{s=0}^\infty \frac{a_{2s}(\theta, \alpha)}{\rho^s}, \quad \rho \rightarrow \infty,$$

uniformly when  $\theta \in [-\pi + \delta, \pi - \delta]$  ( $\delta > 0$ ) and  $|\alpha|$  is bounded. The coefficients are rational functions of  $\alpha$  and  $1 + e^{i\theta}$ , for example,  $a_0(\theta, \alpha) = 1$ , and

2.11.14

$$a_2(\theta, \alpha) = \frac{1}{12}(6\alpha^2 - 6\alpha + 1) - \frac{\alpha}{1+e^{i\theta}} + \frac{1}{(1+e^{i\theta})^2}.$$

Owing to the factor  $e^{-\rho}$ , that is,  $e^{-|z|}$  in (2.11.13),  $F_{n+p}(z)$  is uniformly exponentially small compared with  $E_p(z)$ . For this reason the expansion of  $E_p(z)$  in  $|\text{ph } z| \leq \pi - \delta$  supplied by (2.11.8), (2.11.10), and (2.11.13) is said to be *exponentially improved*.

If we permit the use of nonelementary functions as approximants, then even more powerful re-expansions become available. One is uniformly valid for  $-\pi + \delta \leq$

$\text{ph } z \leq 3\pi - \delta$  with bounded  $|\alpha|$ , and achieves uniform exponential improvement throughout  $0 \leq \text{ph } z \leq \pi$ :

$$F_{n+p}(z) \sim (-1)^n i e^{-p\pi i} \left( \frac{1}{2} \text{erfc} \left( \sqrt{\frac{1}{2}\rho} c(\theta) \right) - i \frac{e^{i\rho(\pi-\theta)} e^{-\rho-z}}{(2\pi\rho)^{1/2}} \sum_{s=0}^\infty \frac{h_{2s}(\theta, \alpha)}{\rho^s} \right).$$

2.11.15

Here  $\text{erfc}$  is the complementary error function (§7.2(i)), and

$$2.11.16 \quad c(\theta) = \sqrt{2(1 + e^{i\theta} + i(\theta - \pi))},$$

the branch being continuous with  $c(\theta) \sim \pi - \theta$  as  $\theta \rightarrow \pi$ . Also,

$$2.11.17 \quad h_{2s}(\theta, \alpha) = \frac{e^{i\alpha(\pi-\theta)}}{1 + e^{-i\theta}} a_{2s}(\theta, \alpha) + (-1)^{s-1} i \frac{1 \cdot 3 \cdot 5 \cdots (2s-1)}{(c(\theta))^{2s+1}},$$

with  $a_{2s}(\theta, \alpha)$  as in (2.11.13), (2.11.14). In particular,

$$2.11.18 \quad h_0(\theta, \alpha) = \frac{e^{i\alpha(\pi-\theta)}}{1 + e^{-i\theta}} - \frac{i}{c(\theta)}.$$

For the sector  $-3\pi + \delta \leq \text{ph } z \leq \pi - \delta$  the conjugate result applies.

Further details for this example are supplied in Olver (1991a, 1994b). See also Paris and Kaminski (2001, Chapter 6), and Dunster (1996b, 1997).

### 2.11(iv) Stokes Phenomenon

Two different asymptotic expansions in terms of elementary functions, (2.11.6) and (2.11.7), are available for the generalized exponential integral in the sector  $\frac{1}{2}\pi < \text{ph } z < \frac{3}{2}\pi$ . That the change in their forms is discontinuous, even though the function being approximated is analytic, is an example of the *Stokes phenomenon*. Where should the change-over take place? Can it be accomplished smoothly?

Satisfactory answers to these questions were found by Berry (1989); see also the survey by Paris and Wood (1995). These answers are linked to the terms involving the complementary error function in the more powerful expansions typified by the combination of (2.11.10) and (2.11.15). Thus if  $0 \leq \theta \leq \pi - \delta$  ( $< \pi$ ), then  $c(\theta)$  lies in the right half-plane. Hence from §7.12(i)  $\text{erfc} \left( \sqrt{\frac{1}{2}\rho} c(\theta) \right)$  is of the same exponentially-small order of magnitude as the contribution from the other terms in (2.11.15) when  $\rho$  is large. On the other hand, when  $\pi + \delta \leq \theta \leq 3\pi - \delta$ ,  $c(\theta)$  is in the left half-plane and  $\text{erfc} \left( \sqrt{\frac{1}{2}\rho} c(\theta) \right)$  differs from 2 by an exponentially-small quantity. In the transition through  $\theta = \pi$ ,  $\text{erfc} \left( \sqrt{\frac{1}{2}\rho} c(\theta) \right)$  changes very rapidly, but smoothly, from one form to the other; compare the graph of its modulus in Figure 2.11.1 in the case  $\rho = 100$ .

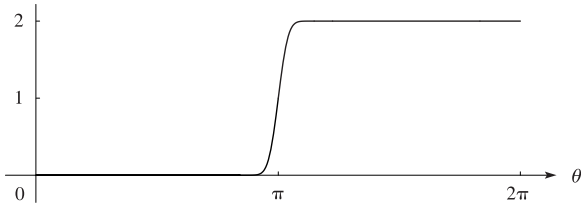


Figure 2.11.1: Graph of  $|\operatorname{erfc}(\sqrt{50}c(\theta))|$ .

In particular, on the ray  $\theta = \pi$  greatest accuracy is achieved by (a) taking the average of the expansions (2.11.6) and (2.11.7), followed by (b) taking account of the exponentially-small contributions arising from the terms involving  $h_{2s}(\theta, \alpha)$  in (2.11.15).

Rays (or curves) on which one contribution in a compound asymptotic expansion achieves maximum dominance over another are called *Stokes lines* ( $\theta = \pi$  in the present example). As these lines are crossed exponentially-small contributions, such as that in (2.11.7), are “switched on” smoothly, in the manner of the graph in Figure 2.11.1.

For higher-order Stokes phenomena see Olde Daalhuis (2004b) and Howls *et al.* (2004).

## 2.11(v) Exponentially-Improved Expansions (continued)

Expansions similar to (2.11.15) can be constructed for many other special functions. However, to enjoy the resurgence property (§2.7(ii)) we often seek instead expansions in terms of the  $F$ -functions introduced in §2.11(iii), leaving the connection of the error-function type behavior as an implicit consequence of this property of the  $F$ -functions. In this context the  $F$ -functions are called *terminants*, a name introduced by Dingle (1973).

For illustration, we give re-expansions of the remainder terms in the expansions (2.7.8) arising in differential-equation theory. For notational convenience assume that the original differential equation (2.7.1) is normalized so that  $\lambda_2 - \lambda_1 = 1$ . (This means that, if necessary,  $z$  is replaced by  $z/(\lambda_2 - \lambda_1)$ .) From (2.7.12), (2.7.13) it is then seen that the optimum number of terms,  $n$ , in (2.7.14) is approximately  $|z|$ . We set

$$2.11.19 \quad w_j(z) = e^{\lambda_j z} z^{\mu_j} \sum_{s=0}^{n-1} \frac{a_{s,j}}{z^s} + R_n^{(j)}(z), \quad j = 1, 2,$$

and expand

$$2.11.20 \quad R_n^{(1)}(z) = (-1)^{n-1} i e^{(\mu_2 - \mu_1)\pi i} e^{\lambda_2 z} z^{\mu_2} \left( C_1 \sum_{s=0}^{m-1} (-1)^s a_{s,2} \frac{F_{n+\mu_2-\mu_1-s}(z)}{z^s} + R_{m,n}^{(1)}(z) \right),$$

$$2.11.21 \quad R_n^{(2)}(z) = (-1)^n i e^{(\mu_2 - \mu_1)\pi i} e^{\lambda_1 z} z^{\mu_1} \left( C_2 \sum_{s=0}^{m-1} (-1)^s a_{s,1} \frac{F_{n+\mu_1-\mu_2-s}(ze^{-\pi i})}{z^s} + R_{m,n}^{(2)}(z) \right),$$

with  $m = 0, 1, 2, \dots$ , and  $C_1, C_2$  as in (2.7.17). Then as  $z \rightarrow \infty$ , with  $|n - |z||$  bounded and  $m$  fixed,

$$2.11.22 \quad R_{m,n}^{(1)}(z) = \begin{cases} O(e^{-|z|-z} z^{-m}), & |\operatorname{ph} z| \leq \pi, \\ O(z^{-m}), & \pi \leq |\operatorname{ph} z| \leq \frac{5}{2}\pi - \delta, \end{cases}$$

$$2.11.23 \quad R_{m,n}^{(2)}(z) = \begin{cases} O(e^{-|z|+z} z^{-m}), & 0 \leq \operatorname{ph} z \leq 2\pi, \\ O(z^{-m}), & -\frac{3}{2}\pi + \delta \leq \operatorname{ph} z \leq 0 \text{ and } 2\pi \leq \operatorname{ph} z \leq \frac{7}{2}\pi - \delta, \end{cases}$$

uniformly with respect to  $\operatorname{ph} z$  in each case.

The relevant Stokes lines are  $\operatorname{ph} z = \pm\pi$  for  $w_1(z)$ , and  $\operatorname{ph} z = 0, 2\pi$  for  $w_2(z)$ . In addition to achieving uniform exponential improvement, particularly in  $|\operatorname{ph} z| \leq \pi$  for  $w_1(z)$ , and  $0 \leq \operatorname{ph} z \leq 2\pi$  for  $w_2(z)$ , the re-expansions (2.11.20), (2.11.21) are resurgent.

For further details see Olde Daalhuis and Olver (1994). For error bounds see Dunster (1996c). For other examples see Boyd (1990b), Paris (1992a,b), and Wong and Zhao (2002b).

Often the process of re-expansion can be repeated any number of times. In this way we arrive at *hy-*

*perasymptotic expansions*. For integrals, see Berry and Howls (1991), Howls (1992), and Paris and Kaminski (2001, Chapter 6). For second-order differential equations, see Olde Daalhuis and Olver (1995a), Olde Daalhuis (1995, 1996), and Murphy and Wood (1997).

For higher-order differential equations, see Olde Daalhuis (1998a,b). The first of these two references also provides an introduction to the powerful Borel transform theory. In this connection see also Byatt-Smith (2000).

For nonlinear differential equations see Olde Daalhuis (2005a,b).

For another approach see Paris (2001a,b).

**2.11(vi) Direct Numerical Transformations**

The transformations in §3.9 for summing slowly convergent series can also be very effective when applied to divergent asymptotic series.

A simple example is provided by Euler’s transformation (§3.9(ii)) applied to the asymptotic expansion for the exponential integral (§6.12(i)):

$$2.11.24 \quad e^x E_1(x) \sim \sum_{s=0}^{\infty} (-1)^s \frac{s!}{x^{s+1}}, \quad x \rightarrow +\infty.$$

Taking  $x = 5$  and rounding to 5D, we obtain

$$2.11.25 \quad e^5 E_1(5) = 0.20000 - 0.04000 + 0.01600 - 0.00960 \\ + 0.00768 - 0.00768 + 0.00922 - 0.01290 \\ + 0.02064 - 0.03716 + 0.07432 - \dots$$

The numerically smallest terms are the 5th and 6th. Truncation after 5 terms yields 0.17408, compared with the correct value

$$2.11.26 \quad e^5 E_1(5) = 0.17042 \dots$$

We now compute the forward differences  $\Delta^j$ ,  $j = 0, 1, 2, \dots$ , of the moduli of the rounded values of the first 6 neglected terms:

$$2.11.27 \quad \Delta^0 = 0.00768, \quad \Delta^1 = 0.00154, \\ \Delta^2 = 0.00214, \quad \Delta^3 = 0.00192, \\ \Delta^4 = 0.00280, \quad \Delta^5 = 0.00434.$$

Multiplying these differences by  $(-1)^j 2^{-j-1}$  and summing, we obtain

$$2.11.28 \quad 0.00384 - 0.00038 + 0.00027 - 0.00012 \\ + 0.00009 - 0.00007 = 0.00363.$$

Subtraction of this result from the sum of the first 5 terms in (2.11.25) yields 0.17045, which is much closer to the true value.

The process just used is equivalent to re-expanding the remainder term of the original asymptotic series (2.11.24) in powers of  $1/(x+5)$  and truncating the new series optimally. Further improvements in accuracy can be realized by making a second application of the Euler transformation; see Olver (1997b, pp. 540–543).

Similar improvements are achievable by Aitken’s  $\Delta^2$ -process, Wynn’s  $\epsilon$ -algorithm, and other acceleration transformations. For a comprehensive survey see Weniger (1989).

The following example, based on Weniger (1996), illustrates their power.

For large  $|z|$ , with  $|\operatorname{ph} z| \leq \frac{3}{2}\pi - \delta (< \frac{3}{2}\pi)$ , the Whittaker function of the second kind has the asymptotic expansion (§13.19)

$$2.11.29 \quad W_{\kappa, \mu}(z) \sim \sum_{n=0}^{\infty} a_n,$$

in which

$$2.11.30 \quad a_n = \frac{e^{-z/2}}{z^{n-\kappa} n!} (\mu^2 - (\kappa - \frac{1}{2})^2) (\mu^2 - (\kappa - \frac{3}{2})^2) \\ \dots (\mu^2 - (\kappa - n + \frac{1}{2})^2).$$

With  $z = 1.0$ ,  $\kappa = 2.3$ ,  $\mu = 0.5$ , the values of  $a_n$  to 8D are supplied in the second column of Table 2.11.1.

Table 2.11.1: Whittaker functions with Levin’s transformation.

$n$	$a_n$	$s_n$	$d_n$
0	0.60653 066	0.60653 066	0.60653 066
1	-1.81352 667	-1.20699 601	-0.91106 488
2	0.35363 770	-0.85335 831	-0.82413 405
3	0.02475 464	-0.82860 367	-0.83323 429
4	-0.00736 451	-0.83596 818	-0.83303 750
5	0.00676 062	-0.82920 756	-0.83298 901
6	-0.01125 643	-0.84046 399	-0.83299 429
7	0.02796 418	-0.81249 981	-0.83299 530
8	-0.09364 504	-0.90614 485	-0.83299 504
9	0.39736 710	-0.50877 775	-0.83299 501
10	-2.05001 686	-2.55879 461	-0.83299 503

The next column lists the partial sums  $s_n = a_0 + a_1 + \dots + a_n$ . Optimum truncation occurs just prior to the numerically smallest term, that is, at  $s_4$ . Comparison with the true value

$$2.11.31 \quad W_{2.3, 0.5}(1.0) = -0.83299 50268 27526 \dots$$

shows that this direct estimate is correct to almost 3D.

The fourth column of Table 2.11.1 gives the results of applying the following variant of Levin’s transformation:

$$2.11.32 \quad d_n = \frac{\sum_{j=0}^n (-1)^j \binom{n}{j} (j+1)^{n-1} \frac{s_j}{a_{j+1}}}{\sum_{j=0}^n (-1)^j \binom{n}{j} (j+1)^{n-1} \frac{1}{a_{j+1}}}.$$

By  $n = 10$  we already have 8 correct decimals. Furthermore, on proceeding to higher values of  $n$  with higher precision, much more accuracy is achievable. For example, using double precision  $d_{20}$  is found to agree with (2.11.31) to 13D.

However, direct numerical transformations need to be used with care. Their extrapolation is based on assumed forms of remainder terms that may not always be appropriate for asymptotic expansions. For example, extrapolated values may converge to an accurate value on one side of a Stokes line (§2.11(iv)), and converge to a quite inaccurate value on the other.

## References

### General References

The main references used in writing this chapter are Olver (1997b) and Wong (1989).

For additional bibliographic reading see Bender (1974), Bleistein and Handelsman (1975), Copson (1965), de Bruijn (1961), Dingle (1973), Erdélyi (1956), Jones (1972, 1997), Lauwerier (1974), Odlyzko (1995), Paris and Kaminski (2001), Slavyanov and Lay (2000), Temme (1995c), and Wasow (1965).

### Sources

The following list gives the references or other indications of proofs that were used in constructing the various sections of this chapter. These sources supplement the references that are quoted in the text.

- §2.1** Olver (1997b, Chapter 1).
- §2.2** Olver (1997b, pp. 11–16), Fabijonas and Olver (1999).
- §2.3** Olver (1997b, Chapter 3). For (2.3.9) see Wong (1989, §2.2). For (2.3.12) use termwise integration in an analogous manner to that used to prove Watson’s lemma (Olver (1997b, pp. 71–72)). (2.3.18) follows from (1.10.15) and (1.10.17) with  $f(t) = p(t)$ ,  $g(t) = q(t)/(p'(t)(p(t) - p(a))^{(\lambda/\mu)-1})$ , using Cauchy’s integral formula for the residue, and integrating by parts. See also Cicuta and Montaldi (1975).
- §2.4** Olver (1997b, Chapter 4 and pp. 315–320), Wong (1989, p. 31).
- §2.5** Wong (1989, Chapter 3), Doetsch (1955, §6.5).
- §2.6** Wong (1989, Chapter 6).
- §2.7** Olver (1997b, Chapters 5–7), Olver (1994a), Olde Daalhuis and Olver (1994), Olde Daalhuis (1998a).
- §2.8** Olver (1997b, Chapters 10–12).
- §2.10** Olver (1997b, Chapter 8).
- §2.11** Olver (1997b, pp. 76–78 and 540–543), Olver (1991a), Weniger (1996). The computations in the example in §2.11(vi) were carried out at NIST.

## Chapter 3

# Numerical Methods

N. M. Temme<sup>1</sup>

<b>Areas</b>	<b>72</b>	3.7 Ordinary Differential Equations . . . . .	88
3.1 Arithmetics and Error Measures . . . . .	72	3.8 Nonlinear Equations . . . . .	90
3.2 Linear Algebra . . . . .	73	3.9 Acceleration of Convergence . . . . .	93
3.3 Interpolation . . . . .	75	3.10 Continued Fractions . . . . .	94
3.4 Differentiation . . . . .	77	3.11 Approximation Techniques . . . . .	96
3.5 Quadrature . . . . .	78	3.12 Mathematical Constants . . . . .	100
3.6 Linear Difference Equations . . . . .	85	<b>References</b>	<b>100</b>

<sup>1</sup>Centrum voor Wiskunde en Informatica, Department MAS, Amsterdam, The Netherlands.

**Acknowledgments:** The author thanks W. Gautschi and C. Brezinski for their valuable contributions, and F. W. J. Olver for assisting with the writing of §§3.6, 3.7, 3.8, and 3.11.

**Copyright** © 2009 National Institute of Standards and Technology. All rights reserved.



## Areas

### 3.1 Arithmetics and Error Measures

#### 3.1(i) Floating-Point Arithmetic

Computer arithmetic is described for the *binary* based system with base 2; another frequently used system is the *hexadecimal* system with base 16.

A nonzero *normalized binary floating-point machine number*  $x$  is represented as

$$3.1.1 \quad x = (-1)^s \cdot (b_0.b_1b_2 \dots b_{p-1}) \cdot 2^E, \quad b_0 = 1,$$

where  $s$  is equal to 1 or 0, each  $b_j$ ,  $j \geq 1$ , is either 0 or 1,  $b_1$  is the *most significant bit*,  $p$  ( $\in \mathbb{N}$ ) is the number of significant bits  $b_j$ ,  $b_{p-1}$  is the *least significant bit*,  $E$  is an integer called the *exponent*,  $b_0.b_1b_2 \dots b_{p-1}$  is the *significand*, and  $f = .b_1b_2 \dots b_{p-1}$  is the *fractional part*.

The set of *machine numbers*  $\mathbb{R}_H$  is the union of 0 and the set

$$3.1.2 \quad (-1)^s 2^E \sum_{j=0}^{p-1} b_j 2^{-j},$$

with  $b_0 = 1$  and all allowable choices of  $E$ ,  $p$ ,  $s$ , and  $b_j$ .

Let  $E_{\min} \leq E \leq E_{\max}$  with  $E_{\min} < 0$  and  $E_{\max} > 0$ . For given values of  $E_{\min}$ ,  $E_{\max}$ , and  $p$ , the *format width in bits*  $N$  of a computer word is the total number of bits: the sign (one bit), the significant bits  $b_1, b_2, \dots, b_{p-1}$  ( $p-1$  bits), and the bits allocated to the exponent (the remaining  $N-p$  bits). The integers  $p$ ,  $E_{\min}$ , and  $E_{\max}$  are characteristics of the machine. The *machine epsilon*  $\epsilon_M$ , that is, the distance between 1 and the next larger machine number with  $E = 0$  is given by  $\epsilon_M = 2^{-p+1}$ . The *machine precision* is  $\frac{1}{2}\epsilon_M = 2^{-p}$ . The lower and upper bounds for the absolute values of the nonzero machine numbers are given by

$$3.1.3 \quad N_{\min} \equiv 2^{E_{\min}} \leq |x| \leq 2^{E_{\max}+1} (1 - 2^{-p}) \equiv N_{\max}.$$

*Underflow (overflow)* after computing  $x \neq 0$  occurs when  $|x|$  is smaller (larger) than  $N_{\min}$  ( $N_{\max}$ ).

#### IEEE Standard

The current standard is the ANSI/IEEE Standard 754; see IEEE (1985, §§1–4). In the case of normalized binary representation the memory positions for *single precision* ( $N = 32$ ,  $p = 24$ ,  $E_{\min} = -126$ ,  $E_{\max} = 127$ ) and *double precision* ( $N = 64$ ,  $p = 53$ ,  $E_{\min} = -1022$ ,  $E_{\max} = 1023$ ) are as in Figure 3.1.1. The respective machine precisions are  $\frac{1}{2}\epsilon_M = 0.596 \times 10^{-7}$  and  $\frac{1}{2}\epsilon_M = 0.111 \times 10^{-15}$ .

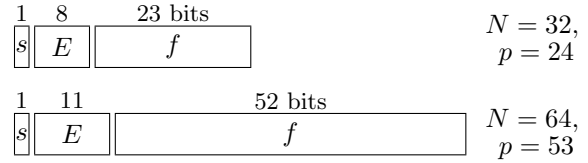


Figure 3.1.1: Floating-point arithmetic. Memory positions in single and double precision, in the case of binary representation.

#### Rounding

Let  $x$  be any positive number with

$$3.1.4 \quad x = (1.b_1b_2 \dots b_{p-1}b_p b_{p+1} \dots) \cdot 2^E, \\ N_{\min} \leq x \leq N_{\max}, \text{ and}$$

$$3.1.5 \quad x_- = (1.b_1b_2 \dots b_{p-1}) \cdot 2^E, \\ x_+ = ((1.b_1b_2 \dots b_{p-1}) + \epsilon_M) \cdot 2^E.$$

Then *rounding by chopping* or *rounding down* of  $x$  gives  $x_-$ , with maximum relative error  $\epsilon_M$ . *Symmetric rounding* or *rounding to nearest* of  $x$  gives  $x_-$  or  $x_+$ , whichever is nearer to  $x$ , with maximum relative error equal to the machine precision  $\frac{1}{2}\epsilon_M = 2^{-p}$ .

Negative numbers  $x$  are rounded in the same way as  $-x$ .

For further information see Goldberg (1991) and Overton (2001).

#### 3.1(ii) Interval Arithmetic

*Interval arithmetic* is intended for bounding the total effect of rounding errors of calculations with machine numbers. With this arithmetic the computed result can be proved to lie in a certain interval, which leads to *validated computing* with guaranteed and rigorous inclusion regions for the results.

Let  $G$  be the set of closed intervals  $\{[a, b]\}$ . The elementary arithmetical operations on intervals are defined as follows:

$$3.1.6 \quad I * J = \{x * y \mid x \in I, y \in J\}, \quad I, J \in G,$$

where  $*$   $\in$   $\{+, -, \cdot, /\}$ , with appropriate roundings of the end points of  $I * J$  when machine numbers are being used. Division is possible only if the divisor interval does not contain zero.

A basic text on interval arithmetic and analysis is Alefeld and Herzberger (1983), and for applications and further information see Moore (1979) and Petković and Petković (1998). The last reference includes analogs for arithmetic in the complex plane  $\mathbb{C}$ .

#### 3.1(iii) Rational Arithmetics

Computer algebra systems use *exact rational arithmetic* with rational numbers  $p/q$ , where  $p$  and  $q$  are multi-length integers. During the calculations common divisors are removed from the rational numbers, and the

final results can be converted to decimal representations of arbitrary length. For further information see Matula and Kornerup (1980).

### 3.1(iv) Level-Index Arithmetic

To eliminate overflow or underflow in finite-precision arithmetic numbers are represented by using *generalized logarithms*  $\ln_\ell(x)$  given by

$$3.1.7 \quad \ln_0(x) = x, \quad \ln_\ell(x) = \ln(\ln_{\ell-1}(x)), \quad \ell = 1, 2, \dots,$$

with  $x \geq 0$  and  $\ell$  the unique nonnegative integer such that  $a \equiv \ln_\ell(x) \in [0, 1)$ . In *level-index arithmetic*  $x$  is represented by  $\ell + a$  (or  $-(\ell + a)$  for negative numbers). Also in this arithmetic *generalized precision* can be defined, which includes absolute error and relative precision (§3.1(v)) as special cases.

For further information see Clenshaw and Olver (1984) and Clenshaw *et al.* (1989). For applications see Lozier (1993).

For further references on level-index arithmetic (and also other arithmetics) see Anuta *et al.* (1996). See also Hayes (2009).

### 3.1(v) Error Measures

If  $x^*$  is an approximation to a real or complex number  $x$ , then the *absolute error* is

$$3.1.8 \quad \epsilon_a = |x^* - x|.$$

If  $x \neq 0$ , the *relative error* is

$$3.1.9 \quad \epsilon_r = \left| \frac{x^* - x}{x} \right| = \frac{\epsilon_a}{|x|}.$$

The *relative precision* is

$$3.1.10 \quad \epsilon_{rp} = |\ln(x^*/x)|,$$

where  $xx^* > 0$  for real variables, and  $xx^* \neq 0$  for complex variables (with the principal value of the logarithm).

The *mollified error* is

$$3.1.11 \quad \epsilon_m = \frac{|x^* - x|}{\max(|x|, 1)}.$$

For error measures for complex arithmetic see Olver (1983).

## 3.2 Linear Algebra

### 3.2(i) Gaussian Elimination

To solve the system

$$3.2.1 \quad \mathbf{Ax} = \mathbf{b},$$

with Gaussian elimination, where  $\mathbf{A}$  is a nonsingular  $n \times n$  matrix and  $\mathbf{b}$  is an  $n \times 1$  vector, we start with the *augmented matrix*

$$3.2.2 \quad \begin{bmatrix} a_{11} & \cdots & a_{1n} & b_1 \\ \vdots & \ddots & \vdots & \vdots \\ a_{n1} & \cdots & a_{nn} & b_n \end{bmatrix}.$$

By repeatedly subtracting multiples of each row from the subsequent rows we obtain a matrix of the form

$$3.2.3 \quad \begin{bmatrix} u_{11} & u_{12} & \cdots & u_{1n} & y_1 \\ 0 & u_{22} & \cdots & u_{2n} & y_2 \\ \vdots & \ddots & \ddots & \vdots & \vdots \\ 0 & \cdots & 0 & u_{nn} & y_n \end{bmatrix}.$$

During this reduction process we store the *multipliers*  $\ell_{jk}$  that are used in each column to eliminate other elements in that column. This yields a *lower triangular matrix* of the form

$$3.2.4 \quad \mathbf{L} = \begin{bmatrix} 1 & 0 & \cdots & 0 \\ \ell_{21} & 1 & \cdots & 0 \\ \vdots & \ddots & \ddots & \vdots \\ \ell_{n1} & \cdots & \ell_{n,n-1} & 1 \end{bmatrix}.$$

If we denote by  $\mathbf{U}$  the upper triangular matrix comprising the elements  $u_{jk}$  in (3.2.3), then we have the factorization, or *triangular decomposition*,

$$3.2.5 \quad \mathbf{A} = \mathbf{LU}.$$

With  $\mathbf{y} = [y_1, y_2, \dots, y_n]^T$  the process of solution can then be regarded as first solving the equation  $\mathbf{Ly} = \mathbf{b}$  for  $\mathbf{y}$  (*forward elimination*), followed by the solution of  $\mathbf{Ux} = \mathbf{y}$  for  $\mathbf{x}$  (*back substitution*).

For more details see Golub and Van Loan (1996, pp. 87–100).

#### Example

$$3.2.6 \quad \begin{bmatrix} 1 & 2 & 3 \\ 2 & 3 & 1 \\ 3 & 1 & 2 \end{bmatrix} = \begin{bmatrix} 1 & 0 & 0 \\ 2 & 1 & 0 \\ 3 & 5 & 1 \end{bmatrix} \begin{bmatrix} 1 & 2 & 3 \\ 0 & -1 & -5 \\ 0 & 0 & 18 \end{bmatrix}.$$

In solving  $\mathbf{Ax} = [1, 1, 1]^T$ , we obtain by forward elimination  $\mathbf{y} = [1, -1, 3]^T$ , and by back substitution  $\mathbf{x} = [\frac{1}{6}, \frac{1}{6}, \frac{1}{6}]^T$ .

In practice, if any of the multipliers  $\ell_{jk}$  are unduly large in magnitude compared with unity, then Gaussian elimination is unstable. To avoid instability the rows are interchanged at each elimination step in such a way that the absolute value of the element that is used as a divisor, the *pivot element*, is not less than that of the other available elements in its column. Then  $|\ell_{jk}| \leq 1$  in all cases. This modification is called *Gaussian elimination with partial pivoting*.

For more information on pivoting see Golub and Van Loan (1996, pp. 109–123).

### Iterative Refinement

When the factorization (3.2.5) is available, the accuracy of the computed solution  $\mathbf{x}$  can be improved with little extra computation. Because of rounding errors, the *residual vector*  $\mathbf{r} = \mathbf{b} - \mathbf{A}\mathbf{x}$  is nonzero as a rule. We solve the system  $\mathbf{A}\delta\mathbf{x} = \mathbf{r}$  for  $\delta\mathbf{x}$ , taking advantage of the existing triangular decomposition of  $\mathbf{A}$  to obtain an improved solution  $\mathbf{x} + \delta\mathbf{x}$ .

### 3.2(ii) Gaussian Elimination for a Tridiagonal Matrix

*Tridiagonal matrices* are ones in which the only nonzero elements occur on the main diagonal and two adjacent diagonals. Thus

$$3.2.7 \quad \mathbf{A} = \begin{bmatrix} b_1 & c_1 & & & 0 \\ a_2 & b_2 & c_2 & & \\ & \ddots & \ddots & \ddots & \\ & & a_{n-1} & b_{n-1} & c_{n-1} \\ 0 & & & a_n & b_n \end{bmatrix}.$$

Assume that  $\mathbf{A}$  can be factored as in (3.2.5), but without partial pivoting. Then

$$3.2.8 \quad \mathbf{L} = \begin{bmatrix} 1 & 0 & & & 0 \\ \ell_2 & 1 & & & \\ & \ddots & \ddots & \ddots & \\ & & \ell_{n-1} & 1 & 0 \\ 0 & & & \ell_n & 1 \end{bmatrix},$$

$$3.2.9 \quad \mathbf{U} = \begin{bmatrix} d_1 & u_1 & & & 0 \\ 0 & d_2 & u_2 & & \\ & \ddots & \ddots & \ddots & \\ & & 0 & d_{n-1} & u_{n-1} \\ 0 & & & 0 & d_n \end{bmatrix},$$

where  $u_j = c_j$ ,  $j = 1, 2, \dots, n-1$ ,  $d_1 = b_1$ , and

$$3.2.10 \quad \ell_j = a_j/d_{j-1}, \quad d_j = b_j - \ell_j c_{j-1}, \quad j = 2, \dots, n.$$

Forward elimination for solving  $\mathbf{A}\mathbf{x} = \mathbf{f}$  then becomes  $y_1 = f_1$ ,

$$3.2.11 \quad y_j = f_j - \ell_j y_{j-1}, \quad j = 2, \dots, n,$$

and back substitution is  $x_n = y_n/d_n$ , followed by

$$3.2.12 \quad x_j = (y_j - u_j x_{j+1})/d_j, \quad j = n-1, \dots, 1.$$

For more information on solving tridiagonal systems see Golub and Van Loan (1996, pp. 152–160).

### 3.2(iii) Condition of Linear Systems

The  $p$ -norm of a vector  $\mathbf{x} = [x_1, \dots, x_n]^T$  is given by

$$3.2.13 \quad \|\mathbf{x}\|_p = \left( \sum_{j=1}^n |x_j|^p \right)^{1/p}, \quad p = 1, 2, \dots, \\ \|\mathbf{x}\|_\infty = \max_{1 \leq j \leq n} |x_j|.$$

The *Euclidean norm* is the case  $p = 2$ .

The  $p$ -norm of a matrix  $\mathbf{A} = [a_{jk}]$  is

$$3.2.14 \quad \|\mathbf{A}\|_p = \max_{\mathbf{x} \neq \mathbf{0}} \frac{\|\mathbf{A}\mathbf{x}\|_p}{\|\mathbf{x}\|_p}.$$

The cases  $p = 1, 2$ , and  $\infty$  are the most important:

$$\|\mathbf{A}\|_1 = \max_{1 \leq k \leq n} \sum_{j=1}^n |a_{jk}|,$$

$$3.2.15 \quad \|\mathbf{A}\|_\infty = \max_{1 \leq j \leq n} \sum_{k=1}^n |a_{jk}|,$$

$$\|\mathbf{A}\|_2 = \sqrt{\rho(\mathbf{A}\mathbf{A}^T)},$$

where  $\rho(\mathbf{A}\mathbf{A}^T)$  is the largest of the absolute values of the eigenvalues of the matrix  $\mathbf{A}\mathbf{A}^T$ ; see §3.2(iv). (We are assuming that the matrix  $\mathbf{A}$  is real; if not  $\mathbf{A}^T$  is replaced by  $\mathbf{A}^H$ , the transpose of the complex conjugate of  $\mathbf{A}$ .)

The sensitivity of the solution vector  $\mathbf{x}$  in (3.2.1) to small perturbations in the matrix  $\mathbf{A}$  and the vector  $\mathbf{b}$  is measured by the *condition number*

$$3.2.16 \quad \kappa(\mathbf{A}) = \|\mathbf{A}\|_p \|\mathbf{A}^{-1}\|_p,$$

where  $\|\cdot\|_p$  is one of the matrix norms. For any norm (3.2.14) we have  $\kappa(\mathbf{A}) \geq 1$ . The larger the value  $\kappa(\mathbf{A})$ , the more ill-conditioned the system.

Let  $\mathbf{x}^*$  denote a computed solution of the system (3.2.1), with  $\mathbf{r} = \mathbf{b} - \mathbf{A}\mathbf{x}^*$  again denoting the residual. Then we have the *a posteriori* error bound

$$3.2.17 \quad \frac{\|\mathbf{x}^* - \mathbf{x}\|_p}{\|\mathbf{x}\|_p} \leq \kappa(\mathbf{A}) \frac{\|\mathbf{r}\|_p}{\|\mathbf{b}\|_p}.$$

For further information see Brezinski (1999) and Trefethen and Bau (1997, Chapter 3).

### 3.2(iv) Eigenvalues and Eigenvectors

If  $\mathbf{A}$  is an  $n \times n$  matrix, then a real or complex number  $\lambda$  is called an *eigenvalue* of  $\mathbf{A}$ , and a nonzero vector  $\mathbf{x}$  a corresponding (*right*) *eigenvector*, if

$$3.2.18 \quad \mathbf{A}\mathbf{x} = \lambda\mathbf{x}.$$

A nonzero vector  $\mathbf{y}$  is called a *left eigenvector* of  $\mathbf{A}$  corresponding to the eigenvalue  $\lambda$  if  $\mathbf{y}^T \mathbf{A} = \lambda \mathbf{y}^T$  or, equivalently,  $\mathbf{A}^T \mathbf{y} = \lambda \mathbf{y}$ . A *normalized* eigenvector has Euclidean norm 1; compare (3.2.13) with  $p = 2$ .

The polynomial

$$3.2.19 \quad p_n(\lambda) = \det[\lambda \mathbf{I} - \mathbf{A}]$$

is called the *characteristic polynomial* of  $\mathbf{A}$  and its zeros are the eigenvalues of  $\mathbf{A}$ . The *multiplicity* of an eigenvalue is its multiplicity as a zero of the characteristic polynomial (§3.8(i)). To an eigenvalue of multiplicity  $m$ , there correspond  $m$  linearly independent eigenvectors provided that  $\mathbf{A}$  is *nondefective*, that is,  $\mathbf{A}$  has a complete set of  $n$  linearly independent eigenvectors.

### 3.2(v) Condition of Eigenvalues

If  $\mathbf{A}$  is nondefective and  $\lambda$  is a simple zero of  $p_n(\lambda)$ , then the sensitivity of  $\lambda$  to small perturbations in the matrix  $\mathbf{A}$  is measured by the *condition number*

$$3.2.20 \quad \kappa(\lambda) = \frac{1}{|\mathbf{y}^T \mathbf{x}|},$$

where  $\mathbf{x}$  and  $\mathbf{y}$  are the normalized right and left eigenvectors of  $\mathbf{A}$  corresponding to the eigenvalue  $\lambda$ . Because  $|\mathbf{y}^T \mathbf{x}| = |\cos \theta|$ , where  $\theta$  is the angle between  $\mathbf{y}^T$  and  $\mathbf{x}$  we always have  $\kappa(\lambda) \geq 1$ . When  $\mathbf{A}$  is a symmetric matrix, the left and right eigenvectors coincide, yielding  $\kappa(\lambda) = 1$ , and the calculation of its eigenvalues is a well-conditioned problem.

### 3.2(vi) Lanczos Tridiagonalization of a Symmetric Matrix

Define the *Lanczos vectors*  $\mathbf{v}_j$  by  $\mathbf{v}_0 = \mathbf{0}$ , a normalized vector  $\mathbf{v}_1$  (perhaps chosen randomly), and for  $j = 1, 2, \dots, n-1$ ,

$$3.2.21 \quad \begin{aligned} \beta_{j+1} \mathbf{v}_{j+1} &= \mathbf{A} \mathbf{v}_j - \alpha_j \mathbf{v}_j - \beta_j \mathbf{v}_{j-1}, \\ \alpha_j &= \mathbf{v}_j^T \mathbf{A} \mathbf{v}_j, \quad \beta_{j+1} = \mathbf{v}_{j+1}^T \mathbf{A} \mathbf{v}_j. \end{aligned}$$

Then all  $\mathbf{v}_j$ ,  $1 \leq j \leq n$ , are normalized and  $\mathbf{v}_j^T \mathbf{v}_k = 0$  for  $j, k = 1, 2, \dots, n$ ,  $j \neq k$ . The tridiagonal matrix

$$3.2.22 \quad \mathbf{B} = \begin{bmatrix} \alpha_1 & \beta_2 & & & 0 \\ \beta_2 & \alpha_2 & \beta_3 & & \\ & \ddots & \ddots & \ddots & \\ & & \beta_{n-1} & \alpha_{n-1} & \beta_n \\ 0 & & & \beta_n & \alpha_n \end{bmatrix}$$

has the same eigenvalues as  $\mathbf{A}$ . Its characteristic polynomial can be obtained from the recursion

$$3.2.23 \quad p_{k+1}(\lambda) = (\lambda - \alpha_{k+1})p_k(\lambda) - \beta_{k+1}^2 p_{k-1}(\lambda), \quad k = 0, 1, \dots, n-1,$$

with  $p_{-1}(\lambda) = 0$ ,  $p_0(\lambda) = 1$ .

For numerical information see Stewart (2001, pp. 347–368).

### 3.2(vii) Computation of Eigenvalues

Many methods are available for computing eigenvalues; see Golub and Van Loan (1996, Chapters 7, 8), Trefethen and Bau (1997, Chapter 5), and Wilkinson (1988, Chapters 8, 9).

## 3.3 Interpolation

### 3.3(i) Lagrange Interpolation

The *nodes* or *abscissas*  $z_k$  are real or complex; function values are  $f_k = f(z_k)$ . Given  $n+1$  distinct points  $z_k$  and

$n+1$  corresponding function values  $f_k$ , the *Lagrange interpolation polynomial* is the unique polynomial  $P_n(z)$  of degree not exceeding  $n$  such that  $P_n(z_k) = f_k$ ,  $k = 0, 1, \dots, n$ . It is given by

$$3.3.1 \quad P_n(z) = \sum_{k=0}^n \ell_k(z) f_k = \sum_{k=0}^n \frac{\omega_{n+1}(z)}{(z - z_k) \omega'_{n+1}(z_k)} f_k,$$

where

$$3.3.2 \quad \ell_k(z) = \prod_{j=0, j \neq k}^n \frac{z - z_j}{z_k - z_j}, \quad \ell_k(z_k) = \delta_{k,j}.$$

Here the prime signifies that the factor for  $j = k$  is to be omitted,  $\delta_{k,j}$  is the Kronecker symbol, and  $\omega_{n+1}$  is the *nodal polynomial*

$$3.3.3 \quad \omega_{n+1}(z) = \prod_{k=0}^n (z - z_k).$$

With an error term the *Lagrange interpolation formula* for  $f$  is given by

$$3.3.4 \quad f(z) = \sum_{k=0}^n \ell_k(z) f_k + R_n(z).$$

If  $f$ ,  $x (= z)$ , and the nodes  $x_k$  are real, and  $f^{(n+1)}$  is continuous on the smallest closed interval  $I$  containing  $x, x_0, x_1, \dots, x_n$ , then the error can be expressed

$$3.3.5 \quad R_n(x) = \frac{f^{(n+1)}(\xi)}{(n+1)!} \omega_{n+1}(x),$$

for some  $\xi \in I$ . If  $f$  is analytic in a simply-connected domain  $D$  (§1.13(i)), then for  $z \in D$ ,

$$3.3.6 \quad R_n(z) = \frac{\omega_{n+1}(z)}{2\pi i} \int_C \frac{f(\zeta)}{(\zeta - z) \omega_{n+1}(\zeta)} d\zeta,$$

where  $C$  is a simple closed contour in  $D$  described in the positive rotational sense and enclosing the points  $z, z_1, z_2, \dots, z_n$ .

### 3.3(ii) Lagrange Interpolation with Equally-Spaced Nodes

The  $(n+1)$ -point formula (3.3.4) can be written in the form

$$3.3.7 \quad f_t = f(x_0 + th) = \sum_{k=n_0}^{n_1} A_k^n f_k + R_{n,t}, \quad n_0 < t < n_1,$$

where the nodes  $x_k = x_0 + kh$  ( $h > 0$ ) and function  $f$  are real,

$$3.3.8 \quad n_0 = -\frac{1}{2}(n - \sigma), \quad n_1 = \frac{1}{2}(n + \sigma),$$

$$3.3.9 \quad \sigma = \frac{1}{2}(1 - (-1)^n),$$

and  $A_k^n$  are the *Lagrangian interpolation coefficients* defined by

$$3.3.10 \quad A_k^n = \frac{(-1)^{n_1+k}}{(k - n_0)! (n_1 - k)! (t - k)} \prod_{m=n_0}^{n_1} (t - m).$$

The remainder is given by

**3.3.11**

$$R_{n,t} = R_n(x_0 + th) = \frac{h^{n+1}}{(n+1)!} f^{(n+1)}(\xi) \prod_{k=n_0}^{n_1} (t-k),$$

where  $\xi$  is as in §3.3(i).

Let  $c_n$  be defined by

$$\mathbf{3.3.12} \quad c_n = \frac{1}{(n+1)!} \max \prod_{k=n_0}^{n_1} |t-k|,$$

where the maximum is taken over  $t$ -intervals given in the formulas below. Then for these  $t$ -intervals,

$$\mathbf{3.3.13} \quad |R_{n,t}| \leq c_n h^{n+1} \left| f^{(n+1)}(\xi) \right|.$$

### Linear Interpolation

$$\mathbf{3.3.14} \quad f_t = (1-t)f_0 + tf_1 + R_{1,t}, \quad 0 < t < 1,$$

$$\mathbf{3.3.15} \quad c_1 = \frac{1}{8}, \quad 0 < t < 1.$$

### Three-Point Formula

$$\mathbf{3.3.16} \quad f_t = \sum_{k=-1}^1 A_k^2 f_k + R_{2,t}, \quad |t| < 1,$$

$$\mathbf{3.3.17} \quad A_{-1}^2 = \frac{1}{2}t(t-1), \quad A_0^2 = 1-t^2, \quad A_1^2 = \frac{1}{2}t(t+1),$$

$$\mathbf{3.3.18} \quad c_2 = 1/(9\sqrt{3}) = 0.0641\dots, \quad |t| < 1.$$

For four-point to eight-point formulas see <http://dlmf.nist.gov/3.3.ii>.

### 3.3(iii) Divided Differences

The *divided differences* of  $f$  relative to a sequence of distinct points  $z_0, z_1, z_2, \dots$  are defined by

$$[z_0]f = f_0,$$

$$\mathbf{3.3.34} \quad [z_0, z_1]f = ([z_1]f - [z_0]f)/(z_1 - z_0),$$

$$[z_0, z_1, z_2]f = ([z_1, z_2]f - [z_0, z_1]f)/(z_2 - z_0),$$

and so on. Explicitly, the *divided difference of order  $n$*  is given by

**3.3.35**

$$[z_0, z_1, \dots, z_n]f = \sum_{k=0}^n \left( f(z_k) / \prod_{\substack{0 \leq j \leq n \\ j \neq k}} (z_k - z_j) \right).$$

If  $f$  and the  $z_k$  ( $= x_k$ ) are real, and  $f$  is  $n$  times continuously differentiable on a closed interval containing the  $x_k$ , then

$$\mathbf{3.3.36} \quad [x_0, x_1, \dots, x_n]f = \frac{f^{(n)}(\xi)}{n!}$$

and again  $\xi$  is as in §3.3(i). If  $f$  is analytic in a simply-connected domain  $D$ , then for  $z \in D$ ,

$$\mathbf{3.3.37} \quad [z_0, z_1, \dots, z_n]f = \frac{1}{2\pi i} \int_C \frac{f(\zeta)}{\omega_{n+1}(\zeta)} d\zeta,$$

where  $\omega_{n+1}(\zeta)$  is given by (3.3.3), and  $C$  is a simple closed contour in  $D$  described in the positive rotational sense and enclosing  $z_0, z_1, \dots, z_n$ .

### 3.3(iv) Newton's Interpolation Formula

This represents the Lagrange interpolation polynomial in terms of divided differences:

**3.3.38**

$$\begin{aligned} f(z) &= [z_0]f + (z - z_0)[z_0, z_1]f \\ &\quad + (z - z_0)(z - z_1)[z_0, z_1, z_2]f + \dots \\ &\quad + (z - z_0)(z - z_1) \cdots (z - z_{n-1})[z_0, z_1, \dots, z_n]f \\ &\quad + R_n(z). \end{aligned}$$

The interpolation error  $R_n(z)$  is as in §3.3(i). Newton's formula has the advantage of allowing easy updating: incorporation of a new point  $z_{n+1}$  requires only addition of the term with  $[z_0, z_1, \dots, z_{n+1}]f$  to (3.3.38), plus the computation of this divided difference. Another advantage is its robustness with respect to confluence of the set of points  $z_0, z_1, \dots, z_n$ . For example, for  $k+1$  coincident points the limiting form is given by  $[z_0, z_0, \dots, z_0]f = f^{(k)}(z_0)/k!$ .

### 3.3(v) Inverse Interpolation

In this method we interchange the roles of the points  $z_k$  and the function values  $f_k$ . It can be used for solving a nonlinear scalar equation  $f(z) = 0$  approximately. Another approach is to combine the methods of §3.8 with direct interpolation and §3.4.

#### Example

To compute the first negative zero  $a_1 = -2.33810\ 7410\dots$  of the Airy function  $f(x) = \text{Ai}(x)$  (§9.2). The inverse interpolation polynomial is given by

$$\mathbf{3.3.39} \quad \begin{aligned} x(f) &= [f_0]x + (f - f_0)[f_0, f_1]x \\ &\quad + (f - f_0)(f - f_1)[f_0, f_1, f_2]x; \end{aligned}$$

compare (3.3.38). With  $x_0 = -2.2$ ,  $x_1 = -2.3$ ,  $x_2 = -2.4$ , we obtain

**3.3.40**

$$\begin{aligned} x &= -2.2 \\ &\quad + 1.44011\ 1973(f - 0.09614\ 53780) + 0.08865\ 85832 \\ &\quad \times (f - 0.09614\ 53780)(f - 0.02670\ 63331), \end{aligned}$$

and with  $f = 0$  we find that  $x = -2.33823\ 2462$ , with 4 correct digits. By using this approximation to  $x$  as a new point,  $x_3 = x$ , and evaluating  $[f_0, f_1, f_2, f_3]x = 1.12388\ 6190$ , we find that  $x = -2.33810\ 7409$ , with 9 correct digits.

For comparison, we use Newton's interpolation formula (3.3.38)

$$\mathbf{3.3.41} \quad \begin{aligned} f(x) &= 0.09614\ 53780 + 0.69439\ 04495(x + 2.1) \\ &\quad - 0.03007\ 14275(x + 2.2)(x + 2.3), \end{aligned}$$

with the derivative

$$\mathbf{3.3.42} \quad f'(x) = 0.55906\ 90257 - 0.06014\ 28550x,$$

and compute an approximation to  $a_1$  by using Newton's rule (§3.8(ii)) with starting value  $x = -2.5$ . This gives the new point  $x_3 = -2.33934\ 0514$ . Then by using  $x_3$  in Newton's interpolation formula, evaluating  $[x_0, x_1, x_2, x_3]f = -0.26608\ 28233$  and recomputing  $f'(x)$ , another application of Newton's rule with starting value  $x_3$  gives the approximation  $x = 2.33810\ 7373$ , with 8 correct digits.

### 3.3(vi) Other Interpolation Methods

For Hermite interpolation, trigonometric interpolation, spline interpolation, rational interpolation (by using continued fractions), interpolation based on Chebyshev points, and bivariate interpolation, see Bulirsch and Rutishauser (1968), Davis (1975, pp. 27–31), and Mason and Handscomb (2003, Chapter 6). These references also describe convergence properties of the interpolation formulas.

For interpolation of a bounded function  $f$  on  $\mathbb{R}$  the *cardinal function* of  $f$  is defined by

$$3.3.43 \quad C(f, h)(x) = \sum_{k=-\infty}^{\infty} f(kh)S(k, h)(x),$$

where

$$3.3.44 \quad S(k, h)(x) = \frac{\sin(\pi(x - kh)/h)}{\pi(x - kh)/h},$$

is called the *Sinc function*. For theory and applications see Stenger (1993, Chapter 3).

## 3.4 Differentiation

### 3.4(i) Equally-Spaced Nodes

The Lagrange  $(n + 1)$ -point formula is

$$3.4.1 \quad hf'_t = hf'(x_0 + th) = \sum_{k=n_0}^{n_1} B_k^n f_k + hR'_{n,t}, \quad n_0 < t < n_1,$$

and follows from the differentiated form of (3.3.4). The  $B_k^n$  are the *differentiated Lagrangian interpolation coefficients*:

$$3.4.2 \quad B_k^n = dA_k^n/dt,$$

where  $A_k^n$  is as in (3.3.10).

If  $f^{(n+2)}(x)$  is continuous on the interval  $I$  defined in §3.3(i), then the remainder in (3.4.1) is given by

$$3.4.3 \quad hf'_{n,t} = \frac{h^{n+1}}{(n+1)!} \left( f^{(n+1)}(\xi_0) \frac{d}{dt} \prod_{k=n_0}^{n_1} (t - k) + f^{(n+2)}(\xi_1) \prod_{k=n_0}^{n_1} (t - k) \right),$$

where  $\xi_0$  and  $\xi_1 \in I$ .

For the values of  $n_0$  and  $n_1$  used in the formulas below

$$3.4.4 \quad h|R'_{n,t}| \leq h^{n+1} \left( c_n |f^{(n+2)}(\xi_1)| + \frac{1}{n+1} |f^{(n+1)}(\xi_0)| \right),$$

$$n_0 < t < n_1,$$

where  $c_n$  is defined by (3.3.12), with numerical values as in §3.3(ii).

#### Two-Point Formula

$$3.4.5 \quad hf'_t = -f_0 + f_1 + hR'_{1,t}, \quad 0 < t < 1.$$

#### Three-Point Formula

$$3.4.6 \quad hf'_t = -\frac{1}{2}(1-2t)f_{-1} - 2tf_0 + \frac{1}{2}(1+2t)f_1 + hR'_{2,t},$$

$$|t| < 1.$$

For four-point to eight-point formulas see <http://dlmf.nist.gov/3.4.i>.

For corresponding formulas for second, third, and fourth derivatives, with  $t = 0$ , see Collatz (1960, Table III, pp. 538–539). For formulas for derivatives with equally-spaced real nodes and based on Sinc approximations (§3.3(vi)), see Stenger (1993, §3.5).

### 3.4(ii) Analytic Functions

If  $f$  can be extended analytically into the complex plane, then from Cauchy's integral formula (§1.9(iii))

$$3.4.17 \quad \frac{1}{k!} f^{(k)}(x_0) = \frac{1}{2\pi i} \int_C \frac{f(\zeta)}{(\zeta - x_0)^{k+1}} d\zeta,$$

where  $C$  is a simple closed contour described in the positive rotational sense such that  $C$  and its interior lie in the domain of analyticity of  $f$ , and  $x_0$  is interior to  $C$ . Taking  $C$  to be a circle of radius  $r$  centered at  $x_0$ , we obtain

$$3.4.18 \quad \frac{1}{k!} f^{(k)}(x_0) = \frac{1}{2\pi r^k} \int_0^{2\pi} f(x_0 + re^{i\theta}) e^{-ik\theta} d\theta.$$

The integral on the right-hand side can be approximated by the composite trapezoidal rule (3.5.2).

#### Example

$f(z) = e^z$ ,  $x_0 = 0$ . The integral (3.4.18) becomes

$$3.4.19 \quad \frac{1}{k!} = \frac{1}{2\pi r^k} \int_0^{2\pi} e^{r \cos \theta} \cos(r \sin \theta - k\theta) d\theta.$$

With the choice  $r = k$  (which is crucial when  $k$  is large because of numerical cancellation) the integrand equals  $e^k$  at the dominant points  $\theta = 0, 2\pi$ , and in combination with the factor  $k^{-k}$  in front of the integral sign this gives a rough approximation to  $1/k!$ . The choice  $r = k$  is motivated by saddle-point analysis; see §2.4(iv) or examples in §3.5(ix). As explained in §§3.5(i) and 3.5(ix) the composite trapezoidal rule can be very efficient for computing integrals with analytic periodic integrands.

### 3.4(iii) Partial Derivatives

#### First-Order

For partial derivatives we use the notation  $u_{t,s} = u(x_0 + th, y_0 + sh)$ .

$$3.4.20 \quad \frac{\partial u_{0,0}}{\partial x} = \frac{1}{2h} (u_{1,0} - u_{-1,0}) + O(h^2),$$

$$3.4.21 \quad \frac{\partial u_{0,0}}{\partial x} = \frac{1}{4h} (u_{1,1} - u_{-1,1} + u_{1,-1} - u_{-1,-1}) + O(h^2).$$

#### Second-Order

$$3.4.22 \quad \frac{\partial^2 u_{0,0}}{\partial x^2} = \frac{1}{h^2} (u_{1,0} - 2u_{0,0} + u_{-1,0}) + O(h^2),$$

$$3.4.23 \quad \frac{\partial^2 u_{0,0}}{\partial x^2} = \frac{1}{12h^2} (-u_{2,0} + 16u_{1,0} - 30u_{0,0} + 16u_{-1,0} - u_{-2,0}) + O(h^4),$$

$$3.4.24 \quad \frac{\partial^2 u_{0,0}}{\partial x^2} = \frac{1}{3h^2} (u_{1,1} - 2u_{0,1} + u_{-1,1} + u_{1,0} - 2u_{0,0} + u_{-1,0} + u_{1,-1} - 2u_{0,-1} + u_{-1,-1}) + O(h^2).$$

$$3.4.25 \quad \frac{\partial^2 u_{0,0}}{\partial x \partial y} = \frac{1}{4h^2} (u_{1,1} - u_{1,-1} - u_{-1,1} + u_{-1,-1}) + O(h^2),$$

$$3.4.26 \quad \frac{\partial^2 u_{0,0}}{\partial x \partial y} = -\frac{1}{2h^2} (u_{1,0} + u_{-1,0} + u_{0,1} + u_{0,-1} - 2u_{0,0} - u_{1,1} - u_{-1,-1}) + O(h^2).$$

#### Laplacian

$$3.4.27 \quad \nabla^2 u = \frac{\partial^2 u}{\partial x^2} + \frac{\partial^2 u}{\partial y^2}.$$

$$3.4.28 \quad \nabla^2 u_{0,0} = \frac{1}{h^2} (u_{1,0} + u_{0,1} + u_{-1,0} + u_{0,-1} - 4u_{0,0}) + O(h^2),$$

$$3.4.29 \quad \begin{aligned} \nabla^2 u_{0,0} &= \frac{1}{12h^2} (-60u_{0,0} + 16(u_{1,0} + u_{0,1} + u_{-1,0} + u_{0,-1}) \\ &\quad - (u_{2,0} + u_{0,2} + u_{-2,0} + u_{0,-2})) + O(h^4). \end{aligned}$$

For fourth-order formulas and the biharmonic operator see <http://dlmf.nist.gov/3.4.iii>.

The results in this subsection for the partial derivatives follow from Panow (1955, Table 10). Those for the Laplacian and the biharmonic operator follow from the formulas for the partial derivatives.

For additional formulas involving values of  $\nabla^2 u$  and  $\nabla^4 u$  on square, triangular, and cubic grids, see Collatz (1960, Table VI, pp. 542–546).

## 3.5 Quadrature

### 3.5(i) Trapezoidal Rules

The *elementary trapezoidal rule* is given by

$$3.5.1 \quad \int_a^b f(x) dx = \frac{1}{2}h(f(a) + f(b)) - \frac{1}{12}h^3 f''(\xi),$$

where  $h = b - a$ ,  $f \in C^2[a, b]$ , and  $a < \xi < b$ .

The *composite trapezoidal rule* is

$$3.5.2 \quad \int_a^b f(x) dx = h(\frac{1}{2}f_0 + f_1 + \cdots + f_{n-1} + \frac{1}{2}f_n) + E_n(f),$$

where  $h = (b - a)/n$ ,  $x_k = a + kh$ ,  $f_k = f(x_k)$ ,  $k = 0, 1, \dots, n$ , and

$$3.5.3 \quad E_n(f) = -\frac{b-a}{12}h^2 f''(\xi), \quad a < \xi < b.$$

If in addition  $f$  is periodic,  $f \in C^k(\mathbb{R})$ , and the integral is taken over a period, then

$$3.5.4 \quad E_n(f) = O(h^k), \quad h \rightarrow 0.$$

In particular, when  $k = \infty$  the error term is an exponentially-small function of  $1/h$ , and in these circumstances the composite trapezoidal rule is exceptionally efficient. For an example see §3.5(ix).

Similar results hold for the trapezoidal rule in the form

$$3.5.5 \quad \int_{-\infty}^{\infty} f(t) dt = h \sum_{k=-\infty}^{\infty} f(kh) + E_h(f),$$

with a function  $f$  that is analytic in a strip containing  $\mathbb{R}$ . For further information and examples, see Goodwin (1949a). In Stenger (1993, Chapter 3) the rule (3.5.5) is considered in the framework of Sinc approximations (§3.3(vi)). See also Poisson's summation formula (§1.8(iv)).

If  $k$  in (3.5.4) is not arbitrarily large, and if odd-order derivatives of  $f$  are known at the end points  $a$  and  $b$ , then the composite trapezoidal rule can be improved by means of the Euler–Maclaurin formula (§2.10(i)). See Davis and Rabinowitz (1984, pp. 134–142) and Temme (1996a, p. 25).

### 3.5(ii) Simpson's Rule

Let  $h = \frac{1}{2}(b - a)$  and  $f \in C^4[a, b]$ . Then the *elementary Simpson's rule* is

$$3.5.6 \quad \int_a^b f(x) dx = \frac{1}{3}h(f(a) + 4f(\frac{1}{2}(a + b)) + f(b)) - \frac{1}{90}h^5 f^{(4)}(\xi),$$

where  $a < \xi < b$ .

Now let  $h = (b-a)/n$ ,  $x_k = a + kh$ , and  $f_k = f(x_k)$ ,  $k = 0, 1, \dots, n$ . Then the *composite Simpson's rule* is

$$3.5.7 \quad \int_a^b f(x) dx = \frac{1}{3}h(f_0 + 4f_1 + 2f_2 + 4f_3 + 2f_4 + \dots + 4f_{n-1} + f_n) + E_n(f),$$

where  $n$  is even and

$$3.5.8 \quad E_n(f) = -\frac{b-a}{180}h^4 f^{(4)}(\xi), \quad a < \xi < b.$$

Simpson's rule can be regarded as a combination of two trapezoidal rules, one with step size  $h$  and one with step size  $h/2$  to refine the error term.

### 3.5(iii) Romberg Integration

Further refinements are achieved by *Romberg integration*. If  $f \in C^{2m+2}[a, b]$ , then the remainder  $E_n(f)$  in (3.5.2) can be expanded in the form

$$3.5.9 \quad E_n(f) = c_1h^2 + c_2h^4 + \dots + c_mh^{2m} + O(h^{2m+2}),$$

where  $h = (b-a)/n$ . As in Simpson's rule, by combining the rule for  $h$  with that for  $h/2$ , the first error term  $c_1h^2$  in (3.5.9) can be eliminated. With the Romberg scheme successive terms  $c_1h^2, c_2h^4, \dots$ , in (3.5.9) are eliminated, according to the formula

$$3.5.10 \quad G_k(\frac{1}{2}h) = G_{k-1}(\frac{1}{2}h) + \frac{G_{k-1}(\frac{1}{2}h) - G_{k-1}(h)}{4^k - 1}, \quad k \geq 1,$$

beginning with

$$3.5.11 \quad G_0(h) = h(\frac{1}{2}f_0 + f_1 + \dots + f_{n-1} + \frac{1}{2}f_n),$$

although we may also start with the elementary rule with  $G_0(h) = \frac{1}{2}h(f(a) + f(b))$  and  $h = b - a$ . To generate  $G_k(h)$  the quantities  $G_0(h), G_0(h/2), \dots, G_0(h/2^k)$  are needed. These can be found by means of the recursion

$$3.5.12 \quad G_0(\frac{1}{2}h) = \frac{1}{2}G_0(h) + \frac{1}{2}h \sum_{k=0}^{n-1} f(x_0 + (k + \frac{1}{2})h),$$

which depends on function values computed previously.

If  $f \in C^{2k+2}(a, b)$ , then for  $j, k = 0, 1, \dots$ ,

$$3.5.13 \quad \int_a^b f(x) dx - G_k\left(\frac{b-a}{2^j}\right) = -\frac{(b-a)^{2k+3}}{2^{k(k+1)}} \frac{4^{-j(k+1)}}{(2k+2)!} |B_{2k+2}| f^{(2k+2)}(\xi),$$

for some  $\xi \in (a, b)$ . For the Bernoulli numbers  $B_m$  see §24.2(i).

When  $f \in C^\infty$ , the Romberg method affords a means of obtaining high accuracy in many cases with a relatively simple adaptive algorithm. However, as illustrated by the next example, other methods may be more efficient.

### Example

With  $J_0(t)$  denoting the Bessel function (§10.2(ii)) the integral

$$3.5.14 \quad \int_0^\infty e^{-pt} J_0(t) dt = \frac{1}{\sqrt{p^2 + 1}}$$

is computed with  $p = 1$  on the interval  $[0, 30]$ . Using (3.5.10) with  $h = 30/4 = 7.5$  we obtain  $G_7(h)$  with 14 correct digits. About  $2^9 = 512$  function evaluations are needed. (With the 20-point Gauss-Laguerre formula (§3.5(v)) the same precision can be achieved with 15 function evaluations.) With  $j = 2$  and  $k = 7$ , the coefficient of the derivative  $f^{(16)}(\xi)$  in (3.5.13) is found to be  $(0.14\dots) \times 10^{-13}$ .

See Davis and Rabinowitz (1984, pp. 440–441) for modifications of the Romberg method when the function  $f$  is singular.

### 3.5(iv) Interpolatory Quadrature Rules

An *interpolatory quadrature rule*

$$3.5.15 \quad \int_a^b f(x)w(x) dx = \sum_{k=1}^n w_k f(x_k) + E_n(f),$$

with *weight function*  $w(x)$ , is one for which  $E_n(f) = 0$  whenever  $f$  is a polynomial of degree  $\leq n-1$ . The *nodes*  $x_1, x_2, \dots, x_n$  are prescribed, and the *weights*  $w_k$  and *error term*  $E_n(f)$  are found by integrating the product of the Lagrange interpolation polynomial of degree  $n-1$  and  $w(x)$ .

If the extreme members of the set of nodes  $x_1, x_2, \dots, x_n$  are the endpoints  $a$  and  $b$ , then the quadrature rule is said to be *closed*. Or if the set  $x_1, x_2, \dots, x_n$  lies in the open interval  $(a, b)$ , then the quadrature rule is said to be *open*.

Rules of closed type include the *Newton-Cotes formulas* such as the trapezoidal rules and *Simpson's rule*. Examples of open rules are the Gauss formulas (§3.5(v)), the *midpoint rule*, and *Fejér's quadrature rule*. For the latter  $a = -1$ ,  $b = 1$ , and the nodes  $x_k$  are the extrema of the Chebyshev polynomial  $T_n(x)$  (§3.11(ii) and §18.3). If we add  $-1$  and  $1$  to this set of  $x_k$ , then the resulting closed formula is the frequently-used *Clenshaw-Curtis formula*, whose weights are positive and given by

$$3.5.16 \quad w_k = \frac{g_k}{n} \left( 1 - \sum_{j=1}^{\lfloor n/2 \rfloor} \frac{b_j}{4j^2 - 1} \cos(2jk\pi/n) \right),$$

where  $x_k = \cos(k\pi/n)$ ,  $k = 0, 1, \dots, n$ , and

$$3.5.17 \quad g_k = \begin{cases} 1, & k = 0, n, \\ 2, & \text{otherwise,} \end{cases} \quad b_j = \begin{cases} 1, & j = \frac{1}{2}n, \\ 2, & \text{otherwise.} \end{cases}$$

For further information, see Mason and Handscomb (2003, Chapter 8), Davis and Rabinowitz (1984, pp. 74–92), and Clenshaw and Curtis (1960).



For a detailed comparison of the Clenshaw–Curtis formula with Gauss quadrature (§3.5(v)), see Trefethen (2008).

### 3.5(v) Gauss Quadrature

Let  $\{p_n\}$  denote the set of monic polynomials  $p_n$  of degree  $n$  (coefficient of  $x^n$  equal to 1) that are orthogonal with respect to a positive weight function  $w$  on a finite or infinite interval  $(a, b)$ ; compare §18.2(i). In *Gauss quadrature* (also known as *Gauss–Christoffel quadrature*) we use (3.5.15) with nodes  $x_k$  the zeros of  $p_n$ , and weights  $w_k$  given by

$$3.5.18 \quad w_k = \int_a^b \frac{p_n(x)}{(x - x_k)p'_n(x_k)} w(x) dx.$$

The  $w_k$  are also known as *Christoffel coefficients* or *Christoffel numbers* and they are all positive. The remainder is given by

$$3.5.19 \quad E_n(f) = \gamma_n f^{(2n)}(\xi)/(2n)!,$$

where

$$3.5.20 \quad \gamma_n = \int_a^b p_n^2(x) w(x) dx,$$

and  $\xi$  is some point in  $(a, b)$ . As a consequence, the rule is exact for polynomials of degree  $\leq 2n - 1$ .

In practical applications the weight function  $w(x)$  is chosen to simulate the asymptotic behavior of the integrand as the endpoints are approached. For  $C^\infty$  functions Gauss quadrature can be very efficient. In adaptive algorithms the evaluation of the nodes and weights may cause difficulties, unless exact values are known.

For the derivation of Gauss quadrature formulas see Gautschi (2004, pp. 22–32), Gil *et al.* (2007a, §5.3), and Davis and Rabinowitz (1984, §§2.7 and 3.6). Stroud and Secrest (1966) includes computational methods and extensive tables. For further extensions, applications, and computation of orthogonal polynomials and Gauss-type formulas, see Gautschi (1994, 1996, 2004). For effective testing of Gaussian quadrature rules see Gautschi (1983).

For the classical orthogonal polynomials related to the following Gauss rules, see §18.3. The given quantities  $\gamma_n$  follow from (18.2.5), (18.2.7), Table 18.3.1, and the relation  $\gamma_n = h_n/k_n^2$ .

#### Gauss–Jacobi Formula

$$3.5.26 \quad [a, b] = [-1, 1], \quad w(x) = (1 - x)^\alpha(1 + x)^\beta, \quad \gamma_n = \frac{\Gamma(n + \alpha + 1)\Gamma(n + \beta + 1)\Gamma(n + \alpha + \beta + 1)}{(2n + \alpha + \beta + 1)(\Gamma(2n + \alpha + \beta + 1))^2} 2^{2n + \alpha + \beta + 1} n!,$$

$$\alpha > -1, \beta > -1.$$

The  $p_n(x)$  are the monic Jacobi polynomials  $P_n^{(\alpha, \beta)}(x)$  (§18.3).

#### Gauss–Laguerre Formula

$$3.5.27 \quad [a, b] = [0, \infty), \quad w(x) = x^\alpha e^{-x}, \quad \gamma_n = n! \Gamma(n + \alpha + 1), \quad \alpha > -1.$$

#### Gauss–Legendre Formula

##### 3.5.21

$$[a, b] = [-1, 1], \quad w(x) = 1, \quad \gamma_n = \frac{2^{2n+1}}{2n+1} \frac{(n!)^4}{((2n)!)^2}.$$

The nodes  $x_k$  and weights  $w_k$  for  $n = 5, 10$  are shown in Tables 3.5.1 and 3.5.2. The  $p_n(x)$  are the *monic* Legendre polynomials, that is, the polynomials  $P_n(x)$  (§18.3) scaled so that the coefficient of the highest power of  $x$  in their explicit forms is unity.

Table 3.5.1: Nodes and weights for the 5-point Gauss–Legendre formula.

$\pm x_k$	$w_k$
0.00000 00000 00000	0.56888 88888 88889
0.53846 93101 05683	0.47862 86704 99366
0.90617 98459 38664	0.23692 68850 56189

Table 3.5.2: Nodes and weights for the 10-point Gauss–Legendre formula.

$\pm x_k$	$w_k$
0.14887 43389 81631 211	0.29552 42247 14752 870
0.43339 53941 29247 191	0.26926 67193 09996 355
0.67940 95682 99024 406	0.21908 63625 15982 044
0.86506 33666 88984 511	0.14945 13491 50580 593
0.97390 65285 17171 720	0.06667 13443 08688 138

For corresponding results for  $n = 20, 40, 80$ ; see <http://dlmf.nist.gov/3.5.v>.

#### Gauss–Chebyshev Formula

##### 3.5.22

$$[a, b] = [-1, 1], \quad w(x) = (1 - x^2)^{-1/2}, \quad \gamma_n = \frac{\pi}{2^{2n-1}}.$$

The nodes  $x_k$  and weights  $w_k$  are known explicitly:

##### 3.5.23

$$x_k = \cos\left(\frac{2k-1}{2n}\pi\right), \quad w_k = \frac{\pi}{n}, \quad k = 1, 2, \dots, n.$$

Nodes and weights are also known explicitly for the other three weight functions in the set  $w(x) = (1 - x)^{\pm 1/2}(1 + x)^{\pm 1/2}$ ; see <http://dlmf.nist.gov/3.5.v>.

If  $\alpha \neq 0$  this is called the *generalized Gauss–Laguerre formula*.

The nodes  $x_k$  and weights  $w_k$  for  $\alpha = 0$  and  $n = 5, 10$  are shown in Tables 3.5.6 and 3.5.7. The  $p_n(x)$  are the monic Laguerre polynomials  $L_n(x)$  (§18.3).

Table 3.5.6: Nodes and weights for the 5-point Gauss–Laguerre formula.

$x_k$	$w_k$
0.26356 03197 18141	0.52175 56105 82809
0.14134 03059 10652 $\times 10^1$	0.39866 68110 83176
0.35964 25771 04072 $\times 10^1$	0.75942 44968 17076 $\times 10^{-1}$
0.70858 10005 85884 $\times 10^1$	0.36117 58679 92205 $\times 10^{-2}$
0.12640 80084 42758 $\times 10^2$	0.23369 97238 57762 $\times 10^{-4}$

Table 3.5.7: Nodes and weights for the 10-point Gauss–Laguerre formula.

$x_k$	$w_k$
0.13779 34705 40492 431	0.30844 11157 65020 141
0.72945 45495 03170 498	0.40111 99291 55273 552
0.18083 42901 74031 605 $\times 10^1$	0.21806 82876 11809 422
0.34014 33697 85489 951 $\times 10^1$	0.62087 45609 86777 475 $\times 10^{-1}$
0.55524 96140 06380 363 $\times 10^1$	0.95015 16975 18110 055 $\times 10^{-2}$
0.83301 52746 76449 670 $\times 10^1$	0.75300 83885 87538 775 $\times 10^{-3}$
0.11843 78583 79000 656 $\times 10^2$	0.28259 23349 59956 557 $\times 10^{-4}$
0.16279 25783 13781 021 $\times 10^2$	0.42493 13984 96268 637 $\times 10^{-6}$
0.21996 58581 19807 620 $\times 10^2$	0.18395 64823 97963 078 $\times 10^{-8}$
0.29920 69701 22738 916 $\times 10^2$	0.99118 27219 60900 856 $\times 10^{-12}$

For the corresponding results for  $n = 15, 20$  see <http://dlmf.nist.gov/3.5.v>.

### Gauss–Hermite Formula

3.5.28  $(a, b) = (-\infty, \infty), \quad w(x) = e^{-x^2}, \quad \gamma_n = \sqrt{\pi} \frac{n!}{2^n}.$

The nodes  $x_k$  and weights  $w_k$  for  $n = 5, 10$  are shown in Tables 3.5.10 and 3.5.11. The  $p_n(x)$  are the monic Hermite polynomials  $H_n(x)$  (§18.3).

Table 3.5.10: Nodes and weights for the 5-point Gauss–Hermite formula.

$\pm x_k$	$w_k$
0.00000 00000 00000	0.94530 87204 82942
0.95857 24646 13819	0.39361 93231 52241
0.20201 82870 45609 $\times 10^1$	0.19953 24205 90459 $\times 10^{-1}$

Table 3.5.11: Nodes and weights for the 10-point Gauss–Hermite formula.

$\pm x_k$	$w_k$
0.34290 13272 23704 609	0.61086 26337 35325 799
0.10366 10829 78951 365 $\times 10^1$	0.24013 86110 82314 686
0.17566 83649 29988 177 $\times 10^1$	0.33874 39445 54810 631 $\times 10^{-1}$
0.25327 31674 23278 980 $\times 10^1$	0.13436 45746 78123 269 $\times 10^{-2}$
0.34361 59118 83773 760 $\times 10^1$	0.76404 32855 23262 063 $\times 10^{-5}$

For the corresponding results for  $n = 15, 20$  see <http://dlmf.nist.gov/3.5.v>.

### Gauss Formula for a Logarithmic Weight Function

3.5.29  $[a, b] = [0, 1], \quad w(x) = \ln(1/x).$

The nodes  $x_k$  and weights  $w_k$  for  $n = 5, 10$  are shown in Tables 3.5.14 and 3.5.15.

Table 3.5.14: Nodes and weights for the 5-point Gauss formula for the logarithmic weight function.

$x_k$	$w_k$
0.29134 47215 19721 $\times 10^{-1}$	0.29789 34717 82894
0.17397 72133 20898	0.34977 62265 13224
0.41170 25202 84902	0.23448 82900 44052
0.67731 41745 82820	0.98930 45951 66331 $\times 10^{-1}$
0.89477 13610 31008	0.18911 55214 31958 $\times 10^{-1}$

Table 3.5.15: Nodes and weights for the 10-point Gauss formula for the logarithmic weight function.

$x_k$	$w_k$
0.90426 30962 19965 064 $\times 10^{-2}$	0.12095 51319 54570 515
0.53971 26622 25006 295 $\times 10^{-1}$	0.18636 35425 64071 870
0.13531 18246 39250 775	0.19566 08732 77759 983
0.24705 24162 87159 824	0.17357 71421 82906 921
0.38021 25396 09332 334	0.13569 56729 95484 202
0.52379 23179 71843 201	0.93646 75853 81105 260 $\times 10^{-1}$
0.66577 52055 16424 597	0.55787 72735 14158 741 $\times 10^{-1}$
0.79419 04160 11966 217	0.27159 81089 92333 311 $\times 10^{-1}$
0.89816 10912 19003 538	0.95151 82602 84851 500 $\times 10^{-2}$
0.96884 79887 18633 539	0.16381 57633 59826 325 $\times 10^{-2}$

For the corresponding results for  $n = 15, 20$  see <http://dlmf.nist.gov/3.5.v>.

### 3.5(vi) Eigenvalue/Eigenvector Characterization of Gauss Quadrature Formulas

All the monic orthogonal polynomials  $\{p_n\}$  used with Gauss quadrature satisfy a three-term recurrence relation (§18.2(iv)):

#### 3.5.30

$p_{k+1}(x) = (x - \alpha_k)p_k(x) - \beta_k p_{k-1}(x)$ ,  $k = 0, 1, \dots$ , with  $\beta_k > 0$ ,  $p_{-1}(x) = 0$ , and  $p_0(x) = 1$ .

The Gauss nodes  $x_k$  (the zeros of  $p_n$ ) are the eigenvalues of the (symmetric tridiagonal) *Jacobi matrix* of order  $n \times n$ :

#### 3.5.31

$$\mathbf{J}_n = \begin{bmatrix} \alpha_0 & \sqrt{\beta_1} & & & 0 \\ \sqrt{\beta_1} & \alpha_1 & \sqrt{\beta_2} & & \\ & \ddots & \ddots & \ddots & \\ & & \sqrt{\beta_{n-2}} & \alpha_{n-2} & \sqrt{\beta_{n-1}} \\ 0 & & \sqrt{\beta_{n-1}} & \alpha_{n-1} & \end{bmatrix}.$$

Let  $\mathbf{v}_k$  denote the normalized eigenvector of  $\mathbf{J}_n$  corresponding to the eigenvalue  $x_k$ . Then the weights are given by

$$3.5.32 \quad w_k = \beta_0 v_{k,1}^2, \quad k = 1, 2, \dots, n,$$

where  $\beta_0 = \int_a^b w(x) dx$  and  $v_{k,1}$  is the first element of  $\mathbf{v}_k$ . Also, the error constant (3.5.20) is given by

$$3.5.33 \quad \gamma_n = \beta_0 \beta_1 \cdots \beta_n.$$

Tables 3.5.1, 3.5.2, 3.5.6, 3.5.7, 3.5.10, and 3.5.11 can be verified by application of the results given in the present subsection. In these cases the coefficients  $\alpha_k$  and  $\beta_k$  are obtainable explicitly from results given in §18.9(i).

### 3.5(vii) Oscillatory Integrals

Integrals of the form

$$3.5.34 \quad \int_a^b f(x) \cos(\omega x) dx, \quad \int_a^b f(x) \sin(\omega x) dx,$$

can be computed by *Filon's rule*. See Davis and Rabinowitz (1984, pp. 146–168).

Oscillatory integral transforms are treated in Wong (1982) by a method based on Gaussian quadrature. A comparison of several methods, including an extension of the Clenshaw–Curtis formula (§3.5(iv)), is given in Evans and Webster (1999).

For computing infinite oscillatory integrals, *Longman's method* may be used. The integral is written as an alternating series of positive and negative subintegrals that are computed individually; see Longman (1956). Convergence acceleration schemes, for example Levin's transformation (§3.9(v)), can be used when evaluating the series. Further methods are given in Clendenin (1966) and Lyness (1985).

For a comprehensive survey of quadrature of highly oscillatory integrals, including multidimensional integrals, see Iserles *et al.* (2006).

### 3.5(viii) Complex Gauss Quadrature

For the Bromwich integral

3.5.35

$$I(f) = \frac{1}{2\pi i} \int_{c-i\infty}^{c+i\infty} e^{\zeta} \zeta^{-s} f(\zeta) d\zeta, \quad s > 0, c > c_0 > 0,$$

a complex Gauss quadrature formula is available. Here  $f(\zeta)$  is assumed analytic in the half-plane  $\Re\zeta > c_0$  and bounded as  $\zeta \rightarrow \infty$  in  $|\text{ph } \zeta| \leq \frac{1}{2}\pi$ . The quadrature rule for (3.5.35) is

3.5.36 
$$I(f) = \sum_{k=1}^n w_k f(\zeta_k) + E_n(f),$$

where  $E_n(f) = 0$  if  $f(\zeta)$  is a polynomial of degree  $\leq 2n - 1$  in  $1/\zeta$ . Complex orthogonal polynomials  $p_n(1/\zeta)$  of degree  $n = 0, 1, 2, \dots$ , in  $1/\zeta$  that satisfy the orthogonality condition

3.5.37 
$$\int_{c-i\infty}^{c+i\infty} e^{\zeta} \zeta^{-s} p_k(1/\zeta) p_\ell(1/\zeta) d\zeta = 0, \quad k \neq \ell,$$

are related to Bessel polynomials (§§10.49(ii) and 18.34). The complex Gauss nodes  $\zeta_k$  have positive real part for all  $s > 0$ .

The nodes and weights of the 5-point complex Gauss quadrature formula (3.5.36) for  $s = 1$  are shown in Table 3.5.18. Extensive tables of quadrature nodes and weights can be found in Krylov and Skoblya (1985).

Table 3.5.18: Nodes and weights for the 5-point complex Gauss quadrature formula with  $s = 1$ .

$\zeta_k$	$w_k$
3.65569 4325+6.54373 6899i	3.83966 1630-0.27357 03863i
3.65569 4325-6.54373 6899i	3.83966 1630+0.27357 03863i
5.70095 3299+3.21026 5600i	-25.07945 221 +2.18725 2294i
5.70095 3299-3.21026 5600i	-25.07945 221 -2.18725 2294i
6.28670 4752+0.00000 0000i	43.47958 116 +0.00000 0000i

#### Example. Laplace Transform Inversion

From §1.14(iii)

3.5.38 
$$G(p) = \int_0^\infty e^{-pt} g(t) dt,$$

3.5.39 
$$g(t) = \frac{1}{2\pi i} \int_{\sigma-i\infty}^{\sigma+i\infty} e^{tp} G(p) dp,$$

with appropriate conditions. The pair

3.5.40 
$$g(t) = J_0(t), \quad G(p) = \frac{1}{\sqrt{p^2 + 1}},$$

where  $J_0(t)$  is the Bessel function (§10.2(ii)), satisfy these conditions, provided that  $\sigma > 0$ . The integral (3.5.39) has the form (3.5.35) if we set  $\zeta = tp$ ,  $c = t\sigma$ , and  $f(\zeta) = t^{-1}\zeta^s G(\zeta/t)$ . We choose  $s = 1$  so that  $f(\zeta) = O(1)$  at infinity. Equation (3.5.36), without the error term, becomes

3.5.41 
$$g(t) = \sum_{k=1}^n \frac{w_k \zeta_k}{\sqrt{\zeta_k^2 + t^2}},$$

approximately.

Using Table 3.5.18 we compute  $g(t)$  for  $n = 5$ . The results are given in the middle column of Table 3.5.19, accompanied by the actual 10D values in the last column. Agreement is very good for small values of  $t$ , but not for larger values. For these cases the integration path may need to be deformed; see §3.5(ix).

Table 3.5.19: Laplace transform inversion.

$t$	$g(t)$	$J_0(t)$
0.0	1.00000 00000	1.00000 00000
0.5	0.93846 98072	0.93846 98072
1.0	0.76519 76866	0.76519 76865
2.0	0.22389 07791	0.22389 10326
5.0	-0.17759 67713	-0.17902 54097
10.0	-0.24593 57645	-0.07540 53543

### 3.5(ix) Other Contour Integrals

A frequent problem with contour integrals is heavy cancellation, which occurs especially when the value of the integral is exponentially small compared with the maximum absolute value of the integrand. To avoid cancellation we try to deform the path to pass through a saddle point in such a way that the maximum contribution of the integrand is derived from the neighborhood of the saddle point. For example, steepest descent paths can be used; see §2.4(iv).

#### Example

In (3.5.35) take  $s = 1$  and  $f(\zeta) = e^{-2\lambda\sqrt{\zeta}}$ , with  $\lambda > 0$ . When  $\lambda$  is large the integral becomes exponentially small, and application of the quadrature rule of §3.5(viii) is useless. In fact from (7.14.4) and the

inversion formula for the Laplace transform (§1.14(iii)) we have

$$3.5.42 \quad \operatorname{erfc} \lambda = \frac{1}{2\pi i} \int_{c-i\infty}^{c+i\infty} e^{\zeta-2\lambda\sqrt{\zeta}} \frac{d\zeta}{\zeta}, \quad c > 0,$$

where  $\operatorname{erfc} z$  is the complementary error function, and from (7.12.1) it follows that

$$3.5.43 \quad \operatorname{erfc} \lambda \sim \frac{e^{-\lambda^2}}{\sqrt{\pi}\lambda}, \quad \lambda \rightarrow \infty.$$

With the transformation  $\zeta = \lambda^2 t$ , (3.5.42) becomes

$$3.5.44 \quad \operatorname{erfc} \lambda = \frac{1}{2\pi i} \int_{c-i\infty}^{c+i\infty} e^{\lambda^2(t-2\sqrt{t})} \frac{dt}{t}, \quad c > 0,$$

with saddle point at  $t = 1$ , and when  $c = 1$  the vertical path intersects the real axis at the saddle point. The steepest descent path is given by  $\Im(t - 2\sqrt{t}) = 0$ , or in polar coordinates  $t = re^{i\theta}$  we have  $r = \sec^2(\frac{1}{2}\theta)$ . Thus

$$3.5.45 \quad \operatorname{erfc} \lambda = \frac{e^{-\lambda^2}}{2\pi} \int_{-\pi}^{\pi} e^{-\lambda^2 \tan^2(\frac{1}{2}\theta)} d\theta.$$

The integrand can be extended as a periodic  $C^\infty$  function on  $\mathbb{R}$  with period  $2\pi$  and as noted in §3.5(i), the trapezoidal rule is exceptionally efficient in this case.

Table 3.5.20 gives the results of applying the composite trapezoidal rule (3.5.2) with step size  $h$ ;  $n$  indicates the number of function values in the rule that are larger than  $10^{-15}$  (we exploit the fact that the integrand is even). All digits shown in the approximation in the final row are correct.

Table 3.5.20: Composite trapezoidal rule for the integral (3.5.45) with  $\lambda = 10$ .

$h$	$\operatorname{erfc} \lambda$	$n$
0.25	0.20949 49432 96679 $\times 10^{-44}$	5
0.20	0.20886 11645 34559 $\times 10^{-44}$	6
0.15	0.20884 87588 72946 $\times 10^{-44}$	8
0.10	0.20884 87583 76254 $\times 10^{-44}$	11

A second example is provided in Gil *et al.* (2001), where the method of contour integration is used to evaluate Scorer functions of complex argument (§9.12). See also Gil *et al.* (2003b).

If  $f$  is meromorphic, with poles near the saddle point, then the foregoing method can be modified. A special case is the rule for Hilbert transforms (§1.14(v)):

$$3.5.46 \quad \mathcal{H}(f; x) = \frac{1}{\pi} \int_{-\infty}^{\infty} \frac{f(t)}{t-x} dt, \quad x \in \mathbb{R},$$

where the integral is the Cauchy principal value. See Kress and Martensen (1970).

Other contour integrals occur in standard integral transforms or their inverses, for example, Hankel transforms (§10.22(v)), Kontorovich–Lebedev transforms (§10.43(v)), and Mellin transforms (§1.14(iv)).

### 3.5(x) Cubature Formulas

Table 3.5.21 supplies cubature rules, including *weights*  $w_j$ , for the disk  $D$ , given by  $x^2 + y^2 \leq h^2$ :

$$3.5.47 \quad \frac{1}{\pi h^2} \iint_D f(x, y) dx dy = \sum_{j=1}^n w_j f(x_j, y_j) + R,$$

and the square  $S$ , given by  $|x| \leq h$ ,  $|y| \leq h$ :

$$3.5.48 \quad \frac{1}{4h^2} \iint_S f(x, y) dx dy = \sum_{j=1}^n w_j f(x_j, y_j) + R.$$

For these results and further information on cubature formulas see Cools (2003).

For integrals in higher dimensions, *Monte Carlo methods* are another—often the only—alternative. The standard Monte Carlo method samples points uniformly from the integration region to estimate the integral and its error. In more advanced methods points are sampled from a probability distribution, so that they are concentrated in regions that make the largest contribution to the integral. With  $N$  function values, the Monte Carlo method aims at an error of order  $1/\sqrt{N}$ , independently of the dimension of the domain of integration. See Davis and Rabinowitz (1984, pp. 384–417) and Schürer (2004).

Table 3.5.21: Cubature formulas for disk and square.

Diagram	$(x_j, y_j)$	$w_j$	$R$
	$(0, 0)$ $(\pm h, 0)$ $(0, \pm h)$	$\frac{1}{2}$ $\frac{1}{8}$ $\frac{1}{8}$	$O(h^4)$
	$(\pm \frac{1}{2}h, \pm \frac{1}{2}h)$	$\frac{1}{4}$	$O(h^4)$
	$(0, 0)$ $(\pm h, 0), (0, \pm h)$ $(\pm \frac{1}{2}h, \pm \frac{1}{2}h)$	$\frac{1}{6}$ $\frac{1}{24}$ $\frac{1}{6}$	$O(h^6)$
	$(0, 0)$ $(\pm \frac{1}{3}\sqrt{6}h, 0)$ $(\pm \frac{1}{6}\sqrt{6}h, \pm \frac{1}{2}\sqrt{2}h)$	$\frac{1}{4}$ $\frac{1}{8}$ $\frac{1}{8}$	$O(h^6)$
	$(0, 0)$ $(\pm h, 0), (0, \pm h)$ $(\pm h, \pm h)$	$\frac{4}{9}$ $\frac{1}{9}$ $\frac{1}{36}$	$O(h^4)$
	$(\pm \frac{1}{3}\sqrt{3}h, \pm \frac{1}{3}\sqrt{3}h)$	$\frac{1}{4}$	$O(h^4)$
	$(0, 0)$ $(\pm \sqrt{\frac{3}{5}}h, 0), (0, \pm \sqrt{\frac{3}{5}}h)$ $(\pm \sqrt{\frac{3}{5}}h, 0), (\pm \sqrt{\frac{3}{5}}h, 0)$	$\frac{16}{81}$ $\frac{10}{81}$ $\frac{25}{324}$	$O(h^6)$

### 3.6 Linear Difference Equations

#### 3.6(i) Introduction

Many special functions satisfy second-order recurrence relations, or difference equations, of the form

$$3.6.1 \quad a_n w_{n+1} - b_n w_n + c_n w_{n-1} = d_n,$$

or equivalently,

$$3.6.2 \quad a_n \Delta^2 w_{n-1} + (2a_n - b_n) \Delta w_{n-1} + (a_n - b_n + c_n) w_{n-1} = d_n,$$

where  $\Delta w_{n-1} = w_n - w_{n-1}$ ,  $\Delta^2 w_{n-1} = \Delta w_n - \Delta w_{n-1}$ , and  $n \in \mathbb{Z}$ . If  $d_n = 0, \forall n$ , then the difference equation is *homogeneous*; otherwise it is *inhomogeneous*.

Difference equations are simple and attractive for computation. In practice, however, problems of severe instability often arise and in §§3.6(ii)–3.6(vii) we show how these difficulties may be overcome.

#### 3.6(ii) Homogeneous Equations

Given numerical values of  $w_0$  and  $w_1$ , the solution  $w_n$  of the equation

$$3.6.3 \quad a_n w_{n+1} - b_n w_n + c_n w_{n-1} = 0,$$

with  $a_n \neq 0, \forall n$ , can be computed recursively for  $n = 2, 3, \dots$ . Unless exact arithmetic is being used, however, each step of the calculation introduces rounding errors. These errors have the effect of perturbing the solution by unwanted small multiples of  $w_n$  and of an independent solution  $g_n$ , say. This is of little consequence if the wanted solution is growing in magnitude at least as fast as any other solution of (3.6.3), and the recursion process is *stable*.

But suppose that  $w_n$  is a nontrivial solution such that

$$3.6.4 \quad w_n/g_n \rightarrow 0, \quad n \rightarrow \infty.$$

Then  $w_n$  is said to be a *recessive* (equivalently, *minimal* or *distinguished*) solution as  $n \rightarrow \infty$ , and it is unique except for a constant factor. In this situation the unwanted multiples of  $g_n$  grow more rapidly than the wanted solution, and the computations are *unstable*. Stability can be restored, however, by *backward recursion*, provided that  $c_n \neq 0, \forall n$ : starting from  $w_N$  and  $w_{N+1}$ , with  $N$  large, equation (3.6.3) is applied to generate in succession  $w_{N-1}, w_{N-2}, \dots, w_0$ . The unwanted multiples of  $g_n$  now decay in comparison with  $w_n$ , hence are of little consequence.

The values of  $w_N$  and  $w_{N+1}$  needed to begin the backward recursion may be available, for example, from asymptotic expansions (§2.9). However, there are alternative procedures that do not require  $w_N$  and  $w_{N+1}$  to be known in advance. These are described in §§ 3.6(iii) and 3.6(v).

#### 3.6(iii) Miller's Algorithm

Because the recessive solution of a homogeneous equation is the fastest growing solution in the backward direction, it occurred to J.C.P. Miller (Bickley *et al.* (1952, pp. xvi–xvii)) that arbitrary “trial values” can be assigned to  $w_N$  and  $w_{N+1}$ , for example, 1 and 0. A “trial solution” is then computed by backward recursion, in

the course of which the original components of the unwanted solution  $g_n$  die away. It therefore remains to apply a normalizing factor  $\Lambda$ . The process is then repeated with a higher value of  $N$ , and the normalized solutions compared. If agreement is not within a prescribed tolerance the cycle is continued.

The normalizing factor  $\Lambda$  can be the true value of  $w_0$  divided by its trial value, or  $\Lambda$  can be chosen to satisfy a known property of the wanted solution of the form

**3.6.5** 
$$\sum_{n=0}^{\infty} \lambda_n w_n = 1,$$

where the  $\lambda$ 's are constants. The latter method is usually superior when the true value of  $w_0$  is zero or pathologically small.

For further information on Miller's algorithm, including examples, convergence proofs, and error analyses, see Wimp (1984, Chapter 4), Gautschi (1967, 1997a), and Olver (1964a). See also Gautschi (1967) and Gil *et al.* (2007a, Chapter 4) for the computation of recessive solutions via continued fractions.

**3.6(iv) Inhomogeneous Equations**

Similar principles apply to equation (3.6.1) when  $a_n c_n \neq 0, \forall n$ , and  $d_n \neq 0$  for some, or all, values of

$n$ . If, as  $n \rightarrow \infty$ , the wanted solution  $w_n$  grows (decays) in magnitude at least as fast as any solution of the corresponding homogeneous equation, then forward (backward) recursion is stable.

A new problem arises, however, if, as  $n \rightarrow \infty$ , the asymptotic behavior of  $w_n$  is intermediate to those of two independent solutions  $f_n$  and  $g_n$  of the corresponding inhomogeneous equation (the complementary functions). More precisely, assume that  $f_0 \neq 0, g_n \neq 0$  for all sufficiently large  $n$ , and as  $n \rightarrow \infty$

**3.6.6** 
$$f_n/g_n \rightarrow 0, \quad w_n/g_n \rightarrow 0.$$

Then computation of  $w_n$  by forward recursion is unstable. If it also happens that  $f_n/w_n \rightarrow 0$  as  $n \rightarrow \infty$ , then computation of  $w_n$  by backward recursion is unstable as well. However,  $w_n$  can be computed successfully in these circumstances by *boundary-value methods*, as follows.

Let us assume the normalizing condition is of the form  $w_0 = \lambda$ , where  $\lambda$  is a constant, and then solve the following tridiagonal system of algebraic equations for the unknowns  $w_1^{(N)}, w_2^{(N)}, \dots, w_{N-1}^{(N)}$ ; see §3.2(ii). Here  $N$  is an arbitrary positive integer.

**3.6.7** 
$$\begin{bmatrix} -b_1 & a_1 & & & & & \\ c_2 & -b_2 & a_2 & & & & \\ & & \ddots & \ddots & \ddots & & \\ & & & c_{N-2} & -b_{N-2} & a_{N-2} & \\ 0 & & & & c_{N-1} & -b_{N-1} & \end{bmatrix} \begin{bmatrix} w_1^{(N)} \\ w_2^{(N)} \\ \vdots \\ w_{N-2}^{(N)} \\ w_{N-1}^{(N)} \end{bmatrix} = \begin{bmatrix} d_1 - c_1 \lambda \\ d_2 \\ \vdots \\ d_{N-2} \\ d_{N-1} \end{bmatrix}.$$

Then as  $N \rightarrow \infty$  with  $n$  fixed,  $w_n^{(N)} \rightarrow w_n$ .

**3.6(v) Olver's Algorithm**

To apply the method just described a succession of values can be prescribed for the arbitrary integer  $N$  and the results compared. However, a more powerful procedure combines the solution of the algebraic equations with the determination of the optimum value of  $N$ . It is applicable equally to the computation of the recessive solution of the homogeneous equation (3.6.3) or the computation of any solution  $w_n$  of the inhomogeneous equation (3.6.1) for which the conditions of §3.6(iv) are satisfied.

Suppose again that  $f_0 \neq 0, w_0$  is given, and we wish to calculate  $w_1, w_2, \dots, w_M$  to a prescribed relative accuracy  $\epsilon$  for a given value of  $M$ . We first compute, by forward recurrence, the solution  $p_n$  of the homogeneous equation (3.6.3) with initial values  $p_0 = 0, p_1 = 1$ . At the same time we construct a sequence  $e_n, n = 0, 1, \dots,$

defined by

**3.6.8** 
$$a_n e_n = c_n e_{n-1} - d_n p_n,$$

beginning with  $e_0 = w_0$ . (This part of the process is equivalent to forward elimination.) The computation is continued until a value  $N (\geq M)$  is reached for which

**3.6.9** 
$$\left| \frac{e_N}{p_N p_{N+1}} \right| \leq \epsilon \min_{1 \leq n \leq M} \left| \frac{e_n}{p_n p_{n+1}} \right|.$$

Then  $w_n$  is generated by backward recursion from

**3.6.10** 
$$p_{n+1} w_n = p_n w_{n+1} + e_n,$$

starting with  $w_N = 0$ . (This part of the process is back substitution.)

An example is included in the next subsection. For further information, including a more general form of normalizing condition, other examples, convergence proofs, and error analyses, see Olver (1967a), Olver and Sookne (1972), and Wimp (1984, Chapter 6).

### 3.6(vi) Examples

#### Example 1. Bessel Functions

The difference equation

**3.6.11**  $w_{n+1} - 2nw_n + w_{n-1} = 0, \quad n = 1, 2, \dots,$   
 is satisfied by  $J_n(1)$  and  $Y_n(1)$ , where  $J_n(x)$  and  $Y_n(x)$  are the Bessel functions of the first kind. For large  $n$ ,

**3.6.12** 
$$J_n(1) \sim \frac{1}{(2\pi n)^{1/2}} \left(\frac{e}{2n}\right)^n,$$

**3.6.13** 
$$Y_n(1) \sim \left(\frac{2}{\pi n}\right)^{1/2} \left(\frac{2n}{e}\right)^n,$$

(§10.19(i)). Thus  $Y_n(1)$  is dominant and can be computed by forward recursion, whereas  $J_n(1)$  is recessive and has to be computed by backward recursion. The backward recursion can be carried out using independently computed values of  $J_N(1)$  and  $J_{N+1}(1)$  or by use of Miller’s algorithm (§3.6(iii)) or Olver’s algorithm (§3.6(v)).

#### Example 2. Weber Function

The Weber function  $\mathbf{E}_n(1)$  satisfies

**3.6.14**  $w_{n+1} - 2nw_n + w_{n-1} = -(2/\pi)(1 - (-1)^n),$

for  $n = 1, 2, \dots$ , and as  $n \rightarrow \infty$

**3.6.15** 
$$\mathbf{E}_{2n}(1) \sim \frac{2}{(4n^2 - 1)\pi},$$

**3.6.16** 
$$\mathbf{E}_{2n+1}(1) \sim \frac{2}{(2n + 1)\pi};$$

see §11.11(ii). Thus the asymptotic behavior of the particular solution  $\mathbf{E}_n(1)$  is intermediate to those of the complementary functions  $J_n(1)$  and  $Y_n(1)$ ; moreover, the conditions for Olver’s algorithm are satisfied. We apply the algorithm to compute  $\mathbf{E}_n(1)$  to 8S for the range  $n = 1, 2, \dots, 10$ , beginning with the value  $\mathbf{E}_0(1) = -0.56865\ 663$  obtained from the Maclaurin series expansion (§11.10(iii)).

In the notation of §3.6(v) we have  $M = 10$  and  $\epsilon = \frac{1}{2} \times 10^{-8}$ . The least value of  $N$  that satisfies (3.6.9) is found to be 16. The results of the computations are displayed in Table 3.6.1. The values of  $w_n$  for  $n = 1, 2, \dots, 10$  are the wanted values of  $\mathbf{E}_n(1)$ . (It should be observed that for  $n > 10$ , however, the  $w_n$  are progressively poorer approximations to  $\mathbf{E}_n(1)$ : the underlined digits are in error.)

Table 3.6.1: Weber function  $w_n = \mathbf{E}_n(1)$  computed by Olver’s algorithm.

$n$	$p_n$	$e_n$	$e_n/(p_n p_{n+1})$	$w_n$
0	0.00000 000	-0.56865 663		-0.56865 663
1	0.10000 000×10 <sup>1</sup>	0.70458 291	0.35229 146	0.43816 243
2	0.20000 000×10 <sup>1</sup>	0.70458 291	0.50327 351×10 <sup>-1</sup>	0.17174 195
3	0.70000 000×10 <sup>1</sup>	0.96172 597×10 <sup>1</sup>	0.34347 356×10 <sup>-1</sup>	0.24880 538
4	0.40000 000×10 <sup>2</sup>	0.96172 597×10 <sup>1</sup>	0.76815 174×10 <sup>-3</sup>	0.47850 795×10 <sup>-1</sup>
5	0.31300 000×10 <sup>3</sup>	0.40814 124×10 <sup>3</sup>	0.42199 534×10 <sup>-3</sup>	0.13400 098
6	0.30900 000×10 <sup>4</sup>	0.40814 124×10 <sup>3</sup>	0.35924 754×10 <sup>-5</sup>	0.18919 443×10 <sup>-1</sup>
7	0.36767 000×10 <sup>5</sup>	0.47221 340×10 <sup>5</sup>	0.25102 029×10 <sup>-5</sup>	0.93032 343×10 <sup>-1</sup>
8	0.51164 800×10 <sup>6</sup>	0.47221 340×10 <sup>5</sup>	0.11324 804×10 <sup>-7</sup>	0.10293 811×10 <sup>-1</sup>
9	0.81496 010×10 <sup>7</sup>	0.10423 616×10 <sup>8</sup>	0.87496 485×10 <sup>-8</sup>	0.71668 638×10 <sup>-1</sup>
10	0.14618 117×10 <sup>9</sup>	0.10423 616×10 <sup>8</sup>	0.24457 824×10 <sup>-10</sup>	0.65021 292×10 <sup>-2</sup>
11	0.29154 738×10 <sup>10</sup>	0.37225 201×10 <sup>10</sup>	0.19952 026×10 <sup>-10</sup>	0.58373 946×10 <sup>-1</sup>
12	0.63994 242×10 <sup>11</sup>	0.37225 201×10 <sup>10</sup>	0.37946 279×10 <sup>-13</sup>	0.44851 387×10 <sup>-2</sup>
13	0.15329 463×10 <sup>13</sup>	0.19555 304×10 <sup>13</sup>	0.32057 909×10 <sup>-13</sup>	0.49269 383×10 <sup>-1</sup>
14	0.39792 611×10 <sup>14</sup>	0.19555 304×10 <sup>13</sup>	0.44167 174×10 <sup>-16</sup>	0.32792 861×10 <sup>-2</sup>
15	0.11126 602×10 <sup>16</sup>	0.14186 384×10 <sup>16</sup>	0.38242 250×10 <sup>-16</sup>	0.42550 628×10 <sup>-1</sup>
16	0.33340 012×10 <sup>17</sup>	0.14186 384×10 <sup>16</sup>	0.39924 861×10 <sup>-19</sup>	0.00000 000

### 3.6(vii) Linear Difference Equations of Other Orders

Similar considerations apply to the first-order equation

**3.6.17**  $a_n w_{n+1} - b_n w_n = d_n.$

Thus in the inhomogeneous case it may sometimes be necessary to recur backwards to achieve stability. For

analyses and examples see Gautschi (1997a).

For a difference equation of order  $k (\geq 3)$ ,

**3.6.18**  $a_{n,k} w_{n+k} + a_{n,k-1} w_{n+k-1} + \dots + a_{n,0} w_n = d_n,$   
 or for systems of  $k$  first-order inhomogeneous equations, boundary-value methods are the rule rather than the exception. Typically  $k - \ell$  conditions are prescribed at the beginning of the range, and  $\ell$  conditions at the end.



Here  $\ell \in [0, k]$ , and its actual value depends on the asymptotic behavior of the wanted solution in relation to those of the other solutions. Within this framework forward and backward recursion may be regarded as the special cases  $\ell = 0$  and  $\ell = k$ , respectively.

For further information see Wimp (1984, Chapters 7–8), Cash and Zahar (1994), and Lozier (1980).

## 3.7 Ordinary Differential Equations

### 3.7(i) Introduction

Consideration will be limited to *ordinary linear second-order differential equations*

$$3.7.1 \quad \frac{d^2 w}{dz^2} + f(z) \frac{dw}{dz} + g(z)w = h(z),$$

where  $f$ ,  $g$ , and  $h$  are analytic functions in a domain  $D \subset \mathbb{C}$ . If  $h = 0$  the differential equation is *homogeneous*, otherwise it is *inhomogeneous*. For applications to special functions  $f$ ,  $g$ , and  $h$  are often simple rational functions.

For general information on solutions of equation (3.7.1) see §1.13. For classification of singularities of (3.7.1) and expansions of solutions in the neighborhoods of singularities, see §2.7. For an introduction to numerical methods for ordinary differential equations, see Ascher and Petzold (1998), Hairer *et al.* (1993), and Iserles (1996).

### 3.7(ii) Taylor-Series Method: Initial-Value Problems

Assume that we wish to integrate (3.7.1) along a finite path  $\mathcal{P}$  from  $z = a$  to  $z = b$  in a domain  $D$ . The path is partitioned at  $P + 1$  points labeled successively  $z_0, z_1, \dots, z_P$ , with  $z_0 = a$ ,  $z_P = b$ .

By repeated differentiation of (3.7.1) all derivatives of  $w(z)$  can be expressed in terms of  $w(z)$  and  $w'(z)$  as follows. Write

$$3.7.2 \quad w^{(s)}(z) = f_s(z)w(z) + g_s(z)w'(z) + h_s(z), \quad s = 0, 1, 2, \dots,$$

with

$$3.7.3 \quad \begin{aligned} f_0(z) &= 1, & g_0(z) &= 0, & h_0(z) &= 0, \\ f_1(z) &= 0, & g_1(z) &= 1, & h_1(z) &= 0. \end{aligned}$$

Then for  $s = 2, 3, \dots$ ,

$$3.7.4 \quad \begin{aligned} f_s(z) &= f'_{s-1}(z) - g(z)g_{s-1}(z), \\ g_s(z) &= f_{s-1}(z) - f(z)g_{s-1}(z) + g'_{s-1}(z), \\ h_s(z) &= h(z)g_{s-1}(z) + h'_{s-1}(z). \end{aligned}$$

Write  $\tau_j = z_{j+1} - z_j$ ,  $j = 0, 1, \dots, P$ , expand  $w(z)$  and  $w'(z)$  in Taylor series (§1.10(i)) centered at  $z = z_j$ , and apply (3.7.2). Then

$$3.7.5 \quad \begin{bmatrix} w(z_{j+1}) \\ w'(z_{j+1}) \end{bmatrix} = \mathbf{A}(\tau_j, z_j) \begin{bmatrix} w(z_j) \\ w'(z_j) \end{bmatrix} + \mathbf{b}(\tau_j, z_j),$$

where  $\mathbf{A}(\tau, z)$  is the matrix

$$3.7.6 \quad \mathbf{A}(\tau, z) = \begin{bmatrix} A_{11}(\tau, z) & A_{12}(\tau, z) \\ A_{21}(\tau, z) & A_{22}(\tau, z) \end{bmatrix},$$

and  $\mathbf{b}(\tau, z)$  is the vector

$$3.7.7 \quad \mathbf{b}(\tau, z) = \begin{bmatrix} b_1(\tau, z) \\ b_2(\tau, z) \end{bmatrix},$$

with

$$3.7.8 \quad \begin{aligned} A_{11}(\tau, z) &= \sum_{s=0}^{\infty} \frac{\tau^s}{s!} f_s(z), \\ A_{12}(\tau, z) &= \sum_{s=0}^{\infty} \frac{\tau^s}{s!} g_s(z), \\ A_{21}(\tau, z) &= \sum_{s=0}^{\infty} \frac{\tau^s}{s!} f_{s+1}(z), \\ A_{22}(\tau, z) &= \sum_{s=0}^{\infty} \frac{\tau^s}{s!} g_{s+1}(z), \end{aligned}$$

$$3.7.9 \quad b_1(\tau, z) = \sum_{s=0}^{\infty} \frac{\tau^s}{s!} h_s(z), \quad b_2(\tau, z) = \sum_{s=0}^{\infty} \frac{\tau^s}{s!} h_{s+1}(z).$$

If the solution  $w(z)$  that we are seeking grows in magnitude at least as fast as all other solutions of (3.7.1) as we pass along  $\mathcal{P}$  from  $a$  to  $b$ , then  $w(z)$  and  $w'(z)$  may be computed in a stable manner for  $z = z_0, z_1, \dots, z_P$  by successive application of (3.7.5) for  $j = 0, 1, \dots, P - 1$ , beginning with initial values  $w(a)$  and  $w'(a)$ .

Similarly, if  $w(z)$  is decaying at least as fast as all other solutions along  $\mathcal{P}$ , then we may reverse the labeling of the  $z_j$  along  $\mathcal{P}$  and begin with initial values  $w(b)$  and  $w'(b)$ .

### 3.7(iii) Taylor-Series Method: Boundary-Value Problems

Now suppose the path  $\mathcal{P}$  is such that the rate of growth of  $w(z)$  along  $\mathcal{P}$  is intermediate to that of two other solutions. (This can happen only for inhomogeneous equations.) Then to compute  $w(z)$  in a stable manner we solve the set of equations (3.7.5) simultaneously for  $j = 0, 1, \dots, P$ , as follows. Let  $\mathbf{A}$  be the  $(2P) \times (2P + 2)$  band matrix

$$3.7.10 \quad \mathbf{A} = \begin{bmatrix} -\mathbf{A}(\tau_0, z_0) & \mathbf{I} & \mathbf{0} & \cdots & \mathbf{0} & \mathbf{0} \\ \mathbf{0} & -\mathbf{A}(\tau_1, z_1) & \mathbf{I} & \cdots & \mathbf{0} & \mathbf{0} \\ \vdots & \vdots & \ddots & \ddots & \vdots & \vdots \\ \mathbf{0} & \mathbf{0} & \cdots & -\mathbf{A}(\tau_{P-2}, z_{P-2}) & \mathbf{I} & \mathbf{0} \\ \mathbf{0} & \mathbf{0} & \cdots & \mathbf{0} & -\mathbf{A}(\tau_{P-1}, z_{P-1}) & \mathbf{I} \end{bmatrix}$$

( $\mathbf{I}$  and  $\mathbf{0}$  being the identity and zero matrices of order  $2 \times 2$ .) Also let  $\mathbf{w}$  denote the  $(2P + 2) \times 1$  vector

$$3.7.11 \quad \mathbf{w} = [w(z_0), w'(z_0), w(z_1), w'(z_1), \dots, w(z_P), w'(z_P)]^T,$$

and  $\mathbf{b}$  the  $(2P) \times 1$  vector

$$3.7.12 \quad \mathbf{b} = [b_1(\tau_0, z_0), b_2(\tau_0, z_0), b_1(\tau_1, z_1), b_2(\tau_1, z_1), \dots, b_1(\tau_{P-1}, z_{P-1}), b_2(\tau_{P-1}, z_{P-1})]^T.$$

Then

$$3.7.13 \quad \mathbf{A}\mathbf{w} = \mathbf{b}.$$

This is a set of  $2P$  equations for the  $2P + 2$  unknowns,  $w(z_j)$  and  $w'(z_j)$ ,  $j = 0, 1, \dots, P$ . The remaining two equations are supplied by boundary conditions of the form

$$3.7.14 \quad \begin{aligned} \alpha_0 w(z_0) + \beta_0 w'(z_0) &= \gamma_0, \\ \alpha_1 w(z_P) + \beta_1 w'(z_P) &= \gamma_1, \end{aligned}$$

where the  $\alpha$ 's,  $\beta$ 's, and  $\gamma$ 's are constants.

If, for example,  $\beta_0 = \beta_1 = 0$ , then on moving the contributions of  $w(z_0)$  and  $w(z_P)$  to the right-hand side of (3.7.13) the resulting system of equations is not tridiagonal, but can readily be made tridiagonal by annihilating the elements of  $\mathbf{A}$  that lie below the main diagonal and its two adjacent diagonals. The equations can then be solved by the method of §3.2(ii), if the differential equation is homogeneous, or by Olver's algorithm (§3.6(v)). The latter is especially useful if the endpoint  $b$  of  $\mathcal{P}$  is at  $\infty$ , or if the differential equation is inhomogeneous.

It will be observed that the present formulation of the Taylor-series method permits considerable parallelism in the computation, both for initial-value and boundary-value problems.

For further information and examples, see Olde Daalhuis and Olver (1998, §7) and Lozier and Olver (1993). General methods for boundary-value problems for ordinary differential equations are given in Ascher *et al.* (1995).

### 3.7(iv) Sturm–Liouville Eigenvalue Problems

Let  $(a, b)$  be a finite or infinite interval and  $q(x)$  be a real-valued continuous (or piecewise continuous) function on the closure of  $(a, b)$ . The *Sturm–Liouville eigenvalue problem* is the construction of a nontrivial solution

of the system

$$3.7.15 \quad \frac{d^2 w_k}{dx^2} + (\lambda_k - q(x))w_k = 0,$$

$$3.7.16 \quad w_k(a) = w_k(b) = 0,$$

with limits taken in (3.7.16) when  $a$  or  $b$ , or both, are infinite. The values  $\lambda_k$  are the *eigenvalues* and the corresponding solutions  $w_k$  of the differential equation are the *eigenfunctions*. The eigenvalues  $\lambda_k$  are simple, that is, there is only one corresponding eigenfunction (apart from a normalization factor), and when ordered increasingly the eigenvalues satisfy

$$3.7.17 \quad \lambda_1 < \lambda_2 < \lambda_3 < \cdots, \quad \lim_{k \rightarrow \infty} \lambda_k = \infty.$$

If  $q(x)$  is  $C^\infty$  on the closure of  $(a, b)$ , then the discretized form (3.7.13) of the differential equation can be used. This converts the problem into a tridiagonal matrix problem in which the elements of the matrix are polynomials in  $\lambda$ ; compare §3.2(vi). The larger the absolute values of the eigenvalues  $\lambda_k$  that are being sought, the smaller the integration steps  $|\tau_j|$  need to be.

For further information, including other methods and examples, see Pryce (1993, §2.5.1).

### 3.7(v) Runge–Kutta Method

The Runge–Kutta method applies to linear or nonlinear differential equations. The method consists of a set of rules each of which is equivalent to a truncated Taylor-series expansion, but the rules avoid the need for analytic differentiations of the differential equation.

#### First-Order Equations

For  $w' = f(z, w)$  the standard fourth-order rule reads

$$3.7.18 \quad w_{n+1} = w_n + \frac{1}{6}(k_1 + 2k_2 + 2k_3 + k_4) + O(h^5),$$

where  $h = z_{n+1} - z_n$  and

$$\begin{aligned} k_1 &= hf(z_n, w_n), \\ k_2 &= hf(z_n + \frac{1}{2}h, w_n + \frac{1}{2}k_1), \\ k_3 &= hf(z_n + \frac{1}{2}h, w_n + \frac{1}{2}k_2), \\ k_4 &= hf(z_n + h, w_n + k_3). \end{aligned}$$

The order estimate  $O(h^5)$  holds if the solution  $w(z)$  has five continuous derivatives.

### Second-Order Equations

For  $w'' = f(z, w, w')$  the standard fourth-order rule reads

$$\begin{aligned} w_{n+1} &= w_n + \frac{1}{6}h(6w'_n + k_1 + k_2 + k_3) + O(h^5), \\ w'_{n+1} &= w'_n + \frac{1}{6}h(k_1 + 2k_2 + 2k_3 + k_4) + O(h^5), \end{aligned}$$

where

$$\begin{aligned} k_1 &= hf(z_n, w_n, w'_n), \\ k_2 &= hf(z_n + \frac{1}{2}h, w_n + \frac{1}{2}hw'_n + \frac{1}{8}hk_1, w'_n + \frac{1}{2}k_1), \\ k_3 &= hf(z_n + \frac{1}{2}h, w_n + \frac{1}{2}hw'_n + \frac{1}{8}hk_2, w'_n + \frac{1}{2}k_2), \\ k_4 &= hf(z_n + h, w_n + hw'_n + \frac{1}{2}hk_3, w'_n + k_3). \end{aligned}$$

The order estimates  $O(h^5)$  hold if the solution  $w(z)$  has five continuous derivatives.

An extensive literature exists on the numerical solution of ordinary differential equations by Runge–Kutta, multistep, or other methods. See, for example, Butcher (1987), Dekker and Verwer (1984, Chapter 3), Hairer *et al.* (1993, Chapter 2), and Hairer and Wanner (1996, Chapter 4).

## 3.8 Nonlinear Equations

### 3.8(i) Introduction

The equation to be solved is

$$f(z) = 0,$$

where  $z$  is a real or complex variable and the function  $f$  is nonlinear. Solutions are called *roots* of the equation, or *zeros* of  $f$ . If  $f(z_0) = 0$  and  $f'(z_0) \neq 0$ , then  $z_0$  is a *simple zero* of  $f$ . If  $f(z_0) = f'(z_0) = \dots = f^{(m-1)}(z_0) = 0$  and  $f^{(m)}(z_0) \neq 0$ , then  $z_0$  is a zero of  $f$  of *multiplicity*  $m$ ; compare §1.10(i).

Sometimes the equation takes the form

$$z = \phi(z),$$

and the solutions are called *fixed points* of  $\phi$ .

Equations (3.8.1) and (3.8.2) are usually solved by iterative methods. Let  $z_1, z_2, \dots$  be a sequence of approximations to a root, or fixed point,  $\zeta$ . If

$$|z_{n+1} - \zeta| < A|z_n - \zeta|^p$$

for all  $n$  sufficiently large, where  $A$  and  $p$  are independent of  $n$ , then the sequence is said to have *convergence*

of the  $p$ th order. (More precisely,  $p$  is the largest of the possible set of indices for (3.8.3).) If  $p = 1$  and  $A < 1$ , then the convergence is said to be *linear* or *geometric*. If  $p = 2$ , then the convergence is *quadratic*; if  $p = 3$ , then the convergence is *cubic*, and so on.

An iterative method converges *locally* to a solution  $\zeta$  if there exists a neighborhood  $N$  of  $\zeta$  such that  $z_n \rightarrow \zeta$  whenever the initial approximation  $z_0$  lies within  $N$ .

### 3.8(ii) Newton's Rule

This is an iterative method for real twice-continuously differentiable, or complex analytic, functions:

$$z_{n+1} = z_n - \frac{f(z_n)}{f'(z_n)}, \quad n = 0, 1, \dots$$

If  $\zeta$  is a simple zero, then the iteration converges locally and quadratically. For multiple zeros the convergence is linear, but if the multiplicity  $m$  is known then quadratic convergence can be restored by multiplying the ratio  $f(z_n)/f'(z_n)$  in (3.8.4) by  $m$ .

For real functions  $f(x)$  the sequence of approximations to a real zero  $\xi$  will always converge (and converge quadratically) if either:

- $f(x_0)f''(x_0) > 0$  and  $f'(x)$ ,  $f''(x)$  do not change sign between  $x_0$  and  $\xi$  (monotonic convergence).
- $f(x_0)f''(x_0) < 0$ ,  $f'(x)$ ,  $f''(x)$  do not change sign in the interval  $(x_0, x_1)$ , and  $\xi \in [x_0, x_1]$  (monotonic convergence after the first iteration).

#### Example

$f(x) = x - \tan x$ . The first positive zero of  $f(x)$  lies in the interval  $(\pi, \frac{3}{2}\pi)$ ; see Figure 4.15.3. From this graph we estimate an initial value  $x_0 = 4.65$ . Newton's rule is given by

$$x_{n+1} = \phi(x_n), \quad \phi(x) = x + x \cot^2 x - \cot x.$$

Results appear in Table 3.8.1. The choice of  $x_0$  here is critical. When  $x_0 \leq 4.2875$  or  $x_0 \geq 4.7125$ , Newton's rule does not converge to the required zero. The convergence is faster when we use instead the function  $f(x) = x \cos x - \sin x$ ; in addition, the successful interval for the starting value  $x_0$  is larger.

Table 3.8.1: Newton's rule for  $x - \tan x = 0$ .

$n$	$x_n$
0	4.65000 00000 000
1	4.60567 66065 900
2	4.55140 53475 751
3	4.50903 76975 617
4	4.49455 61600 185
5	4.49341 56569 391
6	4.49340 94580 903
7	4.49340 94579 091
8	4.49340 94579 091

### 3.8(iii) Other Methods

#### Bisection Method

If  $f(a)f(b) < 0$  with  $a < b$ , then the interval  $[a, b]$  contains one or more zeros of  $f$ . Bisection of this interval is used to decide where at least one zero is located. All zeros of  $f$  in the original interval  $[a, b]$  can be computed to any predetermined accuracy. Convergence is slow however; see Kaufman and Lenker (1986) and Nievergelt (1995).

#### Regula Falsi

Let  $x_0$  and  $x_1$  be such that  $f_0 = f(x_0)$  and  $f_1 = f(x_1)$  have opposite signs. Inverse linear interpolation (§3.3(v)) is used to obtain the first approximation:

$$3.8.6 \quad x_2 = x_1 - \frac{x_1 - x_0}{f_1 - f_0} f_1 = \frac{f_1 x_0 - f_0 x_1}{f_1 - f_0}.$$

We continue with  $x_2$  and either  $x_0$  or  $x_1$ , depending which of  $f_0$  and  $f_1$  is of opposite sign to  $f(x_2)$ , and so on. The convergence is linear, and again more than one zero may occur in the original interval  $[x_0, x_1]$ .

#### Secant Method

Whether or not  $f_0$  and  $f_1$  have opposite signs,  $x_2$  is computed as in (3.8.6). If the wanted zero  $\xi$  is simple, then the method converges locally with order of convergence  $p = \frac{1}{2}(1 + \sqrt{5}) = 1.618\dots$ . Because the method requires only one function evaluation per iteration, its numerical efficiency is ultimately higher than that of Newton's method. There is no guaranteed convergence: the first approximation  $x_2$  may be outside  $[x_0, x_1]$ .

#### Steffensen's Method

This iterative method for solving  $z = \phi(z)$  is given by

$$3.8.7 \quad z_{n+1} = z_n - \frac{(\phi(z_n) - z_n)^2}{\phi(\phi(z_n)) - 2\phi(z_n) + z_n}, \quad n = 0, 1, 2, \dots$$

It converges locally and quadratically for both  $\mathbb{R}$  and  $\mathbb{C}$ .

For other efficient derivative-free methods, see Le (1985).

#### Eigenvalue Methods

For the computation of zeros of orthogonal polynomials as eigenvalues of finite tridiagonal matrices (§3.5(vi)), see Gil *et al.* (2007a, pp. 205–207). For the computation of zeros of Bessel functions, Coulomb functions, and conical functions as eigenvalues of finite parts of infinite tridiagonal matrices, see Grad and Zakrajšek (1973), Ikebe (1975), Ikebe *et al.* (1991), Ball (2000), and Gil *et al.* (2007a, pp. 205–213).

### 3.8(iv) Zeros of Polynomials

The polynomial

$$3.8.8 \quad p(z) = a_n z^n + a_{n-1} z^{n-1} + \dots + a_0, \quad a_n \neq 0,$$

has  $n$  zeros in  $\mathbb{C}$ , counting each zero according to its multiplicity. Explicit formulas for the zeros are available if  $n \leq 4$ ; see §§1.11(iii) and 4.43. No explicit general formulas exist when  $n \geq 5$ .

After a zero  $\zeta$  has been computed, the factor  $z - \zeta$  is factored out of  $p(z)$  as a by-product of Horner's scheme (§1.11(i)) for the computation of  $p(\zeta)$ . In this way polynomials of successively lower degree can be used to find the remaining zeros. (This process is called *deflation*.) However, to guard against the accumulation of rounding errors, a final iteration for each zero should also be performed on the original polynomial  $p(z)$ .

#### Example

$p(z) = z^4 - 1$ . The zeros are  $\pm 1$  and  $\pm i$ . Newton's method is given by

$$3.8.9 \quad z_{n+1} = \phi(z_n), \quad \phi(z) = \frac{3z^4 + 1}{4z^3}.$$

The results for  $z_0 = 1.5$  are given in Table 3.8.2.

Table 3.8.2: Newton's rule for  $z^4 - 1 = 0$ .

$n$	$z_n$
0	1.50000 00000 000
1	1.19907 40740 741
2	1.04431 68969 414
3	1.00274 20038 676
4	1.00001 12265 490
5	1.00000 00001 891
6	1.00000 00000 000

As in the case of Table 3.8.1 the quadratic nature of convergence is clearly evident: as the zero is approached, the number of correct decimal places doubles at each iteration.

Newton's rule can also be used for complex zeros of  $p(z)$ . However, when the coefficients are all real, complex arithmetic can be avoided by the following iterative process.

#### Bairstow's Method

Let  $z^2 - sz - t$  be an approximation to the real quadratic factor of  $p(z)$  that corresponds to a pair of conjugate complex zeros or to a pair of real zeros. We construct sequences  $q_j$  and  $r_j$ ,  $j = n + 1, n, \dots, 0$ , from  $q_{n+1} = r_{n+1} = 0$ ,  $q_n = r_n = a_n$ , and for  $j \leq n - 1$ ,

$$3.8.10 \quad q_j = a_j + s q_{j+1} + t q_{j+2}, \quad r_j = q_j + s r_{j+1} + t r_{j+2}.$$

Then the next approximation to the quadratic factor is  $z^2 - (s + \Delta s)z - (t + \Delta t)$ , where

$$3.8.11 \quad \Delta s = \frac{r_3 q_0 - r_2 q_1}{r_2^2 - l r_3}, \quad \Delta t = \frac{\ell q_1 - r_2 q_0}{r_2^2 - l r_3}, \quad \ell = s r_2 + t r_3.$$

The method converges locally and quadratically, except when the wanted quadratic factor is a multiple factor of  $q(z)$ . On the last iteration  $q_n z^{n-2} + q_{n-1} z^{n-3} + \dots + q_2$  is the quotient on dividing  $p(z)$  by  $z^2 - sz - t$ .

#### Example

$p(z) = z^4 - 2z^2 + 1$ . With the starting values  $s_0 = \frac{7}{4}$ ,  $t_0 = -\frac{1}{2}$ , an approximation to the quadratic factor  $z^2 - 2z + 1 = (z - 1)^2$  is computed ( $s = 2$ ,  $t = -1$ ). Table 3.8.3 gives the successive values of  $s$  and  $t$ . The quadratic nature of the convergence is evident.

Table 3.8.3: Bairstow's method for factoring  $z^4 - 2z^2 + 1$ .

$n$	$s_n$	$t_n$
0	1.75000 00000 000	-0.50000 00000 000
1	2.13527 29454 109	-1.21235 75284 943
2	2.01786 10488 956	-1.02528 61401 539
3	2.00036 06329 466	-1.00047 63067 522
4	2.00000 01474 803	-1.00000 01858 298
5	2.00000 00000 000	-1.00000 00000 000

This example illustrates the fact that the method succeeds even if the two zeros of the wanted quadratic factor are real and the same.

For further information on the computation of zeros of polynomials see McNamee (2007).

### 3.8(v) Zeros of Analytic Functions

Newton's rule is the most frequently used iterative process for accurate computation of real or complex zeros of analytic functions  $f(z)$ . Another iterative method is *Halley's rule*:

$$3.8.12 \quad z_{n+1} = z_n - \frac{f(z_n)}{f'(z_n) - (f''(z_n)f(z_n)/(2f'(z_n)))}.$$

This is useful when  $f(z)$  satisfies a second-order linear differential equation because of the ease of computing  $f''(z_n)$ . The rule converges locally and is cubically convergent.

Initial approximations to the zeros can often be found from asymptotic or other approximations to  $f(z)$ , or by application of the phase principle or Rouché's theorem; see §1.10(iv). These results are also useful in ensuring that no zeros are overlooked when the complex plane is being searched.

For an example involving the Airy functions, see Fabijonas and Olver (1999).

For fixed-point methods for computing zeros of special functions, see Segura (2002), Gil and Segura (2003), and Gil *et al.* (2007a, Chapter 7).

### 3.8(vi) Conditioning of Zeros

Suppose  $f(z)$  also depends on a parameter  $\alpha$ , denoted by  $f(z, \alpha)$ . Then the sensitivity of a simple zero  $z$  to changes in  $\alpha$  is given by

$$3.8.13 \quad \frac{dz}{d\alpha} = -\frac{\partial f}{\partial \alpha} / \frac{\partial f}{\partial z}.$$

Thus if  $f$  is the polynomial (3.8.8) and  $\alpha$  is the coefficient  $a_j$ , say, then

$$3.8.14 \quad \frac{dz}{da_j} = -\frac{z^j}{f'(z)}.$$

For moderate or large values of  $n$  it is not uncommon for the magnitude of the right-hand side of (3.8.14) to be very large compared with unity, signifying that the computation of zeros of polynomials is often an ill-posed problem.

#### Example. Wilkinson's Polynomial

The zeros of

$$3.8.15 \quad p(x) = (x - 1)(x - 2) \cdots (x - 20)$$

are well separated but extremely ill-conditioned. Consider  $x = 20$  and  $j = 19$ . We have  $p'(20) = 19!$  and  $a_{19} = 1 + 2 + \dots + 20 = 210$ . The perturbation factor (3.8.14) is given by

$$3.8.16 \quad \frac{dx}{da_{19}} = -\frac{20^{19}}{19!} = (-4.30 \dots) \times 10^7.$$

Corresponding numerical factors in this example for other zeros and other values of  $j$  are obtained in Gautschi (1984, §4).

### 3.8(vii) Systems of Nonlinear Equations

For fixed-point iterations and Newton's method for solving systems of nonlinear equations, see Gautschi (1997b, Chapter 4, §9) and Ortega and Rheinboldt (1970).

### 3.8(viii) Fixed-Point Iterations: Fractals

The convergence of iterative methods

$$3.8.17 \quad z_{n+1} = \phi(z_n), \quad n = 0, 1, \dots,$$

for solving fixed-point problems (3.8.2) cannot always be predicted, especially in the complex plane.

Consider, for example, (3.8.9). Starting this iteration in the neighborhood of one of the four zeros  $\pm 1, \pm i$ , sequences  $\{z_n\}$  are generated that converge to these zeros. For an arbitrary starting point  $z_0 \in \mathbb{C}$ , convergence cannot be predicted, and the boundary of the set of points  $z_0$  that generate a sequence converging to a particular zero has a very complicated structure. It is called a *Julia set*. In general the Julia set of an analytic function  $f(z)$  is a *fractal*, that is, a set that is self-similar. See Julia (1918) and Devaney (1986).

### 3.9 Acceleration of Convergence

#### 3.9(i) Sequence Transformations

All sequences (series) in this section are sequences (series) of real or complex numbers.

A transformation of a convergent sequence  $\{s_n\}$  with limit  $\sigma$  into a sequence  $\{t_n\}$  is called *limit-preserving* if  $\{t_n\}$  converges to the same limit  $\sigma$ .

The transformation is *accelerating* if it is limit-preserving and if

$$3.9.1 \quad \lim_{n \rightarrow \infty} \frac{t_n - \sigma}{s_n - \sigma} = 0.$$

Similarly for convergent series if we regard the sum as the limit of the sequence of partial sums.

It should be borne in mind that a sequence (series) transformation can be effective for one type of sequence (series) but may not accelerate convergence for another type. It may even fail altogether by not being limit-preserving.

#### 3.9(ii) Euler's Transformation of Series

If  $S = \sum_{k=0}^{\infty} (-1)^k a_k$  is a convergent series, then

$$3.9.2 \quad S = \sum_{k=0}^{\infty} (-1)^k 2^{-k-1} \Delta^k a_0,$$

provided that the right-hand side converges. Here  $\Delta$  is the *forward difference operator*:

$$3.9.3 \quad \Delta^k a_0 = \Delta^{k-1} a_1 - \Delta^{k-1} a_0, \quad k = 1, 2, \dots$$

Thus

$$3.9.4 \quad \Delta^k a_0 = \sum_{m=0}^k (-1)^m \binom{k}{m} a_{k-m}.$$

Euler's transformation is usually applied to alternating series. Examples are provided by the following analytic transformations of slowly-convergent series into rapidly convergent ones:

#### 3.9.5

$$\ln 2 = 1 - \frac{1}{2} + \frac{1}{3} - \frac{1}{4} + \dots = \frac{1}{1 \cdot 2^1} + \frac{1}{2 \cdot 2^2} + \frac{1}{3 \cdot 2^3} + \dots,$$

$$\frac{\pi}{4} = 1 - \frac{1}{3} + \frac{1}{5} - \frac{1}{7} + \dots$$

$$3.9.6 \quad = \frac{1}{2} \left( 1 + \frac{1!}{1 \cdot 3} + \frac{2!}{3 \cdot 5} + \frac{3!}{3 \cdot 5 \cdot 7} + \dots \right).$$

#### 3.9(iii) Aitken's $\Delta^2$ -Process

$$3.9.7 \quad t_n = s_n - \frac{(\Delta s_n)^2}{\Delta^2 s_n} = s_n - \frac{(s_{n+1} - s_n)^2}{s_{n+2} - 2s_{n+1} + s_n}.$$

This transformation is accelerating if  $\{s_n\}$  is a *linearly convergent sequence*, i.e., a sequence for which

$$3.9.8 \quad \lim_{n \rightarrow \infty} \frac{s_{n+1} - \sigma}{s_n - \sigma} = \rho, \quad |\rho| < 1.$$

When applied repeatedly, Aitken's process is known as the *iterated  $\Delta^2$ -process*. See Brezinski and Redivo Zaglia (1991, pp. 39–42).

#### 3.9(iv) Shanks' Transformation

*Shanks' transformation* is a generalization of Aitken's  $\Delta^2$ -process. Let  $k$  be a fixed positive integer. Then the transformation of the sequence  $\{s_n\}$  into a sequence  $\{t_{n,2k}\}$  is given by

$$3.9.9 \quad t_{n,2k} = \frac{H_{k+1}(s_n)}{H_k(\Delta^2 s_n)}, \quad n = 0, 1, 2, \dots,$$

where  $H_m$  is the *Hankel determinant*

$$3.9.10 \quad H_m(u_n) = \begin{vmatrix} u_n & u_{n+1} & \cdots & u_{n+m-1} \\ u_{n+1} & u_{n+2} & \cdots & u_{n+m} \\ \vdots & \vdots & \ddots & \vdots \\ u_{n+m-1} & u_{n+m} & \cdots & u_{n+2m-2} \end{vmatrix}.$$

The ratio of the Hankel determinants in (3.9.9) can be computed recursively by *Wynn's epsilon algorithm*:

#### 3.9.11

$$\varepsilon_{-1}^{(n)} = 0, \quad \varepsilon_0^{(n)} = s_n, \quad n = 0, 1, 2, \dots,$$

$$\varepsilon_{m+1}^{(n)} = \varepsilon_{m-1}^{(n+1)} + \frac{1}{\varepsilon_m^{(n+1)} - \varepsilon_m^{(n)}}, \quad n, m = 0, 1, 2, \dots$$

Then  $t_{n,2k} = \varepsilon_{2k}^{(n)}$ . Aitken's  $\Delta^2$ -process is the case  $k = 1$ .

If  $s_n$  is the  $n$ th partial sum of a power series  $f$ , then  $t_{n,2k} = \varepsilon_{2k}^{(n)}$  is the Padé approximant  $[(n+k)/k]_f$  (§3.11(iv)).

For further information on the epsilon algorithm see Brezinski and Redivo Zaglia (1991, pp. 78–95).

#### Example

In Table 3.9.1 values of the transforms  $t_{n,2k}$  are supplied for

$$3.9.12 \quad s_n = \sum_{j=1}^n \frac{(-1)^{j+1}}{j^2},$$

with  $s_{\infty} = \frac{1}{12} \pi^2 = 0.82246\ 70334\ 24 \dots$

Table 3.9.1: Shanks' transformation for  $s_n = \sum_{j=1}^n (-1)^{j+1} j^{-2}$ .

$n$	$t_{n,2}$	$t_{n,4}$	$t_{n,6}$	$t_{n,8}$	$t_{n,10}$
0	0.80000 00000 00	0.82182 62806 24	0.82244 84501 47	0.82246 64909 60	0.82246 70175 41
1	0.82692 30769 23	0.82259 02017 65	0.82247 05346 57	0.82246 71342 06	0.82246 70363 45
2	0.82111 11111 11	0.82243 44785 14	0.82246 61821 45	0.82246 70102 48	0.82246 70327 79
3	0.82300 13550 14	0.82247 78118 35	0.82246 72851 83	0.82246 70397 56	0.82246 70335 90
4	0.82221 76684 88	0.82246 28314 41	0.82246 69467 93	0.82246 70314 36	0.82246 70333 75
5	0.82259 80392 16	0.82246 88857 22	0.82246 70670 21	0.82246 70341 24	0.82246 70334 40
6	0.82239 19390 77	0.82246 61352 37	0.82246 70190 76	0.82246 70331 54	0.82246 70334 18
7	0.82251 30483 23	0.82246 75033 13	0.82246 70400 56	0.82246 70335 37	0.82246 70334 26
8	0.82243 73137 33	0.82246 67719 32	0.82246 70301 49	0.82246 70333 73	0.82246 70334 23
9	0.82248 70624 89	0.82246 71865 91	0.82246 70351 34	0.82246 70334 48	0.82246 70334 24
10	0.82245 30535 15	0.82246 69397 57	0.82246 70324 88	0.82246 70334 12	0.82246 70334 24

**3.9(v) Levin's and Weniger's Transformations**

We give a special form of *Levin's transformation* in which the sequence  $s = \{s_n\}$  of partial sums  $s_n = \sum_{j=0}^n a_j$  is transformed into:

3.9.13

$$\mathcal{L}_k^{(n)}(s) = \frac{\sum_{j=0}^k (-1)^j \binom{k}{j} c_{j,k,n} s_{n+j} / a_{n+j+1}}{\sum_{j=0}^k (-1)^j \binom{k}{j} c_{j,k,n} / a_{n+j+1}},$$

where  $k$  is a fixed nonnegative integer, and

3.9.14 
$$c_{j,k,n} = \frac{(n+j+1)^{k-1}}{(n+k+1)^{k-1}}.$$

Sequences that are accelerated by Levin's transformation include *logarithmically convergent* sequences, i.e., sequences  $s_n$  converging to  $\sigma$  such that

3.9.15 
$$\lim_{n \rightarrow \infty} \frac{s_{n+1} - \sigma}{s_n - \sigma} = 1.$$

For further information see [Brezinski and Redivo Zaglia \(1991, pp. 39–42\)](#).

In *Weniger's transformations* the numbers  $c_{j,k,n}$  in (3.9.13) are chosen as follows:

3.9.16 
$$c_{j,k,n} = \frac{(\beta + n + j)_{k-1}}{(\beta + n + k)_{k-1}},$$

or

3.9.17 
$$c_{j,k,n} = \frac{(-\gamma - n - j)_{k-1}}{(-\gamma - n - k)_{k-1}},$$

where  $(a)_0 = 1$  and  $(a)_j = a(a+1)\cdots(a+j-1)$  are Pochhammer symbols (§5.2(iii)), and the constants  $\beta$  and  $\gamma$  are chosen arbitrarily subject to certain conditions. See [Weniger \(1989\)](#).

**3.9(vi) Applications and Further Transformations**

For examples and other transformations for convergent sequences and series, see [Wimp \(1981, pp. 156–199\)](#), [Brezinski and Redivo Zaglia \(1991, pp. 55–72\)](#), and [Sidi](#)

(2003, Chapters 6, 12–13, 15–16, 19–24, and pp. 483–492).

For applications to asymptotic expansions, see §2.11(vi), [Olver \(1997b, pp. 540–543\)](#), and [Weniger \(1989, 2003\)](#).

**3.10 Continued Fractions**

**3.10(i) Introduction**

See §1.12 for relevant properties of continued fractions, including the following definitions:

3.10.1 
$$C = b_0 + \frac{a_1}{b_1 +} \frac{a_2}{b_2 +} \cdots, \quad a_n \neq 0,$$

3.10.2 
$$C_n = b_0 + \frac{a_1}{b_1 +} \frac{a_2}{b_2 +} \cdots \frac{a_n}{b_n} = \frac{A_n}{B_n}.$$

$C_n$  is the  $n$ th *approximant* or *convergent* to  $C$ .

**3.10(ii) Relations to Power Series**

Every convergent, asymptotic, or formal series

3.10.3 
$$u_0 + u_1 + u_2 + \cdots$$

can be converted into a continued fraction  $C$  of type (3.10.1), and with the property that the  $n$ th convergent  $C_n = A_n/B_n$  to  $C$  is equal to the  $n$ th partial sum of the series in (3.10.3), that is,

3.10.4 
$$\frac{A_n}{B_n} = u_0 + u_1 + \cdots + u_n, \quad n = 0, 1, \dots$$

For instance, if none of the  $u_n$  vanish, then we can define

3.10.5 
$$b_0 = u_0, \quad b_1 = 1, \quad a_1 = u_1, \\ b_n = 1 + \frac{u_n}{u_{n-1}}, \quad a_n = -\frac{u_n}{u_{n-1}}, \quad n \geq 2.$$

However, other continued fractions with the same limit may converge in a much larger domain of the complex plane than the fraction given by (3.10.4) and (3.10.5). For example, by converting the Maclaurin

expansion of  $\arctan z$  (4.24.3), we obtain a continued fraction with the same region of convergence ( $|z| \leq 1$ ,  $z \neq \pm i$ ), whereas the continued fraction (4.25.4) converges for all  $z \in \mathbb{C}$  except on the branch cuts from  $i$  to  $i\infty$  and  $-i$  to  $-i\infty$ .

**Stieltjes Fractions**

A continued fraction of the form

3.10.6 
$$C = \frac{a_0}{1 -} \frac{a_1 z}{1 -} \frac{a_2 z^2}{1 -} \dots$$

is called a *Stieltjes fraction (S-fraction)*. We say that it corresponds to the formal power series

3.10.7 
$$f(z) = c_0 + c_1 z + c_2 z^2 + \dots$$

if the expansion of its  $n$ th convergent  $C_n$  in ascending powers of  $z$  agrees with (3.10.7) up to and including the term in  $z^{n-1}$ ,  $n = 1, 2, 3, \dots$

**Quotient-Difference Algorithm**

For several special functions the  $S$ -fractions are known explicitly, but in any case the coefficients  $a_n$  can always be calculated from the power-series coefficients by means of the *quotient-difference algorithm*; see Table 3.10.1.

Table 3.10.1: Quotient-difference scheme.

	$q_1^0$			
$e_0^1$	$e_1^0$			
	$q_1^1$	$q_2^0$		
$e_0^2$	$e_1^1$	$e_2^0$		
	$q_1^2$	$q_2^1$	$q_3^0$	
$e_0^3$	$e_1^2$	$e_2^1$	$e_3^0$	
	$q_1^3$	$q_2^2$	$q_3^1$	$\ddots$
$e_0^4$	$e_1^3$	$e_2^2$	$e_3^1$	
	$\ddots$	$\ddots$	$\ddots$	$\ddots$

The first two columns in this table are defined by

3.10.8 
$$\begin{aligned} e_0^n &= 0, & n &= 1, 2, \dots, \\ q_1^n &= c_{n+1}/c_n, & n &= 0, 1, \dots, \end{aligned}$$

where the  $c_n (\neq 0)$  appear in (3.10.7). We continue by means of the *rhombus rule*

3.10.9 
$$\begin{aligned} e_j^k &= e_{j-1}^{k+1} + q_j^{k+1} - q_j^k, & j &\geq 1, k \geq 0, \\ q_{j+1}^k &= q_j^{k+1} e_j^{k+1} / e_j^k, & j &\geq 1, k \geq 0. \end{aligned}$$

Then the coefficients  $a_n$  of the  $S$ -fraction (3.10.6) are given by

3.10.10 
$$a_0 = c_0, \quad a_1 = q_1^0, \quad a_2 = e_1^0, \quad a_3 = q_2^0, \quad a_4 = e_2^0, \quad \dots$$

The quotient-difference algorithm is frequently unstable and may require high-precision arithmetic or exact arithmetic. A more stable version of the algorithm is discussed in Stokes (1980). For applications to Bessel functions and Whittaker functions (Chapters 10 and 13), see Gargantini and Henrici (1967).

**Jacobi Fractions**

A continued fraction of the form

3.10.11 
$$C = \frac{\beta_0}{1 - \alpha_0 z -} \frac{\beta_1 z^2}{1 - \alpha_1 z -} \frac{\beta_2 z^2}{1 - \alpha_2 z -} \dots$$

is called a *Jacobi fraction (J-fraction)*. We say that it is associated with the formal power series  $f(z)$  in (3.10.7) if the expansion of its  $n$ th convergent  $C_n$  in ascending powers of  $z$ , agrees with (3.10.7) up to and including the term in  $z^{2n-1}$ ,  $n = 1, 2, 3, \dots$ . For the same function  $f(z)$ , the convergent  $C_n$  of the Jacobi fraction (3.10.11) equals the convergent  $C_{2n}$  of the Stieltjes fraction (3.10.6).

**Examples of S- and J-Fractions**

For elementary functions, see §§ 4.9 and 4.35.

For special functions see §5.10 (gamma function), §7.9 (error function), §8.9 (incomplete gamma functions), §8.17(v) (incomplete beta function), §8.19(vii) (generalized exponential integral), §§10.10 and 10.33 (quotients of Bessel functions), §13.6 (quotients of confluent hypergeometric functions), §13.19 (quotients of Whittaker functions), and §15.7 (quotients of hypergeometric functions).

For further information and examples see Lorentzen and Waadeland (1992, pp. 292–330, 560–599) and Cuyt *et al.* (2008).

**3.10(iii) Numerical Evaluation of Continued Fractions**

**Forward Recurrence Algorithm**

The  $A_n$  and  $B_n$  of (3.10.2) can be computed by means of three-term recurrence relations (1.12.5). However, this may be unstable; also overflow and underflow may occur when evaluating  $A_n$  and  $B_n$  (making it necessary to re-scale from time to time).

**Backward Recurrence Algorithm**

To compute the  $C_n$  of (3.10.2) we perform the iterated divisions

3.10.12 
$$u_n = b_n, \quad u_k = b_k + \frac{a_{k+1}}{u_{k+1}}, \quad k = n - 1, n - 2, \dots, 0.$$

Then  $u_0 = C_n$ . To achieve a prescribed accuracy, either *a priori* knowledge is needed of the value of  $n$ , or  $n$  is determined by trial and error. In general this algorithm is more stable than the forward algorithm; see Jones and Thron (1974).



### Forward Series Recurrence Algorithm

The continued fraction

$$3.10.13 \quad C = \frac{a_0}{1 - \frac{a_1}{1 - \frac{a_2}{\dots}}}$$

can be written in the form

$$3.10.14 \quad C = \sum_{k=0}^{\infty} t_k,$$

where

$$3.10.15 \quad \begin{aligned} t_0 &= a_0, & t_k &= \rho_k t_{k-1}, & \rho_0 &= 0, \\ \rho_k &= \frac{a_k(1 + \rho_{k-1})}{1 - a_k(1 + \rho_{k-1})}, & & & & k = 1, 2, 3, \dots \end{aligned}$$

The  $n$ th partial sum  $t_0 + t_1 + \dots + t_{n-1}$  equals the  $n$ th convergent of (3.10.13),  $n = 1, 2, 3, \dots$ . In contrast to the preceding algorithms in this subsection no scaling problems arise and no *a priori* information is needed.

In Gautschi (1979b) the forward series algorithm is used for the evaluation of a continued fraction of an incomplete gamma function (see §8.9).

### Steed's Algorithm

This forward algorithm achieves efficiency and stability in the computation of the convergents  $C_n = A_n/B_n$ , and is related to the forward series recurrence algorithm. Again, no scaling problems arise and no *a priori* information is needed.

Let

$$3.10.16 \quad \begin{aligned} C_0 &= b_0, & D_1 &= 1/b_1, & \nabla C_1 &= a_1 D_1, & C_1 &= C_0 + \nabla C_1. \end{aligned}$$

( $\nabla$  is the *backward difference operator*.) Then for  $n \geq 2$ ,

$$3.10.17 \quad \begin{aligned} D_n &= \frac{1}{D_{n-1} a_n + b_n}, \\ \nabla C_n &= (b_n D_n - 1) \nabla C_{n-1}, \\ C_n &= C_{n-1} + \nabla C_n. \end{aligned}$$

The recurrences are continued until  $(\nabla C_n)/C_n$  is within a prescribed relative precision.

For further information on the preceding algorithms, including convergence in the complex plane and methods for accelerating convergence, see Blanch (1964) and Lorentzen and Waadeland (1992, Chapter 3). For the evaluation of special functions by using continued fractions see Cuyt *et al.* (2008), Gautschi (1967, §1), Gil *et al.* (2007a, Chapter 6), and Wimp (1984, Chapter 4, §5). See also §§6.18(i), 7.22(i), 8.25(iv), 10.74(v), 14.32, 28.34(ii), 29.20(i), 30.16(i), 33.23(v).

## 3.11 Approximation Techniques

### 3.11(i) Minimax Polynomial Approximations

Let  $f(x)$  be continuous on a closed interval  $[a, b]$ . Then there exists a unique  $n$ th degree polynomial

$p_n(x)$ , called the *minimax* (or *best uniform*) polynomial approximation to  $f(x)$  on  $[a, b]$ , that minimizes  $\max_{a \leq x \leq b} |\epsilon_n(x)|$ , where  $\epsilon_n(x) = f(x) - p_n(x)$ .

A sufficient condition for  $p_n(x)$  to be the minimax polynomial is that  $|\epsilon_n(x)|$  attains its maximum at  $n+2$  distinct points in  $[a, b]$  and  $\epsilon_n(x)$  changes sign at these consecutive maxima.

If we have a sufficiently close approximation

$$3.11.1 \quad p_n(x) = a_n x^n + a_{n-1} x^{n-1} + \dots + a_0$$

to  $f(x)$ , then the coefficients  $a_k$  can be computed iteratively. Assume that  $f'(x)$  is continuous on  $[a, b]$  and let  $x_0 = a$ ,  $x_{n+1} = b$ , and  $x_1, x_2, \dots, x_n$  be the zeros of  $\epsilon'_n(x)$  in  $(a, b)$  arranged so that

$$3.11.2 \quad x_0 < x_1 < x_2 < \dots < x_n < x_{n+1}.$$

Also, let

$$3.11.3 \quad m_j = (-1)^j \epsilon_n(x_j), \quad j = 0, 1, \dots, n+1.$$

(Thus the  $m_j$  are approximations to  $m$ , where  $\pm m$  is the maximum value of  $|\epsilon_n(x)|$  on  $[a, b]$ .)

Then (in general) a better approximation to  $p_n(x)$  is given by

$$3.11.4 \quad \sum_{k=0}^n (a_k + \delta a_k) x^k,$$

where

$$3.11.5 \quad \sum_{k=0}^n x_j^k \delta a_k = (-1)^j (m_j - m), \quad j = 0, 1, \dots, n+1.$$

This is a set of  $n+2$  equations for the  $n+2$  unknowns  $\delta a_0, \delta a_1, \dots, \delta a_n$  and  $m$ .

The iterative process converges locally and quadratically (§3.8(i)).

A method for obtaining a sufficiently accurate first approximation is described in the next subsection.

For the theory of minimax approximations see Meinardus (1967). For examples of minimax polynomial approximations to elementary and special functions see Hart *et al.* (1968). See also Cody (1970) and Ralston (1965).

### 3.11(ii) Chebyshev-Series Expansions

The Chebyshev polynomials  $T_n$  are given by

$$3.11.6 \quad T_n(x) = \cos(n \arccos x), \quad -1 \leq x \leq 1.$$

They satisfy the recurrence relation

$$3.11.7 \quad T_{n+1}(x) - 2x T_n(x) + T_{n-1}(x) = 0, \quad n = 1, 2, \dots,$$

with initial values  $T_0(x) = 1$ ,  $T_1(x) = x$ . They enjoy an orthogonal property with respect to integrals:

$$3.11.8 \quad \int_{-1}^1 \frac{T_j(x) T_k(x)}{\sqrt{1-x^2}} dx = \begin{cases} \pi, & j = k = 0, \\ \frac{1}{2}\pi, & j = k \neq 0, \\ 0, & j \neq k, \end{cases}$$

as well as an orthogonal property with respect to sums, as follows. When  $n > 0$  and  $0 \leq j \leq n$ ,  $0 \leq k \leq n$ ,

$$3.11.9 \quad \sum_{\ell=0}^n{}'' T_j(x_\ell) T_k(x_\ell) = \begin{cases} n, & j = k = 0 \text{ or } n, \\ \frac{1}{2}n, & j = k \neq 0 \text{ or } n, \\ 0, & j \neq k, \end{cases}$$

where  $x_\ell = \cos(\pi\ell/n)$  and the double prime means that the first and last terms are to be halved.

For these and further properties of Chebyshev polynomials, see Chapter 18, Gil *et al.* (2007a, Chapter 3), and Mason and Handscomb (2003).

### Chebyshev Expansions

If  $f$  is continuously differentiable on  $[-1, 1]$ , then with

$$3.11.10 \quad c_n = \frac{2}{\pi} \int_0^\pi f(\cos \theta) \cos(n\theta) d\theta, \quad n = 0, 1, 2, \dots,$$

the expansion

$$3.11.11 \quad f(x) = \sum_{n=0}^{\infty}{}' c_n T_n(x), \quad -1 \leq x \leq 1,$$

converges uniformly. Here the single prime on the summation symbol means that the first term is to be halved. In fact, (3.11.11) is the Fourier-series expansion of  $f(\cos \theta)$ ; compare (3.11.6) and §1.8(i).

Furthermore, if  $f \in C^\infty[-1, 1]$ , then the convergence of (3.11.11) is usually very rapid; compare (1.8.7) with  $k$  arbitrary.

For general intervals  $[a, b]$  we rescale:

$$3.11.12 \quad f(x) = \sum_{n=0}^{\infty}{}' d_n T_n\left(\frac{2x - a - b}{b - a}\right).$$

Because the series (3.11.12) converges rapidly we obtain a very good first approximation to the minimax polynomial  $p_n(x)$  for  $[a, b]$  if we truncate (3.11.12) at its  $(n + 1)$ th term. This is because in the notation of §3.11(i)

$$3.11.13 \quad \epsilon_n(x) = d_{n+1} T_{n+1}\left(\frac{2x - a - b}{b - a}\right),$$

approximately, and the right-hand side enjoys exactly those properties concerning its maxima and minima that are required for the minimax approximation; compare Figure 18.4.3.

More precisely, it is known that for the interval  $[a, b]$ , the ratio of the maximum value of the remainder

$$3.11.14 \quad \left| \sum_{k=n+1}^{\infty} d_k T_k\left(\frac{2x - a - b}{b - a}\right) \right|$$

to the maximum error of the minimax polynomial  $p_n(x)$  is bounded by  $1 + L_n$ , where  $L_n$  is the  $n$ th Lebesgue constant for Fourier series; see §1.8(i). Since  $L_0 = 1$ ,  $L_n$  is a monotonically increasing function of  $n$ , and (for example)  $L_{1000} = 4.07\dots$ , this means that in practice the

gain in replacing a truncated Chebyshev-series expansion by the corresponding minimax polynomial approximation is hardly worthwhile. Moreover, the set of minimax approximations  $p_0(x), p_1(x), p_2(x), \dots, p_n(x)$  requires the calculation and storage of  $\frac{1}{2}(n + 1)(n + 2)$  coefficients, whereas the corresponding set of Chebyshev-series approximations requires only  $n + 1$  coefficients.

### Calculation of Chebyshev Coefficients

The  $c_n$  in (3.11.11) can be calculated from (3.11.10), but in general it is more efficient to make use of the orthogonal property (3.11.9). Also, in cases where  $f(x)$  satisfies a linear ordinary differential equation with polynomial coefficients, the expansion (3.11.11) can be substituted in the differential equation to yield a recurrence relation satisfied by the  $c_n$ .

For details and examples of these methods, see Clenshaw (1957, 1962) and Miller (1966). See also Mason and Handscomb (2003, Chapter 10) and Fox and Parker (1968, Chapter 5).

### Summation of Chebyshev Series: Clenshaw's Algorithm

For the expansion (3.11.11), numerical values of the Chebyshev polynomials  $T_n(x)$  can be generated by application of the recurrence relation (3.11.7). A more efficient procedure is as follows. Let  $c_n T_n(x)$  be the last term retained in the truncated series. Beginning with  $u_{n+1} = 0$ ,  $u_n = c_n$ , we apply

$$3.11.15 \quad u_k = 2xu_{k+1} - u_{k+2} + c_k, \quad k = n - 1, n - 2, \dots, 0.$$

Then the sum of the truncated expansion equals  $\frac{1}{2}(u_0 - u_2)$ . For error analysis and modifications of Clenshaw's algorithm, see Oliver (1977).

### Complex Variables

If  $x$  is replaced by a complex variable  $z$  and  $f(z)$  is analytic, then the expansion (3.11.11) converges within an ellipse. However, in general (3.11.11) affords no advantage in  $\mathbb{C}$  for numerical purposes compared with the Maclaurin expansion of  $f(z)$ .

For further details on Chebyshev-series expansions in the complex plane, see Mason and Handscomb (2003, §5.10).

### 3.11(iii) Minimax Rational Approximations

Let  $f$  be continuous on a closed interval  $[a, b]$  and  $w$  be a continuous nonvanishing function on  $[a, b]$ :  $w$  is called a *weight function*. Then the *minimax* (or *best uniform*) rational approximation

$$3.11.16 \quad R_{k,\ell}(x) = \frac{p_0 + p_1x + \dots + p_kx^k}{1 + q_1x + \dots + q_\ell x^\ell}$$

of type  $[k, \ell]$  to  $f$  on  $[a, b]$  minimizes the maximum value of  $|\epsilon_{k,\ell}(x)|$  on  $[a, b]$ , where

$$3.11.17 \quad \epsilon_{k,\ell}(x) = \frac{R_{k,\ell}(x) - f(x)}{w(x)}.$$

The theory of polynomial minimax approximation given in §3.11(i) can be extended to the case when  $p_n(x)$  is replaced by a rational function  $R_{k,\ell}(x)$ . There exists a unique solution of this minimax problem and there are at least  $k + \ell + 2$  values  $x_j$ ,  $a \leq x_0 < x_1 < \dots < x_{k+\ell+1} \leq b$ , such that  $m_j = m$ , where

**3.11.18**  $m_j = (-1)^j \epsilon_{k,\ell}(x_j)$ ,  $j = 0, 1, \dots, k + \ell + 1$ , and  $\pm m$  is the maximum of  $|\epsilon_{k,\ell}(x)|$  on  $[a, b]$ .

A collection of minimax rational approximations to elementary and special functions can be found in Hart *et al.* (1968).

A widely implemented and used algorithm for calculating the coefficients  $p_j$  and  $q_j$  in (3.11.16) is *Remez's second algorithm*. See Remez (1957), Werner *et al.* (1967), and Johnson and Blair (1973).

**Example**

With  $w(x) = 1$  and 14-digit computation, we obtain the following rational approximation of type  $[3, 3]$  to the Bessel function  $J_0(x)$  (§10.2(ii)) on the interval  $0 \leq x \leq j_{0,1}$ , where  $j_{0,1}$  is the first positive zero of  $J_0(x)$ :

**3.11.19**  $R_{3,3}(x) = \frac{p_0 + p_1x + p_2x^2 + p_3x^3}{1 + q_1x + q_2x^2 + q_3x^3}$ ,

with coefficients given in Table 3.11.1.

Table 3.11.1: Coefficients  $p_j, q_j$  for the minimax rational approximation  $R_{3,3}(x)$ .

$j$	$p_j$	$q_j$
0	0.99999 99891 7854	
1	-0.34038 93820 9347	-0.34039 05233 8838
2	-0.18915 48376 3222	0.06086 50162 9812
3	0.06658 31942 0166	-0.01864 47680 9090

The error curve is shown in Figure 3.11.1.

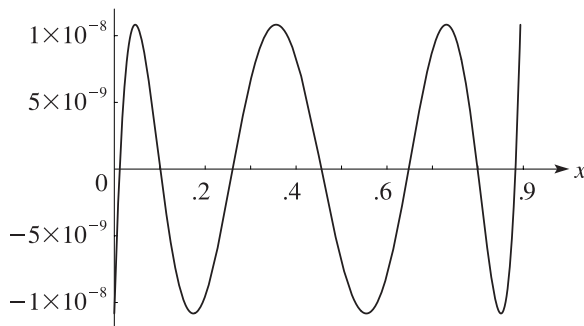


Figure 3.11.1: Error  $R_{3,3}(x) - J_0(x)$  of the minimax rational approximation  $R_{3,3}(x)$  to the Bessel function  $J_0(x)$  for  $0 \leq x \leq j_{0,1}$  ( $= 0.89357 \dots$ ).

**3.11(iv) Padé Approximations**

Let

**3.11.20**  $f(z) = c_0 + c_1z + c_2z^2 + \dots$

be a formal power series. The rational function

**3.11.21**  $\frac{N_{p,q}(z)}{D_{p,q}(z)} = \frac{a_0 + a_1z + \dots + a_pz^p}{b_0 + b_1z + \dots + b_qz^q}$

is called a *Padé approximant at zero* of  $f$  if

**3.11.22**  $N_{p,q}(z) - f(z)D_{p,q}(z) = O(z^{p+q+1})$ ,  $z \rightarrow 0$ .

It is denoted by  $[p/q]_f(z)$ . Thus if  $b_0 \neq 0$ , then the Maclaurin expansion of (3.11.21) agrees with (3.11.20) up to, and including, the term in  $z^{p+q}$ .

The requirement (3.11.22) implies

$a_0 = c_0b_0$ ,

$a_1 = c_1b_0 + c_0b_1$ ,

$\vdots$

**3.11.23**  $a_p = c_pb_0 + c_{p-1}b_1 + \dots + c_{p-q}b_q$ ,

$0 = c_{p+1}b_0 + c_pb_1 + \dots + c_{p-q+1}b_q$ ,

$\vdots$

$0 = c_{p+q}b_0 + c_{p+q-1}b_1 + \dots + c_pb_q$ ,

where  $c_j = 0$  if  $j < 0$ . With  $b_0 = 1$ , the last  $q$  equations give  $b_1, \dots, b_q$  as the solution of a system of linear equations. The first  $p + 1$  equations then yield  $a_0, \dots, a_p$ .

The array of Padé approximants

**3.11.24**

$[0/0]_f$	$[0/1]_f$	$[0/2]_f$	$\dots$
$[1/0]_f$	$[1/1]_f$	$[1/2]_f$	$\dots$
$[2/0]_f$	$[2/1]_f$	$[2/2]_f$	$\dots$
$\vdots$	$\vdots$	$\vdots$	$\ddots$

is called a *Padé table*. Approximants with the same denominator degree are located in the same column of the table.

For convergence results for Padé approximants, and the connection with continued fractions and Gaussian quadrature, see Baker and Graves-Morris (1996, §4.7).

The Padé approximants can be computed by *Wynn's cross rule*. Any five approximants arranged in the Padé table as

	$N$		
$W$	$C$	$E$	
		$S$	

satisfy

**3.11.25**  $(N - C)^{-1} + (S - C)^{-1} = (W - C)^{-1} + (E - C)^{-1}$ .

Starting with the first column  $[n/0]_f$ ,  $n = 0, 1, 2, \dots$ , and initializing the preceding column by  $[n/-1]_f = \infty$ ,  $n = 1, 2, \dots$ , we can compute the lower triangular part of the table via (3.11.25). Similarly, the upper triangular part follows from the first row  $[0/n]_f$ ,  $n = 0, 1, 2, \dots$ , by initializing  $[-1/n]_f = 0$ ,  $n = 1, 2, \dots$

For the recursive computation of  $[n+k/k]_f$  by Wynn's epsilon algorithm, see (3.9.11) and the subsequent text.

### Laplace Transform Inversion

Numerical inversion of the Laplace transform (§1.14(iii))

$$3.11.26 \quad F(s) = \mathcal{L}(f; s) = \int_0^\infty e^{-st} f(t) dt$$

requires  $f = \mathcal{L}^{-1} F$  to be obtained from numerical values of  $F$ . A general procedure is to approximate  $F$  by a rational function  $R$  (vanishing at infinity) and then approximate  $f$  by  $r = \mathcal{L}^{-1} R$ . When  $F$  has an explicit power-series expansion a possible choice of  $R$  is a Padé approximation to  $F$ . See Luke (1969b, §16.4) for several examples involving special functions.

For further information on Padé approximations, see Baker and Graves-Morris (1996, §4.7), Brezinski (1980, pp. 9–39 and 126–177), and Lorentzen and Waadeland (1992, pp. 367–395).

### 3.11(v) Least Squares Approximations

Suppose a function  $f(x)$  is approximated by the polynomial

$$3.11.27 \quad p_n(x) = a_n x^n + a_{n-1} x^{n-1} + \cdots + a_0$$

that minimizes

$$3.11.28 \quad S = \sum_{j=1}^J (f(x_j) - p_n(x_j))^2.$$

Here  $x_j$ ,  $j = 1, 2, \dots, J$ , is a given set of distinct real points and  $J \geq n+1$ . From the equations  $\partial S / \partial a_k = 0$ ,  $k = 0, 1, \dots, n$ , we derive the *normal equations*

$$3.11.29 \quad \begin{bmatrix} X_0 & X_1 & \cdots & X_n \\ X_1 & X_2 & \cdots & X_{n+1} \\ \vdots & \vdots & \ddots & \vdots \\ X_n & X_{n+1} & \cdots & X_{2n} \end{bmatrix} \begin{bmatrix} a_0 \\ a_1 \\ \vdots \\ a_n \end{bmatrix} = \begin{bmatrix} F_0 \\ F_1 \\ \vdots \\ F_n \end{bmatrix},$$

where

$$3.11.30 \quad X_k = \sum_{j=1}^J x_j^k, \quad F_k = \sum_{j=1}^J f(x_j) x_j^k.$$

(3.11.29) is a system of  $n+1$  linear equations for the coefficients  $a_0, a_1, \dots, a_n$ . The matrix is symmetric and positive definite, but the system is ill-conditioned when  $n$  is large because the lower rows of the matrix are approximately proportional to one another. If  $J = n+1$ , then  $p_n(x)$  is the Lagrange interpolation polynomial for the set  $x_1, x_2, \dots, x_J$  (§3.3(i)).

More generally, let  $f(x)$  be approximated by a linear combination

$$3.11.31 \quad \Phi_n(x) = a_n \phi_n(x) + a_{n-1} \phi_{n-1}(x) + \cdots + a_0 \phi_0(x)$$

of given functions  $\phi_k(x)$ ,  $k = 0, 1, \dots, n$ , that minimizes

$$3.11.32 \quad \sum_{j=1}^J w(x_j) (f(x_j) - \Phi_n(x_j))^2,$$

$w(x)$  being a given positive *weight function*, and again  $J \geq n+1$ . Then (3.11.29) is replaced by

$$3.11.33 \quad \begin{bmatrix} X_{00} & X_{01} & \cdots & X_{0n} \\ X_{10} & X_{11} & \cdots & X_{1n} \\ \vdots & \vdots & \ddots & \vdots \\ X_{n0} & X_{n1} & \cdots & X_{nn} \end{bmatrix} \begin{bmatrix} a_0 \\ a_1 \\ \vdots \\ a_n \end{bmatrix} = \begin{bmatrix} F_0 \\ F_1 \\ \vdots \\ F_n \end{bmatrix},$$

with

$$3.11.34 \quad X_{k\ell} = \sum_{j=1}^J w(x_j) \phi_k(x_j) \phi_\ell(x_j),$$

and

$$3.11.35 \quad F_k = \sum_{j=1}^J w(x_j) f(x_j) \phi_k(x_j).$$

Since  $X_{k\ell} = X_{\ell k}$ , the matrix is again symmetric.

If the functions  $\phi_k(x)$  are linearly independent on the set  $x_1, x_2, \dots, x_J$ , that is, the only solution of the system of equations

$$3.11.36 \quad \sum_{k=0}^n c_k \phi_k(x_j) = 0, \quad j = 1, 2, \dots, J,$$

is  $c_0 = c_1 = \cdots = c_n = 0$ , then the approximation  $\Phi_n(x)$  is determined uniquely.

Now suppose that  $X_{k\ell} = 0$  when  $k \neq \ell$ , that is, the functions  $\phi_k(x)$  are *orthogonal with respect to weighted summation on the discrete set*  $x_1, x_2, \dots, x_J$ . Then the system (3.11.33) is diagonal and hence well-conditioned.

A set of functions  $\phi_0(x), \phi_1(x), \dots, \phi_n(x)$  that is linearly independent on the set  $x_1, x_2, \dots, x_J$  (compare (3.11.36)) can always be orthogonalized in the sense given in the preceding paragraph by the *Gram-Schmidt* procedure; see Gautschi (1997b).

#### Example. The Discrete Fourier Transform

We take  $n$  complex exponentials  $\phi_k(x) = e^{ikx}$ ,  $k = 0, 1, \dots, n-1$ , and approximate  $f(x)$  by the linear combination (3.11.31). The functions  $\phi_k(x)$  are orthogonal on the set  $x_0, x_1, \dots, x_{n-1}$ ,  $x_j = 2\pi j/n$ , with respect to the weight function  $w(x) = 1$ , in the sense that

$$3.11.37 \quad \sum_{j=0}^{n-1} \phi_k(x_j) \overline{\phi_\ell(x_j)} = n \delta_{k,\ell}, \quad k, \ell = 0, 1, \dots, n-1,$$

$\delta_{k,\ell}$  being Kronecker's symbol and the bar denoting complex conjugate. In consequence we can solve the system

$$3.11.38 \quad f_j = \sum_{k=0}^{n-1} a_k \phi_k(x_j), \quad j = 0, 1, \dots, n-1,$$

and obtain

$$3.11.39 \quad a_k = \frac{1}{n} \sum_{j=0}^{n-1} f_j \overline{\phi_k(x_j)}, \quad k = 0, 1, \dots, n-1.$$

With this choice of  $a_k$  and  $f_j = f(x_j)$ , the corresponding sum (3.11.32) vanishes.

The pair of vectors  $\{\mathbf{f}, \mathbf{a}\}$

$$3.11.40 \quad \begin{aligned} \mathbf{f} &= [f_0, f_1, \dots, f_{n-1}]^T, \\ \mathbf{a} &= [a_0, a_1, \dots, a_{n-1}]^T, \end{aligned}$$

is called a *discrete Fourier transform pair*.

### The Fast Fourier Transform

The direct computation of the discrete Fourier transform (3.11.38), that is, of

$$3.11.41 \quad f_j = \sum_{k=0}^{n-1} a_k \omega_n^{jk}, \quad \omega_n = e^{2\pi i/n}, \quad j = 0, 1, \dots, n-1,$$

requires approximately  $n^2$  multiplications. The method of the *fast Fourier transform* (FFT) exploits the structure of the matrix  $\Omega$  with elements  $\omega_n^{jk}$ ,  $j, k = 0, 1, \dots, n-1$ . If  $n = 2^m$ , then  $\Omega$  can be factored into  $m$  matrices, the rows of which contain only a few nonzero entries and the nonzero entries are equal apart from signs. In consequence of this structure the number of operations can be reduced to  $nm = n \log_2 n$  operations.

The property

$$3.11.42 \quad \omega_n^{2(k-(n/2))} = \omega_{n/2}^k$$

is of fundamental importance in the FFT algorithm. If  $n$  is not a power of 2, then modifications are possible. For the original reference see Cooley and Tukey (1965). For further details and algorithms, see Van Loan (1992).

For further information on least squares approximations, including examples, see Gautschi (1997b, Chapter 2) and Björck (1996, Chapters 1 and 2).

### 3.11(vi) Splines

Splines are defined piecewise and usually by low-degree polynomials. Given  $n+1$  distinct points  $x_k$  in the real interval  $[a, b]$ , with  $(a =) x_0 < x_1 < \dots < x_{n-1} < x_n (= b)$ , on each subinterval  $[x_k, x_{k+1}]$ ,  $k = 0, 1, \dots, n-1$ , a low-degree polynomial is defined with coefficients determined by, for example, values  $f_k$  and  $f'_k$  of a function  $f$  and its derivative at the nodes  $x_k$  and  $x_{k+1}$ . The set of all the polynomials defines a function, the *spline*, on  $[a, b]$ . By taking more derivatives into account, the smoothness of the spline will increase.

For splines based on Bernoulli and Euler polynomials, see §24.17(ii).

For many applications a spline function is a more adaptable approximating tool than the Lagrange interpolation polynomial involving a comparable number

of parameters; see §3.3(i), where a single polynomial is used for interpolating  $f(x)$  on the complete interval  $[a, b]$ . Multivariate functions can also be approximated in terms of multivariate polynomial splines. See de Boor (2001), Chui (1988), and Schumaker (1981) for further information.

In computer graphics a special type of spline is used which produces a *Bézier curve*. A cubic Bézier curve is defined by four points. Two are endpoints:  $(x_0, y_0)$  and  $(x_3, y_3)$ ; the other points  $(x_1, y_1)$  and  $(x_2, y_2)$  are control points. The slope of the curve at  $(x_0, y_0)$  is tangent to the line between  $(x_0, y_0)$  and  $(x_1, y_1)$ ; similarly the slope at  $(x_3, y_3)$  is tangent to the line between  $x_2, y_2$  and  $x_3, y_3$ . The curve is described by  $x(t)$  and  $y(t)$ , which are cubic polynomials with  $t \in [0, 1]$ . A complete spline results by composing several Bézier curves. A special applications area of Bézier curves is mathematical typography and the design of type fonts. See Knuth (1986, pp. 116-136).

## 3.12 Mathematical Constants

The fundamental constant

$$3.12.1 \quad \pi = 3.14159\ 26535\ 89793\ 23846\ \dots$$

can be defined analytically in numerous ways, for example,

$$3.12.2 \quad \pi = 4 \int_0^1 \frac{dt}{1+t^2}.$$

Other constants that appear in this Handbook include the base  $e$  of natural logarithms

$$3.12.3 \quad e = 2.71828\ 18284\ 59045\ 23536\ \dots,$$

see §4.2(ii), and Euler's constant  $\gamma$

$$3.12.4 \quad \gamma = 0.57721\ 56649\ 01532\ 86060\ \dots,$$

see §5.2(ii).

For access to online high-precision numerical values of mathematical constants see Sloane (2003). For historical and other information see Finch (2003).

## References

### General References

Lozier and Olver (1994) gives an overview of the numerical evaluation of special functions. For more detailed information see Gautschi (1997b), Gil *et al.* (2007a), Henrici (1974, 1977, 1986), Hildebrand (1974), Luke (1969a,b).

## Sources

The following list gives the references or other indications of proofs that were used in constructing the various sections of this chapter. These sources supplement the references that are quoted in the text.

§3.2 Young and Gregory (1988, pp. 741–743), Wilkinson (1988, Chapter 2, §§8–10, and pp. 394–395, 423).

§3.3 Davis (1975, Chapters 2–4), National Bureau of Standards (1944, pp. xv–xvii), Hildebrand (1974, Chapter 2), Ostrowski (1973, pp. 18–26).

§3.4 Hildebrand (1974, pp. 85–89). The coefficients  $B_k^n$  are obtained by differentiation of the  $A_k^n$ ; compare (3.4.2).

§3.5 Davis and Rabinowitz (1984, pp. 54–58, 118–120, 137, 434–436), Bauer *et al.* (1963), Golub and Welsch (1969), Salzer (1955). For (3.5.18)–(3.5.19) see Waldvogel (2006). For Table 3.5.21 see Stroud (1971, pp. 243–249, 278–279).

In §3.5(v) all numerical values of the nodes  $x_k$  and corresponding weights  $w_k$  that appear in the tables in the text and on the Web site can be com-

puted, for example, by means of the quadruple-precision analogs of the softwares **recur** and **gauss** given in Gautschi (1994), or in the case of the tables for the logarithmic weight function with **recur** replaced by **cheb**, also provided in Gautschi (1994). The three softwares can be used for other values of  $n$ , and other values of the parameters  $\alpha$  and  $\beta$  that appear in some of the weight functions.

§3.6 Olver (1967a).

§3.8 Gautschi (1997b, pp. 217–225, 230–234), Ostrowski (1973, Chapters 3–11), Traub (1964, pp. 268–269), National Physical Laboratory (1961, pp. 57–59), Hildebrand (1974, p. 582).

§3.9 Knopp (1964, pp. 253–255).

§3.10 Blanch (1964), Rutishauser (1957), Wall (1948, pp. 17–19), Barnett *et al.* (1974), Barnett (1981a).

§3.11 Powell (1967), Meinardus (1967, §3), Wynn (1966).

§3.12 For more digits in (3.12.1), (3.12.3), and (3.12.4) see OEIS Sequences A000796, A001113, and A001620. See also Sloane (2003).



## Chapter 4

# Elementary Functions

R. Roy<sup>1</sup> and F. W. J. Olver<sup>2</sup>

<b>Notation</b>	<b>104</b>	4.26 Integrals . . . . .	122
4.1 Special Notation . . . . .	104	4.27 Sums . . . . .	123
<b>Logarithm, Exponential, Powers</b>	<b>104</b>	<b>Hyperbolic Functions</b>	<b>123</b>
4.2 Definitions . . . . .	104	4.28 Definitions and Periodicity . . . . .	123
4.3 Graphics . . . . .	106	4.29 Graphics . . . . .	123
4.4 Special Values and Limits . . . . .	107	4.30 Elementary Properties . . . . .	124
4.5 Inequalities . . . . .	108	4.31 Special Values and Limits . . . . .	125
4.6 Power Series . . . . .	108	4.32 Inequalities . . . . .	125
4.7 Derivatives and Differential Equations . .	108	4.33 Maclaurin Series and Laurent Series . . .	125
4.8 Identities . . . . .	109	4.34 Derivatives and Differential Equations . .	125
4.9 Continued Fractions . . . . .	109	4.35 Identities . . . . .	125
4.10 Integrals . . . . .	110	4.36 Infinite Products and Partial Fractions . .	126
4.11 Sums . . . . .	110	4.37 Inverse Hyperbolic Functions . . . . .	127
4.12 Generalized Logarithms and Exponentials	111	4.38 Inverse Hyperbolic Functions: Further	
4.13 Lambert $W$ -Function . . . . .	111	Properties . . . . .	129
<b>Trigonometric Functions</b>	<b>111</b>	4.39 Continued Fractions . . . . .	129
4.14 Definitions and Periodicity . . . . .	112	4.40 Integrals . . . . .	129
4.15 Graphics . . . . .	112	4.41 Sums . . . . .	130
4.16 Elementary Properties . . . . .	115	<b>Applications</b>	<b>130</b>
4.17 Special Values and Limits . . . . .	116	4.42 Solution of Triangles . . . . .	130
4.18 Inequalities . . . . .	116	4.43 Cubic Equations . . . . .	131
4.19 Maclaurin Series and Laurent Series . . .	116	4.44 Other Applications . . . . .	131
4.20 Derivatives and Differential Equations . .	117	<b>Computation</b>	<b>131</b>
4.21 Identities . . . . .	117	4.45 Methods of Computation . . . . .	131
4.22 Infinite Products and Partial Fractions . .	118	4.46 Tables . . . . .	132
4.23 Inverse Trigonometric Functions . . . . .	118	4.47 Approximations . . . . .	132
4.24 Inverse Trigonometric Functions: Further		4.48 Software . . . . .	133
Properties . . . . .	121	<b>References</b>	<b>133</b>
4.25 Continued Fractions . . . . .	121		

<sup>1</sup>Department of Mathematics and Computer Science, Beloit College, Beloit, Wisconsin.

<sup>2</sup>Institute for Physical Science and Technology and Department of Mathematics, University of Maryland, College Park, Maryland.

**Acknowledgments:** The authors are grateful to Steven G. Krantz and Peter R. Turner for advice on early drafts of this chapter.

**Copyright** © 2009 National Institute of Standards and Technology. All rights reserved.



## Notation

### 4.1 Special Notation

(For other notation see pp. xiv and 873.)

$k, m, n$	integers.
$a, c$	real or complex constants.
$x, y$	real variables.
$z = x + iy$	complex variable.
$e$	base of natural logarithms.

It is assumed the user is familiar with the definitions and properties of elementary functions of real arguments  $x$ . The main purpose of the present chapter is to extend these definitions and properties to complex arguments  $z$ .

The main functions treated in this chapter are the logarithm  $\ln z$ ,  $\text{Ln } z$ ; the exponential  $\exp z$ ,  $e^z$ ; the circular trigonometric (or just trigonometric) functions  $\sin z$ ,  $\cos z$ ,  $\tan z$ ,  $\csc z$ ,  $\sec z$ ,  $\cot z$ ; the inverse trigonometric functions  $\arcsin z$ ,  $\text{Arcsin } z$ , etc.; the hyperbolic trigonometric (or just hyperbolic) functions  $\sinh z$ ,  $\cosh z$ ,  $\tanh z$ ,  $\text{csch } z$ ,  $\text{sech } z$ ,  $\text{coth } z$ ; the inverse hyperbolic functions  $\text{arcsinh } z$ ,  $\text{Arcsinh } z$ , etc.

Sometimes in the literature the meanings of  $\ln$  and  $\text{Ln}$  are interchanged; similarly for  $\arcsin z$  and  $\text{Arcsin } z$ , etc. Sometimes “arc” is replaced by the index “-1”, e.g.  $\sin^{-1} z$  for  $\arcsin z$  and  $\text{Sin}^{-1} z$  for  $\text{Arcsin } z$ .

## Logarithm, Exponential, Powers

### 4.2 Definitions

#### 4.2(i) The Logarithm

The *general logarithm function*  $\text{Ln } z$  is defined by

$$4.2.1 \quad \text{Ln } z = \int_1^z \frac{dt}{t}, \quad z \neq 0,$$

where the integration path does not intersect the origin. This is a multivalued function of  $z$  with branch point at  $z = 0$ .

The *principal value*, or *principal branch*, is defined by

$$4.2.2 \quad \ln z = \int_1^z \frac{dt}{t},$$

where the path does not intersect  $(-\infty, 0]$ ; see Figure 4.2.1.  $\ln z$  is a single-valued analytic function on  $\mathbb{C} \setminus (-\infty, 0]$  and real-valued when  $z$  ranges over the positive real numbers.

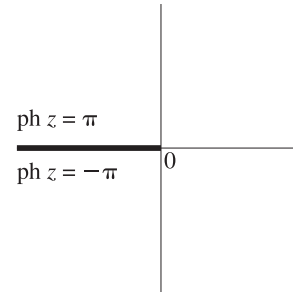


Figure 4.2.1:  $z$ -plane: Branch cut for  $\ln z$  and  $z^\alpha$ .

The real and imaginary parts of  $\ln z$  are given by

$$4.2.3 \quad \ln z = \ln |z| + i \text{ph } z, \quad -\pi < \text{ph } z < \pi.$$

For  $\text{ph } z$  see §1.9(i).

The only zero of  $\ln z$  is at  $z = 1$ .

Most texts extend the definition of the principal value to include the *branch cut*

$$4.2.4 \quad z = x, \quad -\infty < x < 0,$$

by replacing (4.2.3) with

$$4.2.5 \quad \ln z = \ln |z| + i \text{ph } z, \quad -\pi < \text{ph } z \leq \pi.$$

With this definition the general logarithm is given by

$$4.2.6 \quad \text{Ln } z = \ln z + 2k\pi i,$$

where  $k$  is the excess of the number of times the path in (4.2.1) crosses the negative real axis in the positive sense over the number of times in the negative sense.

In this Handbook we allow a further extension by regarding the cut as representing two sets of points, one set corresponding to the “upper side” and denoted by  $z = x + i0$ , the other set corresponding to the “lower side” and denoted by  $z = x - i0$ . Again see Figure 4.2.1. Then

$$4.2.7 \quad \ln(x \pm i0) = \ln |x| \pm i\pi, \quad -\infty < x < 0,$$

with either upper signs or lower signs taken throughout. Consequently  $\ln z$  is two-valued on the cut, and discontinuous across the cut. We regard this as the *closed definition of the principal value*.

In contrast to (4.2.5) the closed definition is symmetric. As a consequence, it has the advantage of extending regions of validity of properties of principal values. For example, with the definition (4.2.5) the identity (4.8.7) is valid only when  $|\text{ph } z| < \pi$ , but with the closed definition the identity (4.8.7) is valid when  $|\text{ph } z| \leq \pi$ . For another example see (4.2.37).

In this Handbook it is usually clear from the context which definition of principal value is being used. *However, in the absence of any indication to the contrary* it is assumed that the definition is the closed one. For other examples in this chapter see §§4.23, 4.24, 4.37, and 4.38.

**4.2(ii) Logarithms to a General Base  $a$** 

With  $a, b \neq 0$  or 1,

$$4.2.8 \quad \log_a z = \ln z / \ln a,$$

$$4.2.9 \quad \log_a z = \frac{\log_b z}{\log_b a},$$

$$4.2.10 \quad \log_a b = \frac{1}{\log_b a}.$$

*Natural logarithms* have as base the unique positive number

$$4.2.11 \quad e = 2.71828\ 18284\ 59045\ 23536\dots$$

such that

$$4.2.12 \quad \ln e = 1.$$

Equivalently,

$$4.2.13 \quad \int_1^e \frac{dt}{t} = 1.$$

Thus

$$4.2.14 \quad \log_e z = \ln z,$$

$$4.2.15 \quad \log_{10} z = (\ln z) / (\ln 10) = (\log_{10} e) \ln z,$$

$$4.2.16 \quad \ln z = (\ln 10) \log_{10} z,$$

$$4.2.17 \quad \log_{10} e = 0.43429\ 44819\ 03251\ 82765\dots,$$

$$4.2.18 \quad \ln 10 = 2.30258\ 50929\ 94045\ 68401\dots$$

$\log_e x = \ln x$  is also called the *Napierian* or *hyperbolic* logarithm.  $\log_{10} x$  is the *common* or *Briggs* logarithm.

**4.2(iii) The Exponential Function**

$$4.2.19 \quad \exp z = 1 + \frac{z}{1!} + \frac{z^2}{2!} + \frac{z^3}{3!} + \dots$$

The function  $\exp$  is an entire function of  $z$ , with no real or complex zeros. It has period  $2\pi i$ :

$$4.2.20 \quad \exp(z + 2\pi i) = \exp z.$$

Also,

$$4.2.21 \quad \exp(-z) = 1 / \exp(z).$$

$$4.2.22 \quad |\exp z| = \exp(\Re z).$$

The general value of the phase is given by

$$4.2.23 \quad \text{ph}(\exp z) = \Im z + 2k\pi, \quad k \in \mathbb{Z}.$$

If  $z = x + iy$ , then

$$4.2.24 \quad \exp z = e^x \cos y + ie^x \sin y.$$

If  $\zeta \neq 0$  then

$$4.2.25 \quad \exp z = \zeta \iff z = \text{Ln } \zeta.$$

**4.2(iv) Powers****Powers with General Bases**

The general  $a^{\text{th}}$  power of  $z$  is defined by

$$4.2.26 \quad z^a = \exp(a \text{Ln } z), \quad z \neq 0.$$

In particular,  $z^0 = 1$ , and if  $a = n = 1, 2, 3, \dots$ , then

$$4.2.27 \quad z^a = \underbrace{z \cdot z \cdots z}_{n \text{ times}} = 1/z^{-a}.$$

In all other cases,  $z^a$  is a multivalued function with branch point at  $z = 0$ . The *principal value* is

$$4.2.28 \quad z^a = \exp(a \ln z).$$

This is an analytic function of  $z$  on  $\mathbb{C} \setminus (-\infty, 0]$ , and is two-valued and discontinuous on the cut shown in Figure 4.2.1, unless  $a \in \mathbb{Z}$ .

$$4.2.29 \quad |z^a| = |z|^{\Re a} \exp(-(\Im a) \text{ph } z),$$

$$4.2.30 \quad \text{ph}(z^a) = (\Re a) \text{ph } z + (\Im a) \ln |z|,$$

where  $\text{ph } z \in [-\pi, \pi]$  for the principal value of  $z^a$ , and is unrestricted in the general case. When  $a$  is real

$$4.2.31 \quad |z^a| = |z|^a, \quad \text{ph}(z^a) = a \text{ph } z.$$

*Unless indicated otherwise*, it is assumed throughout this Handbook that a power assumes its principal value. With this convention,

$$4.2.32 \quad e^z = \exp z,$$

but the general value of  $e^z$  is

$$4.2.33 \quad e^z = (\exp z) \exp(2kz\pi i), \quad k \in \mathbb{Z}.$$

For  $z = 1$

$$4.2.34 \quad e = 1 + \frac{1}{1!} + \frac{1}{2!} + \frac{1}{3!} + \dots$$

If  $z^a$  has its general value, with  $a \neq 0$ , and if  $w \neq 0$ , then

$$4.2.35 \quad z^a = w \iff z = \exp\left(\frac{1}{a} \text{Ln } w\right).$$

This result is also valid when  $z^a$  has its principal value, provided that the branch of  $\text{Ln } w$  satisfies

$$4.2.36 \quad -\pi \leq \Im\left(\frac{1}{a} \text{Ln } w\right) \leq \pi.$$

Another example of a principal value is provided by

$$4.2.37 \quad \sqrt{z^2} = \begin{cases} z, & \Re z \geq 0, \\ -z, & \Re z \leq 0. \end{cases}$$

Again, without the closed definition the  $\geq$  and  $\leq$  signs would have to be replaced by  $>$  and  $<$ , respectively.

### 4.3 Graphics

#### 4.3(i) Real Arguments

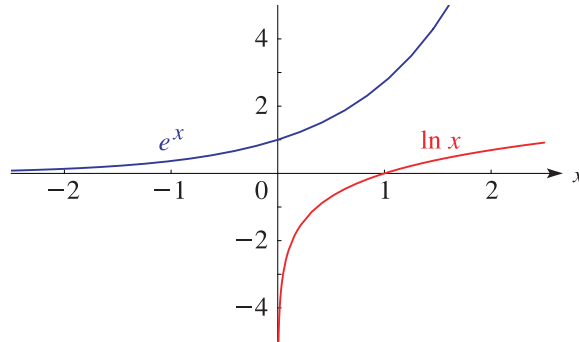
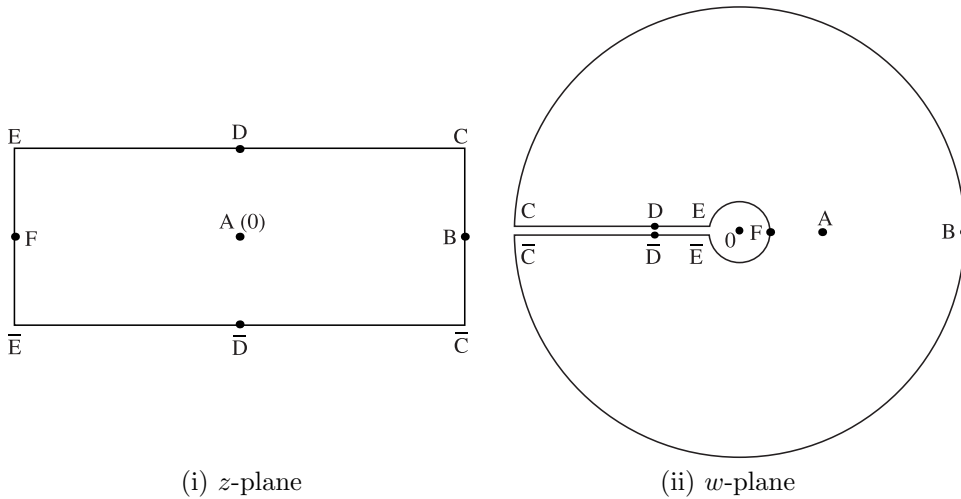


Figure 4.3.1:  $\ln x$  and  $e^x$ .

#### 4.3(ii) Complex Arguments: Conformal Maps

Figure 4.3.2 illustrates the conformal mapping of the strip  $-\pi < \Im z < \pi$  onto the whole  $w$ -plane cut along the negative real axis, where  $w = e^z$  and  $z = \ln w$  (principal value). Corresponding points share the same letters, with bars signifying complex conjugates. Lines parallel to the real axis in the  $z$ -plane map onto rays in the  $w$ -plane, and lines parallel to the imaginary axis in the  $z$ -plane map onto circles centered at the origin in the  $w$ -plane. In the labeling of corresponding points  $r$  is a real parameter that can lie anywhere in the interval  $(0, \infty)$ .



	A	B	C	$\bar{C}$	D	$\bar{D}$	E	$\bar{E}$	F
$z$	0	$r$	$r + i\pi$	$r - i\pi$	$i\pi$	$-i\pi$	$-r + i\pi$	$-r - i\pi$	$-r$
$w$	1	$e^r$	$-e^r + i0$	$-e^r - i0$	$-1 + i0$	$-1 - i0$	$-e^{-r} + i0$	$-e^{-r} - i0$	$e^{-r}$

Figure 4.3.2: Conformal mapping of exponential and logarithm.  $w = e^z$ ,  $z = \ln w$ .

### 4.3(iii) Complex Arguments: Surfaces

In the graphics shown in this subsection height corresponds to the absolute value of the function and color to the phase. See also p. [xiv](#).

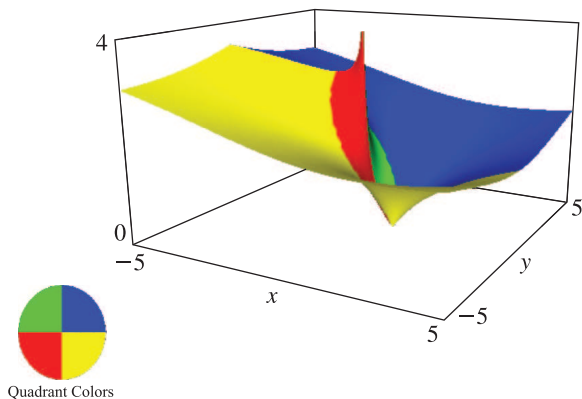


Figure 4.3.3:  $\ln(x + iy)$  (principal value). There is a branch cut along the negative real axis.

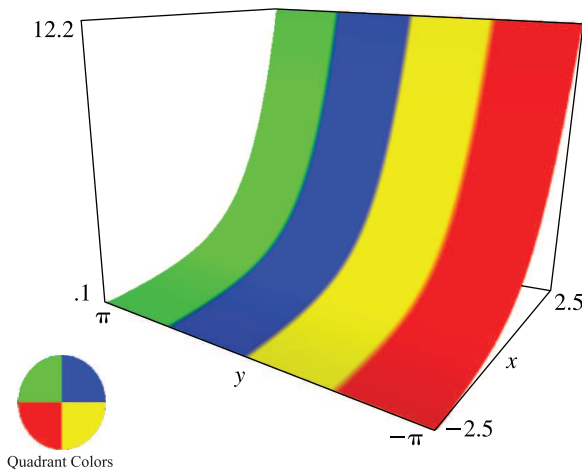


Figure 4.3.4:  $e^{x+iy}$ .

## 4.4 Special Values and Limits

### 4.4(i) Logarithms

- 4.4.1  $\ln 1 = 0,$
- 4.4.2  $\ln(-1 \pm i0) = \pm \pi i,$
- 4.4.3  $\ln(\pm i) = \pm \frac{1}{2}\pi i.$

### 4.4(ii) Powers

- 4.4.4  $e^0 = 1,$
- 4.4.5  $e^{\pm \pi i} = -1,$
- 4.4.6  $e^{\pm \pi i/2} = \pm i,$
- 4.4.7  $e^{2\pi ki} = 1, \quad k \in \mathbb{Z},$
- 4.4.8  $e^{\pm \pi i/3} = \frac{1}{2} \pm i \frac{\sqrt{3}}{2},$
- 4.4.9  $e^{\pm 2\pi i/3} = -\frac{1}{2} \pm i \frac{\sqrt{3}}{2},$
- 4.4.10  $e^{\pm \pi i/4} = \frac{1}{\sqrt{2}} \pm i \frac{1}{\sqrt{2}},$

- 4.4.11  $e^{\pm 3\pi i/4} = -\frac{1}{\sqrt{2}} \pm i \frac{1}{\sqrt{2}},$
- 4.4.12  $i^{\pm i} = e^{\mp \pi/2}.$

### 4.4(iii) Limits

- 4.4.13  $\lim_{x \rightarrow \infty} x^{-a} \ln x = 0, \quad \Re a > 0,$
- 4.4.14  $\lim_{x \rightarrow 0} x^a \ln x = 0, \quad \Re a > 0,$
- 4.4.15  $\lim_{x \rightarrow \infty} x^a e^{-x} = 0,$
- 4.4.16  $\lim_{z \rightarrow \infty} z^a e^{-z} = 0, \quad |\text{ph } z| \leq \frac{1}{2}\pi - \delta (< \frac{1}{2}\pi),$   
where  $a (\in \mathbb{C})$  and  $\delta (\in (0, \frac{1}{2}\pi])$  are constants.
- 4.4.17  $\lim_{n \rightarrow \infty} \left(1 + \frac{z}{n}\right)^n = e^z, \quad z = \text{constant}.$
- 4.4.18  $\lim_{n \rightarrow \infty} \left(1 + \frac{1}{n}\right)^n = e.$
- 4.4.19  $\lim_{n \rightarrow \infty} \left( \left( \sum_{k=1}^n \frac{1}{k} \right) - \ln n \right)$   
 $= \gamma = 0.57721\ 56649\ 01532\ 86060 \dots,$   
where  $\gamma$  is Euler's constant; see (5.2.3).

## 4.5 Inequalities

### 4.5(i) Logarithms

$$4.5.1 \quad \frac{x}{1+x} < \ln(1+x) < x, \quad x > -1, x \neq 0,$$

$$4.5.2 \quad x < -\ln(1-x) < \frac{x}{1-x}, \quad x < 1, x \neq 0,$$

$$4.5.3 \quad |\ln(1-x)| < \frac{3}{2}x, \quad 0 < x \leq 0.5828\dots,$$

$$4.5.4 \quad \ln x \leq x - 1, \quad x > 0,$$

$$4.5.5 \quad \ln x \leq a(x^{1/a} - 1), \quad a, x > 0,$$

$$4.5.6 \quad |\ln(1+z)| \leq -\ln(1-|z|), \quad |z| < 1.$$

For more inequalities involving the logarithm function see Mitrinović (1964, pp. 75–77), Mitrinović (1970, pp. 272–276), and Bullen (1998, pp. 159–160).

### 4.5(ii) Exponentials

In (4.5.7)–(4.5.12) it is assumed that  $x \neq 0$ . (When  $x = 0$  the inequalities become equalities.)

$$4.5.7 \quad e^{-x/(1-x)} < 1 - x < e^{-x}, \quad x < 1,$$

$$4.5.8 \quad 1 + x < e^x, \quad -\infty < x < \infty,$$

$$4.5.9 \quad e^x < \frac{1}{1-x}, \quad x < 1,$$

$$4.5.10 \quad \frac{x}{1+x} < 1 - e^{-x} < x, \quad x > -1,$$

$$4.5.11 \quad x < e^x - 1 < \frac{x}{1-x}, \quad x < 1,$$

$$4.5.12 \quad e^{x/(1+x)} < 1 + x, \quad x > -1,$$

$$4.5.13 \quad e^{xy/(x+y)} < \left(1 + \frac{x}{y}\right)^y < e^x, \quad x > 0, y > 0,$$

$$4.5.14 \quad e^{-x} < 1 - \frac{1}{2}x, \quad 0 < x \leq 1.5936\dots,$$

$$4.5.15 \quad \frac{1}{4}|z| < |e^z - 1| < \frac{7}{4}|z|, \quad 0 < |z| < 1,$$

$$4.5.16 \quad |e^z - 1| \leq e^{|z|} - 1 \leq |z|e^{|z|}, \quad z \in \mathbb{C}.$$

For more inequalities involving the exponential function see Mitrinović (1964, pp. 73–77), Mitrinović (1970, pp. 266–271), and Bullen (1998, pp. 81–83).

## 4.6 Power Series

### 4.6(i) Logarithms

$$4.6.1 \quad \ln(1+z) = z - \frac{1}{2}z^2 + \frac{1}{3}z^3 - \dots, \quad |z| \leq 1, z \neq -1,$$

$$4.6.2 \quad \ln z = \left(\frac{z-1}{z}\right) + \frac{1}{2}\left(\frac{z-1}{z}\right)^2 + \frac{1}{3}\left(\frac{z-1}{z}\right)^3 + \dots, \\ \Re z \geq \frac{1}{2},$$

$$4.6.3 \quad \ln z = (z-1) - \frac{1}{2}(z-1)^2 + \frac{1}{3}(z-1)^3 - \dots, \\ |z-1| \leq 1, z \neq 0,$$

$$4.6.4 \quad \ln z = 2 \left( \left(\frac{z-1}{z+1}\right) + \frac{1}{3}\left(\frac{z-1}{z+1}\right)^3 + \frac{1}{5}\left(\frac{z-1}{z+1}\right)^5 + \dots \right), \\ \Re z \geq 0, z \neq 0,$$

$$4.6.5 \quad \ln\left(\frac{z+1}{z-1}\right) = 2 \left( \frac{1}{z} + \frac{1}{3z^3} + \frac{1}{5z^5} + \dots \right), \quad |z| \geq 1, z \neq \pm 1,$$

---


$$4.6.6 \quad \ln(z+a) = \ln a + 2 \left( \left(\frac{z}{2a+z}\right) + \frac{1}{3}\left(\frac{z}{2a+z}\right)^3 + \frac{1}{5}\left(\frac{z}{2a+z}\right)^5 + \dots \right), \quad a > 0, \Re z \geq -a, z \neq -a.$$


---

### 4.6(ii) Powers

#### Binomial Expansion

$$4.6.7 \quad (1+z)^a = 1 + \frac{a}{1!}z + \frac{a(a-1)}{2!}z^2 + \frac{a(a-1)(a-2)}{3!}z^3 + \dots,$$

valid when  $a$  is any real or complex constant and  $|z| < 1$ . If  $a = 0, 1, 2, \dots$ , then the series terminates and  $z$  is unrestricted.

## 4.7 Derivatives and Differential Equations

### 4.7(i) Logarithms

$$4.7.1 \quad \frac{d}{dz} \ln z = \frac{1}{z},$$

$$4.7.2 \quad \frac{d}{dz} \operatorname{Ln} z = \frac{1}{z},$$

$$4.7.3 \quad \frac{d^n}{dz^n} \ln z = (-1)^{n-1} (n-1)! z^{-n},$$

$$4.7.4 \quad \frac{d^n}{dz^n} \operatorname{Ln} z = (-1)^{n-1} (n-1)! z^{-n}.$$

For a nonvanishing analytic function  $f(z)$ , the general solution of the differential equation

$$4.7.5 \quad \frac{dw}{dz} = \frac{f'(z)}{f(z)}$$

is

$$4.7.6 \quad w(z) = \text{Ln}(f(z)) + \text{constant.}$$

### 4.7(ii) Exponentials and Powers

$$4.7.7 \quad \frac{d}{dz}e^z = e^z,$$

$$4.7.8 \quad \frac{d}{dz}e^{az} = ae^{az},$$

$$4.7.9 \quad \frac{d}{dz}a^z = a^z \ln a, \quad a \neq 0.$$

When  $a^z$  is a general power,  $\ln a$  is replaced by the branch of  $\text{Ln } a$  used in constructing  $a^z$ .

$$4.7.10 \quad \frac{d}{dz}z^a = az^{a-1},$$

$$4.7.11 \quad \frac{d^n}{dz^n}z^a = a(a-1)(a-2)\cdots(a-n+1)z^{a-n}.$$

The general solution of the differential equation

$$4.7.12 \quad \frac{dw}{dz} = f(z)w$$

is

$$4.7.13 \quad w = \exp\left(\int f(z) dz\right) + \text{constant.}$$

The general solution of the differential equation

$$4.7.14 \quad \frac{d^2w}{dz^2} = aw, \quad a \neq 0,$$

is

$$4.7.15 \quad w = Ae^{\sqrt{a}z} + Be^{-\sqrt{a}z},$$

where  $A$  and  $B$  are arbitrary constants.

For other differential equations see Kamke (1977, pp. 396–413).

## 4.8 Identities

### 4.8(i) Logarithms

In (4.8.1)–(4.8.4)  $z_1 z_2 \neq 0$ .

$$4.8.1 \quad \text{Ln}(z_1 z_2) = \text{Ln } z_1 + \text{Ln } z_2.$$

This is interpreted that every value of  $\text{Ln}(z_1 z_2)$  is one of the values of  $\text{Ln } z_1 + \text{Ln } z_2$ , and vice versa.

$$4.8.2 \quad \ln(z_1 z_2) = \ln z_1 + \ln z_2, \quad -\pi \leq \text{ph } z_1 + \text{ph } z_2 \leq \pi,$$

$$4.8.3 \quad \text{Ln} \frac{z_1}{z_2} = \text{Ln } z_1 - \text{Ln } z_2,$$

$$4.8.4 \quad \ln \frac{z_1}{z_2} = \ln z_1 - \ln z_2, \quad -\pi \leq \text{ph } z_1 - \text{ph } z_2 \leq \pi.$$

In (4.8.5)–(4.8.7) and (4.8.10)  $z \neq 0$ .

$$4.8.5 \quad \text{Ln}(z^n) = n \text{Ln } z, \quad n \in \mathbb{Z},$$

$$4.8.6 \quad \ln(z^n) = n \ln z, \quad n \in \mathbb{Z}, \quad -\pi \leq n \text{ph } z \leq \pi,$$

$$4.8.7 \quad \ln \frac{1}{z} = -\ln z, \quad |\text{ph } z| \leq \pi.$$

$$4.8.8 \quad \text{Ln}(\exp z) = z + 2k\pi i, \quad k \in \mathbb{Z},$$

$$4.8.9 \quad \ln(\exp z) = z, \quad -\pi \leq \Im z \leq \pi,$$

$$4.8.10 \quad \exp(\ln z) = \exp(\text{Ln } z) = z.$$

If  $a \neq 0$  and  $a^z$  has its general value, then

$$4.8.11 \quad \text{Ln}(a^z) = z \text{Ln } a + 2k\pi i, \quad k \in \mathbb{Z}.$$

If  $a \neq 0$  and  $a^z$  has its principal value, then

$$4.8.12 \quad \ln(a^z) = z \ln a + 2k\pi i,$$

where the integer  $k$  is chosen so that  $\Re(-iz \ln a) + 2k\pi \in [-\pi, \pi]$ .

$$4.8.13 \quad \ln(a^x) = x \ln a, \quad a > 0.$$

### 4.8(ii) Powers

$$4.8.14 \quad a^{z_1} a^{z_2} = a^{z_1+z_2},$$

$$4.8.15 \quad a^z b^z = (ab)^z, \quad -\pi \leq \text{ph } a + \text{ph } b \leq \pi,$$

$$4.8.16 \quad e^{z_1} e^{z_2} = e^{z_1+z_2},$$

$$4.8.17 \quad (e^{z_1})^{z_2} = e^{z_1 z_2}, \quad -\pi \leq \Im z_1 \leq \pi.$$

The restriction on  $z_1$  can be removed when  $z_2$  is an integer.

## 4.9 Continued Fractions

### 4.9(i) Logarithms

$$4.9.1 \quad \ln(1+z) = \frac{z}{1+} - \frac{z}{2+} + \frac{z}{3+} - \frac{4z}{4+} + \frac{4z}{5+} - \frac{9z}{6+} + \frac{9z}{7+} - \cdots, \\ |\text{ph}(1+z)| < \pi.$$

$$4.9.2 \quad \ln\left(\frac{1+z}{1-z}\right) = \frac{2z}{1-} - \frac{z^2}{3-} + \frac{4z^2}{5-} - \frac{9z^2}{7-} + \frac{16z^2}{9-} - \cdots,$$

valid when  $z \in \mathbb{C} \setminus (-\infty, -1] \cup [1, \infty)$ ; see Figure 4.23.1(i).

For other continued fractions involving logarithms see Lorentzen and Waadeland (1992, pp. 566–568). See also Cuyt *et al.* (2008, pp. 196–200).

### 4.9(ii) Exponentials

For  $z \in \mathbb{C}$ ,

$$\begin{aligned}
 e^z &= \frac{1}{1 - \frac{z}{1 + \frac{z}{2 - \frac{z}{3 + \frac{z}{2 - \frac{z}{5 + \frac{z}{2 - \dots}}}}}}} \\
 4.9.3 \quad &= 1 + \frac{z}{1 - \frac{z}{2 + \frac{z}{3 - \frac{z}{2 + \frac{z}{5 - \frac{z}{2 + \frac{z}{7 - \dots}}}}} \\
 &= 1 + \frac{z}{1 - (z/2) + \frac{z^2/(4 \cdot 3)}{1 + \frac{z^2/(4 \cdot 15)}{1 + \frac{z^2/(4 \cdot 35)}{1 + \dots \frac{z^2/(4(4n^2 - 1))}{1 + \dots}}}}
 \end{aligned}$$

$$4.9.4 \quad e^z - e_{n-1}(z) = \frac{z^n}{n! -} \frac{n!z}{(n+1) +} \frac{z}{(n+2) -} \frac{(n+1)z}{(n+3) +} \frac{2z}{(n+4) -} \frac{(n+2)z}{(n+5) +} \frac{3z}{(n+6) -} \dots,$$

where

$$4.9.5 \quad e_n(z) = \sum_{k=0}^n \frac{z^k}{k!}.$$

For other continued fractions involving the exponential function see Lorentzen and Waadeland (1992, pp. 563–564). See also Cuyt *et al.* (2008, pp. 193–195).

### 4.9(iii) Powers

See Cuyt *et al.* (2008, pp. 217–220).

## 4.10 Integrals

### 4.10(i) Logarithms

$$4.10.1 \quad \int \frac{dz}{z} = \ln z,$$

$$4.10.2 \quad \int \ln z \, dz = z \ln z - z,$$

$$4.10.3 \quad \int z^n \ln z \, dz = \frac{z^{n+1}}{n+1} \ln z - \frac{z^{n+1}}{(n+1)^2}, \quad n \neq -1,$$

$$4.10.4 \quad \int \frac{dz}{z \ln z} = \ln(\ln z),$$

$$4.10.5 \quad \int_0^1 \frac{\ln t}{1-t} \, dt = -\frac{\pi^2}{6},$$

$$4.10.6 \quad \int_0^1 \frac{\ln t}{1+t} \, dt = -\frac{\pi^2}{12},$$

$$4.10.7 \quad \int_0^x \frac{dt}{\ln t} = \text{li}(x), \quad x > 1.$$

The left-hand side of (4.10.7) is a Cauchy principal value (§1.4(v)). For  $\text{li}(x)$  see §6.2(i).

### 4.10(ii) Exponentials

For  $a, b \neq 0$ ,

$$4.10.8 \quad \int e^{az} \, dz = \frac{e^{az}}{a},$$

$$4.10.9 \quad \int \frac{dz}{e^{az} + b} = \frac{1}{ab} (az - \ln(e^{az} + b)),$$

$$4.10.10 \quad \int \frac{e^{az} - 1}{e^{az} + 1} \, dz = \frac{2}{a} \ln(e^{az/2} + e^{-az/2}),$$

$$4.10.11 \quad \int_{-\infty}^{\infty} e^{-cx^2} \, dx = \sqrt{\frac{\pi}{c}}, \quad \Re c > 0,$$

$$4.10.12 \quad \int_0^{\ln 2} \frac{x e^x}{e^x - 1} \, dx = \frac{\pi^2}{12},$$

$$4.10.13 \quad \int_0^{\infty} \frac{dx}{e^x + 1} = \ln 2.$$

### 4.10(iii) Compendia

Extensive compendia of indefinite and definite integrals of logarithms and exponentials include Apelblat (1983, pp. 16–47), Bierens de Haan (1939), Gröbner and Hofreiter (1949, pp. 107–116), Gröbner and Hofreiter (1950, pp. 52–90), Gradshteyn and Ryzhik (2000, Chapters 2–4), and Prudnikov *et al.* (1986a, §§1.3, 1.6, 2.3, 2.6).

## 4.11 Sums

For infinite series involving logarithms and/or exponentials, see Gradshteyn and Ryzhik (2000, Chapter 1), Hansen (1975, §44), and Prudnikov *et al.* (1986a, Chapter 5).

### 4.12 Generalized Logarithms and Exponentials

A *generalized exponential function*  $\phi(x)$  satisfies the equations

$$4.12.1 \quad \phi(x+1) = e^{\phi(x)}, \quad -1 < x < \infty,$$

$$4.12.2 \quad \phi(0) = 0,$$

and is strictly increasing when  $0 \leq x \leq 1$ . Its inverse  $\psi(x)$  is called a *generalized logarithm*. It, too, is strictly increasing when  $0 \leq x \leq 1$ , and

$$4.12.3 \quad \psi(e^x) = 1 + \psi(x), \quad -\infty < x < \infty,$$

$$4.12.4 \quad \psi(0) = 0.$$

These functions are not unique. The simplest choice is given by

$$4.12.5 \quad \phi(x) = \psi(x) = x, \quad 0 \leq x \leq 1.$$

Then

$$4.12.6 \quad \phi(x) = \ln(x+1), \quad -1 < x < 0,$$

and

$$4.12.7 \quad \phi(x) = \exp \exp \cdots \exp(x - [x]), \quad x > 1,$$

where the exponentiations are carried out  $[x]$  times. Correspondingly,

$$4.12.8 \quad \psi(x) = e^x - 1, \quad -\infty < x < 0,$$

and

$$4.12.9 \quad \psi(x) = \ell + \ln^{(\ell)} x, \quad x > 1,$$

where  $\ln^{(\ell)} x$  denotes the  $\ell$ -th repeated logarithm of  $x$ , and  $\ell$  is the positive integer determined by the condition

$$4.12.10 \quad 0 \leq \ln^{(\ell)} x < 1.$$

Both  $\phi(x)$  and  $\psi(x)$  are continuously differentiable.

For further information, see Clenshaw *et al.* (1986). For  $C^\infty$  generalized logarithms, see Walker (1991). For analytic generalized logarithms, see Kneser (1950).

### 4.13 Lambert $W$ -Function

The Lambert  $W$ -function  $W(x)$  is the solution of the equation

$$4.13.1 \quad W e^W = x.$$

On the  $x$ -interval  $[0, \infty)$  there is one real solution, and it is nonnegative and increasing. On the  $x$ -interval  $(-1/e, 0)$  there are two real solutions, one increasing and the other decreasing. We call the solution for which  $W(x) \geq W(-1/e)$  the *principal branch* and denote it by  $W_p(x)$ . The other solution is denoted by  $W_m(x)$ . See Figure 4.13.1.

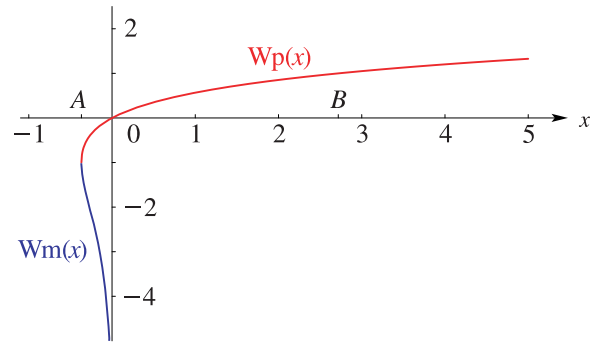


Figure 4.13.1: Branches  $W_p(x)$  and  $W_m(x)$  of the Lambert  $W$ -function.  $A$  and  $B$  denote the points  $-1/e$  and  $e$ , respectively, on the  $x$ -axis.

Properties include:

$$4.13.2 \quad W_p(-1/e) = W_m(-1/e) = -1, \\ W_p(0) = 0, \quad W_p(e) = 1.$$

$$4.13.3 \quad U + \ln U = x, \quad U = U(x) = W(e^x).$$

$$4.13.4 \quad \frac{dW}{dx} = \frac{e^{-W}}{1+W}, \quad x \neq -\frac{1}{e}.$$

$$4.13.5 \quad W_p(x) = \sum_{n=1}^{\infty} (-1)^{n-1} \frac{n^{n-2}}{(n-1)!} x^n, \quad |x| < \frac{1}{e}.$$

$$4.13.6 \quad W\left(-e^{-1-(t^2/2)}\right) = \sum_{n=0}^{\infty} (-1)^{n-1} c_n t^n, \quad |t| < 2\sqrt{\pi},$$

where  $t \geq 0$  for  $W_p$ ,  $t \leq 0$  for  $W_m$ ,

$$4.13.7 \quad c_0 = 1, c_1 = 1, c_2 = \frac{1}{3}, c_3 = \frac{1}{36}, c_4 = -\frac{1}{270},$$

$$4.13.8 \quad c_n = \frac{1}{n+1} \left( c_{n-1} - \sum_{k=2}^{n-1} k c_k c_{n+1-k} \right), \quad n \geq 2,$$

and

$$4.13.9 \quad 1 \cdot 3 \cdot 5 \cdots (2n+1) c_{2n+1} = g_n,$$

where  $g_n$  is defined in §5.11(i).

As  $x \rightarrow +\infty$

4.13.10

$$W_p(x) = \xi - \ln \xi + \frac{\ln \xi}{\xi} + \frac{(\ln \xi)^2}{2\xi^2} - \frac{\ln \xi}{\xi^2} + O\left(\frac{(\ln \xi)^3}{\xi^3}\right),$$

where  $\xi = \ln x$ . As  $x \rightarrow 0-$

4.13.11

$$W_m(x) = -\eta - \ln \eta - \frac{\ln \eta}{\eta} - \frac{(\ln \eta)^2}{2\eta^2} - \frac{\ln \eta}{\eta^2} + O\left(\frac{(\ln \eta)^3}{\eta^3}\right),$$

where  $\eta = \ln(-1/x)$ .

For the foregoing results and further information see Borwein and Corless (1999), Corless *et al.* (1996), de Bruijn (1961, pp. 25–28), Olver (1997b, pp. 12–13), and Siewert and Burniston (1973).

For integral representations of all branches of the Lambert  $W$ -function see Kheyfits (2004).



## Trigonometric Functions

### 4.14 Definitions and Periodicity

$$4.14.1 \quad \sin z = \frac{e^{iz} - e^{-iz}}{2i},$$

$$4.14.2 \quad \cos z = \frac{e^{iz} + e^{-iz}}{2},$$

$$4.14.3 \quad \cos z \pm i \sin z = e^{\pm iz},$$

$$4.14.4 \quad \tan z = \frac{\sin z}{\cos z},$$

$$4.14.5 \quad \csc z = \frac{1}{\sin z},$$

$$4.14.6 \quad \sec z = \frac{1}{\cos z},$$

$$4.14.7 \quad \cot z = \frac{\cos z}{\sin z} = \frac{1}{\tan z}.$$

The functions  $\sin z$  and  $\cos z$  are entire. In  $\mathbb{C}$  the zeros of  $\sin z$  are  $z = k\pi$ ,  $k \in \mathbb{Z}$ ; the zeros of  $\cos z$  are  $z = (k + \frac{1}{2})\pi$ ,  $k \in \mathbb{Z}$ . The functions  $\tan z$ ,  $\csc z$ ,  $\sec z$ , and  $\cot z$  are meromorphic, and the locations of their zeros and poles follow from (4.14.4) to (4.14.7).

For  $k \in \mathbb{Z}$

$$4.14.8 \quad \sin(z + 2k\pi) = \sin z,$$

$$4.14.9 \quad \cos(z + 2k\pi) = \cos z,$$

$$4.14.10 \quad \tan(z + k\pi) = \tan z.$$

### 4.15 Graphics

#### 4.15(i) Real Arguments

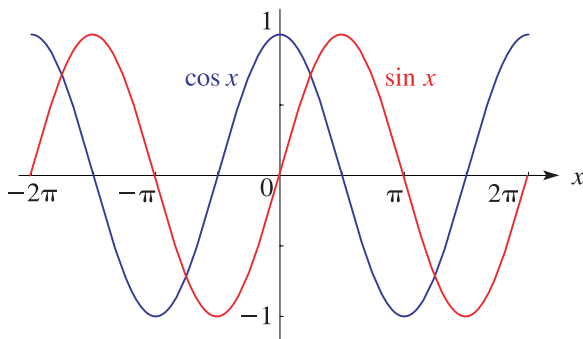


Figure 4.15.1:  $\sin x$  and  $\cos x$ .

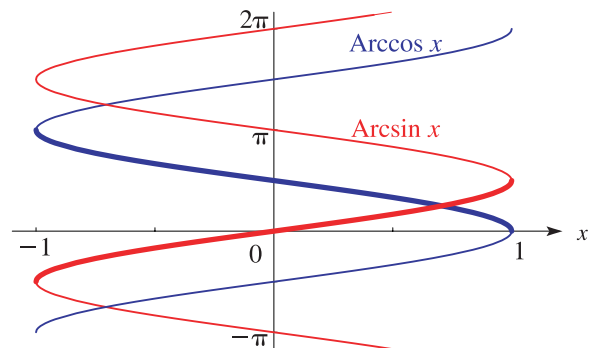


Figure 4.15.2:  $\text{Arcsin } x$  and  $\text{Arccos } x$ . Principal values are shown with thickened lines.

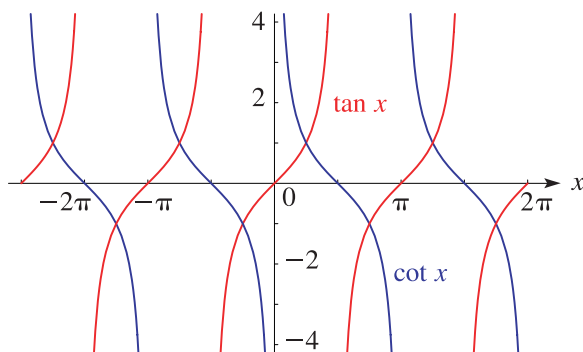


Figure 4.15.3:  $\tan x$  and  $\cot x$ .

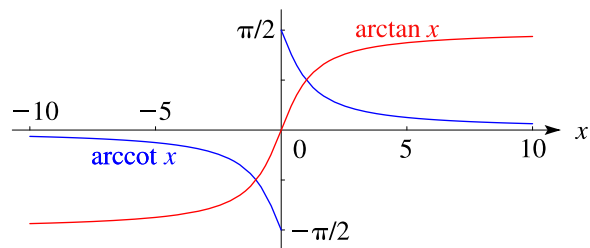


Figure 4.15.4:  $\arctan x$  and  $\text{arccot } x$ . Only principal values are shown.  $\text{arccot } x$  is discontinuous at  $x = 0$ .

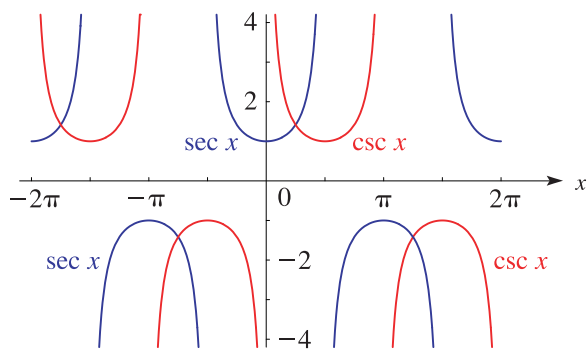


Figure 4.15.5:  $\csc x$  and  $\sec x$ .

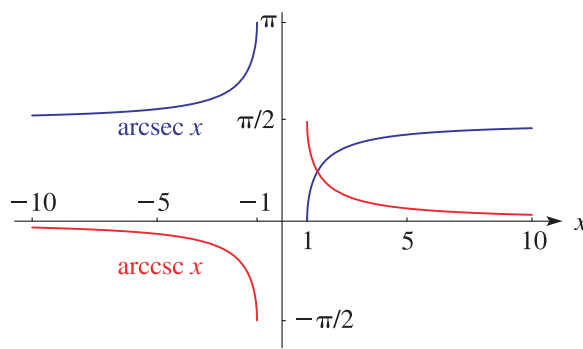
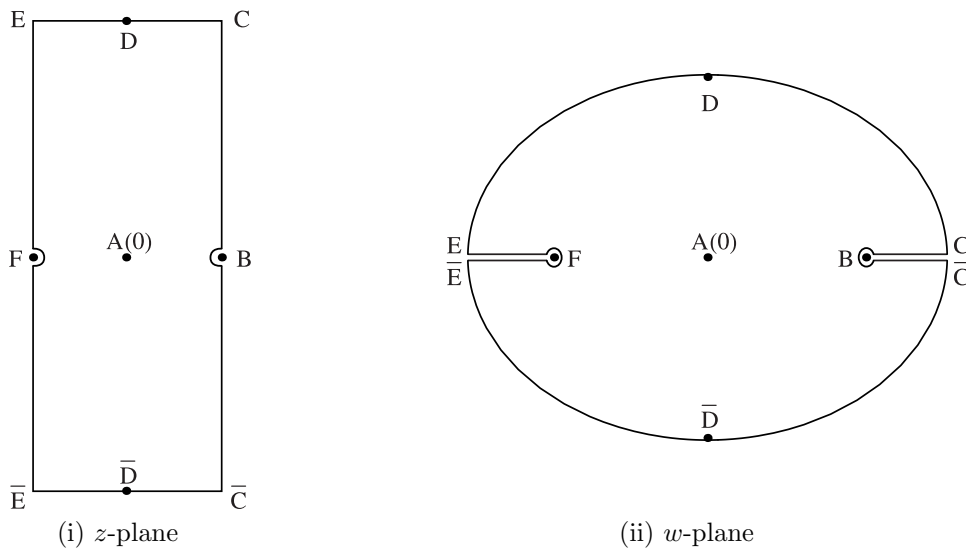


Figure 4.15.6:  $\operatorname{arccsc} x$  and  $\operatorname{arcsec} x$ . Only principal values are shown. (Both functions are complex when  $-1 < x < 1$ .)

**4.15(ii) Complex Arguments: Conformal Maps**

Figure 4.15.7 illustrates the conformal mapping of the strip  $-\frac{1}{2}\pi < \Re z < \frac{1}{2}\pi$  onto the whole  $w$ -plane cut along the real axis from  $-\infty$  to  $-1$  and  $1$  to  $\infty$ , where  $w = \sin z$  and  $z = \arcsin w$  (principal value). Corresponding points share the same letters, with bars signifying complex conjugates. Lines parallel to the real axis in the  $z$ -plane map onto ellipses in the  $w$ -plane with foci at  $w = \pm 1$ , and lines parallel to the imaginary axis in the  $z$ -plane map onto rectangular hyperbolas confocal with the ellipses. In the labeling of corresponding points  $r$  is a real parameter that can lie anywhere in the interval  $(0, \infty)$ .



	A	B	C	$\bar{C}$	D	$\bar{D}$	E	$\bar{E}$	F
$z$	0	$\frac{1}{2}\pi$	$\frac{1}{2}\pi + ir$	$\frac{1}{2}\pi - ir$	$ir$	$-ir$	$-\frac{1}{2}\pi + ir$	$-\frac{1}{2}\pi - ir$	$-\frac{1}{2}\pi$
$w$	0	1	$\cosh r + i0$	$\cosh r - i0$	$i \sinh r$	$-i \sinh r$	$-\cosh r + i0$	$-\cosh r - i0$	-1

Figure 4.15.7: Conformal mapping of sine and inverse sine.  $w = \sin z$ ,  $z = \arcsin w$ .

**4.15(iii) Complex Arguments: Surfaces**

In the graphics shown in this subsection height corresponds to the absolute value of the function and color to the phase. See also p. xiv.

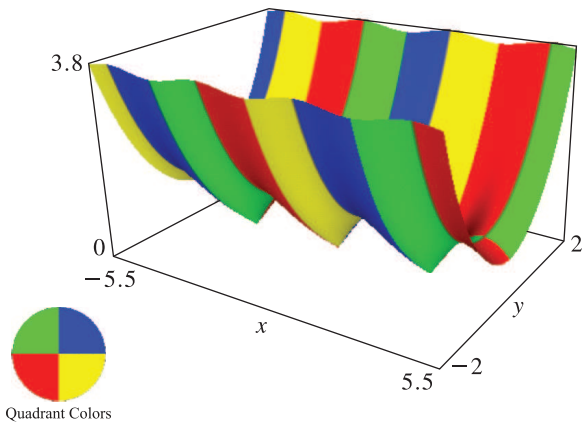


Figure 4.15.8:  $\sin(x + iy)$ .

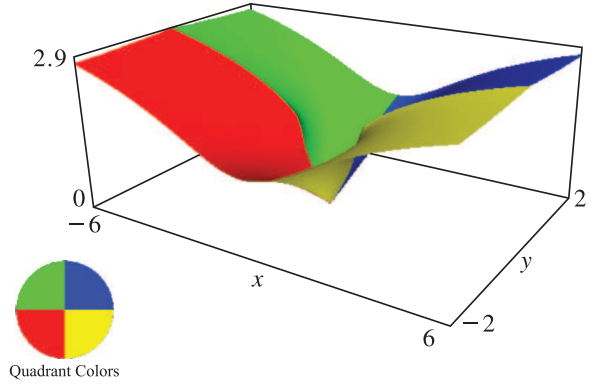


Figure 4.15.9:  $\arcsin(x + iy)$  (principal value). There are branch cuts along the real axis from  $-\infty$  to  $-1$  and  $1$  to  $\infty$ .

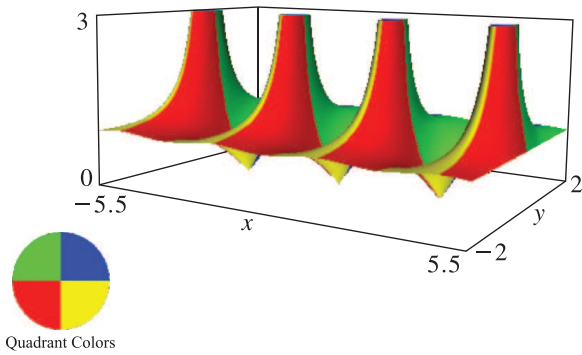


Figure 4.15.10:  $\tan(x + iy)$ .

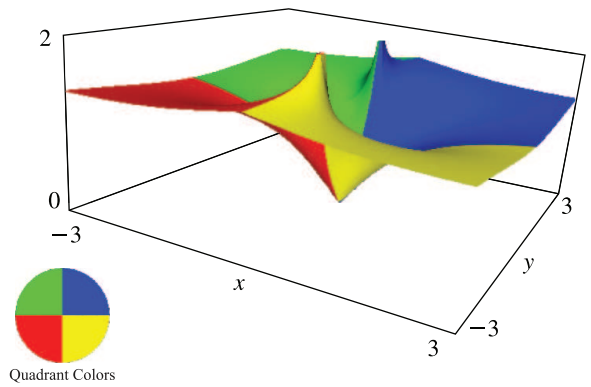


Figure 4.15.11:  $\arctan(x + iy)$  (principal value). There are branch cuts along the imaginary axis from  $-i$  and  $i$  to  $i\infty$ .

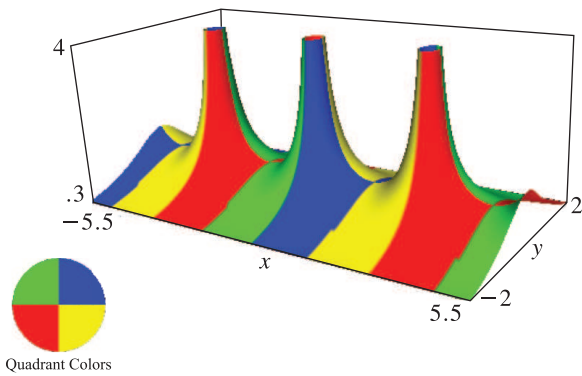


Figure 4.15.12:  $\csc(x + iy)$ .

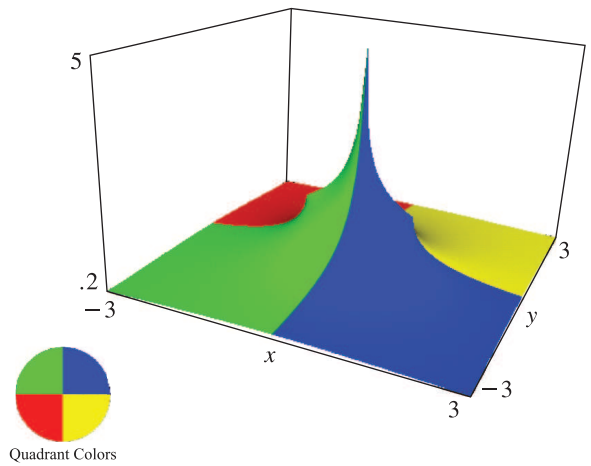


Figure 4.15.13:  $\operatorname{arccsc}(x + iy)$  (principal value). There is a branch cut along the real axis from  $-1$  to  $1$ .

The corresponding surfaces for  $\cos(x + iy)$ ,  $\cot(x + iy)$ , and  $\sec(x + iy)$  are similar. In consequence of the identities

**4.15.1**  $\cos(x + iy) = \sin(x + \frac{1}{2}\pi + iy),$

**4.15.2**  $\cot(x + iy) = -\tan(x + \frac{1}{2}\pi + iy),$

**4.15.3**  $\sec(x + iy) = \csc(x + \frac{1}{2}\pi + iy),$

they can be obtained by translating the surfaces shown in Figures 4.15.8, 4.15.10, 4.15.12 by  $-\frac{1}{2}\pi$  parallel to the  $x$ -axis, and adjusting the phase coloring in the case of Figure 4.15.10.

The corresponding surfaces for  $\arccos(x + iy)$ ,  $\operatorname{arccot}(x + iy)$ ,  $\operatorname{arcsec}(x + iy)$  can be visualized from Figures 4.15.9, 4.15.11, 4.15.13 with the aid of equations (4.23.16)–(4.23.18).

### 4.16 Elementary Properties

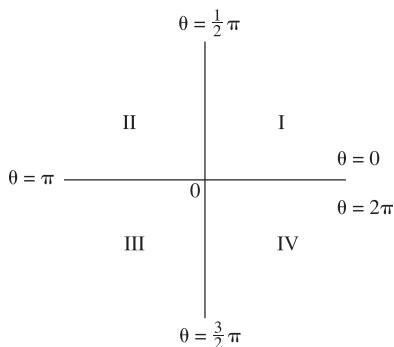


Figure 4.16.1: Quadrants for the angle  $\theta$ .

Table 4.16.1: Signs of the trigonometric functions in the four quadrants.

Quadrant	$\sin \theta, \csc \theta$	$\cos \theta, \sec \theta$	$\tan \theta, \cot \theta$
I	+	+	+
II	+	−	−
III	−	−	+
IV	−	+	−

Table 4.16.2: Trigonometric functions: quarter periods and change of sign.

$x$	$-\theta$	$\frac{1}{2}\pi \pm \theta$	$\pi \pm \theta$	$\frac{3}{2}\pi \pm \theta$	$2\pi \pm \theta$
$\sin x$	$-\sin \theta$	$\cos \theta$	$\mp \sin \theta$	$-\cos \theta$	$\pm \sin \theta$
$\cos x$	$\cos \theta$	$\mp \sin \theta$	$-\cos \theta$	$\pm \sin \theta$	$\cos \theta$
$\tan x$	$-\tan \theta$	$\mp \cot \theta$	$\pm \tan \theta$	$\mp \cot \theta$	$\pm \tan \theta$
$\csc x$	$-\csc \theta$	$\sec \theta$	$\mp \csc \theta$	$-\sec \theta$	$\pm \csc \theta$
$\sec x$	$\sec \theta$	$\mp \csc \theta$	$-\sec \theta$	$\pm \csc \theta$	$\sec \theta$
$\cot x$	$-\cot \theta$	$\mp \tan \theta$	$\pm \cot \theta$	$\mp \tan \theta$	$\pm \cot \theta$

Table 4.16.3: Trigonometric functions: interrelations. All square roots have their principal values when the functions are real, nonnegative, and finite.

	$\sin \theta = a$	$\cos \theta = a$	$\tan \theta = a$	$\csc \theta = a$	$\sec \theta = a$	$\cot \theta = a$
$\sin \theta$	$a$	$(1 - a^2)^{1/2}$	$a(1 + a^2)^{-1/2}$	$a^{-1}$	$a^{-1}(a^2 - 1)^{1/2}$	$(1 + a^2)^{-1/2}$
$\cos \theta$	$(1 - a^2)^{1/2}$	$a$	$(1 + a^2)^{-1/2}$	$a^{-1}(a^2 - 1)^{1/2}$	$a^{-1}$	$a(1 + a^2)^{-1/2}$
$\tan \theta$	$a(1 - a^2)^{-1/2}$	$a^{-1}(1 - a^2)^{1/2}$	$a$	$(a^2 - 1)^{-1/2}$	$(a^2 - 1)^{1/2}$	$a^{-1}$
$\csc \theta$	$a^{-1}$	$(1 - a^2)^{-1/2}$	$a^{-1}(1 + a^2)^{1/2}$	$a$	$a(a^2 - 1)^{-1/2}$	$(1 + a^2)^{1/2}$
$\sec \theta$	$(1 - a^2)^{-1/2}$	$a^{-1}$	$(1 + a^2)^{1/2}$	$a(a^2 - 1)^{-1/2}$	$a$	$a^{-1}(1 + a^2)^{1/2}$
$\cot \theta$	$a^{-1}(1 - a^2)^{1/2}$	$a(1 - a^2)^{-1/2}$	$a^{-1}$	$(a^2 - 1)^{1/2}$	$(a^2 - 1)^{-1/2}$	$a$

### 4.17 Special Values and Limits

Table 4.17.1: Trigonometric functions: values at multiples of  $\frac{1}{12}\pi$ .

$\theta$	$\sin \theta$	$\cos \theta$	$\tan \theta$	$\csc \theta$	$\sec \theta$	$\cot \theta$
0	0	1	0	$\infty$	1	$\infty$
$\pi/12$	$\frac{1}{4}\sqrt{2}(\sqrt{3}-1)$	$\frac{1}{4}\sqrt{2}(\sqrt{3}+1)$	$2-\sqrt{3}$	$\sqrt{2}(\sqrt{3}+1)$	$\sqrt{2}(\sqrt{3}-1)$	$2+\sqrt{3}$
$\pi/6$	$\frac{1}{2}$	$\frac{1}{2}\sqrt{3}$	$\frac{1}{3}\sqrt{3}$	2	$\frac{2}{3}\sqrt{3}$	$\sqrt{3}$
$\pi/4$	$\frac{1}{2}\sqrt{2}$	$\frac{1}{2}\sqrt{2}$	1	$\sqrt{2}$	$\sqrt{2}$	1
$\pi/3$	$\frac{1}{2}\sqrt{3}$	$\frac{1}{2}$	$\sqrt{3}$	$\frac{2}{3}\sqrt{3}$	2	$\frac{1}{3}\sqrt{3}$
$5\pi/12$	$\frac{1}{4}\sqrt{2}(\sqrt{3}+1)$	$\frac{1}{4}\sqrt{2}(\sqrt{3}-1)$	$2+\sqrt{3}$	$\sqrt{2}(\sqrt{3}-1)$	$\sqrt{2}(\sqrt{3}+1)$	$2-\sqrt{3}$
$\pi/2$	1	0	$\infty$	1	$\infty$	0
$7\pi/12$	$\frac{1}{4}\sqrt{2}(\sqrt{3}+1)$	$-\frac{1}{4}\sqrt{2}(\sqrt{3}-1)$	$-(2+\sqrt{3})$	$\sqrt{2}(\sqrt{3}-1)$	$-\sqrt{2}(\sqrt{3}+1)$	$-(2-\sqrt{3})$
$2\pi/3$	$\frac{1}{2}\sqrt{3}$	$-\frac{1}{2}$	$-\sqrt{3}$	$\frac{2}{3}\sqrt{3}$	-2	$-\frac{1}{3}\sqrt{3}$
$3\pi/4$	$\frac{1}{2}\sqrt{2}$	$-\frac{1}{2}\sqrt{2}$	-1	$\sqrt{2}$	$-\sqrt{2}$	-1
$5\pi/6$	$\frac{1}{2}$	$-\frac{1}{2}\sqrt{3}$	$-\frac{1}{3}\sqrt{3}$	2	$-\frac{2}{3}\sqrt{3}$	$-\sqrt{3}$
$11\pi/12$	$\frac{1}{4}\sqrt{2}(\sqrt{3}-1)$	$-\frac{1}{4}\sqrt{2}(\sqrt{3}+1)$	$-(2-\sqrt{3})$	$\sqrt{2}(\sqrt{3}+1)$	$-\sqrt{2}(\sqrt{3}-1)$	$-(2+\sqrt{3})$
$\pi$	0	-1	0	$\infty$	-1	$\infty$

4.17.1  $\lim_{z \rightarrow 0} \frac{\sin z}{z} = 1,$

4.17.2  $\lim_{z \rightarrow 0} \frac{\tan z}{z} = 1.$

4.17.3  $\lim_{z \rightarrow 0} \frac{1 - \cos z}{z^2} = \frac{1}{2}.$

4.18.10  $|\cos z| < 2, \quad |\sin z| \leq \frac{6}{5}|z|, \quad |z| < 1.$

For more inequalities see Mitrinović (1964, pp. 101–111), Mitrinović (1970, pp. 235–265), and Bullen (1998, pp. 250–254).

### 4.18 Inequalities

#### Jordan's Inequality

4.18.1  $\frac{2x}{\pi} \leq \sin x \leq x, \quad 0 \leq x \leq \frac{1}{2}\pi.$

4.18.2  $x \leq \tan x, \quad 0 \leq x < \frac{1}{2}\pi,$

4.18.3  $\cos x \leq \frac{\sin x}{x} \leq 1, \quad 0 \leq x \leq \pi,$

4.18.4  $\pi < \frac{\sin(\pi x)}{x(1-x)} \leq 4, \quad 0 < x < 1.$

With  $z = x + iy,$

4.18.5  $|\sinh y| \leq |\sin z| \leq \cosh y,$

4.18.6  $|\sinh y| \leq |\cos z| \leq \cosh y,$

4.18.7  $|\csc z| \leq \operatorname{csch} |y|,$

4.18.8  $|\cos z| \leq \cosh |z|,$

4.18.9  $|\sin z| \leq \sinh |z|,$

### 4.19 Maclaurin Series and Laurent Series

4.19.1  $\sin z = z - \frac{z^3}{3!} + \frac{z^5}{5!} - \frac{z^7}{7!} + \dots,$

4.19.2  $\cos z = 1 - \frac{z^2}{2!} + \frac{z^4}{4!} - \frac{z^6}{6!} + \dots.$

In (4.19.3)–(4.19.9),  $B_n$  are the Bernoulli numbers and  $E_n$  are the Euler numbers (§§24.2(i)–24.2(ii)).

4.19.3  $\tan z = z + \frac{z^3}{3} + \frac{2}{15}z^5 + \frac{17}{315}z^7 + \dots$   
 $+ \frac{(-1)^{n-1}2^{2n}(2^{2n}-1)B_{2n}}{(2n)!}z^{2n-1} + \dots,$   
 $|z| < \frac{1}{2}\pi,$

4.19.4  $\csc z = \frac{1}{z} + \frac{z}{6} + \frac{7}{360}z^3 + \frac{31}{15120}z^5 + \dots$   
 $+ \frac{(-1)^{n-1}2(2^{2n-1}-1)B_{2n}}{(2n)!}z^{2n-1} + \dots,$   
 $0 < |z| < \pi,$

$$4.19.5 \quad \sec z = 1 + \frac{z^2}{2} + \frac{5}{24}z^4 + \frac{61}{720}z^6 + \dots \\ + \frac{(-1)^n E_{2n}}{(2n)!} z^{2n} + \dots, \quad |z| < \frac{1}{2}\pi,$$

$$4.19.6 \quad \cot z = \frac{1}{z} - \frac{z}{3} - \frac{z^3}{45} - \frac{2}{945}z^5 - \dots \\ - \frac{(-1)^{n-1} 2^{2n} B_{2n}}{(2n)!} z^{2n-1} - \dots, \quad 0 < |z| < \pi,$$

$$4.19.7 \quad \ln\left(\frac{\sin z}{z}\right) = \sum_{n=1}^{\infty} \frac{(-1)^n 2^{2n-1} B_{2n}}{n(2n)!} z^{2n}, \quad |z| < \pi,$$

$$4.19.8 \quad \ln(\cos z) = \sum_{n=1}^{\infty} \frac{(-1)^n 2^{2n-1} (2^{2n} - 1) B_{2n}}{n(2n)!} z^{2n}, \quad |z| < \frac{1}{2}\pi,$$

$$4.19.9 \quad \ln\left(\frac{\tan z}{z}\right) = \sum_{n=1}^{\infty} \frac{(-1)^{n-1} 2^{2n} (2^{2n-1} - 1) B_{2n}}{n(2n)!} z^{2n}, \\ |z| < \frac{1}{2}\pi.$$

## 4.20 Derivatives and Differential Equations

$$4.20.1 \quad \frac{d}{dz} \sin z = \cos z,$$

$$4.20.2 \quad \frac{d}{dz} \cos z = -\sin z,$$

$$4.20.3 \quad \frac{d}{dz} \tan z = \sec^2 z,$$

$$4.20.4 \quad \frac{d}{dz} \csc z = -\csc z \cot z,$$

$$4.20.5 \quad \frac{d}{dz} \sec z = \sec z \tan z,$$

$$4.20.6 \quad \frac{d}{dz} \cot z = -\csc^2 z,$$

$$4.20.7 \quad \frac{d^n}{dz^n} \sin z = \sin\left(z + \frac{1}{2}n\pi\right),$$

$$4.20.8 \quad \frac{d^n}{dz^n} \cos z = \cos\left(z + \frac{1}{2}n\pi\right).$$

With  $a \neq 0$ , the general solutions of the differential equations

$$4.20.9 \quad \frac{d^2 w}{dz^2} + a^2 w = 0,$$

$$4.20.10 \quad \left(\frac{dw}{dz}\right)^2 + a^2 w^2 = 1,$$

$$4.20.11 \quad \frac{dw}{dz} - a^2 w^2 = 1,$$

are respectively

$$4.20.12 \quad w = A \cos(az) + B \sin(az),$$

$$4.20.13 \quad w = (1/a) \sin(az + c),$$

$$4.20.14 \quad w = (1/a) \tan(az + c),$$

where  $A, B, c$  are arbitrary constants.

For other differential equations see Kamke (1977, pp. 355–358 and 396–400).

## 4.21 Identities

### 4.21(i) Addition Formulas

$$4.21.1 \quad \sin u \pm \cos u = \sqrt{2} \sin\left(u \pm \frac{1}{4}\pi\right) = \sqrt{2} \cos\left(u \mp \frac{1}{4}\pi\right).$$

$$4.21.2 \quad \sin(u \pm v) = \sin u \cos v \pm \cos u \sin v,$$

$$4.21.3 \quad \cos(u \pm v) = \cos u \cos v \mp \sin u \sin v,$$

$$4.21.4 \quad \tan(u \pm v) = \frac{\tan u \pm \tan v}{1 \mp \tan u \tan v},$$

$$4.21.5 \quad \cot(u \pm v) = \frac{\pm \cot u \cot v - 1}{\cot u \pm \cot v}.$$

$$4.21.6 \quad \sin u + \sin v = 2 \sin\left(\frac{u+v}{2}\right) \cos\left(\frac{u-v}{2}\right),$$

$$4.21.7 \quad \sin u - \sin v = 2 \cos\left(\frac{u+v}{2}\right) \sin\left(\frac{u-v}{2}\right),$$

$$4.21.8 \quad \cos u + \cos v = 2 \cos\left(\frac{u+v}{2}\right) \cos\left(\frac{u-v}{2}\right),$$

$$4.21.9 \quad \cos u - \cos v = -2 \sin\left(\frac{u+v}{2}\right) \sin\left(\frac{u-v}{2}\right).$$

$$4.21.10 \quad \tan u \pm \tan v = \frac{\sin(u \pm v)}{\cos u \cos v},$$

$$4.21.11 \quad \cot u \pm \cot v = \frac{\sin(v \pm u)}{\sin u \sin v}.$$

### 4.21(ii) Squares and Products

$$4.21.12 \quad \sin^2 z + \cos^2 z = 1,$$

$$4.21.13 \quad \sec^2 z = 1 + \tan^2 z,$$

$$4.21.14 \quad \csc^2 z = 1 + \cot^2 z.$$

$$4.21.15 \quad 2 \sin u \sin v = \cos(u-v) - \cos(u+v),$$

$$4.21.16 \quad 2 \cos u \cos v = \cos(u-v) + \cos(u+v),$$

$$4.21.17 \quad 2 \sin u \cos v = \sin(u-v) + \sin(u+v).$$

$$4.21.18 \quad \sin^2 u - \sin^2 v = \sin(u+v) \sin(u-v),$$

$$4.21.19 \quad \cos^2 u - \cos^2 v = -\sin(u+v) \sin(u-v),$$

$$4.21.20 \quad \cos^2 u - \sin^2 v = \cos(u+v) \cos(u-v).$$

### 4.21(iii) Multiples of the Argument

$$4.21.21 \quad \sin \frac{z}{2} = \pm \left( \frac{1 - \cos z}{2} \right)^{1/2},$$

$$4.21.22 \quad \cos \frac{z}{2} = \pm \left( \frac{1 + \cos z}{2} \right)^{1/2},$$

$$4.21.23 \quad \tan \frac{z}{2} = \pm \left( \frac{1 - \cos z}{1 + \cos z} \right)^{1/2} = \frac{1 - \cos z}{\sin z} = \frac{\sin z}{1 + \cos z}.$$

In (4.21.21)–(4.21.23) Table 4.16.1 and analytic continuation will assist in resolving sign ambiguities.

$$4.21.24 \quad \sin(-z) = -\sin z,$$

$$4.21.25 \quad \cos(-z) = \cos z,$$

$$4.21.26 \quad \tan(-z) = -\tan z.$$

$$4.21.27 \quad \sin(2z) = 2 \sin z \cos z = \frac{2 \tan z}{1 + \tan^2 z},$$

$$4.21.28 \quad \begin{aligned} \cos(2z) &= 2 \cos^2 z - 1 = 1 - 2 \sin^2 z \\ &= \cos^2 z - \sin^2 z = \frac{1 - \tan^2 z}{1 + \tan^2 z}, \end{aligned}$$

$$4.21.29 \quad \tan(2z) = \frac{2 \tan z}{1 - \tan^2 z} = \frac{2 \cot z}{\cot^2 z - 1} = \frac{2}{\cot z - \tan z}.$$

$$4.21.30 \quad \sin(3z) = 3 \sin z - 4 \sin^3 z,$$

$$4.21.31 \quad \cos(3z) = -3 \cos z + 4 \cos^3 z,$$

$$4.21.32 \quad \sin(4z) = 8 \cos^3 z \sin z - 4 \cos z \sin z,$$

$$4.21.33 \quad \cos(4z) = 8 \cos^4 z - 8 \cos^2 z + 1.$$

#### De Moivre's Theorem

When  $n \in \mathbb{Z}$

$$4.21.34 \quad \cos(nz) + i \sin(nz) = (\cos z + i \sin z)^n.$$

This result is also valid when  $n$  is fractional or complex, provided that  $-\pi \leq \Re z \leq \pi$ .

#### 4.21.35

$$\sin(nz) = 2^{n-1} \prod_{k=0}^{n-1} \sin \left( z + \frac{k\pi}{n} \right), \quad n = 1, 2, 3, \dots$$

If  $t = \tan(\frac{1}{2}z)$ , then

#### 4.21.36

$$\sin z = \frac{2t}{1+t^2}, \quad \cos z = \frac{1-t^2}{1+t^2}, \quad dz = \frac{2}{1+t^2} dt.$$

### 4.21(iv) Real and Imaginary Parts; Moduli

With  $z = x + iy$

$$4.21.37 \quad \sin z = \sin x \cosh y + i \cos x \sinh y,$$

$$4.21.38 \quad \cos z = \cos x \cosh y - i \sin x \sinh y,$$

$$4.21.39 \quad \tan z = \frac{\sin(2x) + i \sinh(2y)}{\cos(2x) + \cosh(2y)},$$

$$4.21.40 \quad \cot z = \frac{\sin(2x) - i \sinh(2y)}{\cosh(2y) - \cos(2x)}.$$

$$4.21.41 \quad |\sin z|$$

$$= (\sin^2 x + \sinh^2 y)^{1/2} = \left( \frac{1}{2} (\cosh(2y) - \cos(2x)) \right)^{1/2},$$

$$4.21.42 \quad \begin{aligned} |\cos z| &= (\cos^2 x + \sinh^2 y)^{1/2} \\ &= \left( \frac{1}{2} (\cosh(2y) + \cos(2x)) \right)^{1/2}, \end{aligned}$$

$$4.21.43 \quad |\tan z| = \left( \frac{\cosh(2y) - \cos(2x)}{\cosh(2y) + \cos(2x)} \right)^{1/2}.$$

### 4.22 Infinite Products and Partial Fractions

$$4.22.1 \quad \sin z = z \prod_{n=1}^{\infty} \left( 1 - \frac{z^2}{n^2 \pi^2} \right),$$

$$4.22.2 \quad \cos z = \prod_{n=1}^{\infty} \left( 1 - \frac{4z^2}{(2n-1)^2 \pi^2} \right).$$

When  $z \neq n\pi$ ,  $n \in \mathbb{Z}$ ,

$$4.22.3 \quad \cot z = \frac{1}{z} + 2z \sum_{n=1}^{\infty} \frac{1}{z^2 - n^2 \pi^2},$$

$$4.22.4 \quad \csc^2 z = \sum_{n=-\infty}^{\infty} \frac{1}{(z - n\pi)^2},$$

$$4.22.5 \quad \csc z = \frac{1}{z} + 2z \sum_{n=1}^{\infty} \frac{(-1)^n}{z^2 - n^2 \pi^2}.$$

### 4.23 Inverse Trigonometric Functions

#### 4.23(i) General Definitions

The general values of the inverse trigonometric functions are defined by

$$4.23.1 \quad \operatorname{Arcsin} z = \int_0^z \frac{dt}{(1-t^2)^{1/2}},$$

$$4.23.2 \quad \operatorname{Arccos} z = \int_z^1 \frac{dt}{(1-t^2)^{1/2}},$$

$$4.23.3 \quad \operatorname{Arctan} z = \int_0^z \frac{dt}{1+t^2}, \quad z \neq \pm i,$$

$$4.23.4 \quad \operatorname{Arccsc} z = \operatorname{Arcsin}(1/z),$$

$$4.23.5 \quad \operatorname{Arcsec} z = \operatorname{Arccos}(1/z),$$

$$4.23.6 \quad \operatorname{Arccot} z = \operatorname{Arctan}(1/z).$$

In (4.23.1) and (4.23.2) the integration paths may not pass through either of the points  $t = \pm 1$ . The function  $(1 - t^2)^{1/2}$  assumes its principal value when  $t \in (-1, 1)$ ; elsewhere on the integration paths the branch is determined by continuity. In (4.23.3) the integration path may not intersect  $\pm i$ . Each of the six functions is a multivalued function of  $z$ . Arctan  $z$  and Arccot  $z$  have branch points at  $z = \pm i$ ; the other four functions have branch points at  $z = \pm 1$ .

#### 4.23(ii) Principal Values

The *principal values* (or *principal branches*) of the inverse sine, cosine, and tangent are obtained by introducing cuts in the  $z$ -plane as indicated in Figures 4.23.1(i) and 4.23.1(ii), and requiring the integration paths in (4.23.1)–(4.23.3) not to cross these cuts. Compare the

principal value of the logarithm (§4.2(i)). The principal branches are denoted by arcsin  $z$ , arccos  $z$ , arctan  $z$ , respectively. Each is two-valued on the corresponding cuts, and each is real on the part of the real axis that remains after deleting the intersections with the corresponding cuts.

The principal values of the inverse cosecant, secant, and cotangent are given by

$$4.23.7 \quad \operatorname{arccsc} z = \arcsin(1/z),$$

$$4.23.8 \quad \operatorname{arcsec} z = \arccos(1/z).$$

$$4.23.9 \quad \operatorname{arccot} z = \arctan(1/z), \quad z \neq \pm i.$$

These functions are analytic in the cut plane depicted in Figures 4.23.1(iii) and 4.23.1(iv).

*Except where indicated otherwise*, it is assumed throughout this Handbook that the inverse trigonometric functions assume their principal values.

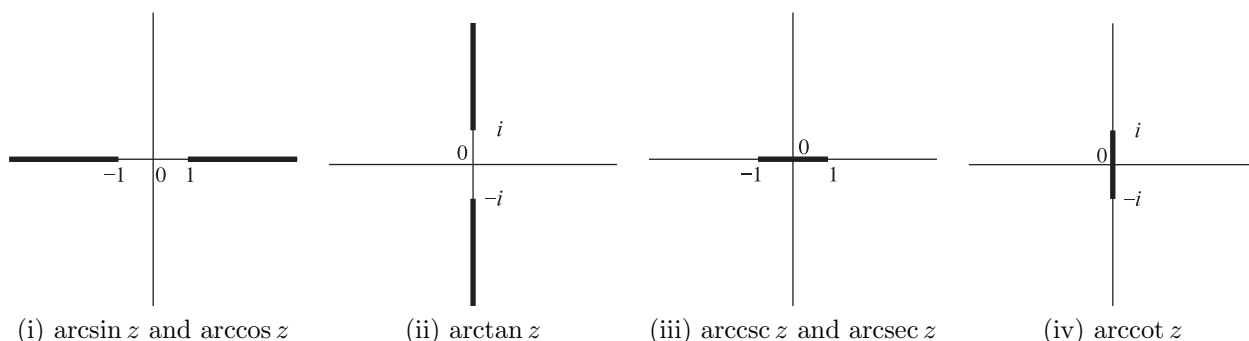


Figure 4.23.1:  $z$ -plane. Branch cuts for the inverse trigonometric functions.

Graphs of the principal values for real arguments are given in §4.15. This section also includes conformal mappings, and surface plots for complex arguments.

#### 4.23(iii) Reflection Formulas

$$4.23.10 \quad \arcsin(-z) = -\arcsin z,$$

$$4.23.11 \quad \arccos(-z) = \pi - \arccos z.$$

$$4.23.12 \quad \arctan(-z) = -\arctan z, \quad z \neq \pm i.$$

$$4.23.13 \quad \operatorname{arccsc}(-z) = -\operatorname{arccsc} z,$$

$$4.23.14 \quad \operatorname{arcsec}(-z) = \pi - \operatorname{arcsec} z.$$

$$4.23.15 \quad \operatorname{arccot}(-z) = -\operatorname{arccot} z, \quad z \neq \pm i.$$

$$4.23.16 \quad \arccos z = \frac{1}{2}\pi - \arcsin z,$$

$$4.23.17 \quad \operatorname{arcsec} z = \frac{1}{2}\pi - \operatorname{arccsc} z.$$

$$4.23.18 \quad \operatorname{arccot} z = \pm \frac{1}{2}\pi - \arctan z, \quad \Re z \geq 0.$$

#### 4.23(iv) Logarithmic Forms

Throughout this subsection *all* quantities assume their principal values.

##### Inverse Sine

$$4.23.19 \quad \arcsin z = -i \ln \left( (1 - z^2)^{1/2} + iz \right),$$

$$z \in \mathbb{C} \setminus (-\infty, -1) \cup (1, \infty);$$

compare Figure 4.23.1(i). On the cuts

$$4.23.20 \quad \arcsin x = \frac{1}{2}\pi \pm i \ln \left( (x^2 - 1)^{1/2} + x \right), \quad x \in [1, \infty),$$

$$4.23.21 \quad \arcsin x = -\frac{1}{2}\pi \pm i \ln \left( (x^2 - 1)^{1/2} - x \right),$$

$$x \in (-\infty, -1],$$



upper signs being taken on upper sides, and lower signs on lower sides.

**Inverse Cosine**

4.23.22 
$$\arccos z = \frac{1}{2}\pi + i \ln\left((1 - z^2)^{1/2} + iz\right),$$

$$z \in \mathbb{C} \setminus (-\infty, -1) \cup (1, \infty);$$

compare Figure 4.23.1(i). An equivalent definition is

4.23.23 
$$\arccos z = -2i \ln\left(\left(\frac{1+z}{2}\right)^{1/2} + i\left(\frac{1-z}{2}\right)^{1/2}\right),$$

$$z \in \mathbb{C} \setminus (-\infty, -1) \cup (1, \infty);$$

see Kahan (1987).

On the cuts

4.23.24 
$$\arccos x = \mp i \ln\left((x^2 - 1)^{1/2} + x\right), \quad x \in [1, \infty),$$

4.23.25 
$$\arccos x = \pi \mp i \ln\left((x^2 - 1)^{1/2} - x\right),$$

$$x \in (-\infty, -1],$$

the upper/lower signs corresponding to the upper/lower sides.

**Inverse Tangent**

4.23.26 
$$\arctan z = \frac{i}{2} \ln\left(\frac{i+z}{i-z}\right), \quad z/i \in \mathbb{C} \setminus (-\infty, -1] \cup [1, \infty);$$

compare Figure 4.23.1(ii). On the cuts

4.23.27 
$$\arctan(iy) = \pm \frac{1}{2}\pi + \frac{i}{2} \ln\left(\frac{y+1}{y-1}\right),$$

$$y \in (-\infty, -1) \cup (1, \infty),$$

the upper/lower sign corresponding to the right/left side.

**Other Inverse Functions**

For the corresponding results for  $\operatorname{arccsc} z$ ,  $\operatorname{arcsec} z$ , and  $\operatorname{arccot} z$ , use (4.23.7)–(4.23.9). Care needs to be taken on the cuts, for example, if  $0 < x < \infty$  then  $1/(x+i0) = (1/x) - i0$ .

**4.23(v) Fundamental Property**

With  $k \in \mathbb{Z}$ , the general solutions of the equations

4.23.28 
$$z = \sin w,$$

4.23.29 
$$z = \cos w,$$

4.23.30 
$$z = \tan w,$$

are respectively

4.23.31 
$$w = \operatorname{Arcsin} z = (-1)^k \arcsin z + k\pi,$$

4.23.32 
$$w = \operatorname{Arccos} z = \pm \arccos z + 2k\pi,$$

4.23.33 
$$w = \operatorname{Arctan} z = \arctan z + k\pi, \quad z \neq \pm i.$$

**4.23(vi) Real and Imaginary Parts**

4.23.34 
$$\arcsin z = \arcsin \beta + i \ln\left(\alpha + (\alpha^2 - 1)^{1/2}\right),$$

4.23.35 
$$\arccos z = \arccos \beta - i \ln\left(\alpha + (\alpha^2 - 1)^{1/2}\right),$$

4.23.36 
$$\arctan z = \frac{1}{2} \arctan\left(\frac{2x}{1 - x^2 - y^2}\right) + \frac{1}{4} i \ln\left(\frac{x^2 + (y+1)^2}{x^2 + (y-1)^2}\right),$$

where  $z = x + iy$  and  $x \in [-1, 1]$  in (4.23.34) and (4.23.35), and  $|z| < 1$  in (4.23.36). Also,

4.23.37 
$$\alpha = \frac{1}{2}((x+1)^2 + y^2)^{1/2} + \frac{1}{2}((x-1)^2 + y^2)^{1/2},$$

4.23.38 
$$\beta = \frac{1}{2}((x+1)^2 + y^2)^{1/2} - \frac{1}{2}((x-1)^2 + y^2)^{1/2}.$$

**4.23(vii) Special Values and Interrelations**

Table 4.23.1: Inverse trigonometric functions: principal values at 0, ±1, ±∞.

$x$	$\arcsin x$	$\arccos x$	$\arctan x$	$\operatorname{arccsc} x$	$\operatorname{arcsec} x$	$\operatorname{arccot} x$
$-\infty$	–	–	$-\frac{1}{2}\pi$	0	$\frac{1}{2}\pi$	0
$-1$	$-\frac{1}{2}\pi$	$\pi$	$-\frac{1}{4}\pi$	$-\frac{1}{2}\pi$	$\pi$	$-\frac{1}{4}\pi$
0	0	$\frac{1}{2}\pi$	0	–	–	$\mp \frac{1}{2}\pi$
1	$\frac{1}{2}\pi$	0	$\frac{1}{4}\pi$	$\frac{1}{2}\pi$	0	$\frac{1}{4}\pi$
$\infty$	–	–	$\frac{1}{2}\pi$	0	$\frac{1}{2}\pi$	0

For interrelations see Table 4.16.3. For example, from the heading and last entry in the penultimate column we have  $\operatorname{arcsec} a = \operatorname{arccot}((a^2 - 1)^{-1/2})$ .

#### 4.23(viii) Gudermannian Function

The *Gudermannian*  $\operatorname{gd}(x)$  is defined by

$$4.23.39 \quad \operatorname{gd}(x) = \int_0^x \operatorname{sech} t \, dt, \quad -\infty < x < \infty.$$

Equivalently,

$$\begin{aligned} \operatorname{gd}(x) &= 2 \arctan(e^x) - \frac{1}{2}\pi \\ 4.23.40 \quad &= \arcsin(\tanh x) = \operatorname{arccsc}(\coth x) \\ &= \arccos(\operatorname{sech} x) = \operatorname{arcsec}(\cosh x) \\ &= \arctan(\sinh x) = \operatorname{arccot}(\operatorname{csch} x). \end{aligned}$$

The inverse Gudermannian function is given by

$$4.23.41 \quad \operatorname{gd}^{-1}(x) = \int_0^x \sec t \, dt, \quad -\frac{1}{2}\pi < x < \frac{1}{2}\pi.$$

Equivalently, and again when  $-\frac{1}{2}\pi < x < \frac{1}{2}\pi$ ,

$$\begin{aligned} \operatorname{gd}^{-1}(x) &= \ln \tan\left(\frac{1}{2}x + \frac{1}{4}\pi\right) = \ln(\sec x + \tan x) \\ 4.23.42 \quad &= \operatorname{arsinh}(\tan x) = \operatorname{arcsch}(\cot x) \\ &= \operatorname{arcosh}(\sec x) = \operatorname{arsech}(\cos x) \\ &= \operatorname{artanh}(\sin x) = \operatorname{arcoth}(\csc x). \end{aligned}$$

### 4.24 Inverse Trigonometric Functions: Further Properties

#### 4.24(i) Power Series

$$4.24.1 \quad \arcsin z = z + \frac{1}{2} \frac{z^3}{3} + \frac{1 \cdot 3}{2 \cdot 4} \frac{z^5}{5} + \frac{1 \cdot 3 \cdot 5}{2 \cdot 4 \cdot 6} \frac{z^7}{7} + \cdots, \quad |z| \leq 1.$$

$$\begin{aligned} 4.24.2 \quad \arccos z &= (2(1 - z^2))^{1/2} \\ &\times \left( 1 + \sum_{n=1}^{\infty} \frac{1 \cdot 3 \cdot 5 \cdots (2n-1)}{2^{2n} (2n+1)n!} (1 - z^2)^n \right), \\ &|1 - z| \leq 2. \end{aligned}$$

$$4.24.3 \quad \arctan z = z - \frac{z^3}{3} + \frac{z^5}{5} - \frac{z^7}{7} + \cdots, \quad |z| \leq 1, \quad z \neq \pm i.$$

$$4.24.4 \quad \operatorname{arctan} z = \pm \frac{\pi}{2} - \frac{1}{z} + \frac{1}{3z^3} - \frac{1}{5z^5} + \cdots, \quad \Re z \geq 0, \quad |z| \geq 1.$$

$$\begin{aligned} 4.24.5 \quad \operatorname{arctan} z &= \frac{z}{z^2 + 1} \\ &\times \left( 1 + \frac{2}{3} \frac{z^2}{1 + z^2} + \frac{2 \cdot 4}{3 \cdot 5} \left( \frac{z^2}{1 + z^2} \right)^2 + \cdots \right), \\ &\Re(z^2) > -\frac{1}{2}, \end{aligned}$$

which requires  $z (= x + iy)$  to lie between the two rectangular hyperbolas given by

$$4.24.6 \quad x^2 - y^2 = -\frac{1}{2}.$$

#### 4.24(ii) Derivatives

$$4.24.7 \quad \frac{d}{dz} \arcsin z = (1 - z^2)^{-1/2},$$

$$4.24.8 \quad \frac{d}{dz} \arccos z = -(1 - z^2)^{-1/2},$$

$$4.24.9 \quad \frac{d}{dz} \arctan z = \frac{1}{1 + z^2},$$

$$4.24.10 \quad \frac{d}{dz} \operatorname{arccsc} z = \mp \frac{1}{z(z^2 - 1)^{1/2}}, \quad \Re z \geq 0.$$

$$4.24.11 \quad \frac{d}{dz} \operatorname{arcsec} z = \pm \frac{1}{z(z^2 - 1)^{1/2}}, \quad \Re z \geq 0.$$

$$4.24.12 \quad \frac{d}{dz} \operatorname{arccot} z = -\frac{1}{1 + z^2}.$$

#### 4.24(iii) Addition Formulas

$$\begin{aligned} &\operatorname{Arcsin} u \pm \operatorname{Arcsin} v \\ 4.24.13 \quad &= \operatorname{Arcsin}\left(u(1 - v^2)^{1/2} \pm v(1 - u^2)^{1/2}\right), \end{aligned}$$

$$\begin{aligned} &\operatorname{Arccos} u \pm \operatorname{Arccos} v \\ 4.24.14 \quad &= \operatorname{Arccos}\left(uv \mp ((1 - u^2)(1 - v^2))^{1/2}\right), \end{aligned}$$

$$4.24.15 \quad \operatorname{Arctan} u \pm \operatorname{Arctan} v = \operatorname{Arctan}\left(\frac{u \pm v}{1 \mp uv}\right),$$

$$\begin{aligned} &\operatorname{Arcsin} u \pm \operatorname{Arccos} v \\ 4.24.16 \quad &= \operatorname{Arcsin}\left(uv \pm ((1 - u^2)(1 - v^2))^{1/2}\right) \\ &= \operatorname{Arccos}\left(v(1 - u^2)^{1/2} \mp u(1 - v^2)^{1/2}\right), \end{aligned}$$

$$\begin{aligned} &\operatorname{Arctan} u \pm \operatorname{Arccot} v = \operatorname{Arctan}\left(\frac{uv \pm 1}{v \mp u}\right) \\ 4.24.17 \quad &= \operatorname{Arccot}\left(\frac{v \mp u}{uv \pm 1}\right). \end{aligned}$$

The above equations are interpreted in the sense that every value of the left-hand side is a value of the right-hand side and vice versa. All square roots have either possible value.

### 4.25 Continued Fractions

$$4.25.1 \quad \tan z = \frac{z}{1 - \frac{z^2}{3 - \frac{z^2}{5 - \frac{z^2}{7 - \cdots}}}}, \quad z \neq \pm \frac{1}{2}\pi, \pm \frac{3}{2}\pi, \dots$$

$$4.25.2 \quad \tan(az) = \frac{a \tan z}{1 +} \frac{(1 - a^2) \tan^2 z}{3 +} \frac{(4 - a^2) \tan^2 z}{5 +} \frac{(9 - a^2) \tan^2 z}{7 +} \cdots, \quad |\Re z| < \frac{1}{2}\pi, \quad az \neq \pm \frac{1}{2}\pi, \pm \frac{3}{2}\pi, \dots$$

$$4.25.3 \quad \frac{\arcsin z}{\sqrt{1 - z^2}} = \frac{z}{1 -} \frac{1 \cdot 2z^2}{3 -} \frac{1 \cdot 2z^2}{5 -} \frac{3 \cdot 4z^2}{7 -} \frac{3 \cdot 4z^2}{9 -} \cdots,$$

valid when  $z$  lies in the open cut plane shown in Figure 4.23.1(i).

$$4.25.4 \quad \arctan z = \frac{z}{1 +} \frac{z^2}{3 +} \frac{4z^2}{5 +} \frac{9z^2}{7 +} \frac{16z^2}{9 +} \cdots,$$

valid when  $z$  lies in the open cut plane shown in Figure 4.23.1(ii).

$$4.25.5 \quad e^{2a \arctan(1/z)} = 1 + \frac{2a}{z - a +} \frac{a^2 + 1}{3z +} \frac{a^2 + 4}{5z +} \frac{a^2 + 9}{7z +} \cdots,$$

valid when  $z$  lies in the open cut plane shown in Figure 4.23.1(iv).

See Lorentzen and Waadeland (1992, pp. 560–571) for other continued fractions involving inverse trigonometric functions. See also Cuyt *et al.* (2008, pp. 201–203, 205–210).

## 4.26 Integrals

### 4.26(i) Introduction

Throughout this section the variables are assumed to be real. The results in §§4.26(ii) and 4.26(iv) can be extended to the complex plane by using continuous branches and avoiding singularities.

### 4.26(ii) Indefinite Integrals

$$4.26.1 \quad \int \sin x \, dx = -\cos x,$$

$$4.26.2 \quad \int \cos x \, dx = \sin x.$$

$$4.26.3 \quad \int \tan x \, dx = -\ln(\cos x), \quad -\frac{1}{2}\pi < x < \frac{1}{2}\pi.$$

$$4.26.4 \quad \int \csc x \, dx = \ln(\tan \frac{1}{2}x), \quad 0 < x < \pi.$$

$$4.26.5 \quad \int \sec x \, dx = \operatorname{gd}^{-1}(x), \quad -\frac{1}{2}\pi < x < \frac{1}{2}\pi.$$

For the right-hand side see (4.23.41) and (4.23.42).

$$4.26.6 \quad \int \cot x \, dx = \ln(\sin x), \quad 0 < x < \pi.$$

$$4.26.7 \quad \int e^{ax} \sin(bx) \, dx = \frac{e^{ax}}{a^2 + b^2} (a \sin(bx) - b \cos(bx)),$$

$$4.26.8 \quad \int e^{ax} \cos(bx) \, dx = \frac{e^{ax}}{a^2 + b^2} (a \cos(bx) + b \sin(bx)).$$

### 4.26(iii) Definite Integrals

Throughout this subsection  $m$  and  $n$  are integers.

#### Orthogonality Properties

$$4.26.9 \quad \int_0^\pi \sin(mt) \sin(nt) \, dt = 0, \quad m \neq n,$$

$$4.26.10 \quad \int_0^\pi \cos(mt) \cos(nt) \, dt = 0, \quad m \neq n,$$

$$4.26.11 \quad \int_0^\pi \sin^2(nt) \, dt = \int_0^\pi \cos^2(nt) \, dt = \frac{1}{2}\pi, \quad n \neq 0.$$

$$4.26.12 \quad \int_0^\infty \frac{\sin(mt)}{t} \, dt = \begin{cases} \frac{1}{2}\pi, & m > 0, \\ 0, & m = 0, \\ -\frac{1}{2}\pi, & m < 0. \end{cases}$$

$$4.26.13 \quad \int_0^\infty \sin(t^2) \, dt = \int_0^\infty \cos(t^2) \, dt = \frac{1}{2}\sqrt{\frac{\pi}{2}}.$$

### 4.26(iv) Inverse Trigonometric Functions

$$4.26.14 \quad \int \arcsin x \, dx = x \arcsin x + (1 - x^2)^{1/2}, \quad -1 < x < 1,$$

$$4.26.15 \quad \int \arccos x \, dx = x \arccos x - (1 - x^2)^{1/2}, \quad -1 < x < 1.$$

$$4.26.16 \quad \int \arctan x \, dx = x \arctan x - \frac{1}{2} \ln(1 + x^2), \\ -\infty < x < \infty,$$

$$4.26.17 \quad \int \operatorname{arccsc} x \, dx = x \operatorname{arccsc} x + \ln(x + (x^2 - 1)^{1/2}), \\ 1 < x < \infty,$$

$$4.26.18 \quad \int \operatorname{arcsec} x \, dx = x \operatorname{arcsec} x - \ln(x + (x^2 - 1)^{1/2}), \\ 1 < x < \infty,$$

$$4.26.19 \quad \int \operatorname{arccot} x \, dx = x \operatorname{arccot} x + \frac{1}{2} \ln(1 + x^2), \quad 0 < x < \infty.$$

$$4.26.20 \quad \int x \arcsin x \, dx = \left(\frac{x^2}{2} - \frac{1}{4}\right) \arcsin x + \frac{x}{4} (1 - x^2)^{1/2}, \\ -1 < x < 1,$$

$$4.26.21 \quad \int x \arccos x \, dx = \left(\frac{x^2}{2} - \frac{1}{4}\right) \arccos x - \frac{x}{4} (1 - x^2)^{1/2}, \\ -1 < x < 1.$$

### 4.26(v) Compendia

Extensive compendia of indefinite and definite integrals of trigonometric and inverse trigonometric functions include Apelblat (1983, pp. 48–109), Bierens de Haan (1939), Gradshteyn and Ryzhik (2000, Chapters 2–4), Gröbner and Hofreiter (1949, pp. 116–139), Gröbner and Hofreiter (1950, pp. 94–160), and Prudnikov *et al.* (1986a, §§1.5, 1.7, 2.5, 2.7).

### 4.27 Sums

For sums of trigonometric and inverse trigonometric functions see Gradshteyn and Ryzhik (2000, Chapter 1), Hansen (1975, §§14–42), Oberhettinger (1973), and Prudnikov *et al.* (1986a, Chapter 5).

## Hyperbolic Functions

### 4.28 Definitions and Periodicity

$$4.28.1 \quad \sinh z = \frac{e^z - e^{-z}}{2},$$

$$4.28.2 \quad \cosh z = \frac{e^z + e^{-z}}{2},$$

$$4.28.3 \quad \cosh z \pm \sinh z = e^{\pm z},$$

$$4.28.4 \quad \tanh z = \frac{\sinh z}{\cosh z},$$

$$4.28.5 \quad \operatorname{csch} z = \frac{1}{\sinh z},$$

$$4.28.6 \quad \operatorname{sech} z = \frac{1}{\cosh z},$$

$$4.28.7 \quad \operatorname{coth} z = \frac{1}{\tanh z}.$$

#### Relations to Trigonometric Functions

$$4.28.8 \quad \sin(iz) = i \sinh z,$$

$$4.28.9 \quad \cos(iz) = \cosh z,$$

$$4.28.10 \quad \tan(iz) = i \tanh z,$$

$$4.28.11 \quad \operatorname{csc}(iz) = -i \operatorname{csch} z,$$

$$4.28.12 \quad \operatorname{sec}(iz) = \operatorname{sech} z,$$

$$4.28.13 \quad \operatorname{cot}(iz) = -i \operatorname{coth} z.$$

As a consequence, many properties of the hyperbolic functions follow immediately from the corresponding properties of the trigonometric functions.

#### Periodicity and Zeros

The functions  $\sinh z$  and  $\cosh z$  have period  $2\pi i$ , and  $\tanh z$  has period  $\pi i$ . The zeros of  $\sinh z$  and  $\cosh z$  are  $z = ik\pi$  and  $z = i(k + \frac{1}{2})\pi$ , respectively,  $k \in \mathbb{Z}$ .

### 4.29 Graphics

#### 4.29(i) Real Arguments

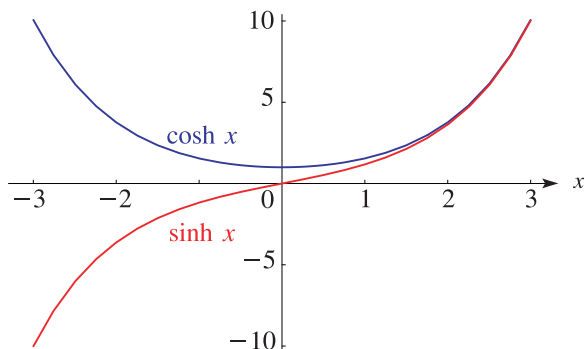


Figure 4.29.1:  $\sinh x$  and  $\cosh x$ .

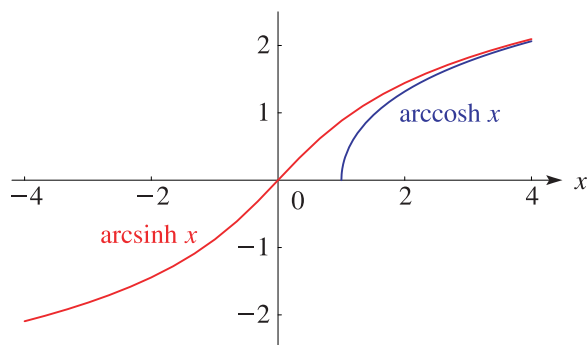


Figure 4.29.2: Principal values of  $\operatorname{arcsinh} x$  and  $\operatorname{arccosh} x$ . ( $\operatorname{arccosh} x$  is complex when  $x < 1$ .)

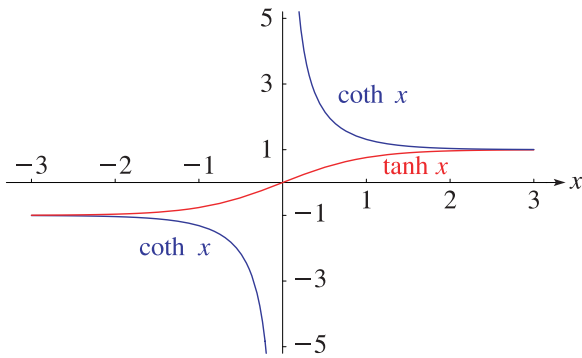


Figure 4.29.3:  $\tanh x$  and  $\coth x$ .

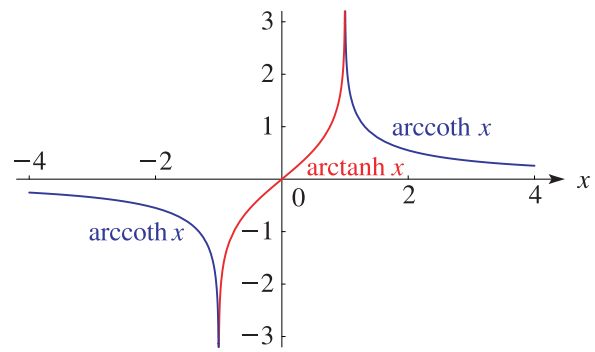


Figure 4.29.4: Principal values of  $\operatorname{arctanh} x$  and  $\operatorname{arcoth} x$ . ( $\operatorname{arctanh} x$  is complex when  $x < -1$  or  $x > 1$ , and  $\operatorname{arcoth} x$  is complex when  $-1 < x < 1$ .)

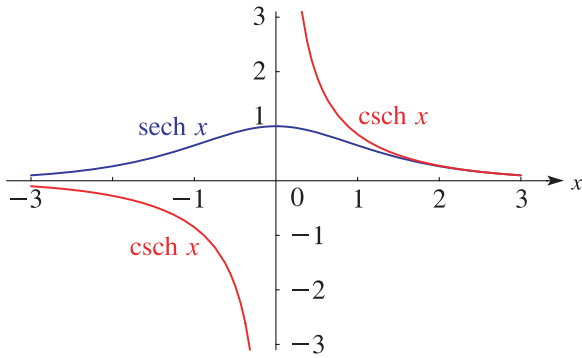


Figure 4.29.5:  $\operatorname{csch} x$  and  $\operatorname{sech} x$ .

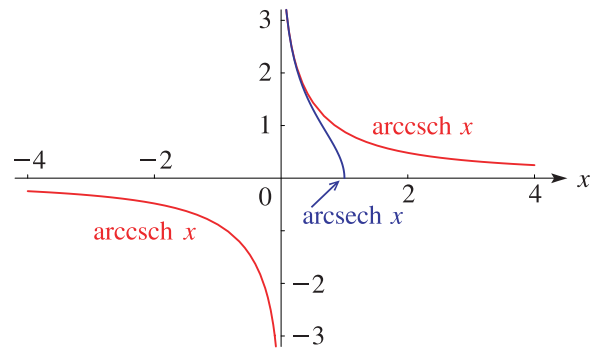


Figure 4.29.6: Principal values of  $\operatorname{arcsch} x$  and  $\operatorname{arcsech} x$ . ( $\operatorname{arcsech} x$  is complex when  $x < 0$  and  $x > 1$ .)

### 4.29(ii) Complex Arguments

The conformal mapping  $w = \sinh z$  is obtainable from Figure 4.15.7 by rotating both the  $w$ -plane and the  $z$ -plane through an angle  $\frac{1}{2}\pi$ , compare (4.28.8).

The surfaces for the complex hyperbolic and inverse hyperbolic functions are similar to the surfaces depicted in §4.15(iii) for the trigonometric and inverse trigonometric functions. They can be visualized with the aid of equations (4.28.8)–(4.28.13).

### 4.30 Elementary Properties

Table 4.30.1: Hyperbolic functions: interrelations. All square roots have their principal values when the functions are real, nonnegative, and finite.

	$\sinh \theta = a$	$\cosh \theta = a$	$\tanh \theta = a$	$\operatorname{csch} \theta = a$	$\operatorname{sech} \theta = a$	$\operatorname{coth} \theta = a$
$\sinh \theta$	$a$	$(a^2 - 1)^{1/2}$	$a(1 - a^2)^{-1/2}$	$a^{-1}$	$a^{-1}(1 - a^2)^{1/2}$	$(a^2 - 1)^{-1/2}$
$\cosh \theta$	$(1 + a^2)^{1/2}$	$a$	$(1 - a^2)^{-1/2}$	$a^{-1}(1 + a^2)^{1/2}$	$a^{-1}$	$a(a^2 - 1)^{-1/2}$
$\tanh \theta$	$a(1 + a^2)^{-1/2}$	$a^{-1}(a^2 - 1)^{1/2}$	$a$	$(1 + a^2)^{-1/2}$	$(1 - a^2)^{1/2}$	$a^{-1}$
$\operatorname{csch} \theta$	$a^{-1}$	$(a^2 - 1)^{-1/2}$	$a^{-1}(1 - a^2)^{1/2}$	$a$	$a(1 - a^2)^{-1/2}$	$(a^2 - 1)^{1/2}$
$\operatorname{sech} \theta$	$(1 + a^2)^{-1/2}$	$a^{-1}$	$(1 - a^2)^{1/2}$	$a(1 + a^2)^{-1/2}$	$a$	$a^{-1}(a^2 - 1)^{1/2}$
$\operatorname{coth} \theta$	$a^{-1}(a^2 + 1)^{1/2}$	$a(a^2 - 1)^{-1/2}$	$a^{-1}$	$(1 + a^2)^{1/2}$	$(1 - a^2)^{-1/2}$	$a$

### 4.31 Special Values and Limits

Table 4.31.1: Hyperbolic functions: values at multiples of  $\frac{1}{2}\pi i$ .

$z$	0	$\frac{1}{2}\pi i$	$\pi i$	$\frac{3}{2}\pi i$	$\infty$
$\sinh z$	0	$i$	0	$-i$	$\infty$
$\cosh z$	1	0	$-1$	0	$\infty$
$\tanh z$	0	$\infty i$	0	$-\infty i$	1
$\operatorname{csch} z$	$\infty$	$-i$	$\infty$	$i$	0
$\operatorname{sech} z$	1	$\infty$	$-1$	$\infty$	0
$\operatorname{coth} z$	$\infty$	0	$\infty$	0	1

$$4.31.1 \quad \lim_{z \rightarrow 0} \frac{\sinh z}{z} = 1,$$

$$4.31.2 \quad \lim_{z \rightarrow 0} \frac{\tanh z}{z} = 1,$$

$$4.31.3 \quad \lim_{z \rightarrow 0} \frac{\cosh z - 1}{z^2} = \frac{1}{2}.$$

### 4.32 Inequalities

For  $x$  real,

$$4.32.1 \quad \cosh x \leq \left(\frac{\sinh x}{x}\right)^3,$$

$$4.32.2 \quad \sin x \cos x < \tanh x < x, \quad x > 0,$$

$$4.32.3 \quad |\cosh x - \cosh y| \geq |x - y| \sqrt{\sinh x \sinh y}, \quad x > 0, y > 0,$$

$$4.32.4 \quad \arctan x \leq \frac{1}{2}\pi \tanh x, \quad x \geq 0.$$

For these and other inequalities involving hyperbolic functions see Mitrinović (1964, pp. 61, 76, 159) and Mitrinović (1970, p. 270).

### 4.33 Maclaurin Series and Laurent Series

$$4.33.1 \quad \sinh z = z + \frac{z^3}{3!} + \frac{z^5}{5!} + \cdots,$$

$$4.33.2 \quad \cosh z = 1 + \frac{z^2}{2!} + \frac{z^4}{4!} + \cdots.$$

$$4.33.3 \quad \tanh z = z - \frac{z^3}{3} + \frac{2}{15}z^5 - \frac{17}{315}z^7 + \cdots \\ + \frac{2^{2n}(2^{2n} - 1)B_{2n}}{(2n)!}z^{2n-1} + \cdots,$$

$$|z| < \frac{1}{2}\pi.$$

For  $B_{2n}$  see §24.2(i). For expansions that correspond to (4.19.4)–(4.19.9), change  $z$  to  $iz$  and use (4.28.8)–(4.28.13).

### 4.34 Derivatives and Differential Equations

$$4.34.1 \quad \frac{d}{dz} \sinh z = \cosh z,$$

$$4.34.2 \quad \frac{d}{dz} \cosh z = \sinh z,$$

$$4.34.3 \quad \frac{d}{dz} \tanh z = \operatorname{sech}^2 z,$$

$$4.34.4 \quad \frac{d}{dz} \operatorname{csch} z = -\operatorname{csch} z \coth z,$$

$$4.34.5 \quad \frac{d}{dz} \operatorname{sech} z = -\operatorname{sech} z \tanh z,$$

$$4.34.6 \quad \frac{d}{dz} \operatorname{coth} z = -\operatorname{csch}^2 z.$$

With  $a \neq 0$ , the general solutions of the differential equations

$$4.34.7 \quad \frac{d^2 w}{dz^2} - a^2 w = 0,$$

$$4.34.8 \quad \left(\frac{dw}{dz}\right)^2 - a^2 w^2 = 1,$$

$$4.34.9 \quad \left(\frac{dw}{dz}\right)^2 - a^2 w^2 = -1,$$

$$4.34.10 \quad \frac{dw}{dz} + a^2 w^2 = 1,$$

are respectively

$$4.34.11 \quad w = A \cosh(az) + B \sinh(az),$$

$$4.34.12 \quad w = (1/a) \sinh(az + c),$$

$$4.34.13 \quad w = (1/a) \cosh(az + c),$$

$$4.34.14 \quad w = (1/a) \coth(az + c),$$

where  $A, B, c$  are arbitrary constants.

For other differential equations see Kamke (1977, pp. 289–400).

### 4.35 Identities

#### 4.35(i) Addition Formulas

$$4.35.1 \quad \sinh(u \pm v) = \sinh u \cosh v \pm \cosh u \sinh v,$$

$$4.35.2 \quad \cosh(u \pm v) = \cosh u \cosh v \pm \sinh u \sinh v,$$

$$4.35.3 \quad \tanh(u \pm v) = \frac{\tanh u \pm \tanh v}{1 \pm \tanh u \tanh v},$$

$$4.35.4 \quad \coth(u \pm v) = \frac{\pm \coth u \coth v + 1}{\coth u \pm \coth v}.$$

$$4.35.5 \quad \sinh u + \sinh v = 2 \sinh\left(\frac{u+v}{2}\right) \cosh\left(\frac{u-v}{2}\right),$$

$$4.35.6 \quad \sinh u - \sinh v = 2 \cosh\left(\frac{u+v}{2}\right) \sinh\left(\frac{u-v}{2}\right),$$

$$4.35.7 \quad \cosh u + \cosh v = 2 \cosh\left(\frac{u+v}{2}\right) \cosh\left(\frac{u-v}{2}\right),$$

$$4.35.8 \quad \cosh u - \cosh v = 2 \sinh\left(\frac{u+v}{2}\right) \sinh\left(\frac{u-v}{2}\right),$$

$$4.35.9 \quad \tanh u \pm \tanh v = \frac{\sinh(u \pm v)}{\cosh u \cosh v},$$

$$4.35.10 \quad \coth u \pm \coth v = \frac{\sinh(v \pm u)}{\sinh u \sinh v}.$$

### 4.35(ii) Squares and Products

$$4.35.11 \quad \cosh^2 z - \sinh^2 z = 1,$$

$$4.35.12 \quad \operatorname{sech}^2 z = 1 - \tanh^2 z,$$

$$4.35.13 \quad \operatorname{csch}^2 z = \coth^2 z - 1.$$

$$4.35.14 \quad 2 \sinh u \sinh v = \cosh(u+v) - \cosh(u-v),$$

$$4.35.15 \quad 2 \cosh u \cosh v = \cosh(u+v) + \cosh(u-v),$$

$$4.35.16 \quad 2 \sinh u \cosh v = \sinh(u+v) + \sinh(u-v).$$

$$4.35.17 \quad \sinh^2 u - \sinh^2 v = \sinh(u+v) \sinh(u-v),$$

$$4.35.18 \quad \cosh^2 u - \cosh^2 v = \sinh(u+v) \sinh(u-v),$$

$$4.35.19 \quad \sinh^2 u + \cosh^2 v = \cosh(u+v) \cosh(u-v).$$

### 4.35(iii) Multiples of the Argument

$$4.35.20 \quad \sinh \frac{z}{2} = \left(\frac{\cosh z - 1}{2}\right)^{1/2},$$

$$4.35.21 \quad \cosh \frac{z}{2} = \left(\frac{\cosh z + 1}{2}\right)^{1/2},$$

$$4.35.22 \quad \tanh \frac{z}{2} = \left(\frac{\cosh z - 1}{\cosh z + 1}\right)^{1/2} = \frac{\cosh z - 1}{\sinh z} = \frac{\sinh z}{\cosh z + 1}.$$

The square roots assume their principal value on the positive real axis, and are determined by continuity elsewhere.

$$4.35.23 \quad \sinh(-z) = -\sinh z,$$

$$4.35.24 \quad \cosh(-z) = \cosh z,$$

$$4.35.25 \quad \tanh(-z) = -\tanh z.$$

$$4.35.26 \quad \sinh(2z) = 2 \sinh z \cosh z = \frac{2 \tanh z}{1 - \tanh^2 z},$$

$$4.35.27 \quad \cosh(2z) = 2 \cosh^2 z - 1 = 2 \sinh^2 z + 1 \\ = \cosh^2 z + \sinh^2 z,$$

$$4.35.28 \quad \tanh(2z) = \frac{2 \tanh z}{1 + \tanh^2 z},$$

$$4.35.29 \quad \sinh(3z) = 3 \sinh z + 4 \sinh^3 z,$$

$$4.35.30 \quad \cosh(3z) = -3 \cosh z + 4 \cosh^3 z,$$

$$4.35.31 \quad \sinh(4z) = 4 \sinh^3 z \cosh z + 4 \cosh^3 z \sinh z,$$

$$4.35.32 \quad \cosh(4z) = \cosh^4 z + 6 \sinh^2 z \cosh^2 z + \sinh^4 z.$$

$$4.35.33 \quad \cosh(nz) \pm \sinh(nz) = (\cosh z \pm \sinh z)^n, \quad n \in \mathbb{Z}.$$

### 4.35(iv) Real and Imaginary Parts; Moduli

With  $z = x + iy$

$$4.35.34 \quad \sinh z = \sinh x \cos y + i \cosh x \sin y,$$

$$4.35.35 \quad \cosh z = \cosh x \cos y + i \sinh x \sin y,$$

$$4.35.36 \quad \tanh z = \frac{\sinh(2x) + i \sin(2y)}{\cosh(2x) + \cos(2y)},$$

$$4.35.37 \quad \coth z = \frac{\sinh(2x) - i \sin(2y)}{\cosh(2x) - \cos(2y)}.$$

$$4.35.38 \quad |\sinh z| = (\sinh^2 x + \sin^2 y)^{1/2} \\ = \left(\frac{1}{2}(\cosh(2x) - \cos(2y))\right)^{1/2},$$

$$4.35.39 \quad |\cosh z| = (\sinh^2 x + \cos^2 y)^{1/2} \\ = \left(\frac{1}{2}(\cosh(2x) + \cos(2y))\right)^{1/2},$$

$$4.35.40 \quad |\tanh z| = \left(\frac{\cosh(2x) - \cos(2y)}{\cosh(2x) + \cos(2y)}\right)^{1/2}.$$

### 4.36 Infinite Products and Partial Fractions

$$4.36.1 \quad \sinh z = z \prod_{n=1}^{\infty} \left(1 + \frac{z^2}{n^2 \pi^2}\right),$$

$$4.36.2 \quad \cosh z = \prod_{n=1}^{\infty} \left(1 + \frac{4z^2}{(2n-1)^2 \pi^2}\right).$$

When  $z \neq n\pi i$ ,  $n \in \mathbb{Z}$ ,

$$4.36.3 \quad \coth z = \frac{1}{z} + 2z \sum_{n=1}^{\infty} \frac{1}{z^2 + n^2 \pi^2},$$

$$4.36.4 \quad \operatorname{csch}^2 z = \sum_{n=-\infty}^{\infty} \frac{1}{(z - n\pi i)^2},$$

$$4.36.5 \quad \operatorname{csch} z = \frac{1}{z} + 2z \sum_{n=1}^{\infty} \frac{(-1)^n}{z^2 + n^2 \pi^2}.$$

## 4.37 Inverse Hyperbolic Functions

### 4.37(i) General Definitions

The general values of the inverse hyperbolic functions are defined by

$$4.37.1 \quad \operatorname{Arcsinh} z = \int_0^z \frac{dt}{(1+t^2)^{1/2}},$$

$$4.37.2 \quad \operatorname{Arccosh} z = \int_1^z \frac{dt}{(t^2-1)^{1/2}},$$

$$4.37.3 \quad \operatorname{Arctanh} z = \int_0^z \frac{dt}{1-t^2}, \quad z \neq \pm 1,$$

$$4.37.4 \quad \operatorname{Arccsch} z = \operatorname{Arcsinh}(1/z),$$

$$4.37.5 \quad \operatorname{Arcsech} z = \operatorname{Arccosh}(1/z),$$

$$4.37.6 \quad \operatorname{Arcoth} z = \operatorname{Arctanh}(1/z).$$

In (4.37.1) the integration path may not pass through either of the points  $t = \pm i$ , and the function  $(1+t^2)^{1/2}$  assumes its principal value when  $t$  is real. In (4.37.2) the integration path may not pass through either of the points  $\pm 1$ , and the function  $(t^2-1)^{1/2}$  assumes its principal value when  $t \in (1, \infty)$ . Elsewhere on the integration paths in (4.37.1) and (4.37.2) the branches are determined by continuity. In (4.37.3) the integration path may not intersect  $\pm 1$ . Each of the six functions is a multivalued function of  $z$ .  $\operatorname{Arcsinh} z$  and  $\operatorname{Arccsch} z$

have branch points at  $z = \pm i$ ; the other four functions have branch points at  $z = \pm 1$ .

### 4.37(ii) Principal Values

The *principal values* (or *principal branches*) of the inverse  $\sinh$ ,  $\cosh$ , and  $\tanh$  are obtained by introducing cuts in the  $z$ -plane as indicated in Figure 4.37.1(i)-(iii), and requiring the integration paths in (4.37.1)–(4.37.3) not to cross these cuts. Compare the principal value of the logarithm (§4.2(i)). The principal branches are denoted by  $\operatorname{arsinh}$ ,  $\operatorname{arcosh}$ ,  $\operatorname{artanh}$  respectively. Each is two-valued on the corresponding cut(s), and each is real on the part of the real axis that remains after deleting the intersections with the corresponding cuts.

The principal values of the inverse hyperbolic cosecant, hyperbolic secant, and hyperbolic tangent are given by

$$4.37.7 \quad \operatorname{arccsch} z = \operatorname{arsinh}(1/z),$$

$$4.37.8 \quad \operatorname{arcsech} z = \operatorname{arcosh}(1/z).$$

$$4.37.9 \quad \operatorname{arcoth} z = \operatorname{artanh}(1/z), \quad z \neq \pm 1.$$

These functions are analytic in the cut plane depicted in Figure 4.37.1(iv), (v), (vi), respectively.

*Except where indicated otherwise*, it is assumed throughout this Handbook that the inverse hyperbolic functions assume their principal values.

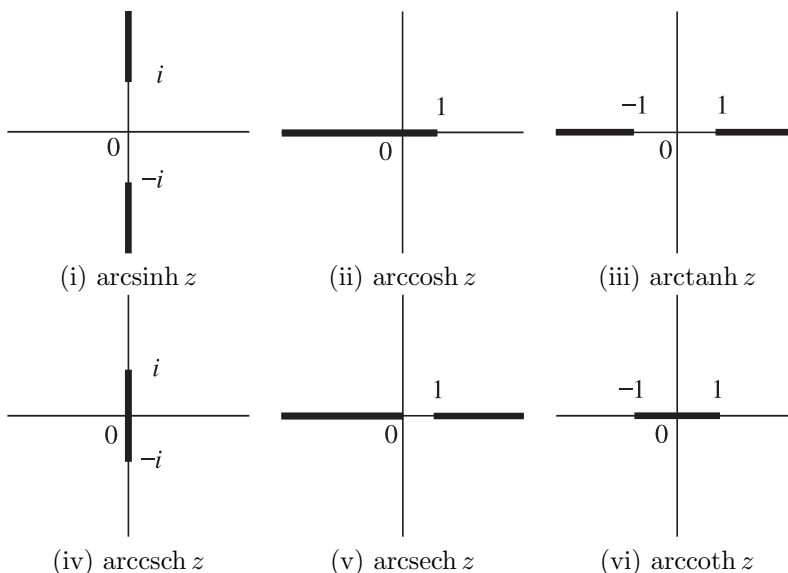


Figure 4.37.1:  $z$ -plane. Branch cuts for the inverse hyperbolic functions.

Graphs of the principal values for real arguments are given in §4.29. This section also indicates conformal mappings, and surface plots for complex arguments.



**4.37(iii) Reflection Formulas**

$$4.37.10 \quad \operatorname{arcsinh}(-z) = -\operatorname{arcsinh} z.$$

$$4.37.11 \quad \operatorname{arccosh}(-z) = \pm\pi i + \operatorname{arccosh} z, \quad \Im z \geq 0.$$

$$4.37.12 \quad \operatorname{arctanh}(-z) = -\operatorname{arctanh} z, \quad z \neq \pm 1.$$

$$4.37.13 \quad \operatorname{arccsch}(-z) = -\operatorname{arccsch} z.$$

$$4.37.14 \quad \operatorname{arcsech}(-z) = \mp\pi i + \operatorname{arcsech} z, \quad \Im z \geq 0.$$

$$4.37.15 \quad \operatorname{arcoth}(-z) = -\operatorname{arcoth} z, \quad z \neq \pm 1.$$

**4.37(iv) Logarithmic Forms**

Throughout this subsection *all* quantities assume their principal values.

**Inverse Hyperbolic Sine**

$$4.37.16 \quad \operatorname{arcsinh} z = \ln\left((z^2 + 1)^{1/2} + z\right), \\ z/i \in \mathbb{C} \setminus (-\infty, -1) \cup (1, \infty);$$

compare Figure 4.37.1(i). On the cuts

4.37.17

$$\operatorname{arcsinh}(iy) = \frac{1}{2}\pi i \pm \ln\left((y^2 - 1)^{1/2} + y\right), \quad y \in [1, \infty),$$

$$4.37.18 \quad \operatorname{arcsinh}(iy) = -\frac{1}{2}\pi i \pm \ln\left((y^2 - 1)^{1/2} - y\right), \\ y \in (-\infty, -1],$$

the upper/lower signs corresponding to the right/left sides.

**Inverse Hyperbolic Cosine**

4.37.19

$$\operatorname{arccosh} z = \ln\left(\pm(z^2 - 1)^{1/2} + z\right), \quad z \in \mathbb{C} \setminus (-\infty, 1),$$

the upper or lower sign being taken according as  $\Re z \geq 0$ ; compare Figure 4.37.1(ii). Also,

4.37.20

$$\operatorname{arccosh}(iy) = \pm\frac{1}{2}\pi i + \ln\left((y^2 + 1)^{1/2} \pm y\right), \quad y \geq 0.$$

It should be noted that the imaginary axis is not a cut; the function defined by (4.37.19) and (4.37.20) is analytic everywhere except on  $(-\infty, 1]$ . Compare Figure 4.37.1(ii).

An equivalent definition is

$$4.37.21 \quad \operatorname{arccosh} z = 2\ln\left(\left(\frac{z+1}{2}\right)^{1/2} + \left(\frac{z-1}{2}\right)^{1/2}\right), \\ z \in \mathbb{C} \setminus (-\infty, 1);$$

see Kahan (1987).

On the part of the cuts from  $-1$  to  $1$

4.37.22

$$\operatorname{arccosh} x = \pm \ln\left(i(1-x^2)^{1/2} + x\right), \quad x \in (-1, 1],$$

the upper/lower sign corresponding to the upper/lower side.

On the part of the cut from  $-\infty$  to  $-1$

4.37.23

$$\operatorname{arccosh} x = \pm\pi i + \ln\left((x^2 - 1)^{1/2} - x\right), \quad x \in (-\infty, -1],$$

the upper/lower sign corresponding to the upper/lower side.

**Inverse Hyperbolic Tangent**

4.37.24

$$\operatorname{arctanh} z = \frac{1}{2}\ln\left(\frac{1+z}{1-z}\right), \quad z \in \mathbb{C} \setminus (-\infty, -1] \cup [1, \infty);$$

compare Figure 4.37.1(iii). On the cuts

$$4.37.25 \quad \operatorname{arctanh} x = \pm\frac{1}{2}\pi i + \frac{1}{2}\ln\left(\frac{x+1}{x-1}\right), \\ x \in (-\infty, -1) \cup (1, \infty),$$

the upper/lower sign corresponding to the upper/lower sides.

**Other Inverse Functions**

For the corresponding results for  $\operatorname{arccsch} z$ ,  $\operatorname{arcsech} z$ , and  $\operatorname{arcoth} z$ , use (4.37.7)–(4.37.9); compare §4.23(iv).

**4.37(v) Fundamental Property**

With  $k \in \mathbb{Z}$ , the general solutions of the equations

$$4.37.26 \quad z = \sinh w,$$

$$4.37.27 \quad z = \cosh w,$$

$$4.37.28 \quad z = \tanh w,$$

are respectively given by

$$4.37.29 \quad w = \operatorname{Arcsinh} z = (-1)^k \operatorname{arcsinh} z + k\pi i,$$

$$4.37.30 \quad w = \operatorname{Arccosh} z = \pm \operatorname{arccosh} z + 2k\pi i,$$

$$4.37.31 \quad w = \operatorname{Arctanh} z = \operatorname{arctanh} z + k\pi i, \quad z \neq \pm 1.$$

**4.37(vi) Interrelations**

Table 4.30.1 can also be used to find interrelations between inverse hyperbolic functions. For example,  $\operatorname{arcsech} a = \operatorname{arcoth}((1-a^2)^{-1/2})$ .

### 4.38 Inverse Hyperbolic Functions: Further Properties

#### 4.38(i) Power Series

$$4.38.1 \quad \operatorname{arsinh} z = z - \frac{1}{2} \frac{z^3}{3} + \frac{1 \cdot 3}{2 \cdot 4} \frac{z^5}{5} - \frac{1 \cdot 3 \cdot 5}{2 \cdot 4 \cdot 6} \frac{z^7}{7} + \cdots, \quad |z| < 1.$$

$$4.38.2 \quad \operatorname{arsinh} z = \ln(2z) + \frac{1}{2} \frac{1}{2z^2} - \frac{1 \cdot 3}{2 \cdot 4} \frac{1}{4z^4} + \frac{1 \cdot 3 \cdot 5}{2 \cdot 4 \cdot 6} \frac{1}{6z^6} - \cdots, \quad \Re z > 0, |z| > 1.$$

$$4.38.3 \quad \operatorname{arcosh} z = \ln(2z) - \frac{1}{2} \frac{1}{2z^2} - \frac{1 \cdot 3}{2 \cdot 4} \frac{1}{4z^4} - \frac{1 \cdot 3 \cdot 5}{2 \cdot 4 \cdot 6} \frac{1}{6z^6} - \cdots, \quad |z| > 1.$$

$$4.38.4 \quad \operatorname{arccosh} z = (2(z-1))^{1/2} \times \left( 1 + \sum_{n=1}^{\infty} (-1)^n \frac{1 \cdot 3 \cdot 5 \cdots (2n-1)}{2^{2n} n! (2n+1)} (z-1)^n \right), \quad \Re z > 0, |z-1| \leq 2.$$

$$4.38.5 \quad \operatorname{artanh} z = z + \frac{z^3}{3} + \frac{z^5}{5} + \frac{z^7}{7} + \cdots, \quad |z| \leq 1, z \neq \pm 1.$$

$$4.38.6 \quad \operatorname{artanh} z = \pm i \frac{\pi}{2} + \frac{1}{z} + \frac{1}{3z^3} + \frac{1}{5z^5} + \cdots, \quad \Im z \geq 0, |z| \geq 1.$$

$$4.38.7 \quad \operatorname{artanh} z = \frac{z}{1-z^2} \times \left( 1 + \frac{2}{3} \frac{z^2}{z^2-1} + \frac{2 \cdot 4}{3 \cdot 5} \left( \frac{z^2}{z^2-1} \right)^2 + \cdots \right), \quad \Re(z^2) < \frac{1}{2},$$

which requires  $z (= x + iy)$  to lie between the two rectangular hyperbolas given by

$$4.38.8 \quad x^2 - y^2 = \frac{1}{2}.$$

#### 4.38(ii) Derivatives

In the following equations square roots have their principal values.

$$4.38.9 \quad \frac{d}{dz} \operatorname{arsinh} z = (1+z^2)^{-1/2}.$$

$$4.38.10 \quad \frac{d}{dz} \operatorname{arcosh} z = \pm (z^2-1)^{-1/2}, \quad \Re z \geq 0.$$

$$4.38.11 \quad \frac{d}{dz} \operatorname{artanh} z = \frac{1}{1-z^2}.$$

$$4.38.12 \quad \frac{d}{dz} \operatorname{arcsch} z = \mp \frac{1}{z(1+z^2)^{1/2}}, \quad \Re z \geq 0.$$

$$4.38.13 \quad \frac{d}{dz} \operatorname{arcsech} z = -\frac{1}{z(1-z^2)^{1/2}}.$$

$$4.38.14 \quad \frac{d}{dz} \operatorname{arccoth} z = \frac{1}{1-z^2}.$$

#### 4.38(iii) Addition Formulas

$$4.38.15 \quad \begin{aligned} & \operatorname{Arcsinh} u \pm \operatorname{Arcsinh} v \\ &= \operatorname{Arcsinh} \left( u(1+v^2)^{1/2} \pm v(1+u^2)^{1/2} \right), \end{aligned}$$

$$4.38.16 \quad \begin{aligned} & \operatorname{Arccosh} u \pm \operatorname{Arccosh} v \\ &= \operatorname{Arccosh} \left( uv \pm ((u^2-1)(v^2-1))^{1/2} \right), \end{aligned}$$

$$4.38.17 \quad \operatorname{Arctanh} u \pm \operatorname{Arctanh} v = \operatorname{Arctanh} \left( \frac{u \pm v}{1 \pm uv} \right),$$

$$4.38.18 \quad \begin{aligned} & \operatorname{Arcsinh} u \pm \operatorname{Arccosh} v \\ &= \operatorname{Arcsinh} \left( uv \pm ((1+u^2)(v^2-1))^{1/2} \right) \\ &= \operatorname{Arccosh} \left( v(1+u^2)^{1/2} \pm u(v^2-1)^{1/2} \right), \end{aligned}$$

$$4.38.19 \quad \begin{aligned} & \operatorname{Arctanh} u \pm \operatorname{Arccoth} v = \operatorname{Arctanh} \left( \frac{uv \pm 1}{v \pm u} \right) \\ &= \operatorname{Arccoth} \left( \frac{v \pm u}{uv \pm 1} \right). \end{aligned}$$

The above equations are interpreted in the sense that every value of the left-hand side is a value of the right-hand side and vice-versa. All square roots have either possible value.

### 4.39 Continued Fractions

$$4.39.1 \quad \tanh z = \frac{z}{1 + \frac{z^2}{3 + \frac{z^2}{5 + \frac{z^2}{7 + \cdots}}}}, \quad z \neq \pm \frac{1}{2}\pi i, \pm \frac{3}{2}\pi i, \dots$$

$$4.39.2 \quad \frac{\operatorname{arsinh} z}{\sqrt{1+z^2}} = \frac{z}{1 + \frac{1 \cdot 2z^2}{3 + \frac{1 \cdot 2z^2}{5 + \frac{3 \cdot 4z^2}{7 + \frac{3 \cdot 4z^2}{9 + \cdots}}}}},$$

where  $z$  is in the open cut plane of Figure 4.37.1(i).

$$4.39.3 \quad \operatorname{artanh} z = \frac{z}{1 - \frac{z^2}{3 - \frac{4z^2}{5 - \frac{9z^2}{7 - \cdots}}}},$$

where  $z$  is in the open cut plane of Figure 4.37.1(iii).

For these and other continued fractions involving inverse hyperbolic functions see Lorentzen and Waadeland (1992, pp. 569–571). See also Cuyt *et al.* (2008, pp. 211–217).

### 4.40 Integrals

#### 4.40(i) Introduction

Throughout this section the variables are assumed to be real. The results in §§4.40(ii) and 4.40(iv) can be extended to the complex plane by using continuous branches and avoiding singularities.

**4.40(ii) Indefinite Integrals**

$$4.40.1 \quad \int \sinh x \, dx = \cosh x,$$

$$4.40.2 \quad \int \cosh x \, dx = \sinh x,$$

$$4.40.3 \quad \int \tanh x \, dx = \ln(\cosh x).$$

$$4.40.4 \quad \int \operatorname{csch} x \, dx = \ln(\tanh(\frac{1}{2}x)), \quad 0 < x < \infty.$$

$$4.40.5 \quad \int \operatorname{sech} x \, dx = \operatorname{gd}(x).$$

For the right-hand side see (4.23.39) and (4.23.40).

$$4.40.6 \quad \int \operatorname{coth} x \, dx = \ln(\sinh x), \quad 0 < x < \infty.$$

**4.40(iii) Definite Integrals**

$$4.40.7 \quad \int_0^\infty e^{-x} \frac{\sin(ax)}{\sinh x} \, dx = \frac{1}{2}\pi \operatorname{coth}(\frac{1}{2}\pi a) - \frac{1}{a}, \quad a \neq 0,$$

$$4.40.8 \quad \int_0^\infty \frac{\sinh(ax)}{\sinh(\pi x)} \, dx = \frac{1}{2} \tan(\frac{1}{2}a), \quad -\pi < a < \pi,$$

$$4.40.9 \quad \int_{-\infty}^\infty \frac{e^{ax}}{(\cosh(\frac{1}{2}x))^2} \, dx = \frac{4\pi a}{\sin(\pi a)}, \quad -1 < a < 1,$$

$$4.40.10 \quad \int_0^\infty \frac{\tanh(ax) - \tanh(bx)}{x} \, dx = \ln\left(\frac{a}{b}\right), \quad a > 0, b > 0.$$

**4.40(iv) Inverse Hyperbolic Functions**

$$4.40.11 \quad \int \operatorname{arcsinh} x \, dx = x \operatorname{arcsinh} x - (1+x^2)^{1/2}.$$

$$4.40.12 \quad \int \operatorname{arcosh} x \, dx = x \operatorname{arcosh} x - (x^2-1)^{1/2}, \quad 1 < x < \infty,$$

$$4.40.13 \quad \int \operatorname{arctanh} x \, dx = x \operatorname{arctanh} x + \frac{1}{2} \ln(1-x^2), \\ -1 < x < 1,$$

$$4.40.14 \quad \int \operatorname{arcsch} x \, dx = x \operatorname{arcsch} x + \operatorname{arcsinh} x, \quad 0 < x < \infty,$$

$$4.40.15 \quad \int \operatorname{arcsech} x \, dx = x \operatorname{arcsech} x + \operatorname{arcsin} x, \quad 0 < x < 1,$$

$$4.40.16 \quad \int \operatorname{arcoth} x \, dx = x \operatorname{arcoth} x + \frac{1}{2} \ln(x^2-1), \\ 1 < x < \infty.$$

**4.40(v) Compendia**

Extensive compendia of indefinite and definite integrals of hyperbolic functions include Apelblat (1983, pp. 96–109), Bierens de Haan (1939), Gröbner and Hofreiter (1949, pp. 139–160), Gröbner and Hofreiter (1950, pp. 160–167), Gradshteyn and Ryzhik (2000, Chapters 2–4), and Prudnikov *et al.* (1986a, §§1.4, 1.8, 2.4, 2.8).

**4.41 Sums**

For sums of hyperbolic functions see Gradshteyn and Ryzhik (2000, Chapter 1), Hansen (1975, §43), Prudnikov *et al.* (1986a, §5.3), and Zucker (1979).

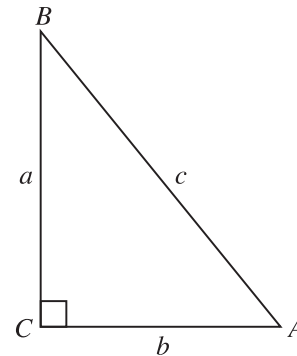
**Applications****4.42 Solution of Triangles****4.42(i) Planar Right Triangles**

Figure 4.42.1: Planar right triangle.

$$4.42.1 \quad \sin A = \frac{a}{c} = \frac{1}{\csc A},$$

$$4.42.2 \quad \cos A = \frac{b}{c} = \frac{1}{\sec A},$$

$$4.42.3 \quad \tan A = \frac{a}{b} = \frac{1}{\cot A}.$$

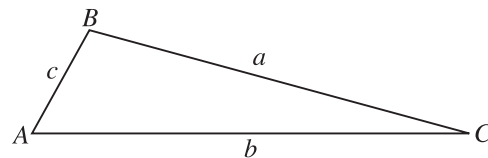
**4.42(ii) Planar Triangles**

Figure 4.42.2: Planar triangle.

$$4.42.4 \quad \frac{a}{\sin A} = \frac{b}{\sin B} = \frac{c}{\sin C},$$

$$4.42.5 \quad c^2 = a^2 + b^2 - 2ab \cos C,$$

$$4.42.6 \quad a = b \cos C + c \cos B$$

4.42.7 area =  $\frac{1}{2}bc \sin A = (s(s-a)(s-b)(s-c))^{1/2}$ ,  
where  $s = \frac{1}{2}(a+b+c)$  (the semiperimeter).

#### 4.42(iii) Spherical Triangles

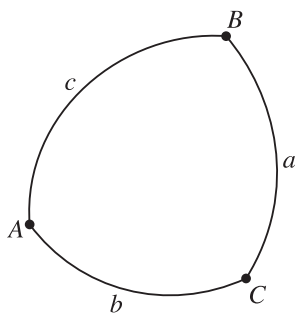


Figure 4.42.3: Spherical triangle.

$$4.42.8 \quad \cos a = \cos b \cos c + \sin b \sin c \cos A,$$

$$4.42.9 \quad \frac{\sin A}{\sin a} = \frac{\sin B}{\sin b} = \frac{\sin C}{\sin c},$$

$$4.42.10 \quad \sin a \cos B = \cos b \sin c - \sin b \cos c \cos A,$$

$$4.42.11 \quad \cos a \cos C = \sin a \cot b - \sin C \cot B,$$

$$4.42.12 \quad \cos A = -\cos B \cos C + \sin B \sin C \cos a.$$

For these and other formulas see Smart (1962, Chapter 1).

### 4.43 Cubic Equations

Let

$$A = \left(-\frac{4}{3}p\right)^{1/2}, \quad B = \left(\frac{4}{3}p\right)^{1/2},$$

$$4.43.1 \quad C = \left(-\frac{27q^2}{4p^3}\right)^{1/2}, \quad D = -\left(\frac{27q^2}{4p^3}\right)^{1/2},$$

where  $p(\neq 0)$  and  $q$  are real constants. The roots of

$$4.43.2 \quad z^3 + pz + q = 0$$

are:

(a)  $A \sin a$ ,  $A \sin(a + \frac{2}{3}\pi)$ , and  $A \sin(a + \frac{4}{3}\pi)$ , with  $\sin(3a) = C$ , when  $p < 0$  and  $C \leq 1$ .

(b)  $A \cosh a$ ,  $A \cosh(a + \frac{2}{3}\pi i)$ , and  $A \cosh(a + \frac{4}{3}\pi i)$ , with  $\cosh(3a) = C$ , when  $p < 0$  and  $C > 1$ .

(c)  $B \sinh a$ ,  $B \sinh(a + \frac{2}{3}\pi i)$ , and  $B \sinh(a + \frac{4}{3}\pi i)$ , with  $\sinh(3a) = D$ , when  $p > 0$ .

Note that in Case (a) all the roots are real, whereas in Cases (b) and (c) there is one real root and a conjugate pair of complex roots. See also §1.11(iii).

### 4.44 Other Applications

For applications of generalized exponentials and generalized logarithms to computer arithmetic see §3.1(iv).

For an application of the Lambert  $W$ -function to generalized Gaussian noise see Chapeau-Blondeau and Monir (2002).

## Computation

### 4.45 Methods of Computation

#### 4.45(i) Real Variables

##### Logarithms

The function  $\ln x$  can always be computed from its ascending power series after preliminary scaling. Suppose first  $1/10 \leq x \leq 10$ . Then we take square roots repeatedly until  $|y|$  is sufficiently small, where

$$4.45.1 \quad y = x^{2^{-m}} - 1.$$

After computing  $\ln(1+y)$  from (4.6.1)

$$4.45.2 \quad \ln x = 2^m \ln(1+y).$$

For other values of  $x$  set  $x = 10^m \xi$ , where  $1/10 \leq \xi \leq 10$  and  $m \in \mathbb{Z}$ . Then

$$4.45.3 \quad \ln x = \ln \xi + m \ln 10.$$

##### Exponentials

Let  $x$  have any real value. First, rescale via

$$4.45.4 \quad m = \left\lfloor \frac{x}{\ln 10} + \frac{1}{2} \right\rfloor, \quad y = x - m \ln 10.$$

Then

$$4.45.5 \quad e^x = 10^m e^y,$$

and since  $|y| \leq \frac{1}{2} \ln 10 = 1.15\dots$ ,  $e^y$  can be computed straightforwardly from (4.2.19).

##### Trigonometric Functions

Let  $x$  have any real value. We first compute  $\xi = x/\pi$ , followed by

$$4.45.6 \quad m = \left\lfloor \xi + \frac{1}{2} \right\rfloor, \quad \theta = \pi(\xi - m).$$

Then

$$4.45.7 \quad \sin x = (-1)^m \sin \theta, \quad \cos x = (-1)^m \cos \theta,$$

and since  $|\theta| \leq \frac{1}{2}\pi = 1.57\dots$ ,  $\sin \theta$  and  $\cos \theta$  can be computed straightforwardly from (4.19.1) and (4.19.2).

The other trigonometric functions can be found from the definitions (4.14.4)–(4.14.7).

### Inverse Trigonometric Functions

The function  $\arctan x$  can always be computed from its ascending power series after preliminary transformations to reduce the size of  $x$ . From (4.24.15) with  $u = v = ((1 + x^2)^{1/2} - 1)/x$ , we have

4.45.8

$$2 \arctan \frac{(1 + x^2)^{1/2} - 1}{x} = \arctan x, \quad 0 < x < \infty.$$

Beginning with  $x_0 = x$ , generate the sequence

4.45.9 
$$x_n = \frac{(1 + x_{n-1}^2)^{1/2} - 1}{x_{n-1}}, \quad n = 1, 2, 3, \dots,$$

until  $x_n$  is sufficiently small. We then compute  $\arctan x_n$  from (4.24.3), followed by

4.45.10 
$$\arctan x = 2^n \arctan x_n.$$

Another method, when  $x$  is large, is to sum

4.45.11 
$$\arctan x = \frac{\pi}{2} - \frac{1}{x} + \frac{1}{3x^3} - \frac{1}{5x^5} + \dots;$$

compare (4.24.4).

As an example, take  $x = 9.47376$ . Then

4.45.12 
$$\begin{aligned} x_1 &= 0.90000\dots, & x_2 &= 0.38373\dots, \\ x_3 &= 0.18528\dots, & x_4 &= 0.09185\dots \end{aligned}$$

From (4.24.3)  $\arctan x_4 = 0.09160\dots$ . From (4.45.10)

4.45.13 
$$\arctan x = 16 \arctan x_4 = 1.46563\dots$$

As a check, from (4.45.11)

4.45.14 
$$\begin{aligned} \arctan x &= 1.57079\dots - 0.10555\dots + 0.00039\dots - \dots \\ &= 1.46563\dots \end{aligned}$$

For the remaining inverse trigonometric functions, we may use the identities provided by the fourth row of Table 4.16.3. For example,  $\arcsin x = \arctan(x(1 - x^2)^{-1/2})$ .

### Hyperbolic and Inverse Hyperbolic Functions

The hyperbolic functions can be computed directly from the definitions (4.28.1)–(4.28.7). The inverses  $\operatorname{arcsinh}$ ,  $\operatorname{arccosh}$ , and  $\operatorname{arctanh}$  can be computed from the logarithmic forms given in §4.37(iv), with real arguments. For  $\operatorname{arcsch}$ ,  $\operatorname{arcsech}$ , and  $\operatorname{arcoth}$  we have (4.37.7)–(4.37.9).

### Other Methods

See Luther (1995), Ziv (1991), Cody and Waite (1980), Rosenberg and McNamee (1976), Carlson (1972a). For interval-arithmetic algorithms, see Markov (1981). For Shift-and-Add and CORDIC algorithms, see Muller (1997), Merrheim (1994), Schelin (1983). For multi-precision methods, see Smith (1989), Brent (1976).

### 4.45(ii) Complex Variables

For  $\ln z$  and  $e^z$

4.45.15 
$$\ln z = \ln |z| + i \operatorname{ph} z, \quad -\pi \leq \operatorname{ph} z \leq \pi,$$

4.45.16 
$$e^z = e^{\Re z} (\cos(\Im z) + i \sin(\Im z)).$$

See §1.9(i) for the precise relationship of  $\operatorname{ph} z$  to the arctangent function.

The trigonometric functions may be computed from the definitions (4.14.1)–(4.14.7), and their inverses from the logarithmic forms in §4.23(iv), followed by (4.23.7)–(4.23.9). Similarly for the hyperbolic and inverse hyperbolic functions; compare (4.28.1)–(4.28.7), §4.37(iv), and (4.37.7)–(4.37.9).

For other methods see Miel (1981).

### 4.45(iii) Lambert $W$ -Function

For  $x \in [-1/e, \infty)$  the principal branch  $W_p(x)$  can be computed by solving the defining equation  $We^W = x$  numerically, for example, by Newton's rule (§3.8(ii)). Initial approximations are obtainable, for example, from the power series (4.13.6) (with  $t \geq 0$ ) when  $x$  is close to  $-1/e$ , from the asymptotic expansion (4.13.10) when  $x$  is large, and by numerical integration of the differential equation (4.13.4) (§3.7) for other values of  $x$ .

Similarly for  $W_m(x)$  in the interval  $[-1/e, 0)$ .

See also Barry *et al.* (1995) and Chapeau-Blondeau and Monir (2002).

## 4.46 Tables

Extensive numerical tables of all the elementary functions for real values of their arguments appear in Abramowitz and Stegun (1964, Chapter 4). This handbook also includes lists of references for earlier tables, as do Fletcher *et al.* (1962) and Lebedev and Fedorova (1960).

For 40D values of the first 500 roots of  $\tan x = x$ , see Robinson (1972). (These roots are zeros of the Bessel function  $J_{3/2}(x)$ ; see §10.21.)

For 10S values of the first five complex roots of  $\sin z = az$ ,  $\cos z = az$ , and  $\cosh z = az$ , for selected positive values of  $a$ , see Fettis (1976).

See also Luther (1995).

## 4.47 Approximations

### 4.47(i) Chebyshev-Series Expansions

Clenshaw (1962) and Luke (1975, Chapter 3) give 20D coefficients for  $\ln$ ,  $\exp$ ,  $\sin$ ,  $\cos$ ,  $\tan$ ,  $\cot$ ,  $\arcsin$ ,  $\arctan$ ,  $\operatorname{arcsinh}$ . Schonfelder (1980) gives 40D coefficients for  $\sin$ ,  $\cos$ ,  $\tan$ .

### 4.47(ii) Rational Functions

Hart *et al.* (1968) give  $\ln$ ,  $\exp$ ,  $\sin$ ,  $\cos$ ,  $\tan$ ,  $\cot$ ,  $\arcsin$ ,  $\arccos$ ,  $\arctan$ ,  $\sinh$ ,  $\cosh$ ,  $\tanh$ ,  $\operatorname{arcsinh}$ ,  $\operatorname{arccosh}$ . Precision is variable.

### 4.47(iii) Padé Approximations

Luke (1975, Chapter 3) supplies real and complex approximations for  $\ln$ ,  $\exp$ ,  $\sin$ ,  $\cos$ ,  $\tan$ ,  $\arctan$ ,  $\operatorname{arcsinh}$ . Precision is variable.

### 4.47(iv) Additional References

See Luke (1975, pp. 288–289) and Luke (1969b, pp. 74–76).

## 4.48 Software

See <http://dlmf.nist.gov/4.48>.

## References

### General References

The main references used in writing this chapter are Levinson and Redheffer (1970), Hobson (1928), Wall (1948), and Whittaker and Watson (1927). For additional bibliographic reading see Copson (1935) and Silverman (1967).

### Sources

The following list gives the references or other indications of proofs that were used in constructing the various sections of this chapter. These sources supplement the references that are quoted in the text.

- §4.2 Levinson and Redheffer (1970, pp. 62–67), Hobson (1928, pp. 289–301).
- §4.3 These graphics were produced at NIST.
- §4.4 Levinson and Redheffer (1970, pp. 62–63, 69), Hardy (1952, pp. 403–420).
- §4.5 (4.5.1) and (4.5.5) can be verified by the methods of Hardy *et al.* (1967, pp. 106–107). (4.5.2) and (4.5.4) follow from (4.5.1). (4.5.3) follows from the fact that  $x = 0$  and  $x = 0.5828\dots$  are successive zeros of  $\frac{3}{2}x + \ln(1 - x)$ . (4.5.6) is obtained from the Maclaurin expansion of  $\ln(1 + z)$ . (4.5.7) to (4.5.12) are obtained by exponentiating the inequalities (4.5.1) and (4.5.2). For (4.5.13), see Hardy *et al.* (1967, p. 102). (4.5.14) follows from the fact that  $1 - \frac{1}{2}x - e^{-x}$  has 0 and 1.5936... as consecutive zeros. (4.5.15) and (4.5.16) can be derived from the Maclaurin expansion of  $e^z$ .
- §4.6 For (4.6.1) see Hardy (1952, pp. 471–473). (4.6.2)–(4.6.6) are variations of this. For (4.6.7) see Hardy (1952, pp. 476–477).
- §4.7 Levinson and Redheffer (1970, pp. 53–54, 62–69).
- §4.8 Levinson and Redheffer (1970, pp. 62–66), Hobson (1928, pp. 297–299).
- §4.10 (4.10.1)–(4.10.4) and (4.10.8)–(4.10.10) can be verified by differentiation. For (4.10.5) and (4.10.6), expand by the geometric series and integrate term by term to get a series which can be summed by Andrews *et al.* (1999, p. 12). For (4.10.11) apply (5.4.6) and (5.9.1). To evaluate (4.10.12) and (4.10.13), expand by the geometric series and integrate term by term. The dilogarithm series which appears from (4.10.12) can be summed by Andrews *et al.* (1999, p. 105).
- §4.13 To verify the radius of convergence of the series (4.13.6) map the plane of  $W$  onto the plane of  $t$  via  $t = (-2v)^{1/2}$ , where  $v = W + \ln W + 1 - i\pi$ . Then  $W$  is analytic at  $t = 0$ , and its nearest singularities to the origin are located at  $t = 2\sqrt{\pi}e^{\pm\pi i/4}$ . Figure 4.13.1 was produced at NIST.
- §4.14 Levinson and Redheffer (1970, pp. 55–57).
- §4.15 These graphics were produced at NIST.
- §4.16 Hobson (1928, pp. 19–24).
- §4.17 Hobson (1928, pp. 29–32, 53–75).
- §4.18 For (4.18.1) see Copson (1935, p. 136). (4.18.3) follows by the same method and (4.18.2) is a consequence. (4.18.5) to (4.18.9) are straightforward and (4.18.10) is obtained from the Maclaurin expansions of  $\cos z$  and  $\sin z$ . For the second inequality in (4.18.4), it is sufficient to show  $f(x) \equiv 4x(1 - x) - \sin(\pi x) \geq 0$  for  $0 \leq x \leq 1/2$ . The function  $f(x)$  is zero at  $x = 0$  and  $x = 1/2$  and it has no zeros in  $(0, 1/2)$ , because  $f'(x) = 4(1 - 2x) - \pi \cos(\pi x)$  can have only one zero in  $(0, 1/2)$  where  $y = 4(1 - 2x)$  intersects  $y = \pi \cos(\pi x)$ . The first inequality is proved similarly.
- §4.19 Hobson (1928, pp. 288–293, 360–367).
- §4.20 Levinson and Redheffer (1970, pp. 53–60).
- §4.21 Hobson (1928, Chapter 4 and pp. 19, 21, 45, 52–53, 60, 63–69, 237–239, 331). For (4.21.35) see Walker (1996, §1.9).

- §4.22** Hobson (1928, Chapter 17), Levinson and Redheffer (1970, pp. 387–389).
- §4.23** Levinson and Redheffer (1970, pp. 68–70), Hobson (1928, pp. 32–33, 332–333), Fletcher *et al.* (1962, §§12.1, 12.2). (4.23.10)–(4.23.18) and also Table 4.23.1 follow from the definitions in §§4.23(i), 4.23(ii). To verify (4.23.19), denote the right-hand side by  $\phi(z)$ , and the domain  $\mathbb{C} \setminus (-\infty, -1] \cup [1, \infty)$  by  $D$ . If  $z = x \in (-1, 1)$ , then  $\phi'(x) = (1 - x^2)^{-1/2}$  and  $\phi(0) = 0$ . Hence (4.23.19) applies; compare (4.23.1) with Arcsin replaced by arcsin. We may now extend (4.23.19) to the rest of  $D$  simply by showing that  $\phi(z)$  is analytic on  $D$ ; compare §1.10(ii). Since the principal value of  $(1 - z^2)^{1/2}$  is analytic on  $D$ , the only possible singularities of  $\phi(z)$  occur on the branch cut of the logarithm, that is, when  $(1 - z^2)^{1/2} = -iz - t$  with  $t \in [0, \infty)$ . By squaring the last equation we see that  $(1 - z^2)^{1/2} + iz$  is real only when  $z$  lies on the imaginary axis, and it is then positive. The proofs of (4.23.22), (4.23.23), (4.23.26) are similar, or in the case of (4.23.22) we may simply refer to (4.23.16). (4.23.40) and (4.23.42) may be verified by differentiation plus comparison of values as  $x \rightarrow 0$ .
- §4.24** Hobson (1928, pp. 54–55, 279–280, 321), Levinson and Redheffer (1970, pp. 68–70). For (4.24.10) and (4.24.11) note that the principal value of  $(z^2 - 1)^{1/2}$  is discontinuous on the imaginary axis, hence we switch to the other branch when crossing this axis. This accounts for the two signs.
- §4.25** Jones and Thron (1980, pp. 202–203), Wall (1948, pp. 343–349).
- §4.26** (4.26.1)–(4.26.8) and (4.26.14)–(4.26.21) may be verified by differentiation. For (4.26.12) and (4.26.13) see Copson (1935, pp. 137 and 227).
- §4.28** Hobson (1928, pp. 322–326), Levinson and Redheffer (1970, pp. 56–57).
- §4.29** These graphics were produced at NIST.
- §4.30** Hobson (1928, pp. 323–326).
- §4.31** Hobson (1928, p. 326), Levinson and Redheffer (1970, p. 61).
- §4.35** Hobson (1928, pp. 323–325, 331).
- §4.36** For (4.36.1)–(4.36.5) replace  $z$  by  $iz$  in (4.22.1)–(4.22.5) and apply (4.28.8)–(4.28.13).
- §4.37** Levinson and Redheffer (1970, pp. 68–69). (4.37.11) follows from (4.37.19). The equations in §4.37(iv) may be verified in a similar manner to those of §4.23(iv). The only new feature is that in (4.37.19) the principal value of  $(z^2 - 1)^{1/2}$  is discontinuous on the imaginary axis, hence to continue  $(z^2 - 1)^{1/2}$  analytically we switch to the other branch. This accounts for the  $\pm$  sign in (4.37.19).
- §4.38** For (4.38.1) expand  $(1 + z^2)^{-1/2}$  by the binomial theorem and integrate term by term. For (4.38.2), write  $(1 + z^2)^{-1/2} = z^{-1}(1 + (1/z^2))^{-1/2}$ ,  $\Re z > 0$ , and then expand and integrate. To find the constant of integration note that for large  $z$ ,  $\operatorname{arcsinh} z$  behaves like  $\ln(2z)$  and the constant is  $\ln 2$ . (4.38.3) is proved similarly. (4.38.4)–(4.38.7) follow from the corresponding series for inverse trigonometric functions in §4.24. For (4.38.9)–(4.38.14) take the derivatives of the logarithmic forms of inverse hyperbolic functions in §4.37(iv). For (4.38.15)–(4.38.19) use similar analysis to that for §4.24(iii).
- §4.40** (4.40.1)–(4.40.6) and (4.40.11)–(4.40.16) may be verified by differentiation. For (4.40.7)–(4.40.10) see Copson (1935, p. 155).
- §4.42** Hobson (1928, p. 18 and Chapter 10).
- §4.43** Hobson (1928, p. 335).

## Chapter 5

# Gamma Function

R. A. Askey<sup>1</sup> and R. Roy<sup>2</sup>

<b>Notation</b>	<b>136</b>	5.15 Polygamma Functions . . . . .	144
5.1 Special Notation . . . . .	136	5.16 Sums . . . . .	144
<b>Properties</b>	<b>136</b>	5.17 Barnes' $G$ -Function (Double Gamma Function) . . . . .	144
5.2 Definitions . . . . .	136	5.18 $q$ -Gamma and Beta Functions . . . . .	145
5.3 Graphics . . . . .	136	<b>Applications</b>	<b>145</b>
5.4 Special Values and Extrema . . . . .	137	5.19 Mathematical Applications . . . . .	145
5.5 Functional Relations . . . . .	138	5.20 Physical Applications . . . . .	145
5.6 Inequalities . . . . .	138	<b>Computation</b>	<b>146</b>
5.7 Series Expansions . . . . .	139	5.21 Methods of Computation . . . . .	146
5.8 Infinite Products . . . . .	139	5.22 Tables . . . . .	146
5.9 Integral Representations . . . . .	139	5.23 Approximations . . . . .	146
5.10 Continued Fractions . . . . .	140	5.24 Software . . . . .	147
5.11 Asymptotic Expansions . . . . .	140	<b>References</b>	<b>147</b>
5.12 Beta Function . . . . .	142		
5.13 Integrals . . . . .	143		
5.14 Multidimensional Integrals . . . . .	143		

<sup>1</sup>Department of Mathematics, University of Wisconsin, Madison, Wisconsin.

<sup>2</sup>Department of Mathematics and Computer Science, Beloit College, Beloit, Wisconsin.

**Acknowledgments:** This chapter is based in part on Abramowitz and Stegun (1964, Chapter 6) by P. J. Davis.

**Copyright** © 2009 National Institute of Standards and Technology. All rights reserved.



## Notation

### 5.1 Special Notation

(For other notation see pp. xiv and 873.)

- $j, m, n$  nonnegative integers.
- $k$  nonnegative integer, except in §5.20.
- $x, y$  real variables.
- $z = x + iy$  complex variable.
- $a, b, q, s, w$  real or complex variables with  $|q| < 1$ .
- $\delta$  arbitrary small positive constant.
- $\gamma$  Euler's constant (§5.2(ii)).
- primes derivatives with respect to the variable.

The main functions treated in this chapter are the gamma function  $\Gamma(z)$ , the psi function (or digamma function)  $\psi(z)$ , the beta function  $B(a, b)$ , and the  $q$ -gamma function  $\Gamma_q(z)$ .

The notation  $\Gamma(z)$  is due to Legendre. Alternative notations for this function are:  $\Pi(z - 1)$  (Gauss) and  $(z - 1)!$ . Alternative notations for the psi function are:  $\Psi(z - 1)$  (Gauss) Jahnke and Emde (1945);  $\Psi(z)$  Davis (1933);  $F(z - 1)$  Pairman (1919).

## Properties

### 5.2 Definitions

#### 5.2(i) Gamma and Psi Functions

**Euler's Integral**

$$5.2.1 \quad \Gamma(z) = \int_0^\infty e^{-t} t^{z-1} dt, \quad \Re z > 0.$$

When  $\Re z \leq 0$ ,  $\Gamma(z)$  is defined by analytic continuation. It is a meromorphic function with no zeros, and with simple poles of residue  $(-1)^n/n!$  at  $z = -n$ .  $1/\Gamma(z)$  is entire, with simple zeros at  $z = -n$ .

$$5.2.2 \quad \psi(z) = \Gamma'(z)/\Gamma(z), \quad z \neq 0, -1, -2, \dots$$

$\psi(z)$  is meromorphic with simple poles of residue  $-1$  at  $z = -n$ .

#### 5.2(ii) Euler's Constant

$$5.2.3 \quad \gamma = \lim_{n \rightarrow \infty} \left( 1 + \frac{1}{2} + \frac{1}{3} + \dots + \frac{1}{n} - \ln n \right) \\ = 0.57721\ 56649\ 01532\ 86060 \dots$$

#### 5.2(iii) Pochhammer's Symbol

$$5.2.4 \quad (a)_0 = 1, \quad (a)_n = a(a+1)(a+2) \cdots (a+n-1),$$

$$5.2.5 \quad (a)_n = \Gamma(a+n)/\Gamma(a), \quad a \neq 0, -1, -2, \dots$$

### 5.3 Graphics

#### 5.3(i) Real Argument

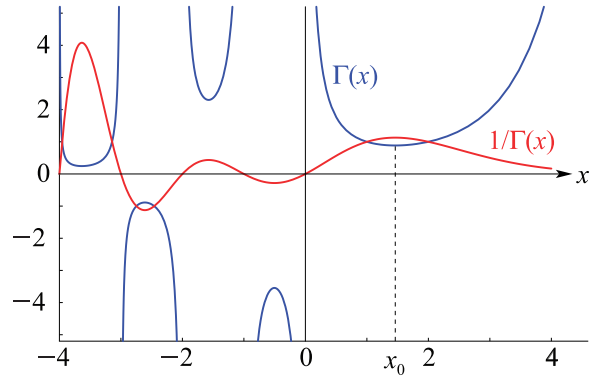


Figure 5.3.1:  $\Gamma(x)$  and  $1/\Gamma(x)$ .  $x_0 = 1.46\dots$ ,  $\Gamma(x_0) = 0.88\dots$ ; see §5.4(iii).

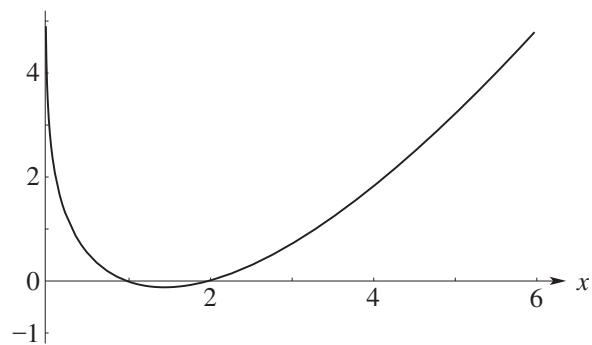


Figure 5.3.2:  $\ln \Gamma(x)$ . This function is convex on  $(0, \infty)$ ; compare §5.5(iv).

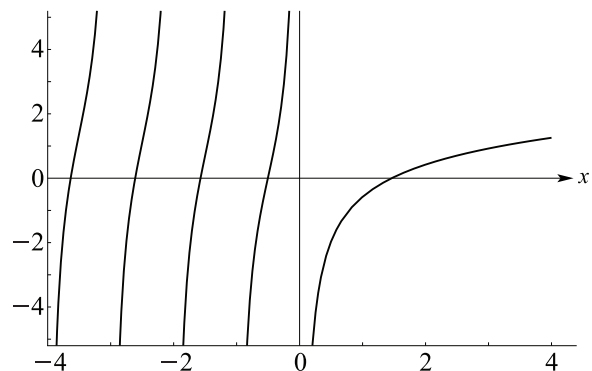
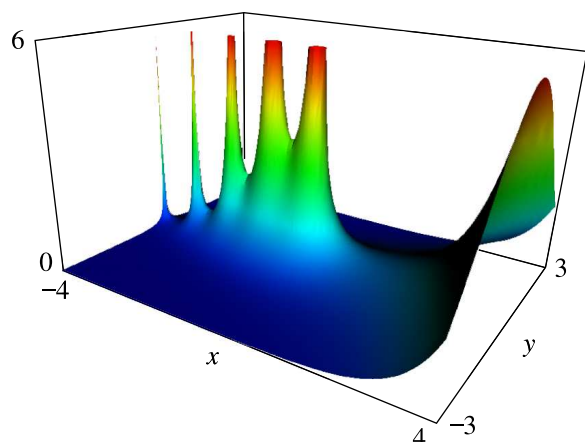
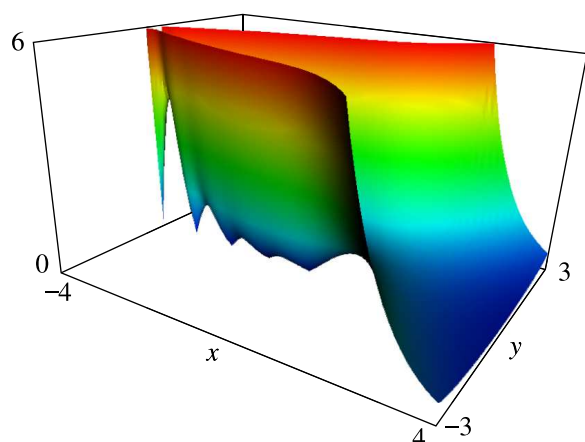
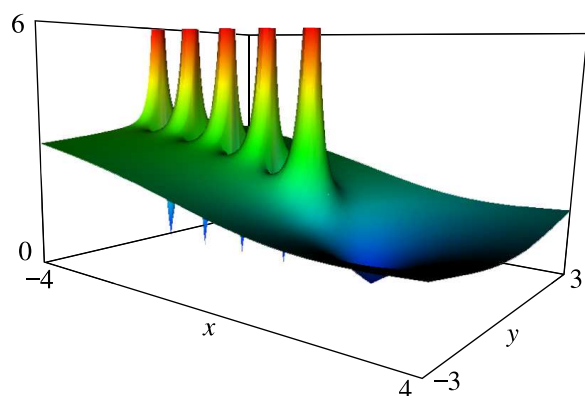


Figure 5.3.3:  $\psi(x)$ .

#### 5.3(ii) Complex Argument

In the graphics shown in this subsection, both the height and color correspond to the absolute value of the function. See also p. xiv.

Figure 5.3.4:  $|\Gamma(x + iy)|$ .Figure 5.3.5:  $1/|\Gamma(x + iy)|$ .Figure 5.3.6:  $|\psi(x + iy)|$ .

## 5.4 Special Values and Extrema

### 5.4(i) Gamma Function

$$5.4.1 \quad \Gamma(1) = 1, \quad n! = \Gamma(n + 1).$$

$$5.4.2 \quad n!! = \begin{cases} 2^{\frac{1}{2}n} \Gamma(\frac{1}{2}n + 1), & n \text{ even,} \\ \pi^{-\frac{1}{2}} 2^{\frac{1}{2}n + \frac{1}{2}} \Gamma(\frac{1}{2}n + 1), & n \text{ odd.} \end{cases}$$

(The second line of Formula (5.4.2) also applies when  $n = -1$ .)

$$5.4.3 \quad |\Gamma(iy)| = \left( \frac{\pi}{y \sinh(\pi y)} \right)^{1/2},$$

$$5.4.4 \quad \Gamma(\frac{1}{2} + iy) \Gamma(\frac{1}{2} - iy) = |\Gamma(\frac{1}{2} + iy)|^2 = \frac{\pi}{\cosh(\pi y)},$$

$$5.4.5 \quad \Gamma(\frac{1}{4} + iy) \Gamma(\frac{3}{4} - iy) = \frac{\pi\sqrt{2}}{\cosh(\pi y) + i \sinh(\pi y)}.$$

$$5.4.6 \quad \begin{aligned} \Gamma(\frac{1}{2}) &= \pi^{1/2} \\ &= 1.77245 38509 05516 02729 \dots, \end{aligned}$$

$$5.4.7 \quad \Gamma(\frac{1}{3}) = 2.67893 85347 07747 63365 \dots,$$

$$5.4.8 \quad \Gamma(\frac{2}{3}) = 1.35411 79394 26400 41694 \dots,$$

$$5.4.9 \quad \Gamma(\frac{1}{4}) = 3.62560 99082 21908 31193 \dots,$$

$$5.4.10 \quad \Gamma(\frac{3}{4}) = 1.22541 67024 65177 64512 \dots$$

$$5.4.11 \quad \Gamma'(1) = -\gamma.$$

### 5.4(ii) Psi Function

$$5.4.12 \quad \psi(1) = -\gamma, \quad \psi'(1) = \frac{1}{6}\pi^2,$$

$$5.4.13 \quad \psi(\frac{1}{2}) = -\gamma - 2 \ln 2, \quad \psi'(\frac{1}{2}) = \frac{1}{2}\pi^2.$$

For higher derivatives of  $\psi(z)$  at  $z = 1$  and  $z = \frac{1}{2}$ , see §5.15.

$$5.4.14 \quad \psi(n + 1) = \sum_{k=1}^n \frac{1}{k} - \gamma,$$

$$5.4.15 \quad \psi(n + \frac{1}{2}) = -\gamma - 2 \ln 2 + 2 \left( 1 + \frac{1}{3} + \dots + \frac{1}{2n-1} \right), \\ n = 1, 2, \dots$$

$$5.4.16 \quad \Im \psi(iy) = \frac{1}{2y} + \frac{\pi}{2} \coth(\pi y),$$

$$5.4.17 \quad \Im \psi(\frac{1}{2} + iy) = \frac{\pi}{2} \tanh(\pi y),$$

$$5.4.18 \quad \Im \psi(1 + iy) = -\frac{1}{2y} + \frac{\pi}{2} \coth(\pi y).$$

If  $p, q$  are integers with  $0 < p < q$ , then

$$5.4.19 \quad \begin{aligned} \psi\left(\frac{p}{q}\right) &= -\gamma - \ln q - \frac{\pi}{2} \cot\left(\frac{\pi p}{q}\right) \\ &\quad + \frac{1}{2} \sum_{k=1}^{q-1} \cos\left(\frac{2\pi kp}{q}\right) \ln\left(2 - 2 \cos\left(\frac{2\pi k}{q}\right)\right). \end{aligned}$$

**5.4(iii) Extrema**

Table 5.4.1:  $\Gamma'(x_n) = \psi(x_n) = 0$ .

$n$	$x_n$	$\Gamma(x_n)$
0	1.46163 21449	0.88560 31944
1	-0.50408 30083	-3.54464 36112
2	-1.57349 84732	2.30240 72583
3	-2.61072 08875	-0.88813 63584
4	-3.63529 33665	0.24512 75398
5	-4.65323 77626	-0.05277 96396
6	-5.66716 24513	0.00932 45945
7	-6.67841 82649	-0.00139 73966
8	-7.68778 83250	0.00018 18784
9	-8.69576 41633	-0.00002 09253
10	-9.70267 25406	0.00000 21574

Compare Figure 5.3.1.

As  $n \rightarrow \infty$ ,

5.4.20 
$$x_n = -n + \frac{1}{\pi} \arctan\left(\frac{\pi}{\ln n}\right) + O\left(\frac{1}{n(\ln n)^2}\right).$$

For error bounds for this estimate see Walker (2007, Theorem 5).

**5.5 Functional Relations**

**5.5(i) Recurrence**

5.5.1 
$$\Gamma(z + 1) = z\Gamma(z),$$

5.5.2 
$$\psi(z + 1) = \psi(z) + \frac{1}{z}.$$

**5.5(ii) Reflection**

5.5.3 
$$\Gamma(z)\Gamma(1 - z) = \pi / \sin(\pi z), \quad z \neq 0, \pm 1, \dots,$$

5.5.4 
$$\psi(z) - \psi(1 - z) = -\pi / \tan(\pi z), \quad z \neq 0, \pm 1, \dots$$

**5.5(iii) Multiplication**

**Duplication Formula**

For  $2z \neq 0, -1, -2, \dots$ ,

5.5.5 
$$\Gamma(2z) = \pi^{-1/2} 2^{2z-1} \Gamma(z)\Gamma\left(z + \frac{1}{2}\right).$$

**Gauss's Multiplication Formula**

For  $nz \neq 0, -1, -2, \dots$ ,

5.5.6 
$$\Gamma(nz) = (2\pi)^{(1-n)/2} n^{nz-(1/2)} \prod_{k=0}^{n-1} \Gamma\left(z + \frac{k}{n}\right).$$

5.5.7 
$$\prod_{k=1}^{n-1} \Gamma\left(\frac{k}{n}\right) = (2\pi)^{(n-1)/2} n^{-1/2}.$$

5.5.8 
$$\psi(2z) = \frac{1}{2} (\psi(z) + \psi(z + \frac{1}{2})) + \ln 2,$$

5.5.9 
$$\psi(nz) = \frac{1}{n} \sum_{k=0}^{n-1} \psi\left(z + \frac{k}{n}\right) + \ln n.$$

**5.5(iv) Bohr–Mollerup Theorem**

If a positive function  $f(x)$  on  $(0, \infty)$  satisfies  $f(x + 1) = xf(x)$ ,  $f(1) = 1$ , and  $\ln f(x)$  is convex (see §1.4(viii)), then  $f(x) = \Gamma(x)$ .

**5.6 Inequalities**

**5.6(i) Real Variables**

Throughout this subsection  $x > 0$ .

5.6.1 
$$1 < (2\pi)^{-1/2} x^{(1/2)-x} e^x \Gamma(x) < e^{1/(12x)},$$

5.6.2 
$$\frac{1}{\Gamma(x)} + \frac{1}{\Gamma(1/x)} \leq 2,$$

5.6.3 
$$\frac{1}{(\Gamma(x))^2} + \frac{1}{(\Gamma(1/x))^2} \leq 2,$$

**Gautschi's Inequality**

5.6.4 
$$x^{1-s} < \frac{\Gamma(x+1)}{\Gamma(x+s)} < (x+1)^{1-s}, \quad 0 < s < 1.$$

5.6.5 
$$\exp\left((1-s)\psi\left(x + s^{1/2}\right)\right) \leq \frac{\Gamma(x+1)}{\Gamma(x+s)} \leq \exp\left((1-s)\psi\left(x + \frac{1}{2}(s+1)\right)\right),$$

$0 < s < 1.$

**5.6(ii) Complex Variables**

5.6.6 
$$|\Gamma(x + iy)| \leq |\Gamma(x)|,$$

5.6.7 
$$|\Gamma(x + iy)| \geq (\operatorname{sech}(\pi y))^{1/2} \Gamma(x), \quad x \geq \frac{1}{2}.$$

For  $b - a \geq 1$ ,  $a \geq 0$ , and  $z = x + iy$  with  $x > 0$ ,

5.6.8 
$$\left| \frac{\Gamma(z+a)}{\Gamma(z+b)} \right| \leq \frac{1}{|z|^{b-a}}.$$

For  $x \geq 0$ ,

5.6.9 
$$|\Gamma(z)| \leq (2\pi)^{1/2} |z|^{x-(1/2)} e^{-\pi|y|/2} \exp\left(\frac{1}{6}|z|^{-1}\right).$$

### 5.7 Series Expansions

#### 5.7(i) Maclaurin and Taylor Series

Throughout this subsection  $\zeta(k)$  is as in Chapter 25.

$$5.7.1 \quad \frac{1}{\Gamma(z)} = \sum_{k=1}^{\infty} c_k z^k,$$

where  $c_1 = 1$ ,  $c_2 = \gamma$ , and

$$5.7.2 \quad (k-1)c_k = \gamma c_{k-1} - \zeta(2)c_{k-2} + \zeta(3)c_{k-3} - \dots + (-1)^k \zeta(k-1)c_1, \quad k \geq 3.$$

For 15D numerical values of  $c_k$  see Abramowitz and Stegun (1964, p. 256), and for 31D values see Wrench (1968).

$$5.7.3 \quad \ln \Gamma(1+z) = -\ln(1+z) + z(1-\gamma) + \sum_{k=2}^{\infty} (-1)^k (\zeta(k) - 1) \frac{z^k}{k}, \quad |z| < 2.$$

$$5.7.4 \quad \psi(1+z) = -\gamma + \sum_{k=2}^{\infty} (-1)^k \zeta(k) z^{k-1}, \quad |z| < 1,$$

$$\psi(1+z) = \frac{1}{2z} - \frac{\pi}{2} \cot(\pi z) + \frac{1}{z^2 - 1} + 1$$

$$5.7.5 \quad -\gamma - \sum_{k=1}^{\infty} (\zeta(2k+1) - 1) z^{2k}, \quad |z| < 2, z \neq 0, \pm 1.$$

For 20D numerical values of the coefficients of the Maclaurin series for  $\Gamma(z+3)$  see Luke (1969b, p. 299).

#### 5.7(ii) Other Series

When  $z \neq 0, -1, -2, \dots$ ,

$$5.7.6 \quad \begin{aligned} \psi(z) &= -\gamma - \frac{1}{z} + \sum_{k=1}^{\infty} \frac{z}{k(k+z)} \\ &= -\gamma + \sum_{k=0}^{\infty} \left( \frac{1}{k+1} - \frac{1}{k+z} \right), \end{aligned}$$

and

$$5.7.7 \quad \psi\left(\frac{z+1}{2}\right) - \psi\left(\frac{z}{2}\right) = 2 \sum_{k=0}^{\infty} \frac{(-1)^k}{k+z}.$$

Also,

$$5.7.8 \quad \Im \psi(1+iy) = \sum_{k=1}^{\infty} \frac{y}{k^2 + y^2}.$$

### 5.8 Infinite Products

$$5.8.1 \quad \Gamma(z) = \lim_{k \rightarrow \infty} \frac{k! k^z}{z(z+1) \cdots (z+k)}, \quad z \neq 0, -1, -2, \dots,$$

$$5.8.2 \quad \frac{1}{\Gamma(z)} = z e^{\gamma z} \prod_{k=1}^{\infty} \left(1 + \frac{z}{k}\right) e^{-z/k},$$

$$5.8.3 \quad \left| \frac{\Gamma(x)}{\Gamma(x+iy)} \right|^2 = \prod_{k=0}^{\infty} \left(1 + \frac{y^2}{(x+k)^2}\right), \quad x \neq 0, -1, \dots$$

If

$$5.8.4 \quad \sum_{k=1}^m a_k = \sum_{k=1}^m b_k,$$

then

$$5.8.5 \quad \begin{aligned} \prod_{k=0}^{\infty} \frac{(a_1+k)(a_2+k) \cdots (a_m+k)}{(b_1+k)(b_2+k) \cdots (b_m+k)} \\ = \frac{\Gamma(b_1)\Gamma(b_2) \cdots \Gamma(b_m)}{\Gamma(a_1)\Gamma(a_2) \cdots \Gamma(a_m)}, \end{aligned}$$

provided that none of the  $b_k$  is zero or a negative integer.

### 5.9 Integral Representations

#### 5.9(i) Gamma Function

$$5.9.1 \quad \frac{1}{\mu} \Gamma\left(\frac{\nu}{\mu}\right) \frac{1}{z^{\nu/\mu}} = \int_0^{\infty} \exp(-zt^{\mu}) t^{\nu-1} dt,$$

$\Re \nu > 0$ ,  $\mu > 0$ , and  $\Re z > 0$ . (The fractional powers have their principal values.)

#### Hankel's Loop Integral

$$5.9.2 \quad \frac{1}{\Gamma(z)} = \frac{1}{2\pi i} \int_{-\infty}^{(0+)} e^t t^{-z} dt,$$

where the contour begins at  $-\infty$ , circles the origin once in the positive direction, and returns to  $-\infty$ .  $t^{-z}$  has its principal value where  $t$  crosses the positive real axis, and is continuous. See Figure 5.9.1.

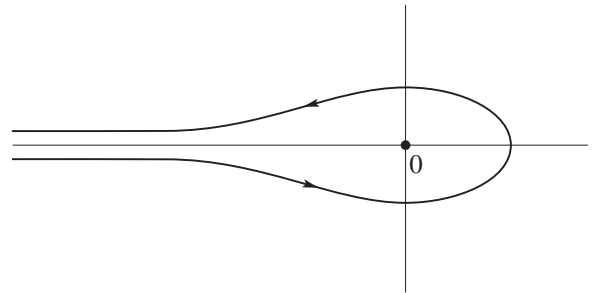


Figure 5.9.1:  $t$ -plane. Contour for Hankel's loop integral.

$$5.9.3 \quad c^{-z} \Gamma(z) = \int_{-\infty}^{\infty} |t|^{2z-1} e^{-ct^2} dt, \quad c > 0, \Re z > 0,$$

where the path is the real axis.

$$5.9.4 \quad \Gamma(z) = \int_1^{\infty} t^{z-1} e^{-t} dt + \sum_{k=0}^{\infty} \frac{(-1)^k}{(z+k)k!}, \quad z \neq 0, -1, -2, \dots$$

$$5.9.5 \quad \Gamma(z) = \int_0^\infty t^{z-1} \left( e^{-t} - \sum_{k=0}^n \frac{(-1)^k t^k}{k!} \right) dt, \\ -n-1 < \Re z < -n.$$

$$5.9.6 \quad \Gamma(z) \cos\left(\frac{1}{2}\pi z\right) = \int_0^\infty t^{z-1} \cos t \, dt, \quad 0 < \Re z < 1,$$

$$5.9.7 \quad \Gamma(z) \sin\left(\frac{1}{2}\pi z\right) = \int_0^\infty t^{z-1} \sin t \, dt, \quad -1 < \Re z < 1.$$

$$5.9.8 \quad \Gamma\left(1 + \frac{1}{n}\right) \cos\left(\frac{\pi}{2n}\right) = \int_0^\infty \cos(t^n) \, dt, \quad n = 2, 3, 4, \dots,$$

$$5.9.9 \quad \Gamma\left(1 + \frac{1}{n}\right) \sin\left(\frac{\pi}{2n}\right) = \int_0^\infty \sin(t^n) \, dt, \quad n = 2, 3, 4, \dots$$

#### Binet's Formula

$$5.9.10 \quad \ln \Gamma(z) = \left(z - \frac{1}{2}\right) \ln z - z + \frac{1}{2} \ln(2\pi) \\ + 2 \int_0^\infty \frac{\arctan(t/z)}{e^{2\pi t} - 1} \, dt,$$

where  $|\operatorname{ph} z| < \pi/2$  and the inverse tangent has its principal value.

$$5.9.11 \quad \ln \Gamma(z+1) = -\gamma z - \frac{1}{2\pi i} \int_{-c-\infty i}^{-c+\infty i} \frac{\pi z^{-s}}{s \sin(\pi s)} \zeta(-s) \, ds,$$

where  $|\operatorname{ph} z| \leq \pi - \delta$  ( $< \pi$ ),  $1 < c < 2$ , and  $\zeta(s)$  is as in Chapter 25.

For additional representations see Whittaker and Watson (1927, §§12.31–12.32).

#### 5.9(ii) Psi Function, Euler's Constant, and Derivatives

For  $\Re z > 0$ ,

$$5.9.12 \quad \psi(z) = \int_0^\infty \left( \frac{e^{-t}}{t} - \frac{e^{-zt}}{1-e^{-t}} \right) dt,$$

$$5.9.13 \quad \psi(z) = \ln z + \int_0^\infty \left( \frac{1}{t} - \frac{1}{1-e^{-t}} \right) e^{-tz} \, dt,$$

$$5.9.14 \quad \psi(z) = \int_0^\infty \left( e^{-t} - \frac{1}{(1+t)^z} \right) \frac{dt}{t},$$

$$5.9.15 \quad \psi(z) = \ln z - \frac{1}{2z} - 2 \int_0^\infty \frac{t \, dt}{(t^2 + z^2)(e^{2\pi t} - 1)}.$$

$$5.9.16 \quad \psi(z) + \gamma = \int_0^\infty \frac{e^{-t} - e^{-zt}}{1-e^{-t}} \, dt = \int_0^1 \frac{1-t^{z-1}}{1-t} \, dt.$$

$$5.9.17 \quad \psi(z+1) = -\gamma + \frac{1}{2\pi i} \int_{-c-\infty i}^{-c+\infty i} \frac{\pi z^{-s-1}}{\sin(\pi s)} \zeta(-s) \, ds,$$

where  $|\operatorname{ph} z| \leq \pi - \delta$  ( $< \pi$ ) and  $1 < c < 2$ .

$$\gamma = - \int_0^\infty e^{-t} \ln t \, dt = \int_0^\infty \left( \frac{1}{1+t} - e^{-t} \right) \frac{dt}{t}$$

$$5.9.18 \quad = \int_0^1 (1-e^{-t}) \frac{dt}{t} - \int_1^\infty e^{-t} \frac{dt}{t} \\ = \int_0^\infty \left( \frac{e^{-t}}{1-e^{-t}} - \frac{e^{-t}}{t} \right) dt.$$

$$5.9.19 \quad \Gamma^{(n)}(z) = \int_0^\infty (\ln t)^n e^{-t} t^{z-1} \, dt, \quad n \geq 0, \Re z > 0.$$

#### 5.10 Continued Fractions

For  $\Re z > 0$ ,

$$5.10.1 \quad \ln \Gamma(z) + z - \left(z - \frac{1}{2}\right) \ln z - \frac{1}{2} \ln(2\pi) \\ = \frac{a_0}{z +} \frac{a_1}{z +} \frac{a_2}{z +} \frac{a_3}{z +} \frac{a_4}{z +} \frac{a_5}{z +} \dots,$$

where

$$5.10.2 \quad a_0 = \frac{1}{12}, \quad a_1 = \frac{1}{30}, \quad a_2 = \frac{53}{210}, \quad a_3 = \frac{195}{371}, \\ a_4 = \frac{22999}{22737}, \quad a_5 = \frac{299 \, 44523}{197 \, 33142}, \quad a_6 = \frac{10 \, 95352 \, 41009}{4 \, 82642 \, 75462}.$$

For exact values of  $a_7$  to  $a_{11}$  and 40S values of  $a_0$  to  $a_{40}$ , see Char (1980). Also see Cuyt *et al.* (2008, pp. 223–228), Jones and Thron (1980, pp. 348–350), and Lorentzen and Waadeland (1992, pp. 221–224) for further information.

#### 5.11 Asymptotic Expansions

##### 5.11(i) Poincaré-Type Expansions

As  $z \rightarrow \infty$  in the sector  $|\operatorname{ph} z| \leq \pi - \delta$  ( $< \pi$ ),

$$5.11.1 \quad \ln \Gamma(z) \\ \sim \left(z - \frac{1}{2}\right) \ln z - z + \frac{1}{2} \ln(2\pi) + \sum_{k=1}^{\infty} \frac{B_{2k}}{2k(2k-1)z^{2k-1}}$$

and

$$5.11.2 \quad \psi(z) \sim \ln z - \frac{1}{2z} - \sum_{k=1}^{\infty} \frac{B_{2k}}{2k z^{2k}}.$$

For the Bernoulli numbers  $B_{2k}$ , see §24.2(i).

With the same conditions,

$$5.11.3 \quad \Gamma(z) \sim e^{-z} z^z \left(\frac{2\pi}{z}\right)^{1/2} \left(\sum_{k=0}^{\infty} \frac{g_k}{z^k}\right),$$

where

$$5.11.4 \quad g_0 = 1, \quad g_1 = \frac{1}{12}, \quad g_2 = \frac{1}{288}, \quad g_3 = -\frac{139}{51840}, \\ g_4 = -\frac{571}{24 \, 88320}, \quad g_5 = \frac{1 \, 63879}{2090 \, 18880}, \quad g_6 = \frac{52 \, 46819}{7 \, 52467 \, 96800}.$$

Also,

$$5.11.5 \quad g_k = \sqrt{2} \left(\frac{1}{2}\right)_k a_{2k},$$

where  $a_0 = \frac{1}{2}\sqrt{2}$  and

$$\begin{aligned} & a_0 a_k + \frac{1}{2} a_1 a_{k-1} + \frac{1}{3} a_2 a_{k-2} + \cdots + \frac{1}{k+1} a_k a_0 \\ \text{5.11.6} \quad & = \frac{1}{k} a_{k-1}, \quad k \geq 1. \end{aligned}$$

Wrench (1968) gives exact values of  $g_k$  up to  $g_{20}$ . Spira (1971) corrects errors in Wrench's results and also supplies exact and 45D values of  $g_k$  for  $k = 21, 22, \dots, 30$ . For an asymptotic expansion of  $g_k$  as  $k \rightarrow \infty$  see Boyd (1994).

**Terminology**

The expansion (5.11.1) is called *Stirling's series* (Whittaker and Watson (1927, §12.33)), whereas the expansion (5.11.3), or sometimes just its leading term, is known as *Stirling's formula* (Abramowitz and Stegun (1964, §6.1), Olver (1997b, p. 88)).

Next, and again with the same conditions,

$$\text{5.11.7} \quad \Gamma(az + b) \sim \sqrt{2\pi} e^{-az} (az)^{az+b-(1/2)},$$

where  $a (> 0)$  and  $b (\in \mathbb{C})$  are both fixed, and

$$\begin{aligned} \text{5.11.8} \quad \ln \Gamma(z + h) & \sim (z + h - \tfrac{1}{2}) \ln z - z + \tfrac{1}{2} \ln(2\pi) \\ & + \sum_{k=2}^{\infty} \frac{(-1)^k B_k(h)}{k(k-1)z^{k-1}}, \end{aligned}$$

where  $h (\in [0, 1])$  is fixed, and  $B_k(h)$  is the Bernoulli polynomial defined in §24.2(i).

Lastly, as  $y \rightarrow \pm\infty$ ,

$$\text{5.11.9} \quad |\Gamma(x + iy)| \sim \sqrt{2\pi} |y|^{x-(1/2)} e^{-\pi|y|/2},$$

uniformly for bounded real values of  $x$ .

**5.11(ii) Error Bounds and Exponential Improvement**

If the sums in the expansions (5.11.1) and (5.11.2) are terminated at  $k = n - 1$  ( $k \geq 0$ ) and  $z$  is real and positive, then the remainder terms are bounded in magnitude by the first neglected terms and have the same sign. If  $z$  is complex, then the remainder terms are bounded in magnitude by  $\sec^{2n}(\frac{1}{2} \text{ph } z)$  for (5.11.1), and  $\sec^{2n+1}(\frac{1}{2} \text{ph } z)$  for (5.11.2), times the first neglected terms.

For the remainder term in (5.11.3) write

$$\begin{aligned} \text{5.11.10} \quad \Gamma(z) & = e^{-z} z^z \left( \frac{2\pi}{z} \right)^{1/2} \left( \sum_{k=0}^{K-1} \frac{g_k}{z^k} + R_K(z) \right), \\ & \quad K = 1, 2, 3, \dots \end{aligned}$$

Then

$$\begin{aligned} \text{5.11.11} \quad |R_K(z)| & \leq \frac{(1 + \zeta(K)) \Gamma(K)}{2(2\pi)^{K+1} |z|^K} \left( 1 + \min(\sec(\text{ph } z), 2K^{1/2}) \right), \\ & \quad |\text{ph } z| \leq \tfrac{1}{2}\pi, \end{aligned}$$

where  $\zeta(K)$  is as in Chapter 25. For this result and a similar bound for the sector  $\frac{1}{2}\pi \leq \text{ph } z \leq \pi$  see Boyd (1994).

For further information see Olver (1997b, pp. 293–295), and for other error bounds see Whittaker and Watson (1927, §12.33), Spira (1971), and Schäfke and Finsterer (1990).

For re-expansions of the remainder terms in (5.11.1) and (5.11.3) in series of incomplete gamma functions with exponential improvement (§2.11(iii)) in the asymptotic expansions, see Berry (1991), Boyd (1994), and Paris and Kaminski (2001, §6.4).

**5.11(iii) Ratios**

In this subsection  $a$ ,  $b$ , and  $c$  are real or complex constants.

If  $z \rightarrow \infty$  in the sector  $|\text{ph } z| \leq \pi - \delta$  ( $< \pi$ ), then

$$\text{5.11.12} \quad \frac{\Gamma(z + a)}{\Gamma(z + b)} \sim z^{a-b},$$

$$\text{5.11.13} \quad \frac{\Gamma(z + a)}{\Gamma(z + b)} \sim z^{a-b} \sum_{k=0}^{\infty} \frac{G_k(a, b)}{z^k}.$$

Also, with the added condition  $\Re(b - a) > 0$ ,

$$\begin{aligned} \text{5.11.14} \quad & \frac{\Gamma(z + a)}{\Gamma(z + b)} \\ & \sim \left( z + \frac{a + b - 1}{2} \right)^{a-b} \sum_{k=0}^{\infty} \frac{H_k(a, b)}{\left( z + \frac{1}{2}(a + b - 1) \right)^{2k}}. \end{aligned}$$

Here

$$\begin{aligned} \text{5.11.15} \quad G_0(a, b) & = 1, \quad G_1(a, b) = \tfrac{1}{2}(a - b)(a + b - 1), \\ G_2(a, b) & = \frac{1}{12} \binom{a - b}{2} (3(a + b - 1)^2 - (a - b + 1)), \end{aligned}$$

$$\begin{aligned} \text{5.11.16} \quad H_0(a, b) & = 1, \quad H_1(a, b) = -\frac{1}{12} \binom{a - b}{2} (a - b + 1), \\ H_2(a, b) & = \frac{1}{240} \binom{a - b}{4} (2(a - b + 1) + 5(a - b + 1)^2). \end{aligned}$$

In terms of generalized Bernoulli polynomials  $B_n^{(\ell)}(x)$  (§24.16(i)), we have for  $k = 0, 1, \dots$ ,

$$\text{5.11.17} \quad G_k(a, b) = \binom{a - b}{k} B_k^{(a-b+1)}(a),$$

$$\text{5.11.18} \quad H_k(a, b) = \binom{a - b}{2k} B_{2k}^{(a-b+1)}\left(\frac{a - b + 1}{2}\right).$$

Lastly, and again if  $z \rightarrow \infty$  in the sector  $|\text{ph } z| \leq$

$\pi - \delta (< \pi)$ , then

**5.11.19**

$$\frac{\Gamma(z+a)\Gamma(z+b)}{\Gamma(z+c)} \sim \sum_{k=0}^{\infty} (-1)^k \frac{(c-a)_k (c-b)_k}{k!} \Gamma(a+b-c+z-k).$$

For the error term in (5.11.19) in the case  $z = x (> 0)$  and  $c = 1$ , see Olver (1995).

**5.12 Beta Function**

In this section all fractional powers have their principal values, except where noted otherwise. In (5.12.1)–(5.12.4) it is assumed  $\Re a > 0$  and  $\Re b > 0$ .

**Euler's Beta Integral**

**5.12.1**  $B(a, b) = \int_0^1 t^{a-1}(1-t)^{b-1} dt = \frac{\Gamma(a)\Gamma(b)}{\Gamma(a+b)}.$

**5.12.2**  $\int_0^{\pi/2} \sin^{2a-1} \theta \cos^{2b-1} \theta d\theta = \frac{1}{2} B(a, b).$

**5.12.3**  $\int_0^{\infty} \frac{t^{a-1} dt}{(1+t)^{a+b}} = B(a, b).$

**5.12.4**  $\int_0^1 \frac{t^{a-1}(1-t)^{b-1}}{(t+z)^{a+b}} dt = B(a, b)(1+z)^{-a} z^{-b}, \quad |\text{ph } z| < \pi.$

**5.12.5**  $\int_0^{\pi/2} (\cos t)^{a-1} \cos(bt) dt = \frac{\pi}{2^a} a B(\frac{1}{2}(a+b+1), \frac{1}{2}(a-b+1)), \quad \Re a > 0.$

**5.12.6**  $\int_0^{\pi} (\sin t)^{a-1} e^{ibt} dt = \frac{\pi}{2^{a-1}} \frac{e^{i\pi b/2}}{a B(\frac{1}{2}(a+b+1), \frac{1}{2}(a-b+1))}, \quad \Re a > 0.$

**5.12.7**  $\int_0^{\infty} \frac{\cosh(2bt)}{(\cosh t)^{2a}} dt = 4^{a-1} B(a+b, a-b), \quad \Re a > |\Re b|.$

**5.12.8**  $\frac{1}{2\pi} \int_{-\infty}^{\infty} \frac{dt}{(w+it)^a (z-it)^b} = \frac{(w+z)^{1-a-b}}{(a+b-1) B(a, b)}, \quad \Re(a+b) > 1, \Re w > 0, \Re z > 0.$

In (5.12.8) the fractional powers have their principal values when  $w > 0$  and  $z > 0$ , and are continued via continuity.

**5.12.9**  $\frac{1}{2\pi i} \int_{c-\infty i}^{c+\infty i} t^{-a}(1-t)^{-1-b} dt = \frac{1}{b B(a, b)}, \quad 0 < c < 1, \Re(a+b) > 0.$

**5.12.10**  $\frac{1}{2\pi i} \int_0^{(1+)} t^{a-1}(t-1)^{b-1} dt = \frac{\sin(\pi b)}{\pi} B(a, b), \quad \Re a > 0,$

with the contour as shown in Figure 5.12.1.

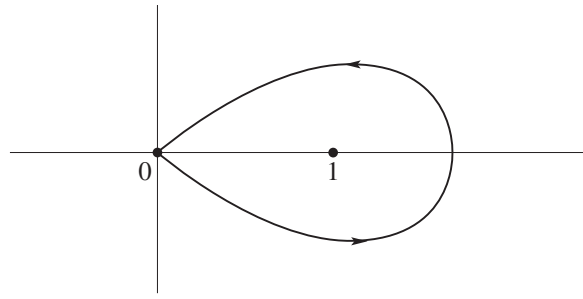


Figure 5.12.1:  $t$ -plane. Contour for first loop integral for the beta function.

In (5.12.11) and (5.12.12) the fractional powers are continuous on the integration paths and take their principal values at the beginning.

**5.12.11**  $\frac{1}{e^{2\pi i a} - 1} \int_{\infty}^{(0+)} t^{a-1}(1+t)^{-a-b} dt = B(a, b),$

when  $\Re b > 0$ ,  $a$  is not an integer and the contour cuts the real axis between  $-1$  and the origin. See Figure 5.12.2.

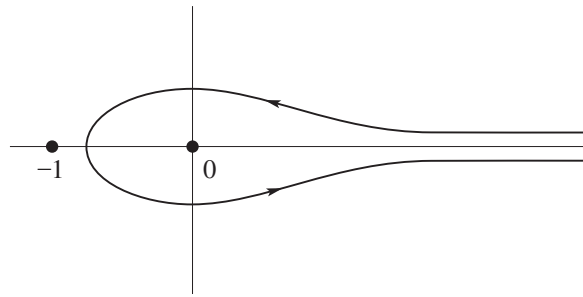


Figure 5.12.2:  $t$ -plane. Contour for second loop integral for the beta function.

**Pochhammer's Integral**

When  $a, b \in \mathbb{C}$

**5.12.12**  $\int_P^{(1+, 0+, 1-, 0-)} t^{a-1}(1-t)^{b-1} dt = -4e^{\pi i(a+b)} \sin(\pi a) \sin(\pi b) B(a, b),$

where the contour starts from an arbitrary point  $P$  in the interval  $(0, 1)$ , circles 1 and then 0 in the positive sense, circles 1 and then 0 in the negative sense, and returns to  $P$ . It can always be deformed into the contour shown in Figure 5.12.3.

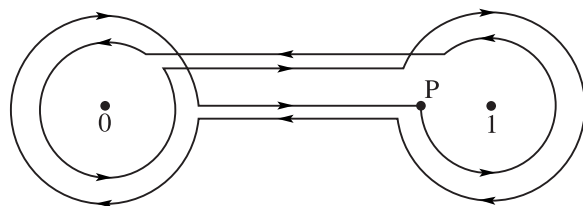


Figure 5.12.3:  $t$ -plane. Contour for Pochhammer's integral.

### 5.13 Integrals

In (5.13.1) the integration path is a straight line parallel to the imaginary axis.

$$5.13.1 \quad \frac{1}{2\pi i} \int_{c-i\infty}^{c+i\infty} \Gamma(s+a)\Gamma(b-s)z^{-s} ds = \frac{\Gamma(a+b)z^a}{(1+z)^{a+b}}, \quad \Re(a+b) > 0, -\Re a < c < \Re b, |\text{ph } z| < \pi.$$

$$5.13.2 \quad \frac{1}{2\pi} \int_{-\infty}^{\infty} |\Gamma(a+it)|^2 e^{(2b-\pi)t} dt = \frac{\Gamma(2a)}{(2\sin b)^{2a}}, \quad a > 0, 0 < b < \pi.$$

**Barnes' Beta Integral**

$$5.13.3 \quad \frac{1}{2\pi} \int_{-\infty}^{\infty} \Gamma(a+it)\Gamma(b+it)\Gamma(c-it)\Gamma(d-it) dt = \frac{\Gamma(a+c)\Gamma(a+d)\Gamma(b+c)\Gamma(b+d)}{\Gamma(a+b+c+d)}, \quad \Re a, \Re b, \Re c, \Re d > 0.$$

**Ramanujan's Beta Integral**

$$5.13.4 \quad \int_{-\infty}^{\infty} \frac{dt}{\Gamma(a+t)\Gamma(b+t)\Gamma(c-t)\Gamma(d-t)} = \frac{\Gamma(a+b+c+d-3)}{\Gamma(a+c-1)\Gamma(a+d-1)\Gamma(b+c-1)\Gamma(b+d-1)}, \quad \Re(a+b+c+d) > 3.$$

**de Branges–Wilson Beta Integral**

$$5.13.5 \quad \frac{1}{4\pi} \int_{-\infty}^{\infty} \frac{\prod_{k=1}^4 \Gamma(a_k+it)\Gamma(a_k-it)}{\Gamma(2it)\Gamma(-2it)} dt = \frac{\prod_{1 \leq j < k \leq 4} \Gamma(a_j+a_k)}{\Gamma(a_1+a_2+a_3+a_4)}, \quad \Re(a_k) > 0, k=1,2,3,4.$$

For compendia of integrals of gamma functions see Apelblat (1983, pp. 124–127 and 129–130), Erdélyi *et al.* (1954a,b), Gradshteyn and Ryzhik (2000, pp. 644–652), Oberhettinger (1974, pp. 191–204), Oberhettinger and Badii (1973, pp. 307–316), Prudnikov *et al.* (1986b, pp. 57–64), Prudnikov *et al.* (1992a, pp. 127–130), and Prudnikov *et al.* (1992b, pp. 113–123).

### 5.14 Multidimensional Integrals

Let  $V_n$  be the simplex:  $t_1 + t_2 + \dots + t_n \leq 1, t_k \geq 0$ . Then for  $\Re z_k > 0, k=1,2,\dots,n+1$ ,

$$5.14.1 \quad \int_{V_n} t_1^{z_1-1} t_2^{z_2-1} \dots t_n^{z_n-1} dt_1 dt_2 \dots dt_n = \frac{\Gamma(z_1)\Gamma(z_2)\dots\Gamma(z_n)}{\Gamma(1+z_1+z_2+\dots+z_n)},$$

$$5.14.2 \quad \int_{V_n} \left(1 - \sum_{k=1}^n t_k\right)^{z_{n+1}-1} \prod_{k=1}^n t_k^{z_k-1} dt_k = \frac{\Gamma(z_1)\Gamma(z_2)\dots\Gamma(z_{n+1})}{\Gamma(z_1+z_2+\dots+z_{n+1})}.$$

**Selberg-type Integrals**

Let

$$5.14.3 \quad \Delta(t_1, t_2, \dots, t_n) = \prod_{1 \leq j < k \leq n} (t_j - t_k).$$

Then

$$5.14.4 \quad \int_{[0,1]^n} t_1 t_2 \dots t_m |\Delta(t_1, \dots, t_n)|^{2c} \prod_{k=1}^n t_k^{a-1} (1-t_k)^{b-1} dt_k = \frac{1}{(\Gamma(1+c))^n} \prod_{k=1}^m \frac{a+(n-k)c}{a+b+(2n-k-1)c} \\ \times \prod_{k=1}^n \frac{\Gamma(a+(n-k)c)\Gamma(b+(n-k)c)\Gamma(1+kc)}{\Gamma(a+b+(2n-k-1)c)},$$

provided that  $\Re a, \Re b > 0, \Re c > -\min(1/n, \Re a/(n-1), \Re b/(n-1))$ .

Secondly,

$$5.14.5 \quad \int_{[0,\infty)^n} t_1 t_2 \dots t_m |\Delta(t_1, \dots, t_n)|^{2c} \prod_{k=1}^n t_k^{a-1} e^{-t_k} dt_k = \prod_{k=1}^m (a+(n-k)c) \frac{\prod_{k=1}^n \Gamma(a+(n-k)c)\Gamma(1+kc)}{(\Gamma(1+c))^n},$$

when  $\Re a > 0, \Re c > -\min(1/n, \Re a/(n-1))$ .

Thirdly,

$$5.14.6 \quad \frac{1}{(2\pi)^{n/2}} \int_{(-\infty,\infty)^n} |\Delta(t_1, \dots, t_n)|^{2c} \prod_{k=1}^n \exp(-\frac{1}{2}t_k^2) dt_k = \frac{\prod_{k=1}^n \Gamma(1+kc)}{(\Gamma(1+c))^n}, \quad \Re c > -1/n.$$



**Dyson's Integral**

5.14.7 
$$\frac{1}{(2\pi)^n} \int_{[-\pi, \pi]^n} \prod_{1 \leq j < k \leq n} |e^{i\theta_j} - e^{i\theta_k}|^{2b} d\theta_1 \cdots d\theta_n = \frac{\Gamma(1 + bn)}{(\Gamma(1 + b))^n}, \quad \Re b > -1/n.$$

**5.15 Polygamma Functions**

The functions  $\psi^{(n)}(z)$ ,  $n = 1, 2, \dots$ , are called the *polygamma functions*. In particular,  $\psi'(z)$  is the *trigamma function*;  $\psi''$ ,  $\psi^{(3)}$ ,  $\psi^{(4)}$  are the *tetra-*, *penta-*, and *hexagamma functions* respectively. Most properties of these functions follow straightforwardly by differentiation of properties of the psi function. This includes asymptotic expansions: compare §§2.1(ii)–2.1(iii).

In (5.15.2)–(5.15.7)  $n, m = 1, 2, 3, \dots$ , and for  $\zeta(n + 1)$  see §25.6(i).

5.15.1 
$$\psi'(z) = \sum_{k=0}^{\infty} \frac{1}{(k+z)^2}, \quad z \neq 0, -1, -2, \dots,$$

5.15.2 
$$\psi^{(n)}(1) = (-1)^{n+1} n! \zeta(n + 1),$$

5.15.3 
$$\psi^{(n)}\left(\frac{1}{2}\right) = (-1)^{n+1} n! (2^{n+1} - 1) \zeta(n + 1),$$

5.15.4 
$$\psi'\left(n - \frac{1}{2}\right) = \frac{1}{2}\pi^2 - 4 \sum_{k=1}^{n-1} \frac{1}{(2k-1)^2},$$

5.15.5 
$$\psi^{(n)}(z + 1) = \psi^{(n)}(z) + (-1)^n n! z^{-n-1},$$

5.15.6 
$$\psi^{(n)}(1 - z) + (-1)^{n-1} \psi^{(n)}(z) = (-1)^n \pi \frac{d^n}{dz^n} \cot(\pi z),$$

5.15.7 
$$\psi^{(n)}(mz) = \frac{1}{m^{n+1}} \sum_{k=0}^{m-1} \psi^{(n)}\left(z + \frac{k}{m}\right).$$

As  $z \rightarrow \infty$  in  $|\text{ph } z| \leq \pi - \delta (< \pi)$

5.15.8 
$$\psi'(z) \sim \frac{1}{z} + \frac{1}{2z^2} + \sum_{k=1}^{\infty} \frac{B_{2k}}{z^{2k+1}}.$$

For  $B_{2k}$  see §24.2(i).

For continued fractions for  $\psi'(z)$  and  $\psi''(z)$  see Cuyt *et al.* (2008, pp. 231–238).

**5.16 Sums**

5.16.1 
$$\sum_{k=1}^{\infty} (-1)^k \psi'(k) = -\frac{\pi^2}{8},$$

5.16.2 
$$\sum_{k=1}^{\infty} \frac{1}{k} \psi'(k + 1) = \zeta(3) = -\frac{1}{2} \psi''(1).$$

For further sums involving the psi function see Hansen (1975, pp. 360–367). For sums of gamma functions see Andrews *et al.* (1999, Chapters 2 and 3) and §§15.2(i), 16.2.

For related sums involving finite field analogs of the gamma and beta functions (Gauss and Jacobi sums) see Andrews *et al.* (1999, Chapter 1) and Terras (1999, pp. 90, 149).

**5.17 Barnes' G-Function (Double Gamma Function)**

5.17.1 
$$G(z + 1) = \Gamma(z) G(z), \quad G(1) = 1,$$

5.17.2 
$$G(n) = (n - 2)!(n - 3)! \cdots 1!, \quad n = 2, 3, \dots$$

$$G(z + 1) = (2\pi)^{z/2} \exp\left(-\frac{1}{2}z(z + 1) - \frac{1}{2}\gamma z^2\right)$$

5.17.3 
$$\times \prod_{k=1}^{\infty} \left( \left(1 + \frac{z}{k}\right)^k \exp\left(-z + \frac{z^2}{2k}\right) \right).$$

5.17.4 
$$\text{Ln } G(z + 1) = \frac{1}{2}z \ln(2\pi) - \frac{1}{2}z(z + 1) + z \text{Ln } \Gamma(z + 1) - \int_0^z \text{Ln } \Gamma(t + 1) dt.$$

In this equation (and in (5.17.5) below), the Ln's have their principal values on the positive real axis and are continued via continuity, as in §4.2(i).

When  $z \rightarrow \infty$  in  $|\text{ph } z| \leq \pi - \delta (< \pi)$ ,

5.17.5 
$$\text{Ln } G(z + 1) \sim \frac{1}{4}z^2 + z \Gamma(z + 1) - \left(\frac{1}{2}z(z + 1) + \frac{1}{12}\right) \text{Ln } z - \ln A + \sum_{k=1}^{\infty} \frac{B_{2k+2}}{2k(2k + 1)(2k + 2)z^{2k}};$$

see Ferreira and López (2001). This reference also provides bounds for the error term. Here  $B_{2k+2}$  is the Bernoulli number (§24.2(i)), and  $A$  is *Glaisher's constant*, given by

5.17.6 
$$A = e^C = 1.28242\ 71291\ 00622\ 63687 \dots,$$

where

5.17.7 
$$C = \lim_{n \rightarrow \infty} \left( \sum_{k=1}^n k \ln k - \left(\frac{1}{2}n^2 + \frac{1}{2}n + \frac{1}{12}\right) \ln n + \frac{1}{4}n^2 \right) = \frac{\gamma + \ln(2\pi)}{12} - \frac{\zeta'(2)}{2\pi^2} = \frac{1}{12} - \zeta'(-1),$$

and  $\zeta'$  is the derivative of the zeta function (Chapter 25).

For Glaisher's constant see also Greene and Knuth (1982, p. 100) and §2.10(i).

## 5.18 $q$ -Gamma and Beta Functions

### 5.18(i) $q$ -Factorials

$$5.18.1 \quad (a; q)_n = \prod_{k=0}^{n-1} (1 - aq^k), \quad n = 0, 1, 2, \dots,$$

$$5.18.2 \quad n!_q = 1(1+q) \cdots (1+q+\cdots+q^{n-1}) = (q; q)_n (1-q)^{-n}.$$

When  $|q| < 1$ ,

$$5.18.3 \quad (a; q)_\infty = \prod_{k=0}^{\infty} (1 - aq^k).$$

See also §17.2(i).

### 5.18(ii) $q$ -Gamma Function

When  $0 < q < 1$ ,

$$5.18.4 \quad \Gamma_q(z) = (q; q)_\infty (1-q)^{1-z} / (q^z; q)_\infty,$$

$$5.18.5 \quad \Gamma_q(1) = \Gamma_q(2) = 1,$$

$$5.18.6 \quad n!_q = \Gamma_q(n+1),$$

$$5.18.7 \quad \Gamma_q(z+1) = \frac{1-q^z}{1-q} \Gamma_q(z).$$

Also,  $\ln \Gamma_q(x)$  is convex for  $x > 0$ , and the analog of the Bohr-Mollerup theorem (§5.5(iv)) holds.

If  $0 < q < r < 1$ , then

$$5.18.8 \quad \Gamma_q(x) < \Gamma_r(x),$$

when  $0 < x < 1$  or when  $x > 2$ , and

$$5.18.9 \quad \Gamma_q(x) > \Gamma_r(x),$$

when  $1 < x < 2$ .

$$5.18.10 \quad \lim_{q \rightarrow 1^-} \Gamma_q(z) = \Gamma(z).$$

For generalized asymptotic expansions of  $\ln \Gamma_q(z)$  as  $|z| \rightarrow \infty$  see Olde Daalhuis (1994) and Moak (1984).

### 5.18(iii) $q$ -Beta Function

$$5.18.11 \quad B_q(a, b) = \frac{\Gamma_q(a) \Gamma_q(b)}{\Gamma_q(a+b)}.$$

$$5.18.12 \quad B_q(a, b) = \int_0^1 \frac{t^{a-1} (tq; q)_\infty}{(tq^b; q)_\infty} d_q t, \\ 0 < q < 1, \Re a > 0, \Re b > 0.$$

For  $q$ -integrals see §17.2(v).

## Applications

### 5.19 Mathematical Applications

#### 5.19(i) Summation of Rational Functions

As shown in Temme (1996a, §3.4), the results given in §5.7(ii) can be used to sum infinite series of rational functions.

**Example**

$$5.19.1 \quad S = \sum_{k=0}^{\infty} a_k, \quad a_k = \frac{k}{(3k+2)(2k+1)(k+1)}.$$

By decomposition into partial fractions (§1.2(iii))

$$5.19.2 \quad a_k = \frac{2}{k + \frac{2}{3}} - \frac{1}{k + \frac{1}{2}} - \frac{1}{k+1} \\ = \left( \frac{1}{k+1} - \frac{1}{k + \frac{1}{2}} \right) - 2 \left( \frac{1}{k+1} - \frac{1}{k + \frac{2}{3}} \right).$$

Hence from (5.7.6), (5.4.13), and (5.4.19)

$$5.19.3 \quad S = \psi\left(\frac{1}{2}\right) - 2\psi\left(\frac{2}{3}\right) - \gamma = 3 \ln 3 - 2 \ln 2 - \frac{1}{3}\pi\sqrt{3}.$$

#### 5.19(ii) Mellin–Barnes Integrals

Many special functions  $f(z)$  can be represented as a *Mellin–Barnes integral*, that is, an integral of a product of gamma functions, reciprocals of gamma functions, and a power of  $z$ , the integration contour being doubly-infinite and eventually parallel to the imaginary axis at both ends. The left-hand side of (5.13.1) is a typical example. By translating the contour parallel to itself and summing the residues of the integrand, asymptotic expansions of  $f(z)$  for large  $|z|$ , or small  $|z|$ , can be obtained complete with an integral representation of the error term. For further information and examples see §2.5 and Paris and Kaminski (2001, Chapters 5, 6, and 8).

#### 5.19(iii) $n$ -Dimensional Sphere

The volume  $V$  and surface area  $S$  of the  $n$ -dimensional sphere of radius  $r$  are given by

$$5.19.4 \quad V = \frac{\pi^{\frac{1}{2}n} r^n}{\Gamma(\frac{1}{2}n + 1)}, \quad S = \frac{2\pi^{\frac{1}{2}n} r^{n-1}}{\Gamma(\frac{1}{2}n)} = \frac{n}{r} V.$$

### 5.20 Physical Applications

#### Rutherford Scattering

In nonrelativistic quantum mechanics, collisions between two charged particles are described with the aid of the Coulomb phase shift  $\text{ph} \Gamma(\ell + 1 + i\eta)$ ; see (33.2.10) and Clark (1979).

### Solvable Models of Statistical Mechanics

Suppose the potential energy of a gas of  $n$  point charges with positions  $x_1, x_2, \dots, x_n$  and free to move on the infinite line  $-\infty < x < \infty$ , is given by

$$5.20.1 \quad W = \frac{1}{2} \sum_{\ell=1}^n x_\ell^2 - \sum_{1 \leq \ell < j \leq n} \ln |x_\ell - x_j|.$$

The probability density of the positions when the gas is in thermodynamic equilibrium is:

$$5.20.2 \quad P(x_1, \dots, x_n) = C \exp(-W/(kT)),$$

where  $k$  is the Boltzmann constant,  $T$  the temperature and  $C$  a constant. Then the partition function (with  $\beta = 1/(kT)$ ) is given by

$$5.20.3 \quad \begin{aligned} \psi_n(\beta) &= \int_{\mathbb{R}^n} e^{-\beta W} dx \\ &= (2\pi)^{n/2} \beta^{-(n/2) - (\beta n(n-1)/4)} \\ &\quad \times (\Gamma(1 + \frac{1}{2}\beta))^{-n} \prod_{j=1}^n \Gamma(1 + \frac{1}{2}j\beta). \end{aligned}$$

See (5.14.6).

For  $n$  charges free to move on a circular wire of radius 1,

$$5.20.4 \quad W = - \sum_{1 \leq \ell < j \leq n} \ln |e^{i\theta_\ell} - e^{i\theta_j}|,$$

and the partition function is given by

$$5.20.5 \quad \begin{aligned} \psi_n(\beta) &= \frac{1}{(2\pi)^n} \int_{[-\pi, \pi]^n} e^{-\beta W} d\theta_1 \cdots d\theta_n \\ &= \Gamma(1 + \frac{1}{2}n\beta) (\Gamma(1 + \frac{1}{2}\beta))^{-n}. \end{aligned}$$

See (5.14.7).

For further information see Mehta (2004).

### Elementary Particles

Veneziano (1968) identifies relationships between particle scattering amplitudes described by the beta function, an important early development in string theory. Carlitz (1972) describes the partition function of dense hadronic matter in terms of a gamma function.

## Computation

### 5.21 Methods of Computation

An effective way of computing  $\Gamma(z)$  in the right half-plane is backward recurrence, beginning with a value generated from the asymptotic expansion (5.11.3). Or we can use forward recurrence, with an initial value obtained e.g. from (5.7.3). For the left half-plane we can continue the backward recurrence or make use of the reflection formula (5.5.3).

Similarly for  $\ln \Gamma(z)$ ,  $\psi(z)$ , and the polygamma functions.

Another approach is to apply numerical quadrature (§3.5) to the integral (5.9.2), using paths of steepest descent for the contour. See Schmelzer and Trefethen (2007).

For a comprehensive survey see van der Laan and Temme (1984, Chapter III). See also Borwein and Zucker (1992).

### 5.22 Tables

#### 5.22(i) Introduction

For early tables for both real and complex variables see Fletcher *et al.* (1962), Lebedev and Fedorova (1960), and Luke (1975, p. 21).

#### 5.22(ii) Real Variables

Abramowitz and Stegun (1964, Chapter 6) tabulates  $\Gamma(x)$ ,  $\ln \Gamma(x)$ ,  $\psi(x)$ , and  $\psi'(x)$  for  $x = 1(.005)2$  to 10D;  $\psi''(x)$  and  $\psi^{(3)}(x)$  for  $x = 1(.01)2$  to 10D;  $\Gamma(n)$ ,  $1/\Gamma(n)$ ,  $\Gamma(n + \frac{1}{2})$ ,  $\psi(n)$ ,  $\log_{10} \Gamma(n)$ ,  $\log_{10} \Gamma(n + \frac{1}{3})$ ,  $\log_{10} \Gamma(n + \frac{1}{2})$ , and  $\log_{10} \Gamma(n + \frac{2}{3})$  for  $n = 1(1)101$  to 8–11S;  $\Gamma(n+1)$  for  $n = 100(100)1000$  to 20S. Zhang and Jin (1996, pp. 67–69 and 72) tabulates  $\Gamma(x)$ ,  $1/\Gamma(x)$ ,  $\Gamma(-x)$ ,  $\ln \Gamma(x)$ ,  $\psi(x)$ ,  $\psi(-x)$ ,  $\psi'(x)$ , and  $\psi'(-x)$  for  $x = 0(.1)5$  to 8D or 8S;  $\Gamma(n+1)$  for  $n = 0(1)100(10)250(50)500(100)3000$  to 51S.

#### 5.22(iii) Complex Variables

Abramov (1960) tabulates  $\ln \Gamma(x + iy)$  for  $x = 1(.01)2$ ,  $y = 0(.01)4$  to 6D. Abramowitz and Stegun (1964, Chapter 6) tabulates  $\ln \Gamma(x + iy)$  for  $x = 1(.1)2$ ,  $y = 0(.1)10$  to 12D. This reference also includes  $\psi(x + iy)$  for the same arguments to 5D. Zhang and Jin (1996, pp. 70, 71, and 73) tabulates the real and imaginary parts of  $\Gamma(x + iy)$ ,  $\ln \Gamma(x + iy)$ , and  $\psi(x + iy)$  for  $x = 0.5, 1, 5, 10$ ,  $y = 0(.5)10$  to 8S.

### 5.23 Approximations

#### 5.23(i) Rational Approximations

Cody and Hillstrom (1967) gives minimax rational approximations for  $\ln \Gamma(x)$  for the ranges  $0.5 \leq x \leq 1.5$ ,  $1.5 \leq x \leq 4$ ,  $4 \leq x \leq 12$ ; precision is variable. Hart *et al.* (1968) gives minimax polynomial and rational approximations to  $\Gamma(x)$  and  $\ln \Gamma(x)$  in the intervals  $0 \leq x \leq 1$ ,  $8 \leq x \leq 1000$ ,  $12 \leq x \leq 1000$ ; precision is variable. Cody *et al.* (1973) gives minimax rational approximations for  $\psi(x)$  for the ranges  $0.5 \leq x \leq 3$  and  $3 \leq x < \infty$ ; precision is variable.

For additional approximations see Hart *et al.* (1968, Appendix B), Luke (1975, pp. 22–23), and Weniger (2003).

### 5.23(ii) Expansions in Chebyshev Series

Luke (1969b) gives the coefficients to 20D for the Chebyshev-series expansions of  $\Gamma(1+x)$ ,  $1/\Gamma(1+x)$ ,  $\Gamma(x+3)$ ,  $\ln\Gamma(x+3)$ ,  $\psi(x+3)$ , and the first six derivatives of  $\psi(x+3)$  for  $0 \leq x \leq 1$ . These coefficients are reproduced in Luke (1975). Clenshaw (1962) also gives 20D Chebyshev-series coefficients for  $\Gamma(1+x)$  and its reciprocal for  $0 \leq x \leq 1$ . See Luke (1975, pp. 22–23) for additional expansions.

### 5.23(iii) Approximations in the Complex Plane

See Schmelzer and Trefethen (2007) for a survey of rational approximations to various scaled versions of  $\Gamma(z)$ .

For rational approximations to  $\psi(z) + \gamma$  see Luke (1975, pp. 13–16).

## 5.24 Software

See <http://dlmf.nist.gov/5.24>.

## References

### General References

The main references used in writing this chapter are Andrews *et al.* (1999), Carlson (1977b), Erdélyi *et al.* (1953a), Nielsen (1906a), Olver (1997b), Paris and Kaminski (2001), Temme (1996a), and Whittaker and Watson (1927).

### Sources

The following list gives the references or other indications of proofs that were used in constructing the various sections of this chapter. These sources supplement the references that are quoted in the text.

- §5.2 Olver (1997b, Chapter 2, §§1 and 2), Temme (1996a, Chapters 1 and 3).
- §5.3 These graphics were computed at NIST.
- §5.4 Olver (1997b, Chapter 2, §§1 and 2), Andrews *et al.* (1999, §1.2). For (5.4.2) use (5.4.6) and (5.5.1). For (5.4.20) use (5.11.2) to solve  $\psi(1-x) = \pi \cot(\pi x)$  with  $x = -n + u$  and  $n$  large.
- §5.5 Olver (1997b, Chapter 2, §§1 and 2), Temme (1996a, Chapter 3), Andrews *et al.* (1999, §1.9). (5.5.9) follows from (5.5.6).
- §5.6 Gautschi (1959b, 1974), Alzer (1997a), Laforgia (1984), Kershaw (1983), Lorch (2002), Carlson (1977b, §3.10), Paris and Kaminski (2001, §2.1.3). For (5.6.1) see §5.11(ii).
- §5.7 Wrench (1968) (errors on p. 621 are corrected here), Erdélyi *et al.* (1953a, §1.17), Olver (1997b, Chapter 2, §2), Temme (1996a, §3.4). (5.7.7) follows from (5.7.6) and (5.5.2).
- §5.8 Olver (1997b, Chapter 2, §1), Whittaker and Watson (1927, §12.13).
- §5.9 Olver (1997b, Chapter 2, §§1 and 2), Temme (1996a, Chapter 3), Whittaker and Watson (1927, §§12.3–12.32 and §13.6). (5.9.3) follows from (5.2.1) by a change of variables. (5.9.8) and (5.9.9) follow from (5.9.6) and (5.9.7). (5.9.15) and (5.9.17) are the differentiated forms of (5.9.10) and (5.9.11). (5.9.19) is the differentiated form of (5.2.1).
- §5.10 Wall (1948, Chapter 19).
- §5.11 Olver (1997b, Chapter 3, §8, Chapter 4, §5, and Chapter 8, §4), Temme (1996a, §3.6.2), Paris and Kaminski (2001, §2.2.5). (5.11.7) and (5.11.9) are derived from (5.11.3).
- §5.12 Carlson (1977b, §4.2 and p. 70), Nielsen (1906a, §64), Temme (1996a, §3.8: an error in Ex.3.13 is corrected here), Olver (1997b, p. 38). (5.12.11) follows from (5.12.3).
- §5.13 Paris and Kaminski (2001, §3.3.4), Titchmarsh (1986a, pp. 188 and 194), Andrews *et al.* (1999, §3.6).
- §5.14 Andrews *et al.* (1999, §§1.8, 8.1–8.3, and 8.7), Mehta (2004, pp. 224–227).
- §5.16 Jordan (1939, pp. 344–345).
- §5.17 Whittaker and Watson (1927, p. 264), Olver (1997b, Chapter 8, §3.3), and the differentiated form of (25.4.1).
- §5.18 Andrews *et al.* (1999, §§10.1–10.3).
- §5.19 Stein and Shakarchi (2003, pp. 208–209) and Robnik (1980). The formula for  $V$  can also be verified by setting  $t_k = (x_k/r)^2$  and  $z_k = \frac{1}{2}$ ,  $k = 1, 2, \dots, n$ , in (5.14.1). The formula for  $S$  can be verified in a similar way from (5.14.2), or derived by differentiating the formula for  $V$ .
- §5.20 Andrews *et al.* (1999, §8.2), Mehta (2004, Chapters 4 and 11).



## Chapter 6

# Exponential, Logarithmic, Sine, and Cosine Integrals

N. M. Temme<sup>1</sup>

<b>Notation</b>	<b>150</b>	6.13 Zeros . . . . .	154
6.1 Special Notation . . . . .	150	6.14 Integrals . . . . .	154
<b>Properties</b>	<b>150</b>	6.15 Sums . . . . .	154
6.2 Definitions and Interrelations . . . . .	150	<b>Applications</b>	<b>154</b>
6.3 Graphics . . . . .	151	6.16 Mathematical Applications . . . . .	154
6.4 Analytic Continuation . . . . .	151	6.17 Physical Applications . . . . .	155
6.5 Further Interrelations . . . . .	151	<b>Computation</b>	<b>155</b>
6.6 Power Series . . . . .	151	6.18 Methods of Computation . . . . .	155
6.7 Integral Representations . . . . .	152	6.19 Tables . . . . .	156
6.8 Inequalities . . . . .	152	6.20 Approximations . . . . .	156
6.9 Continued Fraction . . . . .	153	6.21 Software . . . . .	157
6.10 Other Series Expansions . . . . .	153	<b>References</b>	<b>157</b>
6.11 Relations to Other Functions . . . . .	153		
6.12 Asymptotic Expansions . . . . .	153		

<sup>1</sup>Centrum voor Wiskunde en Informatica, Department MAS, Amsterdam, The Netherlands.

**Acknowledgments:** This chapter is based in part on Abramowitz and Stegun (1964, Chapter 5) by Walter Gautschi and William F. Cahill. Walter Gautschi provided the author with a list of references and comments collected since the original publication.

**Copyright** © 2009 National Institute of Standards and Technology. All rights reserved.

## Notation

### 6.1 Special Notation

(For other notation see pp. xiv and 873.)

- $x$  real variable.
- $z$  complex variable.
- $n$  nonnegative integer.
- $\delta$  arbitrary small positive constant.
- $\gamma$  Euler's constant (§5.2(ii)).

Unless otherwise noted, primes indicate derivatives with respect to the argument.

The main functions treated in this chapter are the exponential integrals  $Ei(x)$ ,  $E_1(z)$ , and  $\text{Ein}(z)$ ; the logarithmic integral  $\text{li}(x)$ ; the sine integrals  $\text{Si}(z)$  and  $\text{si}(z)$ ; the cosine integrals  $\text{Ci}(z)$  and  $\text{Cin}(z)$ .

## Properties

### 6.2 Definitions and Interrelations

#### 6.2(i) Exponential and Logarithmic Integrals

The *principal value* of the exponential integral  $E_1(z)$  is defined by

$$6.2.1 \quad E_1(z) = \int_z^\infty \frac{e^{-t}}{t} dt, \quad z \neq 0,$$

where the path does not cross the negative real axis or pass through the origin. As in the case of the logarithm (§4.2(i)) there is a cut along the interval  $(-\infty, 0]$  and the principal value is two-valued on  $(-\infty, 0)$ .

Unless indicated otherwise, it is assumed throughout this Handbook that  $E_1(z)$  assumes its principal value. This is also true of the functions  $\text{Ci}(z)$  and  $\text{Chi}(z)$  defined in §6.2(ii).

$$6.2.2 \quad E_1(z) = e^{-z} \int_0^\infty \frac{e^{-t}}{t+z} dt, \quad |\text{ph } z| < \pi.$$

$$6.2.3 \quad \text{Ein}(z) = \int_0^z \frac{1-e^{-t}}{t} dt.$$

$\text{Ein}(z)$  is sometimes called the *complementary exponential integral*. It is entire.

$$6.2.4 \quad E_1(z) = \text{Ein}(z) - \ln z - \gamma.$$

In the next three equations  $x > 0$ .

$$6.2.5 \quad Ei(x) = -\int_{-x}^\infty \frac{e^{-t}}{t} dt = \int_{-\infty}^x \frac{e^t}{t} dt,$$

$$6.2.6 \quad Ei(-x) = -\int_x^\infty \frac{e^{-t}}{t} dt = -E_1(x),$$

$$6.2.7 \quad Ei(\pm x) = -\text{Ein}(\mp x) + \ln x + \gamma.$$

( $Ei(x)$  is undefined when  $x = 0$ , or when  $x$  is not real.)

The *logarithmic integral* is defined by

$$6.2.8 \quad \text{li}(x) = \int_0^x \frac{dt}{\ln t} = Ei(\ln x), \quad x > 1.$$

The generalized exponential integral  $E_p(z)$ ,  $p \in \mathbb{C}$ , is treated in Chapter 8.

#### 6.2(ii) Sine and Cosine Integrals

$$6.2.9 \quad \text{Si}(z) = \int_0^z \frac{\sin t}{t} dt.$$

$\text{Si}(z)$  is an odd entire function.

$$6.2.10 \quad \text{si}(z) = -\int_z^\infty \frac{\sin t}{t} dt = \text{Si}(z) - \frac{1}{2}\pi.$$

$$6.2.11 \quad \text{Ci}(z) = -\int_z^\infty \frac{\cos t}{t} dt,$$

where the path does not cross the negative real axis or pass through the origin. This is the *principal value*; compare (6.2.1).

$$6.2.12 \quad \text{Cin}(z) = \int_0^z \frac{1-\cos t}{t} dt.$$

$\text{Cin}(z)$  is an even entire function.

$$6.2.13 \quad \text{Ci}(z) = -\text{Cin}(z) + \ln z + \gamma.$$

#### Values at Infinity

$$6.2.14 \quad \lim_{x \rightarrow \infty} \text{Si}(x) = \frac{1}{2}\pi, \quad \lim_{x \rightarrow \infty} \text{Ci}(x) = 0.$$

#### Hyperbolic Analogs of the Sine and Cosine Integrals

$$6.2.15 \quad \text{Shi}(z) = \int_0^z \frac{\sinh t}{t} dt,$$

$$6.2.16 \quad \text{Chi}(z) = \gamma + \ln z + \int_0^z \frac{\cosh t - 1}{t} dt.$$

#### 6.2(iii) Auxiliary Functions

$$6.2.17 \quad f(z) = \text{Ci}(z) \sin z - \text{si}(z) \cos z,$$

$$6.2.18 \quad g(z) = -\text{Ci}(z) \cos z - \text{si}(z) \sin z.$$

$$6.2.19 \quad \text{Si}(z) = \frac{1}{2}\pi - f(z) \cos z - g(z) \sin z,$$

$$6.2.20 \quad \text{Ci}(z) = f(z) \sin z - g(z) \cos z.$$

$$6.2.21 \quad \frac{df(z)}{dz} = -g(z), \quad \frac{dg(z)}{dz} = f(z) - \frac{1}{z}.$$

## 6.3 Graphics

### 6.3(i) Real Variable

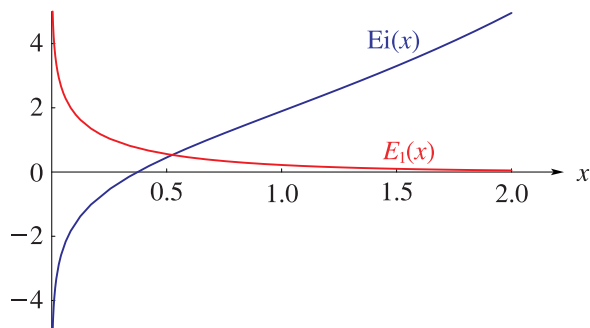


Figure 6.3.1: The exponential integrals  $E_1(x)$  and  $Ei(x)$ ,  $0 < x \leq 2$ .

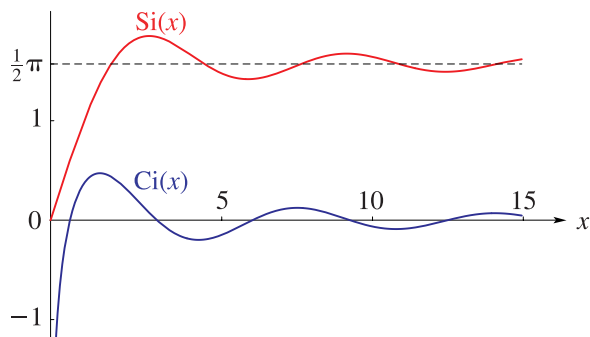


Figure 6.3.2: The sine and cosine integrals  $Si(x)$ ,  $Ci(x)$ ,  $0 \leq x \leq 15$ .

For a graph of  $li(x)$  see Figure 6.16.2.

### 6.3(ii) Complex Variable

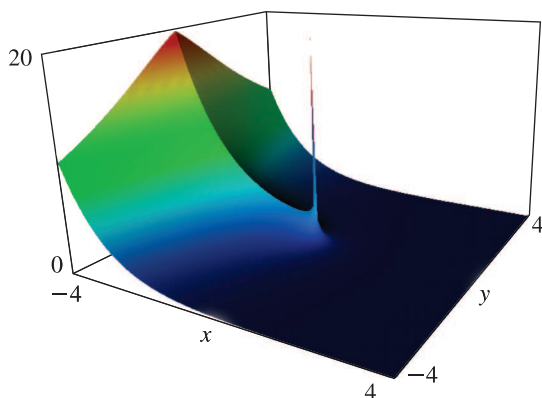


Figure 6.3.3:  $|E_1(x + iy)|$ ,  $-4 \leq x \leq 4$ ,  $-4 \leq y \leq 4$ . Principal value. There is a cut along the negative real axis. Also,  $|E_1(z)| \rightarrow \infty$  logarithmically as  $z \rightarrow 0$ .

## 6.4 Analytic Continuation

Analytic continuation of the principal value of  $E_1(z)$  yields a multi-valued function with branch points at  $z = 0$  and  $z = \infty$ . The general value of  $E_1(z)$  is given by

$$6.4.1 \quad E_1(z) = \text{Ein}(z) - \text{Ln } z - \gamma;$$

compare (6.2.4) and (4.2.6). Thus

$$6.4.2 \quad E_1(ze^{2m\pi i}) = E_1(z) - 2m\pi i, \quad m \in \mathbb{Z},$$

and

$$6.4.3 \quad E_1(ze^{\pm\pi i}) = \text{Ein}(-z) - \ln z - \gamma \mp \pi i, \quad |\text{ph } z| \leq \pi.$$

The general values of the other functions are defined in a similar manner, and

$$6.4.4 \quad \text{Ci}(ze^{\pm\pi i}) = \pm\pi i + \text{Ci}(z),$$

$$6.4.5 \quad \text{Chi}(ze^{\pm\pi i}) = \pm\pi i + \text{Chi}(z),$$

$$6.4.6 \quad f(ze^{\pm\pi i}) = \pi e^{\mp iz} - f(z),$$

$$6.4.7 \quad g(ze^{\pm\pi i}) = \mp \pi i e^{\mp iz} + g(z).$$

Unless indicated otherwise, in the rest of this chapter and elsewhere in this Handbook the functions  $E_1(z)$ ,  $\text{Ci}(z)$ ,  $\text{Chi}(z)$ ,  $f(z)$ , and  $g(z)$  assume their principal values, that is, the branches that are real on the positive real axis and two-valued on the negative real axis.

## 6.5 Further Interrelations

When  $x > 0$ ,

$$6.5.1 \quad E_1(-x \pm i0) = -Ei(x) \mp i\pi,$$

$$6.5.2 \quad Ei(x) = -\frac{1}{2}(E_1(-x + i0) + E_1(-x - i0)),$$

$$6.5.3 \quad \frac{1}{2}(Ei(x) + E_1(x)) = \text{Shi}(x) = -i \text{Si}(ix),$$

$$6.5.4 \quad \frac{1}{2}(Ei(x) - E_1(x)) = \text{Chi}(x) = \text{Ci}(ix) - \frac{1}{2}\pi i.$$

When  $|\text{ph } z| < \frac{1}{2}\pi$ ,

$$6.5.5 \quad \text{Si}(z) = \frac{1}{2}i(E_1(-iz) - E_1(iz)) + \frac{1}{2}\pi,$$

$$6.5.6 \quad \text{Ci}(z) = -\frac{1}{2}(E_1(iz) + E_1(-iz)),$$

$$6.5.7 \quad g(z) \pm if(z) = E_1(\mp iz)e^{\mp iz}.$$

## 6.6 Power Series

$$6.6.1 \quad Ei(x) = \gamma + \ln x + \sum_{n=1}^{\infty} \frac{x^n}{n!n}, \quad x > 0.$$

$$6.6.2 \quad E_1(z) = -\gamma - \ln z - \sum_{n=1}^{\infty} \frac{(-1)^n z^n}{n!n}.$$

$$6.6.3 \quad E_1(z) = -\ln z + e^{-z} \sum_{n=0}^{\infty} \frac{z^n}{n!} \psi(n+1),$$



where  $\psi$  denotes the logarithmic derivative of the gamma function (§5.2(i)).

$$6.6.4 \quad \text{Ein}(z) = \sum_{n=1}^{\infty} \frac{(-1)^{n-1} z^n}{n! n},$$

$$6.6.5 \quad \text{Si}(z) = \sum_{n=0}^{\infty} \frac{(-1)^n z^{2n+1}}{(2n+1)!(2n+1)},$$

$$6.6.6 \quad \text{Ci}(z) = \gamma + \ln z + \sum_{n=1}^{\infty} \frac{(-1)^n z^{2n}}{(2n)!(2n)}.$$

The series in this section converge for all finite values of  $x$  and  $|z|$ .

## 6.7 Integral Representations

### 6.7(i) Exponential Integrals

$$6.7.1 \quad \int_0^{\infty} \frac{e^{-at}}{t+b} dt = \int_0^{\infty} \frac{e^{iat}}{t+ib} dt = e^{ab} E_1(ab), \quad a > 0, b > 0,$$

$$6.7.2 \quad e^x \int_0^{\alpha} \frac{e^{-xt}}{1-t} dt = \text{Ei}(x) - \text{Ei}((1-\alpha)x), \\ 0 \leq \alpha < 1, x > 0.$$

$$6.7.3 \quad \int_x^{\infty} \frac{e^{it}}{a^2+t^2} dt = \frac{i}{2a} (e^a E_1(a-ix) - e^{-a} E_1(-a-ix)), \\ a > 0, x > 0,$$

$$6.7.4 \quad \int_x^{\infty} \frac{te^{it}}{a^2+t^2} dt = \frac{1}{2} (e^a E_1(a-ix) + e^{-a} E_1(-a-ix)), \\ a > 0, x > 0.$$

$$6.7.5 \quad \int_x^{\infty} \frac{e^{-t}}{a^2+t^2} dt = -\frac{1}{2ai} (e^{ia} E_1(x+ia) \\ - e^{-ia} E_1(x-ia)), \\ a > 0, x \in \mathbb{R},$$

$$6.7.6 \quad \int_x^{\infty} \frac{te^{-t}}{a^2+t^2} dt = \frac{1}{2} (e^{ia} E_1(x+ia) + e^{-ia} E_1(x-ia)), \\ a > 0, x \in \mathbb{R}.$$

$$6.7.7 \quad \int_0^1 \frac{e^{-at} \sin(bt)}{t} dt = \Im \text{Ein}(a+ib), \quad a, b \in \mathbb{R},$$

$$6.7.8 \quad \int_0^1 \frac{e^{-at}(1-\cos(bt))}{t} dt = \Re \text{Ein}(a+ib) - \text{Ein}(a), \\ a, b \in \mathbb{R}.$$

Many integrals with exponentials and rational functions, for example, integrals of the type  $\int e^z R(z) dz$ , where  $R(z)$  is an arbitrary rational function, can be represented in finite form in terms of the function  $E_1(z)$  and elementary functions; see Lebedev (1965, p. 42).

### 6.7(ii) Sine and Cosine Integrals

When  $z \in \mathbb{C}$

$$6.7.9 \quad \text{si}(z) = - \int_0^{\pi/2} e^{-z \cos t} \cos(z \sin t) dt,$$

$$6.7.10 \quad \text{Ein}(z) - \text{Cin}(z) = \int_0^{\pi/2} e^{-z \cos t} \sin(z \sin t) dt,$$

$$6.7.11 \quad \int_0^1 \frac{(1-e^{-at}) \cos(bt)}{t} dt = \Re \text{Ein}(a+ib) - \text{Cin}(b), \\ a, b \in \mathbb{R}.$$

### 6.7(iii) Auxiliary Functions

$$6.7.12 \quad g(z) + if(z) = e^{-iz} \int_z^{\infty} \frac{e^{it}}{t} dt, \quad |\text{ph } z| \leq \pi.$$

The path of integration does not cross the negative real axis or pass through the origin.

$$6.7.13 \quad f(z) = \int_0^{\infty} \frac{\sin t}{t+z} dt = \int_0^{\infty} \frac{e^{-zt}}{t^2+1} dt,$$

$$6.7.14 \quad g(z) = \int_0^{\infty} \frac{\cos t}{t+z} dt = \int_0^{\infty} \frac{te^{-zt}}{t^2+1} dt.$$

The first integrals on the right-hand sides apply when  $|\text{ph } z| < \pi$ ; the second ones when  $\Re z \geq 0$  and (in the case of (6.7.14))  $z \neq 0$ .

When  $|\text{ph } z| < \pi$

$$6.7.15 \quad f(z) = 2 \int_0^{\infty} K_0(2\sqrt{zt}) \cos t dt,$$

$$6.7.16 \quad g(z) = 2 \int_0^{\infty} K_0(2\sqrt{zt}) \sin t dt.$$

For  $K_0$  see §10.25(ii).

### 6.7(iv) Compendia

For collections of integral representations see Bierens de Haan (1939, pp. 56–59, 72–73, 82–84, 121, 133–136, 155, 179–181, 223, 225–227, 230, 259–260, 374, 377, 397–398, 408, 416, 424, 431, 438–439, 442–444, 488, 496–500, 567–571, 585, 602, 638, 675–677), Corrington (1961), Erdélyi *et al.* (1954a, vol. 1, pp. 267–270), Geller and Ng (1969), Nielsen (1906b), Oberhettinger (1974, pp. 244–246), Oberhettinger and Badii (1973, pp. 364–371), and Watrasiewicz (1967).

## 6.8 Inequalities

In this section  $x > 0$ .

$$6.8.1 \quad \frac{1}{2} \ln \left( 1 + \frac{2}{x} \right) < e^x E_1(x) < \ln \left( 1 + \frac{1}{x} \right),$$

$$6.8.2 \quad \frac{x}{x+1} < x e^x E_1(x) < \frac{x+1}{x+2},$$

$$6.8.3 \quad \frac{x(x+3)}{x^2+4x+2} < x e^x E_1(x) < \frac{x^2+5x+2}{x^2+6x+6}.$$

## 6.9 Continued Fraction

$$6.9.1 \quad E_1(z) = \frac{e^{-z}}{z+} \frac{1}{1+} \frac{1}{z+} \frac{2}{1+} \frac{2}{z+} \frac{3}{1+} \frac{3}{z+} \cdots, \\ |\operatorname{ph} z| < \pi.$$

See also Cuyt *et al.* (2008, pp. 287–290).

## 6.10 Other Series Expansions

### 6.10(i) Inverse Factorial Series

$$6.10.1 \quad E_1(z) = e^{-z} \left( \frac{c_0}{z} + \frac{c_1}{z(z+1)} + \frac{2!c_2}{z(z+1)(z+2)} \right. \\ \left. + \frac{3!c_3}{z(z+1)(z+2)(z+3)} + \cdots \right), \\ \Re z > 0,$$

where

$$6.10.2 \quad c_0 = 1, \quad c_1 = -1, \quad c_2 = \frac{1}{2}, \quad c_3 = -\frac{1}{3}, \quad c_4 = \frac{1}{6}, \\ \text{and}$$

$$6.10.3 \quad c_k = -\sum_{j=0}^{k-1} \frac{c_j}{k-j}, \quad k \geq 1.$$

For a more general result (incomplete gamma function), and also for a result for the logarithmic integral, see Nielsen (1906a, p. 283: Formula (3) is incorrect).

### 6.10(ii) Expansions in Series of Spherical Bessel Functions

For the notation see §10.47(ii).

$$6.10.4 \quad \operatorname{Si}(z) = z \sum_{n=0}^{\infty} (j_n(\frac{1}{2}z))^2,$$

$$6.10.5 \quad \operatorname{Cin}(z) = \sum_{n=1}^{\infty} a_n (j_n(\frac{1}{2}z))^2,$$

$$6.10.6 \quad \operatorname{Ei}(x) = \gamma + \ln|x| + \sum_{n=0}^{\infty} (-1)^n (x - a_n) \left( i_n^{(1)}(\frac{1}{2}x) \right)^2, \\ x \neq 0,$$

where

$$6.10.7 \quad a_n = (2n+1)(1 - (-1)^n + \psi(n+1) - \psi(1)),$$

and  $\psi$  denotes the logarithmic derivative of the gamma function (§5.2(i)).

### 6.10.8

$$\operatorname{Ein}(z) = ze^{-z/2} \left( i_0^{(1)}(\frac{1}{2}z) + \sum_{n=1}^{\infty} \frac{2n+1}{n(n+1)} i_n^{(1)}(\frac{1}{2}z) \right).$$

For (6.10.4)–(6.10.8) and further results see Harris (2000) and Luke (1969b, pp. 56–57). An expansion for  $E_1(z)$  can be obtained by combining (6.2.4) and (6.10.8).

## 6.11 Relations to Other Functions

For the notation see §§8.2(i) and 13.2(i).

### Incomplete Gamma Function

$$6.11.1 \quad E_1(z) = \Gamma(0, z).$$

### Confluent Hypergeometric Function

$$6.11.2 \quad E_1(z) = e^{-z} U(1, 1, z),$$

$$6.11.3 \quad g(z) + i f(z) = U(1, 1, -iz).$$

## 6.12 Asymptotic Expansions

### 6.12(i) Exponential and Logarithmic Integrals

$$6.12.1 \quad E_1(z) \sim \frac{e^{-z}}{z} \left( 1 - \frac{1!}{z} + \frac{2!}{z^2} - \frac{3!}{z^3} + \cdots \right), \\ z \rightarrow \infty, \quad |\operatorname{ph} z| \leq \frac{3}{2}\pi - \delta (< \frac{3}{2}\pi).$$

When  $|\operatorname{ph} z| \leq \frac{1}{2}\pi$  the remainder is bounded in magnitude by the first neglected term, and has the same sign when  $\operatorname{ph} z = 0$ . When  $\frac{1}{2}\pi \leq |\operatorname{ph} z| < \pi$  the remainder term is bounded in magnitude by  $\operatorname{csc}(|\operatorname{ph} z|)$  times the first neglected term. For these and other error bounds see Olver (1997b, pp. 109–112) with  $\alpha = 0$ .

For re-expansions of the remainder term leading to larger sectors of validity, exponential improvement, and a smooth interpretation of the Stokes phenomenon, see §§2.11(ii)–2.11(iv), with  $p = 1$ .

### 6.12.2

$$\operatorname{Ei}(x) \sim \frac{e^x}{x} \left( 1 + \frac{1!}{x} + \frac{2!}{x^2} + \frac{3!}{x^3} + \cdots \right), \quad x \rightarrow +\infty.$$

If the expansion is terminated at the  $n$ th term, then the remainder term is bounded by  $1 + \chi(n+1)$  times the next term. For the function  $\chi$  see §9.7(i).

The asymptotic expansion of  $\operatorname{li}(x)$  as  $x \rightarrow \infty$  is obtainable from (6.2.8) and (6.12.2).

### 6.12(ii) Sine and Cosine Integrals

The asymptotic expansions of  $\operatorname{Si}(z)$  and  $\operatorname{Ci}(z)$  are given by (6.2.19), (6.2.20), together with

$$6.12.3 \quad f(z) \sim \frac{1}{z} \left( 1 - \frac{2!}{z^2} + \frac{4!}{z^4} - \frac{6!}{z^6} + \cdots \right),$$

$$6.12.4 \quad g(z) \sim \frac{1}{z^2} \left( 1 - \frac{3!}{z^2} + \frac{5!}{z^4} - \frac{7!}{z^6} + \cdots \right),$$

as  $z \rightarrow \infty$  in  $|\operatorname{ph} z| \leq \pi - \delta (< \pi)$ .

The remainder terms are given by

$$6.12.5 \quad f(z) = \frac{1}{z} \sum_{m=0}^{n-1} (-1)^m \frac{(2m)!}{z^{2m}} + R_n^{(f)}(z),$$

$$6.12.6 \quad g(z) = \frac{1}{z^2} \sum_{m=0}^{n-1} (-1)^m \frac{(2m+1)!}{z^{2m}} + R_n^{(g)}(z),$$

where, for  $n = 0, 1, 2, \dots$ ,

6.12.7 
$$R_n^{(f)}(z) = (-1)^n \int_0^\infty \frac{e^{-zt}t^{2n}}{t^2 + 1} dt,$$

6.12.8 
$$R_n^{(g)}(z) = (-1)^n \int_0^\infty \frac{e^{-zt}t^{2n+1}}{t^2 + 1} dt.$$

When  $|\text{ph } z| \leq \frac{1}{4}\pi$ , these remainders are bounded in magnitude by the first neglected terms in (6.12.3) and (6.12.4), respectively, and have the same signs as these terms when  $\text{ph } z = 0$ . When  $\frac{1}{4}\pi \leq |\text{ph } z| < \frac{1}{2}\pi$  the remainders are bounded in magnitude by  $\csc(2|\text{ph } z|)$  times the first neglected terms.

For other phase ranges use (6.4.6) and (6.4.7). For exponentially-improved asymptotic expansions, use (6.5.5), (6.5.6), and §6.12(i).

### 6.13 Zeros

The function  $\text{Ei}(x)$  has one real zero  $x_0$ , given by

6.13.1  $x_0 = 0.37250\ 74107\ 81366\ 63446\ 19918\ 66580 \dots$

$\text{Ci}(x)$  and  $\text{si}(x)$  each have an infinite number of positive real zeros, which are denoted by  $c_k, s_k$ , respectively, arranged in ascending order of absolute value for  $k = 0, 1, 2, \dots$ . Values of  $c_1$  and  $c_2$  to 30D are given by MacLeod (1996).

As  $k \rightarrow \infty$ ,

6.13.2

$$c_k, s_k \sim \alpha + \frac{1}{\alpha} - \frac{16}{3} \frac{1}{\alpha^3} + \frac{1673}{15} \frac{1}{\alpha^5} - \frac{5\ 07746}{105} \frac{1}{\alpha^7} + \dots,$$

where  $\alpha = k\pi$  for  $c_k$ , and  $\alpha = (k + \frac{1}{2})\pi$  for  $s_k$ . For these results, together with the next three terms in (6.13.2), see MacLeod (2002a). See also Riekstynš (1991, pp. 176–177).

### 6.14 Integrals

#### 6.14(i) Laplace Transforms

6.14.1 
$$\int_0^\infty e^{-at} E_1(t) dt = \frac{1}{a} \ln(1 + a), \quad \Re a > -1,$$

6.14.2 
$$\int_0^\infty e^{-at} \text{Ci}(t) dt = -\frac{1}{2a} \ln(1 + a^2), \quad \Re a > 0,$$

6.14.3 
$$\int_0^\infty e^{-at} \text{si}(t) dt = -\frac{1}{a} \arctan a, \quad \Re a > 0.$$

#### 6.14(ii) Other Integrals

6.14.4 
$$\int_0^\infty E_1^2(t) dt = 2 \ln 2,$$

6.14.5 
$$\int_0^\infty \cos t \text{Ci}(t) dt = \int_0^\infty \sin t \text{si}(t) dt = -\frac{1}{4}\pi,$$

6.14.6 
$$\int_0^\infty \text{Ci}^2(t) dt = \int_0^\infty \text{si}^2(t) dt = \frac{1}{2}\pi,$$

6.14.7 
$$\int_0^\infty \text{Ci}(t) \text{si}(t) dt = \ln 2.$$

### 6.14(iii) Compendia

For collections of integrals, see Apelblat (1983, pp. 110–123), Bierens de Haan (1939, pp. 373–374, 409, 479, 571–572, 637, 664–673, 680–682, 685–697), Erdélyi *et al.* (1954a, vol. 1, pp. 40–42, 96–98, 177–178, 325), Geller and Ng (1969), Gradshteyn and Ryzhik (2000, §§5.2–5.3 and 6.2–6.27), Marichev (1983, pp. 182–184), Nielsen (1906b), Oberhettinger (1974, pp. 139–141), Oberhettinger (1990, pp. 53–55 and 158–160), Oberhettinger and Badii (1973, pp. 172–179), Prudnikov *et al.* (1986b, vol. 2, pp. 24–29 and 64–92), Prudnikov *et al.* (1992a, §§3.4–3.6), Prudnikov *et al.* (1992b, §§3.4–3.6), and Wasziewicz (1967).

### 6.15 Sums

6.15.1 
$$\sum_{n=1}^\infty \text{Ci}(\pi n) = \frac{1}{2}(\ln 2 - \gamma),$$

6.15.2 
$$\sum_{n=1}^\infty \frac{\text{si}(\pi n)}{n} = \frac{1}{2}\pi(\ln \pi - 1),$$

6.15.3 
$$\sum_{n=1}^\infty (-1)^n \text{Ci}(2\pi n) = 1 - \ln 2 - \frac{1}{2}\gamma,$$

6.15.4 
$$\sum_{n=1}^\infty (-1)^n \frac{\text{si}(2\pi n)}{n} = \pi\left(\frac{3}{2} \ln 2 - 1\right).$$

For further sums see Fempl (1960), Hansen (1975, pp. 423–424), Harris (2000), Prudnikov *et al.* (1986b, vol. 2, pp. 649–650), and Slavić (1974).

## Applications

### 6.16 Mathematical Applications

#### 6.16(i) The Gibbs Phenomenon

Consider the Fourier series

$$\sin x + \frac{1}{3} \sin(3x) + \frac{1}{5} \sin(5x) + \dots$$

6.16.1 
$$= \begin{cases} \frac{1}{4}\pi, & 0 < x < \pi, \\ 0, & x = 0, \\ -\frac{1}{4}\pi, & -\pi < x < 0. \end{cases}$$

The  $n$ th partial sum is given by

6.16.2 
$$S_n(x) = \sum_{k=0}^{n-1} \frac{\sin((2k+1)x)}{2k+1} = \frac{1}{2} \int_0^x \frac{\sin(2nt)}{\sin t} dt$$

$$= \frac{1}{2} \text{Si}(2nx) + R_n(x),$$

where

$$6.16.3 \quad R_n(x) = \frac{1}{2} \int_0^x \left( \frac{1}{\sin t} - \frac{1}{t} \right) \sin(2nt) dt.$$

By integration by parts

$$6.16.4 \quad R_n(x) = O(n^{-1}), \quad n \rightarrow \infty,$$

uniformly for  $x \in [-\pi, \pi]$ . Hence, if  $x$  is fixed and  $n \rightarrow \infty$ , then  $S_n(x) \rightarrow \frac{1}{4}\pi$ ,  $0$ , or  $-\frac{1}{4}\pi$  according as  $0 < x < \pi$ ,  $x = 0$ , or  $-\pi < x < 0$ ; compare (6.2.14).

These limits are not approached uniformly, however. The first maximum of  $\frac{1}{2} \text{Si}(x)$  for positive  $x$  occurs at  $x = \pi$  and equals  $(1.1789\dots) \times \frac{1}{4}\pi$ ; compare Figure 6.3.2. Hence if  $x = \pi/(2n)$  and  $n \rightarrow \infty$ , then the limiting value of  $S_n(x)$  overshoots  $\frac{1}{4}\pi$  by approximately 18%. Similarly if  $x = \pi/n$ , then the limiting value of  $S_n(x)$  undershoots  $\frac{1}{4}\pi$  by approximately 10%, and so on. Compare Figure 6.16.1.

This nonuniformity of convergence is an illustration of the *Gibbs phenomenon*. It occurs with Fourier-series expansions of all piecewise continuous functions. See Carslaw (1930) for additional graphs and information.

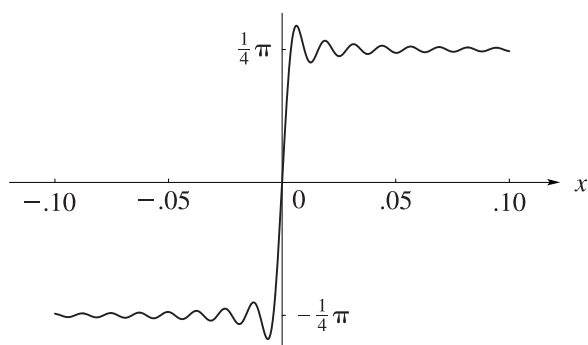


Figure 6.16.1: Graph of  $S_n(x)$ ,  $n = 250$ ,  $-0.1 \leq x \leq 0.1$ , illustrating the Gibbs phenomenon.

### 6.16(ii) Number-Theoretic Significance of $\text{li}(x)$

If we assume Riemann's hypothesis that all nonreal zeros of  $\zeta(s)$  have real part of  $\frac{1}{2}$  (§25.10(i)), then

$$6.16.5 \quad \text{li}(x) - \pi(x) = O(\sqrt{x} \ln x), \quad x \rightarrow \infty,$$

where  $\pi(x)$  is the number of primes less than or equal to  $x$ . Compare §27.12 and Figure 6.16.2. See also Bays and Hudson (2000).

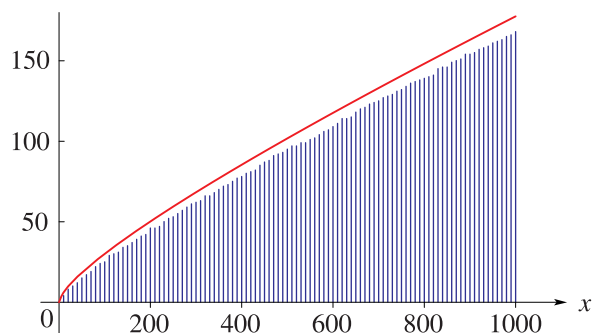


Figure 6.16.2: The logarithmic integral  $\text{li}(x)$ , together with vertical bars indicating the value of  $\pi(x)$  for  $x = 10, 20, \dots, 1000$ .

## 6.17 Physical Applications

Geller and Ng (1969) cites work with applications from diffusion theory, transport problems, the study of the radiative equilibrium of stellar atmospheres, and the evaluation of exchange integrals occurring in quantum mechanics. For applications in astrophysics, see also van de Hulst (1980). Lebedev (1965) gives an application to electromagnetic theory (radiation of a linear half-wave oscillator), in which sine and cosine integrals are used.

## Computation

### 6.18 Methods of Computation

#### 6.18(i) Main Functions

For small or moderate values of  $x$  and  $|z|$ , the expansion in power series (§6.6) or in series of spherical Bessel functions (§6.10(ii)) can be used. For large  $x$  or  $|z|$  these series suffer from slow convergence or cancellation (or both). However, this problem is less severe for the series of spherical Bessel functions because of their more rapid rate of convergence, and also (except in the case of (6.10.6)) absence of cancellation when  $z = x (> 0)$ .

For large  $x$  and  $|z|$ , expansions in inverse factorial series (§6.10(i)) or asymptotic expansions (§6.12) are available. The attainable accuracy of the asymptotic expansions can be increased considerably by exponential improvement. Also, other ranges of  $\text{ph } z$  can be covered by use of the continuation formulas of §6.4.

Quadrature of the integral representations is another effective method. For example, the Gauss-Laguerre formula (§3.5(v)) can be applied to (6.2.2); see Todd (1954) and Tseng and Lee (1998). For an application of the Gauss-Legendre formula (§3.5(v)) see Tooper and Mark (1968).

Lastly, the continued fraction (6.9.1) can be used if  $|z|$  is bounded away from the origin. Convergence becomes slow when  $z$  is near the negative real axis, however.

### 6.18(ii) Auxiliary Functions

Power series, asymptotic expansions, and quadrature can also be used to compute the functions  $f(z)$  and  $g(z)$ . In addition, Acton (1974) developed a recurrence procedure, as follows. For  $n = 0, 1, 2, \dots$ , define

$$\begin{aligned} A_n &= \int_0^\infty \frac{te^{-zt}}{1+t^2} \left( \frac{t^2}{1+t^2} \right)^n dt, \\ 6.18.1 \quad B_n &= \int_0^\infty \frac{e^{-zt}}{1+t^2} \left( \frac{t^2}{1+t^2} \right)^n dt, \\ C_n &= \int_0^\infty e^{-zt} \left( \frac{t^2}{1+t^2} \right)^n dt. \end{aligned}$$

Then  $f(z) = B_0$ ,  $g(z) = A_0$ , and

$$6.18.2 \quad \begin{aligned} A_{n-1} &= A_n + \frac{z}{2n} C_n, & B_{n-1} &= \frac{2nB_n + zA_{n-1}}{2n-1}, \\ C_{n-1} &= C_n + B_{n-1}, & n &= 1, 2, 3, \dots \end{aligned}$$

$A_0$ ,  $B_0$ , and  $C_0$  can be computed by Miller's algorithm (§3.6(iii)), starting with initial values  $(A_N, B_N, C_N) = (1, 0, 0)$ , say, where  $N$  is an arbitrary large integer, and normalizing via  $C_0 = 1/z$ .

### 6.18(iii) Zeros

Zeros of  $\text{Ci}(x)$  and  $\text{si}(x)$  can be computed to high precision by Newton's rule (§3.8(ii)), using values supplied by the asymptotic expansion (6.13.2) as initial approximations.

### 6.18(iv) Other References

For a comprehensive survey of computational methods for the functions treated in this chapter, see van der Laan and Temme (1984, Ch. IV).

## 6.19 Tables

### 6.19(i) Introduction

Lebedev and Fedorova (1960) and Fletcher *et al.* (1962) give comprehensive indexes of mathematical tables. This section lists relevant tables that appeared later.

### 6.19(ii) Real Variables

- Abramowitz and Stegun (1964, Chapter 5) includes  $x^{-1} \text{Si}(x)$ ,  $-x^{-2} \text{Cin}(x)$ ,  $x^{-1} \text{Ein}(x)$ ,  $-x^{-1} \text{Ein}(-x)$ ,  $x = 0(.01)0.5$ ;  $\text{Si}(x)$ ,  $\text{Ci}(x)$ ,  $\text{Ei}(x)$ ,  $E_1(x)$ ,  $x = 0.5(.01)2$ ;  $\text{Si}(x)$ ,  $\text{Ci}(x)$ ,  $xe^{-x} \text{Ei}(x)$ ,  $xe^x E_1(x)$ ,  $x = 2(.1)10$ ;  $xf(x)$ ,  $x^2 g(x)$ ,  $xe^{-x} \text{Ei}(x)$ ,  $xe^x E_1(x)$ ,  $x^{-1} = 0(.005)0.1$ ;  $\text{Si}(\pi x)$ ,  $\text{Cin}(\pi x)$ ,  $x = 0(.1)10$ . Accuracy varies but is within the range 8S–11S.

- Zhang and Jin (1996, pp. 652, 689) includes  $\text{Si}(x)$ ,  $\text{Ci}(x)$ ,  $x = 0(.5)20(2)30$ , 8D;  $\text{Ei}(x)$ ,  $E_1(x)$ ,  $x = [0, 100]$ , 8S.

### 6.19(iii) Complex Variables, $z = x + iy$

- Abramowitz and Stegun (1964, Chapter 5) includes the real and imaginary parts of  $ze^z E_1(z)$ ,  $x = -19(1)20$ ,  $y = 0(1)20$ , 6D;  $e^z E_1(z)$ ,  $x = -4(.5) - 2$ ,  $y = 0(.2)1$ , 6D;  $E_1(z) + \ln z$ ,  $x = -2(.5)2.5$ ,  $y = 0(.2)1$ , 6D.
- Zhang and Jin (1996, pp. 690–692) includes the real and imaginary parts of  $E_1(z)$ ,  $\pm x = 0.5, 1, 3, 5, 10, 15, 20, 50, 100$ ,  $y = 0(.5)1(1)5(5)30, 50, 100$ , 8S.

## 6.20 Approximations

### 6.20(i) Approximations in Terms of Elementary Functions

- Hastings (1955) gives several minimax polynomial and rational approximations for  $E_1(x) + \ln x$ ,  $xe^x E_1(x)$ , and the auxiliary functions  $f(x)$  and  $g(x)$ . These are included in Abramowitz and Stegun (1964, Ch. 5).
- Cody and Thacher (1968) provides minimax rational approximations for  $E_1(x)$ , with accuracies up to 20S.
- Cody and Thacher (1969) provides minimax rational approximations for  $\text{Ei}(x)$ , with accuracies up to 20S.
- MacLeod (1996) provides rational approximations for the sine and cosine integrals and for the auxiliary functions  $f$  and  $g$ , with accuracies up to 20S.

### 6.20(ii) Expansions in Chebyshev Series

- Clenshaw (1962) gives Chebyshev coefficients for  $-E_1(x) - \ln|x|$  for  $-4 \leq x \leq 4$  and  $e^x E_1(x)$  for  $x \geq 4$  (20D).
- Luke and Wimp (1963) covers  $\text{Ei}(x)$  for  $x \leq -4$  (20D), and  $\text{Si}(x)$  and  $\text{Ci}(x)$  for  $x \geq 4$  (20D).
- Luke (1969b, pp. 41–42) gives Chebyshev expansions of  $\text{Ein}(ax)$ ,  $\text{Si}(ax)$ , and  $\text{Cin}(ax)$  for  $-1 \leq x \leq 1$ ,  $a \in \mathbb{C}$ . The coefficients are given in terms of series of Bessel functions.

- Luke (1969b, pp. 321–322) covers  $\text{Ein}(x)$  and  $-\text{Ein}(-x)$  for  $0 \leq x \leq 8$  (the Chebyshev coefficients are given to 20D);  $E_1(x)$  for  $x \geq 5$  (20D), and  $\text{Ei}(x)$  for  $x \geq 8$  (15D). Coefficients for the sine and cosine integrals are given on pp. 325–327.
- Luke (1969b, p. 25) gives a Chebyshev expansion near infinity for the confluent hypergeometric  $U$ -function (§13.2(i)) from which Chebyshev expansions near infinity for  $E_1(z)$ ,  $f(z)$ , and  $g(z)$  follow by using (6.11.2) and (6.11.3). Luke also includes a recursion scheme for computing the coefficients in the expansions of the  $U$  functions. If  $|\text{ph } z| < \pi$  the scheme can be used in backward direction.

### 6.20(iii) Padé-Type and Rational Expansions

- Luke (1969b, pp. 402, 410, and 415–421) gives main diagonal Padé approximations for  $\text{Ein}(z)$ ,  $\text{Si}(z)$ ,  $\text{Cin}(z)$  (valid near the origin), and  $E_1(z)$  (valid for large  $|z|$ ); approximate errors are given for a selection of  $z$ -values.
- Luke (1969b, pp. 411–414) gives rational approximations for  $\text{Ein}(z)$ .

## 6.21 Software

See <http://dlmf.nist.gov/6.21>.

## References

### General References

For general bibliographic reading see Andrews *et al.* (1999), Jeffreys and Jeffreys (1956), Lebedev (1965), Olver (1997b), and Temme (1996a).

### Sources

The following list gives the references or other indications of proofs that were used in constructing the various sections of this chapter. These sources supplement the references that are quoted in the text.

- §6.2 Olver (1997b, pp. 40–42).
- §6.3 These graphics were produced at NIST.
- §6.4 For (6.4.1) see Olver (1997b, p. 40). (6.4.3) follows from (6.6.2) and (6.6.4). (6.4.4) and (6.4.5) follow from (6.2.13) and (6.2.16). (6.4.6) and (6.4.7) follow from (6.2.17), (6.2.18), and (6.4.4).
- §6.5 For (6.5.1) and (6.5.2) see Olver (1997b, p. 41). (6.5.3) and (6.5.4) follow from (6.6.1), (6.6.2), (6.6.5), and (6.6.6). For (6.5.5) and (6.5.6) see Olver (1997b, p. 42). (6.5.7) follows from (6.2.10), (6.2.17), (6.2.18), (6.5.5), and (6.5.6).
- §6.6 Olver (1997b, pp. 40–43). (6.6.3) follows from (6.11.2) and (13.2.9).
- §6.7 (6.7.1) and (6.7.2) follow from the definitions (§6.2(i)). (6.7.3)–(6.7.6) follow from differentiation with respect to  $x$ . (6.7.7) and (6.7.8) follow from replacing the trigonometric functions by exponentials. For (6.7.9)–(6.7.11) see Nielsen (1906b, p. 13: there are sign errors in Eq. (27)). (6.7.12)–(6.7.14) follow from (6.5.7), (6.2.1), and (6.2.2); for the second equations in (6.7.13) and (6.7.14) see Temme (1996a, pp. 187–188). For (6.7.15) and (6.7.16) use (10.32.10).
- §6.8 See Gautschi (1959b) for (6.8.1), and Luke (1969b, p. 201) for (6.8.2) and (6.8.3).
- §6.9 Nielsen (1906b, pp. 42–44), or Lorentzen and Waadeland (1992, p. 577).
- §6.10 Nielsen (1906a, p. 283). (6.10.3) follows from  $1/(1 - \ln(1 - t)) = \sum_{k=0}^{\infty} c_k t^k$ .
- §6.11 Temme (1996a, pp. 180 and 187). For (6.11.3) use (6.5.7).
- §6.12 For (6.12.2) see Olver (1997b, p. 227). (6.12.3) and (6.12.4) follow from (6.7.13) and (6.7.14) by applying Watson’s lemma (§2.4(i)). (6.12.5)–(6.12.8) follow from (6.7.13), (6.7.14), and the identity  $(t^2 + 1)^{-1} = \sum_{m=0}^{n-1} (-1)^m t^{2m} + (-1)^n t^{2n} (t^2 + 1)^{-1}$ . The error bounds are obtained by setting  $t = \sqrt{\tau}$  in (6.12.7) and (6.12.8), rotating the integration path in the  $\tau$ -plane through an angle  $-2 \text{ph } z$ , and then replacing  $|\tau + 1|$  by its minimum value on the path.
- §6.13 See Cody and Thacher (1969) for  $x_0$  in (6.13.1).
- §6.14 Nielsen (1906b, pp. 48–50, 53, and 54: there is a  $\frac{1}{2}$  missing in the formula that corresponds to (6.14.2) and a sign error in the formula that corresponds to (6.14.7)).
- §6.15 Slavić (1974).
- §6.16 Temme (1996a, pp. 181–182: the numerical value 1.089490... on p. 182 should be replaced by 1.1789...). Gibbs reported this phenomenon in a letter to *Nature*, **59** (1899, p. 606). Figures 6.16.1 and 6.16.2 were produced at NIST.



## Chapter 7

# Error Functions, Dawson's and Fresnel Integrals

N. M. Temme<sup>1</sup>

<b>Notation</b>	<b>160</b>	7.15 Sums . . . . .	166
7.1 Special Notation . . . . .	160	7.16 Generalized Error Functions . . . . .	166
<b>Properties</b>	<b>160</b>	7.17 Inverse Error Functions . . . . .	166
7.2 Definitions . . . . .	160	7.18 Repeated Integrals of the Complementary Error Function . . . . .	167
7.3 Graphics . . . . .	160	7.19 Voigt Functions . . . . .	167
7.4 Symmetry . . . . .	161	<b>Applications</b>	<b>168</b>
7.5 Interrelations . . . . .	162	7.20 Mathematical Applications . . . . .	168
7.6 Series Expansions . . . . .	162	7.21 Physical Applications . . . . .	169
7.7 Integral Representations . . . . .	162	<b>Computation</b>	<b>169</b>
7.8 Inequalities . . . . .	163	7.22 Methods of Computation . . . . .	169
7.9 Continued Fractions . . . . .	163	7.23 Tables . . . . .	169
7.10 Derivatives . . . . .	163	7.24 Approximations . . . . .	170
7.11 Relations to Other Functions . . . . .	164	7.25 Software . . . . .	170
7.12 Asymptotic Expansions . . . . .	164	<b>References</b>	<b>170</b>
7.13 Zeros . . . . .	165		
7.14 Integrals . . . . .	166		

<sup>1</sup>Centrum voor Wiskunde en Informatica, Department MAS, Amsterdam, The Netherlands.

**Acknowledgments:** This chapter is based in part on Abramowitz and Stegun (1964, Chapter 7) by Walter Gautschi. Walter Gautschi provided the author with a list of references and comments collected since the original publication.

**Copyright** © 2009 National Institute of Standards and Technology. All rights reserved.



## Notation

### 7.1 Special Notation

(For other notation see pp. xiv and 873.)

- $x$  real variable.
- $z$  complex variable.
- $n$  nonnegative integer.
- $\delta$  arbitrary small positive constant.
- $\gamma$  Euler's constant (§5.2(ii)).

Unless otherwise noted, primes indicate derivatives with respect to the argument.

The main functions treated in this chapter are the error function  $\operatorname{erf} z$ ; the complementary error functions  $\operatorname{erfc} z$  and  $w(z)$ ; Dawson's integral  $F(z)$ ; the Fresnel integrals  $\mathcal{F}(z)$ ,  $C(z)$ , and  $S(z)$ ; the Goodwin–Staton integral  $G(z)$ ; the repeated integrals of the complementary error function  $i^n \operatorname{erfc}(z)$ ; the Voigt functions  $U(x, t)$  and  $V(x, t)$ .

Alternative notations are  $P(z) = \frac{1}{2} \operatorname{erfc}(-z/\sqrt{2})$ ,  $Q(z) = \Phi(z) = \frac{1}{2} \operatorname{erfc}(z/\sqrt{2})$ ,  $\operatorname{Erf} z = \frac{1}{2} \sqrt{\pi} \operatorname{erf} z$ ,  $\operatorname{Erfi} z = e^{z^2} F(z)$ ,  $C_1(z) = C(\sqrt{2/\pi}z)$ ,  $S_1(z) = S(\sqrt{2/\pi}z)$ ,  $C_2(z) = C(\sqrt{2z/\pi})$ ,  $S_2(z) = S(\sqrt{2z/\pi})$ .

The notations  $P(z)$ ,  $Q(z)$ , and  $\Phi(z)$  are used in mathematical statistics, where these functions are called the *normal* or *Gaussian probability functions*.

## Properties

### 7.2 Definitions

#### 7.2(i) Error Functions

$$7.2.1 \quad \operatorname{erf} z = \frac{2}{\sqrt{\pi}} \int_0^z e^{-t^2} dt,$$

$$7.2.2 \quad \operatorname{erfc} z = \frac{2}{\sqrt{\pi}} \int_z^\infty e^{-t^2} dt = 1 - \operatorname{erf} z,$$

7.2.3

$$w(z) = e^{-z^2} \left( 1 + \frac{2i}{\sqrt{\pi}} \int_0^z e^{t^2} dt \right) = e^{-z^2} \operatorname{erfc}(-iz).$$

$\operatorname{erf} z$ ,  $\operatorname{erfc} z$ , and  $w(z)$  are entire functions of  $z$ , as is  $F(z)$  in the next subsection.

#### Values at Infinity

$$7.2.4 \quad \lim_{z \rightarrow \infty} \operatorname{erf} z = 1, \quad \lim_{z \rightarrow \infty} \operatorname{erfc} z = 0,$$

$$|\operatorname{ph} z| \leq \frac{1}{4}\pi - \delta (< \frac{1}{4}\pi).$$

#### 7.2(ii) Dawson's Integral

$$7.2.5 \quad F(z) = e^{-z^2} \int_0^z e^{t^2} dt.$$

#### 7.2(iii) Fresnel Integrals

$$7.2.6 \quad \mathcal{F}(z) = \int_z^\infty e^{\frac{1}{2}\pi i t^2} dt,$$

$$7.2.7 \quad C(z) = \int_0^z \cos\left(\frac{1}{2}\pi t^2\right) dt,$$

$$7.2.8 \quad S(z) = \int_0^z \sin\left(\frac{1}{2}\pi t^2\right) dt,$$

$\mathcal{F}(z)$ ,  $C(z)$ , and  $S(z)$  are entire functions of  $z$ , as are  $f(z)$  and  $g(z)$  in the next subsection.

#### Values at Infinity

$$7.2.9 \quad \lim_{x \rightarrow \infty} C(x) = \frac{1}{2}, \quad \lim_{x \rightarrow \infty} S(x) = \frac{1}{2}.$$

#### 7.2(iv) Auxiliary Functions

7.2.10

$$f(z) = \left(\frac{1}{2} - S(z)\right) \cos\left(\frac{1}{2}\pi z^2\right) - \left(\frac{1}{2} - C(z)\right) \sin\left(\frac{1}{2}\pi z^2\right),$$

7.2.11

$$g(z) = \left(\frac{1}{2} - C(z)\right) \cos\left(\frac{1}{2}\pi z^2\right) + \left(\frac{1}{2} - S(z)\right) \sin\left(\frac{1}{2}\pi z^2\right).$$

#### 7.2(v) Goodwin–Staton Integral

$$7.2.12 \quad G(z) = \int_0^\infty \frac{e^{-t^2}}{t+z} dt, \quad |\operatorname{ph} z| < \pi.$$

### 7.3 Graphics

#### 7.3(i) Real Variable

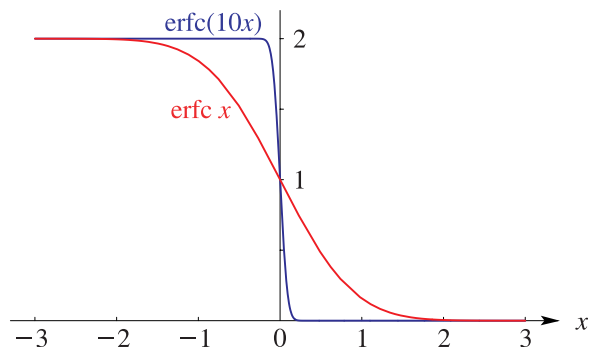


Figure 7.3.1: Complementary error functions  $\operatorname{erfc} x$  and  $\operatorname{erfc}(10x)$ ,  $-3 \leq x \leq 3$ .

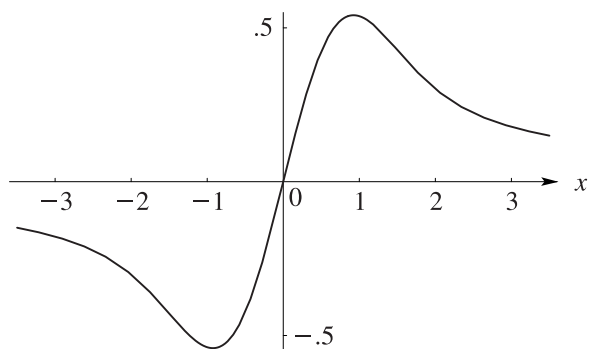


Figure 7.3.2: Dawson's integral  $F(x)$ ,  $-3.5 \leq x \leq 3.5$ .

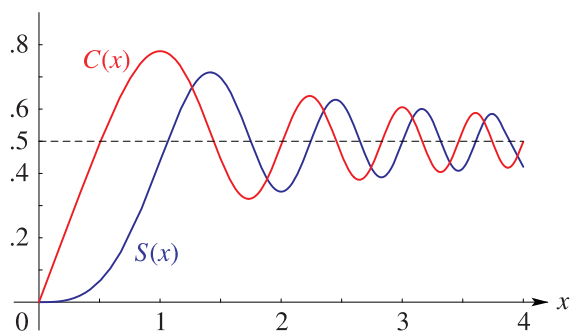


Figure 7.3.3: Fresnel integrals  $C(x)$  and  $S(x)$ ,  $0 \leq x \leq 4$ .

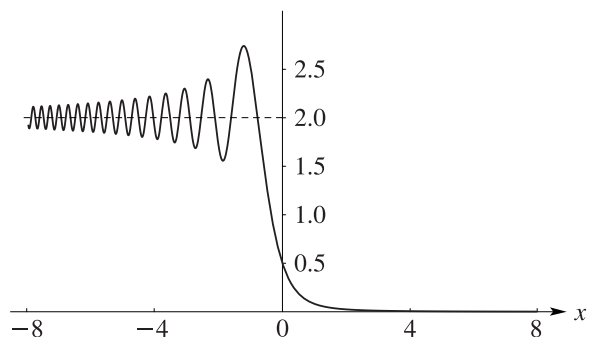


Figure 7.3.4:  $|\mathcal{F}(x)|^2$ ,  $-8 \leq x \leq 8$ . Fresnel (1818) introduced the integral  $\mathcal{F}(x)$  in his study of the interference pattern at the edge of a shadow. He observed that the intensity distribution is given by  $|\mathcal{F}(x)|^2$ .

### 7.3(ii) Complex Variable

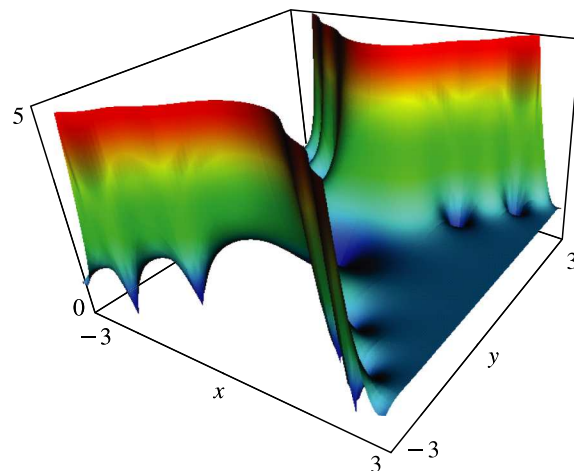


Figure 7.3.5:  $|\operatorname{erf}(x + iy)|$ ,  $-3 \leq x \leq 3$ ,  $-3 \leq y \leq 3$ . Compare §7.13(i).

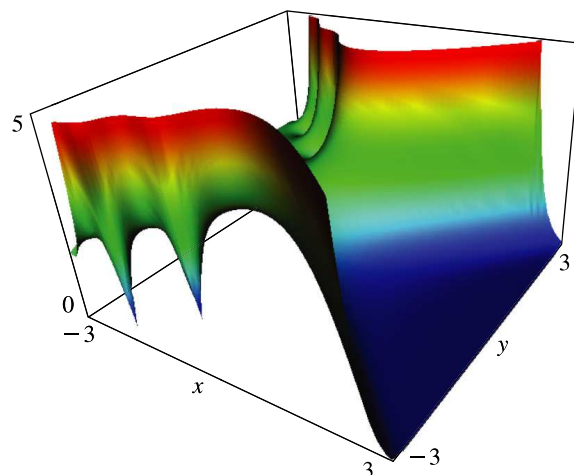


Figure 7.3.6:  $|\operatorname{erfc}(x + iy)|$ ,  $-3 \leq x \leq 3$ ,  $-3 \leq y \leq 3$ . Compare §§7.12(i) and 7.13(ii).

### 7.4 Symmetry

- 7.4.1  $\operatorname{erf}(-z) = -\operatorname{erf}(z)$ ,
- 7.4.2  $\operatorname{erfc}(-z) = 2 - \operatorname{erfc}(z)$ ,
- 7.4.3  $w(-z) = 2e^{-z^2} - w(z)$ .
- 7.4.4  $F(-z) = -F(z)$ .
- 7.4.5  $C(-z) = -C(z)$ ,  $S(-z) = -S(z)$ ,
- 7.4.6  $C(iz) = iC(z)$ ,  $S(iz) = -iS(z)$ .
- 7.4.7  $f(iz) = (1/\sqrt{2})e^{\frac{1}{4}\pi i - \frac{1}{2}\pi iz^2} - if(z)$ ,
- 7.4.7  $g(iz) = (1/\sqrt{2})e^{-\frac{1}{4}\pi i - \frac{1}{2}\pi iz^2} + ig(z)$ .

$$\begin{aligned}
 7.4.8 \quad f(-z) &= \sqrt{2} \cos\left(\frac{1}{4}\pi + \frac{1}{2}\pi z^2\right) - f(z), \\
 g(-z) &= \sqrt{2} \sin\left(\frac{1}{4}\pi + \frac{1}{2}\pi z^2\right) - g(z).
 \end{aligned}$$

## 7.5 Interrelations

$$7.5.1 \quad F(z) = \frac{1}{2}i\sqrt{\pi} \left( e^{-z^2} - w(z) \right) = -\frac{1}{2}i\sqrt{\pi} e^{-z^2} \operatorname{erf}(iz).$$

$$7.5.2 \quad C(z) + iS(z) = \frac{1}{2}(1+i) - \mathcal{F}(z).$$

$$7.5.3 \quad C(z) = \frac{1}{2} + f(z) \sin\left(\frac{1}{2}\pi z^2\right) - g(z) \cos\left(\frac{1}{2}\pi z^2\right),$$

$$7.5.4 \quad S(z) = \frac{1}{2} - f(z) \cos\left(\frac{1}{2}\pi z^2\right) - g(z) \sin\left(\frac{1}{2}\pi z^2\right).$$

$$7.5.5 \quad e^{-\frac{1}{2}\pi iz^2} \mathcal{F}(z) = g(z) + if(z).$$

$$7.5.6 \quad e^{\pm \frac{1}{2}\pi iz^2} (g(z) \pm if(z)) = \frac{1}{2}(1 \pm i) - (C(z) \pm iS(z)).$$

In (7.5.8)–(7.5.10)

$$7.5.7 \quad \zeta = \frac{1}{2}\sqrt{\pi}(1 \mp i)z,$$

and either all upper signs or all lower signs are taken throughout.

$$7.5.8 \quad C(z) \pm iS(z) = \frac{1}{2}(1 \pm i) \operatorname{erf} \zeta.$$

$$7.5.9 \quad C(z) \pm iS(z) = \frac{1}{2}(1 \pm i) \left( 1 - e^{\pm \frac{1}{2}\pi iz^2} w(i\zeta) \right).$$

$$7.5.10 \quad g(z) \pm if(z) = \frac{1}{2}(1 \pm i) e^{\zeta^2} \operatorname{erfc} \zeta.$$

$$7.5.11 \quad |\mathcal{F}(x)|^2 = f^2(x) + g^2(x), \quad x \geq 0,$$

$$\begin{aligned}
 7.5.12 \quad |\mathcal{F}(x)|^2 &= 2 + f^2(-x) + g^2(-x) \\
 &\quad - 2\sqrt{2} \cos\left(\frac{1}{4}\pi + \frac{1}{2}\pi x^2\right) f(-x) \\
 &\quad - 2\sqrt{2} \cos\left(\frac{1}{4}\pi - \frac{1}{2}\pi x^2\right) g(-x), \quad x \leq 0.
 \end{aligned}$$

See Figure 7.3.4.

$$7.5.13 \quad G(x) = \sqrt{\pi} F(x) - \frac{1}{2}e^{-x^2} \operatorname{Ei}(x^2), \quad x > 0.$$

For  $\operatorname{Ei}(x)$  see §6.2(i).

## 7.6 Series Expansions

### 7.6(i) Power Series

$$7.6.1 \quad \operatorname{erf} z = \frac{2}{\sqrt{\pi}} \sum_{n=0}^{\infty} \frac{(-1)^n z^{2n+1}}{n!(2n+1)},$$

$$7.6.2 \quad \operatorname{erf} z = \frac{2}{\sqrt{\pi}} e^{-z^2} \sum_{n=0}^{\infty} \frac{2^n z^{2n+1}}{1 \cdot 3 \cdots (2n+1)},$$

$$7.6.3 \quad w(z) = \sum_{n=0}^{\infty} \frac{(iz)^n}{\Gamma\left(\frac{1}{2}n+1\right)}.$$

$$7.6.4 \quad C(z) = \sum_{n=0}^{\infty} \frac{(-1)^n \left(\frac{1}{2}\pi\right)^{2n}}{(2n)!(4n+1)} z^{4n+1},$$

$$\begin{aligned}
 7.6.5 \quad C(z) &= \cos\left(\frac{1}{2}\pi z^2\right) \sum_{n=0}^{\infty} \frac{(-1)^n \pi^{2n}}{1 \cdot 3 \cdots (4n+1)} z^{4n+1} \\
 &\quad + \sin\left(\frac{1}{2}\pi z^2\right) \sum_{n=0}^{\infty} \frac{(-1)^n \pi^{2n+1}}{1 \cdot 3 \cdots (4n+3)} z^{4n+3}.
 \end{aligned}$$

$$7.6.6 \quad S(z) = \sum_{n=0}^{\infty} \frac{(-1)^n \left(\frac{1}{2}\pi\right)^{2n+1}}{(2n+1)!(4n+3)} z^{4n+3},$$

$$\begin{aligned}
 7.6.7 \quad S(z) &= -\cos\left(\frac{1}{2}\pi z^2\right) \sum_{n=0}^{\infty} \frac{(-1)^n \pi^{2n+1}}{1 \cdot 3 \cdots (4n+3)} z^{4n+3} \\
 &\quad + \sin\left(\frac{1}{2}\pi z^2\right) \sum_{n=0}^{\infty} \frac{(-1)^n \pi^{2n}}{1 \cdot 3 \cdots (4n+1)} z^{4n+1}.
 \end{aligned}$$

The series in this subsection and in §7.6(ii) converge for all finite values of  $|z|$ .

### 7.6(ii) Expansions in Series of Spherical Bessel Functions

For the notation see §§10.47(ii) and 18.3.

$$7.6.8 \quad \operatorname{erf} z = \frac{2z}{\sqrt{\pi}} \sum_{n=0}^{\infty} (-1)^n \left( i_{2n}^{(1)}(z^2) - i_{2n+1}^{(1)}(z^2) \right),$$

$$7.6.9 \quad \operatorname{erf}(az) = \frac{2z}{\sqrt{\pi}} e^{(\frac{1}{2}-a^2)z^2} \sum_{n=0}^{\infty} T_{2n+1}(a) i_n^{(1)}\left(\frac{1}{2}z^2\right),$$

$-1 \leq a \leq 1.$

$$7.6.10 \quad C(z) = z \sum_{n=0}^{\infty} j_{2n}\left(\frac{1}{2}\pi z^2\right),$$

$$7.6.11 \quad S(z) = z \sum_{n=0}^{\infty} j_{2n+1}\left(\frac{1}{2}\pi z^2\right).$$

For further results see Luke (1969b, pp. 57–58).

## 7.7 Integral Representations

### 7.7(i) Error Functions and Dawson's Integral

Integrals of the type  $\int e^{-z^2} R(z) dz$ , where  $R(z)$  is an arbitrary rational function, can be written in closed form in terms of the error functions and elementary functions.

$$7.7.1 \quad \operatorname{erfc} z = \frac{2}{\pi} e^{-z^2} \int_0^{\infty} \frac{e^{-z^2 t^2}}{t^2 + 1} dt, \quad |\operatorname{ph} z| \leq \frac{1}{4}\pi,$$

$$7.7.2 \quad w(z) = \frac{1}{\pi i} \int_{-\infty}^{\infty} \frac{e^{-t^2}}{t-z} dt = \frac{2z}{\pi i} \int_0^{\infty} \frac{e^{-t^2}}{t^2 - z^2} dt, \quad \Im z > 0.$$

$$7.7.3 \quad \int_0^{\infty} e^{-at^2 + 2izt} dt = \frac{1}{2} \sqrt{\frac{\pi}{a}} e^{-z^2/a} + \frac{i}{\sqrt{a}} F\left(\frac{z}{\sqrt{a}}\right),$$

$\Re a > 0.$

$$7.7.4 \quad \int_0^{\infty} \frac{e^{-at}}{\sqrt{t+z^2}} dt = \sqrt{\frac{\pi}{a}} e^{az^2} \operatorname{erfc}(\sqrt{a}z), \quad \Re a > 0, \Re z > 0.$$

$$7.7.5 \quad \int_0^1 \frac{e^{-at^2}}{t^2+1} dt = \frac{\pi}{4} e^a (1 - (\operatorname{erf} \sqrt{a})^2), \quad \Re a > 0.$$

$$7.7.6 \quad \int_x^\infty e^{-(at^2+2bt+c)} dt \\ = \frac{1}{2} \sqrt{\frac{\pi}{a}} e^{(b^2-ac)/a} \operatorname{erfc} \left( \sqrt{a}x + \frac{b}{\sqrt{a}} \right), \quad \Re a > 0.$$

$$7.7.7 \quad \int_x^\infty e^{-a^2t^2-(b^2/t^2)} dt = \frac{\sqrt{\pi}}{4a} (e^{2ab} \operatorname{erfc}(ax + (b/x)) \\ + e^{-2ab} \operatorname{erfc}(ax - (b/x))), \\ x > 0, \quad |\operatorname{ph} a| < \frac{1}{4}\pi.$$

$$7.7.8 \quad \int_0^\infty e^{-a^2t^2-(b^2/t^2)} dt = \frac{\sqrt{\pi}}{2a} e^{-2ab}, \\ |\operatorname{ph} a| < \frac{1}{4}\pi, \quad |\operatorname{ph} b| < \frac{1}{4}\pi.$$

$$7.7.9 \quad \int_0^x \operatorname{erf} t dt = x \operatorname{erf} x + \frac{1}{\sqrt{\pi}} (e^{-x^2} - 1).$$

### 7.7(ii) Auxiliary Functions

$$7.7.10 \quad f(z) = \frac{1}{\pi\sqrt{2}} \int_0^\infty \frac{e^{-\pi z^2 t/2}}{\sqrt{t}(t^2+1)} dt, \quad |\operatorname{ph} z| \leq \frac{1}{4}\pi,$$

$$7.7.11 \quad g(z) = \frac{1}{\pi\sqrt{2}} \int_0^\infty \frac{\sqrt{t} e^{-\pi z^2 t/2}}{t^2+1} dt, \quad |\operatorname{ph} z| \leq \frac{1}{4}\pi,$$

$$7.7.12 \quad g(z) + i f(z) = e^{-\pi i z^2/2} \int_z^\infty e^{\pi i t^2/2} dt.$$

### Mellin–Barnes Integrals

$$7.7.13 \quad f(z) = \frac{(2\pi)^{-3/2}}{2\pi i} \int_{c-i\infty}^{c+i\infty} \zeta^{-s} \Gamma(s) \Gamma(s + \frac{1}{2}) \\ \times \Gamma(s + \frac{3}{4}) \Gamma(\frac{1}{4} - s) ds,$$

$$7.7.14 \quad g(z) = \frac{(2\pi)^{-3/2}}{2\pi i} \int_{c-i\infty}^{c+i\infty} \zeta^{-s} \Gamma(s) \Gamma(s + \frac{1}{2}) \\ \times \Gamma(s + \frac{1}{4}) \Gamma(\frac{3}{4} - s) ds.$$

In (7.7.13) and (7.7.14) the integration paths are straight lines,  $\zeta = \frac{1}{16}\pi^2 z^4$ , and  $c$  is a constant such that  $0 < c < \frac{1}{4}$  in (7.7.13), and  $0 < c < \frac{3}{4}$  in (7.7.14).

$$7.7.15 \quad \int_0^\infty e^{-at} \cos(t^2) dt = \sqrt{\frac{\pi}{2}} f\left(\frac{a}{\sqrt{2\pi}}\right), \quad \Re a > 0,$$

$$7.7.16 \quad \int_0^\infty e^{-at} \sin(t^2) dt = \sqrt{\frac{\pi}{2}} g\left(\frac{a}{\sqrt{2\pi}}\right), \quad \Re a > 0.$$

### 7.7(iii) Compendia

For other integral representations see Erdélyi *et al.* (1954a, vol. 1, pp. 265–267, 270), Ng and Geller (1969), Oberhettinger (1974, pp. 246–248), and Oberhettinger and Badii (1973, pp. 371–377).

## 7.8 Inequalities

Let  $M(x)$  denote *Mills' ratio*:

$$7.8.1 \quad M(x) = \frac{\int_x^\infty e^{-t^2} dt}{e^{-x^2}} = e^{x^2} \int_x^\infty e^{-t^2} dt.$$

(Other notations are often used.) Then

$$7.8.2 \quad \frac{1}{x + \sqrt{x^2 + 2}} < M(x) \leq \frac{1}{x + \sqrt{x^2 + (4/\pi)}}, \quad x \geq 0,$$

$$7.8.3 \quad \frac{\sqrt{\pi}}{2\sqrt{\pi}x + 2} \leq M(x) < \frac{1}{x + 1}, \quad x \geq 0,$$

$$7.8.4 \quad M(x) < \frac{2}{3x + \sqrt{x^2 + 4}}, \quad x > -\frac{1}{2}\sqrt{2},$$

$$7.8.5 \quad \frac{x^2}{2x^2 + 1} \leq \frac{x^2(2x^2 + 5)}{4x^4 + 12x^2 + 3} \leq xM(x) \\ < \frac{2x^4 + 9x^2 + 4}{4x^4 + 20x^2 + 15} < \frac{x^2 + 1}{2x^2 + 3}, \quad x \geq 0.$$

Next,

$$7.8.6 \quad \int_0^x e^{at^2} dt < \frac{1}{3ax} (2e^{ax^2} + ax^2 - 2), \quad a, x > 0.$$

$$7.8.7 \quad \int_0^x e^{t^2} dt < \frac{e^{x^2} - 1}{x}, \quad x > 0.$$

## 7.9 Continued Fractions

$$7.9.1 \quad \sqrt{\pi} e^{z^2} \operatorname{erfc} z = \frac{z}{z^2 + 1} - \frac{\frac{1}{2}}{z^2 + 1} + \frac{1}{z^2 + 1} - \frac{\frac{3}{2}}{z^2 + 1} + \frac{2}{z^2 + 1} - \dots, \quad \Re z > 0,$$

$$7.9.2 \quad \sqrt{\pi} e^{z^2} \operatorname{erfc} z = \frac{2z}{2z^2 + 1} - \frac{1 \cdot 2}{2z^2 + 5} + \frac{3 \cdot 4}{2z^2 + 9} - \dots, \quad \Re z > 0,$$

$$7.9.3 \quad w(z) = \frac{i}{\sqrt{\pi}} \frac{1}{z} - \frac{\frac{1}{2}}{z} + \frac{1}{z} - \frac{\frac{3}{2}}{z} + \frac{2}{z} - \dots, \quad \Im z > 0.$$

See also Cuyt *et al.* (2008, pp. 255–260, 263–267, 270–273).

## 7.10 Derivatives

$$7.10.1 \quad \frac{d^{n+1} \operatorname{erf} z}{dz^{n+1}} = (-1)^n \frac{2}{\sqrt{\pi}} H_n(z) e^{-z^2}, \quad n = 0, 1, 2, \dots$$

For the Hermite polynomial  $H_n(z)$  see §18.3.

$$7.10.2 \quad w'(z) = -2z w(z) + (2i/\sqrt{\pi}),$$

**7.10.3**

$$w^{(n+2)}(z) + 2z w^{(n+1)}(z) + 2(n+1)w^{(n)}(z) = 0, \\ n = 0, 1, 2, \dots$$

$$7.10.4 \quad \frac{df(z)}{dz} = -\pi z g(z), \quad \frac{dg(z)}{dz} = \pi z f(z) - 1.$$

**7.11 Relations to Other Functions****Incomplete Gamma Functions and Generalized Exponential Integral**

For the notation see §§8.2(i) and 8.19(i).

$$7.11.1 \quad \operatorname{erf} z = \frac{1}{\sqrt{\pi}} \gamma\left(\frac{1}{2}, z^2\right),$$

$$7.11.2 \quad \operatorname{erfc} z = \frac{1}{\sqrt{\pi}} \Gamma\left(\frac{1}{2}, z^2\right),$$

$$7.11.3 \quad \operatorname{erfc} z = \frac{z}{\sqrt{\pi}} E_{\frac{1}{2}}(z^2).$$

**Confluent Hypergeometric Functions**

For the notation see §13.2(i).

$$7.11.4 \quad \operatorname{erf} z = \frac{2z}{\sqrt{\pi}} M\left(\frac{1}{2}, \frac{3}{2}, -z^2\right) = \frac{2z}{\sqrt{\pi}} e^{-z^2} M\left(1, \frac{3}{2}, z^2\right),$$

**7.11.5**

$$\operatorname{erfc} z = \frac{1}{\sqrt{\pi}} e^{-z^2} U\left(\frac{1}{2}, \frac{1}{2}, z^2\right) = \frac{z}{\sqrt{\pi}} e^{-z^2} U\left(1, \frac{3}{2}, z^2\right).$$

$$7.11.6 \quad \begin{aligned} C(z) + iS(z) &= z M\left(\frac{1}{2}, \frac{3}{2}, \frac{1}{2}\pi iz^2\right) \\ &= ze^{\pi iz^2/2} M\left(1, \frac{3}{2}, -\frac{1}{2}\pi iz^2\right). \end{aligned}$$

**Generalized Hypergeometric Functions**

For the notation see §§16.2(i) and 16.2(ii).

$$7.11.7 \quad C(z) = z {}_1F_2\left(\frac{1}{4}, \frac{5}{4}, \frac{1}{2}; -\frac{1}{16}\pi^2 z^4\right),$$

$$7.11.8 \quad S(z) = \frac{1}{6}\pi z^3 {}_1F_2\left(\frac{3}{4}, \frac{7}{4}, \frac{3}{2}; -\frac{1}{16}\pi^2 z^4\right).$$

**7.12 Asymptotic Expansions****7.12(i) Complementary Error Function**

As  $z \rightarrow \infty$

**7.12.1**

$$\operatorname{erfc} z \sim \frac{e^{-z^2}}{\sqrt{\pi}z} \sum_{m=0}^{\infty} (-1)^m \frac{1 \cdot 3 \cdot 5 \cdots (2m-1)}{(2z^2)^m}, \\ \operatorname{erfc}(-z) \sim 2 - \frac{e^{-z^2}}{\sqrt{\pi}z} \sum_{m=0}^{\infty} (-1)^m \frac{1 \cdot 3 \cdot 5 \cdots (2m-1)}{(2z^2)^m},$$

both expansions being valid when  $|\operatorname{ph} z| \leq \frac{3}{4}\pi - \delta$  ( $< \frac{3}{4}\pi$ ).

When  $|\operatorname{ph} z| \leq \frac{1}{4}\pi$  the remainder terms are bounded in magnitude by the first neglected terms, and have the same sign as these terms when  $\operatorname{ph} z = 0$ . When  $\frac{1}{4}\pi \leq |\operatorname{ph} z| < \frac{1}{2}\pi$  the remainder terms are bounded in magnitude by  $\csc(2|\operatorname{ph} z|)$  times the first neglected

terms. For these and other error bounds see Olver (1997b, pp. 109–112), with  $\alpha = \frac{1}{2}$  and  $z$  replaced by  $z^2$ ; compare (7.11.2).

For re-expansions of the remainder terms leading to larger sectors of validity, exponential improvement, and a smooth interpretation of the Stokes phenomenon, see §§2.11(ii)–2.11(iv) and use (7.11.3). (Note that some of these re-expansions themselves involve the complementary error function.)

**7.12(ii) Fresnel Integrals**

The asymptotic expansions of  $C(z)$  and  $S(z)$  are given by (7.5.3), (7.5.4), and

$$7.12.2 \quad f(z) \sim \frac{1}{\pi z} \sum_{m=0}^{\infty} (-1)^m \frac{1 \cdot 3 \cdot 5 \cdots (4m-1)}{(\pi z^2)^{2m}},$$

$$7.12.3 \quad g(z) \sim \frac{1}{\pi^2 z^3} \sum_{m=0}^{\infty} (-1)^m \frac{1 \cdot 3 \cdot 5 \cdots (4m+1)}{(\pi z^2)^{2m}},$$

as  $z \rightarrow \infty$  in  $|\operatorname{ph} z| \leq \frac{1}{2}\pi - \delta$  ( $< \frac{1}{2}\pi$ ). The remainder terms are given by

$$7.12.4 \quad f(z) = \frac{1}{\pi z} \sum_{m=0}^{n-1} (-1)^m \frac{1 \cdot 3 \cdots (4m-1)}{(\pi z^2)^{2m}} + R_n^{(f)}(z),$$

**7.12.5**

$$g(z) = \frac{1}{\pi^2 z^3} \sum_{m=0}^{n-1} (-1)^m \frac{1 \cdot 3 \cdots (4m+1)}{(\pi z^2)^{2m}} + R_n^{(g)}(z),$$

where, for  $n = 0, 1, 2, \dots$  and  $|\operatorname{ph} z| < \frac{1}{4}\pi$ ,

$$7.12.6 \quad R_n^{(f)}(z) = \frac{(-1)^n}{\pi\sqrt{2}} \int_0^{\infty} \frac{e^{-\pi z^2 t/2} t^{2n-(1/2)}}{t^2+1} dt,$$

$$7.12.7 \quad R_n^{(g)}(z) = \frac{(-1)^n}{\pi\sqrt{2}} \int_0^{\infty} \frac{e^{-\pi z^2 t/2} t^{2n+(1/2)}}{t^2+1} dt.$$

When  $|\operatorname{ph} z| \leq \frac{1}{8}\pi$ ,  $R_n^{(f)}(z)$  and  $R_n^{(g)}(z)$  are bounded in magnitude by the first neglected terms in (7.12.2) and (7.12.3), respectively, and have the same signs as these terms when  $\operatorname{ph} z = 0$ . They are bounded by  $|\csc(4\operatorname{ph} z)|$  times the first neglected terms when  $\frac{1}{8}\pi \leq |\operatorname{ph} z| < \frac{1}{4}\pi$ .

For other phase ranges use (7.4.7) and (7.4.8). For exponentially-improved expansions use (7.5.7), (7.5.10), and §7.12(i).

**7.12(iii) Goodwin–Staton Integral**

See Olver (1997b, p. 115) for an expansion of  $G(z)$  with bounds for the remainder for real and complex values of  $z$ .

### 7.13 Zeros

#### 7.13(i) Zeros of erf $z$

erf  $z$  has a simple zero at  $z = 0$ , and in the first quadrant of  $\mathbb{C}$  there is an infinite set of zeros  $z_n = x_n + iy_n$ ,  $n = 1, 2, 3, \dots$ , arranged in order of increasing absolute value. The other zeros of erf  $z$  are  $-z_n, \bar{z}_n, -\bar{z}_n$ .

Table 7.13.1 gives 10D values of the first five  $x_n$  and  $y_n$ . For graphical illustration see Figure 7.3.5.

Table 7.13.1: Zeros  $x_n + iy_n$  of erf  $z$ .

$n$	$x_n$	$y_n$
1	1.45061 61632	1.88094 30002
2	2.24465 92738	2.61657 51407
3	2.83974 10469	3.17562 80996
4	3.33546 07354	3.64617 43764
5	3.76900 55670	4.06069 72339

As  $n \rightarrow \infty$

$$7.13.1 \quad \begin{aligned} x_n &\sim \lambda - \frac{1}{4}\mu\lambda^{-1} + \frac{1}{16}(1 - \mu + \frac{1}{2}\mu^2)\lambda^{-3} - \dots, \\ y_n &\sim \lambda + \frac{1}{4}\mu\lambda^{-1} + \frac{1}{16}(1 - \mu + \frac{1}{2}\mu^2)\lambda^{-3} + \dots, \end{aligned}$$

where

$$7.13.2 \quad \lambda = \sqrt{(n - \frac{1}{8})\pi}, \quad \mu = \ln(\lambda\sqrt{2\pi}).$$

#### 7.13(ii) Zeros of erfc $z$

In the second quadrant of  $\mathbb{C}$ , erfc  $z$  has an infinite set of zeros  $z_n = x_n + iy_n$ ,  $n = 1, 2, 3, \dots$ , arranged in order of increasing absolute value. The other zeros of erfc  $z$  are  $\bar{z}_n$ . The zeros of  $w(z)$  are  $iz_n$  and  $i\bar{z}_n$ .

Table 7.13.2 gives 10D values of the first five  $x_n$  and  $y_n$ . For graphical illustration see Figure 7.3.6.

Table 7.13.2: Zeros  $x_n + iy_n$  of erfc  $z$ .

$n$	$x_n$	$y_n$
1	-1.35481 01281	1.99146 68428
2	-2.17704 49061	2.69114 90243
3	-2.78438 76132	3.23533 08684
4	-3.28741 07894	3.69730 97025
5	-3.72594 87194	4.10610 72847

As  $n \rightarrow \infty$

$$7.13.3 \quad \begin{aligned} x_n &\sim -\lambda + \frac{1}{4}\mu\lambda^{-1} - \frac{1}{16}(1 - \mu + \frac{1}{2}\mu^2)\lambda^{-3} + \dots, \\ y_n &\sim \lambda + \frac{1}{4}\mu\lambda^{-1} + \frac{1}{16}(1 - \mu + \frac{1}{2}\mu^2)\lambda^{-3} + \dots, \end{aligned}$$

where

$$7.13.4 \quad \lambda = \sqrt{(n - \frac{1}{8})\pi}, \quad \mu = \ln(2\lambda\sqrt{2\pi}).$$

#### 7.13(iii) Zeros of the Fresnel Integrals

At  $z = 0$ ,  $C(z)$  has a simple zero and  $S(z)$  has a triple zero. In the first quadrant of  $\mathbb{C}$   $C(z)$  has an infinite set of zeros  $z_n = x_n + iy_n$ ,  $n = 1, 2, 3, \dots$ , arranged in order of increasing absolute value. Similarly for  $S(z)$ . Let  $z_n$  be a zero of one of the Fresnel integrals. Then  $-z_n, \bar{z}_n, -\bar{z}_n, iz_n, -iz_n, i\bar{z}_n, -i\bar{z}_n$  are also zeros of the same integral.

Tables 7.13.3 and 7.13.4 give 10D values of the first five  $x_n$  and  $y_n$  of  $C(z)$  and  $S(z)$ , respectively.

Table 7.13.3: Complex zeros  $x_n + iy_n$  of  $C(z)$ .

$n$	$x_n$	$y_n$
1	1.74366 74862	0.30573 50636
2	2.65145 95973	0.25290 39555
3	3.32035 93363	0.22395 34581
4	3.87573 44884	0.20474 74706
5	4.36106 35170	0.19066 97324

As  $n \rightarrow \infty$  the  $x_n$  and  $y_n$  corresponding to the zeros of  $C(z)$  satisfy

$$7.13.5 \quad x_n \sim \lambda + \frac{\alpha(\alpha\pi - 4)}{8\pi\lambda^3} + \dots, \quad y_n \sim \frac{\alpha}{2\lambda} + \dots,$$

with

$$7.13.6 \quad \lambda = \sqrt{4n - 1}, \quad \alpha = (2/\pi) \ln(\pi\lambda).$$

Table 7.13.4: Complex zeros  $x_n + iy_n$  of  $S(z)$ .

$n$	$x_n$	$y_n$
1	2.00925 70118	0.28854 78973
2	2.83347 72325	0.24428 52408
3	3.46753 30835	0.21849 26805
4	4.00257 82433	0.20085 10251
5	4.47418 92952	0.18768 85891

As  $n \rightarrow \infty$  the  $x_n$  and  $y_n$  corresponding to the zeros of  $S(z)$  satisfy (7.13.5) with

$$7.13.7 \quad \lambda = 2\sqrt{n}, \quad \alpha = (2/\pi) \ln(\pi\lambda).$$

#### 7.13(iv) Zeros of $\mathcal{F}(z)$

In consequence of (7.5.5) and (7.5.10), zeros of  $\mathcal{F}(z)$  are related to zeros of erfc  $z$ . Thus if  $z_n$  is a zero of erfc  $z$  (§7.13(ii)), then  $(1 + i)z_n/\sqrt{\pi}$  is a zero of  $\mathcal{F}(z)$ .

For an asymptotic expansion of the zeros of  $\int_0^z \exp(\frac{1}{2}\pi it^2) dt$  ( $= \mathcal{F}(0) - \mathcal{F}(z) = C(z) + iS(z)$ ) see Tuzilín (1971).

## 7.14 Integrals

### 7.14(i) Error Functions

#### Fourier Transform

$$7.14.1 \quad \int_0^{\infty} e^{2iat} \operatorname{erfc}(bt) dt = \frac{1}{a\sqrt{\pi}} F\left(\frac{a}{b}\right) + \frac{i}{2a} \left(1 - e^{-(a/b)^2}\right),$$

$$a \in \mathbb{C}, |\operatorname{ph} b| < \frac{1}{4}\pi.$$

When  $a = 0$  the limit is taken.

#### Laplace Transforms

$$7.14.2 \quad \int_0^{\infty} e^{-at} \operatorname{erf}(bt) dt = \frac{1}{a} e^{a^2/(4b^2)} \operatorname{erfc}\left(\frac{a}{2b}\right),$$

$$\Re a > 0, |\operatorname{ph} b| < \frac{1}{4}\pi,$$

$$7.14.3 \quad \int_0^{\infty} e^{-at} \operatorname{erf} \sqrt{bt} dt = \frac{1}{a} \sqrt{\frac{b}{a+b}}, \quad \Re a > 0, \Re b > 0,$$

$$7.14.4 \quad \int_0^{\infty} e^{(a-b)t} \operatorname{erfc}\left(\sqrt{at} + \sqrt{\frac{c}{t}}\right) dt$$

$$= \frac{e^{-2(\sqrt{ac} + \sqrt{bc})}}{\sqrt{b}(\sqrt{a} + \sqrt{b})}, \quad |\operatorname{ph} a| < \frac{1}{2}\pi, \Re b > 0, \Re c \geq 0.$$

### 7.14(ii) Fresnel Integrals

#### Laplace Transforms

$$7.14.5 \quad \int_0^{\infty} e^{-at} C(t) dt = \frac{1}{a} f\left(\frac{a}{\pi}\right), \quad \Re a > 0,$$

$$7.14.6 \quad \int_0^{\infty} e^{-at} S(t) dt = \frac{1}{a} g\left(\frac{a}{\pi}\right), \quad \Re a > 0,$$

$$7.14.7 \quad \int_0^{\infty} e^{-at} C\left(\sqrt{\frac{2t}{\pi}}\right) dt = \frac{(\sqrt{a^2+1} + a)^{\frac{1}{2}}}{2a\sqrt{a^2+1}}, \quad \Re a > 0,$$

$$7.14.8 \quad \int_0^{\infty} e^{-at} S\left(\sqrt{\frac{2t}{\pi}}\right) dt = \frac{(\sqrt{a^2+1} - a)^{\frac{1}{2}}}{2a\sqrt{a^2+1}}, \quad \Re a > 0.$$

### 7.14(iii) Compendia

For collections of integrals see Apelblat (1983, pp. 131–146), Erdélyi *et al.* (1954a, vol. 1, pp. 40, 96, 176–177), Geller and Ng (1971), Gradshteyn and Ryzhik (2000, §§5.4 and 6.28–6.32), Marichev (1983, pp. 184–189), Ng and Geller (1969), Oberhettinger (1974, pp. 138–139, 142–143), Oberhettinger (1990, pp. 48–52, 155–158), Oberhettinger and Badii (1973, pp. 171–172, 179–181), Prudnikov *et al.* (1986b, vol. 2, pp. 30–36, 93–143), Prudnikov *et al.* (1992a, §§3.7–3.8), and Prudnikov *et al.* (1992b, §§3.7–3.8). In a series of ten papers Hadži (1968, 1969, 1970, 1972, 1973, 1975a,b, 1976a,b, 1978) gives

many integrals containing error functions and Fresnel integrals, also in combination with the hypergeometric function, confluent hypergeometric functions, and generalized hypergeometric functions.

## 7.15 Sums

For sums involving the error function see Hansen (1975, p. 423) and Prudnikov *et al.* (1986b, vol. 2, pp. 650–651).

## 7.16 Generalized Error Functions

Generalizations of the error function and Dawson's integral are  $\int_0^x e^{-t^p} dt$  and  $\int_0^x e^{t^p} dt$ . These functions can be expressed in terms of the incomplete gamma function  $\gamma(a, z)$  (§8.2(i)) by change of integration variable.

## 7.17 Inverse Error Functions

### 7.17(i) Notation

The inverses of the functions  $x = \operatorname{erf} y$ ,  $x = \operatorname{erfc} y$ ,  $y \in \mathbb{R}$ , are denoted by

$$7.17.1 \quad y = \operatorname{inverf} x, \quad y = \operatorname{inverfc} x,$$

respectively.

### 7.17(ii) Power Series

With  $t = \frac{1}{2}\sqrt{\pi}x$ ,

$$7.17.2 \quad \operatorname{inverf} x = t + \frac{1}{3}t^3 + \frac{7}{30}t^5 + \frac{127}{630}t^7 + \cdots, \quad |x| < 1.$$

For 25S values of the first 200 coefficients see Strecok (1968).

### 7.17(iii) Asymptotic Expansion of $\operatorname{inverfc} x$ for Small $x$

As  $x \rightarrow 0$

$$7.17.3 \quad \operatorname{inverfc} x \sim u^{-1/2} + a_2 u^{3/2} + a_3 u^{5/2} + a_4 u^{7/2} + \cdots,$$

where

$$7.17.4 \quad a_2 = \frac{1}{8}v, \quad a_3 = -\frac{1}{32}(v^2 + 6v - 6),$$

$$a_4 = \frac{1}{384}(4v^3 + 27v^2 + 108v - 300),$$

$$7.17.5 \quad u = -2/\ln(\pi x^2 \ln(1/x)),$$

and

$$7.17.6 \quad v = \ln(\ln(1/x)) - 2 + \ln \pi.$$

## 7.18 Repeated Integrals of the Complementary Error Function

### 7.18(i) Definition

$$7.18.1 \quad i^{-1}\operatorname{erfc}(z) = \frac{2}{\sqrt{\pi}}e^{-z^2}, \quad i^0\operatorname{erfc}(z) = \operatorname{erfc} z,$$

and for  $n = 0, 1, 2, \dots$ ,

### 7.18.2

$$i^n\operatorname{erfc}(z) = \int_z^\infty i^{n-1}\operatorname{erfc}(t) dt = \frac{2}{\sqrt{\pi}} \int_z^\infty \frac{(t-z)^n}{n!} e^{-t^2} dt.$$

### 7.18(ii) Graphics

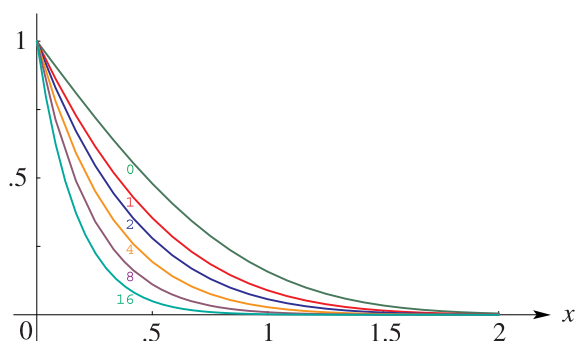


Figure 7.18.1: Repeated integrals of the scaled complementary error function  $2^n \Gamma(\frac{1}{2}n + 1) i^n \operatorname{erfc}(x)$ ,  $n = 0, 1, 2, 4, 8, 16$ .

### 7.18(iii) Properties

$$7.18.3 \quad \frac{d}{dz} i^n \operatorname{erfc}(z) = -i^{n-1} \operatorname{erfc}(z), \quad n = 0, 1, 2, \dots,$$

$$7.18.4 \quad \frac{d^n}{dz^n} (e^{z^2} \operatorname{erfc} z) = (-1)^n 2^n n! e^{z^2} i^n \operatorname{erfc}(z), \quad n = 0, 1, 2, \dots$$

$$7.18.5 \quad \frac{d^2 W}{dz^2} + 2z \frac{dW}{dz} - 2nW = 0, \quad W(z) = A i^n \operatorname{erfc}(z) + B i^n \operatorname{erfc}(-z),$$

where  $n = 1, 2, 3, \dots$ , and  $A, B$  are arbitrary constants.

$$7.18.6 \quad i^n \operatorname{erfc}(z) = \sum_{k=0}^{\infty} \frac{(-1)^k z^k}{2^{n-k} k! \Gamma(1 + \frac{1}{2}(n-k))}.$$

$$7.18.7 \quad i^n \operatorname{erfc}(z) = -\frac{z}{n} i^{n-1} \operatorname{erfc}(z) + \frac{1}{2n} i^{n-2} \operatorname{erfc}(z), \quad n = 1, 2, 3, \dots$$

### 7.18(iv) Relations to Other Functions

For the notation see §§18.3, 13.2(i), and 12.2.

### Hermite Polynomials

$$7.18.8 \quad (-1)^n i^n \operatorname{erfc}(z) + i^n \operatorname{erfc}(-z) = \frac{i^{-n}}{2^{n-1} n!} H_n(iz).$$

### Confluent Hypergeometric Functions

### 7.18.9

$$i^n \operatorname{erfc}(z) = e^{-z^2} \left( \frac{1}{2^n \Gamma(\frac{1}{2}n + 1)} M(\frac{1}{2}n + \frac{1}{2}, \frac{1}{2}, z^2) - \frac{z}{2^{n-1} \Gamma(\frac{1}{2}n + \frac{1}{2})} M(\frac{1}{2}n + 1, \frac{3}{2}, z^2) \right),$$

$$7.18.10 \quad i^n \operatorname{erfc}(z) = \frac{e^{-z^2}}{2^n \sqrt{\pi}} U(\frac{1}{2}n + \frac{1}{2}, \frac{1}{2}, z^2).$$

### Parabolic Cylinder Functions

$$7.18.11 \quad i^n \operatorname{erfc}(z) = \frac{e^{-z^2/2}}{\sqrt{2^{n-1} \pi}} U\left(n + \frac{1}{2}, z\sqrt{2}\right).$$

### Probability Functions

$$7.18.12 \quad i^n \operatorname{erfc}(z) = \frac{1}{\sqrt{2^{n-1} \pi}} Hh_n(\sqrt{2}z).$$

See Jeffreys and Jeffreys (1956, §§23.081–23.09).

### 7.18(v) Continued Fraction

### 7.18.13

$$\frac{i^n \operatorname{erfc}(z)}{i^{n-1} \operatorname{erfc}(z)} = \frac{1/2}{z +} \frac{(n+1)/2}{z +} \frac{(n+2)/2}{z +} \dots, \quad \Re z > 0.$$

See also Cuyt *et al.* (2008, p. 269).

### 7.18(vi) Asymptotic Expansion

$$7.18.14 \quad i^n \operatorname{erfc}(z) \sim \frac{2}{\sqrt{\pi}} \frac{e^{-z^2}}{(2z)^{n+1}} \sum_{m=0}^{\infty} \frac{(-1)^m (2m+n)!}{n! m! (2z)^{2m}}, \quad z \rightarrow \infty, \quad |\operatorname{ph} z| \leq \frac{3}{4}\pi - \delta (< \frac{3}{4}\pi).$$

## 7.19 Voigt Functions

### 7.19(i) Definitions

For  $x \in \mathbb{R}$  and  $t > 0$ ,

$$7.19.1 \quad \mathbf{U}(x, t) = \frac{1}{\sqrt{4\pi t}} \int_{-\infty}^{\infty} \frac{e^{-(x-y)^2/(4t)}}{1+y^2} dy,$$

$$7.19.2 \quad \mathbf{V}(x, t) = \frac{1}{\sqrt{4\pi t}} \int_{-\infty}^{\infty} \frac{y e^{-(x-y)^2/(4t)}}{1+y^2} dy.$$

### 7.19.3

$$\mathbf{U}(x, t) + i \mathbf{V}(x, t) = \sqrt{\frac{\pi}{4t}} e^{z^2} \operatorname{erfc} z, \quad z = (1-ix)/(2\sqrt{t}).$$

### 7.19.4

$$H(a, u) = \frac{a}{\pi} \int_{-\infty}^{\infty} \frac{e^{-t^2} dt}{(u-t)^2 + a^2} = \frac{1}{a\sqrt{\pi}} \mathbf{U}\left(\frac{u}{a}, \frac{1}{4a^2}\right).$$

$H(a, u)$  is sometimes called the *line broadening function*; see, for example, Finn and Muggleston (1965).



**7.19(ii) Graphics**

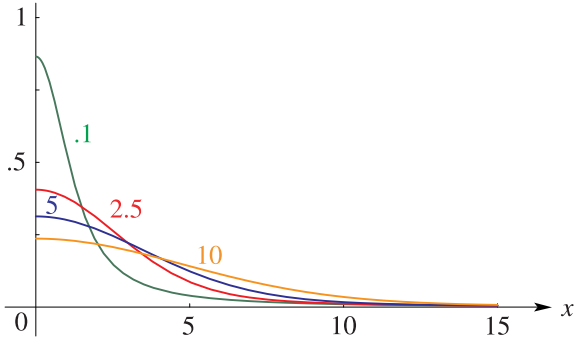


Figure 7.19.1: Voigt function  $U(x, t)$ ,  $t = 0.1, 2.5, 5, 10$ .

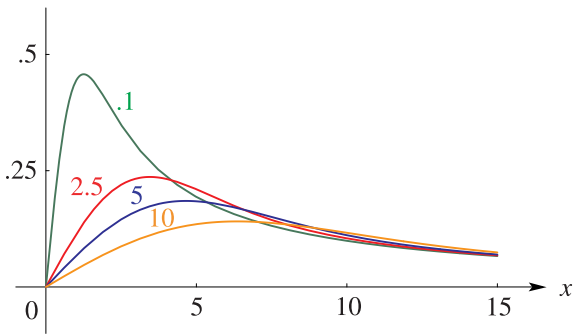


Figure 7.19.2: Voigt function  $V(x, t)$ ,  $t = 0.1, 2.5, 5, 10$ .

**7.19(iii) Properties**

7.19.5  $\lim_{t \rightarrow 0} U(x, t) = \frac{1}{1+x^2}, \quad \lim_{t \rightarrow 0} V(x, t) = \frac{x}{1+x^2}.$

7.19.6  $U(-x, t) = U(x, t), \quad V(-x, t) = -V(x, t).$

7.19.7  $0 < U(x, t) \leq 1, \quad -1 \leq V(x, t) \leq 1.$

7.19.8  $V(x, t) = xU(x, t) + 2t \frac{\partial U(x, t)}{\partial x},$

7.19.9  $U(x, t) = 1 - xV(x, t) - 2t \frac{\partial V(x, t)}{\partial x}.$

**7.19(iv) Other Integral Representations**

7.19.10  $U\left(\frac{u}{a}, \frac{1}{4a^2}\right) = a \int_0^\infty e^{-at - \frac{1}{4}t^2} \cos(ut) dt,$

7.19.11  $V\left(\frac{u}{a}, \frac{1}{4a^2}\right) = a \int_0^\infty e^{-at - \frac{1}{4}t^2} \sin(ut) dt.$

**Applications**

**7.20 Mathematical Applications**

**7.20(i) Asymptotics**

For applications of the complementary error function in uniform asymptotic approximations of integrals—saddle point coalescing with a pole or saddle point coalescing with an endpoint—see Wong (1989, Chapter 7), Olver (1997b, Chapter 9), and van der Waerden (1951).

The complementary error function also plays a ubiquitous role in constructing exponentially-improved asymptotic expansions and providing a smooth interpretation of the Stokes phenomenon; see §§2.11(iii) and 2.11(iv).

**7.20(ii) Cornu's Spiral**

Let the set  $\{x(t), y(t), t\}$  be defined by  $x(t) = C(t)$ ,  $y(t) = S(t)$ ,  $t \geq 0$ . Then the set  $\{x(t), y(t)\}$  is called *Cornu's spiral*: it is the projection of the corkscrew on the  $\{x, y\}$ -plane. See Figure 7.20.1. The spiral has several special properties (see Temme (1996a, p. 184)). Let  $P(t) = P(x(t), y(t))$  be any point on the projected spiral. Then the arc length between the origin and  $P(t)$  equals  $t$ , and is directly proportional to the curvature at  $P(t)$ , which equals  $\pi t$ . Furthermore, because  $dy/dx = \tan(\frac{1}{2}\pi t^2)$ , the angle between the  $x$ -axis and the tangent to the spiral at  $P(t)$  is given by  $\frac{1}{2}\pi t^2$ .

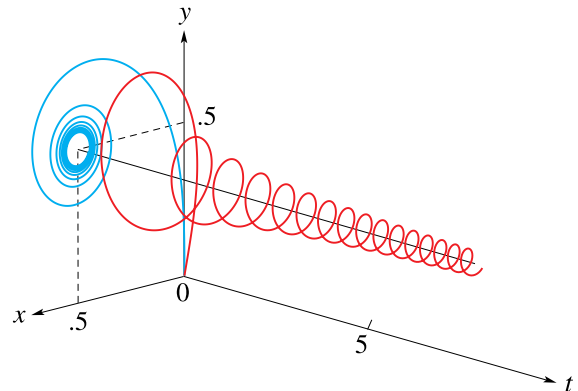


Figure 7.20.1: Cornu's spiral, formed from Fresnel integrals, is defined parametrically by  $x = C(t)$ ,  $y = S(t)$ ,  $t \in [0, \infty)$ .

### 7.20(iii) Statistics

The normal distribution function with mean  $m$  and standard deviation  $\sigma$  is given by

#### 7.20.1

$$\frac{1}{\sigma\sqrt{2\pi}} \int_{-\infty}^x e^{-(t-m)^2/(2\sigma^2)} dt = \frac{1}{2} \operatorname{erfc}\left(\frac{m-x}{\sigma\sqrt{2}}\right) = Q\left(\frac{m-x}{\sigma}\right) = P\left(\frac{x-m}{\sigma}\right).$$

For applications in statistics and probability theory, also for the role of the normal distribution functions (the error functions and probability integrals) in the asymptotics of arbitrary probability density functions, see Johnson *et al.* (1994, Chapter 13) and Patel and Read (1982, Chapters 2 and 3).

## 7.21 Physical Applications

The error functions, Fresnel integrals, and related functions occur in a variety of physical applications. Fresnel integrals and Cornu's spiral occurred originally in the analysis of the diffraction of light; see Born and Wolf (1999, §8.7). More recently, Cornu's spiral appears in the design of highways and railroad tracks, robot trajectory planning, and computer-aided design; see Meek and Walton (1992).

Carslaw and Jaeger (1959) gives many applications and points out the importance of the repeated integrals of the complementary error function  $i^n \operatorname{erfc}(z)$ . Fried and Conte (1961) mentions the role of  $w(z)$  in the theory of linearized waves or oscillations in a hot plasma;  $w(z)$  is called the *plasma dispersion function* or *Faddeeva function*; see Faddeeva and Terent'ev (1954). Ng and Geller (1969) cites work with applications from atomic physics and astrophysics.

Voigt functions can be regarded as the convolution of a Gaussian and a Lorentzian, and appear when the analysis of light (or particulate) absorption (or emission) involves thermal motion effects. These applications include astrophysics, plasma diagnostics, neutron diffraction, laser spectroscopy, and surface scattering. See Mitchell and Zemansky (1961, §IV.2), Armstrong (1967), and Ahn *et al.* (2001). Dawson's integral appears in de-convolving even more complex motional effects; see Pratt (2007).

## Computation

### 7.22 Methods of Computation

#### 7.22(i) Main Functions

The methods available for computing the main functions in this chapter are analogous to those described in

§§6.18(i)–6.18(iv) for the exponential integral and sine and cosine integrals, and similar comments apply. Additional references are Matta and Reichel (1971) for the application of the trapezoidal rule, for example, to the first of (7.7.2), and Gautschi (1970) and Cuyt *et al.* (2008) for continued fractions.

#### 7.22(ii) Goodwin–Staton Integral

See Goodwin and Staton (1948).

#### 7.22(iii) Repeated Integrals of the Complementary Error Function

The recursion scheme given by (7.18.1) and (7.18.7) can be used for computing  $i^n \operatorname{erfc}(x)$ . See Gautschi (1977a), where forward and backward recursions are used; see also Gautschi (1961).

#### 7.22(iv) Voigt Functions

The computation of these functions can be based on algorithms for the complementary error function with complex argument; compare (7.19.3).

#### 7.22(v) Other References

For a comprehensive survey of computational methods for the functions treated in this chapter, see van der Laan and Temme (1984, Ch. V).

## 7.23 Tables

### 7.23(i) Introduction

Lebedev and Fedorova (1960) and Fletcher *et al.* (1962) give comprehensive indexes of mathematical tables. This section lists relevant tables that appeared later.

#### 7.23(ii) Real Variables

- Abramowitz and Stegun (1964, Chapter 7) includes  $\operatorname{erf} x$ ,  $(2/\sqrt{\pi})e^{-x^2}$ ,  $x \in [0, 2]$ , 10D;  $(2/\sqrt{\pi})e^{-x^2}$ ,  $x \in [2, 10]$ , 8S;  $xe^{x^2} \operatorname{erfc} x$ ,  $x^{-2} \in [0, 0.25]$ , 7D;  $2^n \Gamma(\frac{1}{2}n + 1) i^n \operatorname{erfc}(x)$ ,  $n = 1(1)6, 10, 11$ ,  $x \in [0, 5]$ , 6S;  $F(x)$ ,  $x \in [0, 2]$ , 10D;  $x F(x)$ ,  $x^{-2} \in [0, 0.25]$ , 9D;  $C(x)$ ,  $S(x)$ ,  $x \in [0, 5]$ , 7D;  $f(x)$ ,  $g(x)$ ,  $x \in [0, 1]$ ,  $x^{-1} \in [0, 1]$ , 15D.
- Abramowitz and Stegun (1964, Table 27.6) includes the Goodwin–Staton integral  $G(x)$ ,  $x = 1(.1)3(.5)8$ , 4D; also  $G(x) + \ln x$ ,  $x = 0(.05)1$ , 4D.
- Finn and Mugglestone (1965) includes the Voigt function  $H(a, u)$ ,  $u \in [0, 22]$ ,  $a \in [0, 1]$ , 6S.
- Zhang and Jin (1996, pp. 637, 639) includes  $(2/\sqrt{\pi})e^{-x^2}$ ,  $\operatorname{erf} x$ ,  $x = 0(.02)1(.04)3$ , 8D;  $C(x)$ ,  $S(x)$ ,  $x = 0(.2)10(2)100(100)500$ , 8D.

### 7.23(iii) Complex Variables, $z = x + iy$

- Abramowitz and Stegun (1964, Chapter 7) includes  $w(z)$ ,  $x = 0(.1)3.9$ ,  $y = 0(.1)3$ , 6D.
- Zhang and Jin (1996, pp. 638, 640–641) includes the real and imaginary parts of  $\operatorname{erf} z$ ,  $x \in [0, 5]$ ,  $y = 0.5(.5)3$ , 7D and 8D, respectively; the real and imaginary parts of  $\int_x^\infty e^{\pm it^2} dt$ ,  $(1/\sqrt{\pi})e^{\mp i(x^2 + (\pi/4))} \int_x^\infty e^{\pm it^2} dt$ ,  $x = 0(.5)20(1)25$ , 8D, together with the corresponding modulus and phase to 8D and 6D (degrees), respectively.

### 7.23(iv) Zeros

- Fettis *et al.* (1973) gives the first 100 zeros of  $\operatorname{erf} z$  and  $w(z)$  (the table on page 406 of this reference is for  $w(z)$ , not for  $\operatorname{erfc} z$ ), 11S.
- Zhang and Jin (1996, p. 642) includes the first 10 zeros of  $\operatorname{erf} z$ , 9D; the first 25 distinct zeros of  $C(z)$  and  $S(z)$ , 8S.

## 7.24 Approximations

### 7.24(i) Approximations in Terms of Elementary Functions

- Hastings (1955) gives several minimax polynomial and rational approximations for  $\operatorname{erf} x$ ,  $\operatorname{erfc} x$  and the auxiliary functions  $f(x)$  and  $g(x)$ .
- Cody (1969) provides minimax rational approximations for  $\operatorname{erf} x$  and  $\operatorname{erfc} x$ . The maximum relative precision is about 20S.
- Cody (1968) gives minimax rational approximations for the Fresnel integrals (maximum relative precision 19S); for a Fortran algorithm and comments see Snyder (1993).
- Cody *et al.* (1970) gives minimax rational approximations to Dawson's integral  $F(x)$  (maximum relative precision 20S–22S).

### 7.24(ii) Expansions in Chebyshev Series

- Luke (1969b, pp. 323–324) covers  $\frac{1}{2}\sqrt{\pi} \operatorname{erf} x$  and  $e^{x^2} F(x)$  for  $-3 \leq x \leq 3$  (the Chebyshev coefficients are given to 20D);  $\sqrt{\pi} x e^{x^2} \operatorname{erfc} x$  and  $2x F(x)$  for  $x \geq 3$  (the Chebyshev coefficients are given to 20D and 15D, respectively). Coefficients for the Fresnel integrals are given on pp. 328–330 (20D).

- Bulirsch (1967) provides Chebyshev coefficients for the auxiliary functions  $f(x)$  and  $g(x)$  for  $x \geq 3$  (15D).
- Schonfelder (1978) gives coefficients of Chebyshev expansions for  $x^{-1} \operatorname{erf} x$  on  $0 \leq x \leq 2$ , for  $x e^{x^2} \operatorname{erfc} x$  on  $[2, \infty)$ , and for  $e^{x^2} \operatorname{erfc} x$  on  $[0, \infty)$  (30D).
- Shepherd and Laframboise (1981) gives coefficients of Chebyshev series for  $(1 + 2x)e^{x^2} \operatorname{erfc} x$  on  $(0, \infty)$  (22D).

### 7.24(iii) Padé-Type Expansions

- Luke (1969b, vol. 2, pp. 422–435) gives main diagonal Padé approximations for  $F(z)$ ,  $\operatorname{erf} z$ ,  $\operatorname{erfc} z$ ,  $C(z)$ , and  $S(z)$ ; approximate errors are given for a selection of  $z$ -values.

## 7.25 Software

See <http://dlmf.nist.gov/7.25>.

## References

### General References

For general bibliographic reading see Carslaw and Jaeger (1959), Lebedev (1965), Olver (1997b), and Temme (1996a).

### Sources

The following list gives the references or other indications of proofs that were used in constructing the various sections of this chapter. These sources supplement the references that are quoted in the text.

- §7.2 Olver (1997b, pp. 43–44) and Temme (1996a, pp. 180, 182–183, 275–276).
- §7.3 These graphics were produced at NIST.
- §7.4 (7.4.7) follows from (7.2.10), (7.2.11), and (7.4.6). (7.4.8) follows from (7.4.7).
- §7.5 (7.5.1) follows from (7.2.1)–(7.2.3). (7.5.2) follows from (7.2.6)–(7.2.9). (7.5.3) and (7.5.4) follow from (7.2.10) and (7.2.11). (7.5.5) and (7.5.6) follow from (7.2.10), (7.2.11), and (7.5.2). (7.5.8) follows from (7.2.1), (7.2.7), and (7.2.8). (7.5.9) follows from (7.2.2), (7.2.3), (7.5.7), and (7.5.8). (7.5.10) follows from (7.2.2), (7.5.6), and (7.5.8). (7.5.11) follows from (7.5.5). (7.5.12) follows from (7.4.8) and (7.5.11). For (7.5.13) see Olver (1997b, p. 44).

- §7.6** For (7.6.1)–(7.6.3) see van der Laan and Temme (1984, pp. 185–186). (7.6.4) and (7.6.6) follow from (7.2.7) and (7.2.8). (7.6.5) and (7.6.7) follow from (7.5.8) and (7.6.2). For (7.6.8) differentiate: use (7.2.1) for the left-hand side, and (10.47.7) and the second of (10.29.1) for the right-hand side. The same method can be used for (7.6.10) and (7.6.11). For (7.6.9) write the coefficients in the Chebyshev-series expansion of  $\exp(a^2 z^2) \operatorname{erf}(az)$  as integrals (§3.11(ii)), then apply (5.12.5), (7.6.2), and (13.6.9).
- §7.7** (7.7.1), (7.7.2), and (7.7.4) are given in van der Laan and Temme (1984, pp. 185–186). (7.7.3) follows from integrating from 0 to  $iz/a$  and from  $iz/a$  to  $\infty$ . (7.7.5) follows by differentiating with respect to  $a$  (after multiplying the equation by  $e^{-a}$ ). (7.7.6), (7.7.7), and (7.7.9) follow by differentiating with respect to  $x$ . For (7.7.8) let  $x \rightarrow 0+$  in (7.7.7) and use (7.2.2), (7.2.4). For (7.7.10) and (7.7.11) see van der Laan and Temme (1984, Chapter V). (7.7.12) follows from (7.5.5) and (7.2.6). (7.7.13) and (7.7.14) follow by taking Mellin transforms (§1.14(iv)), and applying (7.7.10), (7.7.11), (5.12.1).
- §7.8** See Mills (1926), Mitrinović (1970, p. 177), and Gautschi (1959b) for (7.8.2); Kesavan and Vasudevamurthy (1985) for the lower bound in (7.8.3); Laforgia and Sismondi (1988) for the upper bound in (7.8.3); Gupta (1970) for (7.8.4); Luke (1969b, p. 201) for (7.8.5); Martić (1978) for (7.8.6); Crstici and Tudor (1975) for (7.8.7). See also Wu (1982).
- §7.9** Nielsen (1906a, p. 217) and Lorentzen and Waadeland (1992, pp. 576–577). (7.9.2) is the even part of (7.9.1) (compare §1.12(iv)).
- §7.10** These results may be verified by differentiation of the definitions given in §7.2.
- §7.11** These results may be verified by comparing the power-series expansions of both sides of each equation. For (7.11.5) use (7.7.1) and (13.4.4).
- §7.12** (7.12.2) and (7.12.3) follow from (7.7.10) and (7.7.11) by applying Watson’s lemma in its extended form (§2.4(i)). (7.12.4)–(7.12.7) follow from (7.7.10), (7.7.11), and the identity  $(t^2 + 1)^{-1} = \sum_{m=0}^{n-1} (-1)^m t^{2m} + (-1)^n t^{2n} (t^2 + 1)^{-1}$ . The error bounds are obtained by setting  $t = \sqrt{\tau}$  in (7.12.6) and (7.12.7), rotating the integration path in the  $\tau$ -plane through an angle  $-4 \operatorname{ph} z$ , and then replacing  $|\tau + 1|$  by its minimum value on the path.
- §7.13** Fettis *et al.* (1973), Fettis and Caslin (1973), and Kreyszig (1957).
- §7.14** For (7.14.1) and (7.14.2) integrate by parts and apply (7.7.3), (7.7.6). (7.14.3) follows from (7.14.4) with  $c = 0$ . For (7.14.4) integrate by parts and apply (10.32.10), (10.39.2). For (7.14.5) and (7.14.6) integrate by parts, and use (7.7.15) and (7.7.16). For (7.14.7) and (7.14.8) consider the integrals  $\int_0^\infty e^{-at} \left( C\left(\sqrt{2t/\pi}\right) \pm i S\left(\sqrt{2t/\pi}\right) \right) dt$  and integrate by parts. The results are  $1 / \left( a\sqrt{2(a \mp i)} \right)$ , from which (7.14.7) and (7.14.8) follow.
- §7.17** For (7.17.2) see Carlitz (1963). (7.17.3) follows from Blair *et al.* (1976) after modifications.
- §7.18** Hartree (1936) and Lorentzen and Waadeland (1992, p. 577). The graphs were produced at NIST.
- §7.19** (7.19.3) follows from (7.2.3) and (7.7.2). (7.19.5) follows from the definitions (7.19.1), (7.19.2), together with (1.17.6) or §2.3(iii). For the first of (7.19.7) use (7.19.1) for the lower bound, and (7.19.10) for the upper bound. For the second of (7.19.7) use (7.19.11). For (7.19.8) and (7.19.9) again use the definitions (7.19.1) and (7.19.2). For (7.19.10) and (7.19.11) see Armstrong (1967). The graphs were produced at NIST.
- §7.20** The diagram was produced by the author.



## Chapter 8

# Incomplete Gamma and Related Functions

R. B. Paris<sup>1</sup>

<b>Notation</b>	<b>174</b>	<b>Related Functions</b>	<b>183</b>
8.1 Special Notation . . . . .	174	8.17 Incomplete Beta Functions . . . . .	183
<b>Incomplete Gamma Functions</b>	<b>174</b>	8.18 Asymptotic Expansions of $I_x(a, b)$ . . . . .	184
8.2 Definitions and Basic Properties . . . . .	174	8.19 Generalized Exponential Integral . . . . .	185
8.3 Graphics . . . . .	175	8.20 Asymptotic Expansions of $E_p(z)$ . . . . .	187
8.4 Special Values . . . . .	176	8.21 Generalized Sine and Cosine Integrals . . . . .	188
8.5 Confluent Hypergeometric Representations	177	<b>Applications</b>	<b>189</b>
8.6 Integral Representations . . . . .	177	8.22 Mathematical Applications . . . . .	189
8.7 Series Expansions . . . . .	178	8.23 Statistical Applications . . . . .	189
8.8 Recurrence Relations and Derivatives . . . . .	178	8.24 Physical Applications . . . . .	189
8.9 Continued Fractions . . . . .	179	<b>Computation</b>	<b>190</b>
8.10 Inequalities . . . . .	179	8.25 Methods of Computation . . . . .	190
8.11 Asymptotic Approximations and Expansions	179	8.26 Tables . . . . .	190
8.12 Uniform Asymptotic Expansions for Large Parameter . . . . .	181	8.27 Approximations . . . . .	191
8.13 Zeros . . . . .	182	8.28 Software . . . . .	191
8.14 Integrals . . . . .	182	<b>References</b>	<b>191</b>
8.15 Sums . . . . .	183		
8.16 Generalizations . . . . .	183		

<sup>1</sup>Division of Mathematical Sciences, University of Abertay Dundee, Dundee, United Kingdom.

**Acknowledgments:** This chapter is based in part on Abramowitz and Stegun (1964, Chapters 5 and 6), by W. Gautschi and F. Cahill, and P. J. Davis, respectively.

**Copyright** © 2009 National Institute of Standards and Technology. All rights reserved.

## Notation

### 8.1 Special Notation

(For other notation see pp. xiv and 873.)

- $x$  real variable.
- $z$  complex variable.
- $a, p$  real or complex parameters.
- $k, n$  nonnegative integers.
- $\delta$  arbitrary small positive constant.
- $\Gamma(z)$  gamma function (§5.2(i)).
- $\psi(z)$   $\Gamma'(z)/\Gamma(z)$ .

Unless otherwise indicated, primes denote derivatives with respect to the argument.

The functions treated in this chapter are the incomplete gamma functions  $\gamma(a, z)$ ,  $\Gamma(a, z)$ ,  $\gamma^*(a, z)$ ,  $P(a, z)$ , and  $Q(a, z)$ ; the incomplete beta functions  $B_x(a, b)$  and  $I_x(a, b)$ ; the generalized exponential integral  $E_p(z)$ ; the generalized sine and cosine integrals  $\text{si}(a, z)$ ,  $\text{ci}(a, z)$ ,  $\text{Si}(a, z)$ , and  $\text{Ci}(a, z)$ .

Alternative notations include: *Prym's functions*  $P_z(a) = \gamma(a, z)$ ,  $Q_z(a) = \Gamma(a, z)$ , Nielsen (1906a, pp. 25–26), Batchelder (1967, p. 63);  $(a, z)! = \gamma(a + 1, z)$ ,  $[a, z]! = \Gamma(a + 1, z)$ , Dingle (1973);  $B(a, b, x) = B_x(a, b)$ ,  $I(a, b, x) = I_x(a, b)$ , Magnus *et al.* (1966);  $\text{Si}(a, x) \rightarrow \text{Si}(1 - a, x)$ ,  $\text{Ci}(a, x) \rightarrow \text{Ci}(1 - a, x)$ , Luke (1975).

## Incomplete Gamma Functions

### 8.2 Definitions and Basic Properties

#### 8.2(i) Definitions

The *general values* of the *incomplete gamma functions*  $\gamma(a, z)$  and  $\Gamma(a, z)$  are defined by

$$8.2.1 \quad \gamma(a, z) = \int_0^z t^{a-1} e^{-t} dt, \quad \Re a > 0,$$

$$8.2.2 \quad \Gamma(a, z) = \int_z^\infty t^{a-1} e^{-t} dt,$$

without restrictions on the integration paths. However, when the integration paths do not cross the negative real axis, and in the case of (8.2.2) exclude the origin,  $\gamma(a, z)$  and  $\Gamma(a, z)$  take their *principal values*; compare

§4.2(i). *Except where indicated otherwise* in this Handbook these principal values are assumed. For example,

$$8.2.3 \quad \gamma(a, z) + \Gamma(a, z) = \Gamma(a), \quad a \neq 0, -1, -2, \dots$$

Normalized functions are:

$$8.2.4 \quad P(a, z) = \frac{\gamma(a, z)}{\Gamma(a)}, \quad Q(a, z) = \frac{\Gamma(a, z)}{\Gamma(a)},$$

$$8.2.5 \quad P(a, z) + Q(a, z) = 1.$$

In addition,

$$8.2.6 \quad \gamma^*(a, z) = z^{-a} P(a, z) = \frac{z^{-a}}{\Gamma(a)} \gamma(a, z).$$

$$8.2.7 \quad \gamma^*(a, z) = \frac{1}{\Gamma(a)} \int_0^1 t^{a-1} e^{-zt} dt, \quad \Re a > 0.$$

#### 8.2(ii) Analytic Continuation

In this subsection the functions  $\gamma$  and  $\Gamma$  have their general values.

The function  $\gamma^*(a, z)$  is entire in  $z$  and  $a$ . When  $z \neq 0$ ,  $\Gamma(a, z)$  is an entire function of  $a$ , and  $\gamma(a, z)$  is meromorphic with simple poles at  $a = -n$ ,  $n = 0, 1, 2, \dots$ , with residue  $(-1)^n/n!$ .

For  $m \in \mathbb{Z}$ ,

$$8.2.8 \quad \gamma(a, ze^{2\pi mi}) = e^{2\pi mia} \gamma(a, z), \quad a \neq 0, -1, -2, \dots,$$

$$8.2.9 \quad \Gamma(a, ze^{2\pi mi}) = e^{2\pi mia} \Gamma(a, z) + (1 - e^{2\pi mia}) \Gamma(a).$$

(8.2.9) also holds when  $a$  is zero or a negative integer, provided that the right-hand side is replaced by its limiting value. For example, in the case  $m = -1$  we have

$$8.2.10 \quad e^{-\pi ia} \Gamma(a, ze^{\pi i}) - e^{\pi ia} \Gamma(a, ze^{-\pi i}) = -\frac{2\pi i}{\Gamma(1-a)},$$

without restriction on  $a$ .

Lastly,

$$8.2.11 \quad \Gamma(a, ze^{\pm\pi i}) = \Gamma(a)(1 - z^a e^{\pm\pi ia} \gamma^*(a, -z)).$$

#### 8.2(iii) Differential Equations

If  $w = \gamma(a, z)$  or  $\Gamma(a, z)$ , then

$$8.2.12 \quad \frac{d^2 w}{dz^2} + \left(1 + \frac{1-a}{z}\right) \frac{dw}{dz} = 0.$$

If  $w = e^z z^{1-a} \Gamma(a, z)$ , then

$$8.2.13 \quad \frac{d^2 w}{dz^2} - \left(1 + \frac{1-a}{z}\right) \frac{dw}{dz} + \frac{1-a}{z^2} w = 0.$$

Also,

$$8.2.14 \quad z \frac{d^2 \gamma^*}{dz^2} + (a+1+z) \frac{d\gamma^*}{dz} + a\gamma^* = 0.$$

### 8.3 Graphics

#### 8.3(i) Real Variables

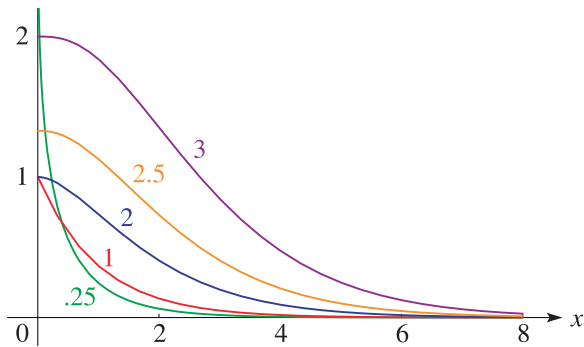


Figure 8.3.1:  $\Gamma(a, x)$ ,  $a = 0.25, 1, 2, 2.5, 3$ .

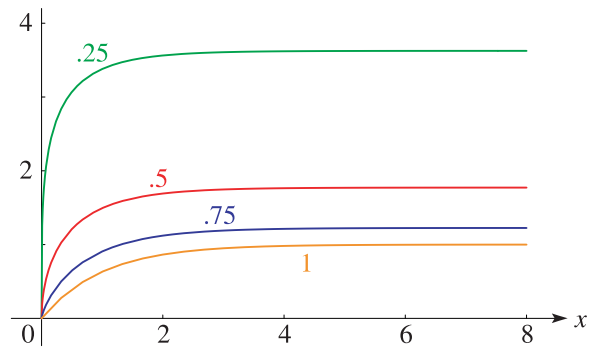


Figure 8.3.2:  $\gamma(a, x)$ ,  $a = 0.25, 0.5, 0.75, 1$ .

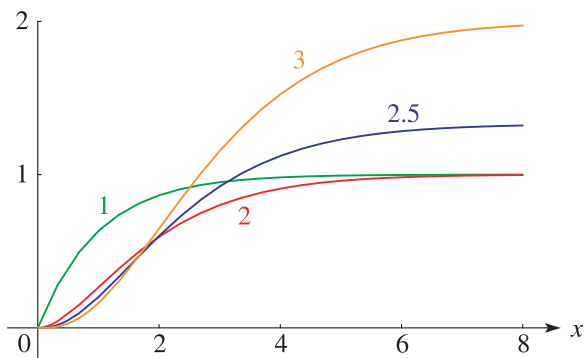


Figure 8.3.3:  $\gamma(a, x)$ ,  $a = 1, 2, 2.5, 3$ .

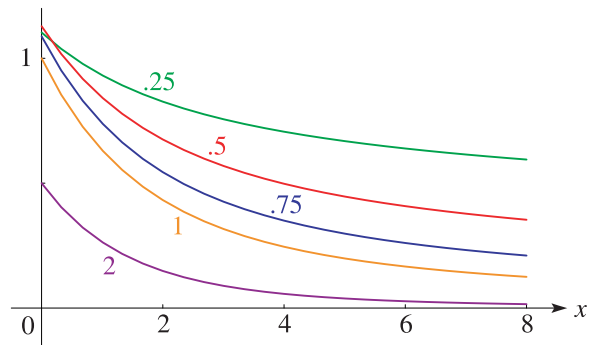


Figure 8.3.4:  $\gamma^*(a, x) (= x^{-a} P(a, x))$ ,  $a = 0.25, 0.5, 0.75, 1, 2$ .

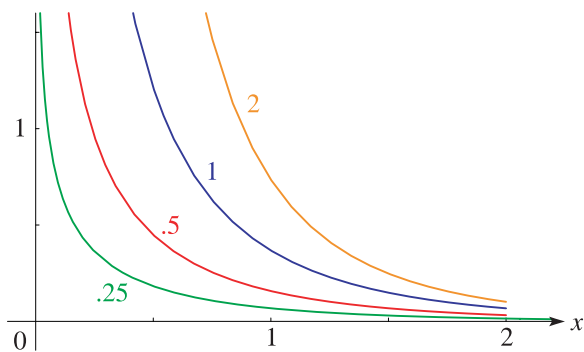


Figure 8.3.5:  $x^{-a} - \gamma^*(a, x) (= x^{-a} Q(a, x))$ ,  $a = 0.25, 0.5, 1, 2$ .

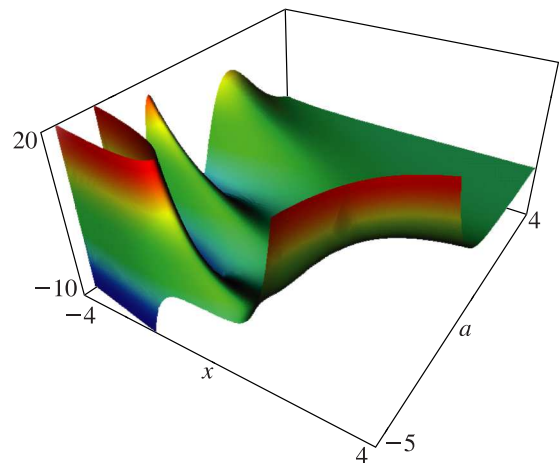


Figure 8.3.6:  $\gamma^*(a, x) (= x^{-a} P(a, x))$ ,  $-4 \leq x \leq 4$ ,  $-5 \leq a \leq 4$ .



Some monotonicity properties of  $\gamma^*(a, x)$  and  $\Gamma(a, x)$  in the four quadrants of the  $(a, x)$ -plane in Figure 8.3.6 are given in Erdélyi *et al.* (1953b, §9.6).

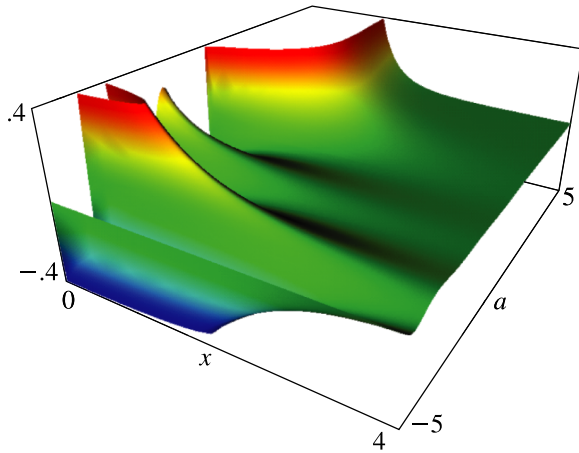


Figure 8.3.7:  $x^{-a} - \gamma^*(a, x)$  ( $= x^{-a} Q(a, x)$ ),  $0 \leq x \leq 4$ ,  $-5 \leq a \leq 5$ .

### 8.3(ii) Complex Argument

In the graphics shown in this subsection, height corresponds to the absolute value of the function and color to the phase. See p. xiv.

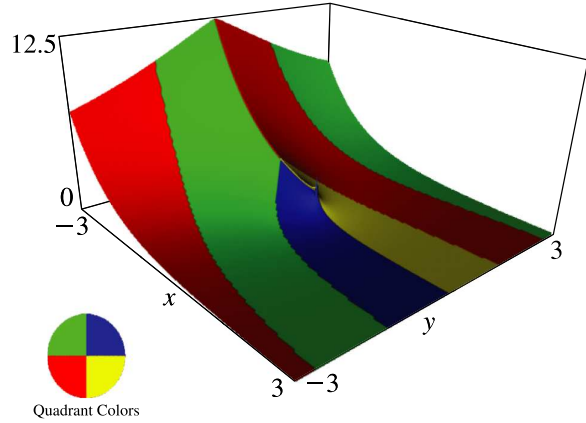


Figure 8.3.8:  $\Gamma(0.25, x + iy)$ ,  $-3 \leq x \leq 3$ ,  $-3 \leq y \leq 3$ . Principal value. There is a cut along the negative real axis. When  $x = y = 0$ ,  $\Gamma(0.25, 0) = \Gamma(0.25) = 3.625 \dots$

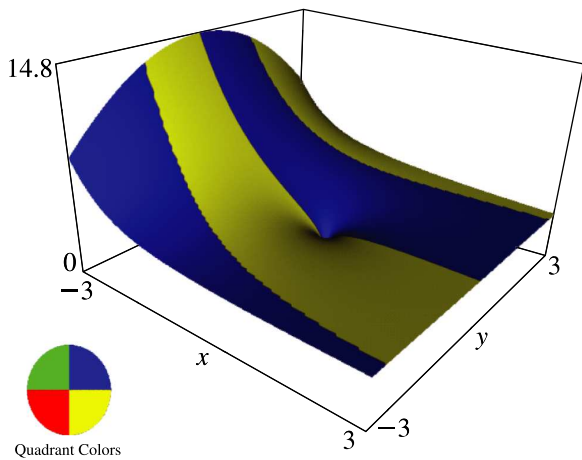


Figure 8.3.9:  $\gamma(0.25, x + iy)$ ,  $-3 \leq x \leq 3$ ,  $-3 \leq y \leq 3$ . Principal value. There is a cut along the negative real axis.

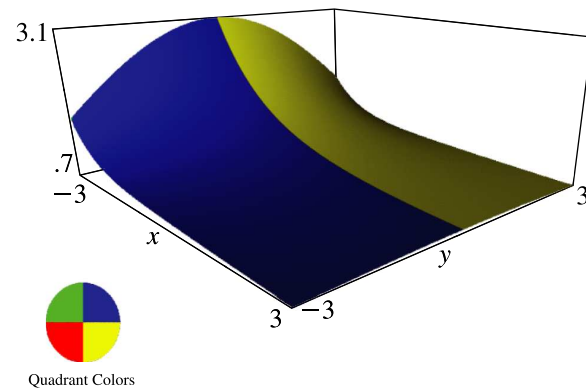


Figure 8.3.10:  $\gamma^*(0.25, x + iy)$ ,  $-3 \leq x \leq 3$ ,  $-3 \leq y \leq 3$ .

For additional graphics see <http://dlmf.nist.gov/8.3.ii>.

### 8.4 Special Values

For  $\operatorname{erf}(z)$ ,  $\operatorname{erfc}(z)$ , and  $F(z)$ , see §§7.2(i), 7.2(ii). For  $E_n(z)$  see §8.19(i).

$$8.4.1 \quad \gamma\left(\frac{1}{2}, z^2\right) = 2 \int_0^z e^{-t^2} dt = \sqrt{\pi} \operatorname{erf}(z),$$

$$8.4.2 \quad \gamma^*(a, 0) = \frac{1}{\Gamma(a+1)},$$

$$8.4.3 \quad \gamma^*\left(\frac{1}{2}, -z^2\right) = \frac{2e^{z^2}}{z\sqrt{\pi}} F(z).$$

$$8.4.4 \quad \Gamma(0, z) = \int_z^\infty t^{-1} e^{-t} dt = E_1(z),$$

$$8.4.5 \quad \Gamma(1, z) = e^{-z},$$

$$8.4.6 \quad \Gamma\left(\frac{1}{2}, z^2\right) = 2 \int_z^\infty e^{-t^2} dt = \sqrt{\pi} \operatorname{erfc}(z).$$

For  $n = 0, 1, 2, \dots$ ,

$$8.4.7 \quad \gamma(n+1, z) = n!(1 - e^{-z}e_n(z)),$$

$$8.4.8 \quad \Gamma(n+1, z) = n!e^{-z}e_n(z),$$

$$8.4.9 \quad P(n+1, z) = 1 - e^{-z}e_n(z),$$

$$8.4.10 \quad Q(n+1, z) = e^{-z}e_n(z),$$

where

$$8.4.11 \quad e_n(z) = \sum_{k=0}^n \frac{z^k}{k!}.$$

Also

$$8.4.12 \quad \gamma^*(-n, z) = z^n,$$

$$8.4.13 \quad \Gamma(1-n, z) = z^{1-n} E_n(z),$$

$$8.4.14 \quad Q\left(n + \frac{1}{2}, z^2\right) = \operatorname{erfc}(z) + \frac{e^{-z^2}}{\sqrt{\pi}} \sum_{k=1}^n \frac{z^{2k-1}}{\left(\frac{1}{2}\right)_k},$$

8.4.15

$$\begin{aligned} \Gamma(-n, z) &= \frac{(-1)^n}{n!} \left( E_1(z) - e^{-z} \sum_{k=0}^{n-1} \frac{(-1)^k k!}{z^{k+1}} \right) \\ &= \frac{(-1)^n}{n!} (\psi(n+1) - \ln z) - z^{-n} \sum_{\substack{k=0 \\ k \neq n}}^{\infty} \frac{(-z)^k}{k!(k-n)}. \end{aligned}$$

## 8.5 Confluent Hypergeometric Representations

For the confluent hypergeometric functions  $M$ ,  $\mathbf{M}$ ,  $U$ , and the Whittaker functions  $M_{\kappa, \mu}$  and  $W_{\kappa, \mu}$ , see §§13.2(i) and 13.14(i).

8.5.1

$$\begin{aligned} \gamma(a, z) &= a^{-1} z^a e^{-z} M(1, 1+a, z) \\ &= a^{-1} z^a M(a, 1+a, -z), \quad a \neq 0, -1, -2, \dots \end{aligned}$$

$$8.5.2 \quad \gamma^*(a, z) = e^{-z} \mathbf{M}(1, 1+a, z) = \mathbf{M}(a, 1+a, -z).$$

8.5.3

$$\Gamma(a, z) = e^{-z} U(1-a, 1-a, z) = z^a e^{-z} U(1, 1+a, z).$$

$$8.5.4 \quad \gamma(a, z) = a^{-1} z^{\frac{1}{2}a - \frac{1}{2}} e^{-\frac{1}{2}z} M_{\frac{1}{2}a - \frac{1}{2}, \frac{1}{2}a}(z).$$

$$8.5.5 \quad \Gamma(a, z) = e^{-\frac{1}{2}z} z^{\frac{1}{2}a - \frac{1}{2}} W_{\frac{1}{2}a - \frac{1}{2}, \frac{1}{2}a}(z).$$

## 8.6 Integral Representations

### 8.6(i) Integrals Along the Real Line

For the Bessel function  $J_\nu(z)$  and modified Bessel function  $K_\nu(z)$ , see §§10.2(ii) and 10.25(ii).

8.6.1

$$\gamma(a, z) = \frac{z^a}{\sin(\pi a)} \int_0^\pi e^{z \cos t} \cos(at + z \sin t) dt, \quad a \notin \mathbb{Z},$$

8.6.2

$$\gamma(a, z) = z^{\frac{1}{2}a} \int_0^\infty e^{-t} t^{\frac{1}{2}a-1} J_a(2\sqrt{zt}) dt, \quad \Re a > 0.$$

8.6.3

$$\gamma(a, z) = z^a \int_0^\infty \exp(-at - ze^{-t}) dt, \quad \Re a > 0.$$

$$8.6.4 \quad \Gamma(a, z) = \frac{z^a e^{-z}}{\Gamma(1-a)} \int_0^\infty \frac{t^{-a} e^{-t}}{z+t} dt,$$

$$|\operatorname{ph} z| < \pi, \quad \Re a < 1,$$

$$8.6.5 \quad \Gamma(a, z) = z^a e^{-z} \int_0^\infty \frac{e^{-zt}}{(1+t)^{1-a}} dt, \quad \Re z > 0,$$

$$8.6.6 \quad \Gamma(a, z) = \frac{2z^{\frac{1}{2}a} e^{-z}}{\Gamma(1-a)} \int_0^\infty e^{-t} t^{-\frac{1}{2}a} K_a(2\sqrt{zt}) dt, \quad \Re a < 1,$$

$$8.6.7 \quad \Gamma(a, z) = z^a \int_0^\infty \exp(at - ze^t) dt, \quad \Re z > 0.$$

### 8.6(ii) Contour Integrals

8.6.8

$$\gamma(a, z) = \frac{-iz^a}{2\sin(\pi a)} \int_{-1}^{(0+)} t^{a-1} e^{zt} dt, \quad z \neq 0, a \notin \mathbb{Z};$$

$t^{a-1}$  takes its principal value where the path intersects the positive real axis, and is continuous elsewhere on the path.

$$8.6.9 \quad \Gamma(-a, ze^{\pm\pi i}) = \frac{e^z e^{\mp\pi i a}}{\Gamma(1+a)} \int_0^\infty \frac{t^a e^{-zt}}{t-1} dt, \quad \Re z > 0, \Re a > -1,$$

where the integration path passes above or below the pole at  $t = 1$ , according as upper or lower signs are taken.

### Mellin–Barnes Integrals

In (8.6.10)–(8.6.12),  $c$  is a real constant and the path of integration is indented (if necessary) so that it separates the poles of the gamma function from the other pole in the integrand, in the case of (8.6.10) and (8.6.11), and from the poles at  $s = 0, 1, 2, \dots$  in the case of (8.6.12).

$$8.6.10 \quad \gamma(a, z) = \frac{1}{2\pi i} \int_{c-i\infty}^{c+i\infty} \frac{\Gamma(s)}{a-s} z^{a-s} ds, \quad |\operatorname{ph} z| < \frac{1}{2}\pi, a \neq 0, -1, -2, \dots,$$

## 8.6.11

$$\Gamma(a, z) = \frac{1}{2\pi i} \int_{c-i\infty}^{c+i\infty} \Gamma(s+a) \frac{z^{-s}}{s} ds, \quad |\text{ph } z| < \frac{1}{2}\pi,$$

## 8.6.12

$$\begin{aligned} \Gamma(a, z) &= -\frac{z^{a-1}e^{-z}}{\Gamma(1-a)} \\ &\times \frac{1}{2\pi i} \int_{c-i\infty}^{c+i\infty} \Gamma(s+1-a) \frac{\pi z^{-s}}{\sin(\pi s)} ds, \\ &|\text{ph } z| < \frac{3}{2}\pi, \quad a \neq 1, 2, 3, \dots \end{aligned}$$

## 8.6(iii) Compendia

For collections of integral representations of  $\gamma(a, z)$  and  $\Gamma(a, z)$  see Erdélyi *et al.* (1953b, §9.3), Oberhettinger (1972, pp. 68–69), Oberhettinger and Badii (1973, pp. 309–312), Prudnikov *et al.* (1992b, §3.10), and Temme (1996a, pp. 282–283).

## 8.7 Series Expansions

For the functions  $e_n(z)$ ,  $i_n^{(1)}(z)$ , and  $L_n^{(\alpha)}(x)$  see (8.4.11), §§10.47(ii), and 18.3, respectively.

## 8.7.1

$$\gamma^*(a, z) = e^{-z} \sum_{k=0}^{\infty} \frac{z^k}{\Gamma(a+k+1)} = \frac{1}{\Gamma(a)} \sum_{k=0}^{\infty} \frac{(-z)^k}{k!(a+k)}.$$

$$\begin{aligned} \gamma(a, x+y) - \gamma(a, x) \\ &= \Gamma(a, x) - \Gamma(a, x+y) \end{aligned}$$

## 8.7.2

$$\begin{aligned} &= e^{-x} x^{a-1} \sum_{n=0}^{\infty} \frac{(1-a)_n}{(-x)^n} (1 - e^{-y} e_n(y)), \\ &|y| < |x|. \end{aligned}$$

$$\Gamma(a, z) = \Gamma(a) - \sum_{k=0}^{\infty} \frac{(-1)^k z^{a+k}}{k!(a+k)}$$

## 8.7.3

$$\begin{aligned} &= \Gamma(a) \left( 1 - z^a e^{-z} \sum_{k=0}^{\infty} \frac{z^k}{\Gamma(a+k+1)} \right), \\ &a \neq 0, -1, -2, \dots \end{aligned}$$

## 8.7.4

$$\begin{aligned} \gamma(a, x) &= \Gamma(a) x^{\frac{1}{2}a} e^{-x} \sum_{n=0}^{\infty} e_n(-1) x^{\frac{1}{2}n} I_{n+a}(2x^{1/2}), \\ &a \neq 0, -1, -2, \dots \end{aligned}$$

## 8.7.5

$$\gamma^*(a, z) = e^{-\frac{1}{2}z} \sum_{n=0}^{\infty} \frac{(1-a)_n}{\Gamma(n+a+1)} (2n+1) i_n^{(1)}\left(\frac{1}{2}z\right).$$

## 8.7.6

$$\Gamma(a, x) = x^a e^{-x} \sum_{n=0}^{\infty} \frac{L_n^{(a)}(x)}{n+1}, \quad x > 0.$$

For an expansion for  $\gamma(a, ix)$  in series of Bessel functions  $J_n(x)$  that converges rapidly when  $a > 0$  and  $x$  ( $\geq 0$ ) is small or moderate in magnitude see Barakat (1961).

## 8.8 Recurrence Relations and Derivatives

$$8.8.1 \quad \gamma(a+1, z) = a\gamma(a, z) - z^a e^{-z},$$

$$8.8.2 \quad \Gamma(a+1, z) = a\Gamma(a, z) + z^a e^{-z}.$$

If  $w(a, z) = \gamma(a, z)$  or  $\Gamma(a, z)$ , then

$$8.8.3 \quad w(a+2, z) - (a+1+z)w(a+1, z) + azw(a, z) = 0.$$

$$8.8.4 \quad z\gamma^*(a+1, z) = \gamma^*(a, z) - \frac{e^{-z}}{\Gamma(a+1)}.$$

$$8.8.5 \quad P(a+1, z) = P(a, z) - \frac{z^a e^{-z}}{\Gamma(a+1)},$$

$$8.8.6 \quad Q(a+1, z) = Q(a, z) + \frac{z^a e^{-z}}{\Gamma(a+1)}.$$

For  $n = 0, 1, 2, \dots$ ,

## 8.8.7

$$\gamma(a+n, z) = (a)_n \gamma(a, z) - z^a e^{-z} \sum_{k=0}^{n-1} \frac{\Gamma(a+k)}{\Gamma(a+k+1)} z^k,$$

## 8.8.8

$$\begin{aligned} \gamma(a, z) \\ &= \frac{\Gamma(a)}{\Gamma(a-n)} \gamma(a-n, z) - z^{a-1} e^{-z} \sum_{k=0}^{n-1} \frac{\Gamma(a)}{\Gamma(a-k)} z^{-k}, \end{aligned}$$

## 8.8.9

$$\Gamma(a+n, z) = (a)_n \Gamma(a, z) + z^a e^{-z} \sum_{k=0}^{n-1} \frac{\Gamma(a+k)}{\Gamma(a+k+1)} z^k,$$

## 8.8.10

$$\begin{aligned} \Gamma(a, z) \\ &= \frac{\Gamma(a)}{\Gamma(a-n)} \Gamma(a-n, z) + z^{a-1} e^{-z} \sum_{k=0}^{n-1} \frac{\Gamma(a)}{\Gamma(a-k)} z^{-k}, \end{aligned}$$

$$8.8.11 \quad P(a+n, z) = P(a, z) - z^a e^{-z} \sum_{k=0}^{n-1} \frac{z^k}{\Gamma(a+k+1)},$$

$$8.8.12 \quad Q(a+n, z) = Q(a, z) + z^a e^{-z} \sum_{k=0}^{n-1} \frac{z^k}{\Gamma(a+k+1)}.$$

$$8.8.13 \quad \frac{d}{dz} \gamma(a, z) = -\frac{d}{dz} \Gamma(a, z) = z^{a-1} e^{-z},$$

$$8.8.14 \quad \left. \frac{\partial}{\partial a} \gamma^*(a, z) \right|_{a=0} = -E_1(z) - \ln z.$$

For  $E_1(z)$  see §8.19(i).

For  $n = 0, 1, 2, \dots$ ,

$$8.8.15 \quad \frac{d^n}{dz^n} (z^{-a} \gamma(a, z)) = (-1)^n z^{-a-n} \gamma(a+n, z),$$

$$8.8.16 \quad \frac{d^n}{dz^n} (z^{-a} \Gamma(a, z)) = (-1)^n z^{-a-n} \Gamma(a+n, z),$$

$$8.8.17 \quad \frac{d^n}{dz^n} (e^z \gamma(a, z)) = (-1)^n (1-a)_n e^z \gamma(a-n, z),$$

$$8.8.18 \quad \frac{d^n}{dz^n} (z^a e^z \gamma^*(a, z)) = z^{a-n} e^z \gamma^*(a-n, z),$$

$$8.8.19 \quad \frac{d^n}{dz^n} (e^z \Gamma(a, z)) = (-1)^n (1-a)_n e^z \Gamma(a-n, z).$$

### 8.9 Continued Fractions

$$\begin{aligned}
 \text{8.9.1} \quad & \Gamma(a+1)e^z \gamma^*(a, z) = \frac{1}{1 - \frac{z}{a+1} + \frac{z}{a+2} - \frac{(a+1)z}{a+3} + \frac{2z}{a+4} - \frac{(a+2)z}{a+5} + \frac{3z}{a+6} - \dots}, \quad a \neq -1, -2, \dots, \\
 \text{8.9.2} \quad & z^{-a} e^z \Gamma(a, z) = \frac{z^{-1}}{1 + \frac{(1-a)z^{-1}}{1 + \frac{z^{-1}}{1 + \frac{(2-a)z^{-1}}{1 + \frac{2z^{-1}}{1 + \frac{(3-a)z^{-1}}{1 + \frac{3z^{-1}}{1 + \dots}}}}} }}, \quad |\text{ph } z| < \pi.
 \end{aligned}$$

For these expansions and further information see Jones and Thron (1985). See also Cuyt *et al.* (2008, pp. 240–251).

### 8.10 Inequalities

$$\text{8.10.1} \quad x^{1-a} e^x \Gamma(a, x) \leq 1, \quad x > 0, 0 < a \leq 1,$$

$$\text{8.10.2} \quad \gamma(a, x) \geq \frac{x^{a-1}}{a} (1 - e^{-x}), \quad x > 0, 0 < a \leq 1.$$

The inequalities in (8.10.1) and (8.10.2) are reversed when  $a \geq 1$ . If  $\vartheta$  is defined by

$$\text{8.10.3} \quad x^{1-a} e^x \Gamma(a, x) = 1 + \frac{a-1}{x} \vartheta,$$

then  $\vartheta \rightarrow 1$  as  $x \rightarrow \infty$ , and

$$\text{8.10.4} \quad 0 < \vartheta \leq 1, \quad x > 0, a \leq 2.$$

For further inequalities of these types see Qi and Mei (1999).

#### Padé Approximants

For  $n = 1, 2, \dots$ ,

$$\text{8.10.5} \quad A_n < x^{1-a} e^x \Gamma(a, x) < B_n, \quad x > 0, a < 1,$$

where

$$\begin{aligned}
 \text{8.10.6} \quad & A_1 = \frac{x}{x+1-a}, \quad B_1 = \frac{x+1}{x+2-a}, \\
 & A_2 = \frac{x(x+3-a)}{x^2 + 2(2-a)x + (1-a)(2-a)}, \\
 & B_2 = \frac{x^2 + (5-a)x + 2}{x^2 + 2(3-a)x + (2-a)(3-a)}.
 \end{aligned}$$

For hypergeometric polynomial representations of  $A_n$  and  $B_n$ , see Luke (1969b, §14.6).

Next, define

$$\text{8.10.7} \quad I = \int_0^x t^{a-1} e^t dt = \Gamma(a) x^a \gamma^*(a, -x), \quad \Re a > 0.$$

Then

$$\text{8.10.8} \quad \frac{(a+1)(a+2) - x}{(a+1)(a+2+x)} < ax^{-a} e^{-x} I < \frac{a+1}{a+1+x}, \quad x > 0, a \geq 0.$$

Also, define

$$\text{8.10.9} \quad c_a = (\Gamma(1+a))^{1/(a-1)}, \quad d_a = (\Gamma(1+a))^{-1/a}.$$

Then

$$\begin{aligned}
 \text{8.10.10} \quad & \frac{x}{2a} \left( \left( 1 + \frac{2}{x} \right)^a - 1 \right) < x^{1-a} e^x \Gamma(a, x) \\
 & \leq \frac{x}{ac_a} \left( \left( 1 + \frac{c_a}{x} \right)^a - 1 \right), \\
 & x \geq 0, 0 < a < 1,
 \end{aligned}$$

and

$$\text{8.10.11} \quad (1 - e^{-\alpha_a x})^a \leq P(a, x) \leq (1 - e^{-\beta_a x})^a, \quad x \geq 0, a > 0,$$

where

$$\text{8.10.12} \quad \alpha_a = \begin{cases} 1, & 0 < a < 1, \\ d_a, & a > 1, \end{cases} \quad \beta_a = \begin{cases} d_a, & 0 < a < 1, \\ 1, & a > 1. \end{cases}$$

Equalities in (8.10.11) apply only when  $a = 1$ .

Lastly,

$$\text{8.10.13} \quad \frac{\Gamma(n, n)}{\Gamma(n)} < \frac{1}{2} < \frac{\Gamma(n, n-1)}{\Gamma(n)}, \quad n = 1, 2, 3, \dots$$

### 8.11 Asymptotic Approximations and Expansions

#### 8.11(i) Large $z$ , Fixed $a$

Define

$$\text{8.11.1} \quad u_k = (-1)^k (1-a)_k = (a-1)(a-2)\cdots(a-k),$$

8.11.2

$$\Gamma(a, z) = z^{a-1} e^{-z} \left( \sum_{k=0}^{n-1} \frac{u_k}{z^k} + R_n(a, z) \right), \quad n = 1, 2, \dots$$

Then as  $z \rightarrow \infty$  with  $a$  and  $n$  fixed

$$\text{8.11.3} \quad R_n(a, z) = O(z^{-n}), \quad |\text{ph } z| \leq \frac{3}{2}\pi - \delta,$$

where  $\delta$  denotes an arbitrary small positive constant.

If  $a$  is real and  $z (= x)$  is positive, then  $R_n(a, x)$  is bounded in absolute value by the first neglected term  $u_n/x^n$  and has the same sign provided that  $n \geq a - 1$ . For bounds on  $R_n(a, z)$  when  $a$  is real and  $z$  is complex see Olver (1997b, pp. 109–112). For an exponentially-improved asymptotic expansion (§2.11(iii)) see Olver (1991a).

**8.11(ii) Large  $a$ , Fixed  $z$**

**8.11.4**  $\gamma(a, z) = z^a e^{-z} \sum_{k=0}^{\infty} \frac{z^k}{(a)_{k+1}}, \quad a \neq 0, -1, -2, \dots$

This expansion is absolutely convergent for all finite  $z$ , and it can also be regarded as a generalized asymptotic expansion (§2.1(v)) of  $\gamma(a, z)$  as  $a \rightarrow \infty$  in  $|\text{ph } a| \leq \pi - \delta$ .

Also,

**8.11.5**  $P(a, z) \sim \frac{z^a e^{-z}}{\Gamma(1+a)} \sim (2\pi a)^{-\frac{1}{2}} e^{a-z} (z/a)^a, \quad a \rightarrow \infty, |\text{ph } a| \leq \pi - \delta.$

**8.11(iii) Large  $a$ , Fixed  $x/a$**

If  $x = \lambda a$ , with  $\lambda$  fixed, then as  $a \rightarrow +\infty$

**8.11.6**  $\gamma(a, x) \sim -x^a e^{-x} \sum_{k=0}^{\infty} \frac{(-a)^k b_k(\lambda)}{(x-a)^{2k+1}}, \quad 0 < \lambda < 1,$

**8.11.7**  $\Gamma(a, x) \sim x^a e^{-x} \sum_{k=0}^{\infty} \frac{(-a)^k b_k(\lambda)}{(x-a)^{2k+1}}, \quad \lambda > 1,$

---

**8.11.11**  $\gamma^*(1-a, -x) = x^{a-1} \left( -\cos(\pi a) + \frac{\sin(\pi a)}{\pi} \left( 2\sqrt{\pi} F(y) + \frac{2}{3} \sqrt{\frac{2\pi}{a}} (1-y^2) \right) e^{y^2} + O(a^{-1}) \right),$

in both cases uniformly with respect to bounded real values of  $y$ . For Dawson's integral  $F(y)$  see §7.2(ii). See Tricomi (1950b) for these approximations, together with higher terms and extensions to complex variables. For related expansions involving Hermite polynomials see Pagurova (1965).

**8.11(v) Other Approximations**

As  $z \rightarrow \infty$ ,

**8.11.12**  $\Gamma(z, z) \sim z^{z-1} e^{-z} \left( \sqrt{\frac{\pi}{2}} z^{\frac{1}{2}} - \frac{1}{3} + \frac{\sqrt{2\pi}}{24z^{\frac{1}{2}}} - \frac{4}{135z} + \frac{\sqrt{2\pi}}{576z^{\frac{3}{2}}} + \frac{8}{2835z^2} + \dots \right), \quad |\text{ph } z| \leq \pi - \delta.$

For the function  $e_n(z)$  defined by (8.4.11),

**8.11.13**  $\lim_{n \rightarrow \infty} \frac{e_n(nx)}{e^{nx}} = \begin{cases} 0, & x > 1, \\ \frac{1}{2}, & x = 1, \\ 1, & 0 \leq x < 1. \end{cases}$

With  $x = 1$ , an asymptotic expansion of  $e_n(nx)/e^{nx}$  follows from (8.11.14) and (8.11.16).

where

**8.11.8**  $b_0(\lambda) = 1, \quad b_1(\lambda) = \lambda, \quad b_2(\lambda) = \lambda(2\lambda + 1),$

and for  $k = 1, 2, \dots$ ,

**8.11.9**  $b_k(\lambda) = \lambda(1-\lambda)b'_{k-1}(\lambda) + (2k-1)\lambda b_{k-1}(\lambda).$

The expansion (8.11.7) also applies when  $a \rightarrow -\infty$  with  $\lambda < 0$ , and in this case Gautschi (1959a) supplies numerical bounds for the remainders in the truncated expansion (8.11.7). For extensions to complex variables see Temme (1994a, §4), and also Mahler (1930), Tricomi (1950b), and Paris (2002b).

**8.11(iv) Large  $a$ , Bounded  $(x-a)/(2a)^{\frac{1}{2}}$**

If  $x = a + (2a)^{\frac{1}{2}}y$  and  $a \rightarrow +\infty$ , then

**8.11.10**  $P(a+1, x) = \frac{1}{2} \text{erfc}(-y) - \frac{1}{3} \sqrt{\frac{2}{\pi a}} (1+y^2) e^{-y^2} + O(a^{-1}),$

If  $S_n(x)$  is defined by

**8.11.14**  $e^{nx} = e_n(nx) + \frac{(nx)^n}{n!} S_n(x),$

then

**8.11.15**  $S_n(x) = \frac{\gamma(n+1, nx)}{(nx)^n e^{-nx}}.$

As  $n \rightarrow \infty$

**8.11.16**  $S_n(1) \sim \frac{1}{2} \frac{n! e^n}{n^n} \sim -\frac{2}{3} + \frac{4}{135} n^{-1} - \frac{8}{2835} n^{-2} - \frac{16}{8505} n^{-3} + \dots,$

**8.11.17**  $S_n(-1) \sim -\frac{1}{2} + \frac{1}{8} n^{-1} + \frac{1}{32} n^{-2} - \frac{1}{128} n^{-3} - \frac{13}{512} n^{-4} + \dots$

Also,

**8.11.18**  $S_n(x) \sim \sum_{k=0}^{\infty} d_k(x) n^{-k}, \quad n \rightarrow \infty,$

uniformly for  $x \in (-\infty, 1 - \delta]$ , with

**8.11.19**  $d_k(x) = \frac{(-1)^k b_k(x)}{(1-x)^{2k+1}}, \quad k = 0, 1, 2, \dots,$

and  $b_k(x)$  as in §8.11(iii).

For (8.11.18) and extensions to complex values of  $x$  see Buckholtz (1963). For a uniformly valid expansion for  $n \rightarrow \infty$  and  $x \in [\delta, 1]$ , see Wong (1973b).

### 8.12 Uniform Asymptotic Expansions for Large Parameter

Define

$$8.12.1 \quad \lambda = z/a, \quad \eta = (2(\lambda - 1 - \ln \lambda))^{1/2},$$

where the branch of the square root is continuous and satisfies  $\eta(\lambda) \sim \lambda - 1$  as  $\lambda \rightarrow 1$ . Then

$$8.12.2 \quad \frac{1}{2}\eta^2 = \lambda - 1 - \ln \lambda, \quad \frac{d\eta}{d\lambda} = \frac{\lambda - 1}{\lambda\eta}.$$

Also, denote

$$8.12.3 \quad P(a, z) = \frac{1}{2} \operatorname{erfc}\left(-\eta\sqrt{a/2}\right) - S(a, \eta),$$

$$8.12.4 \quad Q(a, z) = \frac{1}{2} \operatorname{erfc}\left(\eta\sqrt{a/2}\right) + S(a, \eta),$$

$$8.12.5 \quad \begin{aligned} &\Gamma(a+1) \frac{e^{\pm\pi ia}}{2\pi i} \Gamma(-a, ze^{\pm\pi i}) \\ &= \mp \frac{1}{2} \operatorname{erfc}\left(\pm i\eta\sqrt{a/2}\right) + iT(a, \eta), \end{aligned}$$

and

$$8.12.6 \quad \begin{aligned} &z^{-a} \gamma^*(-a, -z) \\ &= \cos(\pi a) - 2 \sin(\pi a) \left( \frac{e^{\frac{1}{2}a\eta^2}}{\sqrt{\pi}} F\left(\eta\sqrt{a/2}\right) + T(a, \eta) \right), \end{aligned}$$

where  $F(x)$  is Dawson's integral; see §7.2(ii). Then as  $a \rightarrow \infty$  in the sector  $|\operatorname{ph} a| \leq \pi - \delta (< \pi)$ ,

$$8.12.7 \quad S(a, \eta) \sim \frac{e^{-\frac{1}{2}a\eta^2}}{\sqrt{2\pi a}} \sum_{k=0}^{\infty} c_k(\eta) a^{-k},$$

$$8.12.8 \quad T(a, \eta) \sim \frac{e^{\frac{1}{2}a\eta^2}}{\sqrt{2\pi a}} \sum_{k=0}^{\infty} c_k(\eta) (-a)^{-k},$$

in each case uniformly with respect to  $\lambda$  in the sector  $|\operatorname{ph} \lambda| \leq 2\pi - \delta (< 2\pi)$ .

With  $\mu = \lambda - 1$ , the coefficients  $c_k(\eta)$  are given by

$$8.12.9 \quad c_0(\eta) = \frac{1}{\mu} - \frac{1}{\eta}, \quad c_1(\eta) = \frac{1}{\eta^3} - \frac{1}{\mu^3} - \frac{1}{\mu^2} - \frac{1}{12\mu},$$

$$8.12.10 \quad c_k(\eta) = \frac{1}{\eta} \frac{d}{d\eta} c_{k-1}(\eta) + (-1)^k \frac{g_k}{\mu}, \quad k = 1, 2, \dots,$$

where  $g_k$ ,  $k = 0, 1, 2, \dots$ , are the coefficients that appear in the asymptotic expansion (5.11.3) of  $\Gamma(z)$ . The right-hand sides of equations (8.12.9), (8.12.10) have removable singularities at  $\eta = 0$ , and the Maclaurin series expansion of  $c_k(\eta)$  is given by

$$8.12.11 \quad c_k(\eta) = \sum_{n=0}^{\infty} d_{k,n} \eta^n, \quad |\eta| < 2\sqrt{\pi},$$

where  $d_{0,0} = -\frac{1}{3}$ ,

$$8.12.12 \quad \begin{aligned} d_{0,n} &= (n+2)\alpha_{n+2}, & n \geq 1, \\ d_{k,n} &= (-1)^k g_k d_{0,n} + (n+2)d_{k-1,n+2}, & n \geq 0, k \geq 1, \end{aligned}$$

and  $\alpha_3, \alpha_4, \dots$  are defined by

$$8.12.13 \quad \lambda - 1 = \eta + \frac{1}{3}\eta^2 + \sum_{n=3}^{\infty} \alpha_n \eta^n, \quad |\eta| < 2\sqrt{\pi}.$$

In particular,

$$8.12.14 \quad \begin{aligned} \alpha_3 &= \frac{1}{36}, & \alpha_4 &= -\frac{1}{270}, & \alpha_5 &= \frac{1}{4320}, \\ \alpha_6 &= \frac{1}{17010}, & \alpha_7 &= -\frac{139}{54 \cdot 43200}, & \alpha_8 &= \frac{1}{2 \cdot 04120}. \end{aligned}$$

For numerical values of  $d_{k,n}$  to 30D for  $k = 0(1)9$  and  $n = 0(1)N_k$ , where  $N_k = 28 - 4 \lfloor k/2 \rfloor$ , see DiDonato and Morris (1986).

Special cases are given by

$$8.12.15 \quad Q(a, a) \sim \frac{1}{2} + \frac{1}{\sqrt{2\pi a}} \sum_{k=0}^{\infty} c_k(0) a^{-k}, \quad |\operatorname{ph} a| \leq \pi - \delta,$$

$$8.12.16 \quad \begin{aligned} &\frac{e^{\pm\pi ia}}{2i \sin(\pi a)} Q(-a, ae^{\pm\pi i}) \\ &\sim \pm \frac{1}{2} - \frac{i}{\sqrt{2\pi a}} \sum_{k=0}^{\infty} c_k(0) (-a)^{-k}, \quad |\operatorname{ph} a| \leq \pi - \delta, \end{aligned}$$

where

$$8.12.17 \quad \begin{aligned} c_0(0) &= -\frac{1}{3}, & c_1(0) &= -\frac{1}{540}, \\ c_2(0) &= \frac{25}{6048}, & c_3(0) &= \frac{101}{1 \cdot 55520}, \\ c_4(0) &= -\frac{31 \cdot 84811}{36951 \cdot 55200}, & c_5(0) &= -\frac{27 \cdot 45493}{81517 \cdot 36320}. \end{aligned}$$

For error bounds for (8.12.7) see Paris (2002a). For the asymptotic behavior of  $c_k(\eta)$  as  $k \rightarrow \infty$  see Dunster *et al.* (1998) and Olde Daalhuis (1998c). The last reference also includes an exponentially-improved version (§2.11(iii)) of the expansions (8.12.4) and (8.12.7) for  $Q(a, z)$ .

A different type of uniform expansion with coefficients that do not possess a removable singularity at  $z = a$  is given by

$$8.12.18 \quad \left. \begin{aligned} &Q(a, z) \\ &P(a, z) \end{aligned} \right\} \sim \frac{z^{a-\frac{1}{2}} e^{-z}}{\Gamma(a)} \left( d(\pm\chi) \sum_{k=0}^{\infty} \frac{A_k(\chi)}{z^{k/2}} \pm \sum_{k=1}^{\infty} \frac{B_k(\chi)}{z^{k/2}} \right),$$

for  $z \rightarrow \infty$  in  $|\operatorname{ph} z| < \frac{1}{2}\pi$ , with  $\Re(z - a) \leq 0$  for  $P(a, z)$  and  $\Re(z - a) \geq 0$  for  $Q(a, z)$ . Here

$$8.12.19 \quad \begin{aligned} \chi &= (z - a)/\sqrt{z}, & d(\pm\chi) &= \sqrt{\frac{1}{2}\pi} e^{\chi^2/2} \operatorname{erfc}\left(\pm\chi/\sqrt{2}\right), \end{aligned}$$

and

8.12.20  $A_0(\chi) = 1$ ,  $A_1(\chi) = \frac{1}{2}\chi + \frac{1}{6}\chi^3$ ,  $B_1(\chi) = \frac{1}{3} + \frac{1}{6}\chi^2$ . Higher coefficients  $A_k(\chi)$ ,  $B_k(\chi)$ , up to  $k = 8$ , are given in Paris (2002b).

Lastly, a uniform approximation for  $\Gamma(a, ax)$  for large  $a$ , with error bounds, can be found in Dunster (1996a).

For other uniform asymptotic approximations of the incomplete gamma functions in terms of the function  $\operatorname{erfc}$  see Paris (2002b) and Dunster (1996a).

**Inverse Function**

For asymptotic expansions, as  $a \rightarrow \infty$ , of the *inverse function*  $x = x(a, q)$  that satisfies the equation

8.12.21 
$$Q(a, x) = q$$

see Temme (1992a). These expansions involve the inverse error function  $\operatorname{inverfc}(x)$  (§7.17), and are uniform with respect to  $q \in [0, 1]$ . As a special case,

8.12.22 
$$x(a, \frac{1}{2}) \sim a - \frac{1}{3} + \frac{8}{405}a^{-1} + \frac{184}{25515}a^{-2} + \frac{2248}{34\,44525}a^{-3} + \dots, \quad a \rightarrow \infty.$$

**8.13 Zeros**

**8.13(i)  $x$ -Zeros of  $\gamma^*(a, x)$**

The function  $\gamma^*(a, x)$  has no real zeros for  $a \geq 0$ . For  $a < 0$  and  $n = 1, 2, 3, \dots$ , there exist:

- (a) one negative zero  $x_-(a)$  and no positive zeros when  $1 - 2n < a < 2 - 2n$ ;
- (b) one negative zero  $x_-(a)$  and one positive zero  $x_+(a)$  when  $-2n < a < 1 - 2n$ .

The negative zero  $x_-(a)$  decreases monotonically in the interval  $-1 < a < 0$ , and satisfies

8.13.1 
$$1 + a^{-1} < x_-(a) < \ln |a|, \quad -1 < a < 0.$$

When  $-5 \leq a \leq 4$  the behavior of the  $x$ -zeros as functions of  $a$  can be seen by taking the slice  $\gamma^*(a, x) = 0$  of the surface depicted in Figure 8.3.6. Note that from (8.4.12)  $\gamma^*(-n, 0) = 0, n = 1, 2, 3, \dots$

For asymptotic approximations for  $x_+(a)$  and  $x_-(a)$  as  $a \rightarrow -\infty$  see Tricomi (1950b), with corrections by Kölbig (1972b).

**8.13(ii)  $\lambda$ -Zeros of  $\gamma(a, \lambda a)$  and  $\Gamma(a, \lambda a)$**

For information on the distribution and computation of zeros of  $\gamma(a, \lambda a)$  and  $\Gamma(a, \lambda a)$  in the complex  $\lambda$ -plane for large values of the positive real parameter  $a$  see Temme (1995a).

**8.13(iii)  $a$ -Zeros of  $\gamma^*(a, x)$**

For fixed  $x$  and  $n = 1, 2, 3, \dots, \gamma^*(a, x)$  has:

- (a) two zeros in each of the intervals  $-2n < a < 2 - 2n$  when  $x < 0$ ;
- (b) two zeros in each of the intervals  $-2n < a < 1 - 2n$  when  $0 < x \leq x_n^*$ ;
- (c) zeros at  $a = -n$  when  $x = 0$ .

As  $x$  increases the positive zeros coalesce to form a double zero at  $(a_n^*, x_n^*)$ . The values of the first six double zeros are given to 5D in Table 8.13.1. For values up to  $n = 10$  see Kölbig (1972b). Approximations to  $a_n^*, x_n^*$  for large  $n$  can be found in Kölbig (1970). When  $x > x_n^*$  a pair of conjugate trajectories emanate from the point  $a = a_n^*$  in the complex  $a$ -plane. See Kölbig (1970, 1972b) for further information.

Table 8.13.1: Double zeros  $(a_n^*, x_n^*)$  of  $\gamma^*(a, x)$ .

$n$	$a_n^*$	$x_n^*$
1	-1.64425	0.30809
2	-3.63887	0.77997
3	-5.63573	1.28634
4	-7.63372	1.80754
5	-9.63230	2.33692
6	-11.63126	2.87150

**8.14 Integrals**

8.14.1 
$$\int_0^\infty e^{-ax} \frac{\gamma(b, x)}{\Gamma(b)} dx = \frac{(1+a)^{-b}}{a}, \quad \Re a > 0, \Re b > -1,$$

8.14.2 
$$\int_0^\infty e^{-ax} \Gamma(b, x) dx = \Gamma(b) \frac{1 - (1+a)^{-b}}{a}, \quad \Re a > -1, \Re b > -1.$$

In (8.14.1) and (8.14.2) limiting values are used when  $b = 0$ .

8.14.3 
$$\int_0^\infty x^{a-1} \gamma(b, x) dx = -\frac{\Gamma(a+b)}{a}, \quad \Re a < 0, \Re(a+b) > 0,$$

8.14.4 
$$\int_0^\infty x^{a-1} \Gamma(b, x) dx = \frac{\Gamma(a+b)}{a}, \quad \Re a > 0, \Re(a+b) > 0,$$

8.14.5 
$$\int_0^\infty x^{a-1} e^{-sx} \gamma(b, x) dx = \frac{\Gamma(a+b)}{b(1+s)^{a+b}} F(1, a+b; 1+b; 1/(1+s)), \quad \Re s > 0, \Re(a+b) > 0,$$

8.14.6 
$$\int_0^\infty x^{a-1} e^{-sx} \Gamma(b, x) dx = \frac{\Gamma(a+b)}{a(1+s)^{a+b}} F(1, a+b; 1+a; s/(1+s)), \quad \Re s > -1, \Re(a+b) > 0, \Re a > 0.$$

For the hypergeometric function  $F(a, b; c; z)$  see §15.2(i).

For additional integrals see Apelblat (1983, §8.2), Erdélyi *et al.* (1953b, §9.3), Erdélyi *et al.* (1954a,b), Gradshteyn and Ryzhik (2000, §6.45), Marichev (1983, pp.189–190), Oberhettinger (1972, pp. 68–69), Prudnikov *et al.* (1986b, §§1.2, 2.10), and Prudnikov *et al.* (1992a, §3.10).

## 8.15 Sums

$$8.15.1 \quad \gamma(a, \lambda x) = \lambda^a \sum_{k=0}^{\infty} \gamma(a+k, x) \frac{(1-\lambda)^k}{k!}.$$

For sums of infinite series whose terms include incomplete gamma functions, see Prudnikov *et al.* (1986b, §5.2).

## 8.16 Generalizations

For a generalization of the incomplete gamma function, including asymptotic approximations, see Chaudhry and Zubair (1994, 2001) and Chaudhry *et al.* (1996). Other generalizations are considered in Guthmann (1991) and Paris (2003).

## Related Functions

### 8.17 Incomplete Beta Functions

#### 8.17(i) Definitions and Basic Properties

Throughout §§8.17 and 8.18 we assume that  $a > 0$ ,  $b > 0$ , and  $0 \leq x \leq 1$ . However, in the case of §8.17 it is straightforward to continue most results analytically to other real values of  $a$ ,  $b$ , and  $x$ , and also to complex values.

$$8.17.1 \quad B_x(a, b) = \int_0^x t^{a-1} (1-t)^{b-1} dt,$$

$$8.17.2 \quad I_x(a, b) = B_x(a, b) / B(a, b),$$

where, as in §5.12,  $B(a, b)$  denotes the Beta function:

$$8.17.3 \quad B(a, b) = \frac{\Gamma(a)\Gamma(b)}{\Gamma(a+b)}.$$

$$8.17.4 \quad I_x(a, b) = 1 - I_{1-x}(b, a),$$

$$8.17.5 \quad I_x(m, n-m+1) = \sum_{j=m}^n \binom{n}{j} x^j (1-x)^{n-j},$$

$$8.17.6 \quad I_x(a, a) = \frac{1}{2} I_{4x(1-x)}\left(a, \frac{1}{2}\right), \quad 0 \leq x \leq \frac{1}{2}.$$

For a historical profile of  $B_x(a, b)$  see Dutka (1981).

#### 8.17(ii) Hypergeometric Representations

$$8.17.7 \quad B_x(a, b) = \frac{x^a}{a} F(a, 1-b; a+1; x),$$

$$8.17.8 \quad B_x(a, b) = \frac{x^a(1-x)^b}{a} F(a+b, 1; a+1; x),$$

$$8.17.9 \quad B_x(a, b) = \frac{x^a(1-x)^{b-1}}{a} F\left(1, 1-b; \frac{x}{a+1}; \frac{x}{x-1}\right).$$

For the hypergeometric function  $F(a, b; c; z)$  see §15.2(i).

#### 8.17(iii) Integral Representation

With  $a > 0$ ,  $b > 0$ , and  $0 < x < 1$ ,

$$8.17.10 \quad I_x(a, b) = \frac{x^a(1-x)^b}{2\pi i} \int_{c-i\infty}^{c+i\infty} s^{-a}(1-s)^{-b} \frac{ds}{s-x},$$

where  $x < c < 1$  and the branches of  $s^{-a}$  and  $(1-s)^{-b}$  are continuous on the path and assume their principal values when  $s = c$ .

Further integral representations can be obtained by combining the results given in §8.17(ii) with §15.6.

#### 8.17(iv) Recurrence Relations

With

$$8.17.11 \quad x' = 1-x, \quad c = a+b-1,$$

$$8.17.12 \quad I_x(a, b) = x I_x(a-1, b) + x' I_x(a, b-1),$$

$$8.17.13 \quad (a+b) I_x(a, b) = a I_x(a+1, b) + b I_x(a, b+1),$$

$$8.17.14 \quad (a+bx) I_x(a, b) = xb I_x(a-1, b+1) + a I_x(a+1, b),$$

$$8.17.15 \quad (b+ax') I_x(a, b) = ax' I_x(a+1, b-1) + b I_x(a, b+1),$$

$$8.17.16 \quad a I_x(a+1, b) = (a+cx) I_x(a, b) - cx I_x(a-1, b),$$

$$8.17.17 \quad b I_x(a, b+1) = (b+cx') I_x(a, b) - cx' I_x(a, b-1),$$

$$8.17.18 \quad I_x(a, b) = I_x(a+1, b-1) + \frac{x^a(x')^{b-1}}{aB(a, b)},$$

$$8.17.19 \quad I_x(a, b) = I_x(a-1, b+1) - \frac{x^{a-1}(x')^b}{bB(a, b)},$$

$$8.17.20 \quad I_x(a, b) = I_x(a+1, b) + \frac{x^a(x')^b}{aB(a, b)},$$

$$8.17.21 \quad I_x(a, b) = I_x(a, b+1) - \frac{x^a(x')^b}{bB(a, b)}.$$



**8.17(v) Continued Fraction**

**8.17.22** 
$$I_x(a, b) = \frac{x^a(1-x)^b}{aB(a, b)} \left( \frac{1}{1+} \frac{d_1}{1+} \frac{d_2}{1+} \frac{d_3}{1+} \dots \right),$$

where

**8.17.23** 
$$d_{2m} = \frac{m(b-m)x}{(a+2m-1)(a+2m)},$$

$$d_{2m+1} = -\frac{(a+m)(a+b+m)x}{(a+2m)(a+2m+1)}.$$

The  $4m$  and  $4m + 1$  convergents are less than  $I_x(a, b)$ , and the  $4m + 2$  and  $4m + 3$  convergents are greater than  $I_x(a, b)$ .

See also Cuyt *et al.* (2008, pp. 385–389).

The expansion (8.17.22) converges rapidly for  $x < (a + 1)/(a + b + 2)$ . For  $x > (a + 1)/(a + b + 2)$  or  $1 - x < (b + 1)/(a + b + 2)$ , more rapid convergence is obtained by computing  $I_{1-x}(b, a)$  and using (8.17.4).

**8.17(vi) Sums**

For sums of infinite series whose terms involve the incomplete Beta function see Hansen (1975, §62).

**8.18 Asymptotic Expansions of  $I_x(a, b)$**

**8.18(i) Large Parameters, Fixed  $x$**

If  $b$  and  $x$  are fixed, with  $b > 0$  and  $0 < x < 1$ , then as  $a \rightarrow \infty$

**8.18.1** 
$$I_x(a, b) = \Gamma(a+b)x^a(1-x)^{b-1} \times \left( \sum_{k=0}^{n-1} \frac{1}{\Gamma(a+k+1)\Gamma(b-k)} \left( \frac{x}{1-x} \right)^k + O\left( \frac{1}{\Gamma(a+n+1)} \right) \right),$$

for each  $n = 0, 1, 2, \dots$ . If  $b = 1, 2, 3, \dots$  and  $n \geq b$ , then the  $O$ -term can be omitted and the result is exact.

If  $b \rightarrow \infty$  and  $a$  and  $x$  are fixed, with  $a > 0$  and  $0 < x < 1$ , then (8.18.1), with  $a$  and  $b$  interchanged and  $x$  replaced by  $1 - x$ , can be combined with (8.17.4).

**8.18(ii) Large Parameters: Uniform Asymptotic Expansions**

**Large  $a$ , Fixed  $b$**

Let

**8.18.2** 
$$\xi = -\ln x.$$

Then as  $a \rightarrow \infty$ , with  $b (> 0)$  fixed,

**8.18.3** 
$$I_x(a, b) \sim \frac{\Gamma(a+b)}{\Gamma(a)} \sum_{k=0}^{\infty} d_k F_k,$$

uniformly for  $x \in (0, 1)$ . The functions  $F_k$  are defined by

**8.18.4** 
$$aF_{k+1} = (k+b-a\xi)F_k + k\xi F_{k-1},$$

with

**8.18.5** 
$$F_0 = a^{-b} Q(b, a\xi), \quad F_1 = \frac{b-a\xi}{a} F_0 + \frac{\xi^b e^{-a\xi}}{a\Gamma(b)},$$

and  $Q(a, z)$  as in §8.2(i). The coefficients  $d_k$  are defined by the generating function

**8.18.6** 
$$\left( \frac{1-e^{-t}}{t} \right)^{b-1} = \sum_{k=0}^{\infty} d_k (t-\xi)^k.$$

In particular,

**8.18.7** 
$$d_0 = \left( \frac{1-x}{\xi} \right)^{b-1}, \quad d_1 = \frac{x\xi + x - 1}{(1-x)\xi} (b-1)d_0.$$

Compare also §24.16(i).

**Symmetric Case**

Let

**8.18.8** 
$$x_0 = a/(a+b).$$

Then as  $a+b \rightarrow \infty$ ,

**8.18.9** 
$$I_x(a, b) \sim \frac{1}{2} \operatorname{erfc}\left(-\eta\sqrt{b/2}\right) + \frac{1}{\sqrt{2\pi(a+b)}} \times \left( \frac{x}{x_0} \right)^a \left( \frac{1-x}{1-x_0} \right)^b \sum_{k=0}^{\infty} \frac{(-1)^k c_k(\eta)}{(a+b)^k},$$

uniformly for  $x \in (0, 1)$  and  $a/(a+b), b/(a+b) \in [\delta, 1-\delta]$ , where  $\delta$  again denotes an arbitrary small positive constant. For  $\operatorname{erfc}$  see §7.2(i). Also,

**8.18.10** 
$$-\frac{1}{2}\eta^2 = x_0 \ln\left(\frac{x}{x_0}\right) + (1-x_0) \ln\left(\frac{1-x}{1-x_0}\right),$$

with  $\eta/(x-x_0) > 0$ , and

**8.18.11** 
$$c_0(\eta) = \frac{1}{\eta} - \frac{\sqrt{x_0(1-x_0)}}{x-x_0},$$

with limiting value

**8.18.12** 
$$c_0(0) = \frac{1-2x_0}{3\sqrt{x_0(1-x_0)}}.$$

For this result, and for higher coefficients  $c_k(\eta)$  see Temme (1996a, §11.3.3.2). All of the  $c_k(\eta)$  are analytic at  $\eta = 0$ .

**General Case**

Let  $\tilde{\Gamma}(z)$  denote the scaled gamma function

**8.18.13**  $\tilde{\Gamma}(z) = (2\pi)^{-1/2} e^z z^{(1/2)-z} \Gamma(z)$ ,  
 $\mu = b/a$ , and  $x_0$  again be as in (8.18.8). Then as  $a \rightarrow \infty$

**8.18.14**

$$I_x(a, b) \sim Q(b, a\zeta) - \frac{(2\pi b)^{-1/2}}{\tilde{\Gamma}(b)} \left(\frac{x}{x_0}\right)^a \left(\frac{1-x}{1-x_0}\right)^b \sum_{k=0}^{\infty} \frac{h_k(\zeta, \mu)}{a^k},$$

uniformly for  $b \in (0, \infty)$  and  $x \in (0, 1)$ . Here

**8.18.15**

$\mu \ln \zeta - \zeta = \ln x + \mu \ln(1-x) + (1+\mu) \ln(1+\mu) - \mu$ ,  
 with  $(\zeta - \mu)/(x_0 - x) > 0$ , and

**8.18.16**  $h_0(\zeta, \mu) = \mu \left( \frac{1}{\zeta - \mu} - \frac{(1+\mu)^{-3/2}}{x_0 - x} \right)$ ,

with limiting value

**8.18.17**  $h_0(\mu, \mu) = \frac{1}{3} \left( \frac{1-\mu}{\sqrt{1+\mu}} - 1 \right)$ .

For this result and higher coefficients  $h_k(\zeta, \mu)$  see Temme (1996a, §11.3.3.3). All of the  $h_k(\zeta, \mu)$  are analytic at  $\zeta = \mu$  (corresponding to  $x = x_0$ ).

**Inverse Function**

For asymptotic expansions for large values of  $a$  and/or  $b$  of the  $x$ -solution of the equation

**8.18.18**  $I_x(a, b) = p$ ,  $0 \leq p \leq 1$ ,

see Temme (1992b).

**8.19 Generalized Exponential Integral****8.19(i) Definition and Integral Representations**

For  $p, z \in \mathbb{C}$

**8.19.1**  $E_p(z) = z^{p-1} \Gamma(1-p, z)$ .

Most properties of  $E_p(z)$  follow straightforwardly from those of  $\Gamma(a, z)$ . For an extensive treatment of  $E_1(z)$  see Chapter 6.

**8.19.2**  $E_p(z) = z^{p-1} \int_z^{\infty} \frac{e^{-t}}{t^p} dt$ .

When the path of integration excludes the origin and does not cross the negative real axis (8.19.2) defines the principal value of  $E_p(z)$ , and unless indicated otherwise in this Handbook principal values are assumed.

**Other Integral Representations**

**8.19.3**  $E_p(z) = \int_1^{\infty} \frac{e^{-zt}}{t^p} dt$ ,  $|\text{ph } z| < \frac{1}{2}\pi$ ,

**8.19.4**  $E_p(z) = \frac{z^{p-1} e^{-z}}{\Gamma(p)} \int_0^{\infty} \frac{t^{p-1} e^{-zt}}{1+t} dt$ ,  
 $|\text{ph } z| < \frac{1}{2}\pi$ ,  $\Re p > 0$ .

Integral representations of Mellin–Barnes type for  $E_p(z)$  follow immediately from (8.6.11), (8.6.12), and (8.19.1).

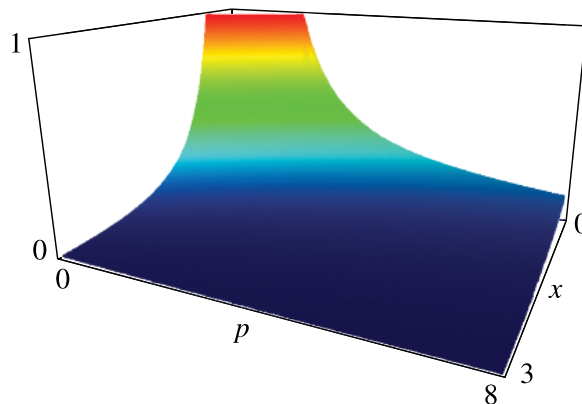
**8.19(ii) Graphics**

Figure 8.19.1:  $E_p(x)$ ,  $0 \leq x \leq 3$ ,  $0 \leq p \leq 8$ .

In Figures 8.19.2 and 8.19.3, height corresponds to the absolute value of the function and color to the phase. See p. xiv.

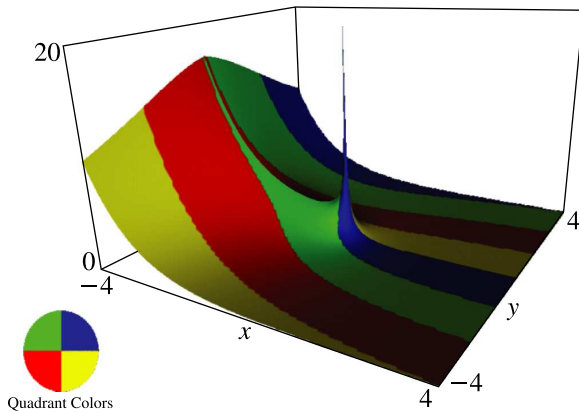


Figure 8.19.2:  $E_{\frac{1}{2}}(x + iy)$ ,  $-4 \leq x \leq 4$ ,  $-4 \leq y \leq 4$ . Principal value. There is a branch cut along the negative real axis.

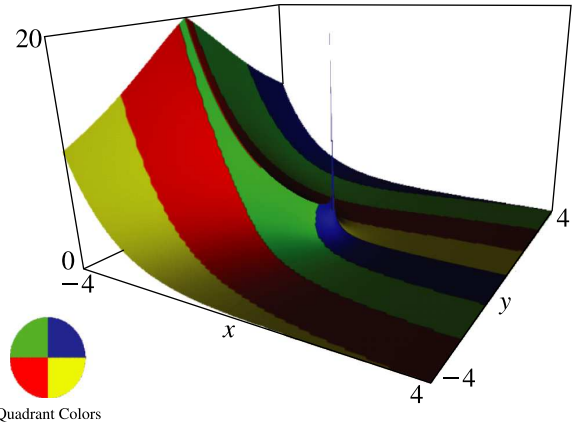


Figure 8.19.3:  $E_1(x + iy)$ ,  $-4 \leq x \leq 4$ ,  $-4 \leq y \leq 4$ . Principal value. There is a branch cut along the negative real axis.

For additional graphics see <http://dlmf.nist.gov/8.19.ii>.

**8.19(iii) Special Values**

8.19.5  $E_0(z) = z^{-1}e^{-z}, \quad z \neq 0,$

8.19.6  $E_p(0) = \frac{1}{p-1}, \quad \Re p > 1,$

8.19.7 
$$E_n(z) = \frac{(-z)^{n-1}}{(n-1)!} E_1(z) + \frac{e^{-z}}{(n-1)!} \sum_{k=0}^{n-2} (n-k-2)! (-z)^k,$$

$$n = 2, 3, \dots$$

**8.19(iv) Series Expansions**

For  $n = 1, 2, 3, \dots$ ,

8.19.8 
$$E_n(z) = \frac{(-z)^{n-1}}{(n-1)!} (\psi(n) - \ln z) - \sum_{\substack{k=0 \\ k \neq n-1}}^{\infty} \frac{(-z)^k}{k!(1-n+k)},$$

and

8.19.9 
$$E_n(z) = \frac{(-1)^n z^{n-1}}{(n-1)!} \ln z + \frac{e^{-z}}{(n-1)!} \sum_{k=1}^{n-1} (-z)^{k-1} \Gamma(n-k) + \frac{e^{-z} (-z)^{n-1}}{(n-1)!} \sum_{k=0}^{\infty} \frac{z^k}{k!} \psi(k+1),$$

with  $|\text{ph } z| \leq \pi$  in both equations. For  $\psi(x)$  see §5.2(i). When  $p \in \mathbb{C}$

8.19.10 
$$E_p(z) = z^{p-1} \Gamma(1-p) - \sum_{k=0}^{\infty} \frac{(-z)^k}{k!(1-p+k)},$$

**8.19.11**

$$E_p(z) = \Gamma(1-p) \left( z^{p-1} - e^{-z} \sum_{k=0}^{\infty} \frac{z^k}{\Gamma(2-p+k)} \right),$$

again with  $|\text{ph } z| \leq \pi$  in both equations. The right-hand sides are replaced by their limiting forms when  $p = 1, 2, 3, \dots$

**8.19(v) Recurrence Relation and Derivatives**

8.19.12  $p E_{p+1}(z) + z E_p(z) = e^{-z}.$

8.19.13  $\frac{d}{dz} E_p(z) = -E_{p-1}(z),$

8.19.14  $\frac{d}{dz} (e^z E_p(z)) = e^z E_p(z) \left( 1 + \frac{p-1}{z} \right) - \frac{1}{z}.$

**p-Derivatives**

For  $j = 1, 2, 3, \dots$ ,

8.19.15 
$$\frac{\partial^j E_p(z)}{\partial p^j} = (-1)^j \int_1^{\infty} (\ln t)^j t^{-p} e^{-zt} dt, \quad \Re z > 0.$$

For properties and numerical tables see Milgram (1985), and also (when  $p = 1$ ) MacLeod (2002b).

**8.19(vi) Relation to Confluent Hypergeometric Function**

8.19.16  $E_p(z) = z^{p-1} e^{-z} U(p, p, z).$

For  $U(a, b, z)$  see §13.2(i).

**8.19(vii) Continued Fraction**

$$8.19.17 \quad E_p(z) = e^{-z} \left( \frac{1}{z+} \frac{p}{1+} \frac{1}{z+} \frac{p+1}{1+} \frac{2}{z+} \cdots \right),$$

$|\operatorname{ph} z| < \pi.$

See also Cuyt *et al.* (2008, pp. 277–285).

**8.19(viii) Analytic Continuation**

The general function  $E_p(z)$  is attained by extending the path in (8.19.2) across the negative real axis. Unless  $p$  is a nonpositive integer,  $E_p(z)$  has a branch point at  $z = 0$ . For  $z \neq 0$  each branch of  $E_p(z)$  is an entire function of  $p$ .

$$8.19.18 \quad E_p(z e^{2m\pi i}) = \frac{2\pi i e^{mp\pi i} \sin(mp\pi)}{\Gamma(p) \sin(p\pi)} z^{p-1} + E_p(z),$$

$m \in \mathbb{Z}, z \neq 0.$

**8.19(ix) Inequalities**

For  $n = 1, 2, 3, \dots$  and  $x > 0$ ,

$$8.19.19 \quad \frac{n-1}{n} E_n(x) < E_{n+1}(x) < E_n(x),$$

$$8.19.20 \quad (E_n(x))^2 < E_{n-1}(x) E_{n+1}(x),$$

$$8.19.21 \quad \frac{1}{x+n} < e^x E_n(x) \leq \frac{1}{x+n-1},$$

$$8.19.22 \quad \frac{d}{dx} \frac{E_n(x)}{E_{n-1}(x)} > 0.$$

**8.19(x) Integrals**

$$8.19.23 \quad \int_z^\infty E_{p-1}(t) dt = E_p(z), \quad |\operatorname{ph} z| < \pi,$$

$$8.19.24 \quad \int_0^\infty e^{-at} E_n(t) dt = \frac{(-1)^{n-1}}{a^n} \left( \ln(1+a) + \sum_{k=1}^{n-1} \frac{(-1)^k a^k}{k} \right),$$

$n = 1, 2, \dots, \Re a > -1,$

$$8.19.25 \quad \int_0^\infty e^{-at} t^{b-1} E_p(t) dt = \frac{\Gamma(b)(1+a)^{-b}}{p+b-1} \times F(1, b; p+b; a/(1+a)),$$

$\Re a > -1, \Re(p+b) > 1.$

$$8.19.26 \quad \int_0^\infty E_p(t) E_q(t) dt = \frac{L(p) + L(q)}{p+q-1},$$

$p > 0, q > 0, p+q > 1,$

where

$$8.19.27 \quad L(p) = \int_0^\infty e^{-t} E_p(t) dt = \frac{1}{2p} F(1, 1; 1+p; \tfrac{1}{2}), \quad p > 0.$$

For the hypergeometric function  $F(a, b; c; z)$  see §15.2(i). When  $p = 1, 2, 3, \dots$ ,  $L(p)$  can also be evaluated via (8.19.24).

For collections of integrals involving  $E_p(z)$ , especially for integer  $p$ , see Apelblat (1983, §§7.1–7.2) and LeCaine (1945).

**8.19(xi) Further Generalizations**

For higher-order generalized exponential integrals see Meijer and Baken (1987) and Milgram (1985).

**8.20 Asymptotic Expansions of  $E_p(z)$** **8.20(i) Large  $z$** **8.20.1**

$$E_p(z) = \frac{e^{-z}}{z} \left( \sum_{k=0}^{n-1} (-1)^k \frac{(p)_k}{z^k} + (-1)^n \frac{(p)_n e^z}{z^{n-1}} E_{n+p}(z) \right),$$

$n = 1, 2, 3, \dots$

As  $z \rightarrow \infty$

$$8.20.2 \quad E_p(z) \sim \frac{e^{-z}}{z} \sum_{k=0}^{\infty} (-1)^k \frac{(p)_k}{z^k}, \quad |\operatorname{ph} z| \leq \frac{3}{2}\pi - \delta,$$

and

$$8.20.3 \quad E_p(z) \sim \pm \frac{2\pi i}{\Gamma(p)} e^{\mp p\pi i} z^{p-1} + \frac{e^{-z}}{z} \sum_{k=0}^{\infty} \frac{(-1)^k (p)_k}{z^k},$$

$\frac{1}{2}\pi + \delta \leq \pm \operatorname{ph} z \leq \frac{7}{2}\pi - \delta,$

$\delta$  again denoting an arbitrary small positive constant. Where the sectors of validity of (8.20.2) and (8.20.3) overlap the contribution of the first term on the right-hand side of (8.20.3) is exponentially small compared to the other contribution; compare §2.11(ii).

For an exponentially-improved asymptotic expansion of  $E_p(z)$  see §2.11(iii).

**8.20(ii) Large  $p$** 

For  $x \geq 0$  and  $p > 1$  let  $x = \lambda p$  and define  $A_0(\lambda) = 1$ ,

$$8.20.4 \quad A_{k+1}(\lambda) = (1 - 2k\lambda)A_k(\lambda) + \lambda(\lambda + 1) \frac{dA_k(\lambda)}{d\lambda},$$

$k = 0, 1, 2, \dots,$

so that  $A_k(\lambda)$  is a polynomial in  $\lambda$  of degree  $k-1$  when  $k \geq 1$ . In particular,

**8.20.5**

$$A_1(\lambda) = 1, \quad A_2(\lambda) = 1 - 2\lambda, \quad A_3(\lambda) = 1 - 8\lambda + 6\lambda^2.$$

Then as  $p \rightarrow \infty$

$$8.20.6 \quad E_p(\lambda p) \sim \frac{e^{-\lambda p}}{(\lambda + 1)^p} \sum_{k=0}^{\infty} \frac{A_k(\lambda)}{(\lambda + 1)^{2k}} \frac{1}{p^k},$$

uniformly for  $\lambda \in [0, \infty)$ .

For further information, including extensions to complex values of  $x$  and  $p$ , see Temme (1994a, §4) and Dunster (1996b, 1997).

## 8.21 Generalized Sine and Cosine Integrals

### 8.21(i) Definitions: General Values

With  $\gamma$  and  $\Gamma$  denoting here the general values of the incomplete gamma functions (§8.2(i)), we define

$$8.21.1 \quad \text{ci}(a, z) \pm i \text{si}(a, z) = e^{\pm \frac{1}{2}\pi i a} \Gamma\left(a, ze^{\mp \frac{1}{2}\pi i}\right),$$

$$8.21.2 \quad \text{Ci}(a, z) \pm i \text{Si}(a, z) = e^{\pm \frac{1}{2}\pi i a} \gamma\left(a, ze^{\mp \frac{1}{2}\pi i}\right).$$

From §§8.2(i) and 8.2(ii) it follows that each of the four functions  $\text{si}(a, z)$ ,  $\text{ci}(a, z)$ ,  $\text{Si}(a, z)$ , and  $\text{Ci}(a, z)$  is a multivalued function of  $z$  with branch point at  $z = 0$ . Furthermore,  $\text{si}(a, z)$  and  $\text{ci}(a, z)$  are entire functions of  $a$ , and  $\text{Si}(a, z)$  and  $\text{Ci}(a, z)$  are meromorphic functions of  $a$  with simple poles at  $a = -1, -3, -5, \dots$  and  $a = 0, -2, -4, \dots$ , respectively.

### 8.21(ii) Definitions: Principal Values

When  $\text{ph } z = 0$  (and when  $a \neq -1, -3, -5, \dots$ , in the case of  $\text{Si}(a, z)$ , or  $a \neq 0, -2, -4, \dots$ , in the case of  $\text{Ci}(a, z)$ ) the *principal values* of  $\text{si}(a, z)$ ,  $\text{ci}(a, z)$ ,  $\text{Si}(a, z)$ , and  $\text{Ci}(a, z)$  are defined by (8.21.1) and (8.21.2) with the incomplete gamma functions assuming their principal values (§8.2(i)). Elsewhere in the sector  $|\text{ph } z| \leq \pi$  the principal values are defined by analytic continuation from  $\text{ph } z = 0$ ; compare §4.2(i).

From here on it is assumed that *unless indicated otherwise* the functions  $\text{si}(a, z)$ ,  $\text{ci}(a, z)$ ,  $\text{Si}(a, z)$ , and  $\text{Ci}(a, z)$  have their principal values.

Properties of the four functions that are stated below in §§8.21(iii) and 8.21(iv) follow directly from the definitions given above, together with properties of the incomplete gamma functions given earlier in this chapter. In the case of §8.21(iv) the equation

$$8.21.3 \quad \int_0^\infty t^{a-1} e^{\pm it} dt = e^{\pm \frac{1}{2}\pi i a} \Gamma(a), \quad 0 < \Re a < 1,$$

(obtained from (5.2.1) by rotation of the integration path) is also needed.

### 8.21(iii) Integral Representations

$$8.21.4 \quad \text{si}(a, z) = \int_z^\infty t^{a-1} \sin t dt, \quad \Re a < 1,$$

$$8.21.5 \quad \text{ci}(a, z) = \int_z^\infty t^{a-1} \cos t dt, \quad \Re a < 1,$$

$$8.21.6 \quad \text{Si}(a, z) = \int_0^z t^{a-1} \sin t dt, \quad \Re a > -1,$$

$$8.21.7 \quad \text{Ci}(a, z) = \int_0^z t^{a-1} \cos t dt, \quad \Re a > 0.$$

In these representations the integration paths do not cross the negative real axis, and in the case of (8.21.4) and (8.21.5) the paths also exclude the origin.

### 8.21(iv) Interrelations

#### 8.21.8

$$\text{Si}(a, z) = \Gamma(a) \sin\left(\frac{1}{2}\pi a\right) - \text{si}(a, z), \quad a \neq -1, -3, -5, \dots,$$

#### 8.21.9

$$\text{Ci}(a, z) = \Gamma(a) \cos\left(\frac{1}{2}\pi a\right) - \text{ci}(a, z), \quad a \neq 0, -2, -4, \dots$$

### 8.21(v) Special Values

$$8.21.10 \quad \text{si}(0, z) = -\text{si}(z), \quad \text{ci}(0, z) = -\text{Ci}(z),$$

$$8.21.11 \quad \text{Si}(0, z) = \text{Si}(z).$$

For the functions on the right-hand sides of (8.21.10) and (8.21.11) see §6.2(ii).

$$8.21.12 \quad \text{Si}(a, \infty) = \Gamma(a) \sin\left(\frac{1}{2}\pi a\right), \quad a \neq -1, -3, -5, \dots,$$

$$8.21.13 \quad \text{Ci}(a, \infty) = \Gamma(a) \cos\left(\frac{1}{2}\pi a\right), \quad a \neq 0, -2, -4, \dots$$

### 8.21(vi) Series Expansions

#### Power-Series Expansions

$$8.21.14 \quad \text{Si}(a, z) = z^a \sum_{k=0}^{\infty} \frac{(-1)^k z^{2k+1}}{(2k+a+1)(2k+1)!},$$

$$a \neq -1, -3, -5, \dots,$$

#### 8.21.15

$$\text{Ci}(a, z) = z^a \sum_{k=0}^{\infty} \frac{(-1)^k z^{2k}}{(2k+a)(2k)!}, \quad a \neq 0, -2, -4, \dots$$

#### Spherical-Bessel-Function Expansions

$$8.21.16 \quad \text{Si}(a, z) = z^a \sum_{k=0}^{\infty} \frac{(2k + \frac{3}{2})(1 - \frac{1}{2}a)_k}{(\frac{1}{2} + \frac{1}{2}a)_{k+1}} j_{2k+1}(z),$$

$$a \neq -1, -3, -5, \dots,$$

$$8.21.17 \quad \text{Ci}(a, z) = z^a \sum_{k=0}^{\infty} \frac{(2k + \frac{1}{2})(\frac{1}{2} - \frac{1}{2}a)_k}{(\frac{1}{2}a)_{k+1}} j_{2k}(z),$$

$$a \neq 0, -2, -4, \dots$$

For  $j_n(z)$  see §10.47(ii). For (8.21.16), (8.21.17), and further expansions in series of Bessel functions see Luke (1969b, pp. 56–57).

### 8.21(vii) Auxiliary Functions

8.21.18  $f(a, z) = \operatorname{si}(a, z) \cos z - \operatorname{ci}(a, z) \sin z,$

8.21.19  $g(a, z) = \operatorname{si}(a, z) \sin z + \operatorname{ci}(a, z) \cos z.$

8.21.20  $\operatorname{si}(a, z) = f(a, z) \cos z + g(a, z) \sin z,$

8.21.21  $\operatorname{ci}(a, z) = -f(a, z) \sin z + g(a, z) \cos z.$

When  $|\operatorname{ph} z| < \pi$  and  $\Re a < 1,$

8.21.22 
$$f(a, z) = \int_0^\infty \frac{\sin t}{(t+z)^{1-a}} dt,$$

8.21.23 
$$g(a, z) = \int_0^\infty \frac{\cos t}{(t+z)^{1-a}} dt.$$

When  $|\operatorname{ph} z| < \frac{1}{2}\pi,$

8.21.24 
$$f(a, z) = \frac{z^a}{2} \int_0^\infty ((1+it)^{a-1} + (1-it)^{a-1}) e^{-zt} dt,$$

8.21.25 
$$g(a, z) = \frac{z^a}{2i} \int_0^\infty ((1-it)^{a-1} - (1+it)^{a-1}) e^{-zt} dt.$$

### 8.21(viii) Asymptotic Expansions

When  $z \rightarrow \infty$  with  $|\operatorname{ph} z| \leq \pi - \delta (< \pi),$

8.21.26 
$$f(a, z) \sim z^{a-1} \sum_{k=0}^\infty \frac{(-1)^k (1-a)_{2k}}{z^{2k}},$$

8.21.27 
$$g(a, z) \sim z^{a-1} \sum_{k=0}^\infty \frac{(-1)^k (1-a)_{2k+1}}{z^{2k+1}}.$$

For the corresponding expansions for  $\operatorname{si}(a, z)$  and  $\operatorname{ci}(a, z)$  apply (8.21.20) and (8.21.21).

## Applications

### 8.22 Mathematical Applications

#### 8.22(i) Terminant Function

The so-called *terminant function*  $F_p(z),$  defined by

8.22.1 
$$F_p(z) = \frac{\Gamma(p)}{2\pi} z^{1-p} E_p(z) = \frac{\Gamma(p)}{2\pi} \Gamma(1-p, z),$$

plays a fundamental role in re-expansions of remainder terms in asymptotic expansions, including exponentially-improved expansions and a smooth interpretation of the Stokes phenomenon. See §§2.11(ii)–2.11(v) and the references supplied in these subsections.

#### 8.22(ii) Riemann Zeta Function and Incomplete Riemann Zeta Function

The function  $\Gamma(a, z),$  with  $|\operatorname{ph} a| \leq \frac{1}{2}\pi$  and  $\operatorname{ph} z = \frac{1}{2}\pi,$  has an intimate connection with the Riemann zeta function  $\zeta(s)$  (§25.2(i)) on the critical line  $\Re s = \frac{1}{2}.$  See Paris and Cang (1997).

If  $\zeta_x(s)$  denotes the *incomplete Riemann zeta function* defined by

8.22.2 
$$\zeta_x(s) = \frac{1}{\Gamma(s)} \int_0^x \frac{t^{s-1}}{e^t - 1} dt, \quad \Re s > 1,$$

so that  $\lim_{x \rightarrow \infty} \zeta_x(s) = \zeta(s),$  then

8.22.3 
$$\zeta_x(s) = \sum_{k=1}^\infty k^{-s} P(s, kx), \quad \Re s > 1.$$

For further information on  $\zeta_x(s),$  including zeros and uniform asymptotic approximations, see Kölbig (1970, 1972a) and Dunster (2006).

### 8.23 Statistical Applications

The functions  $P(a, x)$  and  $Q(a, x)$  are used extensively in statistics as the probability integrals of the gamma distribution; see Johnson *et al.* (1994, pp. 337–414). Particular forms are the chi-square distribution functions; see Johnson *et al.* (1994, pp. 415–493). The function  $B_x(a, b)$  and its normalization  $I_x(a, b)$  play a similar role in statistics in connection with the beta distribution; see Johnson *et al.* (1995, pp. 210–275). In queueing theory the Erlang loss function is used, which can be expressed in terms of the reciprocal of  $Q(a, x);$  see Jagerman (1974) and Cooper (1981, pp. 80, 316–319).

### 8.24 Physical Applications

#### 8.24(i) Incomplete Gamma Functions

The function  $\gamma(a, x)$  appears in: discussions of power-law relaxation times in complex physical systems (Sornette (1998)); logarithmic oscillations in relaxation times for proteins (Metzler *et al.* (1999)); Gaussian orbitals and exponential (Slater) orbitals in quantum chemistry (Shavitt (1963), Shavitt and Karplus (1965)); population biology and ecological systems (Camacho *et al.* (2002)).

#### 8.24(ii) Incomplete Beta Functions

The function  $I_x(a, b)$  appears in: Monte Carlo sampling in statistical mechanics (Kofke (2004)); analysis of packings of soft or granular objects (Prellberg and Owczarek (1995)); growth formulas in cosmology (Hamilton (2001)).

### 8.24(iii) Generalized Exponential Integral

The function  $E_p(x)$ , with  $p > 0$ , appears in theories of transport and radiative equilibrium (Hopf (1934), Kourganoff (1952), Altaç (1996)).

With more general values of  $p$ ,  $E_p(x)$  supplies fundamental auxiliary functions that are used in the computation of molecular electronic integrals in quantum chemistry (Harris (2002), Shavitt (1963)), and also wave acoustics of overlapping sound beams (Ding (2000)).

## Computation

### 8.25 Methods of Computation

#### 8.25(i) Series Expansions

Although the series expansions in §§8.7, 8.19(iv), and 8.21(vi) converge for all finite values of  $z$ , they are cumbersome to use when  $|z|$  is large owing to slowness of convergence and cancellation. For large  $|z|$  the corresponding asymptotic expansions (generally divergent) are used instead. See also Luke (1975, pp. 101–102) and Temme (1994a).

#### 8.25(ii) Quadrature

See Allasia and Besenghi (1987a) for the numerical computation of  $\Gamma(a, z)$  from (8.6.4) by means of the trapezoidal rule.

#### 8.25(iii) Asymptotic Expansions

DiDonato and Morris (1986) describes an algorithm for computing  $P(a, x)$  and  $Q(a, x)$  for  $a \geq 0$ ,  $x \geq 0$ , and  $a + x \neq 0$  from the uniform expansions in §8.12. The algorithm supplies 14S accuracy. A numerical inversion procedure is also given for calculating the value of  $x$  (with 10S accuracy), when  $a$  and  $P(a, x)$  are specified, based on Newton's rule (§3.8(ii)). See also Temme (1987, 1994a).

#### 8.25(iv) Continued Fractions

The computation of  $\gamma(a, z)$  and  $\Gamma(a, z)$  by means of continued fractions is described in Jones and Thron (1985) and Gautschi (1979a, §§4.3, 5). See also Jacobsen *et al.* (1986) and Temme (1996a, p. 280).

### 8.25(v) Recurrence Relations

Expansions involving incomplete gamma functions often require the generation of sequences  $P(a + n, x)$ ,  $Q(a + n, x)$ , or  $\gamma^*(a + n, x)$  for fixed  $a$  and  $n = 0, 1, 2, \dots$ . An efficient procedure, based partly on the recurrence relations (8.8.5) and (8.8.6), is described in Gautschi (1979a, 1999).

Stable recursive schemes for the computation of  $E_p(x)$  are described in Miller (1960) for  $x > 0$  and integer  $p$ . For  $x > 0$  and real  $p$  see Amos (1980) and Chiccoli *et al.* (1987, 1988). See also Chiccoli *et al.* (1990) and Stegun and Zucker (1974).

### 8.26 Tables

#### 8.26(i) Introduction

For tables published before 1961 see Fletcher *et al.* (1962) and Lebedev and Fedorova (1960).

#### 8.26(ii) Incomplete Gamma Functions

- Khamis (1965) tabulates  $P(a, x)$  for  $a = 0.05(.05)10(.1)20(.25)70$ ,  $0.0001 \leq x \leq 250$  to 10D.
- Pagurova (1963) tabulates  $P(a, x)$  and  $Q(a, x)$  (with different notation) for  $a = 0(.05)3$ ,  $x = 0(.05)1$  to 7D.
- Pearson (1965) tabulates the function  $I(u, p)$  ( $= P(p + 1, u)$ ) for  $p = -1(.05)0(.1)5(.2)50$ ,  $u = 0(.1)u_p$  to 7D, where  $I(u, u_p)$  rounds off to 1 to 7D; also  $I(u, p)$  for  $p = -0.75(.01) - 1$ ,  $u = 0(.1)6$  to 5D.
- Zhang and Jin (1996, Table 3.8) tabulates  $\gamma(a, x)$  for  $a = 0.5, 1, 3, 5, 10, 25, 50, 100$ ,  $x = 0(.1)1(1)3, 5(5)30, 50, 100$  to 8D or 8S.

#### 8.26(iii) Incomplete Beta Functions

- Pearson (1968) tabulates  $I_x(a, b)$  for  $x = 0.01(.01)1$ ,  $a, b = 0.5(.5)11(1)50$ , with  $b \leq a$ , to 7D.
- Zhang and Jin (1996, Table 3.9) tabulates  $I_x(a, b)$  for  $x = 0(.05)1$ ,  $a = 0.5, 1, 3, 5, 10$ ,  $b = 1, 10$  to 8D.

#### 8.26(iv) Generalized Exponential Integral

- Abramowitz and Stegun (1964, pp. 245–248) tabulates  $E_n(x)$  for  $n = 2, 3, 4, 10, 20$ ,  $x = 0(.01)2$  to 7D; also  $(x + n)e^x E_n(x)$  for  $n = 2, 3, 4, 10, 20$ ,  $x^{-1} = 0(.01)0.1(.05)0.5$  to 6S.

- Chiccoli *et al.* (1988) presents a short table of  $E_p(x)$  for  $p = -\frac{9}{2}(1) - \frac{1}{2}$ ,  $0 \leq x \leq 200$  to 14S.
- Pagurova (1961) tabulates  $E_n(x)$  for  $n = 0(1)20$ ,  $x = 0(.01)2(.1)10$  to 4-9S;  $e^x E_n(x)$  for  $n = 2(1)10$ ,  $x = 10(.1)20$  to 7D;  $e^x E_p(x)$  for  $p = 0(.1)1$ ,  $x = 0.01(.01)7(.05)12(.1)20$  to 7S or 7D.
- Stankiewicz (1968) tabulates  $E_n(x)$  for  $n = 1(1)10$ ,  $x = 0.01(.01)5$  to 7D.
- Zhang and Jin (1996, Table 19.1) tabulates  $E_n(x)$  for  $n = 1, 2, 3, 5, 10, 15, 20$ ,  $x = 0(.1)1, 1.5, 2, 3, 5, 10, 20, 30, 50, 100$  to 7D or 8S.

## 8.27 Approximations

### 8.27(i) Incomplete Gamma Functions

- DiDonato (1978) gives a simple approximation for the function  $F(p, x) = x^{-p} e^{x^2/2} \int_x^\infty e^{-t^2/2} t^p dt$  (which is related to the incomplete gamma function by a change of variables) for real  $p$  and large positive  $x$ . This takes the form  $F(p, x) = 4x/h(p, x)$ , approximately, where  $h(p, x) = 3(x^2 - p) + \sqrt{(x^2 - p)^2 + 8(x^2 + p)}$  and is shown to produce an absolute error  $O(x^{-7})$  as  $x \rightarrow \infty$ .
- Luke (1975, §4.3) gives Padé approximation methods, combined with a detailed analysis of the error terms, valid for real and complex variables except on the negative real  $z$ -axis. See also Temme (1994a, §3).
- Luke (1969b, pp. 25, 40–41) gives Chebyshev-series expansions for  $\Gamma(a, \omega z)$  (by specifying parameters) with  $1 \leq \omega < \infty$ , and  $\gamma(a, \omega z)$  with  $0 \leq \omega \leq 1$ ; see also Temme (1994a, §3).
- Luke (1969b, p. 186) gives hypergeometric polynomial representations that converge uniformly on compact subsets of the  $z$ -plane that exclude  $z = 0$  and are valid for  $|\operatorname{ph} z| < \pi$ .

### 8.27(ii) Generalized Exponential Integral

- Luke (1975, p. 103) gives Chebyshev-series expansions for  $E_1(x)$  and related functions for  $x \geq 5$ .
- Luke (1975, p. 106) gives rational and Padé approximations, with remainders, for  $E_1(z)$  and  $z^{-1} \int_0^z t^{-1}(1 - e^{-t}) dt$  for complex  $z$  with  $|\operatorname{ph} z| \leq \pi$ .
- Verbeeck (1970) gives polynomial and rational approximations for  $E_p(x) = (e^{-x}/x)P(z)$ , approximately, where  $P(z)$  denotes a quotient of polynomials of equal degree in  $z = x^{-1}$ .

## 8.28 Software

See <http://dlmf.nist.gov/8.28>.

## References

### General References

The main references used in writing this chapter are Erdélyi *et al.* (1953b), Luke (1969b), and Temme (1996a). For additional bibliographic reading see Gautschi (1998), Olver (1997b), and Wong (1989).

### Sources

The following list gives the references or other indications of proofs that were used in constructing the various sections of this chapter. These sources supplement the references that are quoted in the text.

- §8.2 Olver (1997b, p. 45), Temme (1996b). (8.2.12)–(8.2.14) follow from the definitions in §8.2(i).
- §8.3 The graphics were produced at NIST.
- §8.4 Erdélyi *et al.* (1953b, Chapter 9). (8.4.14) follows from (8.4.6) and (8.8.6). (8.4.15) follows from the first series in (8.7.3) by combining  $\Gamma(a)$  with the term  $k = n$  of the series, then taking the limit as  $a \rightarrow -n$ .
- §8.5 Slater (1960, §5.6) and §13.2(vii). For (8.5.4) see (13.18.4).
- §8.6 For (8.6.1) use (8.6.8), replacing  $t$  by  $e^{it}$  with  $-\pi \leq t \leq \pi$ . For (8.6.2) substitute for  $J_a(2\sqrt{zt})$  by (10.2.2), integrate term by term and refer to (8.7.1) and (8.2.6). (8.6.6) may be proved in a similar manner with the aid also of (10.25.2), (10.27.4), (8.2.3), and analytic continuation when  $a = -2, -3, -4, \dots$ . For (8.6.3) and (8.6.7) apply (8.2.1) and (8.2.2), taking new integration variables  $ze^{\mp t}$ . For (8.6.4) and (8.6.5) see Temme (1996a, §§11.2.1–11.2.2). For (8.6.8) assume temporarily  $\Re a > 0$ , collapse the integration path onto the interval  $[-1, 0]$  and use (8.2.1). For (8.6.9) see Temme (1996b). For (8.6.10)–(8.6.12) see Paris and Kaminski (2001, §3.4.3).
- §8.7 Erdélyi *et al.* (1953b, Chapter 9). (8.7.3) follows from (8.7.1) and (8.2.3). For (8.7.5) use (8.5.2) and (13.11.1).
- §8.8 Erdélyi *et al.* (1953b, Chapter 9). These results also follow straightforwardly from §8.2(i).



- §8.10** Olver (1997b, pp. 66–67), Luke (1969b, pp. 195, 201). For (8.10.10)–(8.10.13), see Gautschi (1959b), Alzer (1997b), and Vietoris (1983).
- §8.11** Olver (1997b, pp. 66, 109–112), Temme (1996a, p. 280). For (8.11.4) see (8.5.1) or (8.7.1). (8.11.5) follows from the leading terms of (8.11.4) and (5.11.3). For (8.11.6) and (8.11.7) see Gautschi (1959a) and Temme (1994a). (8.11.12) can be obtained from (8.12.15), (8.2.4), and (5.11.3). (8.11.15) follows from (8.4.7) with  $z = nx$ . For (8.11.16) see Ramanujan (1962, pp. 323–324). For (8.11.17) see Copson (1933).
- §8.12** Temme (1979b, 1992a, 1996b), Paris (2002b), and Ferreira *et al.* (2005).
- §8.13** Erdélyi *et al.* (1953b, §9.6), Tricomi (1950b), Lew (1994), and Kölbig (1972b).
- §8.14** (8.14.1)–(8.14.2) are obtained by term-by-term integration using (8.7.1) and (8.7.3). (8.14.3)–(8.14.6) are obtained by specializing (13.10.10), (13.10.11), (13.10.3), (13.10.4) by means of (8.5.1)–(8.5.3).
- §8.15** Tricomi (1950b).
- §8.17** Temme (1996a, §§11.3–11.3.2). For (8.17.5) combine (8.17.8) and (15.8.1). For (8.17.6) combine (8.17.8), (15.8.18), and (15.8.1). For the last paragraph of §8.17(v) see Zhang and Jin (1996, p. 65).
- §8.18** Temme (1996a, §§11.3.3.1–11.3.3.3). For (8.18.1) use (8.17.9) and apply §15.12(ii).
- §8.19** For (8.19.1)–(8.19.4) see Temme (1996a, p. 180). For (8.19.5)–(8.19.7) use (8.19.1), (8.19.3), (8.4.15). (8.19.8) follows from (8.4.13) and (8.4.15). (8.19.9) follows from (6.6.3), (8.19.1), and (8.4.15). (8.19.10) and (8.19.11) follow from (8.19.1) and (8.7.3). For (8.19.12)–(8.19.16) combine (8.19.1) with (8.8.2), (8.8.16), (8.8.19), and (8.5.3). For (8.19.17) combine (8.9.2) and (8.19.1). For (8.19.18) see Olver (1994b). For (8.19.19)–(8.19.22) see Hopf (1934, pp. 26–27). For (8.19.23) use (8.19.13). For (8.19.24)–(8.19.27) see Kourganoff (1952, Appendix 1). The graphics were produced at NIST.
- §8.20** Olver (1991a), Gautschi (1959a).
- §8.21** For §8.21(iii) follow the prescription given in the final paragraph of §8.21(ii). Thus for (8.21.4) and (8.21.5) replace  $z$  by  $iz$  with  $\text{ph } z = 0$  in (8.2.2), deform the path of integration to run along the positive imaginary axis, and replace  $t$  by  $it$ . Then extend to the sector  $|\text{ph } z| \leq \pi$  by analytic continuation. Similarly for (8.21.6) and (8.21.7). For §8.21(iv) temporarily restrict  $0 < \Re a < 1$ . Then (8.21.8) and (8.21.9) follow immediately from (8.21.3)–(8.21.7). Subsequently, ease the restrictions on  $a$  by analytic continuation with respect to  $a$ ; compare §8.21(i). For (8.21.12) and (8.21.13) use (8.21.8) and (8.21.9), and also (8.21.4) and (8.21.5). (8.21.14) and (8.21.15) are obtained by expansion of the trigonometric functions in (8.21.6), (8.21.7), and termwise integration. See also Luke (1975, p. 115). (8.21.22) and (8.21.23) follow from (8.21.4), (8.21.5), (8.21.18), and (8.21.19). For (8.21.24) and (8.21.25) assume  $\text{ph } z = 0$ , and in the integrals for  $\text{ci}(a, z) \pm i \text{si}(a, z)$  obtained from (8.21.4) and (8.21.5) set  $t = (1 + \tau)z$ , rotate the integration paths in the  $\tau$ -plane through  $\pm \frac{1}{2}\pi$ , and apply (8.21.18) and (8.21.19). The restriction  $\text{ph } z = 0$  is eased to  $|\text{ph } z| < \frac{1}{2}\pi$  by analytic continuation. For (8.21.26) and (8.21.27) apply Watson’s lemma to (8.21.24) and (8.21.25), and then extend the sector of validity from  $|\text{ph } z| \leq \frac{1}{2}\pi - \delta$  to  $|\text{ph } z| \leq \pi - \delta$ ; see §2.4(i).

## Chapter 9

# Airy and Related Functions

F. W. J. Olver<sup>1</sup>

<b>Notation</b>	<b>194</b>	<b>Related Functions</b>	<b>204</b>
9.1 Special Notation . . . . .	194	9.12 Scorer Functions . . . . .	204
<b>Airy Functions</b>	<b>194</b>	9.13 Generalized Airy Functions . . . . .	206
9.2 Differential Equation . . . . .	194	9.14 Incomplete Airy Functions . . . . .	208
9.3 Graphics . . . . .	195	<b>Applications</b>	<b>208</b>
9.4 Maclaurin Series . . . . .	196	9.15 Mathematical Applications . . . . .	208
9.5 Integral Representations . . . . .	196	9.16 Physical Applications . . . . .	209
9.6 Relations to Other Functions . . . . .	196	<b>Computation</b>	<b>209</b>
9.7 Asymptotic Expansions . . . . .	198	9.17 Methods of Computation . . . . .	209
9.8 Modulus and Phase . . . . .	199	9.18 Tables . . . . .	210
9.9 Zeros . . . . .	200	9.19 Approximations . . . . .	211
9.10 Integrals . . . . .	202	9.20 Software . . . . .	212
9.11 Products . . . . .	203	<b>References</b>	<b>212</b>

<sup>1</sup>Institute for Physical Science and Technology and Department of Mathematics, University of Maryland, College Park, Maryland.

**Acknowledgments:** This chapter is based in part on Abramowitz and Stegun (1964, Chapter 10) by H. A. Antosiewicz. The author is pleased to acknowledge the assistance of Bruce R. Fabijonas for computing the numerical tables in §9.9, and of Leonard Maximon for writing §9.16.

Copyright © 2009 National Institute of Standards and Technology. All rights reserved.

## Notation

### 9.1 Special Notation

(For other notation see pp. xiv and 873.)

$k$	nonnegative integer, except in §9.9(iii).
$x$	real variable.
$z(= x + iy)$	complex variable.
$\delta$	arbitrary small positive constant.
primes	derivatives with respect to argument.

The main functions treated in this chapter are the Airy functions  $\text{Ai}(z)$  and  $\text{Bi}(z)$ , and the Scorer functions  $\text{Gi}(z)$  and  $\text{Hi}(z)$  (also known as inhomogeneous Airy functions).

Other notations that have been used are as follows:  $\text{Ai}(-x)$  and  $\text{Bi}(-x)$  for  $\text{Ai}(x)$  and  $\text{Bi}(x)$  (Jeffreys (1928), later changed to  $\text{Ai}(x)$  and  $\text{Bi}(x)$ );  $U(x) = \sqrt{\pi} \text{Bi}(x)$ ,  $V(x) = \sqrt{\pi} \text{Ai}(x)$  (Fock (1945));  $A(x) = 3^{-1/3} \pi \text{Ai}(-3^{-1/3}x)$  (Szegő (1967, §1.81));  $e_0(x) = \pi \text{Hi}(-x)$ ,  $\tilde{e}_0(x) = -\pi \text{Gi}(-x)$  (Tumarkin (1959)).

## Airy Functions

### 9.2 Differential Equation

#### 9.2(i) Airy's Equation

$$9.2.1 \quad \frac{d^2 w}{dz^2} = zw.$$

All solutions are entire functions of  $z$ .

Standard solutions are:

$$9.2.2 \quad w = \text{Ai}(z), \text{Bi}(z), \text{Ai}(ze^{\mp 2\pi i/3}).$$

#### 9.2(ii) Initial Values

$$9.2.3 \quad \text{Ai}(0) = \frac{1}{3^{2/3} \Gamma(\frac{2}{3})} = 0.35502\ 80538\dots,$$

$$9.2.4 \quad \text{Ai}'(0) = -\frac{1}{3^{1/3} \Gamma(\frac{1}{3})} = -0.25881\ 94037\dots,$$

$$9.2.5 \quad \text{Bi}(0) = \frac{1}{3^{1/6} \Gamma(\frac{2}{3})} = 0.61492\ 66274\dots,$$

$$9.2.6 \quad \text{Bi}'(0) = \frac{3^{1/6}}{\Gamma(\frac{1}{3})} = 0.44828\ 83573\dots$$

#### 9.2(iii) Numerically Satisfactory Pairs of Solutions

Table 9.2.1 lists numerically satisfactory pairs of solutions of (9.2.1) for the stated regions; compare §2.7(iv).

Table 9.2.1: Numerically satisfactory solutions of Airy's equation.

Pair	Region
$\text{Ai}(x), \text{Bi}(x)$	$-\infty < x < \infty$
$\text{Ai}(z), \text{Bi}(z)$	$\begin{cases}  \text{ph } z  \leq \frac{1}{3}\pi \\ -\infty < z \leq 0 \end{cases}$
$\text{Ai}(z), \text{Ai}(ze^{-2\pi i/3})$	$-\frac{1}{3}\pi \leq \text{ph } z \leq \pi$
$\text{Ai}(z), \text{Ai}(ze^{2\pi i/3})$	$-\pi \leq \text{ph } z \leq \frac{1}{3}\pi$
$\text{Ai}(ze^{\mp 2\pi i/3})$	$ \text{ph}(-z)  \leq \frac{2}{3}\pi$

#### 9.2(iv) Wronskians

$$9.2.7 \quad \mathscr{W} \{ \text{Ai}(z), \text{Bi}(z) \} = \frac{1}{\pi},$$

$$9.2.8 \quad \mathscr{W} \left\{ \text{Ai}(z), \text{Ai}(ze^{\mp 2\pi i/3}) \right\} = \frac{e^{\pm \pi i/6}}{2\pi},$$

$$9.2.9 \quad \mathscr{W} \left\{ \text{Ai}(ze^{-2\pi i/3}), \text{Ai}(ze^{2\pi i/3}) \right\} = \frac{1}{2\pi i}.$$

#### 9.2(v) Connection Formulas

$$9.2.10 \quad \text{Bi}(z) = e^{-\pi i/6} \text{Ai}(ze^{-2\pi i/3}) + e^{\pi i/6} \text{Ai}(ze^{2\pi i/3}).$$

$$9.2.11 \quad \text{Ai}(ze^{\mp 2\pi i/3}) = \frac{1}{2} e^{\mp \pi i/3} (\text{Ai}(z) \pm i \text{Bi}(z)).$$

9.2.12

$$\text{Ai}(z) + e^{-2\pi i/3} \text{Ai}(ze^{-2\pi i/3}) + e^{2\pi i/3} \text{Ai}(ze^{2\pi i/3}) = 0,$$

9.2.13

$$\text{Bi}(z) + e^{-2\pi i/3} \text{Bi}(ze^{-2\pi i/3}) + e^{2\pi i/3} \text{Bi}(ze^{2\pi i/3}) = 0.$$

$$9.2.14 \quad \text{Ai}(-z) = e^{\pi i/3} \text{Ai}(ze^{\pi i/3}) + e^{-\pi i/3} \text{Ai}(ze^{-\pi i/3}),$$

$$9.2.15 \quad \text{Bi}(-z) = e^{-\pi i/6} \text{Ai}(ze^{\pi i/3}) + e^{\pi i/6} \text{Ai}(ze^{-\pi i/3}).$$

#### 9.2(vi) Riccati Form of Differential Equation

$$9.2.16 \quad \frac{dW}{dz} + W^2 = z,$$

$W = (1/w) dw/dz$ , where  $w$  is any nontrivial solution of (9.2.1). See also Smith (1990).

### 9.3 Graphics

#### 9.3(i) Real Variable

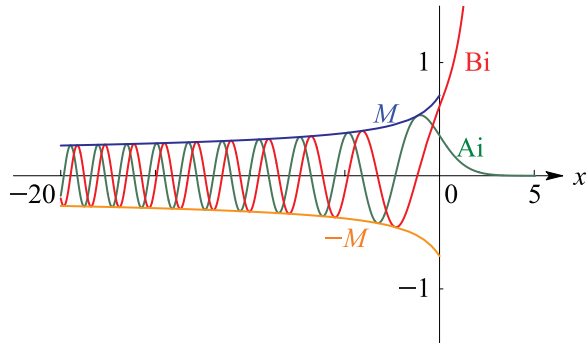


Figure 9.3.1:  $Ai(x)$ ,  $Bi(x)$ ,  $M(x)$ . For  $M(x)$  see §9.8(i).

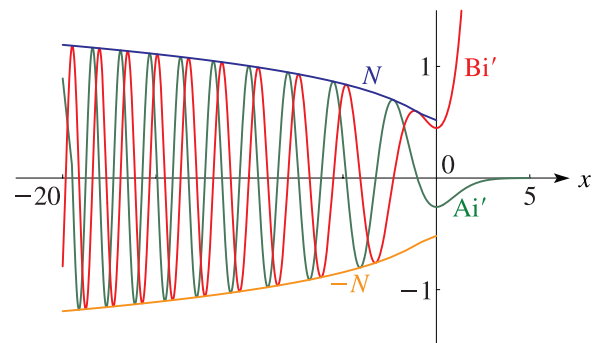


Figure 9.3.2:  $Ai'(x)$ ,  $Bi'(x)$ ,  $N(x)$ . For  $N(x)$  see §9.8(i).

#### 9.3(ii) Complex Variable

In the graphics shown in this subsection, height corresponds to the absolute value of the function and color to the phase. See also p. *xiv*.

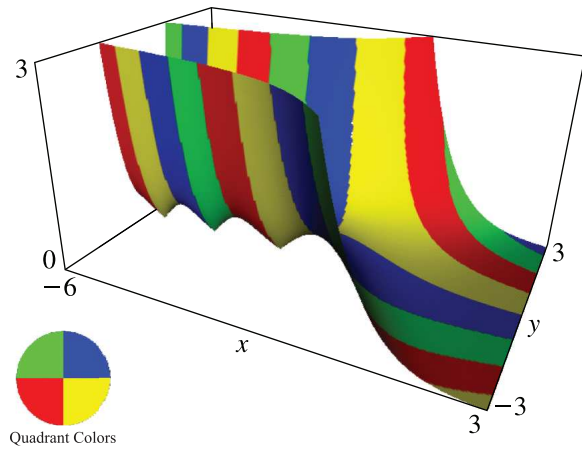


Figure 9.3.3:  $Ai(x + iy)$ .

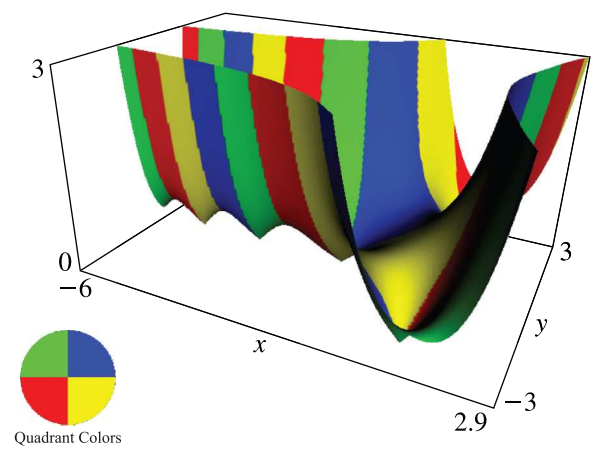


Figure 9.3.4:  $Bi(x + iy)$ .

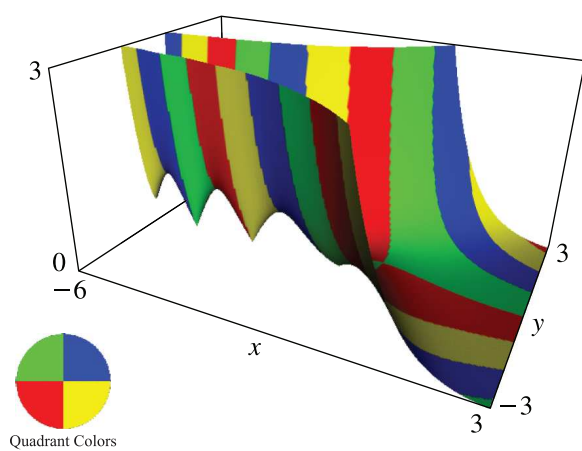


Figure 9.3.5:  $Ai'(x + iy)$ .

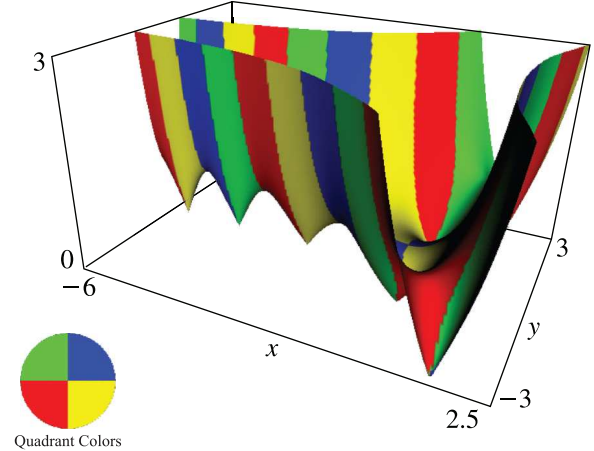


Figure 9.3.6:  $Bi'(x + iy)$ .

## 9.4 Maclaurin Series

For  $z \in \mathbb{C}$

$$9.4.1 \quad \text{Ai}(z) = \text{Ai}(0) \left( 1 + \frac{1}{3!}z^3 + \frac{1 \cdot 4}{6!}z^6 + \frac{1 \cdot 4 \cdot 7}{9!}z^9 + \dots \right) + \text{Ai}'(0) \left( z + \frac{2}{4!}z^4 + \frac{2 \cdot 5}{7!}z^7 + \frac{2 \cdot 5 \cdot 8}{10!}z^{10} + \dots \right),$$

$$9.4.2 \quad \text{Ai}'(z) = \text{Ai}'(0) \left( 1 + \frac{2}{3!}z^3 + \frac{2 \cdot 5}{6!}z^6 + \frac{2 \cdot 5 \cdot 8}{9!}z^9 + \dots \right) + \text{Ai}(0) \left( \frac{1}{2!}z^2 + \frac{1 \cdot 4}{5!}z^5 + \frac{1 \cdot 4 \cdot 7}{8!}z^8 + \dots \right),$$

$$9.4.3 \quad \text{Bi}(z) = \text{Bi}(0) \left( 1 + \frac{1}{3!}z^3 + \frac{1 \cdot 4}{6!}z^6 + \frac{1 \cdot 4 \cdot 7}{9!}z^9 + \dots \right) + \text{Bi}'(0) \left( z + \frac{2}{4!}z^4 + \frac{2 \cdot 5}{7!}z^7 + \frac{2 \cdot 5 \cdot 8}{10!}z^{10} + \dots \right),$$

$$9.4.4 \quad \text{Bi}'(z) = \text{Bi}'(0) \left( 1 + \frac{2}{3!}z^3 + \frac{2 \cdot 5}{6!}z^6 + \frac{2 \cdot 5 \cdot 8}{9!}z^9 + \dots \right) + \text{Bi}(0) \left( \frac{1}{2!}z^2 + \frac{1 \cdot 4}{5!}z^5 + \frac{1 \cdot 4 \cdot 7}{8!}z^8 + \dots \right).$$

## 9.5 Integral Representations

### 9.5(i) Real Variable

$$9.5.1 \quad \text{Ai}(x) = \frac{1}{\pi} \int_0^{\infty} \cos\left(\frac{1}{3}t^3 + xt\right) dt.$$

9.5.2

$$\text{Ai}(-x) = \frac{x^{1/2}}{\pi} \int_{-1}^{\infty} \cos\left(x^{3/2}\left(\frac{1}{3}t^3 + t^2 - \frac{2}{3}\right)\right) dt, \quad x > 0.$$

9.5.3

$$\text{Bi}(x) = \frac{1}{\pi} \int_0^{\infty} \exp\left(-\frac{1}{3}t^3 + xt\right) dt + \frac{1}{\pi} \int_0^{\infty} \sin\left(\frac{1}{3}t^3 + xt\right) dt.$$

See also (9.10.19), (9.11.3), (36.9.2), and Vallée and Soares (2004, §2.1.3).

### 9.5(ii) Complex Variable

$$9.5.4 \quad \text{Ai}(z) = \frac{1}{2\pi i} \int_{\infty e^{-\pi i/3}}^{\infty e^{\pi i/3}} \exp\left(\frac{1}{3}t^3 - zt\right) dt,$$

$$9.5.5 \quad \text{Bi}(z) = \frac{1}{2\pi} \int_{-\infty}^{\infty e^{\pi i/3}} \exp\left(\frac{1}{3}t^3 - zt\right) dt + \frac{1}{2\pi} \int_{-\infty}^{\infty e^{-\pi i/3}} \exp\left(\frac{1}{3}t^3 - zt\right) dt.$$

$$9.5.6 \quad \text{Ai}(z) = \frac{\sqrt{3}}{2\pi} \int_0^{\infty} \exp\left(-\frac{t^3}{3} - \frac{z^3}{3t^3}\right) dt.$$

9.5.7

$$\text{Ai}(z) = \frac{e^{-\zeta}}{\pi} \int_0^{\infty} \exp\left(-z^{1/2}t^2\right) \cos\left(\frac{1}{3}t^3\right) dt, \quad |\text{ph } z| < \pi.$$

9.5.8

$$\text{Ai}(z) = \frac{e^{-\zeta} \zeta^{-1/6}}{\sqrt{\pi}(48)^{1/6} \Gamma\left(\frac{5}{6}\right)} \int_0^{\infty} e^{-t} t^{-1/6} \left(2 + \frac{t}{\zeta}\right)^{-1/6} dt, \quad |\text{ph } z| < \frac{2}{3}\pi.$$

In (9.5.7) and (9.5.8)  $\zeta = \frac{2}{3}z^{3/2}$ .

See also (9.10.18) and (9.11.4).

## 9.6 Relations to Other Functions

### 9.6(i) Airy Functions as Bessel Functions, Hankel Functions, and Modified Bessel Functions

For the notation see §§10.2(ii) and 10.25(ii). With

$$9.6.1 \quad \zeta = \frac{2}{3}z^{3/2},$$

$$\begin{aligned} \text{Ai}(z) &= \pi^{-1} \sqrt{z/3} K_{\pm 1/3}(\zeta) \\ &= \frac{1}{3} \sqrt{z} (I_{-1/3}(\zeta) - I_{1/3}(\zeta)) \\ &= \frac{1}{2} \sqrt{z/3} e^{2\pi i/3} H_{1/3}^{(1)}(\zeta e^{\pi i/2}) \\ 9.6.2 \quad &= \frac{1}{2} \sqrt{z/3} e^{\pi i/3} H_{-1/3}^{(1)}(\zeta e^{\pi i/2}) \\ &= \frac{1}{2} \sqrt{z/3} e^{-2\pi i/3} H_{1/3}^{(2)}(\zeta e^{-\pi i/2}) \\ &= \frac{1}{2} \sqrt{z/3} e^{-\pi i/3} H_{-1/3}^{(2)}(\zeta e^{-\pi i/2}), \end{aligned}$$

$$\begin{aligned} \text{Ai}'(z) &= -\pi^{-1} (z/\sqrt{3}) K_{\pm 2/3}(\zeta) \\ &= (z/3) (I_{2/3}(\zeta) - I_{-2/3}(\zeta)) \\ &= \frac{1}{2} (z/\sqrt{3}) e^{-\pi i/6} H_{2/3}^{(1)}(\zeta e^{\pi i/2}) \\ 9.6.3 \quad &= \frac{1}{2} (z/\sqrt{3}) e^{-5\pi i/6} H_{-2/3}^{(1)}(\zeta e^{\pi i/2}) \\ &= \frac{1}{2} (z/\sqrt{3}) e^{\pi i/6} H_{2/3}^{(2)}(\zeta e^{-\pi i/2}) \\ &= \frac{1}{2} (z/\sqrt{3}) e^{5\pi i/6} H_{-2/3}^{(2)}(\zeta e^{-\pi i/2}), \end{aligned}$$

$$\begin{aligned} \text{Bi}(z) &= \sqrt{z/3} (I_{1/3}(\zeta) + I_{-1/3}(\zeta)) \\ &= \frac{1}{2} \sqrt{z/3} \left( e^{\pi i/6} H_{1/3}^{(1)}(\zeta e^{-\pi i/2}) \right. \\ 9.6.4 \quad &\quad \left. + e^{-\pi i/6} H_{1/3}^{(2)}(\zeta e^{\pi i/2}) \right) \\ &= \frac{1}{2} \sqrt{z/3} \left( e^{-\pi i/6} H_{-1/3}^{(1)}(\zeta e^{-\pi i/2}) \right. \\ &\quad \left. + e^{\pi i/6} H_{-1/3}^{(2)}(\zeta e^{\pi i/2}) \right), \end{aligned}$$

$$\begin{aligned}
\text{Bi}'(z) &= (z/\sqrt{3}) (I_{2/3}(\zeta) + I_{-2/3}(\zeta)) \\
&= \frac{1}{2}(z/\sqrt{3}) \left( e^{\pi i/3} H_{2/3}^{(1)}(\zeta e^{-\pi i/2}) \right. \\
&\quad \left. + e^{-\pi i/3} H_{2/3}^{(2)}(\zeta e^{\pi i/2}) \right) \\
&= \frac{1}{2}(z/\sqrt{3}) \left( e^{-\pi i/3} H_{-2/3}^{(1)}(\zeta e^{-\pi i/2}) \right. \\
&\quad \left. + e^{\pi i/3} H_{-2/3}^{(2)}(\zeta e^{\pi i/2}) \right),
\end{aligned}$$

9.6.5

$$\begin{aligned}
\text{Ai}(-z) &= (\sqrt{z}/3) (J_{1/3}(\zeta) + J_{-1/3}(\zeta)) \\
&= \frac{1}{2}\sqrt{z/3} \left( e^{\pi i/6} H_{1/3}^{(1)}(\zeta) + e^{-\pi i/6} H_{1/3}^{(2)}(\zeta) \right) \\
&= \frac{1}{2}\sqrt{z/3} \left( e^{-\pi i/6} H_{-1/3}^{(1)}(\zeta) + e^{\pi i/6} H_{-1/3}^{(2)}(\zeta) \right),
\end{aligned}$$

9.6.6

$$\begin{aligned}
\text{Ai}'(-z) &= (z/3) (J_{2/3}(\zeta) - J_{-2/3}(\zeta)) \\
&= \frac{1}{2}(z/\sqrt{3}) \left( e^{-\pi i/6} H_{2/3}^{(1)}(\zeta) + e^{\pi i/6} H_{2/3}^{(2)}(\zeta) \right) \\
&= \frac{1}{2}(z/\sqrt{3}) \left( e^{-5\pi i/6} H_{-2/3}^{(1)}(\zeta) \right. \\
&\quad \left. + e^{5\pi i/6} H_{-2/3}^{(2)}(\zeta) \right),
\end{aligned}$$

9.6.7

$$\begin{aligned}
\text{Bi}(-z) &= \sqrt{z/3} (J_{-1/3}(\zeta) - J_{1/3}(\zeta)) \\
&= \frac{1}{2}\sqrt{z/3} \left( e^{2\pi i/3} H_{1/3}^{(1)}(\zeta) + e^{-2\pi i/3} H_{1/3}^{(2)}(\zeta) \right) \\
&= \frac{1}{2}\sqrt{z/3} \left( e^{\pi i/3} H_{-1/3}^{(1)}(\zeta) + e^{-\pi i/3} H_{-1/3}^{(2)}(\zeta) \right),
\end{aligned}$$

9.6.8

$$\begin{aligned}
\text{Bi}'(-z) &= (z/\sqrt{3}) (J_{-2/3}(\zeta) + J_{2/3}(\zeta)) \\
&= \frac{1}{2}(z/\sqrt{3}) \left( e^{\pi i/3} H_{2/3}^{(1)}(\zeta) + e^{-\pi i/3} H_{2/3}^{(2)}(\zeta) \right) \\
&= \frac{1}{2}(z/\sqrt{3}) \left( e^{-\pi i/3} H_{-2/3}^{(1)}(\zeta) \right. \\
&\quad \left. + e^{\pi i/3} H_{-2/3}^{(2)}(\zeta) \right).
\end{aligned}$$

### 9.6(ii) Bessel Functions, Hankel Functions, and Modified Bessel Functions as Airy Functions

Again, for the notation see §§10.2(ii) and 10.25(ii). With

9.6.10

$$z = \left(\frac{3}{2}\zeta\right)^{2/3},$$

$$9.6.11 \quad J_{\pm 1/3}(\zeta) = \frac{1}{2}\sqrt{3/z} \left( \sqrt{3} \text{Ai}(-z) \mp \text{Bi}(-z) \right),$$

$$9.6.12 \quad J_{\pm 2/3}(\zeta) = \frac{1}{2}(\sqrt{3}/z) \left( \pm\sqrt{3} \text{Ai}'(-z) + \text{Bi}'(-z) \right),$$

$$9.6.13 \quad I_{\pm 1/3}(\zeta) = \frac{1}{2}\sqrt{3/z} \left( \mp\sqrt{3} \text{Ai}(z) + \text{Bi}(z) \right),$$

$$9.6.14 \quad I_{\pm 2/3}(\zeta) = \frac{1}{2}(\sqrt{3}/z) \left( \pm\sqrt{3} \text{Ai}'(z) + \text{Bi}'(z) \right),$$

$$9.6.15 \quad K_{\pm 1/3}(\zeta) = \pi\sqrt{3/z} \text{Ai}(z),$$

$$9.6.16 \quad K_{\pm 2/3}(\zeta) = -\pi(\sqrt{3}/z) \text{Ai}'(z),$$

$$\begin{aligned}
9.6.17 \quad H_{1/3}^{(1)}(\zeta) &= e^{-\pi i/3} H_{-1/3}^{(1)}(\zeta) \\
&= e^{-\pi i/6} \sqrt{3/z} (\text{Ai}(-z) - i \text{Bi}(-z)),
\end{aligned}$$

$$\begin{aligned}
9.6.18 \quad H_{2/3}^{(1)}(\zeta) &= e^{-2\pi i/3} H_{-2/3}^{(1)}(\zeta) \\
&= e^{\pi i/6} (\sqrt{3}/z) (\text{Ai}'(-z) - i \text{Bi}'(-z)),
\end{aligned}$$

$$\begin{aligned}
9.6.19 \quad H_{1/3}^{(2)}(\zeta) &= e^{\pi i/3} H_{-1/3}^{(2)}(\zeta) \\
&= e^{\pi i/6} \sqrt{3/z} (\text{Ai}(-z) + i \text{Bi}(-z)),
\end{aligned}$$

$$\begin{aligned}
9.6.20 \quad H_{2/3}^{(2)}(\zeta) &= e^{2\pi i/3} H_{-2/3}^{(2)}(\zeta) \\
&= e^{-\pi i/6} (\sqrt{3}/z) (\text{Ai}'(-z) + i \text{Bi}'(-z)).
\end{aligned}$$

### 9.6(iii) Airy Functions as Confluent Hypergeometric Functions

For the notation see §§13.1, 13.2, and 13.14(i). With  $\zeta$  as in (9.6.1),

$$\begin{aligned}
9.6.21 \quad \text{Ai}(z) &= \frac{1}{2}\pi^{-1/2} z^{-1/4} W_{0,1/3}(2\zeta) \\
&= 3^{-1/6} \pi^{-1/2} \zeta^{2/3} e^{-\zeta} U\left(\frac{5}{6}, \frac{5}{3}, 2\zeta\right),
\end{aligned}$$

$$\begin{aligned}
9.6.22 \quad \text{Ai}'(z) &= -\frac{1}{2}\pi^{-1/2} z^{1/4} W_{0,2/3}(2\zeta) \\
&= -3^{1/6} \pi^{-1/2} \zeta^{4/3} e^{-\zeta} U\left(\frac{7}{6}, \frac{7}{3}, 2\zeta\right),
\end{aligned}$$

$$\begin{aligned}
9.6.23 \quad \text{Bi}(z) &= \frac{1}{2^{1/3} \Gamma(\frac{2}{3})} z^{-1/4} M_{0,-1/3}(2\zeta) \\
&\quad + \frac{3}{2^{5/3} \Gamma(\frac{1}{3})} z^{-1/4} M_{0,1/3}(2\zeta),
\end{aligned}$$

$$\begin{aligned}
9.6.24 \quad \text{Bi}'(z) &= \frac{2^{1/3}}{\Gamma(\frac{1}{3})} z^{1/4} M_{0,-2/3}(2\zeta) \\
&\quad + \frac{3}{2^{10/3} \Gamma(\frac{2}{3})} z^{1/4} M_{0,2/3}(2\zeta),
\end{aligned}$$

$$\begin{aligned}
9.6.25 \quad \text{Bi}(z) &= \frac{1}{3^{1/6} \Gamma(\frac{2}{3})} e^{-\zeta} {}_1F_1\left(\frac{1}{6}; \frac{1}{3}; 2\zeta\right) \\
&\quad + \frac{3^{5/6}}{2^{2/3} \Gamma(\frac{1}{3})} \zeta^{2/3} e^{-\zeta} {}_1F_1\left(\frac{5}{6}; \frac{5}{3}; 2\zeta\right),
\end{aligned}$$

$$\begin{aligned}
9.6.26 \quad \text{Bi}'(z) &= \frac{3^{1/6}}{\Gamma(\frac{1}{3})} e^{-\zeta} {}_1F_1\left(-\frac{1}{6}; -\frac{1}{3}; 2\zeta\right) \\
&\quad + \frac{3^{7/6}}{2^{7/3} \Gamma(\frac{2}{3})} \zeta^{4/3} e^{-\zeta} {}_1F_1\left(\frac{7}{6}; \frac{7}{3}; \zeta\right).
\end{aligned}$$

**9.7 Asymptotic Expansions**

Table 9.7.1:  $\chi(n)$ .

**9.7(i) Notation**

Here  $\delta$  denotes an arbitrary small positive constant and

**9.7.1** 
$$\zeta = \frac{2}{3}z^{3/2}.$$

Also  $u_0 = v_0 = 1$  and for  $k = 1, 2, \dots$ ,

**9.7.2** 
$$u_k = \frac{(2k+1)(2k+3)(2k+5)\cdots(6k-1)}{(216)^k(k)!},$$

$$v_k = \frac{6k+1}{1-6k}u_k.$$

Lastly,

**9.7.3** 
$$\chi(n) = \pi^{1/2} \Gamma(\frac{1}{2}n+1)/\Gamma(\frac{1}{2}n+\frac{1}{2}).$$

Numerical values of this function are given in Table 9.7.1 for  $n = 1(1)20$  to 2D. For large  $n$ ,

**9.7.4** 
$$\chi(n) \sim (\frac{1}{2}\pi n)^{1/2}.$$

$n$	$\chi(n)$	$n$	$\chi(n)$	$n$	$\chi(n)$	$n$	$\chi(n)$
1	1.57	6	3.20	11	4.25	16	5.09
2	2.00	7	3.44	12	4.43	17	5.24
3	2.36	8	3.66	13	4.61	18	5.39
4	2.67	9	3.87	14	4.77	19	5.54
5	2.95	10	4.06	15	4.94	20	5.68

**9.7(ii) Poincaré-Type Expansions**

As  $z \rightarrow \infty$  the following asymptotic expansions are valid uniformly in the stated sectors.

**9.7.5** 
$$\text{Ai}(z) \sim \frac{e^{-\zeta}}{2\sqrt{\pi}z^{1/4}} \sum_{k=0}^{\infty} (-1)^k \frac{u_k}{\zeta^k}, \quad |\text{ph } z| \leq \pi - \delta,$$

**9.7.6** 
$$\text{Ai}'(z) \sim -\frac{z^{1/4}e^{-\zeta}}{2\sqrt{\pi}} \sum_{k=0}^{\infty} (-1)^k \frac{v_k}{\zeta^k}, \quad |\text{ph } z| \leq \pi - \delta,$$

**9.7.7** 
$$\text{Bi}(z) \sim \frac{e^{\zeta}}{\sqrt{\pi}z^{1/4}} \sum_{k=0}^{\infty} \frac{u_k}{\zeta^k}, \quad |\text{ph } z| \leq \frac{1}{3}\pi - \delta,$$

**9.7.8** 
$$\text{Bi}'(z) \sim \frac{z^{1/4}e^{\zeta}}{\sqrt{\pi}} \sum_{k=0}^{\infty} \frac{v_k}{\zeta^k}, \quad |\text{ph } z| \leq \frac{1}{3}\pi - \delta.$$

**9.7.9** 
$$\text{Ai}(-z) \sim \frac{1}{\sqrt{\pi}z^{1/4}} \left( \cos(\zeta - \frac{1}{4}\pi) \sum_{k=0}^{\infty} (-1)^k \frac{u_{2k}}{\zeta^{2k}} + \sin(\zeta - \frac{1}{4}\pi) \sum_{k=0}^{\infty} (-1)^k \frac{u_{2k+1}}{\zeta^{2k+1}} \right), \quad |\text{ph } z| \leq \frac{2}{3}\pi - \delta,$$

**9.7.10** 
$$\text{Ai}'(-z) \sim \frac{z^{1/4}}{\sqrt{\pi}} \left( \sin(\zeta - \frac{1}{4}\pi) \sum_{k=0}^{\infty} (-1)^k \frac{v_{2k}}{\zeta^{2k}} - \cos(\zeta - \frac{1}{4}\pi) \sum_{k=0}^{\infty} (-1)^k \frac{v_{2k+1}}{\zeta^{2k+1}} \right), \quad |\text{ph } z| \leq \frac{2}{3}\pi - \delta,$$

**9.7.11** 
$$\text{Bi}(-z) \sim \frac{1}{\sqrt{\pi}z^{1/4}} \left( -\sin(\zeta - \frac{1}{4}\pi) \sum_{k=0}^{\infty} (-1)^k \frac{u_{2k}}{\zeta^{2k}} + \cos(\zeta - \frac{1}{4}\pi) \sum_{k=0}^{\infty} (-1)^k \frac{u_{2k+1}}{\zeta^{2k+1}} \right), \quad |\text{ph } z| \leq \frac{2}{3}\pi - \delta,$$

**9.7.12** 
$$\text{Bi}'(-z) \sim \frac{z^{1/4}}{\sqrt{\pi}} \left( \cos(\zeta - \frac{1}{4}\pi) \sum_{k=0}^{\infty} (-1)^k \frac{v_{2k}}{\zeta^{2k}} + \sin(\zeta - \frac{1}{4}\pi) \sum_{k=0}^{\infty} (-1)^k \frac{v_{2k+1}}{\zeta^{2k+1}} \right), \quad |\text{ph } z| \leq \frac{2}{3}\pi - \delta.$$

**9.7.13** 
$$\text{Bi}(ze^{\pm\pi i/3}) \sim \sqrt{\frac{2}{\pi}} \frac{e^{\pm\pi i/6}}{z^{1/4}} \left( \cos(\zeta - \frac{1}{4}\pi \mp \frac{1}{2}i \ln 2) \sum_{k=0}^{\infty} (-1)^k \frac{u_{2k}}{\zeta^{2k}} + \sin(\zeta - \frac{1}{4}\pi \mp \frac{1}{2}i \ln 2) \sum_{k=0}^{\infty} (-1)^k \frac{u_{2k+1}}{\zeta^{2k+1}} \right),$$
  

$$|\text{ph } z| \leq \frac{2}{3}\pi - \delta,$$

**9.7.14** 
$$\text{Bi}'(ze^{\pm\pi i/3}) \sim \sqrt{\frac{2}{\pi}} e^{\mp\pi i/6} z^{1/4} \left( -\sin(\zeta - \frac{1}{4}\pi \mp \frac{1}{2}i \ln 2) \sum_{k=0}^{\infty} (-1)^k \frac{v_{2k}}{\zeta^{2k}} + \cos(\zeta - \frac{1}{4}\pi \mp \frac{1}{2}i \ln 2) \sum_{k=0}^{\infty} (-1)^k \frac{v_{2k+1}}{\zeta^{2k+1}} \right),$$
  

$$|\text{ph } z| \leq \frac{2}{3}\pi - \delta.$$

### 9.7(iii) Error Bounds for Real Variables

In (9.7.5) and (9.7.6) the  $n$ th error term, that is, the error on truncating the expansion at  $n$  terms, is bounded in magnitude by the first neglected term and has the same sign, provided that the following term is of opposite sign, that is, if  $n \geq 0$  for (9.7.5) and  $n \geq 1$  for (9.7.6).

In (9.7.7) and (9.7.8) the  $n$ th error term is bounded in magnitude by the first neglected term multiplied by  $2\chi(n)\exp(\sigma\pi/(72\zeta))$  where  $\sigma = 5$  for (9.7.7) and  $\sigma = 7$  for (9.7.8), provided that  $n \geq 1$  in both cases.

In (9.7.9)–(9.7.12) the  $n$ th error term in each infinite series is bounded in magnitude by the first neglected term and has the same sign, provided that the following term in the series is of opposite sign.

As special cases, when  $0 < x < \infty$

9.7.15

$$\text{Ai}(x) \leq \frac{e^{-\xi}}{2\sqrt{\pi}x^{1/4}}, \quad |\text{Ai}'(x)| \leq \frac{x^{1/4}e^{-\xi}}{2\sqrt{\pi}} \left(1 + \frac{7}{72\xi}\right),$$

9.7.16

$$\begin{aligned} \text{Bi}(x) &\leq \frac{e^\xi}{\sqrt{\pi}x^{1/4}} \left(1 + \frac{5\pi}{72\xi} \exp\left(\frac{5\pi}{72\xi}\right)\right), \\ \text{Bi}'(x) &\leq \frac{x^{1/4}e^\xi}{\sqrt{\pi}} \left(1 + \frac{7\pi}{72\xi} \exp\left(\frac{7\pi}{72\xi}\right)\right), \end{aligned}$$

where  $\xi = \frac{2}{3}x^{3/2}$ .

### 9.7(iv) Error Bounds for Complex Variables

When  $n \geq 1$  the  $n$ th error term in (9.7.5) and (9.7.6) is bounded in magnitude by the first neglected term multiplied by

$$\begin{aligned} &2 \exp\left(\frac{\sigma}{36|\zeta|}\right), \quad 2\chi(n) \exp\left(\frac{\sigma\pi}{72|\zeta|}\right) \\ \text{9.7.17} \quad &\text{or } \frac{4\chi(n)}{|\cos(\text{ph } \zeta)|^n} \exp\left(\frac{\sigma\pi}{36|\Re \zeta|}\right), \end{aligned}$$

according as  $|\text{ph } z| \leq \frac{1}{3}\pi$ ,  $\frac{1}{3}\pi \leq |\text{ph } z| \leq \frac{2}{3}\pi$ , or  $\frac{2}{3}\pi \leq |\text{ph } z| \leq \pi$ . Here  $\sigma = 5$  for (9.7.5) and  $\sigma = 7$  for (9.7.6).

Corresponding bounds for the errors in (9.7.7) to (9.7.14) may be obtained by use of these results and those of §9.2(v) and their differentiated forms.

For other error bounds see Boyd (1993).

### 9.7(v) Exponentially-Improved Expansions

In (9.7.5) and (9.7.6) let

$$\text{9.7.18} \quad \text{Ai}(z) = \frac{e^{-\zeta}}{2\sqrt{\pi}z^{1/4}} \left( \sum_{k=0}^{n-1} (-1)^k \frac{u_k}{\zeta^k} + R_n(z) \right),$$

$$\text{9.7.19} \quad \text{Ai}'(z) = -\frac{z^{1/4}e^{-\zeta}}{2\sqrt{\pi}} \left( \sum_{k=0}^{n-1} (-1)^k \frac{v_k}{\zeta^k} + S_n(z) \right),$$

with  $n = \lfloor 2|\zeta| \rfloor$ . Then

9.7.20

$$R_n(z) = (-1)^n \sum_{k=0}^{m-1} (-1)^k u_k \frac{G_{n-k}(2\zeta)}{\zeta^k} + R_{m,n}(z),$$

9.7.21

$$S_n(z) = (-1)^{n-1} \sum_{k=0}^{m-1} (-1)^k v_k \frac{G_{n-k}(2\zeta)}{\zeta^k} + S_{m,n}(z),$$

where

$$\text{9.7.22} \quad G_p(z) = \frac{e^z}{2\pi} \Gamma(p) \Gamma(1-p, z).$$

(For the notation see §8.2(i).) And as  $z \rightarrow \infty$  with  $m$  fixed

9.7.23

$$R_{m,n}(z), S_{m,n}(z) = O\left(e^{-2|\zeta|} \zeta^{-m}\right), \quad |\text{ph } z| \leq \frac{2}{3}\pi.$$

For re-expansions of the remainder terms in (9.7.7)–(9.7.14) combine the results of this section with those of §9.2(v) and their differentiated forms, as in §9.7(iv).

For higher re-expansions of the remainder terms see Olde Daalhuis (1995, 1996), and Olde Daalhuis and Olver (1995a).

## 9.8 Modulus and Phase

### 9.8(i) Definitions

Throughout this section  $x$  is real and nonpositive.

$$\text{9.8.1} \quad \text{Ai}(x) = M(x) \sin \theta(x),$$

$$\text{9.8.2} \quad \text{Bi}(x) = M(x) \cos \theta(x),$$

$$\text{9.8.3} \quad M(x) = \sqrt{\text{Ai}^2(x) + \text{Bi}^2(x)},$$

$$\text{9.8.4} \quad \theta(x) = \arctan(\text{Ai}(x)/\text{Bi}(x)).$$

$$\text{9.8.5} \quad \text{Ai}'(x) = N(x) \sin \phi(x),$$

$$\text{9.8.6} \quad \text{Bi}'(x) = N(x) \cos \phi(x),$$

$$\text{9.8.7} \quad N(x) = \sqrt{\text{Ai}'^2(x) + \text{Bi}'^2(x)},$$

$$\text{9.8.8} \quad \phi(x) = \arctan(\text{Ai}'(x)/\text{Bi}'(x)).$$

Graphs of  $M(x)$  and  $N(x)$  are included in §9.3(i). The branches of  $\theta(x)$  and  $\phi(x)$  are continuous and fixed by  $\theta(0) = -\phi(0) = \frac{1}{6}\pi$ . (These definitions of  $\theta(x)$  and  $\phi(x)$  differ from Abramowitz and Stegun (1964, Chapter 10), and agree more closely with those used in Miller (1946) and Olver (1997b, Chapter 11).)

In terms of Bessel functions, and with  $\xi = \frac{2}{3}|x|^{3/2}$ ,

$$\text{9.8.9} \quad |x|^{1/2} M^2(x) = \frac{1}{2}\xi \left( J_{1/3}^2(\xi) + Y_{1/3}^2(\xi) \right),$$

$$\text{9.8.10} \quad |x|^{-1/2} N^2(x) = \frac{1}{2}\xi \left( J_{2/3}^2(\xi) + Y_{2/3}^2(\xi) \right),$$

$$\text{9.8.11} \quad \theta(x) = \frac{2}{3}\pi + \arctan(Y_{1/3}(\xi)/J_{1/3}(\xi)),$$

$$\text{9.8.12} \quad \phi(x) = \frac{1}{3}\pi + \arctan(Y_{2/3}(\xi)/J_{2/3}(\xi)).$$



### 9.8(ii) Identities

Primes denote differentiations with respect to  $x$ , which is continued to be assumed real and nonpositive.

$$9.8.13 \quad M(x)N(x)\sin(\theta(x) - \phi(x)) = \pi^{-1},$$

$$9.8.14 \quad \begin{aligned} M^2(x)\theta'(x) &= -\pi^{-1}, & N^2(x)\phi'(x) &= \pi^{-1}x, \\ N(x)N'(x) &= xM(x)M'(x), \end{aligned}$$

$$9.8.15 \quad \begin{aligned} N^2(x) &= M'^2(x) + M^2(x)\theta'^2(x) \\ &= M'^2(x) + \pi^{-2}M^{-2}(x), \end{aligned}$$

$$9.8.16 \quad \begin{aligned} x^2M^2(x) &= N'^2(x) + N^2(x)\phi'^2(x) \\ &= N'^2(x) + \pi^{-2}x^2N^{-2}(x), \end{aligned}$$

$$9.8.17 \quad \begin{aligned} \tan(\theta(x) - \phi(x)) &= 1/(\pi M(x)M'(x)) \\ &= -M(x)\theta'(x)/M'(x), \end{aligned}$$

$$9.8.18 \quad \begin{aligned} M''(x) &= xM(x) + \pi^{-2}M^{-3}(x), \\ (M^2)'''(x) - 4x(M^2)'(x) - 2M^2(x) &= 0, \end{aligned}$$

$$9.8.19 \quad \theta'^2(x) + \frac{1}{2}(\theta'''(x)/\theta'(x)) - \frac{3}{4}(\theta''(x)/\theta'(x))^2 = -x.$$

### 9.8(iii) Monotonicity

As  $x$  increases from  $-\infty$  to 0 each of the functions  $M(x)$ ,  $M'(x)$ ,  $|x|^{-1/4}N(x)$ ,  $M(x)N(x)$ ,  $\theta'(x)$ ,  $\phi'(x)$  is increasing, and each of the functions  $|x|^{1/4}M(x)$ ,  $\theta(x)$ ,  $\phi(x)$  is decreasing.

### 9.8(iv) Asymptotic Expansions

As  $x \rightarrow -\infty$

$$9.8.20 \quad M^2(x) \sim \frac{1}{\pi(-x)^{1/2}} \sum_{k=0}^{\infty} \frac{1 \cdot 3 \cdot 5 \cdots (6k-1)}{k!(96)^k} \frac{1}{x^{3k}},$$

$$9.8.21 \quad N^2(x) \sim \frac{(-x)^{1/2}}{\pi} \sum_{k=0}^{\infty} \frac{1 \cdot 3 \cdot 5 \cdots (6k-1)}{k!(96)^k} \frac{1+6k}{1-6k} \frac{1}{x^{3k}},$$

$$9.8.22 \quad \begin{aligned} \theta(x) \sim \frac{\pi}{4} + \frac{2}{3}(-x)^{3/2} &\left( 1 + \frac{5}{32} \frac{1}{x^3} + \frac{1105}{6144} \frac{1}{x^6} \right. \\ &\left. + \frac{82825}{65536} \frac{1}{x^9} + \frac{1282031525}{58720256} \frac{1}{x^{12}} + \cdots \right), \end{aligned}$$

$$9.8.23 \quad \begin{aligned} \phi(x) \sim -\frac{\pi}{4} + \frac{2}{3}(-x)^{3/2} &\left( 1 - \frac{7}{32} \frac{1}{x^3} - \frac{1463}{6144} \frac{1}{x^6} \right. \\ &\left. - \frac{495271}{327680} \frac{1}{x^9} - \frac{206530429}{8388608} \frac{1}{x^{12}} - \cdots \right). \end{aligned}$$

In (9.8.20) and (9.8.21) the remainder after  $n$  terms does not exceed the  $(n+1)$ th term in absolute value and is of the same sign, provided that  $n \geq 0$  for (9.8.20) and  $n \geq 1$  for (9.8.21).

For higher terms in (9.8.22) and (9.8.23) see Fabijonas *et al.* (2004). Also, approximate values (25S) of the coefficients of the powers  $x^{-15}$ ,  $x^{-18}$ ,  $\dots$ ,  $x^{-56}$  are available in Sherry (1959).

## 9.9 Zeros

### 9.9(i) Distribution and Notation

On the real line,  $\text{Ai}(x)$ ,  $\text{Ai}'(x)$ ,  $\text{Bi}(x)$ ,  $\text{Bi}'(x)$  each have an infinite number of zeros, all of which are negative. They are denoted by  $a_k$ ,  $a'_k$ ,  $b_k$ ,  $b'_k$ , respectively, arranged in ascending order of absolute value for  $k = 1, 2, \dots$ .

$\text{Ai}(z)$  and  $\text{Ai}'(z)$  have no other zeros. However,  $\text{Bi}(z)$  and  $\text{Bi}'(z)$  each have an infinite number of complex zeros. They lie in the sectors  $\frac{1}{3}\pi < \text{ph}z < \frac{1}{2}\pi$  and  $-\frac{1}{2}\pi < \text{ph}z < -\frac{1}{3}\pi$ , and are denoted by  $\beta_k$ ,  $\beta'_k$ , respectively, in the former sector, and by  $\bar{\beta}_k$ ,  $\bar{\beta}'_k$ , in the conjugate sector, again arranged in ascending order of absolute value (modulus) for  $k = 1, 2, \dots$ . See §9.3(ii) for visualizations.

For the distribution in  $\mathbb{C}$  of the zeros of  $\text{Ai}'(z) - \sigma \text{Ai}(z)$ , where  $\sigma$  is an arbitrary complex constant, see Muraveĭ (1976).

### 9.9(ii) Relation to Modulus and Phase

$$9.9.1 \quad \theta(a_k) = \phi(a'_{k+1}) = k\pi,$$

$$9.9.2 \quad \theta(b_k) = \phi(b'_k) = (k - \frac{1}{2})\pi.$$

$$9.9.3 \quad \text{Ai}'(a_k) = \frac{(-1)^{k-1}}{\pi M(a_k)}, \quad \text{Bi}'(b_k) = \frac{(-1)^{k-1}}{\pi M(b_k)},$$

$$9.9.4 \quad \text{Ai}(a'_k) = \frac{(-1)^{k-1}}{\pi N(a'_k)}, \quad \text{Bi}(b'_k) = \frac{(-1)^k}{\pi N(b'_k)}.$$

### 9.9(iii) Derivatives With Respect to $k$

If  $k$  is regarded as a continuous variable, then

$$9.9.5 \quad \text{Ai}'(a_k) = (-1)^{k-1} \left( -\frac{da_k}{dk} \right)^{-1/2},$$

$$\text{Ai}(a'_k) = (-1)^{k-1} \left( a'_k \frac{da'_k}{dk} \right)^{-1/2}.$$

See Olver (1954, Appendix).

**9.9(iv) Asymptotic Expansions**

For large  $k$

9.9.6  $a_k = -T\left(\frac{3}{8}\pi(4k-1)\right),$

9.9.7  $\text{Ai}'(a_k) = (-1)^{k-1}V\left(\frac{3}{8}\pi(4k-1)\right),$

9.9.8  $a'_k = -U\left(\frac{3}{8}\pi(4k-3)\right),$

9.9.9  $\text{Ai}(a'_k) = (-1)^{k-1}W\left(\frac{3}{8}\pi(4k-3)\right).$

9.9.10  $b_k = -T\left(\frac{3}{8}\pi(4k-3)\right),$

9.9.11  $\text{Bi}'(b_k) = (-1)^{k-1}V\left(\frac{3}{8}\pi(4k-3)\right),$

9.9.12  $b'_k = -U\left(\frac{3}{8}\pi(4k-1)\right),$

9.9.13  $\text{Bi}(b'_k) = (-1)^k W\left(\frac{3}{8}\pi(4k-1)\right).$

9.9.14  $\beta_k = e^{\pi i/3}T\left(\frac{3}{8}\pi(4k-1) + \frac{3}{4}i \ln 2\right),$

9.9.15  $\text{Bi}'(\beta_k) = (-1)^k \sqrt{2}e^{-\pi i/6}V\left(\frac{3}{8}\pi(4k-1) + \frac{3}{4}i \ln 2\right),$

9.9.16  $\beta'_k = e^{\pi i/3}U\left(\frac{3}{8}\pi(4k-3) + \frac{3}{4}i \ln 2\right),$

9.9.17  $\text{Bi}(\beta'_k) = (-1)^{k-1} \sqrt{2}e^{\pi i/6}W\left(\frac{3}{8}\pi(4k-3) + \frac{3}{4}i \ln 2\right).$

Here

9.9.18  $T(t) \sim t^{2/3} \left(1 + \frac{5}{48}t^{-2} - \frac{5}{36}t^{-4} + \frac{77125}{82944}t^{-6} - \frac{1080\ 56875}{69\ 67296}t^{-8} + \frac{16\ 23755\ 96875}{3344\ 30208}t^{-10} - \dots\right),$

9.9.19  $U(t) \sim t^{2/3} \left(1 - \frac{7}{48}t^{-2} + \frac{35}{288}t^{-4} - \frac{1\ 81223}{2\ 07360}t^{-6} + \frac{186\ 83371}{12\ 44160}t^{-8} - \frac{9\ 11458\ 84361}{1911\ 02976}t^{-10} + \dots\right),$

9.9.20  $V(t) \sim \pi^{-1/2}t^{1/6} \left(1 + \frac{5}{48}t^{-2} - \frac{1525}{4608}t^{-4} + \frac{23\ 97875}{6\ 63552}t^{-6} - \frac{7\ 48989\ 40625}{8918\ 13888}t^{-8} + \frac{14419\ 83037\ 34375}{4\ 28070\ 66624}t^{-10} - \dots\right),$

9.9.21  $W(t) \sim \pi^{-1/2}t^{-1/6} \left(1 - \frac{7}{96}t^{-2} + \frac{1673}{6144}t^{-4} - \frac{843\ 94709}{265\ 42080}t^{-6} + \frac{78\ 02771\ 35421}{1\ 01921\ 58720}t^{-8} - \frac{20444\ 90510\ 51945}{6\ 52298\ 15808}t^{-10} + \dots\right).$

For higher terms see Fabijonas and Olver (1999).

For error bounds for the asymptotic expansions of  $a_k$ ,  $b_k$ ,  $a'_k$ , and  $b'_k$  see Pittaluga and Sacripante (1991), and a conjecture given in Fabijonas and Olver (1999).

**9.9(v) Tables**

Tables 9.9.1 and 9.9.2 give 10D values of the first five real zeros of Ai, Ai', Bi, Bi', together with the associated values of the derivative or the function. Tables 9.9.3 and 9.9.4 give the corresponding results for the first five complex zeros of Bi and Bi' in the upper half plane.

For versions of Tables 9.9.1–9.9.4 that cover  $k = 1(1)10$  see <http://dlmf.nist.gov/9.9.v>.

Table 9.9.1: Zeros of Ai and Ai'.

$k$	$a_k$	$\text{Ai}'(a_k)$	$a'_k$	$\text{Ai}(a'_k)$
1	-2.33810 74105	0.70121 08227	-1.01879 29716	0.53565 66560
2	-4.08794 94441	-0.80311 13697	-3.24819 75822	-0.41901 54780
3	-5.52055 98281	0.86520 40259	-4.82009 92112	0.38040 64686
4	-6.78670 80901	-0.91085 07370	-6.16330 73556	-0.35790 79437
5	-7.94413 35871	0.94733 57094	-7.37217 72550	0.34230 12444

Table 9.9.2: Real zeros of Bi and Bi'.

$k$	$b_k$	$\text{Bi}'(b_k)$	$b'_k$	$\text{Bi}(b'_k)$
1	-1.17371 32227	0.60195 78880	-2.29443 96826	-0.45494 43836
2	-3.27109 33028	-0.76031 01415	-4.07315 50891	0.39652 28361
3	-4.83073 78417	0.83699 10126	-5.51239 57297	-0.36796 91615
4	-6.16985 21283	-0.88947 99014	-6.78129 44460	0.34949 91168
5	-7.37676 20794	0.92998 36386	-7.94017 86892	-0.33602 62401

Table 9.9.3: Complex zeros of Bi.

$k$	$e^{-\pi i/3} \beta_k$		$\text{Bi}'(\beta_k)$	
	modulus	phase	modulus	phase
1	2.35387 33809	0.09533 49591	0.99310 68457	2.64060 02521
2	4.09328 73094	0.04178 55604	1.13612 83345	-0.51328 28720
3	5.52350 35011	0.02668 05442	1.22374 37881	2.62462 83591
4	6.78865 95301	0.01958 69751	1.28822 92493	-0.51871 63829
5	7.94555 90160	0.01547 08228	1.33979 47726	2.62185 44560

Table 9.9.4: Complex zeros of Bi'.

$k$	$e^{-\pi i/3} \beta'_k$		$\text{Bi}(\beta'_k)$	
	modulus	phase	modulus	phase
1	1.12139 32942	0.33072 66208	0.75004 14897	0.46597 78930
2	3.25690 82266	0.05938 99367	0.59221 66315	-2.63235 40329
3	4.82400 26102	0.03278 56423	0.53787 06321	0.51549 32992
4	6.16568 66408	0.02266 24588	0.50611 02160	-2.62362 85920
5	7.37383 79870	0.01731 96481	0.48406 00643	0.51928 28169

## 9.10 Integrals

### 9.10(i) Indefinite Integrals

9.10.1  $\int_z^\infty \text{Ai}(t) dt = \pi (\text{Ai}(z) \text{Gi}'(z) - \text{Ai}'(z) \text{Gi}(z)),$

9.10.2  $\int_{-\infty}^z \text{Ai}(t) dt = \pi (\text{Ai}(z) \text{Hi}'(z) - \text{Ai}'(z) \text{Hi}(z)),$

9.10.3  $\int_{-\infty}^z \text{Bi}(t) dt = \int_0^z \text{Bi}(t) dt$   
 $= \pi (\text{Bi}'(z) \text{Gi}(z) - \text{Bi}(z) \text{Gi}'(z))$   
 $= \pi (\text{Bi}(z) \text{Hi}'(z) - \text{Bi}'(z) \text{Hi}(z)).$

For the functions Gi and Hi see §9.12.

### 9.10(ii) Asymptotic Approximations

9.10.4  $\int_x^\infty \text{Ai}(t) dt \sim \frac{1}{2} \pi^{-1/2} x^{-3/4} \exp\left(-\frac{2}{3} x^{3/2}\right), \quad x \rightarrow \infty,$

9.10.5  $\int_0^x \text{Bi}(t) dt \sim \pi^{-1/2} x^{-3/4} \exp\left(\frac{2}{3} x^{3/2}\right), \quad x \rightarrow \infty.$

9.10.6  $\int_{-\infty}^x \text{Ai}(t) dt = \pi^{-1/2} (-x)^{-3/4} \cos\left(\frac{2}{3} (-x)^{3/2} + \frac{1}{4} \pi\right)$   
 $+ O(|x|^{-9/4}), \quad x \rightarrow -\infty,$

### 9.10.7

$$\int_{-\infty}^x \text{Bi}(t) dt = \pi^{-1/2} (-x)^{-3/4} \sin\left(\frac{2}{3} (-x)^{3/2} + \frac{1}{4} \pi\right) + O(|x|^{-9/4}), \quad x \rightarrow -\infty.$$

For higher terms in (9.10.4)–(9.10.7) see Vallée and Soares (2004, §3.1.3). For error bounds see Boyd (1993). See also Muldoon (1970).

### 9.10(iii) Other Indefinite Integrals

Let  $w(z)$  be any solution of Airy's equation (9.2.1). Then

9.10.8  $\int zw(z) dz = w'(z),$

9.10.9  $\int z^2 w(z) dz = zw'(z) - w(z),$

### 9.10.10

$$\int z^{n+3} w(z) dz = z^{n+2} w'(z) - (n+2) z^{n+1} w(z) + (n+1)(n+2) \int z^n w(z) dz, \quad n = 0, 1, 2, \dots$$

See also §9.11(iv).

### 9.10(iv) Definite Integrals

9.10.11  $\int_0^\infty \text{Ai}(t) dt = \frac{1}{3}, \quad \int_{-\infty}^0 \text{Ai}(t) dt = \frac{2}{3},$

$$9.10.12 \quad \int_{-\infty}^0 \text{Bi}(t) dt = 0.$$

### 9.10(v) Laplace Transforms

$$9.10.13 \quad \int_{-\infty}^{\infty} e^{pt} \text{Ai}(t) dt = e^{p^3/3}, \quad \Re p > 0.$$

$$9.10.14 \quad \int_0^{\infty} e^{-pt} \text{Ai}(t) dt = e^{-p^3/3} \left( \frac{1}{3} - \frac{p {}_1F_1\left(\frac{1}{3}; \frac{4}{3}; \frac{1}{3}p^3\right)}{3^{4/3} \Gamma\left(\frac{4}{3}\right)} + \frac{p^2 {}_1F_1\left(\frac{2}{3}; \frac{5}{3}; \frac{1}{3}p^3\right)}{3^{5/3} \Gamma\left(\frac{5}{3}\right)} \right), \\ p \in \mathbb{C}.$$

$$9.10.15 \quad \int_0^{\infty} e^{-pt} \text{Ai}(-t) dt \\ = \frac{1}{3} e^{p^3/3} \left( \frac{\Gamma\left(\frac{1}{3}, \frac{1}{3}p^3\right)}{\Gamma\left(\frac{1}{3}\right)} + \frac{\Gamma\left(\frac{2}{3}, \frac{1}{3}p^3\right)}{\Gamma\left(\frac{2}{3}\right)} \right), \quad \Re p > 0,$$

$$9.10.16 \quad \int_0^{\infty} e^{-pt} \text{Bi}(-t) dt \\ = \frac{1}{\sqrt{3}} e^{p^3/3} \left( \frac{\Gamma\left(\frac{2}{3}, \frac{1}{3}p^3\right)}{\Gamma\left(\frac{2}{3}\right)} - \frac{\Gamma\left(\frac{1}{3}, \frac{1}{3}p^3\right)}{\Gamma\left(\frac{1}{3}\right)} \right), \\ \Re p > 0.$$

For the confluent hypergeometric function  ${}_1F_1$  and the incomplete gamma function  $\Gamma$  see §§13.1, 13.2, and 8.2(i).

For Laplace transforms of products of Airy functions see Shawagfeh (1992).

### 9.10(vi) Mellin Transform

$$9.10.17 \quad \int_0^{\infty} t^{\alpha-1} \text{Ai}(t) dt = \frac{\Gamma(\alpha)}{3^{(\alpha+2)/3} \Gamma\left(\frac{1}{3}\alpha + \frac{2}{3}\right)}, \quad \Re \alpha > 0.$$

### 9.10(vii) Stieltjes Transforms

$$9.10.18 \quad \text{Ai}(z) = \frac{z^{5/4} e^{-(2/3)z^{3/2}}}{2^{7/2}\pi} \int_0^{\infty} \frac{t^{-1/2} e^{-(2/3)t^{3/2}} \text{Ai}(t)}{z^{3/2} + t^{3/2}} dt, \\ |\text{ph } z| < \frac{2}{3}\pi.$$

$$9.10.19 \quad \text{Bi}(x) = \frac{x^{5/4} e^{(2/3)x^{3/2}}}{2^{5/2}\pi} \int_0^{\infty} \frac{t^{-1/2} e^{-(2/3)t^{3/2}} \text{Ai}(t)}{x^{3/2} - t^{3/2}} dt, \\ x > 0,$$

where the last integral is a Cauchy principal value (§1.4(v)).

### 9.10(viii) Repeated Integrals

$$9.10.20 \quad \int_0^x \int_0^v \text{Ai}(t) dt dv = x \int_0^x \text{Ai}(t) dt - \text{Ai}'(x) + \text{Ai}'(0),$$

$$9.10.21 \quad \int_0^x \int_0^v \text{Bi}(t) dt dv = x \int_0^x \text{Bi}(t) dt - \text{Bi}'(x) + \text{Bi}'(0),$$

$$9.10.22 \quad \int_0^{\infty} \int_t^{\infty} \cdots \int_t^{\infty} \text{Ai}(-t)(dt)^n = \frac{2 \cos\left(\frac{1}{3}(n-1)\pi\right)}{3^{(n+2)/3} \Gamma\left(\frac{1}{3}n + \frac{2}{3}\right)}, \\ n = 1, 2, \dots$$

### 9.10(ix) Compendia

For further integrals, including the Airy transform, see §9.11(iv), Widder (1979), Prudnikov *et al.* (1990, §1.8.1), Prudnikov *et al.* (1992a, pp. 405–413), Prudnikov *et al.* (1992b, §4.3.25), Vallée and Soares (2004, Chapters 3, 4).

## 9.11 Products

### 9.11(i) Differential Equation

$$9.11.1 \quad \frac{d^3 w}{dz^3} - 4z \frac{dw}{dz} - 2w = 0, \quad w = w_1 w_2,$$

where  $w_1$  and  $w_2$  are any solutions of (9.2.1). For example,  $w = \text{Ai}^2(z)$ ,  $\text{Ai}(z) \text{Bi}(z)$ ,  $\text{Ai}(z) \text{Ai}(ze^{\mp 2\pi i/3})$ ,  $M^2(z)$ . Numerically satisfactory triads of solutions can be constructed where needed on  $\mathbb{R}$  or  $\mathbb{C}$  by inspection of the asymptotic expansions supplied in §9.7.

### 9.11(ii) Wronskian

$$9.11.2 \quad \mathscr{W} \{ \text{Ai}^2(z), \text{Ai}(z) \text{Bi}(z), \text{Bi}^2(z) \} = 2\pi^{-3}.$$

### 9.11(iii) Integral Representations

$$9.11.3 \quad \text{Ai}^2(x) = \frac{1}{4\pi\sqrt{3}} \int_0^{\infty} J_0\left(\frac{1}{12}t^3 + xt\right) t dt, \quad x \geq 0,$$

where  $J_0$  is the Bessel function (§10.2(ii)).

$$9.11.4 \quad \text{Ai}^2(z) + \text{Bi}^2(z) = \frac{1}{\pi^{3/2}} \int_0^{\infty} \exp\left(z t - \frac{1}{12}t^3\right) t^{-1/2} dt.$$

For an integral representation of the Dirac delta involving a product of two Ai functions see §1.17(ii).

For further integral representations see Reid (1995, 1997a,b).

### 9.11(iv) Indefinite Integrals

Let  $w_1, w_2$  be any solutions of (9.2.1), not necessarily distinct. Then

$$9.11.5 \quad \int w_1 w_2 dz = -w_1' w_2' + z w_1 w_2,$$

$$9.11.6 \quad \int w_1 w_2' dz = \frac{1}{2} (w_1 w_2 + z \mathscr{W} \{w_1, w_2\}),$$

$$9.11.7 \quad \int w_1' w_2' dz = \frac{1}{3} (w_1 w_2' + w_1' w_2 + z w_1' w_2' - z^2 w_1 w_2),$$

$$9.11.8 \quad \int z w_1 w_2 dz = \frac{1}{6} (w_1 w_2' + w_1' w_2) - \frac{1}{3} (z w_1' w_2' - z^2 w_1 w_2),$$

$$9.11.9 \quad \int z w_1 w_2' dz = \frac{1}{2} w_1' w_2' + \frac{1}{4} z^2 \mathscr{W} \{w_1, w_2\},$$

$$9.11.10 \quad \int z w_1' w_2' dz = \frac{3}{10} (-w_1 w_2 + z w_1 w_2' + z w_1' w_2) + \frac{1}{5} (z^2 w_1' w_2' - z^3 w_1 w_2).$$

For  $\int z^n w_1 w_2 dz$ ,  $\int z^n w_1 w_2' dz$ ,  $\int z^n w_1' w_2' dz$ , where  $n$  is any positive integer, see Albright (1977). For related integrals see Gordon (1969, Appendix B).

For any continuously-differentiable function  $f$

$$9.11.11 \quad \int \frac{1}{w_1^2} f' \left( \frac{w_2}{w_1} \right) dz = \frac{1}{\mathscr{W} \{w_1, w_2\}} f \left( \frac{w_2}{w_1} \right).$$

#### Examples

$$9.11.12 \quad \int \frac{dz}{\text{Ai}^2(z)} = \pi \frac{\text{Bi}(z)}{\text{Ai}(z)},$$

$$9.11.13 \quad \int \frac{dz}{\text{Ai}(z) \text{Bi}(z)} = \pi \ln \left( \frac{\text{Bi}(z)}{\text{Ai}(z)} \right),$$

$$9.11.14 \quad \int \frac{\text{Ai}(z) \text{Bi}(z)}{(\text{Ai}^2(z) + \text{Bi}^2(z))^2} dz = \frac{\pi}{2} \frac{\text{Bi}^2(z)}{\text{Ai}^2(z) + \text{Bi}^2(z)}.$$

### 9.11(v) Definite Integrals

$$9.11.15 \quad \int_0^\infty t^{\alpha-1} \text{Ai}^2(t) dt = \frac{2 \Gamma(\alpha)}{\pi^{1/2} 12^{(2\alpha+5)/6} \Gamma(\frac{1}{3}\alpha + \frac{5}{6})}, \quad \Re \alpha > 0.$$

$$9.11.16 \quad \int_{-\infty}^\infty \text{Ai}^3(t) dt = \frac{\Gamma^2(\frac{1}{3})}{4\pi^2},$$

$$9.11.17 \quad \int_{-\infty}^\infty \text{Ai}^2(t) \text{Bi}(t) dt = \frac{\Gamma^2(\frac{1}{3})}{4\sqrt{3}\pi^2}.$$

$$9.11.18 \quad \int_0^\infty \text{Ai}^4(t) dt = \frac{\ln 3}{24\pi^2}.$$

$$9.11.19 \quad \int_0^\infty \frac{dt}{\text{Ai}^2(t) + \text{Bi}^2(t)} = \int_0^\infty \frac{t dt}{\text{Ai}'^2(t) + \text{Bi}'^2(t)} = \frac{\pi^2}{6}.$$

For further definite integrals see Prudnikov *et al.* (1990, §1.8.2), Laurenzi (1993), Reid (1995, 1997a,b), and Vallée and Soares (2004, Chapters 3, 4).

## Related Functions

### 9.12 Scorer Functions

#### 9.12(i) Differential Equation

$$9.12.1 \quad \frac{d^2 w}{dz^2} - zw = \frac{1}{\pi}.$$

Solutions of this equation are the *Scorer functions* and can be found by the method of variation of parameters (§1.13(iii)). The general solution is given by

$$9.12.2 \quad w(z) = A w_1(z) + B w_2(z) + p(z),$$

where  $A$  and  $B$  are arbitrary constants,  $w_1(z)$  and  $w_2(z)$  are any two linearly independent solutions of Airy's equation (9.2.1), and  $p(z)$  is any particular solution of (9.12.1). Standard particular solutions are

$$9.12.3 \quad -\text{Gi}(z), \quad \text{Hi}(z), \quad e^{\mp 2\pi i/3} \text{Hi}(ze^{\mp 2\pi i/3}),$$

where

$$9.12.4 \quad \text{Gi}(z) = \text{Bi}(z) \int_z^\infty \text{Ai}(t) dt + \text{Ai}(z) \int_0^z \text{Bi}(t) dt,$$

$$9.12.5 \quad \text{Hi}(z) = \text{Bi}(z) \int_{-\infty}^z \text{Ai}(t) dt - \text{Ai}(z) \int_{-\infty}^z \text{Bi}(t) dt.$$

$\text{Gi}(z)$  and  $\text{Hi}(z)$  are entire functions of  $z$ .

#### 9.12(ii) Graphs

See Figures 9.12.1 and 9.12.2.

#### 9.12(iii) Initial Values

$$9.12.6 \quad \begin{aligned} \text{Gi}(0) &= \frac{1}{2} \text{Hi}(0) = \frac{1}{3} \text{Bi}(0) \\ &= 1 / \left( 3^{7/6} \Gamma(\frac{2}{3}) \right) = 0.20497 \, 55424 \dots, \end{aligned}$$

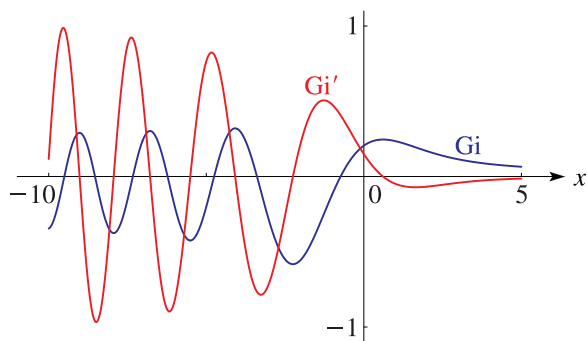
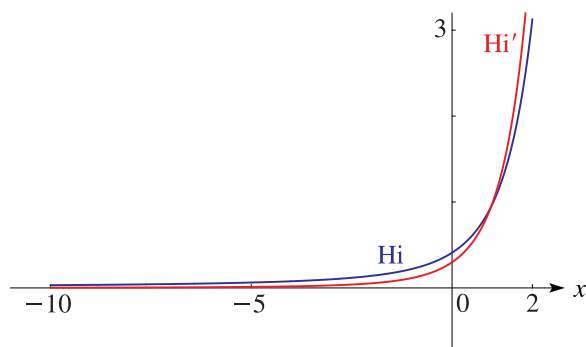
$$9.12.7 \quad \begin{aligned} \text{Gi}'(0) &= \frac{1}{2} \text{Hi}'(0) = \frac{1}{3} \text{Bi}'(0) = 1 / \left( 3^{5/6} \Gamma(\frac{1}{3}) \right) \\ &= 0.14942 \, 94524 \dots \end{aligned}$$

#### 9.12(iv) Numerically Satisfactory Solutions

$-\text{Gi}(x)$  is a numerically satisfactory companion to the complementary functions  $\text{Ai}(x)$  and  $\text{Bi}(x)$  on the interval  $0 \leq x < \infty$ .  $\text{Hi}(x)$  is a numerically satisfactory companion to  $\text{Ai}(x)$  and  $\text{Bi}(x)$  on the interval  $-\infty < x \leq 0$ .

In  $\mathbb{C}$ , numerically satisfactory sets of solutions are given by

$$9.12.8 \quad -\text{Gi}(z), \text{Ai}(z), \text{Bi}(z), \quad |\text{ph } z| \leq \frac{1}{3}\pi,$$

Figure 9.12.1:  $\text{Gi}(x)$ ,  $\text{Gi}'(x)$ .Figure 9.12.2:  $\text{Hi}(x)$ ,  $\text{Hi}'(x)$ .**9.12.9**

$$\text{Hi}(z), \text{Ai}\left(ze^{-2\pi i/3}\right), \text{Ai}\left(ze^{2\pi i/3}\right), \quad |\text{ph}(-z)| \leq \frac{2}{3}\pi,$$

and

$$\text{9.12.10} \quad e^{\mp 2\pi i/3} \text{Hi}\left(ze^{\mp 2\pi i/3}\right), \text{Ai}(z), \text{Ai}\left(ze^{\pm 2\pi i/3}\right), \\ -\pi \leq \pm \text{ph} z \leq \frac{1}{3}\pi.$$

**9.12(v) Connection Formulas**

$$\text{9.12.11} \quad \text{Gi}(z) + \text{Hi}(z) = \text{Bi}(z),$$

**9.12.12**

$$\text{Gi}(z) = \frac{1}{2}e^{\pi i/3} \text{Hi}\left(ze^{-2\pi i/3}\right) + \frac{1}{2}e^{-\pi i/3} \text{Hi}\left(ze^{2\pi i/3}\right),$$

$$\text{9.12.13} \quad \text{Gi}(z) = e^{\mp \pi i/3} \text{Hi}\left(ze^{\pm 2\pi i/3}\right) \pm i \text{Ai}(z),$$

**9.12.14**

$$\text{Hi}(z) = e^{\pm 2\pi i/3} \text{Hi}\left(ze^{\pm 2\pi i/3}\right) + 2e^{\mp \pi i/6} \text{Ai}\left(ze^{\mp 2\pi i/3}\right).$$

**9.12(vi) Maclaurin Series****9.12.15**

$$\text{Gi}(z) = \frac{3^{-2/3}}{\pi} \sum_{k=0}^{\infty} \cos\left(\frac{2k-1}{3}\pi\right) \Gamma\left(\frac{k+1}{3}\right) \frac{(3^{1/3}z)^k}{k!},$$

**9.12.16**

$$\text{Gi}'(z) = \frac{3^{-1/3}}{\pi} \sum_{k=0}^{\infty} \cos\left(\frac{2k+1}{3}\pi\right) \Gamma\left(\frac{k+2}{3}\right) \frac{(3^{1/3}z)^k}{k!}.$$

$$\text{9.12.17} \quad \text{Hi}(z) = \frac{3^{-2/3}}{\pi} \sum_{k=0}^{\infty} \Gamma\left(\frac{k+1}{3}\right) \frac{(3^{1/3}z)^k}{k!},$$

$$\text{9.12.18} \quad \text{Hi}'(z) = \frac{3^{-1/3}}{\pi} \sum_{k=0}^{\infty} \Gamma\left(\frac{k+2}{3}\right) \frac{(3^{1/3}z)^k}{k!}.$$

**9.12(vii) Integral Representations**

$$\text{9.12.19} \quad \text{Gi}(x) = \frac{1}{\pi} \int_0^{\infty} \sin\left(\frac{1}{3}t^3 + xt\right) dt, \quad x \in \mathbb{R}.$$

$$\text{9.12.20} \quad \text{Hi}(z) = \frac{1}{\pi} \int_0^{\infty} \exp\left(-\frac{1}{3}t^3 + zt\right) dt,$$

**9.12.21**

$$\text{Gi}(z) = -\frac{1}{\pi} \int_0^{\infty} \exp\left(-\frac{1}{3}t^3 - \frac{1}{2}zt\right) \cos\left(\frac{1}{2}\sqrt{3}zt + \frac{2}{3}\pi\right) dt.$$

If  $\zeta = \frac{2}{3}z^{3/2}$  or  $\frac{2}{3}x^{3/2}$ , and  $K_{1/3}$  is the modified Bessel function (§10.25(ii)), then

$$\text{9.12.22} \quad \text{Hi}(-z) = \frac{4z^2}{3^{3/2}\pi^2} \int_0^{\infty} \frac{K_{1/3}(t)}{\zeta^2 + t^2} dt, \quad |\text{ph} z| < \frac{1}{3}\pi,$$

$$\text{9.12.23} \quad \text{Gi}(x) = \frac{4x^2}{3^{3/2}\pi^2} \int_0^{\infty} \frac{K_{1/3}(t)}{\zeta^2 - t^2} dt, \quad x > 0,$$

where the last integral is a Cauchy principal value (§1.4(v)).

**Mellin–Barnes Type Integral****9.12.24**

$$\text{Hi}(z) = \frac{3^{-2/3}}{2\pi^2 i} \int_{-i\infty}^{i\infty} \Gamma\left(\frac{1}{3} + \frac{1}{3}t\right) \Gamma(-t) (3^{1/3}e^{\pi i}z)^t dt,$$

where the integration contour separates the poles of  $\Gamma\left(\frac{1}{3} + \frac{1}{3}t\right)$  from those of  $\Gamma(-t)$ .

**9.12(viii) Asymptotic Expansions****Functions and Derivatives**

As  $z \rightarrow \infty$ , and with  $\delta$  denoting an arbitrary small positive constant,

$$\text{9.12.25} \quad \text{Gi}(z) \sim \frac{1}{\pi z} \sum_{k=0}^{\infty} \frac{(3k)!}{k!(3z^3)^k}, \quad |\text{ph} z| \leq \frac{1}{3}\pi - \delta,$$

$$\text{9.12.26} \quad \text{Gi}'(z) \sim -\frac{1}{\pi z^2} \sum_{k=0}^{\infty} \frac{(3k+1)!}{k!(3z^3)^k}, \quad |\text{ph} z| \leq \frac{1}{3}\pi - \delta.$$

**9.12.27**

$$\text{Hi}(z) \sim -\frac{1}{\pi z} \sum_{k=0}^{\infty} \frac{(3k)!}{k!(3z^3)^k}, \quad |\text{ph}(-z)| \leq \frac{2}{3}\pi - \delta,$$

9.12.28

$$\text{Hi}'(z) \sim \frac{1}{\pi z^2} \sum_{k=0}^{\infty} \frac{(3k+1)!}{k!(3z^3)^k}, \quad |\text{ph}(-z)| \leq \frac{2}{3}\pi - \delta.$$

For other phase ranges combine these results with the connection formulas (9.12.11)–(9.12.14) and the asymptotic expansions given in §9.7. For example, with the notation of §9.7(i).

$$\begin{aligned} \text{9.12.29} \quad \text{Hi}(z) &\sim -\frac{1}{\pi z} \sum_{k=0}^{\infty} \frac{(3k)!}{k!(3z^3)^k} + \frac{e^\zeta}{\sqrt{\pi}z^{1/4}} \sum_{k=0}^{\infty} \frac{u_k}{\zeta^k}, \\ &|\text{ph } z| \leq \pi - \delta. \end{aligned}$$

Integrals

9.12.30

$$\int_0^z \text{Gi}(t) dt \sim \frac{1}{\pi} \ln z + \frac{2\gamma + \ln 3}{3\pi} - \frac{1}{\pi} \sum_{k=1}^{\infty} \frac{(3k-1)!}{k!(3z^3)^k}, \quad |\text{ph } z| \leq \frac{1}{3}\pi - \delta.$$

$$\begin{aligned} \int_0^z \text{Hi}(-t) dt &\sim \frac{1}{\pi} \ln z + \frac{2\gamma + \ln 3}{3\pi} \\ \text{9.12.31} \quad &+ \frac{1}{\pi} \sum_{k=1}^{\infty} (-1)^{k-1} \frac{(3k-1)!}{k!(3z^3)^k}, \\ &|\text{ph } z| \leq \frac{2}{3}\pi - \delta, \end{aligned}$$

where  $\gamma$  is Euler's constant (§5.2(ii)).

9.12(ix) Zeros

All zeros, real or complex, of  $\text{Gi}(z)$  and  $\text{Hi}(z)$  are simple.

Neither  $\text{Hi}(z)$  nor  $\text{Hi}'(z)$  has real zeros.

$\text{Gi}(z)$  has no nonnegative real zeros and  $\text{Gi}'(z)$  has exactly one nonnegative real zero, given by  $z = 0.60907\ 54170\ 7\dots$ . Both  $\text{Gi}(z)$  and  $\text{Gi}'(z)$  have an infinity of negative real zeros, and they are interlaced.

For the above properties and further results, including the distribution of complex zeros, asymptotic approximations for the numerically large real or complex zeros, and numerical tables see Gil *et al.* (2003c).

For graphical illustration of the real zeros see Figures 9.12.1 and 9.12.2.

As  $z \rightarrow \infty$

$$\text{9.13.9} \quad A_n(z) = \sqrt{p/\pi} \sin(p\pi) z^{-n/4} e^{-\zeta} (1 + O(\zeta^{-1})), \quad |\text{ph } z| \leq 3p\pi - \delta,$$

$$\text{9.13.10} \quad A_n(-z) = \begin{cases} 2\sqrt{p/\pi} \cos(\frac{1}{2}p\pi) z^{-n/4} (\cos(\zeta - \frac{1}{4}\pi) + e^{|\Im\zeta|} O(\zeta^{-1})), & |\text{ph } z| \leq 2p\pi - \delta, n \text{ odd}, \\ \sqrt{p/\pi} z^{-n/4} e^\zeta (1 + O(\zeta^{-1})), & |\text{ph } z| \leq p\pi - \delta, n \text{ even}, \end{cases}$$

$$\text{9.13.11} \quad B_n(z) = \pi^{-1/2} z^{-n/4} e^\zeta (1 + O(\zeta^{-1})), \quad |\text{ph } z| \leq p\pi - \delta,$$

$$\text{9.13.12} \quad B_n(-z) = \begin{cases} -(2/\sqrt{\pi}) \sin(\frac{1}{2}p\pi) z^{-n/4} (\sin(\zeta - \frac{1}{4}\pi) + e^{|\Im\zeta|} O(\zeta^{-1})), & |\text{ph } z| \leq 2p\pi - \delta, n \text{ odd}, \\ (1/\sqrt{\pi}) \sin(p\pi) z^{-n/4} e^{-\zeta} (1 + O(\zeta^{-1})), & |\text{ph } z| \leq 3p\pi - \delta, n \text{ even}. \end{cases}$$

9.13 Generalized Airy Functions

9.13(i) Generalizations from the Differential Equation

Equations of the form

$$\text{9.13.1} \quad \frac{d^2 w}{dz^2} = z^n w, \quad n = 1, 2, 3, \dots,$$

are used in approximating solutions to differential equations with multiple turning points; see §2.8(v). The general solution of (9.13.1) is given by

$$\text{9.13.2} \quad w = z^{1/2} \mathcal{Z}_p(\zeta),$$

where

$$\text{9.13.3} \quad p = \frac{1}{n+2}, \quad \zeta = \frac{2}{n+2} z^{(n+2)/2} = 2pz^{1/(2p)},$$

and  $\mathcal{Z}_p$  is any linear combination of the modified Bessel functions  $I_p$  and  $e^{p\pi i} K_p$  (§10.25(ii)).

Swanson and Headley (1967) define independent solutions  $A_n(z)$  and  $B_n(z)$  of (9.13.1) by

$$\begin{aligned} \text{9.13.4} \quad A_n(z) &= (2p/\pi) \sin(p\pi) z^{1/2} K_p(\zeta), \\ B_n(z) &= (pz)^{1/2} (I_{-p}(\zeta) + I_p(\zeta)), \end{aligned}$$

when  $z$  is real and positive, and by analytic continuation elsewhere. (All solutions of (9.13.1) are entire functions of  $z$ .) When  $n = 1$ ,  $A_n(z)$  and  $B_n(z)$  become  $\text{Ai}(z)$  and  $\text{Bi}(z)$ , respectively.

Properties of  $A_n(z)$  and  $B_n(z)$  follow from the corresponding properties of the modified Bessel functions. They include:

$$\begin{aligned} \text{9.13.5} \quad A_n(0) &= p^{1/2} B_n(0) = \frac{p^{1-p}}{\Gamma(1-p)}, \\ -A_n'(0) &= p^{1/2} B_n'(0) = \frac{p^p}{\Gamma(p)}. \end{aligned}$$

$$\text{9.13.6} \quad A_n(-z) = \begin{cases} pz^{1/2} (J_{-p}(\zeta) + J_p(\zeta)), & n \text{ odd}, \\ p^{1/2} B_n(z), & n \text{ even}, \end{cases}$$

$$\text{9.13.7} \quad B_n(-z) = \begin{cases} (pz)^{1/2} (J_{-p}(\zeta) - J_p(\zeta)), & n \text{ odd}, \\ p^{-1/2} A_n(z), & n \text{ even}. \end{cases}$$

$$\text{9.13.8} \quad \mathcal{W} \{A_n(z), B_n(z)\} = \frac{2}{\pi} p^{1/2} \sin(p\pi).$$

The distribution in  $\mathbb{C}$  and asymptotic properties of the zeros of  $A_n(z)$ ,  $A'_n(z)$ ,  $B_n(z)$ , and  $B'_n(z)$  are investigated in Swanson and Headley (1967) and Headley and Barwell (1975).

In Olver (1977a, 1978) a different normalization is used. In place of (9.13.1) we have

$$9.13.13 \quad \frac{d^2 w}{dt^2} = \frac{1}{4} m^2 t^{m-2} w,$$

where  $m = 3, 4, 5, \dots$ . For real variables the solutions of (9.13.13) are denoted by  $U_m(t)$ ,  $U_m(-t)$  when  $m$  is even, and by  $V_m(t)$ ,  $\bar{V}_m(t)$  when  $m$  is odd. (The overbar has nothing to do with complex conjugates.) Their relations to the functions  $A_n(z)$  and  $B_n(z)$  are given by

$$9.13.14 \quad m = n + 2 = 1/p, \quad t = (\tfrac{1}{2}m)^{-2/m} z = \zeta^{2/m},$$

$$\sqrt{2\pi} \left(\tfrac{1}{2}m\right)^{(m-1)/m} \csc(\pi/m) A_n(z)$$

$$9.13.15 \quad = \begin{cases} U_m(t), & m \text{ even,} \\ V_m(t), & m \text{ odd,} \end{cases}$$

$$\sqrt{\pi} \left(\tfrac{1}{2}m\right)^{(m-2)/(2m)} \csc(\pi/m) B_n(z)$$

$$9.13.16 \quad = \begin{cases} U_m(-t), & m \text{ even,} \\ \bar{V}_m(t), & m \text{ odd.} \end{cases}$$

Properties and graphs of  $U_m(t)$ ,  $V_m(t)$ ,  $\bar{V}_m(t)$  are included in Olver (1977a) together with properties and graphs of real solutions of the equation

$$9.13.17 \quad \frac{d^2 w}{dt^2} = -\frac{1}{4} m^2 t^{m-2} w, \quad m \text{ even,}$$

which are denoted by  $W_m(t)$ ,  $W_m(-t)$ .

In  $\mathbb{C}$ , the solutions of (9.13.13) used in Olver (1978) are

$$9.13.18 \quad w = U_m(te^{-2j\pi i/m}), \quad j = 0, \pm 1, \pm 2, \dots$$

The function on the right-hand side is recessive in the sector  $-(2j-1)\pi/m \leq \text{ph } z \leq (2j+1)\pi/m$ , and is therefore an essential member of any numerically satisfactory pair of solutions in this region.

Another normalization of (9.13.17) is used in Smirnov (1960), given by

$$9.13.19 \quad \frac{d^2 w}{dx^2} + x^\alpha w = 0,$$

where  $\alpha > -2$  and  $x > 0$ . Solutions are  $w = U_1(x, \alpha)$ ,  $U_2(x, \alpha)$ , where

$$9.13.20 \quad \begin{aligned} U_1(x, \alpha) &= \frac{1}{(\alpha + 2)^{1/(\alpha+2)}} \\ &\times \Gamma\left(\frac{\alpha+1}{\alpha+2}\right) x^{1/2} J_{-1/(\alpha+2)}\left(\frac{2}{\alpha+2} x^{(\alpha+2)/2}\right), \end{aligned}$$

### 9.13.21

$$U_2(x, \alpha) = (\alpha + 2)^{1/(\alpha+2)} \times \Gamma\left(\frac{\alpha+3}{\alpha+2}\right) x^{1/2} J_{1/(\alpha+2)}\left(\frac{2}{\alpha+2} x^{(\alpha+2)/2}\right),$$

and  $J$  denotes the Bessel function (§10.2(ii)).

When  $\alpha$  is a positive integer the relation of these functions to  $W_m(t)$ ,  $W_m(-t)$  is as follows:

$$9.13.22 \quad \alpha = m - 2, \quad x = (m/2)^{2/m} t,$$

### 9.13.23

$$U_1(x, \alpha) = \frac{\pi^{1/2}}{2^{(m+2)/(2m)} \Gamma(1/m)} (W_m(t) + W_m(-t)),$$

### 9.13.24

$$U_2(x, \alpha) = \frac{\pi^{1/2} m^{2/m}}{2^{(m+2)/(2m)} \Gamma(-1/m)} (W_m(t) - W_m(-t)).$$

For properties of the zeros of the functions defined in this subsection see Laforgia and Muldoon (1988) and references given therein.

## 9.13(ii) Generalizations from Integral Representations

Reid (1972) and Drazin and Reid (1981, Appendix) introduce the following contour integrals in constructing approximate solutions to the Orr–Sommerfeld equation for fluid flow:

$$9.13.25 \quad A_k(z, p) = \frac{1}{2\pi i} \int_{\mathcal{L}_k} t^{-p} \exp\left(zt - \frac{1}{3}t^3\right) dt, \quad k = 1, 2, 3, p \in \mathbb{C},$$

$$9.13.26 \quad B_0(z, p) = \frac{1}{2\pi i} \int_{\mathcal{L}_0} t^{-p} \exp\left(zt - \frac{1}{3}t^3\right) dt, \quad p = 0, \pm 1, \pm 2, \dots,$$

$$9.13.27 \quad B_k(z, p) = \int_{\mathcal{I}_k} t^{-p} \exp\left(zt - \frac{1}{3}t^3\right) dt, \quad k = 1, 2, 3, p = 0, \pm 1, \pm 2, \dots,$$

with  $z \in \mathbb{C}$  in all cases. The integration paths  $\mathcal{L}_0$ ,  $\mathcal{L}_1$ ,  $\mathcal{L}_2$ ,  $\mathcal{L}_3$  are depicted in Figure 9.13.1.  $\mathcal{I}_1$ ,  $\mathcal{I}_2$ ,  $\mathcal{I}_3$  are depicted in Figure 9.13.2. When  $p$  is not an integer the branch of  $t^{-p}$  in (9.13.25) is usually chosen to be  $\exp(-p(\ln|t| + i \text{ph } t))$  with  $0 \leq \text{ph } t < 2\pi$ .



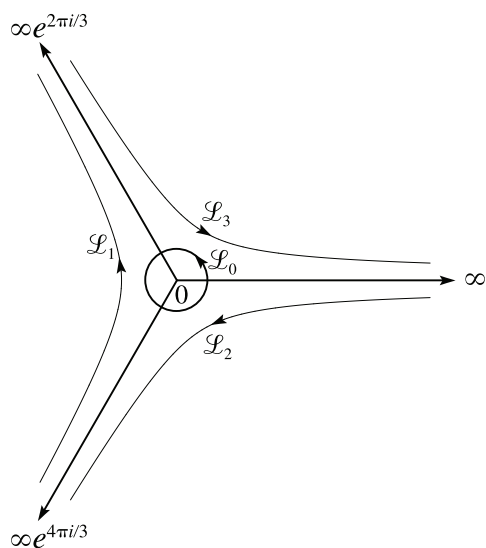


Figure 9.13.1:  $t$ -plane. Paths  $\mathcal{L}_0, \mathcal{L}_1, \mathcal{L}_2, \mathcal{L}_3$ .

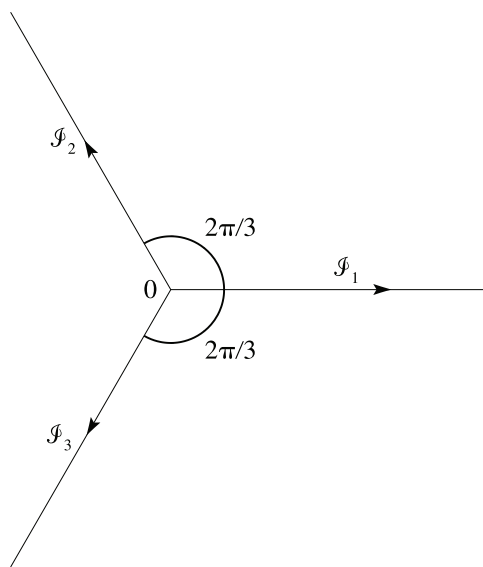


Figure 9.13.2:  $t$ -plane. Paths  $\mathcal{I}_1, \mathcal{I}_2, \mathcal{I}_3$ .

When  $p = 0$

9.13.28  $A_1(z, 0) = \text{Ai}(z),$

9.13.29  $A_2(z, 0) = e^{2\pi i/3} \text{Ai}\left(ze^{2\pi i/3}\right),$

$A_3(z, 0) = e^{-2\pi i/3} \text{Ai}\left(ze^{-2\pi i/3}\right),$

and

9.13.30  $B_0(z, 0) = 0, \quad B_1(z, 0) = \pi \text{Hi}(z).$

Each of the functions  $A_k(z, p)$  and  $B_k(z, p)$  satisfies the differential equation

9.13.31  $\frac{d^3 w}{dz^3} - z \frac{dw}{dz} + (p - 1)w = 0,$

and the difference equation

9.13.32  $f(p - 3) - zf(p - 1) + (p - 1)f(p) = 0.$

The  $A_k(z, p)$  are related by

9.13.33  $A_2(z, p) = e^{-2(p-1)\pi i/3} A_1\left(ze^{2\pi i/3}, p\right),$

$A_3(z, p) = e^{2(p-1)\pi i/3} A_1\left(ze^{-2\pi i/3}, p\right).$

Connection formulas for the solutions of (9.13.31) include

9.13.34  $A_1(z, p) + A_2(z, p) + A_3(z, p) + B_0(z, p) = 0,$

9.13.35  $B_2(z, p) - B_3(z, p) = 2\pi i A_1(z, p),$

9.13.36  $B_3(z, p) - B_1(z, p) = 2\pi i A_2(z, p),$

9.13.37  $B_1(z, p) - B_2(z, p) = 2\pi i A_3(z, p).$

Further properties of these functions, and also of similar contour integrals containing an additional factor  $(\ln t)^q, q = 1, 2, \dots,$  in the integrand, are derived

in Reid (1972), Drazin and Reid (1981, Appendix), and Baldwin (1985). These properties include Wronskians, asymptotic expansions, and information on zeros.

For further generalizations via integral representations see Chin and Hedstrom (1978), Janson *et al.* (1993, §10), and Kamimoto (1998).

### 9.14 Incomplete Airy Functions

Incomplete Airy functions are defined by the contour integral (9.5.4) when one of the integration limits is replaced by a variable real or complex parameter. For information, including asymptotic approximations, computation, and applications, see Levey and Felsen (1969), Constantinides and Marhefka (1993), and Michaeli (1996).

## Applications

### 9.15 Mathematical Applications

Airy functions play an indispensable role in the construction of uniform asymptotic expansions for contour integrals with coalescing saddle points, and for solutions of linear second-order ordinary differential equations with a simple turning point. For descriptions of, and references to, the underlying theory see §§2.4(v) and 2.8(iii).

## 9.16 Physical Applications

Airy functions are applied in many branches of both classical and quantum physics. The function  $\text{Ai}(x)$  first appears as an integral in two articles by G.B. Airy on the intensity of light in the neighborhood of a caustic (Airy (1838, 1849)). Details of the Airy theory are given in van de Hulst (1957) in the chapter on the optics of a raindrop. See also Berry (1966, 1969).

The frequent appearances of the Airy functions in both classical and quantum physics is associated with wave equations with turning points, for which asymptotic (WKBJ) solutions are exponential on one side and oscillatory on the other. The Airy functions constitute uniform approximations whose region of validity includes the turning point and its neighborhood. Within classical physics, they appear prominently in physical optics, electromagnetism, radiative transfer, fluid mechanics, and nonlinear wave propagation. Examples dealing with the propagation of light and with radiation of electromagnetic waves are given in Landau and Lifshitz (1962). Extensive use is made of Airy functions in investigations in the theory of electromagnetic diffraction and radiowave propagation (Fock (1965)). A quite different application is made in the study of the diffraction of sound pulses by a circular cylinder (Friedlander (1958)).

In fluid dynamics, Airy functions enter several topics. In the study of the stability of a two-dimensional viscous fluid, the flow is governed by the Orr–Sommerfeld equation (a fourth-order differential equation). Again, the quest for asymptotic approximations that are uniformly valid solutions to this equation in the neighborhoods of critical points leads (after choosing solvable equations with similar asymptotic properties) to Airy functions. Other applications appear in the study of instability of Couette flow of an inviscid fluid. These examples of transitions to turbulence are presented in detail in Drazin and Reid (1981) with the problem of hydrodynamic stability. The investigation of the transition between subsonic and supersonic of a two-dimensional gas flow leads to the Euler–Tricomi equation (Landau and Lifshitz (1987)). An application of Airy functions to the solution of this equation is given in Gramtcheff (1981).

Airy functions play a prominent role in problems defined by nonlinear wave equations. These first appeared in connection with the equation governing the evolution of long shallow water waves of permanent form, generally called solitons, and are predicted by the Korteweg–de Vries (KdV) equation (a third-order nonlinear partial differential equation). The KdV equation and solitons have applications in many branches of physics, including plasma physics lattice dynamics, and quantum mechan-

ics. (Ablowitz and Segur (1981), Ablowitz and Clarkson (1991), and Whitham (1974).)

Reference to many of these applications as well as to the theory of elasticity and to the heat equation are given in Vallée and Soares (2004): a book devoted specifically to the Airy and Scorer functions and their applications in physics.

An example from quantum mechanics is given in Landau and Lifshitz (1965), in which the exact solution of the Schrödinger equation for the motion of a particle in a homogeneous external field is expressed in terms of  $\text{Ai}(x)$ . Solutions of the Schrödinger equation involving the Airy functions are given for other potentials in Vallée and Soares (2004). This reference provides several examples of applications to problems in quantum mechanics in which Airy functions give uniform asymptotic approximations, valid in the neighborhood of a turning point. A study of the semiclassical description of quantum-mechanical scattering is given in Ford and Wheeler (1959a,b). In the case of the rainbow, the scattering amplitude is expressed in terms of  $\text{Ai}(x)$ , the analysis being similar to that given originally by Airy (1838) for the corresponding problem in optics.

An application of the Scorer functions is to the problem of the uniform loading of infinite plates (Rothman (1954a,b)).

## Computation

### 9.17 Methods of Computation

#### 9.17(i) Maclaurin Expansions

Although the Maclaurin-series expansions of §§9.4 and 9.12(vi) converge for all finite values of  $z$ , they are cumbersome to use when  $|z|$  is large owing to slowness of convergence and cancellation. For large  $|z|$  the asymptotic expansions of §§9.7 and 9.12(viii) should be used instead. Since these expansions diverge, the accuracy they yield is limited by the magnitude of  $|z|$ . However, in the case of  $\text{Ai}(z)$  and  $\text{Bi}(z)$  this accuracy can be increased considerably by use of the exponentially-improved forms of expansion supplied in §9.7(v).

#### 9.17(ii) Differential Equations

A comprehensive and powerful approach is to integrate the defining differential equation (9.2.1) by direct numerical methods. As described in §3.7(ii), to ensure stability the integration path must be chosen in such a way that as we proceed along it the wanted solution grows at least as fast as all other solutions of the differential equation. In the case of  $\text{Ai}(z)$ , for example, this means

that in the sectors  $\frac{1}{3}\pi < |\text{ph } z| < \pi$  we may integrate along outward rays from the origin with initial values obtained from §9.2(ii). But when  $|\text{ph } z| < \frac{1}{3}\pi$  the integration has to be towards the origin, with starting values of  $\text{Ai}(z)$  and  $\text{Ai}'(z)$  computed from their asymptotic expansions. On the remaining rays, given by  $\text{ph } z = \pm\frac{1}{3}\pi$  and  $\pi$ , integration can proceed in either direction.

For further information see Lozier and Olver (1993) and Fabijonas *et al.* (2004). The former reference includes a parallelized version of the method.

In the case of the Scorer functions, integration of the differential equation (9.12.1) is more difficult than (9.2.1), because in some regions stable directions of integration do not exist. An example is provided by  $\text{Gi}(x)$  on the positive real axis. In these cases boundary-value methods need to be used instead; see §3.7(iii).

### 9.17(iii) Integral Representations

Among the integral representations of the Airy functions the Stieltjes transform (9.10.18) furnishes a way of computing  $\text{Ai}(z)$  in the complex plane, once values of this function can be generated on the positive real axis. For details, including the application of a generalized form of Gaussian quadrature, see Gordon (1969, Appendix A) and Schulden *et al.* (1979).

Gil *et al.* (2002a) describes two methods for the computation of  $\text{Ai}(z)$  and  $\text{Ai}'(z)$  for  $z \in \mathbb{C}$ . In the first method the integration path for the contour integral (9.5.4) is deformed to coincide with paths of steepest descent (§2.4(iv)). The trapezoidal rule (§3.5(i)) is then applied. The second method is to apply generalized Gauss–Laguerre quadrature (§3.5(v)) to the integral (9.5.8). For the second method see also Gautschi (2002a). The methods for  $\text{Ai}'(z)$  are similar.

For quadrature methods for Scorer functions see Gil *et al.* (2001), Lee (1980), and Gordon (1970, Appendix A); but see also Gautschi (1983).

### 9.17(iv) Via Bessel Functions

In consequence of §9.6(i), algorithms for generating Bessel functions, Hankel functions, and modified Bessel functions (§10.74) can also be applied to  $\text{Ai}(z)$ ,  $\text{Bi}(z)$ , and their derivatives.

### 9.17(v) Zeros

Zeros of the Airy functions, and their derivatives, can be computed to high precision via Newton's rule (§3.8(ii)) or Halley's rule (§3.8(v)), using values supplied by the asymptotic expansions of §9.9(iv) as initial approximations. This method was used in the computation of the tables in §9.9(v). See also Fabijonas *et al.* (2004).

For the computation of the zeros of the Scorer functions and their derivatives see Gil *et al.* (2003c).

## 9.18 Tables

### 9.18(i) Introduction

Additional listings of early tables of the functions treated in this chapter are given in Fletcher *et al.* (1962) and Lebedev and Fedorova (1960).

### 9.18(ii) Real Variables

- Miller (1946) tabulates  $\text{Ai}(x)$ ,  $\text{Ai}'(x)$  for  $x = -20(.01)2$ ;  $\log_{10} \text{Ai}(x)$ ,  $\text{Ai}'(x)/\text{Ai}(x)$  for  $x = 0(.1)25(1)75$ ;  $\text{Bi}(x)$ ,  $\text{Bi}'(x)$  for  $x = -10(.1)2.5$ ;  $\log_{10} \text{Bi}(x)$ ,  $\text{Bi}'(x)/\text{Bi}(x)$  for  $x = 0(.1)10$ ;  $M(x)$ ,  $N(x)$ ,  $\theta(x)$ ,  $\phi(x)$  (respectively  $F(x)$ ,  $G(x)$ ,  $\chi(x)$ ,  $\psi(x)$ ) for  $x = -80(1) - 30(.1)0$ . Precision is generally 8D; slightly less for some of the auxiliary functions. Extracts from these tables are included in Abramowitz and Stegun (1964, Chapter 10), together with some auxiliary functions for large arguments.
- Fox (1960, Table 3) tabulates  $2\pi^{1/2}x^{1/4} \times \exp(\frac{2}{3}x^{3/2}) \text{Ai}(x)$ ,  $2\pi^{1/2}x^{-1/4} \exp(\frac{2}{3}x^{3/2}) \text{Ai}'(x)$ ,  $\pi^{1/2}x^{1/4} \exp(-\frac{2}{3}x^{3/2}) \text{Bi}(x)$ , and  $\pi^{1/2}x^{-1/4} \times \exp(-\frac{2}{3}x^{3/2}) \text{Bi}'(x)$  for  $\frac{3}{2}x^{-3/2} = 0(.001)0.05$ , together with similar auxiliary functions for negative values of  $x$ . Precision is 10D.
- Zhang and Jin (1996, p. 337) tabulates  $\text{Ai}(x)$ ,  $\text{Ai}'(x)$ ,  $\text{Bi}(x)$ ,  $\text{Bi}'(x)$  for  $x = 0(1)20$  to 8S and for  $x = -20(1)0$  to 9D.
- Yakovleva (1969) tabulates Fock's functions  $U(x) \equiv \sqrt{\pi} \text{Bi}(x)$ ,  $U'(x) \equiv \sqrt{\pi} \text{Bi}'(x)$ ,  $V(x) \equiv \sqrt{\pi} \text{Ai}(x)$ ,  $V'(x) \equiv \sqrt{\pi} \text{Ai}'(x)$  for  $x = -9(.001)9$ . Precision is 7S.

### 9.18(iii) Complex Variables

- Woodward and Woodward (1946) tabulates the real and imaginary parts of  $\text{Ai}(z)$ ,  $\text{Ai}'(z)$ ,  $\text{Bi}(z)$ ,  $\text{Bi}'(z)$  for  $\Re z = -2.4(.2)2.4$ ,  $\Im z = -2.4(.2)0$ . Precision is 4D.
- Harvard (1945) tabulates the real and imaginary parts of  $h_1(z)$ ,  $h_1'(z)$ ,  $h_2(z)$ ,  $h_2'(z)$  for  $-x_0 \leq \Re z \leq x_0$ ,  $0 \leq \Im z \leq y_0$ ,  $|x_0 + iy_0| < 6.1$ , with interval 0.1 in  $\Re z$  and  $\Im z$ . Precision is 8D. Here  $h_1(z) = -2^{4/3}3^{1/6}i \text{Ai}(e^{-\pi i/3}z)$ ,  $h_2(z) = 2^{4/3}3^{1/6}i \text{Ai}(e^{\pi i/3}z)$ .

**9.18(iv) Zeros**

- Miller (1946) tabulates  $a_k$ ,  $\text{Ai}'(a_k)$ ,  $a'_k$ ,  $\text{Ai}(a'_k)$ ,  $k = 1(1)50$ ;  $b_k$ ,  $\text{Bi}'(b_k)$ ,  $b'_k$ ,  $\text{Bi}(b'_k)$ ,  $k = 1(1)20$ . Precision is 8D. Entries for  $k = 1(1)20$  are reproduced in Abramowitz and Stegun (1964, Chapter 10).
- Sherry (1959) tabulates  $a_k$ ,  $\text{Ai}'(a_k)$ ,  $a'_k$ ,  $\text{Ai}(a'_k)$ ,  $k = 1(1)50$ ; 20S.
- Zhang and Jin (1996, p. 339) tabulates  $a_k$ ,  $\text{Ai}'(a_k)$ ,  $a'_k$ ,  $\text{Ai}(a'_k)$ ,  $b_k$ ,  $\text{Bi}'(b_k)$ ,  $b'_k$ ,  $\text{Bi}(b'_k)$ ,  $k = 1(1)20$ ; 8D.
- Corless *et al.* (1992) gives the real and imaginary parts of  $\beta_k$  for  $k = 1(1)13$ ; 14S.
- See also §9.9(v).

**9.18(v) Integrals**

- Rothman (1954a) tabulates  $\int_0^x \text{Ai}(t) dt$  and  $\int_0^x \text{Bi}(t) dt$  for  $x = -10(.1)\infty$  and  $-10(.1)2$ , respectively; 7D. The entries in the columns headed  $\int_0^x \text{Ai}(-x) dx$  and  $\int_0^x \text{Bi}(-x) dx$  all have the wrong sign. The tables are reproduced in Abramowitz and Stegun (1964, Chapter 10), and the sign errors are corrected in later reprintings.
- NBS (1958) tabulates  $\int_0^x \text{Ai}(-t) dt$  and  $\int_0^x \int_0^v \text{Ai}(-t) dt dv$  (see (9.10.20)) for  $x = -2(.01)5$  to 8D and 7D, respectively.
- Zhang and Jin (1996, p. 338) tabulates  $\int_0^x \text{Ai}(t) dt$  and  $\int_0^x \text{Bi}(t) dt$  for  $x = -10(.2)10$  to 8D or 8S.

**9.18(vi) Scorer Functions**

- Scorer (1950) tabulates  $\text{Gi}(x)$  and  $\text{Hi}(-x)$  for  $x = 0(.1)10$ ; 7D.
- Rothman (1954b) tabulates  $\int_0^x \text{Gi}(t) dt$ ,  $\text{Gi}'(x)$ ,  $\int_0^x \text{Hi}(-t) dt$ ,  $-\text{Hi}'(-x)$  for  $x = 0(.1)10$ ; 7D.
- NBS (1958) tabulates  $A_0(x) \equiv \pi \text{Hi}(-x)$  and  $-A'_0(x) \equiv \pi \text{Hi}'(-x)$  for  $x = 0(.01)1(.02)5(.05)11$  and  $1/x = 0.01(.01)0.1$ ;  $\int_0^x A_0(t) dt$  for  $x = 0.5, 1(1)11$ . Precision is 8D.
- Nosova and Tumarkin (1965) tabulates  $e_0(x) \equiv \pi \text{Hi}(-x)$ ,  $e'_0(x) \equiv -\pi \text{Hi}'(-x)$ ,  $\tilde{e}_0(-x) \equiv -\pi \text{Gi}(x)$ ,  $\tilde{e}'_0(-x) \equiv \pi \text{Gi}'(x)$  for  $x = -1(.01)10$ ; 7D. Also included are the real and imaginary parts of  $e_0(z)$  and  $ie'_0(z)$ , where  $z = iy$  and  $y = 0(.01)9$ ; 6-7D.
- Gil *et al.* (2003c) tabulates the only positive zero of  $\text{Gi}'(z)$ , the first 10 negative real zeros of  $\text{Gi}(z)$  and  $\text{Gi}'(z)$ , and the first 10 complex zeros of  $\text{Gi}(z)$ ,  $\text{Gi}'(z)$ ,  $\text{Hi}(z)$ , and  $\text{Hi}'(z)$ . Precision is 11 or 12S.

**9.18(vii) Generalized Airy Functions**

- Smirnov (1960) tabulates  $U_1(x, \alpha)$ ,  $U_2(x, \alpha)$ , defined by (9.13.20), (9.13.21), and also  $\partial U_1(x, \alpha)/\partial x$ ,  $\partial U_2(x, \alpha)/\partial x$ , for  $\alpha = 1$ ,  $x = -6(.01)10$  to 5D or 5S, and also for  $\alpha = \pm\frac{1}{4}, \pm\frac{1}{3}, \pm\frac{1}{2}, \pm\frac{2}{3}, \pm\frac{3}{4}, \frac{5}{4}, \frac{4}{3}, \frac{3}{2}, \frac{5}{3}, \frac{7}{4}, 2$ ,  $x = 0(.01)6$ ; 4D.

**9.19 Approximations****9.19(i) Approximations in Terms of Elementary Functions**

- Martín *et al.* (1992) provides two simple formulas for approximating  $\text{Ai}(x)$  to graphical accuracy, one for  $-\infty < x \leq 0$ , the other for  $0 \leq x < \infty$ .
- Moshier (1989, §6.14) provides minimax rational approximations for calculating  $\text{Ai}(x)$ ,  $\text{Ai}'(x)$ ,  $\text{Bi}(x)$ ,  $\text{Bi}'(x)$ . They are in terms of the variable  $\zeta$ , where  $\zeta = \frac{2}{3}x^{3/2}$  when  $x$  is positive,  $\zeta = \frac{2}{3}(-x)^{3/2}$  when  $x$  is negative, and  $\zeta = 0$  when  $x = 0$ . The approximations apply when  $2 \leq \zeta < \infty$ , that is, when  $3^{2/3} \leq x < \infty$  or  $-\infty < x \leq -3^{2/3}$ . The precision in the coefficients is 21S.

**9.19(ii) Expansions in Chebyshev Series**

These expansions are for real arguments  $x$  and are supplied in sets of four for each function, corresponding to intervals  $-\infty < x \leq a$ ,  $a \leq x \leq 0$ ,  $0 \leq x \leq b$ ,  $b \leq x < \infty$ . The constants  $a$  and  $b$  are chosen numerically, with a view to equalizing the effort required for summing the series.

- Prince (1975) covers  $\text{Ai}(x)$ ,  $\text{Ai}'(x)$ ,  $\text{Bi}(x)$ ,  $\text{Bi}'(x)$ . The Chebyshev coefficients are given to 10-11D. Fortran programs are included. See also Razaz and Schonfelder (1981).
- Németh (1992, Chapter 8) covers  $\text{Ai}(x)$ ,  $\text{Ai}'(x)$ ,  $\text{Bi}(x)$ ,  $\text{Bi}'(x)$ , and integrals  $\int_0^x \text{Ai}(t) dt$ ,  $\int_0^x \text{Bi}(t) dt$ ,  $\int_0^x \int_0^v \text{Ai}(t) dt dv$ ,  $\int_0^x \int_0^v \text{Bi}(t) dt dv$  (see also (9.10.20) and (9.10.21)). The Chebyshev coefficients are given to 15D. Chebyshev coefficients are also given for expansions of the second and higher (real) zeros of  $\text{Ai}(x)$ ,  $\text{Ai}'(x)$ ,  $\text{Bi}(x)$ ,  $\text{Bi}'(x)$ , again to 15D.
- Razaz and Schonfelder (1980) covers  $\text{Ai}(x)$ ,  $\text{Ai}'(x)$ ,  $\text{Bi}(x)$ ,  $\text{Bi}'(x)$ . The Chebyshev coefficients are given to 30D.

### 9.19(iii) Approximations in the Complex Plane

- Corless *et al.* (1992) describe a method of approximation based on subdividing  $\mathbb{C}$  into a triangular mesh, with values of  $Ai(z)$ ,  $Ai'(z)$  stored at the nodes.  $Ai(z)$  and  $Ai'(z)$  are then computed from Taylor-series expansions centered at one of the nearest nodes. The Taylor coefficients are generated by recursion, starting from the stored values of  $Ai(z)$ ,  $Ai'(z)$  at the node. Similarly for  $Bi(z)$ ,  $Bi'(z)$ .

### 9.19(iv) Scorer Functions

- MacLeod (1994) supplies Chebyshev-series expansions to cover  $Gi(x)$  for  $0 \leq x < \infty$  and  $Hi(x)$  for  $-\infty < x \leq 0$ . The Chebyshev coefficients are given to 20D.

## 9.20 Software

See <http://dlmf.nist.gov/9.20>.

## References

### General References

The main references used in writing this chapter are Miller (1946) and Olver (1997b). For additional bibliographic reading see Bleistein and Handelsman (1975), Jeffreys and Jeffreys (1956), Lebedev (1965), Temme (1996a), Wasow (1965, 1985), and Wong (1989).

### Sources

The following list gives the references or other indications of proofs that were used in constructing the various sections of this chapter. These sources supplement the references that are quoted in the text.

§9.2 Miller (1946), Olver (1997b, Chapter 11).

§9.3 These graphics were produced by NIST.

§9.4 Miller (1946, p. B17), Olver (1997b, p. 54).

§9.5 Miller (1946, p. B17), Olver (1997b, p. 103). For (9.5.4) see Olver (1997b, p. 53). For (9.5.5) combine (9.2.10) and (9.5.4). For (9.5.6) see Reid (1995). For (9.5.7) see Copson (1963). (9.5.8) follows from the first of (9.6.2) and (10.32.9).

§9.6 Miller (1946, p. B17), Olver (1997b, pp. 392–393). For (9.6.21)–(9.6.24) combine (9.6.1)–(9.6.5) and (10.39.8)–(10.39.10). For (9.6.25), (9.6.26) combine (9.6.23), (9.6.24) with (13.14.2) and refer to §13.1.

§9.7 For (9.7.4) and Table 9.7.1 see Olver (1997b, p. 225). For (9.7.5)–(9.7.14) and §9.7(iii) see Olver (1997b, pp. 392–393 and 413–414). For §9.7(iv) see (9.6.1)–(9.6.5) and Olver (1997b, pp. 266–267). For (9.7.18)–(9.7.23) see Olver (1991b, 1993a).

§9.8 For (9.8.9)–(9.8.12) combine (9.6.17) and (9.6.18) with (10.4.3). For (9.8.13) use (9.2.7). For (9.8.14)–(9.8.19) combine (9.8.9)–(9.8.12) with §10.18(ii); see also Olver (1997b, p. 404), Miller (1946, p. B10). For §9.8(iii) see Olver (1997b, p. 404). For §9.8(iv) combine (9.8.9)–(9.8.12) with §10.18(iii); see also Miller (1946, p. B48).

§9.9 Olver (1997b, pp. 404, 414–415), Miller (1946, p. B48), Olver (1954, Appendix). For the computation of Tables 9.9.1–9.9.4 see §9.17(v).

§9.10 For (9.10.1) combine (9.12.4) and its differentiated form with the first of (9.10.11). For (9.10.2) combine (9.12.11) and its differentiated form with (9.10.1), then apply (9.2.7) and (9.10.11). (9.10.3) is proved in a similar manner. For (9.10.4)–(9.10.7) integrate the leading terms of the asymptotic expansions given in §9.7(ii) and use (9.10.11), (9.10.12). To verify (9.10.8)–(9.10.10)—and also (9.10.20), (9.10.21)—differentiate, and refer to (9.2.1). For (9.10.11) and (9.10.12) see Olver (1997b, p. 431). For (9.10.13) see Widder (1979). For (9.10.14)–(9.10.16) see Gibbs (1973, problem 72–21). For (9.10.17) see Olver (1997b, p. 338). For (9.10.18) and (9.10.19) see Schulten *et al.* (1979). To verify (9.10.20) and (9.10.21) differentiate, and refer to (9.2.1). For (9.10.22) see Olver (1997b, pp. 342–344).

§9.11 For (9.11.1) see §1.13(v). For (9.11.2) use (9.2.1) and (9.2.7). For (9.11.3) and (9.11.4) see Lebedev (1965, p. 142) and Muldoon (1977). For (9.11.5)–(9.11.14) see Albright (1977) and Albright and Gavathas (1986). For (9.11.15) see Reid (1995). For (9.11.16) and (9.11.17) see Reid (1997a). For (9.11.18) see Laurenzi (1993).

For (9.11.19) extend the definitions of §9.8(i) to positive values of  $x$ , obtain the indefinite integrals of  $1/M^2(x)$  and  $x/N^2(x)$  via the first two of (9.8.14), then combine the values of  $\theta(0)$  and  $\phi(0)$  given in §9.8(i) with  $\theta(+\infty) = \phi(+\infty) = 0$  obtained from (9.8.4), (9.8.8), and §9.7(ii). (Communicated by M.E. Muldoon.)

**§9.12** For (9.12.1)–(9.12.7) see Olver (1997b, pp. 430–431). For §9.12(iv) refer to the asymptotic expansions given in §§9.7(ii) and 9.12(viii). (9.12.11)–(9.12.14) can be verified with the aid of §§9.2(ii) and 9.12(iii). For (9.12.17) expand the integral in (9.12.20) in powers of  $zt$  and integrate term-by-term by means of (5.2.1). For (9.12.15) substitute into (9.12.11) by means of (9.12.17), (9.4.3), (9.2.5), (9.2.6), and use (5.5.3). For (9.12.16) and (9.12.18) use differentiation. (9.12.20) can be verified by showing that the right-hand side satisfies the differential equation (9.12.1) and the initial conditions given in §9.12(iii). For (9.12.19) combine (9.5.3) and (9.12.11). For (9.12.21), see Lee (1980). For (9.12.22), (9.12.23) see Gordon (1970, Appendix A). For (9.12.24) see Exton (1983). For (9.12.25), (9.12.27) see Olver (1997b, pp. 431–432). For (9.12.26), (9.12.28) refer to §2.1(ii).

Except for the constant term, (9.12.31) can be

verified by termwise integration of (9.12.27). To evaluate the constant term replace  $z$  by  $-x$  ( $\leq 0$ ) in (9.12.20) and integrate (§1.5(v)) to obtain  $\pi \int_0^x \text{Hi}(-t) dt = \int_0^\infty (1 - e^{-xt}) e^{-\frac{1}{3}t^3} t^{-1} dt$ . Next, integrate the right-hand side of this equation by parts—integrating the factor  $t^{-1}$  and differentiating the rest. As  $x \rightarrow \infty$  the asymptotic expansions of  $\int_0^\infty x e^{-xt} e^{-\frac{1}{3}t^3} (\ln t) dt$  and  $\int_0^\infty e^{-xt} t^2 e^{-\frac{1}{3}t^3} (\ln t) dt$  follow from (2.3.9). Also,  $\int_0^\infty t^2 e^{-\frac{1}{3}t^3} (\ln t) dt$  can be found by replacing  $\frac{1}{3}t^3$  by  $t$  and referring to the first of (5.9.18). For (9.12.30) integrate (9.12.25) and obtain the constant term by combining (9.12.12) and (9.12.31). (Equations (9.12.30) and (9.12.31) first appeared in Rothman (1954b). As noted in this reference these results were derived by the author of the present DLMF chapter, but the proof was not included.) The graphs were produced by NIST.



## Chapter 10

# Bessel Functions

F. W. J. Olver<sup>1</sup> and L. C. Maximon<sup>2</sup>

<b>Notation</b>	<b>217</b>	10.40 Asymptotic Expansions for Large Argument	255
10.1 Special Notation . . . . .	217	10.41 Asymptotic Expansions for Large Order . . . . .	256
<b>Bessel and Hankel Functions</b>	<b>217</b>	10.42 Zeros . . . . .	258
10.2 Definitions . . . . .	217	10.43 Integrals . . . . .	258
10.3 Graphics . . . . .	218	10.44 Sums . . . . .	260
10.4 Connection Formulas . . . . .	222	10.45 Functions of Imaginary Order . . . . .	261
10.5 Wronskians and Cross-Products . . . . .	222	10.46 Generalized and Incomplete Bessel Functions; Mittag-Leffler Function . . . . .	261
10.6 Recurrence Relations and Derivatives . . . . .	222	<b>Spherical Bessel Functions</b>	<b>262</b>
10.7 Limiting Forms . . . . .	223	10.47 Definitions and Basic Properties . . . . .	262
10.8 Power Series . . . . .	223	10.48 Graphs . . . . .	262
10.9 Integral Representations . . . . .	223	10.49 Explicit Formulas . . . . .	264
10.10 Continued Fractions . . . . .	226	10.50 Wronskians and Cross-Products . . . . .	265
10.11 Analytic Continuation . . . . .	226	10.51 Recurrence Relations and Derivatives . . . . .	265
10.12 Generating Function and Associated Series . . . . .	226	10.52 Limiting Forms . . . . .	265
10.13 Other Differential Equations . . . . .	226	10.53 Power Series . . . . .	265
10.14 Inequalities; Monotonicity . . . . .	227	10.54 Integral Representations . . . . .	266
10.15 Derivatives with Respect to Order . . . . .	227	10.55 Continued Fractions . . . . .	266
10.16 Relations to Other Functions . . . . .	228	10.56 Generating Functions . . . . .	266
10.17 Asymptotic Expansions for Large Argument . . . . .	228	10.57 Uniform Asymptotic Expansions for Large Order . . . . .	266
10.18 Modulus and Phase Functions . . . . .	230	10.58 Zeros . . . . .	266
10.19 Asymptotic Expansions for Large Order . . . . .	231	10.59 Integrals . . . . .	267
10.20 Uniform Asymptotic Expansions for Large Order . . . . .	232	10.60 Sums . . . . .	267
10.21 Zeros . . . . .	235	<b>Kelvin Functions</b>	<b>267</b>
10.22 Integrals . . . . .	240	10.61 Definitions and Basic Properties . . . . .	267
10.23 Sums . . . . .	246	10.62 Graphs . . . . .	268
10.24 Functions of Imaginary Order . . . . .	248	10.63 Recurrence Relations and Derivatives . . . . .	269
<b>Modified Bessel Functions</b>	<b>248</b>	10.64 Integral Representations . . . . .	269
10.25 Definitions . . . . .	248	10.65 Power Series . . . . .	269
10.26 Graphics . . . . .	249	10.66 Expansions in Series of Bessel Functions . . . . .	270
10.27 Connection Formulas . . . . .	251	10.67 Asymptotic Expansions for Large Argument . . . . .	271
10.28 Wronskians and Cross-Products . . . . .	251	10.68 Modulus and Phase Functions . . . . .	272
10.29 Recurrence Relations and Derivatives . . . . .	251	10.69 Uniform Asymptotic Expansions for Large Order . . . . .	273
10.30 Limiting Forms . . . . .	252	10.70 Zeros . . . . .	273
10.31 Power Series . . . . .	252	10.71 Integrals . . . . .	274
10.32 Integral Representations . . . . .	252	<b>Applications</b>	<b>274</b>
10.33 Continued Fractions . . . . .	253	10.72 Mathematical Applications . . . . .	274
10.34 Analytic Continuation . . . . .	253	10.73 Physical Applications . . . . .	275
10.35 Generating Function and Associated Series . . . . .	254		
10.36 Other Differential Equations . . . . .	254		
10.37 Inequalities; Monotonicity . . . . .	254		
10.38 Derivatives with Respect to Order . . . . .	254		
10.39 Relations to Other Functions . . . . .	254		

<sup>1</sup>Institute for Physical Science and Technology and Department of Mathematics, University of Maryland, College Park, Maryland.

<sup>2</sup>Center for Nuclear Studies, Department of Physics, The George Washington University, Washington, D.C.



<b>Computation</b>	<b>276</b>		
10.74 Methods of Computation . . . . .	276	10.77 Software . . . . .	281
10.75 Tables . . . . .	278		
10.76 Approximations . . . . .	281	<b>References</b>	<b>281</b>

**Acknowledgments:** This chapter is based in part on Abramowitz and Stegun (1964, Chapters 9, 10, and 11) by F. W. J. Olver, H. A. Antosiewicz, and Y. L. Luke, respectively. The authors are pleased to acknowledge assistance of Martin E. Muldoon with §§10.21 and 10.42, Adri Olde Daalhuis with the verification of Eqs. (10.15.6)–(10.15.9), (10.38.6), (10.38.7), (10.60.7)–(10.60.9), and (10.61.9)–(10.61.12), Peter Paule and Frédéric Chyzak for the verification of Eqs. (10.15.6)–(10.15.9), (10.38.6), (10.38.7), (10.56.1)–(10.56.5), (10.60.4), (10.60.6), (10.60.10), and (10.60.11) by application of computer algebra, Nico Temme with the verification of Eqs. (10.15.6)–(10.15.9), (10.38.6), and (10.38.7), and Roderick Wong with the verification of §§10.22(v) and 10.43(v).

**Copyright** © 2009 National Institute of Standards and Technology. All rights reserved.

## Notation

### 10.1 Special Notation

(For other notation see pp. xiv and 873.)

- $m, n$  integers. In §§10.47–10.71  $n$  is nonnegative.
- $k$  nonnegative integer (except in §10.73).
- $x, y$  real variables.
- $z$  complex variable.
- $\nu$  real or complex parameter (the order).
- $\delta$  arbitrary small positive constant.
- $\vartheta$   $z(d/dz)$ .
- $\psi(x)$   $\Gamma'(x)/\Gamma(x)$ : logarithmic derivative of the gamma function (§5.2(i)).
- primes derivatives with respect to argument, except where indicated otherwise.

The main functions treated in this chapter are the Bessel functions  $J_\nu(z)$ ,  $Y_\nu(z)$ ; Hankel functions  $H_\nu^{(1)}(z)$ ,  $H_\nu^{(2)}(z)$ ; modified Bessel functions  $I_\nu(z)$ ,  $K_\nu(z)$ ; spherical Bessel functions  $j_n(z)$ ,  $y_n(z)$ ,  $h_n^{(1)}(z)$ ,  $h_n^{(2)}(z)$ ; modified spherical Bessel functions  $i_n^{(1)}(z)$ ,  $i_n^{(2)}(z)$ ,  $k_n(z)$ ; Kelvin functions  $\text{ber}_\nu(x)$ ,  $\text{bei}_\nu(x)$ ,  $\text{ker}_\nu(x)$ ,  $\text{kei}_\nu(x)$ . For the spherical Bessel functions and modified spherical Bessel functions the order  $n$  is a nonnegative integer. For the other functions when the order  $\nu$  is replaced by  $n$ , it can be any integer. For the Kelvin functions the order  $\nu$  is always assumed to be real.

A common alternative notation for  $Y_\nu(z)$  is  $N_\nu(z)$ . Other notations that have been used are as follows.

Abramowitz and Stegun (1964):  $j_n(z)$ ,  $y_n(z)$ ,  $h_n^{(1)}(z)$ ,  $h_n^{(2)}(z)$ , for  $j_n(z)$ ,  $y_n(z)$ ,  $h_n^{(1)}(z)$ ,  $h_n^{(2)}(z)$ , respectively, when  $n \geq 0$ .

Jeffreys and Jeffreys (1956):  $\text{Hs}_\nu(z)$  for  $H_\nu^{(1)}(z)$ ,  $\text{Hi}_\nu(z)$  for  $H_\nu^{(2)}(z)$ ,  $\text{Kh}_\nu(z)$  for  $(2/\pi)K_\nu(z)$ .

Whittaker and Watson (1927):  $K_\nu(z)$  for  $\cos(\nu\pi)K_\nu(z)$ .

For older notations see British Association for the Advancement of Science (1937, pp. xix–xx) and Watson (1944, Chapters 1–3).

## Bessel and Hankel Functions

### 10.2 Definitions

#### 10.2(i) Bessel's Equation

$$10.2.1 \quad z^2 \frac{d^2 w}{dz^2} + z \frac{dw}{dz} + (z^2 - \nu^2)w = 0.$$

This differential equation has a regular singularity at  $z = 0$  with indices  $\pm\nu$ , and an irregular singularity at  $z = \infty$  of rank 1; compare §§2.7(i) and 2.7(ii).

### 10.2(ii) Standard Solutions

#### Bessel Function of the First Kind

$$10.2.2 \quad J_\nu(z) = \left(\frac{1}{2}z\right)^\nu \sum_{k=0}^{\infty} (-1)^k \frac{\left(\frac{1}{4}z^2\right)^k}{k! \Gamma(\nu + k + 1)}.$$

This solution of (10.2.1) is an analytic function of  $z \in \mathbb{C}$ , except for a branch point at  $z = 0$  when  $\nu$  is not an integer. The *principal branch* of  $J_\nu(z)$  corresponds to the principal value of  $(\frac{1}{2}z)^\nu$  (§4.2(iv)) and is analytic in the  $z$ -plane cut along the interval  $(-\infty, 0]$ .

When  $\nu = n \in \mathbb{Z}$ ,  $J_\nu(z)$  is entire in  $z$ .

For fixed  $z (\neq 0)$  each branch of  $J_\nu(z)$  is entire in  $\nu$ .

#### Bessel Function of the Second Kind (Weber's Function)

$$10.2.3 \quad Y_\nu(z) = \frac{J_\nu(z) \cos(\nu\pi) - J_{-\nu}(z)}{\sin(\nu\pi)}.$$

When  $\nu$  is an integer the right-hand side is replaced by its limiting value:

$$10.2.4 \quad Y_n(z) = \frac{1}{\pi} \left. \frac{\partial J_\nu(z)}{\partial \nu} \right|_{\nu=n} + \frac{(-1)^n}{\pi} \left. \frac{\partial J_\nu(z)}{\partial \nu} \right|_{\nu=-n}, \quad n = 0, \pm 1, \pm 2, \dots$$

Whether or not  $\nu$  is an integer  $Y_\nu(z)$  has a branch point at  $z = 0$ . The *principal branch* corresponds to the principal branches of  $J_{\pm\nu}(z)$  in (10.2.3) and (10.2.4), with a cut in the  $z$ -plane along the interval  $(-\infty, 0]$ .

Except in the case of  $J_{\pm n}(z)$ , the principal branches of  $J_\nu(z)$  and  $Y_\nu(z)$  are two-valued and discontinuous on the cut  $\text{ph } z = \pm\pi$ ; compare §4.2(i).

Both  $J_\nu(z)$  and  $Y_\nu(z)$  are real when  $\nu$  is real and  $\text{ph } z = 0$ .

For fixed  $z (\neq 0)$  each branch of  $Y_\nu(z)$  is entire in  $\nu$ .

#### Bessel Functions of the Third Kind (Hankel Functions)

These solutions of (10.2.1) are denoted by  $H_\nu^{(1)}(z)$  and  $H_\nu^{(2)}(z)$ , and their defining properties are given by

$$10.2.5 \quad H_\nu^{(1)}(z) \sim \sqrt{2/(\pi z)} e^{i(z - \frac{1}{2}\nu\pi - \frac{1}{4}\pi)}$$

as  $z \rightarrow \infty$  in  $-\pi + \delta \leq \text{ph } z \leq 2\pi - \delta$ , and

$$10.2.6 \quad H_\nu^{(2)}(z) \sim \sqrt{2/(\pi z)} e^{-i(z - \frac{1}{2}\nu\pi - \frac{1}{4}\pi)}$$

as  $z \rightarrow \infty$  in  $-2\pi + \delta \leq \text{ph } z \leq \pi - \delta$ , where  $\delta$  is an arbitrary small positive constant. Each solution has a branch point at  $z = 0$  for all  $\nu \in \mathbb{C}$ . The *principal branches* correspond to principal values of the square roots in (10.2.5) and (10.2.6), again with a cut in the  $z$ -plane along the interval  $(-\infty, 0]$ .

The principal branches of  $H_\nu^{(1)}(z)$  and  $H_\nu^{(2)}(z)$  are two-valued and discontinuous on the cut  $\text{ph } z = \pm\pi$ .

For fixed  $z (\neq 0)$  each branch of  $H_\nu^{(1)}(z)$  and  $H_\nu^{(2)}(z)$  is entire in  $\nu$ .

**Branch Conventions**

Except where indicated otherwise, it is assumed throughout this Handbook that the symbols  $J_\nu(z)$ ,  $Y_\nu(z)$ ,  $H_\nu^{(1)}(z)$ , and  $H_\nu^{(2)}(z)$  denote the principal values of these functions.

**Cylinder Functions**

The notation  $\mathcal{C}_\nu(z)$  denotes  $J_\nu(z)$ ,  $Y_\nu(z)$ ,  $H_\nu^{(1)}(z)$ ,  $H_\nu^{(2)}(z)$ , or any nontrivial linear combination of these functions, the coefficients in which are independent of  $z$  and  $\nu$ .

**10.2(iii) Numerically Satisfactory Pairs of Solutions**

Table 10.2.1 lists numerically satisfactory pairs of solutions (§2.7(iv)) of (10.2.1) for the stated intervals or

regions in the case  $\Re\nu \geq 0$ . When  $\Re\nu < 0$ ,  $\nu$  is replaced by  $-\nu$  throughout.

Table 10.2.1: Numerically satisfactory pairs of solutions of Bessel's equation.

Pair	Interval or Region
$J_\nu(x), Y_\nu(x)$	$0 < x < \infty$
$J_\nu(z), Y_\nu(z)$	neighborhood of 0 in $ \text{ph } z  \leq \pi$
$J_\nu(z), H_\nu^{(1)}(z)$	$0 \leq \text{ph } z \leq \pi$
$J_\nu(z), H_\nu^{(2)}(z)$	$-\pi \leq \text{ph } z \leq 0$
$H_\nu^{(1)}(z), H_\nu^{(2)}(z)$	neighborhood of $\infty$ in $ \text{ph } z  \leq \pi$

**10.3 Graphics**

**10.3(i) Real Order and Variable**

See Figures 10.3.1–10.3.8. For the modulus and phase functions  $M_\nu(x)$ ,  $\theta_\nu(x)$ ,  $N_\nu(x)$ , and  $\phi_\nu(x)$  see §10.18.

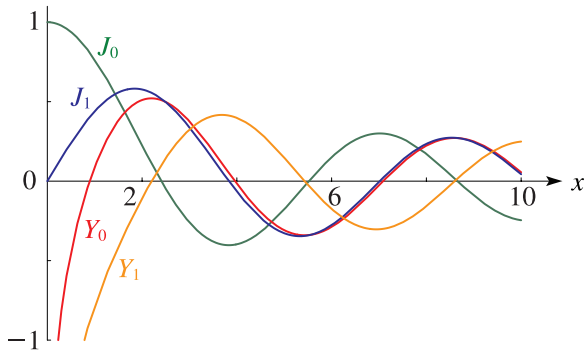


Figure 10.3.1:  $J_0(x), Y_0(x), J_1(x), Y_1(x), 0 \leq x \leq 10$ .

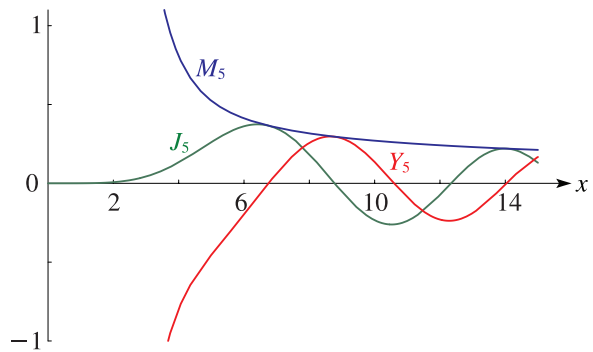


Figure 10.3.2:  $J_5(x), Y_5(x), M_5(x), 0 \leq x \leq 15$ .

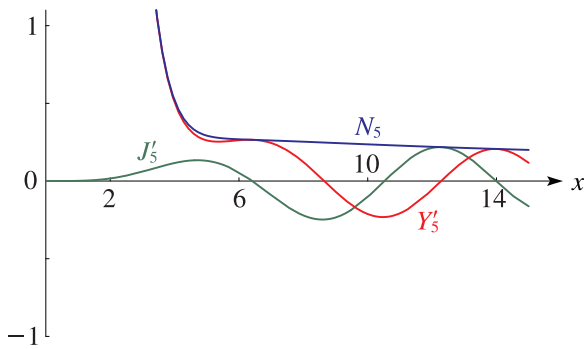


Figure 10.3.3:  $J'_5(x), Y'_5(x), N_5(x), 0 \leq x \leq 15$ .

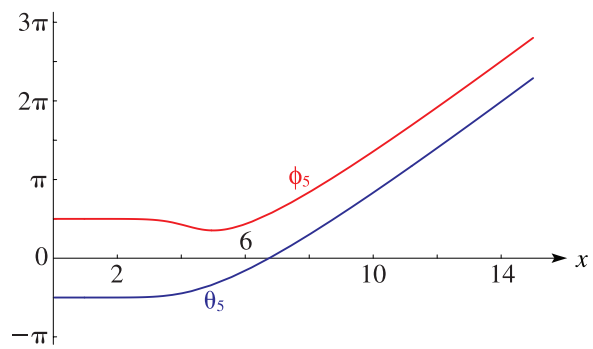


Figure 10.3.4:  $\theta_5(x), \phi_5(x), 0 \leq x \leq 15$ .

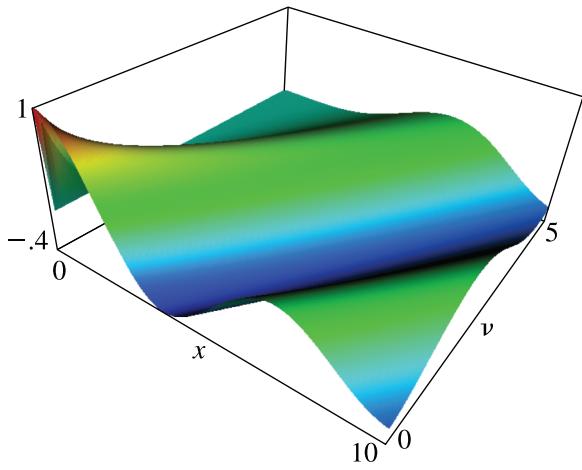


Figure 10.3.5:  $J_\nu(x), 0 \leq x \leq 10, 0 \leq \nu \leq 5$ .

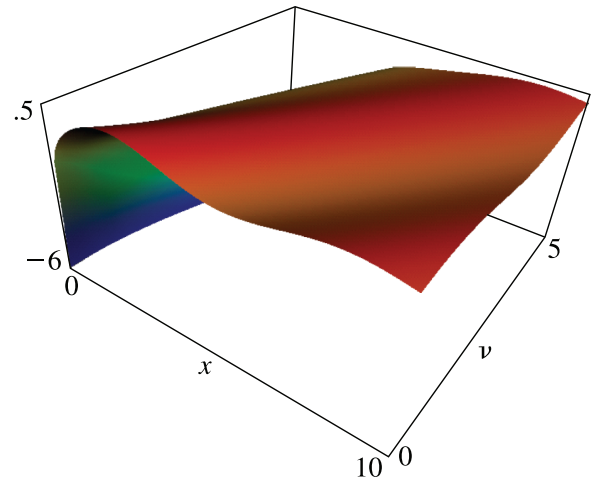


Figure 10.3.6:  $Y_\nu(x), 0 < x \leq 10, 0 \leq \nu \leq 5$ .

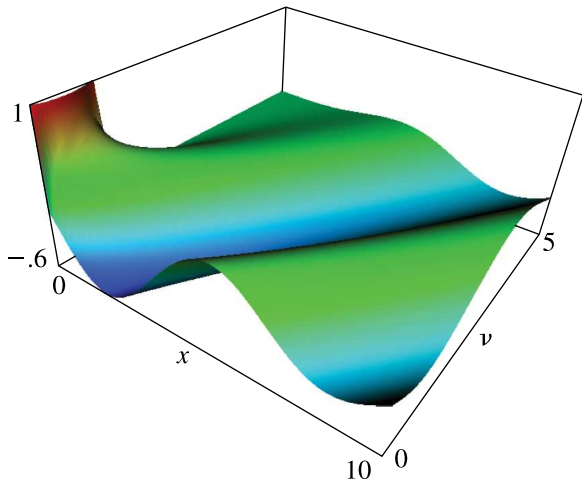


Figure 10.3.7:  $J'_\nu(x), 0 \leq x \leq 10, 0 \leq \nu \leq 5$ .

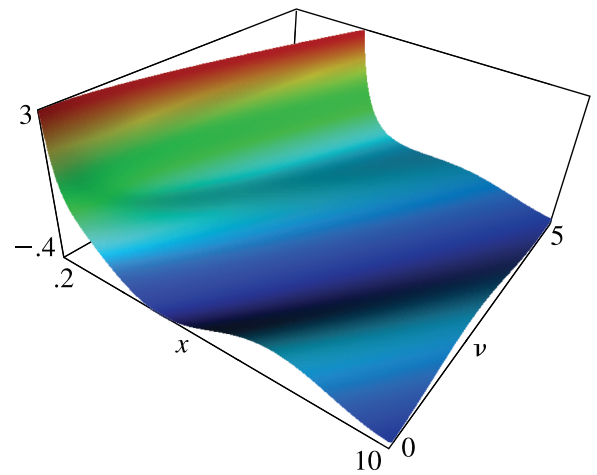


Figure 10.3.8:  $Y'_\nu(x), 0.2 \leq x \leq 10, 0 \leq \nu \leq 5$ .

### 10.3(ii) Real Order, Complex Variable

See Figures 10.3.9–10.3.16. In these graphics, height corresponds to the absolute value of the function and color to the phase. See also p. xiv.

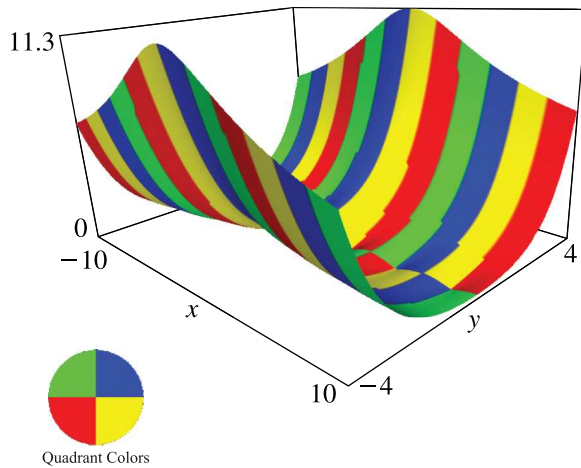


Figure 10.3.9:  $J_0(x + iy)$ ,  $-10 \leq x \leq 10$ ,  $-4 \leq y \leq 4$ .

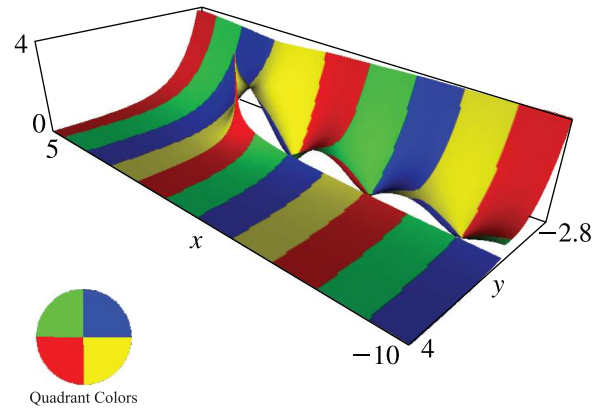


Figure 10.3.10:  $H_0^{(1)}(x + iy)$ ,  $-10 \leq x \leq 5$ ,  $-2.8 \leq y \leq 4$ . Principal value. There is a cut along the negative real axis.

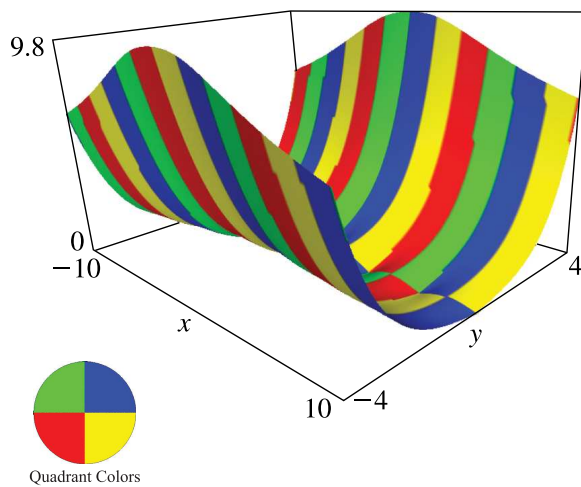


Figure 10.3.11:  $J_1(x + iy)$ ,  $-10 \leq x \leq 10$ ,  $-4 \leq y \leq 4$ .

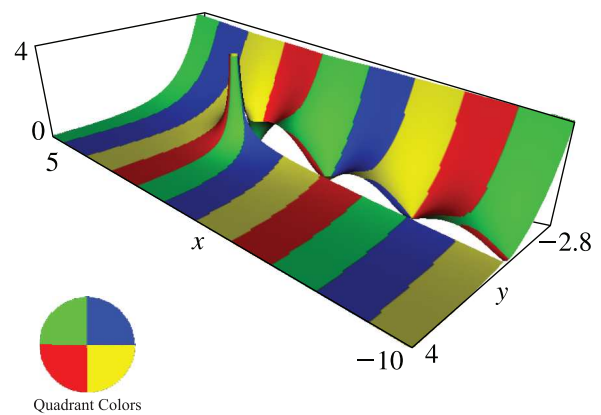


Figure 10.3.12:  $H_1^{(1)}(x + iy)$ ,  $-10 \leq x \leq 5$ ,  $-2.8 \leq y \leq 4$ . Principal value. There is a cut along the negative real axis.

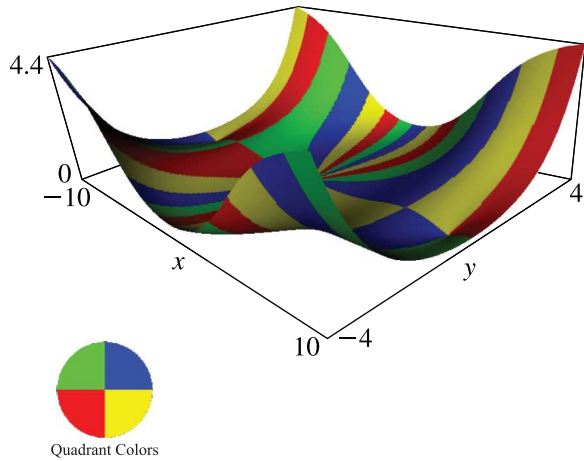


Figure 10.3.13:  $J_5(x+iy)$ ,  $-10 \leq x \leq 10$ ,  $-4 \leq y \leq 4$ .

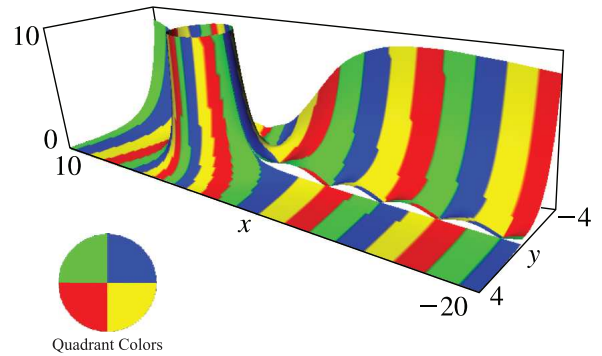


Figure 10.3.14:  $H_5^{(1)}(x+iy)$ ,  $-20 \leq x \leq 10$ ,  $-4 \leq y \leq 4$ . Principal value. There is a cut along the negative real axis.

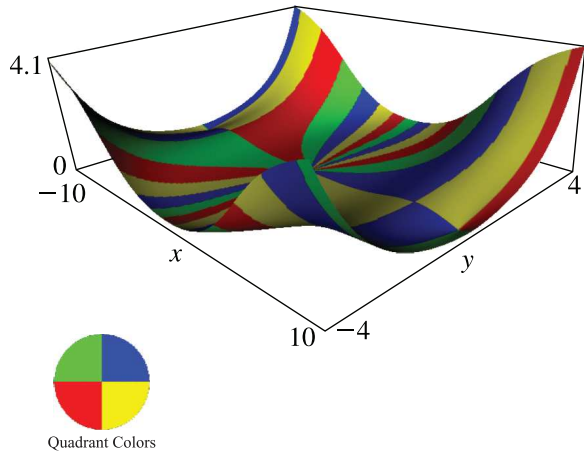


Figure 10.3.15:  $J_{5.5}(x+iy)$ ,  $-10 \leq x \leq 10$ ,  $-4 \leq y \leq 4$ . Principal value. There is a cut along the negative real axis.

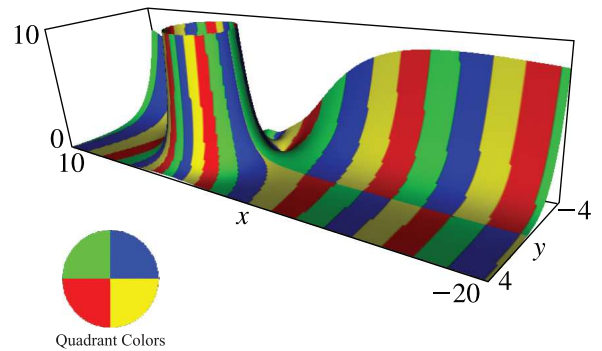


Figure 10.3.16:  $H_{5.5}^{(1)}(x+iy)$ ,  $-20 \leq x \leq 10$ ,  $-4 \leq y \leq 4$ . Principal value. There is a cut along the negative real axis.

**10.3(iii) Imaginary Order, Real Variable**

See Figures 10.3.17–10.3.19. For the notation see §10.24.

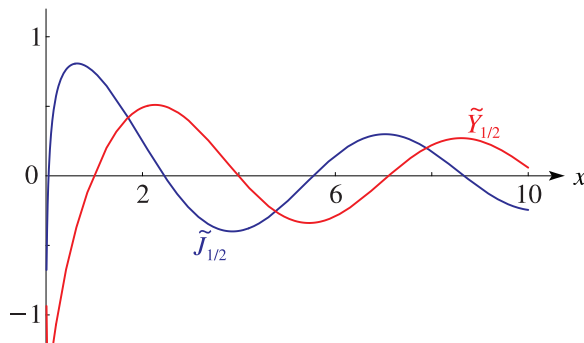


Figure 10.3.17:  $\tilde{J}_{1/2}(x), \tilde{Y}_{1/2}(x), 0.01 \leq x \leq 10$ .

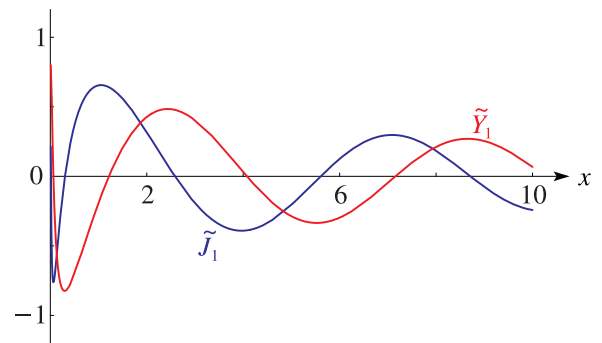


Figure 10.3.18:  $\tilde{J}_1(x), \tilde{Y}_1(x), 0.01 \leq x \leq 10$ .

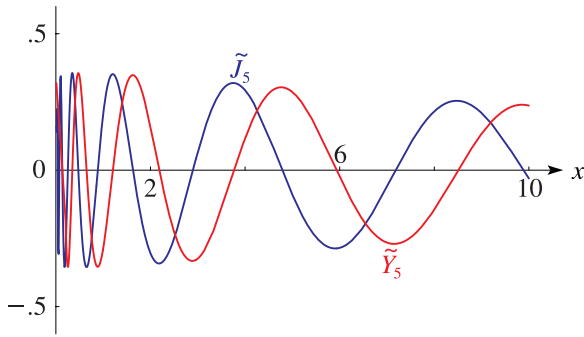


Figure 10.3.19:  $\tilde{J}_5(x), \tilde{Y}_5(x), 0.01 \leq x \leq 10$ .

## 10.4 Connection Formulas

Other solutions of (10.2.1) include  $J_{-\nu}(z)$ ,  $Y_{-\nu}(z)$ ,  $H_{-\nu}^{(1)}(z)$ , and  $H_{-\nu}^{(2)}(z)$ .

$$\begin{aligned} 10.4.1 \quad J_{-n}(z) &= (-1)^n J_n(z), \\ Y_{-n}(z) &= (-1)^n Y_n(z), \end{aligned}$$

$$\begin{aligned} 10.4.2 \quad H_{-n}^{(1)}(z) &= (-1)^n H_n^{(1)}(z), \\ H_{-n}^{(2)}(z) &= (-1)^n H_n^{(2)}(z). \end{aligned}$$

$$\begin{aligned} 10.4.3 \quad H_{\nu}^{(1)}(z) &= J_{\nu}(z) + i Y_{\nu}(z), \\ H_{\nu}^{(2)}(z) &= J_{\nu}(z) - i Y_{\nu}(z), \end{aligned}$$

$$\begin{aligned} 10.4.4 \quad J_{\nu}(z) &= \frac{1}{2} \left( H_{\nu}^{(1)}(z) + H_{\nu}^{(2)}(z) \right), \\ Y_{\nu}(z) &= \frac{1}{2i} \left( H_{\nu}^{(1)}(z) - H_{\nu}^{(2)}(z) \right). \end{aligned}$$

$$10.4.5 \quad J_{\nu}(z) = \csc(\nu\pi) (Y_{-\nu}(z) - Y_{\nu}(z) \cos(\nu\pi)).$$

$$\begin{aligned} 10.4.6 \quad H_{-\nu}^{(1)}(z) &= e^{\nu\pi i} H_{\nu}^{(1)}(z), \\ H_{-\nu}^{(2)}(z) &= e^{-\nu\pi i} H_{\nu}^{(2)}(z). \end{aligned}$$

$$\begin{aligned} 10.4.7 \quad H_{\nu}^{(1)}(z) &= i \csc(\nu\pi) (e^{-\nu\pi i} J_{\nu}(z) - J_{-\nu}(z)) \\ &= \csc(\nu\pi) (Y_{-\nu}(z) - e^{-\nu\pi i} Y_{\nu}(z)), \end{aligned}$$

$$\begin{aligned} 10.4.8 \quad H_{\nu}^{(2)}(z) &= i \csc(\nu\pi) (J_{-\nu}(z) - e^{\nu\pi i} J_{\nu}(z)) \\ &= \csc(\nu\pi) (Y_{-\nu}(z) - e^{\nu\pi i} Y_{\nu}(z)). \end{aligned}$$

In (10.4.5), (10.4.7), and (10.4.8) limiting values are taken when  $\nu = n$ ; compare (10.2.3) and (10.2.4).

See also §10.11.

## 10.5 Wronskians and Cross-Products

$$\begin{aligned} 10.5.1 \quad \mathscr{W} \{J_{\nu}(z), J_{-\nu}(z)\} &= J_{\nu+1}(z) J_{-\nu}(z) + J_{\nu}(z) J_{-\nu-1}(z) \\ &= -2 \sin(\nu\pi) / (\pi z), \end{aligned}$$

$$\begin{aligned} 10.5.2 \quad \mathscr{W} \{J_{\nu}(z), Y_{\nu}(z)\} &= J_{\nu+1}(z) Y_{\nu}(z) - J_{\nu}(z) Y_{\nu+1}(z) \\ &= 2 / (\pi z), \end{aligned}$$

$$\begin{aligned} 10.5.3 \quad \mathscr{W} \{J_{\nu}(z), H_{\nu}^{(1)}(z)\} &= J_{\nu+1}(z) H_{\nu}^{(1)}(z) - J_{\nu}(z) H_{\nu+1}^{(1)}(z) \\ &= 2i / (\pi z), \end{aligned}$$

$$\begin{aligned} 10.5.4 \quad \mathscr{W} \{J_{\nu}(z), H_{\nu}^{(2)}(z)\} &= J_{\nu+1}(z) H_{\nu}^{(2)}(z) - J_{\nu}(z) H_{\nu+1}^{(2)}(z) \\ &= -2i / (\pi z), \end{aligned}$$

$$\mathscr{W} \{H_{\nu}^{(1)}(z), H_{\nu}^{(2)}(z)\} = H_{\nu+1}^{(1)}(z) H_{\nu}^{(2)}(z)$$

$$\begin{aligned} 10.5.5 \quad &- H_{\nu}^{(1)}(z) H_{\nu+1}^{(2)}(z) \\ &= -4i / (\pi z). \end{aligned}$$

## 10.6 Recurrence Relations and Derivatives

### 10.6(i) Recurrence Relations

With  $\mathscr{C}_{\nu}(z)$  defined as in §10.2(ii),

$$\begin{aligned} 10.6.1 \quad \mathscr{C}_{\nu-1}(z) + \mathscr{C}_{\nu+1}(z) &= (2\nu/z) \mathscr{C}_{\nu}(z), \\ \mathscr{C}_{\nu-1}(z) - \mathscr{C}_{\nu+1}(z) &= 2 \mathscr{C}'_{\nu}(z). \end{aligned}$$

$$\begin{aligned} 10.6.2 \quad \mathscr{C}'_{\nu}(z) &= \mathscr{C}_{\nu-1}(z) - (\nu/z) \mathscr{C}_{\nu}(z), \\ \mathscr{C}'_{\nu}(z) &= -\mathscr{C}_{\nu+1}(z) + (\nu/z) \mathscr{C}_{\nu}(z). \end{aligned}$$

$$\begin{aligned} 10.6.3 \quad J'_0(z) &= -J_1(z), & Y'_0(z) &= -Y_1(z), \\ H_0^{(1)'}(z) &= -H_1^{(1)}(z), & H_0^{(2)'}(z) &= -H_1^{(2)}(z). \end{aligned}$$

If  $f_{\nu}(z) = z^p \mathscr{C}_{\nu}(\lambda z^q)$ , where  $p, q$ , and  $\lambda (\neq 0)$  are real or complex constants, then

$$\begin{aligned} 10.6.4 \quad f_{\nu-1}(z) + f_{\nu+1}(z) &= (2\nu/\lambda) z^{-q} f_{\nu}(z), \\ (p + \nu q) f_{\nu-1}(z) + (p - \nu q) f_{\nu+1}(z) &= (2\nu/\lambda) z^{1-q} f'_{\nu}(z). \end{aligned}$$

$$\begin{aligned} 10.6.5 \quad z f'_{\nu}(z) &= \lambda q z^q f_{\nu-1}(z) + (p - \nu q) f_{\nu}(z), \\ z f'_{\nu}(z) &= -\lambda q z^q f_{\nu+1}(z) + (p + \nu q) f_{\nu}(z). \end{aligned}$$

### 10.6(ii) Derivatives

For  $k = 0, 1, 2, \dots$ ,

$$\begin{aligned} 10.6.6 \quad \left( \frac{1}{z} \frac{d}{dz} \right)^k (z^{\nu} \mathscr{C}_{\nu}(z)) &= z^{\nu-k} \mathscr{C}_{\nu-k}(z), \\ \left( \frac{1}{z} \frac{d}{dz} \right)^k (z^{-\nu} \mathscr{C}_{\nu}(z)) &= (-1)^k z^{-\nu-k} \mathscr{C}_{\nu+k}(z). \end{aligned}$$

$$10.6.7 \quad \mathscr{C}_{\nu}^{(k)}(z) = \frac{1}{2^k} \sum_{n=0}^k (-1)^n \binom{k}{n} \mathscr{C}_{\nu-k+2n}(z).$$

### 10.6(iii) Cross-Products

Let

$$\begin{aligned}
 p_\nu &= J_\nu(a) Y_\nu(b) - J_\nu(b) Y_\nu(a), \\
 q_\nu &= J_\nu(a) Y'_\nu(b) - J'_\nu(b) Y_\nu(a), \\
 r_\nu &= J'_\nu(a) Y_\nu(b) - J_\nu(b) Y'_\nu(a), \\
 s_\nu &= J'_\nu(a) Y'_\nu(b) - J'_\nu(b) Y'_\nu(a),
 \end{aligned}$$

where  $a$  and  $b$  are independent of  $\nu$ . Then

$$\begin{aligned}
 p_{\nu+1} - p_{\nu-1} &= -\frac{2\nu}{a} q_\nu - \frac{2\nu}{b} r_\nu, \\
 q_{\nu+1} + r_\nu &= \frac{\nu}{a} p_\nu - \frac{\nu+1}{b} p_{\nu+1}, \\
 r_{\nu+1} + q_\nu &= \frac{\nu}{b} p_\nu - \frac{\nu+1}{a} p_{\nu+1}, \\
 s_\nu &= \frac{1}{2} p_{\nu+1} + \frac{1}{2} p_{\nu-1} - \frac{\nu^2}{ab} p_\nu,
 \end{aligned}$$

and

$$p_\nu s_\nu - q_\nu r_\nu = 4/(\pi^2 ab).$$

## 10.7 Limiting Forms

### 10.7(i) $z \rightarrow 0$

When  $\nu$  is fixed and  $z \rightarrow 0$ ,

$$J_0(z) \rightarrow 1, \quad Y_0(z) \sim (2/\pi) \ln z,$$

$$H_0^{(1)}(z) \sim -H_0^{(2)}(z) \sim (2i/\pi) \ln z,$$

$$J_\nu(z) \sim (\frac{1}{2}z)^\nu / \Gamma(\nu + 1), \quad \nu \neq -1, -2, -3, \dots,$$

10.7.4

$$\begin{aligned}
 Y_\nu(z) &\sim -(1/\pi) \Gamma(\nu) (\frac{1}{2}z)^{-\nu}, \\
 &\quad \Re \nu > 0 \text{ or } \nu = -\frac{1}{2}, -\frac{3}{2}, -\frac{5}{2}, \dots,
 \end{aligned}$$

10.7.5

$$\begin{aligned}
 Y_{-\nu}(z) &\sim -(1/\pi) \cos(\nu\pi) \Gamma(\nu) (\frac{1}{2}z)^{-\nu}, \\
 &\quad \Re \nu > 0, \nu \neq \frac{1}{2}, \frac{3}{2}, \frac{5}{2}, \dots,
 \end{aligned}$$

10.7.6

$$\begin{aligned}
 Y_{i\nu}(z) &= \frac{i \operatorname{csch}(\nu\pi)}{\Gamma(1 - i\nu)} (\frac{1}{2}z)^{-i\nu} - \frac{i \operatorname{coth}(\nu\pi)}{\Gamma(1 + i\nu)} (\frac{1}{2}z)^{i\nu} \\
 &\quad + e^{|\nu \operatorname{ph} z|} o(1), \quad \nu \in \mathbb{R} \text{ and } \nu \neq 0.
 \end{aligned}$$

See also §10.24 when  $z = x (> 0)$ .

10.7.7

$$H_\nu^{(1)}(z) \sim -H_\nu^{(2)}(z) \sim -(i/\pi) \Gamma(\nu) (\frac{1}{2}z)^{-\nu}, \quad \Re \nu > 0.$$

For  $H_{-\nu}^{(1)}(z)$  and  $H_{-\nu}^{(2)}(z)$  when  $\Re \nu > 0$  combine (10.4.6) and (10.7.7). For  $H_{i\nu}^{(1)}(z)$  and  $H_{i\nu}^{(2)}(z)$  when  $\nu \in \mathbb{R}$  and  $\nu \neq 0$  combine (10.4.3), (10.7.3), and (10.7.6).

### 10.7(ii) $z \rightarrow \infty$

When  $\nu$  is fixed and  $z \rightarrow \infty$ ,

10.7.8

$$\begin{aligned}
 J_\nu(z) &= \sqrt{2/(\pi z)} \left( \cos(z - \frac{1}{2}\nu\pi - \frac{1}{4}\pi) + e^{|\Im z|} o(1) \right), \\
 Y_\nu(z) &= \sqrt{2/(\pi z)} \left( \sin(z - \frac{1}{2}\nu\pi - \frac{1}{4}\pi) + e^{|\Im z|} o(1) \right), \\
 &\quad |\operatorname{ph} z| \leq \pi - \delta (< \pi).
 \end{aligned}$$

For the corresponding results for  $H_\nu^{(1)}(z)$  and  $H_\nu^{(2)}(z)$  see (10.2.5) and (10.2.6).

## 10.8 Power Series

For  $J_\nu(z)$  see (10.2.2) and (10.4.1). When  $\nu$  is not an integer the corresponding expansions for  $Y_\nu(z)$ ,  $H_\nu^{(1)}(z)$ , and  $H_\nu^{(2)}(z)$  are obtained by combining (10.2.2) with (10.2.3), (10.4.7), and (10.4.8).

When  $n = 0, 1, 2, \dots$ ,

$$\begin{aligned}
 Y_n(z) &= -\frac{(\frac{1}{2}z)^{-n}}{\pi} \sum_{k=0}^{n-1} \frac{(n-k-1)!}{k!} (\frac{1}{4}z^2)^k \\
 &\quad + \frac{2}{\pi} \ln(\frac{1}{2}z) J_n(z) - \frac{(\frac{1}{2}z)^n}{\pi} \sum_{k=0}^{\infty} (\psi(k+1) \\
 &\quad + \psi(n+k+1)) \frac{(-\frac{1}{4}z^2)^k}{k!(n+k)!},
 \end{aligned}$$

where  $\psi(x) = \Gamma'(x)/\Gamma(x)$  (§5.2(i)). In particular,

10.8.2

$$\begin{aligned}
 Y_0(z) &= \frac{2}{\pi} (\ln(\frac{1}{2}z) + \gamma) J_0(z) + \frac{2}{\pi} \left( \frac{\frac{1}{4}z^2}{(1!)^2} - (1 + \frac{1}{2}) \frac{(\frac{1}{4}z^2)^2}{(2!)^2} \right. \\
 &\quad \left. + (1 + \frac{1}{2} + \frac{1}{3}) \frac{(\frac{1}{4}z^2)^3}{(3!)^2} - \dots \right),
 \end{aligned}$$

where  $\gamma$  is Euler's constant (§5.2(ii)).

For negative values of  $n$  use (10.4.1).

The corresponding results for  $H_n^{(1)}(z)$  and  $H_n^{(2)}(z)$  are obtained via (10.4.3) with  $\nu = n$ .

10.8.3

$$J_\nu(z) J_\mu(z) = (\frac{1}{2}z)^{\nu+\mu} \sum_{k=0}^{\infty} \frac{(\nu + \mu + k + 1)_k (-\frac{1}{4}z^2)^k}{k! \Gamma(\nu + k + 1) \Gamma(\mu + k + 1)}.$$

## 10.9 Integral Representations

### 10.9(i) Integrals along the Real Line

#### Bessel's Integral

10.9.1

$$J_0(z) = \frac{1}{\pi} \int_0^\pi \cos(z \sin \theta) d\theta = \frac{1}{\pi} \int_0^\pi \cos(z \cos \theta) d\theta,$$

10.9.2

$$\begin{aligned}
 J_n(z) &= \frac{1}{\pi} \int_0^\pi \cos(z \sin \theta - n\theta) d\theta \\
 &= \frac{i^{-n}}{\pi} \int_0^\pi e^{iz \cos \theta} \cos(n\theta) d\theta, \quad n \in \mathbb{Z}.
 \end{aligned}$$



**Neumann's Integral****10.9.3**

$$Y_0(z) = \frac{4}{\pi^2} \int_0^{\frac{1}{2}\pi} \cos(z \cos \theta) (\gamma + \ln(2z \sin^2 \theta)) d\theta,$$

where  $\gamma$  is Euler's constant (§5.2(ii)).

**Poisson's and Related Integrals**

$$\begin{aligned} J_\nu(z) &= \frac{(\frac{1}{2}z)^\nu}{\pi^{\frac{1}{2}} \Gamma(\nu + \frac{1}{2})} \int_0^\pi \cos(z \cos \theta) (\sin \theta)^{2\nu} d\theta \\ 10.9.4 \quad &= \frac{2(\frac{1}{2}z)^\nu}{\pi^{\frac{1}{2}} \Gamma(\nu + \frac{1}{2})} \int_0^1 (1-t^2)^{\nu-\frac{1}{2}} \cos(zt) dt, \\ &\Re \nu > -\frac{1}{2}. \end{aligned}$$

$$\begin{aligned} 10.9.5 \quad Y_\nu(z) &= \frac{2(\frac{1}{2}z)^\nu}{\pi^{\frac{1}{2}} \Gamma(\nu + \frac{1}{2})} \left( \int_0^1 (1-t^2)^{\nu-\frac{1}{2}} \sin(zt) dt \right. \\ &\quad \left. - \int_0^\infty e^{-zt} (1+t^2)^{\nu-\frac{1}{2}} dt \right), \\ &\Re \nu > -\frac{1}{2}, |\text{ph } z| < \frac{1}{2}\pi. \end{aligned}$$

**Schl\"afli's and Related Integrals****10.9.6**

$$\begin{aligned} J_\nu(z) &= \frac{1}{\pi} \int_0^\pi \cos(z \sin \theta - \nu\theta) d\theta \\ &\quad - \frac{\sin(\nu\pi)}{\pi} \int_0^\infty e^{-z \sinh t - \nu t} dt, \quad |\text{ph } z| < \frac{1}{2}\pi, \end{aligned}$$

**10.9.7**

$$\begin{aligned} Y_\nu(z) &= \frac{1}{\pi} \int_0^\pi \sin(z \sin \theta - \nu\theta) d\theta \\ &\quad - \frac{1}{\pi} \int_0^\infty (e^{\nu t} + e^{-\nu t} \cos(\nu\pi)) e^{-z \sinh t} dt, \\ &|\text{ph } z| < \frac{1}{2}\pi. \end{aligned}$$

**Mehler–Sonine and Related Integrals**

$$\begin{aligned} J_\nu(x) &= \frac{2}{\pi} \int_0^\infty \sin(x \cosh t - \frac{1}{2}\nu\pi) \cosh(\nu t) dt, \\ 10.9.8 \quad Y_\nu(x) &= -\frac{2}{\pi} \int_0^\infty \cos(x \cosh t - \frac{1}{2}\nu\pi) \cosh(\nu t) dt, \\ &|\Re \nu| < 1, x > 0. \end{aligned}$$

In particular,

$$\begin{aligned} 10.9.9 \quad J_0(x) &= \frac{2}{\pi} \int_0^\infty \sin(x \cosh t) dt, \quad x > 0, \\ Y_0(x) &= -\frac{2}{\pi} \int_0^\infty \cos(x \cosh t) dt, \quad x > 0. \end{aligned}$$

**10.9.10**

$$H_\nu^{(1)}(z) = \frac{e^{-\frac{1}{2}\nu\pi i}}{\pi i} \int_{-\infty}^\infty e^{iz \cosh t - \nu t} dt, \quad 0 < \text{ph } z < \pi,$$

**10.9.11**

$$H_\nu^{(2)}(z) = -\frac{e^{\frac{1}{2}\nu\pi i}}{\pi i} \int_{-\infty}^\infty e^{-iz \cosh t - \nu t} dt, \quad -\pi < \text{ph } z < 0.$$

$$J_\nu(x) = \frac{2(\frac{1}{2}x)^{-\nu}}{\pi^{\frac{1}{2}} \Gamma(\frac{1}{2} - \nu)} \int_1^\infty \frac{\sin(xt) dt}{(t^2 - 1)^{\nu+\frac{1}{2}}},$$

**10.9.12**

$$Y_\nu(x) = -\frac{2(\frac{1}{2}x)^{-\nu}}{\pi^{\frac{1}{2}} \Gamma(\frac{1}{2} - \nu)} \int_1^\infty \frac{\cos(xt) dt}{(t^2 - 1)^{\nu+\frac{1}{2}}},$$

$$|\Re \nu| < \frac{1}{2}, x > 0.$$

$$\begin{aligned} 10.9.13 \quad &\left( \frac{z + \zeta}{z - \zeta} \right)^{\frac{1}{2}\nu} J_\nu \left( (z^2 - \zeta^2)^{\frac{1}{2}} \right) \\ &= \frac{1}{\pi} \int_0^\pi e^{\zeta \cos \theta} \cos(z \sin \theta - \nu\theta) d\theta \\ &\quad - \frac{\sin(\nu\pi)}{\pi} \int_0^\infty e^{-\zeta \cosh t - z \sinh t - \nu t} dt, \\ &\Re(z + \zeta) > 0, \end{aligned}$$

**10.9.14**

$$\begin{aligned} &\left( \frac{z + \zeta}{z - \zeta} \right)^{\frac{1}{2}\nu} Y_\nu \left( (z^2 - \zeta^2)^{\frac{1}{2}} \right) \\ &= \frac{1}{\pi} \int_0^\pi e^{\zeta \cos \theta} \sin(z \sin \theta - \nu\theta) d\theta \\ &\quad - \frac{1}{\pi} \int_0^\infty (e^{\nu t + \zeta \cosh t} + e^{-\nu t - \zeta \cosh t} \cos(\nu\pi)) \\ &\quad \times e^{-z \sinh t} dt, \quad \Re(z \pm \zeta) > 0. \end{aligned}$$

$$\begin{aligned} 10.9.15 \quad &\left( \frac{z + \zeta}{z - \zeta} \right)^{\frac{1}{2}\nu} H_\nu^{(1)} \left( (z^2 - \zeta^2)^{\frac{1}{2}} \right) \\ &= \frac{1}{\pi i} e^{-\frac{1}{2}\nu\pi i} \int_{-\infty}^\infty e^{iz \cosh t + i\zeta \sinh t - \nu t} dt, \\ &\Im(z \pm \zeta) > 0, \end{aligned}$$

$$\begin{aligned} 10.9.16 \quad &\left( \frac{z + \zeta}{z - \zeta} \right)^{\frac{1}{2}\nu} H_\nu^{(2)} \left( (z^2 - \zeta^2)^{\frac{1}{2}} \right) \\ &= -\frac{1}{\pi i} e^{\frac{1}{2}\nu\pi i} \int_{-\infty}^\infty e^{-iz \cosh t - i\zeta \sinh t - \nu t} dt, \\ &\Im(z \pm \zeta) < 0. \end{aligned}$$

**10.9(ii) Contour Integrals****Schl\"afli–Sommerfeld Integrals**

When  $|\text{ph } z| < \frac{1}{2}\pi$ ,

$$10.9.17 \quad J_\nu(z) = \frac{1}{2\pi i} \int_{\infty-\pi i}^{\infty+\pi i} e^{z \sinh t - \nu t} dt,$$

and

$$\begin{aligned} 10.9.18 \quad H_\nu^{(1)}(z) &= \frac{1}{\pi i} \int_{-\infty}^{\infty+\pi i} e^{z \sinh t - \nu t} dt, \\ H_\nu^{(2)}(z) &= -\frac{1}{\pi i} \int_{-\infty}^{\infty-\pi i} e^{z \sinh t - \nu t} dt. \end{aligned}$$

**Schl\"afli's Integral**

$$10.9.19 \quad J_\nu(z) = \frac{(\frac{1}{2}z)^\nu}{2\pi i} \int_{-\infty}^{(0+)} \exp\left(t - \frac{z^2}{4t}\right) \frac{dt}{t^{\nu+1}},$$

where the integration path is a simple loop contour, and  $t^{\nu+1}$  is continuous on the path and takes its principal value at the intersection with the positive real axis.

**Hankel's Integrals**

In (10.9.20) and (10.9.21) the integration paths are simple loop contours not enclosing  $t = -1$ . Also,  $(t^2-1)^{\nu-\frac{1}{2}}$  is continuous on the path, and takes its principal value at the intersection with the interval  $(1, \infty)$ .

10.9.20

$$J_\nu(z) = \frac{\Gamma(\frac{1}{2} - \nu)(\frac{1}{2}z)^\nu}{\pi^{\frac{3}{2}}i} \int_0^{(1+)} \cos(zt)(t^2 - 1)^{\nu-\frac{1}{2}} dt, \quad \nu \neq \frac{1}{2}, \frac{3}{2}, \dots$$

10.9.21

$$H_\nu^{(1)}(z) = \frac{\Gamma(\frac{1}{2} - \nu)(\frac{1}{2}z)^\nu}{\pi^{\frac{3}{2}}i} \int_{1+i\infty}^{(1+)} e^{izt}(t^2 - 1)^{\nu-\frac{1}{2}} dt,$$

$$H_\nu^{(2)}(z) = \frac{\Gamma(\frac{1}{2} - \nu)(\frac{1}{2}z)^\nu}{\pi^{\frac{3}{2}}i} \int_{1-i\infty}^{(1+)} e^{-izt}(t^2 - 1)^{\nu-\frac{1}{2}} dt, \quad \nu \neq \frac{1}{2}, \frac{3}{2}, \dots, |\text{ph } z| < \frac{1}{2}\pi.$$

**Mellin-Barnes Type Integrals**

10.9.22

$$J_\nu(x) = \frac{1}{2\pi i} \int_{-i\infty}^{i\infty} \frac{\Gamma(-t)(\frac{1}{2}x)^{\nu+2t}}{\Gamma(\nu+t+1)} dt, \quad \Re \nu > 0, x > 0,$$

where the integration path passes to the left of  $t = 0, 1, 2, \dots$

$$10.9.23 \quad J_\nu(z) = \frac{1}{2\pi i} \int_{-\infty-ic}^{-\infty+ic} \frac{\Gamma(t)}{\Gamma(\nu-t+1)} (\frac{1}{2}z)^{\nu-2t} dt,$$

where  $c$  is a positive constant and the integration path encloses the points  $t = 0, -1, -2, \dots$

In (10.9.24) and (10.9.25)  $c$  is any constant exceeding  $\max(\Re \nu, 0)$ .

10.9.24

$$H_\nu^{(1)}(z) = -\frac{e^{-\frac{1}{2}\nu\pi i}}{2\pi^2} \int_{c-i\infty}^{c+i\infty} \Gamma(t) \Gamma(t-\nu) (-\frac{1}{2}iz)^{\nu-2t} dt, \quad 0 < \text{ph } z < \pi,$$

10.9.25

$$H_\nu^{(2)}(z) = \frac{e^{\frac{1}{2}\nu\pi i}}{2\pi^2} \int_{c-i\infty}^{c+i\infty} \Gamma(t) \Gamma(t-\nu) (\frac{1}{2}iz)^{\nu-2t} dt, \quad -\pi < \text{ph } z < 0.$$

For (10.9.22)–(10.9.25) and further integrals of this type see Paris and Kaminski (2001, pp. 114–116).

**10.9(iii) Products**

$$10.9.26 \quad J_\mu(z) J_\nu(z) = \frac{2}{\pi} \int_0^{\pi/2} J_{\mu+\nu}(2z \cos \theta) \cos(\mu - \nu)\theta d\theta, \quad \Re(\mu + \nu) > -1.$$

$$10.9.27 \quad J_\nu(z) J_\nu(\zeta) = \frac{2}{\pi} \int_0^{\pi/2} J_{2\nu}(2(z\zeta)^{\frac{1}{2}} \sin \theta) \cos((z - \zeta) \cos \theta) d\theta, \quad \Re \nu > -\frac{1}{2},$$

where the square root has its principal value.

$$10.9.28 \quad J_\nu(z) J_\nu(\zeta) = \frac{1}{2\pi i} \int_{c-i\infty}^{c+i\infty} \exp\left(\frac{1}{2}t - \frac{z^2 + \zeta^2}{2t}\right) I_\nu\left(\frac{z\zeta}{t}\right) \frac{dt}{t}, \quad \Re \nu > -1,$$

where  $c$  is a positive constant. For the function  $I_\nu$  see §10.25(ii).

**Mellin-Barnes Type**

$$10.9.29 \quad J_\mu(x) J_\nu(x) = \frac{1}{2\pi i} \int_{-i\infty}^{i\infty} \frac{\Gamma(-t) \Gamma(2t + \mu + \nu + 1) (\frac{1}{2}x)^{\mu+\nu+2t}}{\Gamma(t + \mu + 1) \Gamma(t + \nu + 1) \Gamma(t + \mu + \nu + 1)} dt, \quad x > 0,$$

where the path of integration separates the poles of  $\Gamma(-t)$  from those of  $\Gamma(2t + \mu + \nu + 1)$ . See Paris and Kaminski (2001, p. 116) for related results.

**Nicholson's Integral**

$$10.9.30 \quad J_\nu^2(z) + Y_\nu^2(z) = \frac{8}{\pi^2} \int_0^\infty \cosh(2\nu t) K_0(2z \sinh t) dt, \quad |\text{ph } z| < \frac{1}{2}\pi.$$

For the function  $K_0$  see §10.25(ii).

**10.9(iv) Compendia**

For collections of integral representations of Bessel and Hankel functions see Erdélyi *et al.* (1953b, §§7.3 and 7.12), Erdélyi *et al.* (1954a, pp. 43–48, 51–60, 99–105, 108–115, 123–124, 272–276, and 356–357), Gröbner and Hofreiter (1950, pp. 189–192), Marichev (1983, pp. 191–192 and 196–210), Magnus *et al.* (1966, §3.6), and Watson (1944, Chapter 6).

**10.10 Continued Fractions**

Assume  $J_{\nu-1}(z) \neq 0$ . Then

**10.10.1**

$$\frac{J_\nu(z)}{J_{\nu-1}(z)} = \frac{1}{2\nu z^{-1} - \frac{1}{2(\nu+1)z^{-1} - \frac{1}{2(\nu+2)z^{-1} - \dots}}}, \quad z \neq 0,$$

**10.10.2**

$$\frac{J_\nu(z)}{J_{\nu-1}(z)} = \frac{\frac{1}{2}z/\nu}{1 - \frac{\frac{1}{4}z^2/(\nu(\nu+1))}{1 - \frac{\frac{1}{4}z^2/((\nu+1)(\nu+2))}{1 - \dots}}}, \quad \nu \neq 0, -1, -2, \dots$$

See also Cuyt *et al.* (2008, pp. 349–356).

**10.11 Analytic Continuation**

When  $m \in \mathbb{Z}$ ,

**10.11.1**  $J_\nu(ze^{m\pi i}) = e^{m\nu\pi i} J_\nu(z),$

**10.11.2**  $Y_\nu(ze^{m\pi i}) = e^{-m\nu\pi i} Y_\nu(z) + 2i \sin(m\nu\pi) \cot(\nu\pi) J_\nu(z).$

**10.11.3**  $\sin(\nu\pi) H_\nu^{(1)}(ze^{m\pi i}) = -\sin((m-1)\nu\pi) H_\nu^{(1)}(z) - e^{-\nu\pi i} \sin(m\nu\pi) H_\nu^{(2)}(z),$

**10.11.4**  $\sin(\nu\pi) H_\nu^{(2)}(ze^{m\pi i}) = e^{\nu\pi i} \sin(m\nu\pi) H_\nu^{(1)}(z) + \sin((m+1)\nu\pi) H_\nu^{(2)}(z).$

**10.11.5**  $H_\nu^{(1)}(ze^{\pi i}) = -e^{-\nu\pi i} H_\nu^{(2)}(z),$   
 $H_\nu^{(2)}(ze^{-\pi i}) = -e^{\nu\pi i} H_\nu^{(1)}(z).$

If  $\nu = n \in \mathbb{Z}$ , then limiting values are taken in (10.11.2)–(10.11.4):

**10.11.6**  $Y_n(ze^{m\pi i}) = (-1)^{mn} (Y_n(z) + 2im J_n(z)),$

**10.11.7**  $H_n^{(1)}(ze^{m\pi i}) = (-1)^{mn-1} ((m-1) H_n^{(1)}(z) + m H_n^{(2)}(z)),$

**10.11.8**  $H_n^{(2)}(ze^{m\pi i}) = (-1)^{mn} (m H_n^{(1)}(z) + (m+1) H_n^{(2)}(z)).$

For real  $\nu$ ,

$$J_\nu(\bar{z}) = \overline{J_\nu(z)}, \quad Y_\nu(\bar{z}) = \overline{Y_\nu(z)},$$

**10.11.9**  $H_\nu^{(1)}(\bar{z}) = \overline{H_\nu^{(2)}(z)}, \quad H_\nu^{(2)}(\bar{z}) = \overline{H_\nu^{(1)}(z)}.$

For complex  $\nu$  replace  $\nu$  by  $\bar{\nu}$  on the right-hand sides.

**10.12 Generating Function and Associated Series**

For  $z \in \mathbb{C}$  and  $t \in \mathbb{C} \setminus \{0\}$ ,

**10.12.1**  $e^{\frac{1}{2}z(t-t^{-1})} = \sum_{m=-\infty}^{\infty} t^m J_m(z).$

For  $z, \theta \in \mathbb{C}$ ,

**10.12.2**  $\cos(z \sin \theta) = J_0(z) + 2 \sum_{k=1}^{\infty} J_{2k}(z) \cos(2k\theta),$

$\sin(z \sin \theta) = 2 \sum_{k=0}^{\infty} J_{2k+1}(z) \sin((2k+1)\theta),$

**10.12.3**  $\cos(z \cos \theta) = J_0(z) + 2 \sum_{k=1}^{\infty} (-1)^k J_{2k}(z) \cos(2k\theta),$

$\sin(z \cos \theta) = 2 \sum_{k=0}^{\infty} (-1)^k J_{2k+1}(z) \cos((2k+1)\theta).$

**10.12.4**  $1 = J_0(z) + 2J_2(z) + 2J_4(z) + 2J_6(z) + \dots,$

$\cos z = J_0(z) - 2J_2(z) + 2J_4(z) - 2J_6(z) + \dots,$

**10.12.5**  $\sin z = 2J_1(z) - 2J_3(z) + 2J_5(z) - \dots,$

**10.12.6**  $\frac{1}{2}z \cos z = J_1(z) - 9J_3(z) + 25J_5(z) - 49J_7(z) + \dots,$   
 $\frac{1}{2}z \sin z = 4J_2(z) - 16J_4(z) + 36J_6(z) - \dots$

**10.13 Other Differential Equations**

In the following equations  $\nu, \lambda, p, q$ , and  $r$  are real or complex constants with  $\lambda \neq 0, p \neq 0$ , and  $q \neq 0$ .

**10.13.1**  $w'' + \left(\lambda^2 - \frac{\nu^2 - \frac{1}{4}}{z^2}\right)w = 0, \quad w = z^{\frac{1}{2}} \mathcal{C}_\nu(\lambda z),$

**10.13.2**  $w'' + \left(\frac{\lambda^2}{4z} - \frac{\nu^2 - 1}{4z^2}\right)w = 0, \quad w = z^{\frac{1}{2}} \mathcal{C}_\nu(\lambda z^{\frac{1}{2}}),$

**10.13.3**  $w'' + \lambda^2 z^{p-2} w = 0, \quad w = z^{\frac{1}{2}} \mathcal{C}_{1/p}(2\lambda z^{\frac{1}{2}p/p}),$

**10.13.4**  $w'' - \frac{2\nu - 1}{z} w' + \lambda^2 w = 0, \quad w = z^\nu \mathcal{C}_\nu(\lambda z),$

**10.13.5**  $z^2 w'' + (1 - 2r)z w' + (\lambda^2 q^2 z^{2q} + r^2 - \nu^2 q^2)w = 0, \quad w = z^r \mathcal{C}_\nu(\lambda z^q),$

**10.13.6**  $w'' + (\lambda^2 e^{2z} - \nu^2)w = 0, \quad w = \mathcal{C}_\nu(\lambda e^z),$

$$10.13.7 \quad z^2(z^2 - \nu^2)w'' + z(z^2 - 3\nu^2)w' + ((z^2 - \nu^2)^2 - (z^2 + \nu^2))w = 0, \\ w = \mathcal{C}'_\nu(z),$$

$$10.13.8 \quad w^{(2n)} = (-1)^n \lambda^{2n} z^{-n} w, \\ w = z^{\frac{1}{2}n} \mathcal{C}_n \left( 2\lambda e^{k\pi i/n} z^{\frac{1}{2}} \right), \quad k = 0, 1, \dots, 2n - 1.$$

In (10.13.9)–(10.13.11)  $\mathcal{C}_\nu(z)$ ,  $\mathcal{D}_\mu(z)$  are any cylinder functions of orders  $\nu, \mu$ , respectively, and  $\vartheta = z(d/dz)$ .

$$10.13.9 \quad z^2 w''' + 3z w'' + (4z^2 + 1 - 4\nu^2)w' + 4z w = 0, \\ w = \mathcal{C}_\nu(z) \mathcal{D}_\nu(z),$$

$$10.13.10 \quad z^3 w''' + z(4z^2 + 1 - 4\nu^2)w' + (4\nu^2 - 1)w = 0, \\ w = z \mathcal{C}_\nu(z) \mathcal{D}_\nu(z),$$

$$10.13.11 \quad (\vartheta^4 - 2(\nu^2 + \mu^2)\vartheta^2 + (\nu^2 - \mu^2)^2) w + 4z^2(\vartheta + 1)(\vartheta + 2)w = 0, \quad w = \mathcal{C}_\nu(z) \mathcal{D}_\mu(z).$$

For further differential equations see Kamke (1977, pp. 440–451). See also Watson (1944, pp. 95–100).

### 10.14 Inequalities; Monotonicity

$$10.14.1 \quad |J_\nu(x)| \leq 1, \quad \nu \geq 0, x \in \mathbb{R}, \\ |J_\nu(x)| \leq 2^{-\frac{1}{2}}, \quad \nu \geq 1, x \in \mathbb{R}.$$

$$10.14.2 \quad 0 < J_\nu(\nu) < \frac{2^{\frac{1}{3}}}{3^{\frac{2}{3}} \Gamma(\frac{2}{3}) \nu^{\frac{1}{3}}}, \quad \nu > 0.$$

For monotonicity properties of  $J_\nu(\nu)$  and  $J'_\nu(\nu)$  see Lorch (1992).

$$10.14.3 \quad |J_n(z)| \leq e^{|\Im z|}, \quad n \in \mathbb{Z}.$$

$$10.14.4 \quad |J_\nu(z)| \leq \frac{\frac{1}{2} z |\nu e^{|\Im z|}}{\Gamma(\nu + 1)}, \quad \nu \geq -\frac{1}{2}.$$

$$10.14.5 \quad |J_\nu(\nu x)| \leq \frac{x^\nu \exp\left(\nu(1-x^2)^{\frac{1}{2}}\right)}{\left(1 + (1-x^2)^{\frac{1}{2}}\right)^\nu}, \quad \nu \geq 0, 0 < x \leq 1;$$

see Siegel (1953).

$$10.14.6 \quad |J'_\nu(\nu x)| \leq \frac{(1+x^2)^{\frac{1}{4}} x^\nu \exp\left(\nu(1-x^2)^{\frac{1}{2}}\right)}{x(2\pi\nu)^{\frac{1}{2}} \left(1 + (1-x^2)^{\frac{1}{2}}\right)^\nu}, \\ \nu > 0, 0 < x \leq 1;$$

see Watson (1944, p. 255). For a related bound for  $Y_\nu(\nu x)$  see Siegel and Sleator (1954).

$$10.14.7 \quad 1 \leq \frac{J_\nu(\nu x)}{x^\nu J_\nu(\nu)} \leq e^{\nu(1-x)}, \quad \nu \geq 0, 0 < x \leq 1;$$

see Paris (1984). For similar bounds for  $\mathcal{C}_\nu(x)$  (§10.2(ii)) see Laforgia (1986).

### Kapteyn's Inequality

$$10.14.8 \quad |J_n(nz)| \leq \frac{\left| z^n \exp\left(n(1-z^2)^{\frac{1}{2}}\right) \right|}{\left| 1 + (1-z^2)^{\frac{1}{2}} \right|^n}, \quad n = 0, 1, 2, \dots,$$

where  $(1-z^2)^{\frac{1}{2}}$  has its principal value.

$$10.14.9 \quad |J_n(nz)| \leq 1, \quad n = 0, 1, 2, \dots, z \in \mathbf{K},$$

where  $\mathbf{K}$  is defined in §10.20(ii).

For inequalities for the function  $\Gamma(\nu + 1)(2/x)^\nu J_\nu(x)$  with  $\nu > -\frac{1}{2}$  see Neuman (2004).

For further monotonicity properties see Landau (1999, 2000).

## 10.15 Derivatives with Respect to Order

### Noninteger Values of $\nu$

$$10.15.1 \quad \frac{\partial J_\nu(z)}{\partial \nu} = J_\nu(z) \ln\left(\frac{1}{2}z\right) - \left(\frac{1}{2}z\right)^\nu \sum_{k=0}^{\infty} (-1)^k \frac{\psi(\nu + k + 1)}{\Gamma(\nu + k + 1)} \frac{\left(\frac{1}{4}z^2\right)^k}{k!},$$

$$10.15.2 \quad \frac{\partial Y_\nu(z)}{\partial \nu} = \cot(\nu\pi) \left( \frac{\partial J_\nu(z)}{\partial \nu} - \pi Y_\nu(z) \right) - \csc(\nu\pi) \frac{\partial J_{-\nu}(z)}{\partial \nu} - \pi J_\nu(z).$$

### Integer Values of $\nu$

$$10.15.3 \quad \left. \frac{\partial J_\nu(z)}{\partial \nu} \right|_{\nu=n} = \frac{\pi}{2} Y_n(z) + \frac{n!}{2\left(\frac{1}{2}z\right)^n} \sum_{k=0}^{n-1} \frac{\left(\frac{1}{2}z\right)^k J_k(z)}{k!(n-k)},$$

$$10.15.4 \quad \left. \frac{\partial Y_\nu(z)}{\partial \nu} \right|_{\nu=n} = -\frac{\pi}{2} J_n(z) + \frac{n!}{2\left(\frac{1}{2}z\right)^n} \sum_{k=0}^{n-1} \frac{\left(\frac{1}{2}z\right)^k Y_k(z)}{k!(n-k)},$$

$$10.15.5 \quad \left. \frac{\partial J_\nu(z)}{\partial \nu} \right|_{\nu=0} = \frac{\pi}{2} Y_0(z), \quad \left. \frac{\partial Y_\nu(z)}{\partial \nu} \right|_{\nu=0} = -\frac{\pi}{2} J_0(z).$$

**Half-Integer Values of  $\nu$** 

For the notations Ci and Si see §6.2(ii). When  $x > 0$ ,

**10.15.6**

$$\left. \frac{\partial J_\nu(x)}{\partial \nu} \right|_{\nu=\frac{1}{2}} = \sqrt{\frac{2}{\pi x}} (\text{Ci}(2x) \sin x - \text{Si}(2x) \cos x),$$

**10.15.7**

$$\left. \frac{\partial J_\nu(x)}{\partial \nu} \right|_{\nu=-\frac{1}{2}} = \sqrt{\frac{2}{\pi x}} (\text{Ci}(2x) \cos x + \text{Si}(2x) \sin x),$$

**10.15.8**

$$\left. \frac{\partial Y_\nu(x)}{\partial \nu} \right|_{\nu=\frac{1}{2}} = \sqrt{\frac{2}{\pi x}} (\text{Ci}(2x) \cos x + (\text{Si}(2x) - \pi) \sin x),$$

**10.15.9**

$$\left. \frac{\partial Y_\nu(x)}{\partial \nu} \right|_{\nu=-\frac{1}{2}} = -\sqrt{\frac{2}{\pi x}} (\text{Ci}(2x) \sin x - (\text{Si}(2x) - \pi) \cos x).$$

For further results see Brychkov and Geddes (2005) and Landau (1999, 2000).

**10.16 Relations to Other Functions****Elementary Functions**

$$J_{\frac{1}{2}}(z) = Y_{-\frac{1}{2}}(z) = \left(\frac{2}{\pi z}\right)^{\frac{1}{2}} \sin z,$$

**10.16.1**

$$J_{-\frac{1}{2}}(z) = -Y_{\frac{1}{2}}(z) = \left(\frac{2}{\pi z}\right)^{\frac{1}{2}} \cos z,$$

$$H_{\frac{1}{2}}^{(1)}(z) = -i H_{-\frac{1}{2}}^{(1)}(z) = -i \left(\frac{2}{\pi z}\right)^{\frac{1}{2}} e^{iz},$$

**10.16.2**

$$H_{\frac{1}{2}}^{(2)}(z) = i H_{-\frac{1}{2}}^{(2)}(z) = i \left(\frac{2}{\pi z}\right)^{\frac{1}{2}} e^{-iz}.$$

For these and general results when  $\nu$  is half an odd integer see §§10.47(ii) and 10.49(i).

**Airy Functions**

See §§9.6(i) and 9.6(ii).

**Parabolic Cylinder Functions**

With the notation of §12.14(i),

**10.16.3**

$$J_{\frac{1}{4}}(z) = -2^{-\frac{1}{4}} \pi^{-\frac{1}{2}} z^{-\frac{1}{4}} \left( W\left(0, 2z^{\frac{1}{2}}\right) - W\left(0, -2z^{\frac{1}{2}}\right) \right),$$

$$J_{-\frac{1}{4}}(z) = 2^{-\frac{1}{4}} \pi^{-\frac{1}{2}} z^{-\frac{1}{4}} \left( W\left(0, 2z^{\frac{1}{2}}\right) + W\left(0, -2z^{\frac{1}{2}}\right) \right).$$

**10.16.4**

$$J_{\frac{3}{4}}(z) = -2^{-\frac{1}{4}} \pi^{-\frac{1}{2}} z^{-\frac{3}{4}} \left( W'\left(0, 2z^{\frac{1}{2}}\right) - W'\left(0, -2z^{\frac{1}{2}}\right) \right),$$

$$J_{-\frac{3}{4}}(z) = -2^{-\frac{1}{4}} \pi^{-\frac{1}{2}} z^{-\frac{3}{4}} \left( W'\left(0, 2z^{\frac{1}{2}}\right) + W'\left(0, -2z^{\frac{1}{2}}\right) \right).$$

Principal values on each side of these equations correspond.

**Confluent Hypergeometric Functions**

$$10.16.5 \quad J_\nu(z) = \frac{\left(\frac{1}{2}z\right)^\nu e^{\mp iz}}{\Gamma(\nu+1)} M\left(\nu + \frac{1}{2}, 2\nu + 1, \pm 2iz\right),$$

$$10.16.6 \quad \left. \begin{matrix} H_\nu^{(1)}(z) \\ H_\nu^{(2)}(z) \end{matrix} \right\} = \mp 2\pi^{-\frac{1}{2}} i e^{\mp \nu \pi i} (2z)^\nu \times e^{\pm iz} U\left(\nu + \frac{1}{2}, 2\nu + 1, \mp 2iz\right).$$

For the functions  $M$  and  $U$  see §13.2(i).

$$10.16.7 \quad J_\nu(z) = \frac{e^{\mp(2\nu+1)\pi i/4}}{2^{2\nu} \Gamma(\nu+1)} (2z)^{-\frac{1}{2}} M_{0,\nu}(\pm 2iz),$$

$$2\nu \neq -1, -2-3, \dots,$$

$$10.16.8 \quad \left. \begin{matrix} H_\nu^{(1)}(z) \\ H_\nu^{(2)}(z) \end{matrix} \right\} = e^{\mp(2\nu+1)\pi i/4} \left(\frac{2}{\pi z}\right)^{\frac{1}{2}} W_{0,\nu}(\mp 2iz).$$

For the functions  $M_{0,\nu}$  and  $W_{0,\nu}$  see §13.14(i).

In all cases principal branches correspond at least when  $|\text{ph } z| \leq \frac{1}{2}\pi$ .

**Generalized Hypergeometric Functions**

$$10.16.9 \quad J_\nu(z) = \frac{\left(\frac{1}{2}z\right)^\nu}{\Gamma(\nu+1)} {}_0F_1(-; \nu+1; -\frac{1}{4}z^2).$$

For  ${}_0F_1$  see (16.2.1).

With  $\mathbf{F}$  as in §15.2(i), and with  $z$  and  $\nu$  fixed,

$$10.16.10 \quad J_\nu(z) = \left(\frac{1}{2}z\right)^\nu \lim_{\lambda, \mu \rightarrow \infty} \mathbf{F}(\lambda, \mu; \nu+1; -z^2/(4\lambda\mu)),$$

as  $\lambda$  and  $\mu \rightarrow \infty$  in  $\mathbb{C}$ . For this result see Watson (1944, §5.7).

**10.17 Asymptotic Expansions for Large Argument****10.17(i) Hankel's Expansions**

Define  $a_0(\nu) = 1$ ,

**10.17.1**

$$a_k(\nu) = \frac{(4\nu^2 - 1^2)(4\nu^2 - 3^2) \cdots (4\nu^2 - (2k-1)^2)}{k! 8^k},$$

$$k \geq 1,$$

**10.17.2**

$$\omega = z - \frac{1}{2}\nu\pi - \frac{1}{4}\pi,$$

and let  $\delta$  denote an arbitrary small positive constant. Then as  $z \rightarrow \infty$ , with  $\nu$  fixed,

$$J_\nu(z) \sim \left(\frac{2}{\pi z}\right)^{\frac{1}{2}} \left( \cos \omega \sum_{k=0}^{\infty} (-1)^k \frac{a_{2k}(\nu)}{z^{2k}} \right.$$

**10.17.3**

$$\left. - \sin \omega \sum_{k=0}^{\infty} (-1)^k \frac{a_{2k+1}(\nu)}{z^{2k+1}} \right),$$

$$|\text{ph } z| \leq \pi - \delta,$$

$$10.17.4 \quad Y_\nu(z) \sim \left(\frac{2}{\pi z}\right)^{\frac{1}{2}} \left( \sin \omega \sum_{k=0}^{\infty} (-1)^k \frac{a_{2k}(\nu)}{z^{2k}} + \cos \omega \sum_{k=0}^{\infty} (-1)^k \frac{a_{2k+1}(\nu)}{z^{2k+1}} \right),$$

$|\text{ph } z| \leq \pi - \delta,$

$$10.17.5 \quad H_\nu^{(1)}(z) \sim \left(\frac{2}{\pi z}\right)^{\frac{1}{2}} e^{i\omega} \sum_{k=0}^{\infty} i^k \frac{a_k(\nu)}{z^k},$$

$-\pi + \delta \leq \text{ph } z \leq 2\pi - \delta,$

$$10.17.6 \quad H_\nu^{(2)}(z) \sim \left(\frac{2}{\pi z}\right)^{\frac{1}{2}} e^{-i\omega} \sum_{k=0}^{\infty} (-i)^k \frac{a_k(\nu)}{z^k},$$

$-2\pi + \delta \leq \text{ph } z \leq \pi - \delta,$

---


$$10.17.8 \quad b_k(\nu) = \frac{((4\nu^2 - 1^2)(4\nu^2 - 3^2) \cdots (4\nu^2 - (2k - 3)^2)) (4\nu^2 + 4k^2 - 1)}{k! 8^k}.$$

Then as  $z \rightarrow \infty$  with  $\nu$  fixed,

$$10.17.9 \quad J'_\nu(z) \sim -\left(\frac{2}{\pi z}\right)^{\frac{1}{2}} \left( \sin \omega \sum_{k=0}^{\infty} (-1)^k \frac{b_{2k}(\nu)}{z^{2k}} + \cos \omega \sum_{k=0}^{\infty} (-1)^k \frac{b_{2k+1}(\nu)}{z^{2k+1}} \right),$$

$|\text{ph } z| \leq \pi - \delta,$

$$10.17.10 \quad Y'_\nu(z) \sim \left(\frac{2}{\pi z}\right)^{\frac{1}{2}} \left( \cos \omega \sum_{k=0}^{\infty} (-1)^k \frac{b_{2k}(\nu)}{z^{2k}} - \sin \omega \sum_{k=0}^{\infty} (-1)^k \frac{b_{2k+1}(\nu)}{z^{2k+1}} \right),$$

$|\text{ph } z| \leq \pi - \delta,$

$$10.17.11 \quad H_\nu^{(1)'}(z) \sim i \left(\frac{2}{\pi z}\right)^{\frac{1}{2}} e^{i\omega} \sum_{k=0}^{\infty} i^k \frac{b_k(\nu)}{z^k},$$

$-\pi + \delta \leq \text{ph } z \leq 2\pi - \delta,$

$$10.17.12 \quad H_\nu^{(2)'}(z) \sim -i \left(\frac{2}{\pi z}\right)^{\frac{1}{2}} e^{-i\omega} \sum_{k=0}^{\infty} (-i)^k \frac{b_k(\nu)}{z^k},$$

$-2\pi + \delta \leq \text{ph } z \leq \pi - \delta.$

**10.17(iii) Error Bounds for Real Argument and Order**

In the expansions (10.17.3) and (10.17.4) assume that  $\nu \geq 0$  and  $z > 0$ . Then the remainder associated with the sum  $\sum_{k=0}^{\ell-1} (-1)^k a_{2k}(\nu) z^{-2k}$  does not exceed the first neglected term in absolute value and has the same sign provided that  $\ell \geq \max(\frac{1}{2}\nu - \frac{1}{4}, 1)$ . Similarly for  $\sum_{k=0}^{\ell-1} (-1)^k a_{2k+1}(\nu) z^{-2k-1}$ , provided that  $\ell \geq \max(\frac{1}{2}\nu - \frac{3}{4}, 1)$ .

In the expansions (10.17.5) and (10.17.6) assume that  $\nu > -\frac{1}{2}$  and  $z > 0$ . If these expansions are terminated when  $k = \ell - 1$ , then the remainder term is bounded in absolute value by the first neglected term, provided that  $\ell \geq \max(\nu - \frac{1}{2}, 1)$ .

where the branch of  $z^{\frac{1}{2}}$  is determined by

$$10.17.7 \quad z^{\frac{1}{2}} = \exp\left(\frac{1}{2} \ln |z| + \frac{1}{2} i \text{ph } z\right).$$

Corresponding expansions for other ranges of  $\text{ph } z$  can be obtained by combining (10.17.3), (10.17.5), (10.17.6) with the continuation formulas (10.11.1), (10.11.3), (10.11.4) (or (10.11.7), (10.11.8)), and also the connection formula given by the second of (10.4.4).

**10.17(ii) Asymptotic Expansions of Derivatives**

We continue to use the notation of §10.17(i). Also,  $b_0(\nu) = 1$ ,  $b_1(\nu) = (4\nu^2 + 3)/8$ , and for  $k \geq 2$ ,

**10.17(iv) Error Bounds for Complex Argument and Order**

For (10.17.5) and (10.17.6) write

$$10.17.13 \quad \left. \begin{aligned} H_\nu^{(1)}(z) \\ H_\nu^{(2)}(z) \end{aligned} \right\} = \left(\frac{2}{\pi z}\right)^{\frac{1}{2}} e^{\pm i\omega} \left( \sum_{k=0}^{\ell-1} (\pm i)^k \frac{a_k(\nu)}{z^k} + R_\ell^\pm(\nu, z) \right),$$

$\ell = 1, 2, \dots$

Then

$$10.17.14 \quad |R_\ell^\pm(\nu, z)| \leq 2|a_\ell(\nu)| \mathcal{V}_{z, \pm i\infty}(t^{-\ell}) \times \exp\left(|\nu^2 - \frac{1}{4}| \mathcal{V}_{z, \pm i\infty}(t^{-\ell})\right),$$

where  $\mathcal{V}$  denotes the variational operator (2.3.6), and the paths of variation are subject to the condition that  $|\Im t|$  changes monotonically. Bounds for  $\mathcal{V}_{z, i\infty}(t^{-\ell})$  are given by

$$10.17.15 \quad \mathcal{V}_{z,i\infty}(t^{-\ell}) \leq \begin{cases} |z|^{-\ell}, & 0 \leq \text{ph } z \leq \pi, \\ \chi(\ell)|z|^{-\ell}, & -\frac{1}{2}\pi \leq \text{ph } z \leq 0 \text{ or } \pi \leq \text{ph } z \leq \frac{3}{2}\pi, \\ 2\chi(\ell)|\Im z|^{-\ell}, & -\pi < \text{ph } z \leq -\frac{1}{2}\pi \text{ or } \frac{3}{2}\pi \leq \text{ph } z < 2\pi, \end{cases}$$

where  $\chi(\ell) = \pi^{\frac{1}{2}} \Gamma(\frac{1}{2}\ell + 1) / \Gamma(\frac{1}{2}\ell + \frac{1}{2})$ ; see §9.7(i). The bounds (10.17.15) also apply to  $\mathcal{V}_{z,-i\infty}(t^{-\ell})$  in the conjugate sectors.

Corresponding error bounds for (10.17.3) and (10.17.4) are obtainable by combining (10.17.13) and (10.17.14) with (10.4.4).

**10.17(v) Exponentially-Improved Expansions**

As in §9.7(v) denote

$$10.17.16 \quad G_p(z) = \frac{e^z}{2\pi} \Gamma(p) \Gamma(1-p, z),$$

where  $\Gamma(1-p, z)$  is the incomplete gamma function (§8.2(i)). Then in (10.17.13) as  $z \rightarrow \infty$  with  $|\ell - 2|z||$  bounded and  $m (\geq 0)$  fixed,

$$10.17.17 \quad R_{\ell}^{\pm}(\nu, z) = (-1)^{\ell} 2 \cos(\nu\pi) \times \left( \sum_{k=0}^{m-1} (\pm i)^k \frac{a_k(\nu)}{z^k} G_{\ell-k}(\mp 2iz) + R_{m,\ell}^{\pm}(\nu, z) \right),$$

where

$$10.17.18 \quad R_{m,\ell}^{\pm}(\nu, z) = O\left(e^{-2|z|} z^{-m}\right), \quad |\text{ph}(ze^{\mp \frac{1}{2}\pi i})| \leq \pi.$$

For higher re-expansions of the remainder terms see Olde Daalhuis and Olver (1995a) and Olde Daalhuis (1995, 1996).

**10.18 Modulus and Phase Functions**

**10.18(i) Definitions**

For  $\nu \geq 0$  and  $x > 0$

$$10.18.1 \quad M_{\nu}(x)e^{i\theta_{\nu}(x)} = H_{\nu}^{(1)}(x),$$

$$10.18.2 \quad N_{\nu}(x)e^{i\phi_{\nu}(x)} = H_{\nu}^{(1)'}(x),$$

where  $M_{\nu}(x) (> 0)$ ,  $N_{\nu}(x) (> 0)$ ,  $\theta_{\nu}(x)$ , and  $\phi_{\nu}(x)$  are continuous real functions of  $\nu$  and  $x$ , with the branches of  $\theta_{\nu}(x)$  and  $\phi_{\nu}(x)$  fixed by

$$10.18.3 \quad \theta_{\nu}(x) \rightarrow -\frac{1}{2}\pi, \quad \phi_{\nu}(x) \rightarrow \frac{1}{2}\pi, \quad x \rightarrow 0+.$$

**10.18(ii) Basic Properties**

$$10.18.4 \quad \begin{aligned} J_{\nu}(x) &= M_{\nu}(x) \cos \theta_{\nu}(x), \\ Y_{\nu}(x) &= M_{\nu}(x) \sin \theta_{\nu}(x), \end{aligned}$$

$$10.18.5 \quad \begin{aligned} J'_{\nu}(x) &= N_{\nu}(x) \cos \phi_{\nu}(x), \\ Y'_{\nu}(x) &= N_{\nu}(x) \sin \phi_{\nu}(x), \end{aligned}$$

$$10.18.6 \quad \begin{aligned} M_{\nu}(x) &= (J_{\nu}^2(x) + Y_{\nu}^2(x))^{\frac{1}{2}}, \\ N_{\nu}(x) &= (J'_{\nu}{}^2(x) + Y'_{\nu}{}^2(x))^{\frac{1}{2}}, \end{aligned}$$

$$10.18.7 \quad \begin{aligned} \theta_{\nu}(x) &= \text{Arctan}(Y_{\nu}(x) / J_{\nu}(x)), \\ \phi_{\nu}(x) &= \text{Arctan}(Y'_{\nu}(x) / J'_{\nu}(x)). \end{aligned}$$

$$10.18.8 \quad M_{\nu}^2(x) \theta'_{\nu}(x) = \frac{2}{\pi x}, \quad N_{\nu}^2(x) \phi'_{\nu}(x) = \frac{2(x^2 - \nu^2)}{\pi x^3},$$

$$10.18.9 \quad \begin{aligned} N_{\nu}^2(x) &= M_{\nu}^2(x) + M_{\nu}^2(x) \theta_{\nu}^2(x) = M_{\nu}^2(x) + \frac{4}{(\pi x M_{\nu}(x))^2}, \end{aligned}$$

$$10.18.10 \quad (x^2 - \nu^2) M_{\nu}(x) M'_{\nu}(x) + x^2 N_{\nu}(x) N'_{\nu}(x) + x N_{\nu}^2(x) = 0.$$

$$10.18.11 \quad \tan(\phi_{\nu}(x) - \theta_{\nu}(x)) = \frac{M_{\nu}(x) \theta'_{\nu}(x)}{M'_{\nu}(x)} = \frac{2}{\pi x M_{\nu}(x) M'_{\nu}(x)},$$

$$10.18.12 \quad M_{\nu}(x) N_{\nu}(x) \sin(\phi_{\nu}(x) - \theta_{\nu}(x)) = \frac{2}{\pi x}.$$

$$10.18.13 \quad x^2 M_{\nu}''(x) + x M_{\nu}'(x) + (x^2 - \nu^2) M_{\nu}(x) = \frac{4}{\pi^2 M_{\nu}^3(x)},$$

$$10.18.14 \quad w'' + \left(1 + \frac{\frac{1}{4} - \nu^2}{x^2}\right) w = \frac{4}{\pi^2 w^3}, \quad w = x^{\frac{1}{2}} M_{\nu}(x),$$

$$10.18.15 \quad \begin{aligned} x^3 w''' + x(4x^2 + 1 - 4\nu^2)w' + (4\nu^2 - 1)w &= 0, \\ w &= x M_{\nu}^2(x). \end{aligned}$$

$$10.18.16 \quad \theta_{\nu}^2(x) + \frac{1}{2} \frac{\theta_{\nu}'''(x)}{\theta_{\nu}'(x)} - \frac{3}{4} \left(\frac{\theta_{\nu}''(x)}{\theta_{\nu}'(x)}\right)^2 = 1 - \frac{\nu^2 - \frac{1}{4}}{x^2}.$$

**10.18(iii) Asymptotic Expansions for Large Argument**

As  $x \rightarrow \infty$ , with  $\nu$  fixed and  $\mu = 4\nu^2$ ,

**10.18.17** 
$$M_\nu^2(x) \sim \frac{2}{\pi x} \left( 1 + \frac{1}{2} \frac{\mu - 1}{(2x)^2} + \frac{1 \cdot 3}{2 \cdot 4} \frac{(\mu - 1)(\mu - 9)}{(2x)^4} + \frac{1 \cdot 3 \cdot 5}{2 \cdot 4 \cdot 6} \frac{(\mu - 1)(\mu - 9)(\mu - 25)}{(2x)^6} + \dots \right),$$

**10.18.18** 
$$\theta_\nu(x) \sim x - \left( \frac{1}{2}\nu + \frac{1}{4} \right) \pi + \frac{\mu - 1}{2(4x)} + \frac{(\mu - 1)(\mu - 25)}{6(4x)^3} + \frac{(\mu - 1)(\mu^2 - 114\mu + 1073)}{5(4x)^5} + \frac{(\mu - 1)(5\mu^3 - 1535\mu^2 + 54703\mu - 3\,75733)}{14(4x)^7} + \dots$$

Also,

**10.18.19** 
$$N_\nu^2(x) \sim \frac{2}{\pi x} \left( 1 - \frac{1}{2} \frac{\mu - 3}{(2x)^2} - \frac{1}{2 \cdot 4} \frac{(\mu - 1)(\mu - 45)}{(2x)^4} - \dots \right),$$

the general term in this expansion being

**10.18.20** 
$$-\frac{(2k - 3)!! (\mu - 1)(\mu - 9) \cdots (\mu - (2k - 3)^2)(\mu - (2k + 1)(2k - 1)^2)}{(2k)!! (2x)^{2k}}, \quad k \geq 2,$$

and

**10.18.21** 
$$\phi_\nu(x) \sim x - \left( \frac{1}{2}\nu - \frac{1}{4} \right) \pi + \frac{\mu + 3}{2(4x)} + \frac{\mu^2 + 46\mu - 63}{6(4x)^3} + \frac{\mu^3 + 185\mu^2 - 2053\mu + 1899}{5(4x)^5} + \dots$$

The remainder after  $k$  terms in (10.18.17) does not exceed the  $(k + 1)$ th term in absolute value and is of the same sign, provided that  $k > \nu - \frac{1}{2}$ .

**10.19 Asymptotic Expansions for Large Order**

**10.19(i) Asymptotic Forms**

If  $\nu \rightarrow \infty$  through positive real values, with  $z (\neq 0)$  fixed, then

**10.19.1** 
$$J_\nu(z) \sim \frac{1}{\sqrt{2\pi\nu}} \left( \frac{ez}{2\nu} \right)^\nu,$$

**10.19.2**

$$Y_\nu(z) \sim -i H_\nu^{(1)}(z) \sim i H_\nu^{(2)}(z) \sim -\sqrt{\frac{2}{\pi\nu}} \left( \frac{ez}{2\nu} \right)^{-\nu}.$$

**10.19(ii) Debye's Expansions**

If  $\nu \rightarrow \infty$  through positive real values with  $\alpha (> 0)$  fixed, then

**10.19.3**

$$J_\nu(\nu \operatorname{sech} \alpha) \sim \frac{e^{\nu(\tanh \alpha - \alpha)}}{(2\pi\nu \tanh \alpha)^{\frac{1}{2}}} \sum_{k=0}^{\infty} \frac{U_k(\coth \alpha)}{\nu^k},$$

$$Y_\nu(\nu \operatorname{sech} \alpha) \sim -\frac{e^{\nu(\alpha - \tanh \alpha)}}{(\frac{1}{2}\pi\nu \tanh \alpha)^{\frac{1}{2}}} \sum_{k=0}^{\infty} (-1)^k \frac{U_k(\coth \alpha)}{\nu^k},$$

**10.19.4**

$$J'_\nu(\nu \operatorname{sech} \alpha) \sim \left( \frac{\sinh(2\alpha)}{4\pi\nu} \right)^{\frac{1}{2}} e^{\nu(\tanh \alpha - \alpha)} \sum_{k=0}^{\infty} \frac{V_k(\coth \alpha)}{\nu^k},$$

$$Y'_\nu(\nu \operatorname{sech} \alpha) \sim \left( \frac{\sinh(2\alpha)}{\pi\nu} \right)^{\frac{1}{2}} e^{\nu(\alpha - \tanh \alpha)} \sum_{k=0}^{\infty} (-1)^k \frac{V_k(\coth \alpha)}{\nu^k}.$$

If  $\nu \rightarrow \infty$  through positive real values with  $\beta (\in (0, \frac{1}{2}\pi))$  fixed, and

**10.19.5** 
$$\xi = \nu(\tan \beta - \beta) - \frac{1}{4}\pi,$$

then

**10.19.6**

$$J_\nu(\nu \sec \beta) \sim \left( \frac{2}{\pi\nu \tan \beta} \right)^{\frac{1}{2}} \left( \cos \xi \sum_{k=0}^{\infty} \frac{U_{2k}(i \cot \beta)}{\nu^{2k}} - i \sin \xi \sum_{k=0}^{\infty} \frac{U_{2k+1}(i \cot \beta)}{\nu^{2k+1}} \right),$$

$$Y_\nu(\nu \sec \beta) \sim \left( \frac{2}{\pi\nu \tan \beta} \right)^{\frac{1}{2}} \left( \sin \xi \sum_{k=0}^{\infty} \frac{U_{2k}(i \cot \beta)}{\nu^{2k}} + i \cos \xi \sum_{k=0}^{\infty} \frac{U_{2k+1}(i \cot \beta)}{\nu^{2k+1}} \right),$$

**10.19.7**

$$J'_\nu(\nu \sec \beta) \sim \left( \frac{\sin(2\beta)}{\pi\nu} \right)^{\frac{1}{2}} \left( -\sin \xi \sum_{k=0}^{\infty} \frac{V_{2k}(i \cot \beta)}{\nu^{2k}} - i \cos \xi \sum_{k=0}^{\infty} \frac{V_{2k+1}(i \cot \beta)}{\nu^{2k+1}} \right),$$

$$Y'_\nu(\nu \sec \beta) \sim \left( \frac{\sin(2\beta)}{\pi\nu} \right)^{\frac{1}{2}} \left( \cos \xi \sum_{k=0}^{\infty} \frac{V_{2k}(i \cot \beta)}{\nu^{2k}} - i \sin \xi \sum_{k=0}^{\infty} \frac{V_{2k+1}(i \cot \beta)}{\nu^{2k+1}} \right).$$



In these expansions  $U_k(p)$  and  $V_k(p)$  are the polynomials in  $p$  of degree  $3k$  defined in §10.41(ii).

For error bounds for the first of (10.19.3) see Olver (1997b, p. 382).

### 10.19(iii) Transition Region

As  $\nu \rightarrow \infty$ , with  $a \in \mathbb{C}$  fixed,

$$10.19.8 \quad J_\nu(\nu + a\nu^{1/3}) \sim \frac{2^{1/3}}{\nu^{1/3}} \text{Ai}\left(-2^{1/3}a\right) \sum_{k=0}^{\infty} \frac{P_k(a)}{\nu^{2k/3}} + \frac{2^{2/3}}{\nu} \text{Ai}'\left(-2^{1/3}a\right) \sum_{k=0}^{\infty} \frac{Q_k(a)}{\nu^{2k/3}}, \quad |\text{ph } \nu| \leq \frac{1}{2}\pi - \delta,$$

$$Y_\nu(\nu + a\nu^{1/3}) \sim -\frac{2^{1/3}}{\nu^{1/3}} \text{Bi}\left(-2^{1/3}a\right) \sum_{k=0}^{\infty} \frac{P_k(a)}{\nu^{2k/3}} - \frac{2^{2/3}}{\nu} \text{Bi}'\left(-2^{1/3}a\right) \sum_{k=0}^{\infty} \frac{Q_k(a)}{\nu^{2k/3}}, \quad |\text{ph } \nu| \leq \frac{1}{2}\pi - \delta.$$

Also,

$$10.19.9 \quad \left. \begin{matrix} H_\nu^{(1)}(\nu + a\nu^{1/3}) \\ H_\nu^{(2)}(\nu + a\nu^{1/3}) \end{matrix} \right\} \sim \frac{2^{4/3}}{\nu^{1/3}} e^{\mp\pi i/3} \text{Ai}\left(e^{\mp\pi i/3} 2^{1/3}a\right) \sum_{k=0}^{\infty} \frac{P_k(a)}{\nu^{2k/3}} + \frac{2^{5/3}}{\nu} e^{\pm\pi i/3} \text{Ai}'\left(e^{\mp\pi i/3} 2^{1/3}a\right) \sum_{k=0}^{\infty} \frac{Q_k(a)}{\nu^{2k/3}},$$

with sectors of validity  $-\frac{1}{2}\pi + \delta \leq \pm \text{ph } \nu \leq \frac{3}{2}\pi - \delta$ . Here Ai and Bi are the Airy functions (§9.2), and

#### 10.19.10

$$P_0(a) = 1, \quad P_1(a) = -\frac{1}{5}a, \quad P_2(a) = -\frac{9}{100}a^5 + \frac{3}{35}a^2, \\ P_3(a) = \frac{957}{7000}a^6 - \frac{173}{3150}a^3 - \frac{1}{225}, \\ P_4(a) = \frac{27}{20000}a^{10} - \frac{23573}{147000}a^7 + \frac{5903}{138600}a^4 + \frac{947}{346500}a,$$

$$Q_0(a) = \frac{3}{10}a^2, \quad Q_1(a) = -\frac{17}{70}a^3 + \frac{1}{70},$$

$$10.19.11 \quad Q_2(a) = -\frac{9}{1000}a^7 + \frac{611}{3150}a^4 - \frac{37}{3150}a, \\ Q_3(a) = -\frac{549}{28000}a^8 - \frac{110767}{693000}a^5 + \frac{79}{12375}a^2.$$

For corresponding expansions for derivatives see <http://dlmf.nist.gov/10.19.iii>.

For proofs and also for the corresponding expansions for second derivatives see Olver (1952).

For higher coefficients in (10.19.8) in the case  $a = 0$  (that is, in the expansions of  $J_\nu(\nu)$  and  $Y_\nu(\nu)$ ), see Watson (1944, §8.21) and Temme (1997).

## 10.20 Uniform Asymptotic Expansions for Large Order

### 10.20(i) Real Variables

Define  $\zeta = \zeta(z)$  to be the solution of the differential equation

$$10.20.1 \quad \left(\frac{d\zeta}{dz}\right)^2 = \frac{1-z^2}{\zeta z^2}$$

that is infinitely differentiable on the interval  $0 < z < \infty$ , including  $z = 1$ . Then

#### 10.20.2

$$\frac{2}{3}\zeta^{3/2} = \int_z^1 \frac{\sqrt{1-t^2}}{t} dt = \ln\left(\frac{1+\sqrt{1-z^2}}{z}\right) - \sqrt{1-z^2}, \quad 0 < z \leq 1,$$

$$10.20.3 \quad \frac{2}{3}(-\zeta)^{3/2} = \int_1^z \frac{\sqrt{t^2-1}}{t} dt = \sqrt{z^2-1} - \text{arcsec } z, \quad 1 \leq z < \infty,$$

all functions taking their principal values, with  $\zeta = \infty, 0, -\infty$ , corresponding to  $z = 0, 1, \infty$ , respectively.

As  $\nu \rightarrow \infty$  through positive real values

$$10.20.4 \quad J_\nu(\nu z) \sim \left(\frac{4\zeta}{1-z^2}\right)^{1/4} \left( \frac{\text{Ai}\left(\nu^{2/3}\zeta\right)}{\nu^{1/3}} \sum_{k=0}^{\infty} \frac{A_k(\zeta)}{\nu^{2k}} + \frac{\text{Ai}'\left(\nu^{2/3}\zeta\right)}{\nu^{5/3}} \sum_{k=0}^{\infty} \frac{B_k(\zeta)}{\nu^{2k}} \right),$$

$$10.20.5 \quad Y_\nu(\nu z) \sim -\left(\frac{4\zeta}{1-z^2}\right)^{1/4} \left( \frac{\text{Bi}\left(\nu^{2/3}\zeta\right)}{\nu^{1/3}} \sum_{k=0}^{\infty} \frac{A_k(\zeta)}{\nu^{2k}} + \frac{\text{Bi}'\left(\nu^{2/3}\zeta\right)}{\nu^{5/3}} \sum_{k=0}^{\infty} \frac{B_k(\zeta)}{\nu^{2k}} \right),$$

$$10.20.6 \quad \left. \begin{matrix} H_\nu^{(1)}(\nu z) \\ H_\nu^{(2)}(\nu z) \end{matrix} \right\} \sim 2e^{\mp\pi i/3} \left(\frac{4\zeta}{1-z^2}\right)^{1/4} \left( \frac{\text{Ai}\left(e^{\pm 2\pi i/3} \nu^{2/3}\zeta\right)}{\nu^{1/3}} \sum_{k=0}^{\infty} \frac{A_k(\zeta)}{\nu^{2k}} + \frac{e^{\pm 2\pi i/3} \text{Ai}'\left(e^{\pm 2\pi i/3} \nu^{2/3}\zeta\right)}{\nu^{5/3}} \sum_{k=0}^{\infty} \frac{B_k(\zeta)}{\nu^{2k}} \right),$$

$$10.20.7 \quad J'_\nu(\nu z) \sim -\frac{2}{z} \left( \frac{1-z^2}{4\zeta} \right)^{\frac{1}{4}} \left( \frac{\text{Ai}(\nu^{\frac{2}{3}}\zeta)}{\nu^{\frac{4}{3}}} \sum_{k=0}^{\infty} \frac{C_k(\zeta)}{\nu^{2k}} + \frac{\text{Ai}'(\nu^{\frac{2}{3}}\zeta)}{\nu^{\frac{2}{3}}} \sum_{k=0}^{\infty} \frac{D_k(\zeta)}{\nu^{2k}} \right),$$

$$10.20.8 \quad Y'_\nu(\nu z) \sim \frac{2}{z} \left( \frac{1-z^2}{4\zeta} \right)^{\frac{1}{4}} \left( \frac{\text{Bi}(\nu^{\frac{2}{3}}\zeta)}{\nu^{\frac{4}{3}}} \sum_{k=0}^{\infty} \frac{C_k(\zeta)}{\nu^{2k}} + \frac{\text{Bi}'(\nu^{\frac{2}{3}}\zeta)}{\nu^{\frac{2}{3}}} \sum_{k=0}^{\infty} \frac{D_k(\zeta)}{\nu^{2k}} \right),$$

$$10.20.9 \quad \left. \begin{matrix} H_\nu^{(1)'}(\nu z) \\ H_\nu^{(2)'}(\nu z) \end{matrix} \right\} \sim \frac{4e^{\mp 2\pi i/3}}{z} \left( \frac{1-z^2}{4\zeta} \right)^{\frac{1}{4}} \left( \frac{e^{\mp 2\pi i/3} \text{Ai}(e^{\pm 2\pi i/3} \nu^{\frac{2}{3}}\zeta)}{\nu^{\frac{4}{3}}} \sum_{k=0}^{\infty} \frac{C_k(\zeta)}{\nu^{2k}} + \frac{\text{Ai}'(e^{\pm 2\pi i/3} \nu^{\frac{2}{3}}\zeta)}{\nu^{\frac{2}{3}}} \sum_{k=0}^{\infty} \frac{D_k(\zeta)}{\nu^{2k}} \right),$$

uniformly for  $z \in (0, \infty)$  in all cases, where Ai and Bi are the Airy functions (§9.2).

In the following formulas for the coefficients  $A_k(\zeta)$ ,  $B_k(\zeta)$ ,  $C_k(\zeta)$ , and  $D_k(\zeta)$ ,  $u_k, v_k$  are the constants defined in §9.7(i), and  $U_k(p), V_k(p)$  are the polynomials in  $p$  of degree  $3k$  defined in §10.41(ii).

**Interval  $0 < z < 1$**

$$10.20.10 \quad A_k(\zeta) = \sum_{j=0}^{2k} \left(\frac{3}{2}\right)^j v_j \zeta^{-3j/2} U_{2k-j} \left( (1-z^2)^{-\frac{1}{2}} \right),$$

10.20.11

$$B_k(\zeta) = -\zeta^{-\frac{1}{2}} \sum_{j=0}^{2k+1} \left(\frac{3}{2}\right)^j u_j \zeta^{-3j/2} U_{2k-j+1} \left( (1-z^2)^{-\frac{1}{2}} \right),$$

10.20.12

$$C_k(\zeta) = -\zeta^{\frac{1}{2}} \sum_{j=0}^{2k+1} \left(\frac{3}{2}\right)^j v_j \zeta^{-3j/2} V_{2k-j+1} \left( (1-z^2)^{-\frac{1}{2}} \right),$$

$$10.20.13 \quad D_k(\zeta) = \sum_{j=0}^{2k} \left(\frac{3}{2}\right)^j u_j \zeta^{-3j/2} V_{2k-j} \left( (1-z^2)^{-\frac{1}{2}} \right).$$

**Interval  $1 < z < \infty$**

In formulas (10.20.10)–(10.20.13) replace  $\zeta^{\frac{1}{2}}, \zeta^{-\frac{1}{2}}, \zeta^{-3j/2}$ , and  $(1-z^2)^{-\frac{1}{2}}$  by  $-i(-\zeta)^{\frac{1}{2}}, i(-\zeta)^{-\frac{1}{2}}, i^{3j}(-\zeta)^{-3j/2}$ , and  $i(z^2-1)^{-\frac{1}{2}}$ , respectively.

Note: Another way of arranging the above formulas for the coefficients  $A_k(\zeta), B_k(\zeta), C_k(\zeta)$ , and  $D_k(\zeta)$  would be by analogy with (12.10.42) and (12.10.46). In this way there is less usage of many-valued functions.

**Values at  $\zeta = 0$**

$$10.20.14 \quad \begin{aligned} A_0(0) &= 1, & A_1(0) &= -\frac{1}{225}, \\ A_2(0) &= \frac{1\ 51439}{2182\ 95000}, & A_3(0) &= -\frac{8872\ 78009}{250\ 49351\ 25000}, \\ B_0(0) &= \frac{1}{70} 2^{\frac{1}{3}}, & B_1(0) &= -\frac{1213}{10\ 23750} 2^{\frac{1}{3}}, \\ B_2(0) &= \frac{1\ 65425\ 37833}{3774\ 32055\ 00000} 2^{\frac{1}{3}}, \\ B_3(0) &= -\frac{430\ 99056\ 39368\ 59253}{5\ 68167\ 34399\ 42500\ 00000} 2^{\frac{1}{3}}. \end{aligned}$$

Each of the coefficients  $A_k(\zeta), B_k(\zeta), C_k(\zeta)$ , and  $D_k(\zeta)$ ,  $k = 0, 1, 2, \dots$ , is real and infinitely differentiable on the interval  $-\infty < \zeta < \infty$ . For (10.20.14)

and further information on the coefficients see Temme (1997).

For numerical tables of  $\zeta = \zeta(z), (4\zeta/(1-z^2))^{\frac{1}{4}}$  and  $A_k(\zeta), B_k(\zeta), C_k(\zeta)$ , and  $D_k(\zeta)$  see Olver (1962, pp. 28–42).

### 10.20(ii) Complex Variables

The function  $\zeta = \zeta(z)$  given by (10.20.2) and (10.20.3) can be continued analytically to the  $z$ -plane cut along the negative real axis. Corresponding points of the mapping are shown in Figures 10.20.1 and 10.20.2.

The equations of the curved boundaries  $D_1E_1$  and  $D_2E_2$  in the  $\zeta$ -plane are given parametrically by

$$10.20.15 \quad \zeta = \left(\frac{3}{2}\right)^{\frac{2}{3}} (\tau \mp i\pi)^{\frac{2}{3}}, \quad 0 \leq \tau < \infty, \text{ respectively.}$$

The curves  $BP_1E_1$  and  $BP_2E_2$  in the  $z$ -plane are the inverse maps of the line segments

$$10.20.16 \quad \zeta = e^{\mp i\pi/3} \tau, \quad 0 \leq \tau \leq \left(\frac{3}{2}\pi\right)^{\frac{2}{3}}, \text{ respectively. They are given parametrically by}$$

$$10.20.17 \quad z = \pm(\tau \coth \tau - \tau^2)^{\frac{1}{2}} \pm i(\tau^2 - \tau \tanh \tau)^{\frac{1}{2}}, \quad 0 \leq \tau \leq \tau_0, \text{ where } \tau_0 = 1.19968\dots \text{ is the positive root of the equation } \tau = \coth \tau. \text{ The points } P_1, P_2 \text{ where these curves intersect the imaginary axis are } \pm ic, \text{ where}$$

$$10.20.18 \quad c = (\tau_0^2 - 1)^{\frac{1}{2}} = 0.66274\dots$$

The eye-shaped closed domain in the uncut  $z$ -plane that is bounded by  $BP_1E_1$  and  $BP_2E_2$  is denoted by  $\mathbf{K}$ ; see Figure 10.20.3.

As  $\nu \rightarrow \infty$  through positive real values the expansions (10.20.4)–(10.20.9) apply uniformly for  $|\text{ph } z| \leq \pi - \delta$ , the coefficients  $A_k(\zeta), B_k(\zeta), C_k(\zeta)$ , and  $D_k(\zeta)$ , being the analytic continuations of the functions defined in §10.20(i) when  $\zeta$  is real.

For proofs of the above results and for error bounds and extensions of the regions of validity see Olver (1997b, pp. 419–425). For extensions to complex  $\nu$  see Olver (1954). For resurgence properties of the coefficients (§2.7(ii)) see Howls and Olde Daalhuis (1999). For further results see Dunster (2001a), Wang and Wong (2002), and Paris (2004).

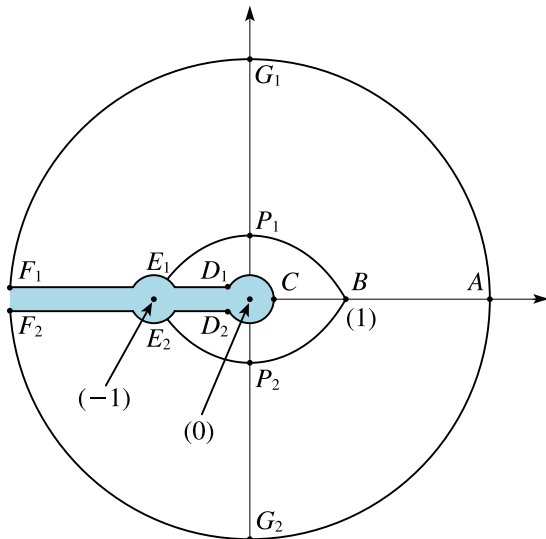


Figure 10.20.1:  $z$ -plane.  $P_1$  and  $P_2$  are the points  $\pm ic$ .  $c = 0.66274\dots$

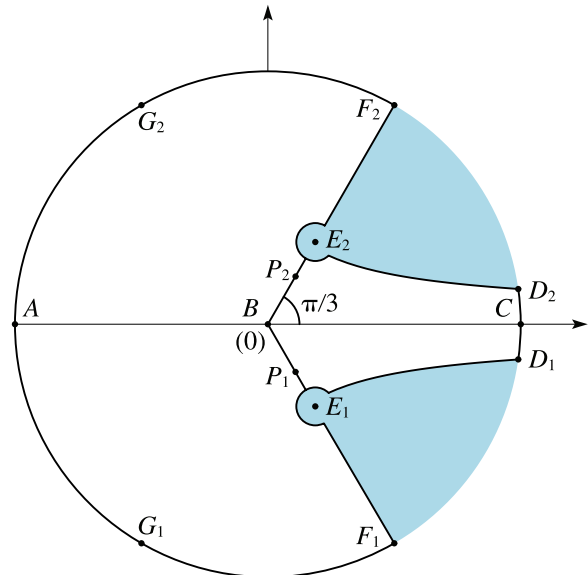


Figure 10.20.2:  $\zeta$ -plane.  $E_1$  and  $E_2$  are the points  $e^{\mp\pi i/3}(3\pi/2)^{2/3}$ .

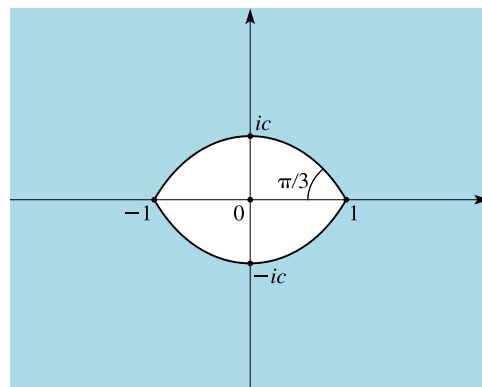


Figure 10.20.3:  $z$ -plane. Domain  $\mathbf{K}$  (unshaded).  $c = 0.66274\dots$

**10.20(iii) Double Asymptotic Properties**

For asymptotic properties of the expansions (10.20.4)–(10.20.6) with respect to large values of  $z$  see §10.41(v).

**10.21 Zeros**

**10.21(i) Distribution**

The zeros of any cylinder function or its derivative are simple, with the possible exceptions of  $z = 0$  in the case of the functions, and  $z = 0, \pm\nu$  in the case of the derivatives.

If  $\nu$  is real, then  $J_\nu(z)$ ,  $J'_\nu(z)$ ,  $Y_\nu(z)$ , and  $Y'_\nu(z)$ , each have an infinite number of positive real zeros. All of these zeros are simple, provided that  $\nu \geq -1$  in the case of  $J'_\nu(z)$ , and  $\nu \geq -\frac{1}{2}$  in the case of  $Y'_\nu(z)$ . When all of their zeros are simple, the  $m$ th positive zeros of these functions are denoted by  $j_{\nu,m}$ ,  $j'_{\nu,m}$ ,  $y_{\nu,m}$ , and  $y'_{\nu,m}$  respectively, except that  $z = 0$  is counted as the first zero of  $J'_0(z)$ . Since  $J'_0(z) = -J_1(z)$  we have

**10.21.1** 
$$j'_{0,1} = 0, \quad j'_{0,m} = j_{1,m-1}, \quad m = 2, 3, \dots$$

When  $\nu \geq 0$ , the zeros interlace according to the inequalities

**10.21.2** 
$$j_{\nu,1} < j_{\nu+1,1} < j_{\nu,2} < j_{\nu+1,2} < j_{\nu,3} < \dots, \\ y_{\nu,1} < y_{\nu+1,1} < y_{\nu,2} < y_{\nu+1,2} < y_{\nu,3} < \dots,$$

**10.21.3** 
$$\nu \leq j'_{\nu,1} < y_{\nu,1} < y'_{\nu,1} < j_{\nu,1} < j'_{\nu,2} < y_{\nu,2} < \dots$$

The positive zeros of any two real distinct cylinder functions of the same order are interlaced, as are the positive zeros of any real cylinder function  $\mathcal{C}_\nu(z)$  and the contiguous function  $\mathcal{C}_{\nu+1}(z)$ . See also Elbert and Laforgia (1994).

When  $\nu \geq -1$  the zeros of  $J_\nu(z)$  are all real. If  $\nu < -1$  and  $\nu$  is not an integer, then the number of complex zeros of  $J_\nu(z)$  is  $2 \lfloor -\nu \rfloor$ . If  $\lfloor -\nu \rfloor$  is odd, then two of these zeros lie on the imaginary axis.

If  $\nu \geq 0$ , then the zeros of  $J'_\nu(z)$  are all real.

For information on the real double zeros of  $J'_\nu(z)$  and  $Y'_\nu(z)$  when  $\nu < -1$  and  $\nu < -\frac{1}{2}$ , respectively, see Döring (1971) and Kerimov and Skorokhodov (1986). The latter reference also has information on double zeros of the second and third derivatives of  $J_\nu(z)$  and  $Y_\nu(z)$ .

No two of the functions  $J_0(z)$ ,  $J_1(z)$ ,  $J_2(z)$ ,  $\dots$ , have any common zeros other than  $z = 0$ ; see Watson (1944, §15.28).

**10.21(ii) Analytic Properties**

If  $\rho_\nu$  is a zero of the cylinder function

**10.21.4** 
$$\mathcal{C}_\nu(z) = J_\nu(z) \cos(\pi t) + Y_\nu(z) \sin(\pi t),$$

where  $t$  is a parameter, then

**10.21.5** 
$$\mathcal{C}'_\nu(\rho_\nu) = \mathcal{C}_{\nu-1}(\rho_\nu) = -\mathcal{C}_{\nu+1}(\rho_\nu).$$

If  $\sigma_\nu$  is a zero of  $\mathcal{C}'_\nu(z)$ , then

**10.21.6** 
$$\mathcal{C}_\nu(\sigma_\nu) = \frac{\sigma_\nu}{\nu} \mathcal{C}_{\nu-1}(\sigma_\nu) = \frac{\sigma_\nu}{\nu} \mathcal{C}_{\nu+1}(\sigma_\nu).$$

The parameter  $t$  may be regarded as a continuous variable and  $\rho_\nu$ ,  $\sigma_\nu$  as functions  $\rho_\nu(t)$ ,  $\sigma_\nu(t)$  of  $t$ . If  $\nu \geq 0$  and these functions are fixed by

**10.21.7** 
$$\rho_\nu(0) = 0, \quad \sigma_\nu(0) = j'_{\nu,1},$$

then

**10.21.8** 
$$j_{\nu,m} = \rho_\nu(m), \quad y_{\nu,m} = \rho_\nu(m - \frac{1}{2}), \quad m = 1, 2, \dots,$$

**10.21.9** 
$$j'_{\nu,m} = \sigma_\nu(m - 1), \quad y'_{\nu,m} = \sigma_\nu(m - \frac{1}{2}), \\ m = 1, 2, \dots$$

**10.21.10** 
$$\mathcal{C}'_\nu(\rho_\nu) = \left( \frac{\rho_\nu}{2} \frac{d\rho_\nu}{dt} \right)^{-\frac{1}{2}}, \quad \mathcal{C}_\nu(\sigma_\nu) = \left( \frac{\sigma_\nu^2 - \nu^2}{2\sigma_\nu} \frac{d\sigma_\nu}{dt} \right)^{-\frac{1}{2}},$$

**10.21.11** 
$$2\rho_\nu^2 \frac{d\rho_\nu}{dt} \frac{d^3\rho_\nu}{dt^3} - 3\rho_\nu^2 \left( \frac{d^2\rho_\nu}{dt^2} \right)^2 - 4\pi^2 \rho_\nu^2 \left( \frac{d\rho_\nu}{dt} \right)^2 + (4\rho_\nu^2 + 1 - 4\nu^2) \left( \frac{d\rho_\nu}{dt} \right)^4 = 0.$$

The functions  $\rho_\nu(t)$  and  $\sigma_\nu(t)$  are related to the inverses of the phase functions  $\theta_\nu(x)$  and  $\phi_\nu(x)$  defined in §10.18(i): if  $\nu \geq 0$ , then

**10.21.12** 
$$\theta_\nu(j_{\nu,m}) = (m - \frac{1}{2})\pi, \quad \theta_\nu(y_{\nu,m}) = (m - 1)\pi, \\ m = 1, 2, \dots,$$

**10.21.13** 
$$\phi_\nu(j'_{\nu,m}) = (m - \frac{1}{2})\pi, \quad \phi_\nu(y'_{\nu,m}) = m\pi, \\ m = 1, 2, \dots$$

For sign properties of the forward differences that are defined by

**10.21.14** 
$$\Delta \rho_\nu(t) = \rho_\nu(t + 1) - \rho_\nu(t), \\ \Delta^2 \rho_\nu(t) = \Delta \rho_\nu(t + 1) - \Delta \rho_\nu(t), \dots,$$

when  $t = 1, 2, 3, \dots$ , and similarly for  $\sigma_\nu(t)$ , see Lorch and Szego (1963, 1964), Lorch *et al.* (1970, 1972), and Muldoon (1977).

**10.21(iii) Infinite Products**

**10.21.15** 
$$J_\nu(z) = \frac{(\frac{1}{2}z)^\nu}{\Gamma(\nu + 1)} \prod_{k=1}^{\infty} \left( 1 - \frac{z^2}{j_{\nu,k}^2} \right), \quad \nu \geq 0,$$

**10.21.16** 
$$J'_\nu(z) = \frac{(\frac{1}{2}z)^{\nu-1}}{2\Gamma(\nu)} \prod_{k=1}^{\infty} \left( 1 - \frac{z^2}{j'_{\nu,k}{}^2} \right), \quad \nu > 0.$$

**10.21(iv) Monotonicity Properties**

Any positive zero  $c$  of the cylinder function  $\mathcal{C}_\nu(x)$  and any positive zero  $c'$  of  $\mathcal{C}'_\nu(x)$  such that  $c' > |\nu|$  are definable as continuous and increasing functions of  $\nu$ :

10.21.17 
$$\frac{dc}{d\nu} = 2c \int_0^\infty K_0(2c \sinh t) e^{-2\nu t} dt,$$

10.21.18 
$$\frac{dc'}{d\nu} = \frac{2c'}{c'^2 - \nu^2} \int_0^\infty (c'^2 \cosh(2t) - \nu^2) \times K_0(2c' \sinh t) e^{-2\nu t} dt,$$

where  $K_0$  is defined in §10.25(ii).

In particular,  $j_{\nu,m}$ ,  $y_{\nu,m}$ ,  $j'_{\nu,m}$ , and  $y'_{\nu,m}$  are increasing functions of  $\nu$  when  $\nu \geq 0$ . It is also true that the positive zeros  $j''_\nu$  and  $j'''_\nu$  of  $J''_\nu(x)$  and  $J'''_\nu(x)$ , respectively, are increasing functions of  $\nu$  when  $\nu > 0$ , provided that in the latter case  $j'''_\nu > \sqrt{3}$  when  $0 < \nu < 1$ .

$j_{\nu,m}/\nu$  and  $j'_{\nu,m}/\nu$  are decreasing functions of  $\nu$  when  $\nu > 0$  for  $m = 1, 2, 3, \dots$

For further monotonicity properties see Elbert (2001), Lorch (1990, 1993, 1995), Lorch and Szego (1990, 1995), and Muldoon (1981). For inequalities for zeros arising from monotonicity properties see Laforgia and Muldoon (1983).

**10.21(v) Inequalities**

For bounds for the smallest real or purely imaginary zeros of  $J_\nu(x)$  when  $\nu$  is real see Ismail and Muldoon (1995).

**10.21(vi) McMahon's Asymptotic Expansions for Large Zeros**

If  $\nu$  ( $\geq 0$ ) is fixed,  $\mu = 4\nu^2$ , and  $m \rightarrow \infty$ , then

10.21.19 
$$j_{\nu,m}, y_{\nu,m} \sim a - \frac{\mu - 1}{8a} - \frac{4(\mu - 1)(7\mu - 31)}{3(8a)^3} - \frac{32(\mu - 1)(83\mu^2 - 982\mu + 3779)}{15(8a)^5} - \frac{64(\mu - 1)(6949\mu^3 - 153855\mu^2 + 1585743\mu - 6277237)}{105(8a)^7} - \dots,$$

where  $a = (m + \frac{1}{2}\nu - \frac{1}{4})\pi$  for  $j_{\nu,m}$ ,  $a = (m + \frac{1}{2}\nu - \frac{3}{4})\pi$  for  $y_{\nu,m}$ . With  $a = (t + \frac{1}{2}\nu - \frac{1}{4})\pi$ , the right-hand side is the asymptotic expansion of  $\rho_\nu(t)$  for large  $t$ .

10.21.20 
$$j'_{\nu,m}, y'_{\nu,m} \sim b - \frac{\mu + 3}{8b} - \frac{4(7\mu^2 + 82\mu - 9)}{3(8b)^3} - \frac{32(83\mu^3 + 2075\mu^2 - 3039\mu + 3537)}{15(8b)^5} - \frac{64(6949\mu^4 + 296492\mu^3 - 1248002\mu^2 + 7414380\mu - 5853627)}{105(8b)^7} - \dots,$$

where  $b = (m + \frac{1}{2}\nu - \frac{3}{4})\pi$  for  $j'_{\nu,m}$ ,  $b = (m + \frac{1}{2}\nu - \frac{1}{4})\pi$  for  $y'_{\nu,m}$ , and  $b = (t + \frac{1}{2}\nu + \frac{1}{4})\pi$  for  $\sigma_\nu(t)$ .

For the next three terms in (10.21.19) and the next two terms in (10.21.20) see Bickley *et al.* (1952, p. xxxvii) or Olver (1960, pp. xvii–xviii).

For error bounds see Wong and Lang (1990), Wong (1995), and Elbert and Laforgia (2000). See also Laforgia (1979).

For the  $m$ th positive zero  $j''_{\nu,m}$  of  $J''_\nu(x)$  Wong and Lang (1990) gives the corresponding expansion

10.21.21 
$$j''_{\nu,m} \sim c - \frac{\mu + 7}{8c} - \frac{28\mu^2 + 424\mu + 1724}{3(8c)^3} - \dots,$$

where  $c = (m + \frac{1}{2}\nu - \frac{1}{4})\pi$  if  $0 < \nu < 1$ , and  $c = (m + \frac{1}{2}\nu - \frac{5}{4})\pi$  if  $\nu > 1$ . An error bound is included for the case  $\nu \geq \frac{3}{2}$ .

**10.21(vii) Asymptotic Expansions for Large Order**

Let  $\mathcal{C}_\nu(x)$ ,  $\rho_\nu(t)$ , and  $\sigma_\nu(t)$  be defined as in §10.21(ii) and  $M(x)$ ,  $\theta(x)$ ,  $N(x)$ , and  $\phi(x)$  denote the modulus

and phase functions for the Airy functions and their derivatives as in §9.8.

As  $\nu \rightarrow \infty$  with  $t$  ( $> 0$ ) fixed,

10.21.22 
$$\rho_\nu(t) \sim \nu \sum_{k=0}^\infty \frac{\alpha_k}{\nu^{2k/3}},$$

10.21.23 
$$\mathcal{C}'_\nu(\rho_\nu(t)) \sim \frac{(2/\nu)^{2/3}}{\pi M(-2^{1/3}\alpha)} \sum_{k=0}^\infty \frac{\beta_k}{\nu^{2k/3}},$$

where  $\alpha$  is given by

10.21.24 
$$\theta(-2^{1/3}\alpha) = \pi t,$$

and

$$\alpha_0 = 1, \quad \alpha_1 = \alpha, \quad \alpha_2 = \frac{3}{10}\alpha^2,$$

10.21.25 
$$\alpha_3 = -\frac{1}{350}\alpha^3 + \frac{1}{70}, \quad \alpha_4 = -\frac{479}{63000}\alpha^4 - \frac{1}{3150}\alpha,$$

$$\alpha_5 = \frac{20231}{8085000}\alpha^5 - \frac{551}{161700}\alpha^2,$$

10.21.26

$$\beta_0 = 1, \quad \beta_1 = -\frac{4}{5}\alpha, \quad \beta_2 = \frac{18}{35}\alpha^2,$$

$$\beta_3 = -\frac{88}{315}\alpha^3 - \frac{11}{1575}, \quad \beta_4 = \frac{79586}{606375}\alpha^4 + \frac{9824}{606375}\alpha.$$

As  $\nu \rightarrow \infty$  with  $t$  ( $> -\frac{1}{6}$ ) fixed,

$$10.21.27 \quad \sigma_\nu(t) \sim \nu \sum_{k=0}^{\infty} \frac{\alpha'_k}{\nu^{2k/3}},$$

$$10.21.28 \quad \mathcal{C}_\nu(\sigma_\nu(t)) \sim \frac{(2/\nu)^{\frac{1}{3}}}{\pi N(-2^{\frac{1}{3}}\alpha')} \sum_{k=0}^{\infty} \frac{\beta'_k}{\nu^{2k/3}},$$

where  $\alpha'$  is given by

$$10.21.29 \quad \phi(-2^{\frac{1}{3}}\alpha') = \pi t,$$

and

10.21.30

$$\begin{aligned} \alpha'_0 &= 1, & \alpha'_1 &= \alpha', & \alpha'_2 &= \frac{3}{10}\alpha'^2 - \frac{1}{10}\alpha'^{-1}, \\ \alpha'_3 &= -\frac{1}{350}\alpha'^3 - \frac{1}{25} - \frac{1}{200}\alpha'^{-3}, \\ \alpha'_4 &= -\frac{479}{63000}\alpha'^4 + \frac{509}{31500}\alpha' + \frac{1}{1500}\alpha'^{-2} - \frac{1}{2000}\alpha'^{-5}, \end{aligned}$$

10.21.31

$$\begin{aligned} \beta'_0 &= 1, & \beta'_1 &= -\frac{1}{5}\alpha', & \beta'_2 &= \frac{9}{350}\alpha'^2 + \frac{1}{100}\alpha'^{-1}, \\ \beta'_3 &= \frac{89}{15750}\alpha'^3 - \frac{47}{4500} + \frac{1}{3000}\alpha'^{-3}. \end{aligned}$$

In particular, with the notation as below,

$$10.21.32 \quad j_{\nu,m} \sim \nu \sum_{k=0}^{\infty} \frac{\alpha_k}{\nu^{2k/3}},$$

$$10.21.33 \quad y_{\nu,m} \sim \nu \sum_{k=0}^{\infty} \frac{\alpha_k}{\nu^{2k/3}},$$

$$10.21.34 \quad J'_\nu(j_{\nu,m}) \sim (-1)^m \frac{(2/\nu)^{\frac{2}{3}}}{\pi M(a_m)} \sum_{k=0}^{\infty} \frac{\beta_k}{\nu^{2k/3}},$$

$$10.21.35 \quad Y'_\nu(y_{\nu,m}) \sim (-1)^{m-1} \frac{(2/\nu)^{\frac{2}{3}}}{\pi M(b_m)} \sum_{k=0}^{\infty} \frac{\beta_k}{\nu^{2k/3}},$$

and

$$10.21.36 \quad j'_{\nu,m} \sim \nu \sum_{k=0}^{\infty} \frac{\alpha'_k}{\nu^{2k/3}},$$

$$10.21.37 \quad y'_{\nu,m} \sim \nu \sum_{k=0}^{\infty} \frac{\alpha'_k}{\nu^{2k/3}},$$

$$10.21.38 \quad J_\nu(j'_{\nu,m}) \sim (-1)^{m-1} \frac{(2/\nu)^{\frac{1}{3}}}{\pi N(a'_m)} \sum_{k=0}^{\infty} \frac{\beta'_k}{\nu^{2k/3}},$$

$$10.21.39 \quad Y_\nu(y'_{\nu,m}) \sim (-1)^{m-1} \frac{(2/\nu)^{\frac{1}{3}}}{\pi N(b'_m)} \sum_{k=0}^{\infty} \frac{\beta'_k}{\nu^{2k/3}}.$$

Here  $a_m, b_m, a'_m, b'_m$  are the  $m$ th negative zeros of  $\text{Ai}(x), \text{Bi}(x), \text{Ai}'(x), \text{Bi}'(x)$ , respectively (§9.9),  $\alpha_k, \beta_k, \alpha'_k, \beta'_k$  are given by (10.21.25), (10.21.26), (10.21.30), and (10.21.31), with  $\alpha = -2^{-\frac{1}{3}}a_m$  in the case of  $j_{\nu,m}$  and  $J'_\nu(j_{\nu,m})$ ,  $\alpha = -2^{-\frac{1}{3}}b_m$  in the case of  $y_{\nu,m}$  and  $Y'_\nu(y_{\nu,m})$ ,  $\alpha' = -2^{-\frac{1}{3}}a'_m$  in the case of  $j'_{\nu,m}$  and  $J_\nu(j'_{\nu,m})$ ,  $\alpha' = -2^{-\frac{1}{3}}b'_m$  in the case of  $y'_{\nu,m}$  and  $Y_\nu(y'_{\nu,m})$ .

For error bounds for (10.21.32) see Qu and Wong (1999); for (10.21.36) and (10.21.37) see Elbert and Laforgia (1997). See also Spigler (1980).

For the first zeros rounded numerical values of the coefficients are given by

$$\begin{aligned} j_{\nu,1} &\sim \nu + 1.85575 \, 71\nu^{\frac{1}{3}} + 1.03315 \, 0\nu^{-\frac{1}{3}} - 0.00397\nu^{-1} - 0.0908\nu^{-\frac{5}{3}} + 0.043\nu^{-\frac{7}{3}} + \dots, \\ y_{\nu,1} &\sim \nu + 0.93157 \, 68\nu^{\frac{1}{3}} + 0.26035 \, 1\nu^{-\frac{1}{3}} + 0.01198\nu^{-1} - 0.0060\nu^{-\frac{5}{3}} - 0.001\nu^{-\frac{7}{3}} + \dots, \\ J'_\nu(j_{\nu,1}) &\sim -1.11310 \, 28\nu^{-\frac{2}{3}} \div (1 + 1.48460 \, 6\nu^{-\frac{2}{3}} + 0.43294\nu^{-\frac{4}{3}} - 0.1943\nu^{-2} + 0.019\nu^{-\frac{8}{3}} + \dots), \\ Y'_\nu(y_{\nu,1}) &\sim 0.95554 \, 86\nu^{-\frac{2}{3}} \div (1 + 0.74526 \, 1\nu^{-\frac{2}{3}} + 0.10910\nu^{-\frac{4}{3}} - 0.0185\nu^{-2} - 0.003\nu^{-\frac{8}{3}} + \dots), \\ j'_{\nu,1} &\sim \nu + 0.80861 \, 65\nu^{\frac{1}{3}} + 0.07249 \, 0\nu^{-\frac{1}{3}} - 0.05097\nu^{-1} + 0.0094\nu^{-\frac{5}{3}} + \dots, \\ y'_{\nu,1} &\sim \nu + 1.82109 \, 80\nu^{\frac{1}{3}} + 0.94000 \, 7\nu^{-\frac{1}{3}} - 0.05808\nu^{-1} - 0.0540\nu^{-\frac{5}{3}} + \dots, \\ J_\nu(j'_{\nu,1}) &\sim 0.67488 \, 51\nu^{-\frac{1}{3}}(1 - 0.16172 \, 3\nu^{-\frac{2}{3}} + 0.02918\nu^{-\frac{4}{3}} - 0.0068\nu^{-2} + \dots), \\ Y_\nu(y'_{\nu,1}) &\sim 0.57319 \, 40\nu^{-\frac{1}{3}}(1 - 0.36422 \, 0\nu^{-\frac{2}{3}} + 0.09077\nu^{-\frac{4}{3}} + 0.0237\nu^{-2} + \dots). \end{aligned}$$

For numerical coefficients for  $m = 2, 3, 4, 5$  see Olver (1951, Tables 3–6).

The expansions (10.21.32)–(10.21.39) become progressively weaker as  $m$  increases. The approximations that follow in §10.21(viii) do not suffer from this drawback.

### 10.21(viii) Uniform Asymptotic Approximations for Large Order

As  $\nu \rightarrow \infty$  the following four approximations hold uniformly for  $m = 1, 2, \dots$ :

$$10.21.41 \quad j_{\nu,m} = \nu z(\zeta) + \frac{z(\zeta)(h(\zeta))^2 B_0(\zeta)}{2\nu} + O\left(\frac{1}{\nu^3}\right),$$

$$\zeta = \nu^{-\frac{2}{3}} a_m,$$

**10.21.42**

$$J'_\nu(j_{\nu,m}) = -\frac{2}{\nu^{\frac{2}{3}}} \frac{\text{Ai}'(a_m)}{z(\zeta)h(\zeta)} \left(1 + O\left(\frac{1}{\nu^2}\right)\right), \quad \zeta = \nu^{-\frac{2}{3}} a_m,$$

**10.21.43**

$$j'_{\nu,m} = \nu z(\zeta) + \frac{z(\zeta)(h(\zeta))^2 C_0(\zeta)}{2\zeta\nu} + O\left(\frac{1}{\nu}\right), \quad \zeta = \nu^{-\frac{2}{3}} a'_m,$$

**10.21.44**

$$J_\nu(j'_{\nu,m}) = \frac{h(\zeta) \text{Ai}(a'_m)}{\nu^{\frac{1}{3}}} \left(1 + O\left(\frac{1}{\nu^{\frac{4}{3}}}\right)\right), \quad \zeta = \nu^{-\frac{2}{3}} a'_m.$$

Here  $a_m$  and  $a'_m$  denote respectively the zeros of the Airy function  $\text{Ai}(z)$  and its derivative  $\text{Ai}'(z)$ ; see §9.9. Next,  $z(\zeta)$  is the inverse of the function  $\zeta = \zeta(z)$  defined by (10.20.3).  $B_0(\zeta)$  and  $C_0(\zeta)$  are defined by (10.20.11) and (10.20.12) with  $k = 0$ . Lastly,

**10.21.45** 
$$h(\zeta) = (4\zeta/(1 - z^2))^{\frac{1}{4}}.$$

(Note: If the term  $z(\zeta)(h(\zeta))^2 C_0(\zeta)/(2\zeta\nu)$  in (10.21.43) is omitted, then the uniform character of the error term  $O(1/\nu)$  is destroyed.)

Corresponding uniform approximations for  $y_{\nu,m}$ ,  $Y'_\nu(y_{\nu,m})$ ,  $y'_{\nu,m}$ , and  $Y_\nu(y'_{\nu,m})$ , are obtained from (10.21.41)–(10.21.44) by changing the symbols  $j$ ,  $J$ ,  $\text{Ai}$ ,  $\text{Ai}'$ ,  $a_m$ , and  $a'_m$  to  $y$ ,  $Y$ ,  $-\text{Bi}$ ,  $-\text{Bi}'$ ,  $b_m$ , and  $b'_m$ , respectively.

For derivations and further information, including extensions to uniform asymptotic expansions, see Olver (1954, 1960). The latter reference includes numerical tables of the first few coefficients in the uniform asymptotic expansions.

**10.21(ix) Complex Zeros**

This subsection describes the distribution in  $\mathbb{C}$  of the zeros of the principal branches of the Bessel functions of the second and third kinds, and their derivatives, in the case when the order is a positive integer  $n$ . For further information, including uniform asymptotic expansions, extensions to other branches of the functions and their derivatives, and extensions to half-integer values of the order, see Olver (1954). (There is an inaccuracy in Figures 11 and 14 in this reference. Each curve that represents an infinite string of nonreal zeros should be located on the opposite side of its straight line asymptote. This inaccuracy was repeated in Abramowitz and Stegun (1964, Figures 9.5 and 9.6). See Kerimov and Skorokhodov (1985a,b) and Figures 10.21.3–10.21.6.)

See also Cruz and Sesma (1982); Cruz *et al.* (1991), Kerimov and Skorokhodov (1984c, 1987, 1988), Kokologianaki *et al.* (1992), and references supplied in §10.75(iii).

**Zeros of  $Y_n(nz)$  and  $Y'_n(nz)$**

In Figures 10.21.1, 10.21.3, and 10.21.5 the two continuous curves that join the points  $\pm 1$  are the boundaries

of  $\mathbf{K}$ , that is, the eye-shaped domain depicted in Figure 10.20.3. These curves therefore intersect the imaginary axis at the points  $z = \pm ic$ , where  $c = 0.66274 \dots$

The first set of zeros of the principal value of  $Y_n(nz)$  are the points  $z = y_{n,m}/n$ ,  $m = 1, 2, \dots$ , on the positive real axis (§10.21(i)). Secondly, there is a conjugate pair of infinite strings of zeros with asymptotes  $\Im z = \pm ia/n$ , where

**10.21.46** 
$$a = \frac{1}{2} \ln 3 = 0.54931 \dots$$

Lastly, there are two conjugate sets, with  $n$  zeros in each set, that are asymptotically close to the boundary of  $\mathbf{K}$  as  $n \rightarrow \infty$ . Figures 10.21.1, 10.21.3, and 10.21.5 plot the actual zeros for  $n = 1, 5$ , and 10, respectively.

The zeros of  $Y'_n(nz)$  have a similar pattern to those of  $Y_n(nz)$ .

**Zeros of  $H_n^{(1)}(nz)$ ,  $H_n^{(2)}(nz)$ ,  $H_n^{(1)'}(nz)$ ,  $H_n^{(2)'}(nz)$**

In Figures 10.21.2, 10.21.4, and 10.21.6 the continuous curve that joins the points  $\pm 1$  is the lower boundary of  $\mathbf{K}$ .

The first set of zeros of the principal value of  $H_n^{(1)}(nz)$  is an infinite string with asymptote  $\Im z = -id/n$ , where

**10.21.47** 
$$d = \frac{1}{2} \ln 2 = 0.34657 \dots$$

The only other set comprises  $n$  zeros that are asymptotically close to the lower boundary of  $\mathbf{K}$  as  $n \rightarrow \infty$ . Figures 10.21.2, 10.21.4, and 10.21.6 plot the actual zeros for  $n = 1, 5$ , and 10, respectively.

The zeros of  $H_n^{(1)'}(nz)$  have a similar pattern to those of  $H_n^{(1)}(nz)$ . The zeros of  $H_n^{(2)}(nz)$  and  $H_n^{(2)'}(nz)$  are the complex conjugates of the zeros of  $H_n^{(1)}(nz)$  and  $H_n^{(1)'}(nz)$ , respectively.

**Zeros of  $J_0(z) - iJ_1(z)$  and  $J_n(z) - iJ_{n+1}(z)$**

For information see Synolakis (1988), MacDonald (1989, 1997), and Ikebe *et al.* (1993).

**10.21(x) Cross-Products**

Throughout this subsection we assume  $\nu \geq 0$ ,  $x > 0$ ,  $\lambda > 1$ , and we denote  $4\nu^2$  by  $\mu$ .

The zeros of the functions

**10.21.48** 
$$J_\nu(x) Y_\nu(\lambda x) - Y_\nu(x) J_\nu(\lambda x)$$

and

**10.21.49** 
$$J'_\nu(x) Y'_\nu(\lambda x) - Y'_\nu(x) J'_\nu(\lambda x)$$

are simple and the asymptotic expansion of the  $m$ th positive zero as  $m \rightarrow \infty$  is given by

**10.21.50** 
$$\alpha + \frac{p}{\alpha} + \frac{q - p^2}{\alpha^3} + \frac{r - 4pq + 2p^3}{\alpha^5} + \dots,$$

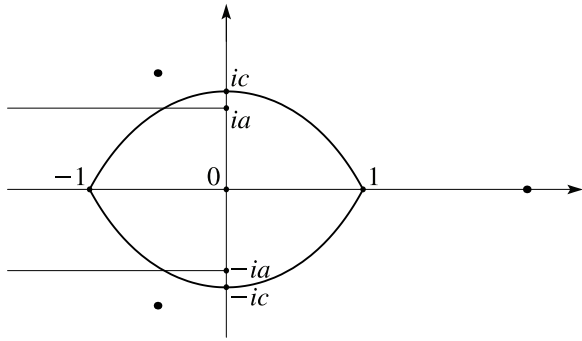


Figure 10.21.1: Zeros  $\bullet\bullet\bullet$  of  $Y_n(nz)$  in  $|\text{ph } z| \leq \pi$ . Case  $n = 1$ ,  $-1.6 \leq \Re z \leq 2.6$ .

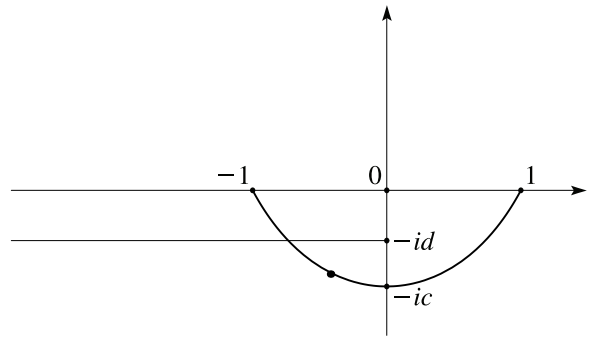


Figure 10.21.2: Zeros  $\bullet\bullet\bullet$  of  $H_n^{(1)}(nz)$  in  $|\text{ph } z| \leq \pi$ . Case  $n = 1$ ,  $-2.8 \leq \Re z \leq 1.4$ .

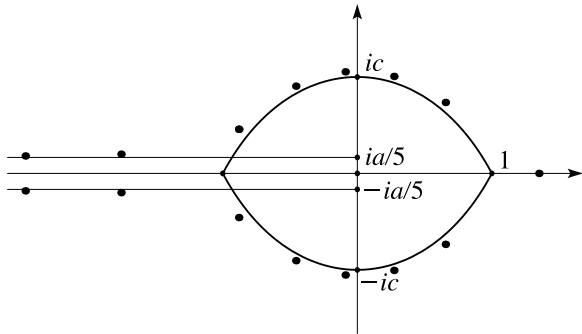


Figure 10.21.3: Zeros  $\bullet\bullet\bullet$  of  $Y_n(nz)$  in  $|\text{ph } z| \leq \pi$ . Case  $n = 5$ ,  $-2.6 \leq \Re z \leq 1.6$ .

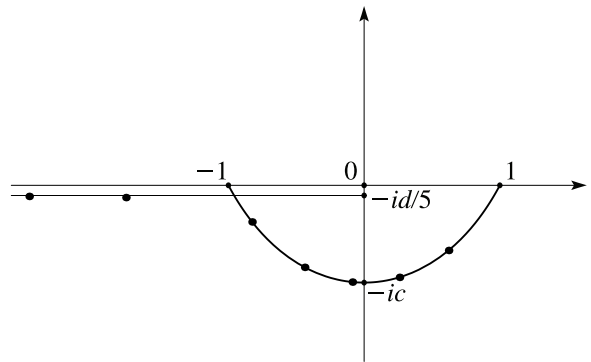


Figure 10.21.4: Zeros  $\bullet\bullet\bullet$  of  $H_n^{(1)}(nz)$  in  $|\text{ph } z| \leq \pi$ . Case  $n = 5$ ,  $-2.6 \leq \Re z \leq 1.6$ .

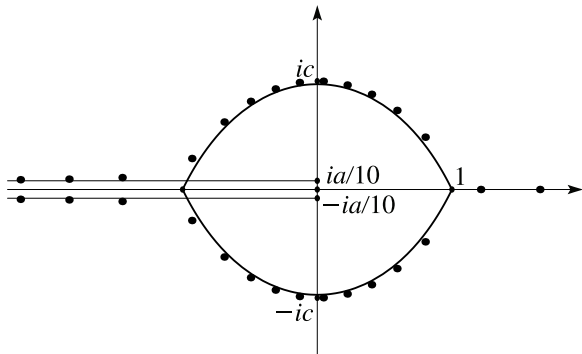


Figure 10.21.5: Zeros  $\bullet\bullet\bullet$  of  $Y_n(nz)$  in  $|\text{ph } z| \leq \pi$ . Case  $n = 10$ ,  $-2.3 \leq \Re z \leq 1.9$ .

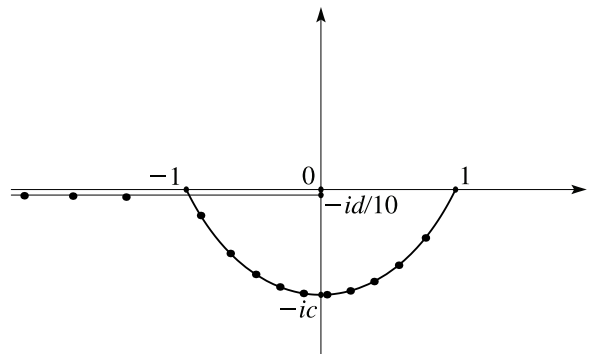


Figure 10.21.6: Zeros  $\bullet\bullet\bullet$  of  $H_n^{(1)}(nz)$  in  $|\text{ph } z| \leq \pi$ . Case  $n = 10$ ,  $-2.3 \leq \Re z \leq 1.9$ .



where, in the case of (10.21.48),

### 10.21.51

$$\alpha = \frac{m\pi}{\lambda - 1}, \quad p = \frac{\mu - 1}{8\lambda}, \quad q = \frac{(\mu - 1)(\mu - 25)(\lambda^3 - 1)}{6(4\lambda)^3(\lambda - 1)},$$

$$r = \frac{(\mu - 1)(\mu^2 - 114\mu + 1073)(\lambda^5 - 1)}{5(4\lambda)^5(\lambda - 1)},$$

### 10.21.54

$$\alpha = \frac{(m - \frac{1}{2})\pi}{\lambda - 1}, \quad p = \frac{(\mu + 3)\lambda - (\mu - 1)}{8\lambda(\lambda - 1)}, \quad q = \frac{(\mu^2 + 46\mu - 63)\lambda^3 - (\mu - 1)(\mu - 25)}{6(4\lambda)^3(\lambda - 1)},$$

$$r = \frac{(\mu^3 + 185\mu^2 - 2053\mu + 1899)\lambda^5 - (\mu - 1)(\mu^2 - 114\mu + 1073)}{5(4\lambda)^5(\lambda - 1)}.$$

Higher coefficients in the asymptotic expansions in this subsection can be obtained by expressing the cross-products in terms of the modulus and phase functions (§10.18), and then reverting the asymptotic expansion for the difference of the phase functions.

For further information see Cochran (1963, 1964, 1966a,b), Kalähne (1907), Martinek *et al.* (1966), Muldoon (1979), and Salchev and Popov (1976).

### 10.21(xi) Riccati–Bessel Functions

The Riccati–Bessel functions are  $(\frac{1}{2}\pi x)^{\frac{1}{2}} J_\nu(x)$  and  $(\frac{1}{2}\pi x)^{\frac{1}{2}} Y_\nu(x)$ . Except possibly for  $x = 0$  their zeros are the same as those of  $J_\nu(x)$  and  $Y_\nu(x)$ , respectively. For information on the zeros of the derivatives of Riccati–Bessel functions, and also on zeros of their cross-products, see Boyer (1969). This information includes asymptotic approximations analogous to those given in §§10.21(vi), 10.21(vii), and 10.21(x).

and, in the case of (10.21.49),

$$\alpha = \frac{(m - 1)\pi}{\lambda - 1}, \quad p = \frac{\mu + 3}{8\lambda},$$

$$10.21.52 \quad q = \frac{(\mu^2 + 46\mu - 63)(\lambda^3 - 1)}{6(4\lambda)^3(\lambda - 1)},$$

$$r = \frac{(\mu^3 + 185\mu^2 - 2053\mu + 1899)(\lambda^5 - 1)}{5(4\lambda)^5(\lambda - 1)}.$$

The asymptotic expansion of the large positive zeros (not necessarily the  $m$ th) of the function

$$10.21.53 \quad J'_\nu(x) Y_\nu(\lambda x) - Y'_\nu(x) J_\nu(\lambda x)$$

is given by (10.21.50), where

### 10.21(xii) Zeros of $\alpha J_\nu(x) + x J'_\nu(x)$

For properties of the positive zeros of the function  $\alpha J_\nu(x) + x J'_\nu(x)$ , with  $\alpha$  and  $\nu$  real, see Landau (1999).

### 10.21(xiii) Rayleigh Function

The *Rayleigh function*  $\sigma_n(\nu)$  is defined by

$$10.21.55 \quad \sigma_n(\nu) = \sum_{m=1}^{\infty} (j_{\nu,m})^{-2n}, \quad n = 1, 2, 3, \dots$$

For properties, computation, and generalizations see Kapitsa (1951a), Kerimov (1999), and Gupta and Muldoon (2000). See also Watson (1944, §§15.5, 15.51).

### 10.21(xiv) $\nu$ -Zeros

For information on zeros of Bessel and Hankel functions as functions of the order, see Cochran (1965), Cochran and Hoffspiegel (1970), Hethcote (1970), and Conde and Kalla (1979).

## 10.22 Integrals

### 10.22(i) Indefinite Integrals

In this subsection  $\mathcal{C}_\nu(z)$  and  $\mathcal{D}_\mu(z)$  denote cylinder functions (§10.2(ii)) of orders  $\nu$  and  $\mu$ , respectively, not necessarily distinct.

$$10.22.1 \quad \int z^{\nu+1} \mathcal{C}_\nu(z) dz = z^{\nu+1} \mathcal{C}_{\nu+1}(z), \quad \int z^{-\nu+1} \mathcal{C}_\nu(z) dz = -z^{-\nu+1} \mathcal{C}_{\nu-1}(z).$$

$$10.22.2 \quad \int z^\nu \mathcal{C}_\nu(z) dz = \pi^{\frac{1}{2}} 2^{\nu-1} \Gamma(\nu + \frac{1}{2}) z (\mathcal{C}_\nu(z) \mathbf{H}_{\nu-1}(z) - \mathcal{C}_{\nu-1}(z) \mathbf{H}_\nu(z)), \quad \nu \neq -\frac{1}{2}.$$

For the Struve function  $\mathbf{H}_\nu(z)$  see §11.2(i).

$$\begin{aligned}
 10.22.3 \quad \int e^{iz} z^\nu \mathcal{C}_\nu(z) dz &= \frac{e^{iz} z^{\nu+1}}{2\nu+1} (\mathcal{C}_\nu(z) - i \mathcal{C}_{\nu+1}(z)), & \nu \neq -\frac{1}{2}, \\
 \int e^{iz} z^{-\nu} \mathcal{C}_\nu(z) dz &= \frac{e^{iz} z^{-\nu+1}}{1-2\nu} (\mathcal{C}_\nu(z) + i \mathcal{C}_{\nu-1}(z)), & \nu \neq \frac{1}{2}.
 \end{aligned}$$

**Products**

$$10.22.4 \quad \int z \mathcal{C}_\mu(az) \mathcal{D}_\mu(bz) dz = \frac{z(a \mathcal{C}_{\mu+1}(az) \mathcal{D}_\mu(bz) - b \mathcal{C}_\mu(az) \mathcal{D}_{\mu+1}(bz))}{a^2 - b^2}, \quad a^2 \neq b^2,$$

$$10.22.5 \quad \int z \mathcal{C}_\mu(az) \mathcal{D}_\mu(az) dz = \frac{1}{4} z^2 (2 \mathcal{C}_\mu(az) \mathcal{D}_\mu(az) - \mathcal{C}_{\mu-1}(az) \mathcal{D}_{\mu+1}(az) - \mathcal{C}_{\mu+1}(az) \mathcal{D}_{\mu-1}(az)),$$

$$10.22.6 \quad \int \mathcal{C}_\mu(az) \mathcal{D}_\nu(az) \frac{dz}{z} = -\frac{az(\mathcal{C}_{\mu+1}(az) \mathcal{D}_\nu(az) - \mathcal{C}_\mu(az) \mathcal{D}_{\nu+1}(az))}{\mu^2 - \nu^2} + \frac{\mathcal{C}_\mu(az) \mathcal{D}_\nu(az)}{\mu + \nu}, \quad \mu^2 \neq \nu^2,$$

$$10.22.7 \quad \int z^{\mu+\nu+1} \mathcal{C}_\mu(az) \mathcal{D}_\nu(az) dz = \frac{z^{\mu+\nu+2}}{2(\mu + \nu + 1)} (\mathcal{C}_\mu(az) \mathcal{D}_\nu(az) + \mathcal{C}_{\mu+1}(az) \mathcal{D}_{\nu+1}(az)), \quad \mu + \nu \neq -1,$$

$$\int z^{-\mu-\nu+1} \mathcal{C}_\mu(az) \mathcal{D}_\nu(az) dz = \frac{z^{-\mu-\nu+2}}{2(1 - \mu - \nu)} (\mathcal{C}_\mu(az) \mathcal{D}_\nu(az) + \mathcal{C}_{\mu-1}(az) \mathcal{D}_{\nu-1}(az)), \quad \mu + \nu \neq 1.$$

**10.22(ii) Integrals over Finite Intervals**

Throughout this subsection  $x > 0$ .

$$10.22.8 \quad \int_0^x J_\nu(t) dt = 2 \sum_{k=0}^{\infty} J_{\nu+2k+1}(x), \quad \Re \nu > -1.$$

$$10.22.9 \quad \int_0^x J_{2n}(t) dt = \int_0^x J_0(t) dt - 2 \sum_{k=0}^{n-1} J_{2k+1}(x), \quad \int_0^x J_{2n+1}(t) dt = 1 - J_0(x) - 2 \sum_{k=1}^n J_{2k}(x), \quad n = 0, 1, \dots$$

$$10.22.10 \quad \int_0^x t^\mu J_\nu(t) dt = x^\mu \frac{\Gamma(\frac{1}{2}\nu + \frac{1}{2}\mu + \frac{1}{2})}{\Gamma(\frac{1}{2}\nu - \frac{1}{2}\mu + \frac{1}{2})} \sum_{k=0}^{\infty} \frac{(\nu + 2k + 1) \Gamma(\frac{1}{2}\nu - \frac{1}{2}\mu + \frac{1}{2} + k)}{\Gamma(\frac{1}{2}\nu + \frac{1}{2}\mu + \frac{3}{2} + k)} J_{\nu+2k+1}(x), \quad \Re(\mu + \nu + 1) > 0.$$

$$10.22.11 \quad \int_0^x \frac{1 - J_0(t)}{t} dt = \frac{1}{2} \sum_{k=1}^{\infty} \frac{\psi(k+1) - \psi(1)}{k!} (\frac{1}{2}x)^k J_k(x),$$

$$\begin{aligned}
 10.22.12 \quad x \int_0^x \frac{1 - J_0(t)}{t} dt &= 2 \sum_{k=0}^{\infty} (2k + 3)(\psi(k + 2) - \psi(1)) J_{2k+3}(x) \\
 &= x - 2J_1(x) + 2 \sum_{k=0}^{\infty} (2k + 5)(\psi(k + 3) - \psi(1) - 1) J_{2k+5}(x),
 \end{aligned}$$

where  $\psi(x) = \Gamma'(x)/\Gamma(x)$  (§5.2(i)). See also (10.22.39).

**Trigonometric Arguments**

$$10.22.13 \quad \int_0^{\frac{1}{2}\pi} J_{2\nu}(2z \cos \theta) \cos(2\mu\theta) d\theta = \frac{1}{2}\pi J_{\nu+\mu}(z) J_{\nu-\mu}(z), \quad \Re \nu > -\frac{1}{2},$$

$$10.22.14 \quad \int_0^{\pi} J_{2\nu}(2z \sin \theta) \cos(2\mu\theta) d\theta = \pi \cos(\mu\pi) J_{\nu+\mu}(z) J_{\nu-\mu}(z), \quad \Re \nu > -\frac{1}{2},$$

$$10.22.15 \quad \int_0^{\pi} J_{2\nu}(2z \sin \theta) \sin(2\mu\theta) d\theta = \pi \sin(\mu\pi) J_{\nu+\mu}(z) J_{\nu-\mu}(z), \quad \Re \nu > -1.$$

$$10.22.16 \quad \int_0^{\frac{1}{2}\pi} J_0(2z \sin \theta) \cos(2n\theta) d\theta = \frac{1}{2}\pi J_n^2(z), \quad n = 0, 1, 2, \dots$$

10.22.17

$$\int_0^{\frac{1}{2}\pi} Y_{2\nu}(2z \cos \theta) \cos(2\mu\theta) d\theta = \frac{1}{2}\pi \cot(2\nu\pi) J_{\nu+\mu}(z) J_{\nu-\mu}(z) - \frac{1}{2}\pi \csc(2\nu\pi) J_{\mu-\nu}(z) J_{-\mu-\nu}(z), \quad -\frac{1}{2} < \Re\nu < \frac{1}{2},$$

10.22.18

$$\int_0^{\frac{1}{2}\pi} Y_0(2z \sin \theta) \cos(2n\theta) d\theta = \frac{1}{2}\pi J_n(z) Y_n(z), \quad n = 0, 1, 2, \dots$$

10.22.19

$$\int_0^{\frac{1}{2}\pi} J_\mu(z \sin \theta) (\sin \theta)^{\mu+1} (\cos \theta)^{2\nu+1} d\theta = 2^\nu \Gamma(\nu+1) z^{-\nu-1} J_{\mu+\nu+1}(z), \quad \Re\mu > -1, \Re\nu > -1,$$

10.22.20

$$\int_0^{\frac{1}{2}\pi} J_\mu(z \sin \theta) (\sin \theta)^\mu (\cos \theta)^{2\mu} d\theta = \pi^{\frac{1}{2}} 2^{\mu-1} z^{-\mu} \Gamma(\mu + \frac{1}{2}) J_\mu^2(\frac{1}{2}z), \quad \Re\mu > -\frac{1}{2},$$

10.22.21

$$\int_0^{\frac{1}{2}\pi} Y_\mu(z \sin \theta) (\sin \theta)^\mu (\cos \theta)^{2\mu} d\theta = \pi^{\frac{1}{2}} 2^{\mu-1} z^{-\mu} \Gamma(\mu + \frac{1}{2}) J_\mu(\frac{1}{2}z) Y_\mu(\frac{1}{2}z), \quad \Re\mu > -\frac{1}{2}.$$

10.22.22

$$\int_0^{\frac{1}{2}\pi} J_\mu(z \sin^2 \theta) J_\nu(z \cos^2 \theta) (\sin \theta)^{2\mu+1} (\cos \theta)^{2\nu+1} d\theta = \frac{\Gamma(\mu + \frac{1}{2}) \Gamma(\nu + \frac{1}{2}) J_{\mu+\nu+\frac{1}{2}}(z)}{(8\pi z)^{\frac{1}{2}} \Gamma(\mu + \nu + 1)}, \quad \Re\mu > -\frac{1}{2}, \Re\nu > -\frac{1}{2}.$$

10.22.23

$$\int_0^{\frac{1}{2}\pi} J_\mu(z \sin^2 \theta) J_\nu(z \cos^2 \theta) (\sin \theta)^{2\alpha-1} \sec \theta d\theta = \frac{(\mu + \nu + \alpha) \Gamma(\mu + \alpha) 2^{\alpha-1}}{\nu \Gamma(\mu + 1) z^\alpha} J_{\mu+\nu+\alpha}(z),$$

$\Re(\mu + \alpha) > 0, \Re\nu > 0.$

10.22.24

$$\int_0^{\frac{1}{2}\pi} J_\mu(z \sin^2 \theta) J_\nu(z \cos^2 \theta) \cot \theta d\theta = \frac{1}{2}\mu^{-1} J_{\mu+\nu}(z), \quad \Re\mu > 0, \Re\nu > -1.$$

10.22.25

$$\int_0^{\frac{1}{2}\pi} J_\mu(z \sin \theta) I_\nu(z \cos \theta) (\tan \theta)^{\mu+1} d\theta = \frac{\Gamma(\frac{1}{2}\nu - \frac{1}{2}\mu) (\frac{1}{2}z)^\mu}{2\Gamma(\frac{1}{2}\nu + \frac{1}{2}\mu + 1)} J_\nu(z), \quad \Re\nu > \Re\mu > -1.$$

For  $I_\nu$  see §10.25(ii).

10.22.26

$$\int_0^{\frac{1}{2}\pi} J_\mu(z \sin \theta) J_\nu(\zeta \cos \theta) (\sin \theta)^{\mu+1} (\cos \theta)^{\nu+1} d\theta = \frac{z^\mu \zeta^\nu J_{\mu+\nu+1}(\sqrt{\zeta^2 + z^2})}{(\zeta^2 + z^2)^{\frac{1}{2}(\mu+\nu+1)}}, \quad \Re\mu > -1, \Re\nu > -1.$$

**Products**

10.22.27

$$\int_0^x t J_{\nu-1}^2(t) dt = 2 \sum_{k=0}^{\infty} (\nu + 2k) J_{\nu+2k}^2(x), \quad \Re\nu > 0,$$

10.22.28

$$\int_0^x t (J_{\nu-1}^2(t) - J_{\nu+1}^2(t)) dt = 2\nu J_\nu^2(x), \quad \Re\nu > 0,$$

10.22.29

$$\int_0^x t J_0^2(t) dt = \frac{1}{2}x^2 (J_0^2(x) + J_1^2(x)).$$

10.22.30

$$\int_0^x J_n(t) J_{n+1}(t) dt = \frac{1}{2} (1 - J_0^2(x)) - \sum_{k=1}^n J_k^2(x) = \sum_{k=n+1}^{\infty} J_k^2(x), \quad n = 0, 1, 2, \dots$$

**Convolutions**

10.22.31

$$\int_0^x J_\mu(t) J_\nu(x-t) dt = 2 \sum_{k=0}^{\infty} (-1)^k J_{\mu+\nu+2k+1}(x), \quad \Re\mu > -1, \Re\nu > -1.$$

10.22.32

$$\int_0^x J_\nu(t) J_{1-\nu}(x-t) dt = J_0(x) - \cos x, \quad -1 < \Re\nu < 2.$$

10.22.33

$$\int_0^x J_\nu(t) J_{-\nu}(x-t) dt = \sin x, \quad |\Re\nu| < 1.$$

10.22.34

$$\int_0^x t^{-1} J_\mu(t) J_\nu(x-t) dt = \frac{J_{\mu+\nu}(x)}{\mu}, \quad \Re\mu > 0, \Re\nu > -1.$$

$$10.22.35 \quad \int_0^x \frac{J_\mu(t) J_\nu(x-t) dt}{t(x-t)} = \frac{(\mu + \nu) J_{\mu+\nu}(x)}{\mu\nu x}, \quad \Re\mu > 0, \Re\nu > 0.$$

**Fractional Integral**

$$10.22.36 \quad \frac{1}{\Gamma(\alpha)} \int_0^x (x-t)^{\alpha-1} J_\nu(t) dt = 2^\alpha \sum_{k=0}^{\infty} \frac{(\alpha)_k}{k!} J_{\nu+\alpha+2k}(x), \quad \Re\alpha > 0, \Re\nu \geq 0.$$

When  $\alpha = m = 1, 2, 3, \dots$  the left-hand side of (10.22.36) is the  $m$ th repeated integral of  $J_\nu(x)$  (§§1.4(v) and 1.15(vi)).

**Orthogonality**

If  $\nu > -1$ , then

$$10.22.37 \quad \int_0^1 t J_\nu(j_{\nu,\ell}t) J_\nu(j_{\nu,m}t) dt = \frac{1}{2} \delta_{\ell,m} (J'_\nu(j_{\nu,\ell}))^2,$$

where  $j_{\nu,\ell}$  and  $j_{\nu,m}$  are zeros of  $J_\nu(x)$  (§10.21(i)), and  $\delta_{\ell,m}$  is Kronecker's symbol.

Also, if  $a, b, \nu$  are real constants with  $b \neq 0$  and  $\nu > -1$ , then

$$10.22.38 \quad \int_0^1 t J_\nu(\alpha_\ell t) J_\nu(\alpha_m t) dt = \delta_{\ell,m} \left( \frac{a^2}{b^2} + \alpha_\ell^2 - \nu^2 \right) \frac{(J_\nu(\alpha_\ell))^2}{2\alpha_\ell^2},$$

where  $\alpha_\ell$  and  $\alpha_m$  are positive zeros of  $a J_\nu(x) + bx J'_\nu(x)$ . (Compare (10.22.55)).

**10.22(iii) Integrals over the Interval  $(x, \infty)$** 

When  $x > 0$

$$10.22.39 \quad \int_x^\infty \frac{J_0(t)}{t} dt + \gamma + \ln\left(\frac{1}{2}x\right) = \int_0^x \frac{1 - J_0(t)}{t} dt = \sum_{k=1}^{\infty} (-1)^{k-1} \frac{(\frac{1}{2}x)^{2k}}{2k(k!)^2},$$

$$10.22.40 \quad \int_x^\infty \frac{Y_0(t)}{t} dt = -\frac{1}{\pi} (\ln(\frac{1}{2}x) + \gamma)^2 + \frac{\pi}{6} + \frac{2}{\pi} \sum_{k=1}^{\infty} (-1)^k \left( \psi(k+1) + \frac{1}{2k} - \ln(\frac{1}{2}x) \right) \frac{(\frac{1}{2}x)^{2k}}{2k(k!)^2},$$

where  $\gamma$  is Euler's constant (§5.2(ii)).

**10.22(iv) Integrals over the Interval  $(0, \infty)$** 

$$10.22.41 \quad \int_0^\infty J_\nu(t) dt = 1, \quad \Re\nu > -1,$$

$$10.22.42 \quad \int_0^\infty Y_\nu(t) dt = -\tan\left(\frac{1}{2}\nu\pi\right), \quad |\Re\nu| < 1.$$

$$10.22.43 \quad \int_0^\infty t^\mu J_\nu(t) dt = 2^\mu \frac{\Gamma(\frac{1}{2}\nu + \frac{1}{2}\mu + \frac{1}{2})}{\Gamma(\frac{1}{2}\nu - \frac{1}{2}\mu + \frac{1}{2})}, \quad \Re(\mu + \nu) > -1, \Re\mu < \frac{1}{2},$$

$$10.22.44 \quad \int_0^\infty t^\mu Y_\nu(t) dt = \frac{2^\mu}{\pi} \Gamma\left(\frac{1}{2}\mu + \frac{1}{2}\nu + \frac{1}{2}\right) \Gamma\left(\frac{1}{2}\mu - \frac{1}{2}\nu + \frac{1}{2}\right) \sin\left(\frac{1}{2}\mu - \frac{1}{2}\nu\right)\pi, \quad \Re(\mu \pm \nu) > -1, \Re\mu < \frac{1}{2}.$$

$$10.22.45 \quad \int_0^\infty \frac{1 - J_0(t)}{t^\mu} dt = -\frac{\pi \sec(\frac{1}{2}\mu\pi)}{2^\mu \Gamma^2(\frac{1}{2}\mu + \frac{1}{2})}, \quad 1 < \Re\mu < 3.$$

$$10.22.46 \quad \int_0^\infty \frac{t^{\nu+1} J_\nu(at)}{(t^2 + b^2)^{\mu+1}} dt = \frac{a^\mu b^{\nu-\mu}}{2^\mu \Gamma(\mu+1)} K_{\nu-\mu}(ab), \quad a > 0, \Re b > 0, -1 < \Re\nu < 2\Re\mu + \frac{3}{2}.$$

$$10.22.47 \quad \int_0^\infty \frac{t^\nu Y_\nu(at)}{t^2 + b^2} dt = -b^{\nu-1} K_\nu(ab), \quad a > 0, \Re b > 0, -\frac{1}{2} < \Re\nu < \frac{5}{2}.$$

For  $K_\nu$  see §10.25(ii).

$$10.22.48 \quad \int_0^\infty J_\mu(x \cosh \phi) (\cosh \phi)^{1-\mu} (\sinh \phi)^{2\nu+1} d\phi = 2^\nu \Gamma(\nu+1) x^{-\nu-1} J_{\mu-\nu-1}(x), \quad x > 0, \Re\nu > -1, \Re\mu > 2\Re\nu + \frac{1}{2}.$$

$$\begin{aligned}
10.22.49 \quad \int_0^\infty t^{\mu-1} e^{-at} J_\nu(bt) dt &= \frac{(\frac{1}{2}b)^\nu}{a^{\mu+\nu}} \Gamma(\mu+\nu) \mathbf{F}\left(\frac{\mu+\nu}{2}, \frac{\mu+\nu+1}{2}; \nu+1; -\frac{b^2}{a^2}\right), \quad \Re(\mu+\nu) > 0, \Re(a \pm ib) > 0, \\
10.22.50 \quad \int_0^\infty t^{\mu-1} e^{-at} Y_\nu(bt) dt &= \cot(\nu\pi) \frac{(\frac{1}{2}b)^\nu \Gamma(\mu+\nu)}{(a^2+b^2)^{\frac{1}{2}(\mu+\nu)}} \mathbf{F}\left(\frac{\mu+\nu}{2}, \frac{1-\mu+\nu}{2}; \nu+1; \frac{b^2}{a^2+b^2}\right) \\
&\quad - \csc(\nu\pi) \frac{(\frac{1}{2}b)^{-\nu} \Gamma(\mu-\nu)}{(a^2+b^2)^{\frac{1}{2}(\mu-\nu)}} \mathbf{F}\left(\frac{\mu-\nu}{2}, \frac{1-\mu-\nu}{2}; 1-\nu; \frac{b^2}{a^2+b^2}\right), \\
&\quad \Re\mu > |\Re\nu|, \Re(a \pm ib) > 0.
\end{aligned}$$

For the hypergeometric function  $\mathbf{F}$  see §15.2(i).

$$\begin{aligned}
10.22.51 \quad \int_0^\infty J_\nu(bt) \exp(-p^2 t^2) t^{\nu+1} dt &= \frac{b^\nu}{(2p^2)^{\nu+1}} \exp\left(-\frac{b^2}{4p^2}\right), \quad \Re\nu > -1, \Re(p^2) > 0, \\
10.22.52 \quad \int_0^\infty J_\nu(bt) \exp(-p^2 t^2) dt &= \frac{\sqrt{\pi}}{2p} \exp\left(-\frac{b^2}{8p^2}\right) I_{\nu/2}\left(\frac{b^2}{8p^2}\right), \quad \Re\nu > -1, \Re(p^2) > 0, \\
10.22.53 \quad \int_0^\infty Y_{2\nu}(bt) \exp(-p^2 t^2) dt &= -\frac{\sqrt{\pi}}{2p} \exp\left(-\frac{b^2}{8p^2}\right) \left( I_\nu\left(\frac{b^2}{8p^2}\right) \tan(\nu\pi) + \frac{1}{\pi} K_\nu\left(\frac{b^2}{8p^2}\right) \sec(\nu\pi) \right), \quad |\Re\nu| < \frac{1}{2}, \Re(p^2) > 0.
\end{aligned}$$

For  $I$  and  $K$  see §10.25(ii).

$$\begin{aligned}
10.22.54 \quad \int_0^\infty J_\nu(bt) \exp(-p^2 t^2) t^{\mu-1} dt &= \frac{(\frac{1}{2}b/p)^\nu \Gamma(\frac{1}{2}\nu + \frac{1}{2}\mu)}{2p^\mu} \exp\left(-\frac{b^2}{4p^2}\right) \mathbf{M}\left(\frac{1}{2}\nu - \frac{1}{2}\mu + 1, \nu + 1, \frac{b^2}{4p^2}\right), \\
&\quad \Re(\mu+\nu) > 0, \Re(p^2) > 0.
\end{aligned}$$

For the confluent hypergeometric function  $\mathbf{M}$  see §13.2(i).

### Orthogonality

$$10.22.55 \quad \int_0^\infty t^{-1} J_{\nu+2\ell+1}(t) J_{\nu+2m+1}(t) dt = \frac{\delta_{\ell,m}}{2(2\ell+\nu+1)}, \quad \nu + \ell + m > -1.$$

### Weber–Schafheitlin Discontinuous Integrals, including Special Cases

$$\begin{aligned}
10.22.56 \quad \int_0^\infty \frac{J_\mu(at) J_\nu(bt)}{t^\lambda} dt &= \frac{a^\mu \Gamma(\frac{1}{2}\nu + \frac{1}{2}\mu - \frac{1}{2}\lambda + \frac{1}{2})}{2^\lambda b^{\mu-\lambda+1} \Gamma(\frac{1}{2}\nu - \frac{1}{2}\mu + \frac{1}{2}\lambda + \frac{1}{2})} \mathbf{F}\left(\frac{1}{2}(\mu+\nu-\lambda+1), \frac{1}{2}(\mu-\nu-\lambda+1); \mu+1; \frac{a^2}{b^2}\right), \\
&\quad 0 < a < b, \Re(\mu+\nu+1) > \Re\lambda > -1.
\end{aligned}$$

If  $0 < b < a$ , then interchange  $a$  and  $b$ , and also  $\mu$  and  $\nu$ . If  $b = a$ , then

$$\begin{aligned}
10.22.57 \quad \int_0^\infty \frac{J_\mu(at) J_\nu(at)}{t^\lambda} dt &= \frac{(\frac{1}{2}a)^{\lambda-1} \Gamma(\frac{1}{2}\mu + \frac{1}{2}\nu - \frac{1}{2}\lambda + \frac{1}{2}) \Gamma(\lambda)}{2 \Gamma(\frac{1}{2}\lambda + \frac{1}{2}\nu - \frac{1}{2}\mu + \frac{1}{2}) \Gamma(\frac{1}{2}\lambda + \frac{1}{2}\mu - \frac{1}{2}\nu + \frac{1}{2}) \Gamma(\frac{1}{2}\lambda + \frac{1}{2}\mu + \frac{1}{2}\nu + \frac{1}{2})}, \\
&\quad \Re(\mu+\nu+1) > \Re\lambda > 0.
\end{aligned}$$

$$\begin{aligned}
10.22.58 \quad \int_0^\infty \frac{J_\nu(at) J_\nu(bt)}{t^\lambda} dt &= \frac{(ab)^\nu \Gamma(\nu - \frac{1}{2}\lambda + \frac{1}{2})}{2^\lambda (a^2 + b^2)^{\nu - \frac{1}{2}\lambda + \frac{1}{2}} \Gamma(\frac{1}{2}\lambda + \frac{1}{2})} \mathbf{F}\left(\frac{2\nu+1-\lambda}{4}, \frac{2\nu+3-\lambda}{4}; \nu+1; \frac{4a^2 b^2}{(a^2+b^2)^2}\right), \\
&\quad a \neq b, \Re(2\nu+1) > \Re\lambda > -1.
\end{aligned}$$

When  $\Re\mu > -1$

$$10.22.59 \quad \int_0^\infty e^{ibt} J_\mu(at) dt = \begin{cases} \frac{\exp(i\mu \arcsin(b/a))}{(a^2 - b^2)^{\frac{1}{2}}}, & 0 \leq b < a, \\ \frac{ia^\mu \exp(\frac{1}{2}\mu\pi i)}{(b^2 - a^2)^{\frac{1}{2}} (b + (b^2 - a^2)^{\frac{1}{2}})^\mu}, & 0 < a < b. \end{cases}$$

$$10.22.60 \quad \int_0^\infty e^{ibt} Y_0(at) dt = \begin{cases} (2i/\pi)(a^2 - b^2)^{-\frac{1}{2}} \arcsin(b/a), & 0 \leq b < a, \\ (b^2 - a^2)^{-\frac{1}{2}} \left( -1 + \frac{2i}{\pi} \ln\left(\frac{a}{b + (b^2 - a^2)^{\frac{1}{2}}}\right) \right), & 0 < a < b. \end{cases}$$

When  $\Re\mu > 0$ ,

$$10.22.61 \quad \int_0^\infty t^{-1} e^{ibt} J_\mu(at) dt = \begin{cases} (1/\mu) \exp(i\mu \arcsin(b/a)), & 0 \leq b \leq a, \\ \frac{a^\mu \exp(\frac{1}{2}\mu\pi i)}{\mu (b + (b^2 - a^2)^{\frac{1}{2}})^\mu}, & 0 < a \leq b. \end{cases}$$

When  $\Re\nu > \Re\mu > -1$ ,

$$10.22.62 \quad \int_0^\infty t^{\mu-\nu+1} J_\mu(at) J_\nu(bt) dt = \begin{cases} 0, & 0 < b < a, \\ \frac{2^{\mu-\nu+1} a^\mu (b^2 - a^2)^{\nu-\mu-1}}{b^\nu \Gamma(\nu - \mu)}, & 0 < a \leq b. \end{cases}$$

When  $\Re\mu > 0$ ,

$$10.22.63 \quad \int_0^\infty J_\mu(at) J_{\mu-1}(bt) dt = \begin{cases} b^{\mu-1} a^{-\mu}, & 0 < b < a, \\ (2b)^{-1}, & b = a (> 0), \\ 0, & 0 < a < b. \end{cases}$$

When  $n = 0, 1, 2, \dots$  and  $\Re\mu > -n - 1$ ,

$$10.22.64 \quad \int_0^\infty J_{\mu+2n+1}(at) J_\mu(bt) dt = \begin{cases} \frac{b^\mu \Gamma(\mu + n + 1)}{a^{\mu+1} n!} \mathbf{F}\left(-n, \mu + n + 1; \mu + 1; \frac{b^2}{a^2}\right), & 0 < b < a, \\ (-1)^n / (2a), & b = a (> 0), \\ 0, & 0 < a < b. \end{cases}$$

$$10.22.65 \quad \int_0^\infty J_0(at) (J_0(bt) - J_0(ct)) \frac{dt}{t} = \begin{cases} 0, & 0 \leq b < a, 0 < c \leq a, \\ \ln(c/a), & 0 \leq b < a \leq c. \end{cases}$$

### Other Double Products

In (10.22.66)–(10.22.70)  $a, b, c$  are positive constants.

$$10.22.66 \quad \int_0^\infty e^{-at} J_\nu(bt) J_\nu(ct) dt = \frac{1}{\pi(bc)^{\frac{1}{2}}} Q_{\nu-\frac{1}{2}}\left(\frac{a^2 + b^2 + c^2}{2bc}\right), \quad \Re\nu > -\frac{1}{2}.$$

$$10.22.67 \quad \int_0^\infty t \exp(-p^2 t^2) J_\nu(at) J_\nu(bt) dt = \frac{1}{2p^2} \exp\left(-\frac{a^2 + b^2}{4p^2}\right) I_\nu\left(\frac{ab}{2p^2}\right), \quad \Re\nu > -1, \Re(p^2) > 0.$$

$$10.22.68 \quad \int_0^\infty t \exp(-p^2 t^2) J_0(at) Y_0(at) dt = -\frac{1}{2\pi p^2} \exp\left(-\frac{a^2}{2p^2}\right) K_0\left(\frac{a^2}{2p^2}\right), \quad \Re(p^2) > 0.$$

For the associated Legendre function  $Q$  see §14.3(ii) with  $\mu = 0$ . For  $I$  and  $K$  see §10.25(ii).

$$10.22.69 \quad \int_0^\infty J_\nu(at) J_\nu(bt) \frac{t dt}{t^2 - z^2} = \begin{cases} \frac{1}{2}\pi i J_\nu(bz) H_\nu^{(1)}(az), & a > b \\ \frac{1}{2}\pi i J_\nu(az) H_\nu^{(1)}(bz), & b > a \end{cases}, \quad \Re\nu > -1, \Im z > 0.$$

$$10.22.70 \quad \int_0^\infty Y_\nu(at) J_{\nu+1}(bt) \frac{t dt}{t^2 - z^2} = \frac{1}{2}\pi J_{\nu+1}(bz) H_\nu^{(1)}(az), \quad a \geq b > 0, \Re\nu > -\frac{3}{2}, \Im z > 0.$$

Equation (10.22.70) also remains valid if the order  $\nu + 1$  of the  $J$  functions on both sides is replaced by  $\nu + 2n - 3$ ,  $n = 1, 2, \dots$ , and the constraint  $\Re\nu > -\frac{3}{2}$  is replaced by  $\Re\nu > -n + \frac{1}{2}$ .

See also §1.17(ii) for an integral representation of the Dirac delta in terms of a product of Bessel functions.

### Triple Products

In (10.22.71) and (10.22.72)  $a, b, c$  are positive constants.

$$10.22.71 \quad \int_0^\infty J_\mu(at) J_\nu(bt) J_\nu(ct) t^{1-\mu} dt = \frac{(bc)^{\mu-1} (\sin \phi)^{\mu-\frac{1}{2}}}{(2\pi)^{\frac{1}{2}} a^\mu} P_{\nu-\frac{1}{2}}^{\frac{1}{2}-\mu}(\cos \phi),$$

$$\Re\mu > -\frac{1}{2}, \Re\nu > -1, |b - c| < a < b + c, \cos \phi = (b^2 + c^2 - a^2)/(2bc).$$

$$10.22.72 \quad \int_0^\infty J_\mu(at) J_\nu(bt) J_\nu(ct) t^{1-\mu} dt = \frac{(bc)^{\mu-1} \cos(\nu\pi) (\sinh \chi)^{\mu-\frac{1}{2}}}{(\frac{1}{2}\pi^3)^{\frac{1}{2}} a^\mu} Q_{\nu-\frac{1}{2}}^{\frac{1}{2}-\mu}(\cosh \chi),$$

$$\Re\mu > -\frac{1}{2}, \Re\nu > -1, a > b + c, \cosh \chi = (a^2 - b^2 - c^2)/(2bc).$$

For the Ferrers function  $P$  and the associated Legendre function  $Q$ , see §§14.3(i) and 14.3(ii), respectively.

In (10.22.74) and (10.22.75),  $a, b, c$  are positive constants and

**10.22.73** 
$$A = s(s-a)(s-b)(s-c), \quad s = \frac{1}{2}(a+b+c).$$

(Thus if  $a, b, c$  are the sides of a triangle, then  $A^{\frac{1}{2}}$  is the area of the triangle.)

If  $\Re \nu > -\frac{1}{2}$ , then

**10.22.74** 
$$\int_0^\infty J_\nu(at) J_\nu(bt) J_\nu(ct) t^{1-\nu} dt = \begin{cases} \frac{2^{\nu-1} A^{\nu-\frac{1}{2}}}{\pi^{\frac{1}{2}} (abc)^\nu \Gamma(\nu + \frac{1}{2})}, & A > 0, \\ 0, & A \leq 0. \end{cases}$$

If  $|\nu| < \frac{1}{2}$ , then

**10.22.75** 
$$\int_0^\infty Y_\nu(at) J_\nu(bt) J_\nu(ct) t^{1+\nu} dt = \begin{cases} -\frac{(abc)^\nu (-A)^{-\nu-\frac{1}{2}}}{\pi^{\frac{1}{2}} 2^{\nu+1} \Gamma(\frac{1}{2} - \nu)}, & 0 < a < |b-c|, \\ 0, & |b-c| < a < b+c, \\ \frac{(abc)^\nu (-A)^{-\nu-\frac{1}{2}}}{\pi^{\frac{1}{2}} 2^{\nu+1} \Gamma(\frac{1}{2} - \nu)}, & a > b+c. \end{cases}$$

Additional infinite integrals over the product of three Bessel functions (including modified Bessel functions) are given in Gervois and Navelet (1984, 1985a,b, 1986a,b).

**10.22(v) Hankel Transform**

The *Hankel transform* (or *Bessel transform*) of a function  $f(x)$  is defined as

**10.22.76** 
$$g(y) = \int_0^\infty f(x) J_\nu(xy) (xy)^{\frac{1}{2}} dx.$$

*Hankel's inversion theorem* is given by

**10.22.77** 
$$f(y) = \int_0^\infty g(x) J_\nu(xy) (xy)^{\frac{1}{2}} dx.$$

Sufficient conditions for the validity of (10.22.77) are that  $\int_0^\infty |f(x)| dx < \infty$  when  $\nu \geq -\frac{1}{2}$ , or that  $\int_0^\infty |f(x)| dx < \infty$  and  $\int_0^1 x^{\nu+\frac{1}{2}} |f(x)| dx < \infty$  when  $-1 < \nu < -\frac{1}{2}$ ; see Titchmarsh (1986a, Theorem 135, Chapter 8) and Akhiezer (1988, p. 62).

For asymptotic expansions of Hankel transforms see Wong (1976, 1977) and Frenzen and Wong (1985).

For collections of Hankel transforms see Erdélyi *et al.* (1954b, Chapter 8) and Oberhettinger (1972).

**10.22(vi) Compendia**

For collections of integrals of the functions  $J_\nu(z)$ ,  $Y_\nu(z)$ ,  $H_\nu^{(1)}(z)$ , and  $H_\nu^{(2)}(z)$ , including integrals with respect to the order, see Andrews *et al.* (1999, pp. 216–225), Apelblat (1983, §12), Erdélyi *et al.* (1953b, §§7.7.1–7.7.7 and 7.14–7.14.2), Erdélyi *et al.* (1954a,b), Gradshteyn and Ryzhik (2000, §§5.5 and 6.5–6.7), Gröbner and Hofreiter (1950, pp. 196–204), Luke (1962), Magnus *et al.* (1966, §3.8), Marichev (1983, pp. 191–216), Oberhettinger (1974, §§1.10 and 2.7), Oberhettinger (1990, §§1.13–1.16 and 2.13–2.16), Oberhettinger and Badii (1973, §§1.14 and 2.12), Okui (1974, 1975), Prudnikov *et al.* (1986b, §§1.8–1.10, 2.12–2.14, 3.2.4–3.2.7,

3.3.2, and 3.4.1), Prudnikov *et al.* (1992a, §§3.12–3.14), Prudnikov *et al.* (1992b, §§3.12–3.14), Watson (1944, Chapters 5, 12, 13, and 14), and Wheelon (1968).

**10.23 Sums**

**10.23(i) Multiplication Theorem**

**10.23.1**

$$\mathcal{C}_\nu(\lambda z) = \lambda^{\pm\nu} \sum_{k=0}^\infty \frac{(\mp 1)^k (\lambda^2 - 1)^k (\frac{1}{2}z)^k}{k!} \mathcal{C}_{\nu \pm k}(z),$$

$$|\lambda^2 - 1| < 1.$$

If  $\mathcal{C} = J$  and the upper signs are taken, then the restriction on  $\lambda$  is unnecessary.

**10.23(ii) Addition Theorems**

**Neumann's Addition Theorem**

**10.23.2** 
$$\mathcal{C}_\nu(u \pm v) = \sum_{k=-\infty}^\infty \mathcal{C}_{\nu \mp k}(u) J_k(v), \quad |v| < |u|.$$

The restriction  $|v| < |u|$  is unnecessary when  $\mathcal{C} = J$  and  $\nu$  is an integer. Special cases are:

**10.23.3** 
$$J_0^2(z) + 2 \sum_{k=1}^\infty J_k^2(z) = 1,$$

**10.23.4** 
$$\sum_{k=0}^{2n} (-1)^k J_k(z) J_{2n-k}(z) + 2 \sum_{k=1}^\infty J_k(z) J_{2n+k}(z) = 0, \quad n \geq 1,$$

**10.23.5** 
$$\sum_{k=0}^n J_k(z) J_{n-k}(z) + 2 \sum_{k=1}^\infty (-1)^k J_k(z) J_{n+k}(z) = J_n(2z).$$

**Graf's and Gegenbauer's Addition Theorems**

Define

$$10.23.6 \quad w = \sqrt{u^2 + v^2 - 2uv \cos \alpha},$$

$$u - v \cos \alpha = w \cos \chi, \quad v \sin \alpha = w \sin \chi,$$

the branches being continuous and chosen so that  $w \rightarrow u$  and  $\chi \rightarrow 0$  as  $v \rightarrow 0$ . If  $u, v$  are real and positive and  $0 \leq \alpha \leq \pi$ , then  $w$  and  $\chi$  are real and nonnegative, and the geometrical relationship is shown in Figure 10.23.1.

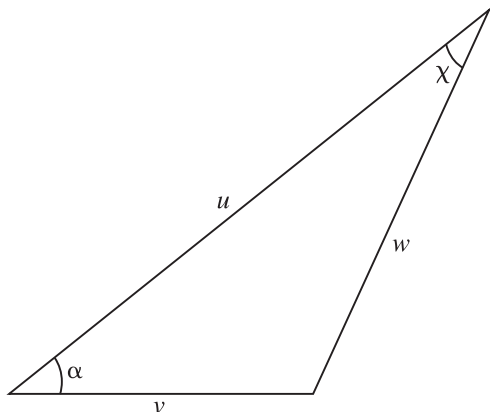


Figure 10.23.1: Graf's and Gegenbauer's addition theorems.

$$10.23.7 \quad \frac{\mathcal{C}_\nu(w)}{\sin(\nu\chi)} \cos(\nu\chi) = \sum_{k=-\infty}^{\infty} \mathcal{C}_{\nu+k}(u) J_k(v) \frac{\cos(k\alpha)}{\sin(k\alpha)},$$

$$|ve^{\pm i\alpha}| < |u|.$$

$$10.23.8 \quad \frac{\mathcal{C}_\nu(w)}{w^\nu} = 2^\nu \Gamma(\nu)$$

$$\times \sum_{k=0}^{\infty} (\nu+k) \frac{\mathcal{C}_{\nu+k}(u)}{u^\nu} \frac{J_{\nu+k}(v)}{v^\nu} C_k^{(\nu)}(\cos \alpha),$$

$$\nu \neq 0, -1, \dots, |ve^{\pm i\alpha}| < |u|,$$

where  $C_k^{(\nu)}(\cos \alpha)$  is Gegenbauer's polynomial (§18.3). The restriction  $|ve^{\pm i\alpha}| < |u|$  is unnecessary in (10.23.7) when  $\mathcal{C} = J$  and  $\nu$  is an integer, and in (10.23.8) when  $\mathcal{C} = J$ .

The degenerate form of (10.23.8) when  $u = \infty$  is given by

$$10.23.9 \quad e^{iv \cos \alpha} = \frac{\Gamma(\nu)}{(\frac{1}{2}v)^\nu} \sum_{k=0}^{\infty} (\nu+k) i^k J_{\nu+k}(v) C_k^{(\nu)}(\cos \alpha),$$

$$\nu \neq 0, -1, \dots$$

**Partial Fractions**

For expansions of products of Bessel functions of the first kind in partial fractions see Rogers (2005).

**10.23(iii) Series Expansions of Arbitrary Functions**

**Neumann's Expansion**

$$10.23.10 \quad f(z) = a_0 J_0(z) + 2 \sum_{k=1}^{\infty} a_k J_k(z), \quad |z| < c,$$

where  $c$  is the distance of the nearest singularity of the analytic function  $f(z)$  from  $z = 0$ ,

$$10.23.11 \quad a_k = \frac{1}{2\pi i} \int_{|z|=c'} f(t) O_k(t) dt, \quad 0 < c' < c,$$

and  $O_k(t)$  is Neumann's polynomial, defined by the generating function:

$$10.23.12 \quad \frac{1}{t-z} = J_0(z) O_0(t) + 2 \sum_{k=1}^{\infty} J_k(z) O_k(t), \quad |z| < |t|.$$

$O_n(t)$  is a polynomial of degree  $n+1$  in  $1/t$  :  $O_0(t) = 1/t$  and

$$10.23.13 \quad O_n(t) = \frac{1}{4} \sum_{k=0}^{\lfloor n/2 \rfloor} \frac{(n-k-1)! n}{k!} \left(\frac{2}{t}\right)^{n-2k+1}, \quad n = 1, 2, \dots$$

For the more general form of expansion

$$10.23.14 \quad z^\nu f(z) = a_0 J_\nu(z) + 2 \sum_{k=1}^{\infty} a_k J_{\nu+k}(z)$$

see Watson (1944, §16.13), and for further generalizations see Watson (1944, Chapter 16) and (Erdélyi *et al.*, 1953b, §7.10.1).

**Examples**

$$10.23.15 \quad \left(\frac{1}{2}z\right)^\nu = \sum_{k=0}^{\infty} \frac{(\nu+2k)\Gamma(\nu+k)}{k!} J_{\nu+2k}(z),$$

$$\nu \neq 0, -1, -2, \dots,$$

$$10.23.16 \quad Y_0(z) = \frac{2}{\pi} \left(\ln\left(\frac{1}{2}z\right) + \gamma\right) J_0(z) - \frac{4}{\pi} \sum_{k=1}^{\infty} (-1)^k \frac{J_{2k}(z)}{k},$$

$$Y_n(z) = -\frac{n! \left(\frac{1}{2}z\right)^{-n}}{\pi} \sum_{k=0}^{n-1} \frac{\left(\frac{1}{2}z\right)^k J_k(z)}{k!(n-k)}$$

$$10.23.17 \quad + \frac{2}{\pi} \left(\ln\left(\frac{1}{2}z\right) - \psi(n+1)\right) J_n(z)$$

$$- \frac{2}{\pi} \sum_{k=1}^{\infty} (-1)^k \frac{(n+2k) J_{n+2k}(z)}{k(n+k)},$$

where  $\gamma$  is Euler's constant and  $\psi(n+1) = \Gamma'(n+1)/\Gamma(n+1)$  (§5.2).

Other examples are provided by (10.12.1)–(10.12.6), (10.23.2), and (10.23.7).



**Fourier–Bessel Expansion**

Assume  $f(t)$  satisfies

**10.23.18** 
$$\int_0^1 t^{\frac{1}{2}} |f(t)| dt < \infty,$$

and define

**10.23.19** 
$$a_m = \frac{2}{(J_{\nu+1}(j_{\nu,m}))^2} \int_0^1 t f(t) J_{\nu}(j_{\nu,m}t) dt, \quad \nu \geq -\frac{1}{2},$$

where  $j_{\nu,m}$  is as in §10.21(i). If  $0 < x < 1$ , then

**10.23.20** 
$$\frac{1}{2}f(x-) + \frac{1}{2}f(x+) = \sum_{m=1}^{\infty} a_m J_{\nu}(j_{\nu,m}x),$$

provided that  $f(t)$  is of bounded variation (§1.4(v)) on an interval  $[a, b]$  with  $0 < a < x < b < 1$ . This result is proved in Watson (1944, Chapter 18) and further information is provided in this reference, including the behavior of the series near  $x = 0$  and  $x = 1$ .

As an example,

**10.23.21** 
$$x^{\nu} = \sum_{m=1}^{\infty} \frac{2J_{\nu}(j_{\nu,m}x)}{j_{\nu,m}J_{\nu+1}(j_{\nu,m})}, \quad \nu > 0, 0 \leq x < 1.$$

(Note that when  $x = 1$  the left-hand side is 1 and the right-hand side is 0.)

**Other Series Expansions**

For other types of expansions of arbitrary functions in series of Bessel functions, see Watson (1944, Chapters 17–19) and Erdélyi *et al.* (1953b, §§ 7.10.2–7.10.4). See also Schäfke (1960, 1961b).

**10.23(iv) Compendia**

For collections of sums of series involving Bessel or Hankel functions see Erdélyi *et al.* (1953b, §7.15), Gradshteyn and Ryzhik (2000, §§8.51–8.53), Hansen (1975), Luke (1969b, §9.4), Prudnikov *et al.* (1986b, pp. 651–691 and 697–700), and Wheelon (1968, pp. 48–51).

**10.24 Functions of Imaginary Order**

With  $z = x$  and  $\nu$  replaced by  $i\nu$ , Bessel’s equation (10.2.1) becomes

**10.24.1** 
$$x^2 \frac{d^2 w}{dx^2} + x \frac{dw}{dx} + (x^2 + \nu^2)w = 0.$$

For  $\nu \in \mathbb{R}$  and  $x \in (0, \infty)$  define

**10.24.2** 
$$\begin{aligned} \tilde{J}_{\nu}(x) &= \operatorname{sech}\left(\frac{1}{2}\pi\nu\right) \Re(J_{i\nu}(x)), \\ \tilde{Y}_{\nu}(x) &= \operatorname{sech}\left(\frac{1}{2}\pi\nu\right) \Re(Y_{i\nu}(x)), \end{aligned}$$

and

**10.24.3** 
$$\Gamma(1 + i\nu) = \left(\frac{\pi\nu}{\sinh(\pi\nu)}\right)^{\frac{1}{2}} e^{i\gamma_{\nu}},$$

where  $\gamma_{\nu}$  is real and continuous with  $\gamma_0 = 0$ ; compare (5.4.3). Then

**10.24.4** 
$$\tilde{J}_{-\nu}(x) = \tilde{J}_{\nu}(x), \quad \tilde{Y}_{-\nu}(x) = \tilde{Y}_{\nu}(x),$$

and  $\tilde{J}_{\nu}(x), \tilde{Y}_{\nu}(x)$  are linearly independent solutions of (10.24.1):

**10.24.5** 
$$\mathscr{W}\{\tilde{J}_{\nu}(x), \tilde{Y}_{\nu}(x)\} = 2/(\pi x).$$

As  $x \rightarrow +\infty$ , with  $\nu$  fixed,

$$\tilde{J}_{\nu}(x) = \sqrt{2/(\pi x)} \cos\left(x - \frac{1}{4}\pi\right) + O\left(x^{-\frac{3}{2}}\right),$$

**10.24.6** 
$$\tilde{Y}_{\nu}(x) = \sqrt{2/(\pi x)} \sin\left(x - \frac{1}{4}\pi\right) + O\left(x^{-\frac{3}{2}}\right).$$

As  $x \rightarrow 0+$ , with  $\nu$  fixed,

**10.24.7** 
$$\begin{aligned} \tilde{J}_{\nu}(x) &= \left(\frac{2 \tanh(\frac{1}{2}\pi\nu)}{\pi\nu}\right)^{\frac{1}{2}} \cos\left(\nu \ln\left(\frac{1}{2}x\right) - \gamma_{\nu}\right) \\ &\quad + O(x^2), \end{aligned}$$

**10.24.8** 
$$\begin{aligned} \tilde{Y}_{\nu}(x) &= \left(\frac{2 \coth(\frac{1}{2}\pi\nu)}{\pi\nu}\right)^{\frac{1}{2}} \sin\left(\nu \ln\left(\frac{1}{2}x\right) - \gamma_{\nu}\right) \\ &\quad + O(x^2), \end{aligned} \quad \nu > 0,$$

and

**10.24.9** 
$$\tilde{Y}_0(x) = Y_0(x) = \frac{2}{\pi} \left(\ln\left(\frac{1}{2}x\right) + \gamma\right) + O(x^2 \ln x),$$

where  $\gamma$  denotes Euler’s constant §5.2(ii).

In consequence of (10.24.6), when  $x$  is large  $\tilde{J}_{\nu}(x)$  and  $\tilde{Y}_{\nu}(x)$  comprise a numerically satisfactory pair of solutions of (10.24.1); compare §2.7(iv). Also, in consequence of (10.24.7)–(10.24.9), when  $x$  is small either  $\tilde{J}_{\nu}(x)$  and  $\tanh(\frac{1}{2}\pi\nu)\tilde{Y}_{\nu}(x)$  or  $\tilde{J}_{\nu}(x)$  and  $\tilde{Y}_{\nu}(x)$  comprise a numerically satisfactory pair depending whether  $\nu \neq 0$  or  $\nu = 0$ .

For graphs of  $\tilde{J}_{\nu}(x)$  and  $\tilde{Y}_{\nu}(x)$  see §10.3(iii).

For mathematical properties and applications of  $\tilde{J}_{\nu}(x)$  and  $\tilde{Y}_{\nu}(x)$ , including zeros and uniform asymptotic expansions for large  $\nu$ , see Dunster (1990a). In this reference  $\tilde{J}_{\nu}(x)$  and  $\tilde{Y}_{\nu}(x)$  are denoted respectively by  $F_{i\nu}(x)$  and  $G_{i\nu}(x)$ .

**Modified Bessel Functions**

**10.25 Definitions**

**10.25(i) Modified Bessel’s Equation**

**10.25.1** 
$$z^2 \frac{d^2 w}{dz^2} + z \frac{dw}{dz} - (z^2 + \nu^2)w = 0.$$

This equation is obtained from Bessel’s equation (10.2.1) on replacing  $z$  by  $\pm iz$ , and it has the same kinds of singularities. Its solutions are called *modified Bessel functions* or *Bessel functions of imaginary argument*.

### 10.25(ii) Standard Solutions

10.25.2 
$$I_\nu(z) = \left(\frac{1}{2}z\right)^\nu \sum_{k=0}^{\infty} \frac{\left(\frac{1}{4}z^2\right)^k}{k! \Gamma(\nu + k + 1)}.$$

This solution has properties analogous to those of  $J_\nu(z)$ , defined in §10.2(ii). In particular, the *principal branch* of  $I_\nu(z)$  is defined in a similar way: it corresponds to the principal value of  $(\frac{1}{2}z)^\nu$ , is analytic in  $\mathbb{C} \setminus (-\infty, 0]$ , and two-valued and discontinuous on the cut  $\text{ph } z = \pm\pi$ .

The defining property of the second standard solution  $K_\nu(z)$  of (10.25.1) is

10.25.3 
$$K_\nu(z) \sim \sqrt{\pi/(2z)}e^{-z},$$

as  $z \rightarrow \infty$  in  $|\text{ph } z| \leq \frac{3}{2}\pi - \delta$  ( $< \frac{3}{2}\pi$ ). It has a branch point at  $z = 0$  for all  $\nu \in \mathbb{C}$ . The *principal branch* corresponds to the principal value of the square root in (10.25.3), is analytic in  $\mathbb{C} \setminus (-\infty, 0]$ , and two-valued and discontinuous on the cut  $\text{ph } z = \pm\pi$ .

Both  $I_\nu(z)$  and  $K_\nu(z)$  are real when  $\nu$  is real and  $\text{ph } z = 0$ .

For fixed  $z$  ( $\neq 0$ ) each branch of  $I_\nu(z)$  and  $K_\nu(z)$  is entire in  $\nu$ .

### Branch Conventions

Except where indicated otherwise it is assumed throughout this Handbook that the symbols  $I_\nu(z)$  and  $K_\nu(z)$  denote the principal values of these functions.

### Symbol $\mathcal{Z}_\nu(z)$

Corresponding to the symbol  $\mathcal{C}_\nu$  introduced in §10.2(ii), we sometimes use  $\mathcal{Z}_\nu(z)$  to denote  $I_\nu(z)$ ,  $e^{\nu\pi i} K_\nu(z)$ , or any nontrivial linear combination of these functions, the coefficients in which are independent of  $z$  and  $\nu$ .

### 10.25(iii) Numerically Satisfactory Pairs of Solutions

Table 10.25.1 lists numerically satisfactory pairs of solutions (§2.7(iv)) of (10.25.1). It is assumed that  $\Re\nu \geq 0$ . When  $\Re\nu < 0$ ,  $I_\nu(z)$  is replaced by  $I_{-\nu}(z)$ .

Table 10.25.1: Numerically satisfactory pairs of solutions of the modified Bessel's equation.

Pair	Region
$I_\nu(z), K_\nu(z)$	$ \text{ph } z  \leq \frac{1}{2}\pi$
$I_\nu(z), K_\nu(ze^{\mp\pi i})$	$\frac{1}{2}\pi \leq \pm \text{ph } z \leq \frac{3}{2}\pi$

## 10.26 Graphics

### 10.26(i) Real Order and Variable

See Figures 10.26.1–10.26.6.

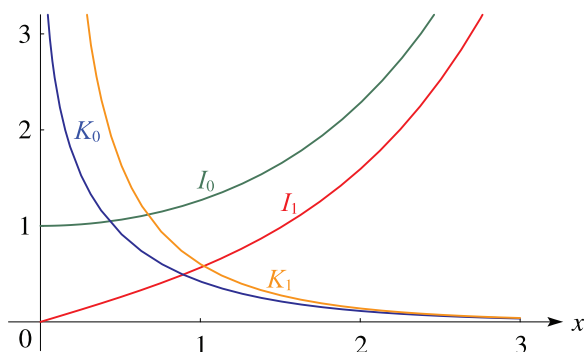


Figure 10.26.1:  $I_0(x), I_1(x), K_0(x), K_1(x), 0 \leq x \leq 3$ .

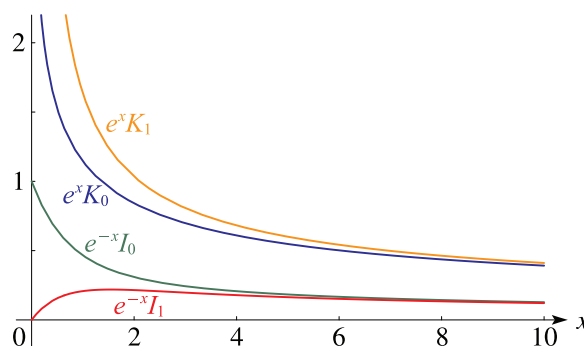


Figure 10.26.2:  $e^{-x} I_0(x), e^{-x} I_1(x), e^x K_0(x), e^x K_1(x), 0 \leq x \leq 10$ .

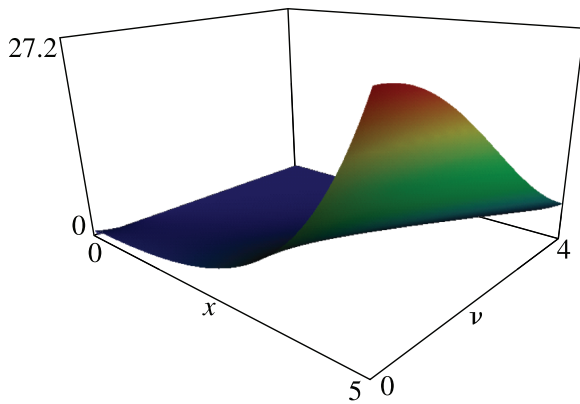


Figure 10.26.3:  $I_\nu(x)$ ,  $0 \leq x \leq 5, 0 \leq \nu \leq 4$ .

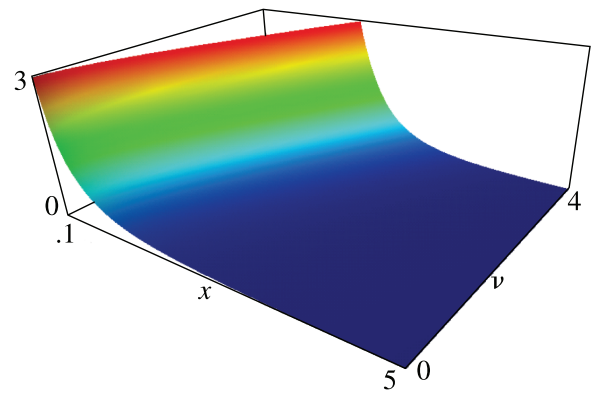


Figure 10.26.4:  $K_\nu(x)$ ,  $0.1 \leq x \leq 5, 0 \leq \nu \leq 4$ .

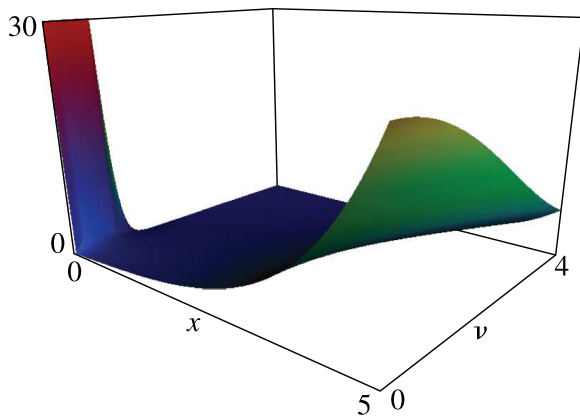


Figure 10.26.5:  $I'_\nu(x)$ ,  $0 \leq x \leq 5, 0 \leq \nu \leq 4$ .

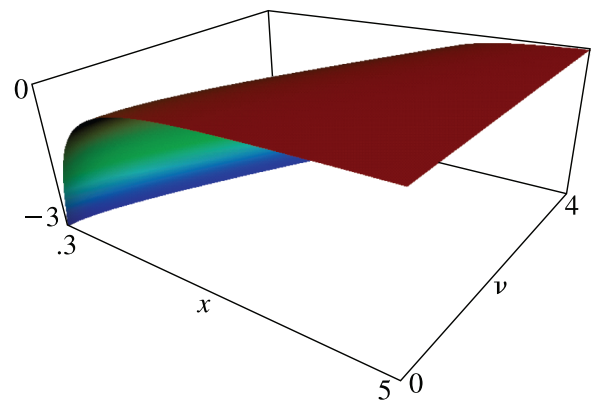


Figure 10.26.6:  $K'_\nu(x)$ ,  $0.3 \leq x \leq 5, 0 \leq \nu \leq 4$ .

**10.26(ii) Real Order, Complex Variable**

Apply (10.27.6) and (10.27.8) to §10.3(ii).

**10.26(iii) Imaginary Order, Real Variable**

See Figures 10.26.7–10.26.10. For the notation, see §10.45.

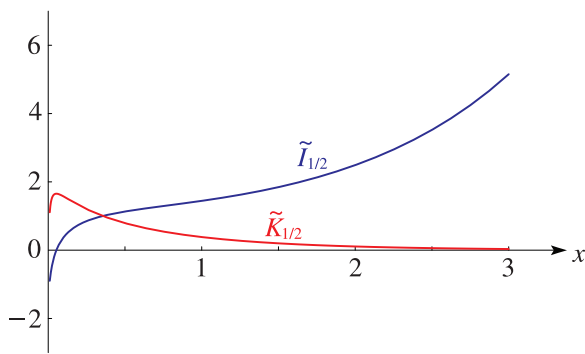


Figure 10.26.7:  $\tilde{I}_{1/2}(x), \tilde{K}_{1/2}(x), 0.01 \leq x \leq 3$ .

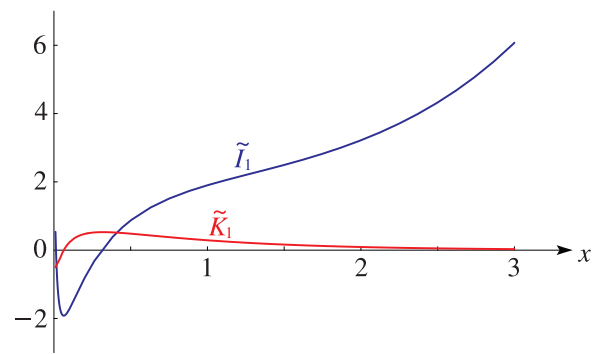


Figure 10.26.8:  $\tilde{I}_1(x), \tilde{K}_1(x), 0.01 \leq x \leq 3$ .

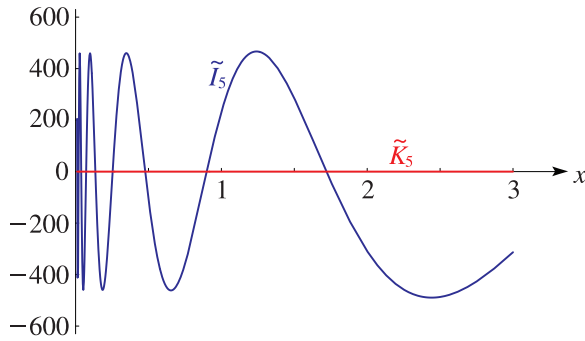


Figure 10.26.9:  $\tilde{I}_5(x), \tilde{K}_5(x), 0.01 \leq x \leq 3$ .

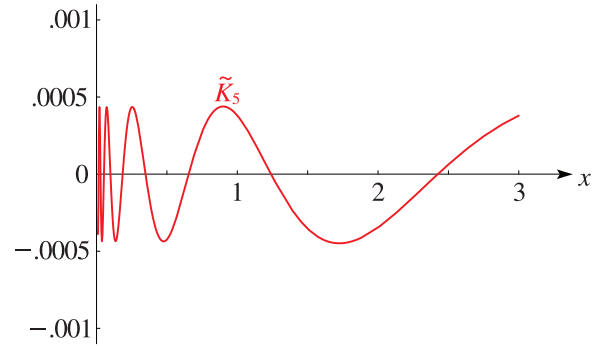


Figure 10.26.10:  $\tilde{K}_5(x), 0.01 \leq x \leq 3$ .

### 10.27 Connection Formulas

Other solutions of (10.25.1) are  $I_{-\nu}(z)$  and  $K_{-\nu}(z)$ .

10.27.1 
$$I_{-n}(z) = I_n(z),$$

10.27.2 
$$I_{-\nu}(z) = I_\nu(z) + (2/\pi) \sin(\nu\pi) K_\nu(z),$$

10.27.3 
$$K_{-\nu}(z) = K_\nu(z).$$

10.27.4 
$$K_\nu(z) = \frac{1}{2}\pi \frac{I_{-\nu}(z) - I_\nu(z)}{\sin(\nu\pi)}.$$

When  $\nu$  is an integer limiting values are taken:

10.27.5 
$$K_n(z) = \frac{(-1)^{n-1}}{2} \left( \left. \frac{\partial I_\nu(z)}{\partial \nu} \right|_{\nu=n} + \left. \frac{\partial I_\nu(z)}{\partial \nu} \right|_{\nu=-n} \right),$$
  

$$n = 0, \pm 1, \pm 2, \dots$$

In terms of the solutions of (10.2.1),

10.27.6 
$$I_\nu(z) = e^{\mp \nu \pi i/2} J_\nu(z e^{\pm \pi i/2}), \quad -\pi \leq \pm \text{ph } z \leq \frac{1}{2}\pi,$$

10.27.7 
$$I_\nu(z) = \frac{1}{2} e^{\mp \nu \pi i/2} \left( H_\nu^{(1)}(z e^{\pm \pi i/2}) + H_\nu^{(2)}(z e^{\pm \pi i/2}) \right),$$
  

$$-\pi \leq \pm \text{ph } z \leq \frac{1}{2}\pi.$$

10.27.8 
$$K_\nu(z) = \begin{cases} \frac{1}{2}\pi i e^{\nu \pi i/2} H_\nu^{(1)}(z e^{\pi i/2}), & -\pi \leq \text{ph } z \leq \frac{1}{2}\pi, \\ -\frac{1}{2}\pi i e^{-\nu \pi i/2} H_\nu^{(2)}(z e^{-\pi i/2}), & -\frac{1}{2}\pi \leq \text{ph } z \leq \pi. \end{cases}$$

10.27.9 
$$\pi i J_\nu(z) = e^{-\nu \pi i/2} K_\nu(z e^{-\pi i/2}) - e^{\nu \pi i/2} K_\nu(z e^{\pi i/2}), \quad |\text{ph } z| \leq \frac{1}{2}\pi.$$

10.27.10 
$$-\pi Y_\nu(z) = e^{-\nu \pi i/2} K_\nu(z e^{-\pi i/2}) + e^{\nu \pi i/2} K_\nu(z e^{\pi i/2}),$$
  

$$|\text{ph } z| \leq \frac{1}{2}\pi.$$

$$Y_\nu(z) = e^{\pm(\nu+1)\pi i/2} I_\nu(z e^{\mp \pi i/2})$$

10.27.11 
$$-(2/\pi) e^{\mp \nu \pi i/2} K_\nu(z e^{\mp \pi i/2}),$$
  

$$-\frac{1}{2}\pi \leq \pm \text{ph } z \leq \pi.$$

See also §10.34.

Many properties of modified Bessel functions follow immediately from those of ordinary Bessel functions by application of (10.27.6)–(10.27.8).

### 10.28 Wronskians and Cross-Products

10.28.1 
$$\mathscr{W}\{I_\nu(z), I_{-\nu}(z)\} = I_\nu(z) I_{-\nu-1}(z) - I_{\nu+1}(z) I_{-\nu}(z)$$
  

$$= -2 \sin(\nu\pi)/(\pi z),$$

10.28.2 
$$\mathscr{W}\{K_\nu(z), I_\nu(z)\} = I_\nu(z) K_{\nu+1}(z) + I_{\nu+1}(z) K_\nu(z)$$
  

$$= 1/z.$$

### 10.29 Recurrence Relations and Derivatives

#### 10.29(i) Recurrence Relations

With  $\mathscr{L}_\nu(z)$  defined as in §10.25(ii),

10.29.1 
$$\mathscr{L}_{\nu-1}(z) - \mathscr{L}_{\nu+1}(z) = (2\nu/z) \mathscr{L}_\nu(z),$$
  

$$\mathscr{L}_{\nu-1}(z) + \mathscr{L}_{\nu+1}(z) = 2\mathscr{L}'_\nu(z).$$

10.29.2 
$$\mathscr{L}'_\nu(z) = \mathscr{L}_{\nu-1}(z) - (\nu/z) \mathscr{L}_\nu(z),$$
  

$$\mathscr{L}'_\nu(z) = \mathscr{L}_{\nu+1}(z) + (\nu/z) \mathscr{L}_\nu(z).$$

10.29.3 
$$I'_0(z) = I_1(z), \quad K'_0(z) = -K_1(z).$$

**10.29(ii) Derivatives**

For  $k = 0, 1, 2, \dots$ ,

$$10.29.4 \quad \left(\frac{1}{z} \frac{d}{dz}\right)^k (z^\nu \mathcal{Z}_\nu(z)) = z^{\nu-k} \mathcal{Z}_{\nu-k}(z),$$

$$\left(\frac{1}{z} \frac{d}{dz}\right)^k (z^{-\nu} \mathcal{Z}_\nu(z)) = z^{-\nu-k} \mathcal{Z}_{\nu+k}(z).$$

$$10.29.5 \quad \mathcal{Z}_\nu^{(k)}(z) = \frac{1}{2^k} \left( \mathcal{Z}_{\nu-k}(z) + \binom{k}{1} \mathcal{Z}_{\nu-k+2}(z) + \binom{k}{2} \mathcal{Z}_{\nu-k+4}(z) + \dots + \mathcal{Z}_{\nu+k}(z) \right).$$

**10.30 Limiting Forms**

**10.30(i)  $z \rightarrow 0$**

When  $\nu$  is fixed and  $z \rightarrow 0$ ,

$$10.30.1 \quad I_\nu(z) \sim \left(\frac{1}{2}z\right)^\nu / \Gamma(\nu + 1), \quad \nu \neq -1, -2, -3, \dots,$$

$$10.30.2 \quad K_\nu(z) \sim \frac{1}{2} \Gamma(\nu) \left(\frac{1}{2}z\right)^{-\nu}, \quad \Re \nu > 0,$$

$$10.30.3 \quad K_0(z) \sim -\ln z.$$

For  $K_\nu(x)$ , when  $\nu$  is purely imaginary and  $x \rightarrow 0+$ , see (10.45.2) and (10.45.7).

**10.30(ii)  $z \rightarrow \infty$**

When  $\nu$  is fixed and  $z \rightarrow \infty$ ,

$$10.30.4 \quad I_\nu(z) \sim e^z / \sqrt{2\pi z}, \quad |\text{ph } z| \leq \frac{1}{2}\pi - \delta,$$

$$10.30.5 \quad I_\nu(z) \sim e^{\pm(\nu+\frac{1}{2})\pi i} e^{-z/\sqrt{2\pi z}}, \quad \frac{1}{2}\pi + \delta \leq \pm \text{ph } z \leq \frac{3}{2}\pi - \delta.$$

For  $K_\nu(z)$  see (10.25.3).

**10.31 Power Series**

For  $I_\nu(z)$  see (10.25.2) and (10.27.1). When  $\nu$  is not an integer the corresponding expansion for  $K_\nu(z)$  is obtained from (10.25.2) and (10.27.4).

When  $n = 0, 1, 2, \dots$ ,

$$10.31.1 \quad K_n(z) = \frac{1}{2} \left(\frac{1}{2}z\right)^{-n} \sum_{k=0}^{n-1} \frac{(n-k-1)!}{k!} \left(-\frac{1}{4}z^2\right)^k + (-1)^{n+1} \ln\left(\frac{1}{2}z\right) I_n(z) + (-1)^n \frac{1}{2} \left(\frac{1}{2}z\right)^n \sum_{k=0}^{\infty} (\psi(k+1) + \psi(n+k+1)) \frac{\left(\frac{1}{4}z^2\right)^k}{k!(n+k)!},$$

where  $\psi(x) = \Gamma'(x)/\Gamma(x)$  (§5.2(i)). In particular,

**10.31.2**

$$K_0(z) = -\left(\ln\left(\frac{1}{2}z\right) + \gamma\right) I_0(z) + \frac{1}{4} \frac{z^2}{(1!)^2} + \left(1 + \frac{1}{2}\right) \frac{\left(\frac{1}{4}z^2\right)^2}{(2!)^2} + \left(1 + \frac{1}{2} + \frac{1}{3}\right) \frac{\left(\frac{1}{4}z^2\right)^3}{(3!)^2} + \dots$$

For negative values of  $n$  use (10.27.3).

**10.31.3**

$$I_\nu(z) I_\mu(z) = \left(\frac{1}{2}z\right)^{\nu+\mu} \sum_{k=0}^{\infty} \frac{(\nu + \mu + k + 1)_k \left(\frac{1}{4}z^2\right)^k}{k! \Gamma(\nu + k + 1) \Gamma(\mu + k + 1)}.$$

**10.32 Integral Representations**

**10.32(i) Integrals along the Real Line**

**10.32.1**

$$I_0(z) = \frac{1}{\pi} \int_0^\pi e^{\pm z \cos \theta} d\theta = \frac{1}{\pi} \int_0^\pi \cosh(z \cos \theta) d\theta.$$

$$I_\nu(z) = \frac{\left(\frac{1}{2}z\right)^\nu}{\pi^{\frac{1}{2}} \Gamma\left(\nu + \frac{1}{2}\right)} \int_0^\pi e^{\pm z \cos \theta} (\sin \theta)^{2\nu} d\theta$$

**10.32.2**

$$= \frac{\left(\frac{1}{2}z\right)^\nu}{\pi^{\frac{1}{2}} \Gamma\left(\nu + \frac{1}{2}\right)} \int_{-1}^1 (1-t^2)^{\nu-\frac{1}{2}} e^{\pm z t} dt,$$

$\Re \nu > -\frac{1}{2}$ .

**10.32.3**

$$I_n(z) = \frac{1}{\pi} \int_0^\pi e^{z \cos \theta} \cos(n\theta) d\theta.$$

**10.32.4**

$$I_\nu(z) = \frac{1}{\pi} \int_0^\pi e^{z \cos \theta} \cos(\nu\theta) d\theta - \frac{\sin(\nu\pi)}{\pi} \int_0^\infty e^{-z \cosh t - \nu t} dt, \quad |\text{ph } z| < \frac{1}{2}\pi.$$

**10.32.5**

$$K_0(z) = -\frac{1}{\pi} \int_0^\pi e^{\pm z \cos \theta} (\gamma + \ln(2z(\sin \theta)^2)) d\theta.$$

**10.32.6**

$$K_0(x) = \int_0^\infty \cos(x \sinh t) dt = \int_0^\infty \frac{\cos(xt)}{\sqrt{t^2 + 1}} dt, \quad x > 0.$$

$$K_\nu(x) = \sec\left(\frac{1}{2}\nu\pi\right) \int_0^\infty \cos(x \sinh t) \cosh(\nu t) dt$$

**10.32.7**

$$= \csc\left(\frac{1}{2}\nu\pi\right) \int_0^\infty \sin(x \sinh t) \sinh(\nu t) dt,$$

$|\Re \nu| < 1, x > 0$ .

$$K_\nu(z) = \frac{\pi^{\frac{1}{2}} \left(\frac{1}{2}z\right)^\nu}{\Gamma\left(\nu + \frac{1}{2}\right)} \int_0^\infty e^{-z \cosh t} (\sinh t)^{2\nu} dt$$

**10.32.8**

$$= \frac{\pi^{\frac{1}{2}} \left(\frac{1}{2}z\right)^\nu}{\Gamma\left(\nu + \frac{1}{2}\right)} \int_1^\infty e^{-zt} (t^2 - 1)^{\nu-\frac{1}{2}} dt,$$

$\Re \nu > -\frac{1}{2}, |\text{ph } z| < \frac{1}{2}\pi$ .

**10.32.9**

$$K_\nu(z) = \int_0^\infty e^{-z \cosh t} \cosh(\nu t) dt, \quad |\text{ph } z| < \frac{1}{2}\pi.$$

10.32.10

$$K_\nu(z) = \frac{1}{2} \left(\frac{1}{2}z\right)^\nu \int_0^\infty \exp\left(-t - \frac{z^2}{4t}\right) \frac{dt}{t^{\nu+1}}, \quad |\text{ph } z| < \frac{1}{4}\pi.$$

Basset's Integral

10.32.11 
$$K_\nu(xz) = \frac{\Gamma(\nu + \frac{1}{2})(2z)^\nu}{\pi^{\frac{1}{2}}x^\nu} \int_0^\infty \frac{\cos(xt) dt}{(t^2 + z^2)^{\nu + \frac{1}{2}}},$$
  
 $\Re\nu > -\frac{1}{2}, x > 0, |\text{ph } z| < \frac{1}{2}\pi.$

10.32(ii) Contour Integrals

10.32.12

$$I_\nu(z) = \frac{1}{2\pi i} \int_{\infty - i\pi}^{\infty + i\pi} e^{z \cosh t - \nu t} dt, \quad |\text{ph } z| < \frac{1}{2}\pi.$$

Mellin-Barnes Type

10.32.13 
$$K_\nu(z) = \frac{(\frac{1}{2}z)^\nu}{4\pi i} \int_{c-i\infty}^{c+i\infty} \Gamma(t) \Gamma(t - \nu) (\frac{1}{2}z)^{-2t} dt,$$
  
 $c > \max(\Re\nu, 0), |\text{ph } z| < \pi.$

10.32.14

$$K_\nu(z) = \frac{1}{2\pi^2 i} \left(\frac{\pi}{2z}\right)^{\frac{1}{2}} e^{-z} \cos(\nu\pi) \times \int_{-i\infty}^{i\infty} \Gamma(t) \Gamma(\frac{1}{2} - t - \nu) \Gamma(\frac{1}{2} - t + \nu) (2z)^t dt,$$
  
 $\nu - \frac{1}{2} \notin \mathbb{Z}, |\text{ph } z| < \frac{3}{2}\pi.$

Mellin-Barnes Type

10.32.19 
$$K_\mu(z) K_\nu(z) = \frac{1}{8\pi i} \int_{c-i\infty}^{c+i\infty} \frac{\Gamma(t + \frac{1}{2}\mu + \frac{1}{2}\nu) \Gamma(t + \frac{1}{2}\mu - \frac{1}{2}\nu) \Gamma(t - \frac{1}{2}\mu + \frac{1}{2}\nu) \Gamma(t - \frac{1}{2}\mu - \frac{1}{2}\nu)}{\Gamma(2t)} (\frac{1}{2}z)^{-2t} dt,$$
  
 $c > \frac{1}{2}(|\Re\mu| + |\Re\nu|), |\text{ph } z| < \frac{1}{2}\pi.$

For similar integrals for  $J_\nu(z) K_\nu(z)$  and  $I_\nu(z) K_\nu(z)$  see Paris and Kaminski (2001, p. 116).

10.32(iv) Compendia

For collections of integral representations of modified Bessel functions, or products of modified Bessel functions, see Erdélyi *et al.* (1953b, §§7.3, 7.12, and 7.14.2), Erdélyi *et al.* (1954a, pp. 48–60, 105–115, 276–285, and 357–359), Gröbner and Hofreiter (1950, pp. 193–194), Magnus *et al.* (1966, §3.7), Marichev (1983, pp. 191–216), and Watson (1944, Chapters 6, 12, and 13).

10.33 Continued Fractions

Assume  $I_{\nu-1}(z) \neq 0$ . Then

10.33.1

$$\frac{I_\nu(z)}{I_{\nu-1}(z)} = \frac{1}{2\nu z^{-1} + \frac{1}{2(\nu+1)z^{-1} + \frac{1}{2(\nu+2)z^{-1} + \dots}}}, \quad z \neq 0,$$

In (10.32.14) the integration contour separates the poles of  $\Gamma(t)$  from the poles of  $\Gamma(\frac{1}{2} - t - \nu) \Gamma(\frac{1}{2} - t + \nu)$ .

10.32(iii) Products

10.32.15

$$I_\mu(z) I_\nu(z) = \frac{2}{\pi} \int_0^{\frac{1}{2}\pi} I_{\mu+\nu}(2z \cos \theta) \cos((\mu - \nu)\theta) d\theta,$$
  
 $\Re(\mu + \nu) > -1.$

10.32.16

$$I_\mu(x) K_\nu(x) = \int_0^\infty J_{\mu\pm\nu}(2x \sinh t) e^{(-\mu\pm\nu)t} dt,$$
  
 $\Re(\mu \mp \nu) > -\frac{1}{2}, \Re(\mu \pm \nu) > -1, x > 0.$

10.32.17

$$K_\mu(z) K_\nu(z) = 2 \int_0^\infty K_{\mu\pm\nu}(2z \cosh t) \cosh((\mu \mp \nu)t) dt,$$
  
 $|\text{ph } z| < \frac{1}{2}\pi.$

10.32.18

$$K_\nu(z) K_\nu(\zeta) = \frac{1}{2} \int_0^\infty \exp\left(-\frac{t}{2} - \frac{z^2 + \zeta^2}{2t}\right) K_\nu\left(\frac{z\zeta}{t}\right) \frac{dt}{t},$$
  
 $|\text{ph } z| < \pi, |\text{ph } \zeta| < \pi, |\text{ph}(z + \zeta)| < \frac{1}{4}\pi.$

10.33.2

$$\frac{I_\nu(z)}{I_{\nu-1}(z)} = \frac{\frac{1}{2}z/\nu}{1+} \frac{\frac{1}{4}z^2/(\nu(\nu+1))}{1+} \frac{\frac{1}{4}z^2/((\nu+1)(\nu+2))}{1+} \dots,$$
  
 $\nu \neq 0, -1, -2, \dots$

See also Cuyt *et al.* (2008, pp. 361–367).

10.34 Analytic Continuation

When  $m \in \mathbb{Z}$ ,

10.34.1

$$I_\nu(ze^{m\pi i}) = e^{m\nu\pi i} I_\nu(z),$$

10.34.2

$$K_\nu(ze^{m\pi i}) = e^{-m\nu\pi i} K_\nu(z) - \pi i \sin(m\nu\pi) \csc(\nu\pi) I_\nu(z).$$

10.34.3

$$I_\nu(ze^{m\pi i}) = (i/\pi) \left( \pm e^{m\nu\pi i} K_\nu(ze^{\pm\pi i}) \mp e^{(m\mp 1)\nu\pi i} K_\nu(z) \right),$$

10.34.4

$$K_\nu(ze^{m\pi i}) = \csc(\nu\pi) \left( \pm \sin(m\nu\pi) K_\nu(ze^{\pm\pi i}) \mp \sin((m \mp 1)\nu\pi) K_\nu(z) \right).$$

If  $\nu = n(\in \mathbb{Z})$ , then limiting values are taken in (10.34.2) and (10.34.4):

**10.34.5**

$$K_n(ze^{m\pi i}) = (-1)^{mn} K_n(z) + (-1)^{n(m-1)-1} m\pi i I_n(z),$$

**10.34.6** 
$$K_n(ze^{m\pi i}) = \pm(-1)^{n(m-1)} m K_n(ze^{\pm\pi i}) \mp (-1)^{nm} (m \mp 1) K_n(z).$$

For real  $\nu$ ,

**10.34.7** 
$$I_\nu(\bar{z}) = \overline{I_\nu(z)}, \quad K_\nu(\bar{z}) = \overline{K_\nu(z)}.$$

For complex  $\nu$  replace  $\nu$  by  $\bar{\nu}$  on the right-hand sides.

**10.35 Generating Function and Associated Series**

For  $z \in \mathbb{C}$  and  $t \in \mathbb{C} \setminus \{0\}$ ,

**10.35.1** 
$$e^{\frac{1}{2}z(t+t^{-1})} = \sum_{m=-\infty}^{\infty} t^m I_m(z).$$

For  $z, \theta \in \mathbb{C}$ ,

**10.35.2** 
$$e^{z \cos \theta} = I_0(z) + 2 \sum_{k=1}^{\infty} I_k(z) \cos(k\theta),$$

**10.35.3**

$$e^{z \sin \theta} = I_0(z) + 2 \sum_{k=0}^{\infty} (-1)^k I_{2k+1}(z) \sin((2k+1)\theta) + 2 \sum_{k=1}^{\infty} (-1)^k I_{2k}(z) \cos(2k\theta).$$

**10.35.4**  $1 = I_0(z) - 2I_2(z) + 2I_4(z) - 2I_6(z) + \dots,$

**10.35.5**  $e^{\pm z} = I_0(z) \pm 2I_1(z) + 2I_2(z) \pm 2I_3(z) + \dots,$

**10.35.6**  $\cosh z = I_0(z) + 2I_2(z) + 2I_4(z) + 2I_6(z) + \dots,$   
 $\sinh z = 2I_1(z) + 2I_3(z) + 2I_5(z) + \dots$

**10.36 Other Differential Equations**

The quantity  $\lambda^2$  in (10.13.1)–(10.13.6) and (10.13.8) can be replaced by  $-\lambda^2$  if at the same time the symbol  $\mathcal{C}$  in the given solutions is replaced by  $\mathcal{L}$ . Also,

**10.36.1** 
$$z^2(z^2 + \nu^2)w'' + z(z^2 + 3\nu^2)w' - ((z^2 + \nu^2)^2 + z^2 - \nu^2)w = 0, \quad w = \mathcal{L}'_\nu(z),$$

**10.36.2** 
$$z^2w'' + z(1 \pm 2z)w' + (\pm z - \nu^2)w = 0,$$
  

$$w = e^{\mp z} \mathcal{L}'_\nu(z).$$

Differential equations for products can be obtained from (10.13.9)–(10.13.11) by replacing  $z$  by  $iz$ .

**10.37 Inequalities; Monotonicity**

If  $\nu (\geq 0)$  is fixed, then throughout the interval  $0 < x < \infty$ ,  $I_\nu(x)$  is positive and increasing, and  $K_\nu(x)$  is positive and decreasing.

If  $x (> 0)$  is fixed, then throughout the interval  $0 < \nu < \infty$ ,  $I_\nu(x)$  is decreasing, and  $K_\nu(x)$  is increasing.

For sharper inequalities when the variables are real see Paris (1984) and Laforgia (1991).

If  $0 \leq \nu < \mu$  and  $|\text{ph } z| < \pi$ , then

**10.37.1** 
$$|K_\nu(z)| < |K_\mu(z)|.$$

See also Pal'tsev (1999) and Petropoulou (2000).

**10.38 Derivatives with Respect to Order**

**10.38.1**

$$\frac{\partial I_\nu(z)}{\partial \nu} = I_\nu(z) \ln\left(\frac{1}{2}z\right) - \left(\frac{1}{2}z\right)^\nu \sum_{k=0}^{\infty} \frac{\psi(\nu+k+1)}{\Gamma(\nu+k+1)} \frac{\left(\frac{1}{4}z^2\right)^k}{k!},$$

**10.38.2** 
$$\frac{\partial K_\nu(z)}{\partial \nu} = \frac{1}{2}\pi \csc(\nu\pi) \left( \frac{\partial I_{-\nu}(z)}{\partial \nu} - \frac{\partial I_\nu(z)}{\partial \nu} \right) - \pi \cot(\nu\pi) K_\nu(z), \quad \nu \notin \mathbb{Z}.$$

**Integer Values of  $\nu$**

**10.38.3**

$$(-1)^n \frac{\partial I_\nu(z)}{\partial \nu} \Big|_{\nu=n} = -K_n(z) + \frac{n!}{2\left(\frac{1}{2}z\right)^n} \sum_{k=0}^{n-1} (-1)^k \frac{\left(\frac{1}{2}z\right)^k I_k(z)}{k!(n-k)},$$

**10.38.4** 
$$\frac{\partial K_\nu(z)}{\partial \nu} \Big|_{\nu=n} = \frac{n!}{2\left(\frac{1}{2}z\right)^n} \sum_{k=0}^{n-1} \frac{\left(\frac{1}{2}z\right)^k K_k(z)}{k!(n-k)}.$$

**10.38.5** 
$$\frac{\partial I_\nu(z)}{\partial \nu} \Big|_{\nu=0} = -K_0(z), \quad \frac{\partial K_\nu(z)}{\partial \nu} \Big|_{\nu=0} = 0.$$

**Half-Integer Values of  $\nu$**

For the notations  $E_1$  and  $\text{Ei}$  see §6.2(i). When  $x > 0$ ,

**10.38.6**

$$\frac{\partial I_\nu(x)}{\partial \nu} \Big|_{\nu=\pm\frac{1}{2}} = -\frac{1}{\sqrt{2\pi x}} (E_1(2x)e^x \pm \text{Ei}(2x)e^{-x}),$$

**10.38.7** 
$$\frac{\partial K_\nu(x)}{\partial \nu} \Big|_{\nu=\pm\frac{1}{2}} = \pm \sqrt{\frac{\pi}{2x}} E_1(2x)e^x.$$

For further results see Brychkov and Geddes (2005).

**10.39 Relations to Other Functions**

**Elementary Functions**

**10.39.1**

$$I_{\frac{1}{2}}(z) = \left(\frac{2}{\pi z}\right)^{\frac{1}{2}} \sinh z, \quad I_{-\frac{1}{2}}(z) = \left(\frac{2}{\pi z}\right)^{\frac{1}{2}} \cosh z,$$

**10.39.2** 
$$K_{\frac{1}{2}}(z) = K_{-\frac{1}{2}}(z) = \left(\frac{\pi}{2z}\right)^{\frac{1}{2}} e^{-z}.$$

For these and general results when  $\nu$  is half an odd integer see §§10.47(ii) and 10.49(ii).

**Airy Functions**

See §§9.6(i) and 9.6(ii).

**Parabolic Cylinder Functions**

With the notation of §12.2(i),

$$10.39.3 \quad K_{\frac{1}{4}}(z) = \pi^{\frac{1}{2}} z^{-\frac{1}{4}} U\left(0, 2z^{\frac{1}{2}}\right),$$

10.39.4

$$K_{\frac{3}{4}}(z) = \frac{1}{2} \pi^{\frac{1}{2}} z^{-\frac{3}{4}} \left( \frac{1}{2} U\left(1, 2z^{\frac{1}{2}}\right) + U\left(-1, 2z^{\frac{1}{2}}\right) \right).$$

Principal values on each side of these equations correspond. For these and further results see Miller (1955, pp. 42–43 and 77–79).

**Confluent Hypergeometric Functions**

$$10.39.5 \quad I_{\nu}(z) = \frac{\left(\frac{1}{2}z\right)^{\nu} e^{\pm z}}{\Gamma(\nu+1)} M\left(\nu + \frac{1}{2}, 2\nu + 1, \mp 2z\right),$$

$$10.39.6 \quad K_{\nu}(z) = \pi^{\frac{1}{2}} (2z)^{\nu} e^{-z} U\left(\nu + \frac{1}{2}, 2\nu + 1, 2z\right),$$

10.39.7

$$I_{\nu}(z) = \frac{(2z)^{-\frac{1}{2}} M_{0,\nu}(2z)}{2^{2\nu} \Gamma(\nu+1)}, \quad 2\nu \neq -1, -2, -3, \dots,$$

$$10.39.8 \quad K_{\nu}(z) = \left(\frac{\pi}{2z}\right)^{\frac{1}{2}} W_{0,\nu}(2z).$$

For the functions  $M$ ,  $U$ ,  $M_{0,\nu}$ , and  $W_{0,\nu}$  see §§13.2(i) and 13.14(i).

**Generalized Hypergeometric Functions and Hypergeometric Function**

$$10.39.9 \quad I_{\nu}(z) = \frac{\left(\frac{1}{2}z\right)^{\nu}}{\Gamma(\nu+1)} {}_0F_1\left(-; \nu+1; \frac{1}{4}z^2\right),$$

$$10.39.10 \quad I_{\nu}(z) = \left(\frac{1}{2}z\right)^{\nu} \lim_{\lambda \rightarrow \infty} \mathbf{F}\left(\lambda, \mu; \nu+1; z^2/(4\lambda\mu)\right),$$

as  $\lambda$  and  $\mu \rightarrow \infty$  in  $\mathbb{C}$ , with  $z$  and  $\nu$  fixed. For the functions  ${}_0F_1$  and  $\mathbf{F}$  see (16.2.1) and §15.2(i).

**10.40 Asymptotic Expansions for Large Argument**

**10.40(i) Hankel's Expansions**

With the notation of §§10.17(i) and 10.17(ii), as  $z \rightarrow \infty$  with  $\nu$  fixed,

10.40.1

$$I_{\nu}(z) \sim \frac{e^z}{(2\pi z)^{\frac{1}{2}}} \sum_{k=0}^{\infty} (-1)^k \frac{a_k(\nu)}{z^k}, \quad |\text{ph } z| \leq \frac{1}{2}\pi - \delta,$$

10.40.2

$$K_{\nu}(z) \sim \left(\frac{\pi}{2z}\right)^{\frac{1}{2}} e^{-z} \sum_{k=0}^{\infty} \frac{a_k(\nu)}{z^k}, \quad |\text{ph } z| \leq \frac{3}{2}\pi - \delta,$$

10.40.3

$$I'_{\nu}(z) \sim \frac{e^z}{(2\pi z)^{\frac{1}{2}}} \sum_{k=0}^{\infty} (-1)^k \frac{b_k(\nu)}{z^k}, \quad |\text{ph } z| \leq \frac{1}{2}\pi - \delta,$$

10.40.4

$$K'_{\nu}(z) \sim -\left(\frac{\pi}{2z}\right)^{\frac{1}{2}} e^{-z} \sum_{k=0}^{\infty} \frac{b_k(\nu)}{z^k}, \quad |\text{ph } z| \leq \frac{3}{2}\pi - \delta.$$

Corresponding expansions for  $I_{\nu}(z)$ ,  $K_{\nu}(z)$ ,  $I'_{\nu}(z)$ , and  $K'_{\nu}(z)$  for other ranges of  $\text{ph } z$  are obtainable by combining (10.34.3), (10.34.4), (10.34.6), and their differentiated forms, with (10.40.2) and (10.40.4). In particular, use of (10.34.3) with  $m = 0$  yields the following more general (and more accurate) version of (10.40.1):

$$I_{\nu}(z) \sim \frac{e^z}{(2\pi z)^{\frac{1}{2}}} \sum_{k=0}^{\infty} (-1)^k \frac{a_k(\nu)}{z^k}$$

10.40.5

$$\pm i e^{\pm \nu \pi i} \frac{e^{-z}}{(2\pi z)^{\frac{1}{2}}} \sum_{k=0}^{\infty} \frac{a_k(\nu)}{z^k}, \quad -\frac{1}{2}\pi + \delta \leq \pm \text{ph } z \leq \frac{3}{2}\pi - \delta.$$

**Products**

With  $\mu = 4\nu^2$  and fixed,

10.40.6

$$I_{\nu}(z) K_{\nu}(z) \sim \frac{1}{2z} \left( 1 - \frac{1}{2} \frac{\mu - 1}{(2z)^2} + \frac{1 \cdot 3}{2 \cdot 4} \frac{(\mu - 1)(\mu - 9)}{(2z)^4} - \dots \right),$$

10.40.7

$$I'_{\nu}(z) K'_{\nu}(z) \sim -\frac{1}{2z} \left( 1 + \frac{1}{2} \frac{\mu - 3}{(2z)^2} - \frac{1}{2 \cdot 4} \frac{(\mu - 1)(\mu - 45)}{(2z)^4} + \dots \right),$$

as  $z \rightarrow \infty$  in  $|\text{ph } z| \leq \frac{1}{2}\pi - \delta$ . The general terms in (10.40.6) and (10.40.7) can be written down by analogy with (10.18.17), (10.18.19), and (10.18.20).

**$\nu$ -Derivative**

For fixed  $\nu$ ,

$$10.40.8 \quad \frac{\partial K_{\nu}(z)}{\partial \nu} \sim \left(\frac{\pi}{2z}\right)^{\frac{1}{2}} \frac{\nu e^{-z}}{z} \sum_{k=0}^{\infty} \frac{\alpha_k(\nu)}{(8z)^k},$$

as  $z \rightarrow \infty$  in  $|\text{ph } z| \leq \frac{3}{2}\pi - \delta$ . Here  $\alpha_0(\nu) = 1$  and

10.40.9

$$\alpha_k(\nu) = \frac{(4\nu^2 - 1^2)(4\nu^2 - 3^2) \cdots (4\nu^2 - (2k + 1)^2)}{(k + 1)!} \times \left( \frac{1}{4\nu^2 - 1^2} + \frac{1}{4\nu^2 - 3^2} + \dots + \frac{1}{4\nu^2 - (2k + 1)^2} \right).$$

**10.40(ii) Error Bounds for Real Argument and Order**

In the expansion (10.40.2) assume that  $z > 0$  and the sum is truncated when  $k = \ell - 1$ . Then the remainder term does not exceed the first neglected term in



absolute value and has the same sign provided that  $\ell \geq \max(|\nu| - \frac{1}{2}, 1)$ .

For the error term in (10.40.1) see §10.40(iii).

**10.40(iii) Error Bounds for Complex Argument and Order**

For (10.40.2) write

$$10.40.10 \quad K_\nu(z) = \left(\frac{\pi}{2z}\right)^{\frac{1}{2}} e^{-z} \left(\sum_{k=0}^{\ell-1} \frac{a_k(\nu)}{z^k} + R_\ell(\nu, z)\right),$$

$$\ell = 1, 2, \dots$$

Then

**10.40.11**

$|R_\ell(\nu, z)| \leq 2|a_\ell(\nu)| \mathcal{V}_{z,\infty}(t^{-\ell}) \exp(|\nu^2 - \frac{1}{4}| \mathcal{V}_{z,\infty}(t^{-1}))$ , where  $\mathcal{V}$  denotes the variational operator (§2.3(i)), and the paths of variation are subject to the condition that  $|\Re t|$  changes monotonically. Bounds for  $\mathcal{V}_{z,\infty}(t^{-\ell})$  are given by

**10.40.12**

$$\mathcal{V}_{z,\infty}(t^{-\ell}) \leq \begin{cases} |z|^{-\ell}, & |\text{ph } z| \leq \frac{1}{2}\pi, \\ \chi(\ell)|z|^{-\ell}, & \frac{1}{2}\pi \leq |\text{ph } z| \leq \pi, \\ 2\chi(\ell)|\Re z|^{-\ell}, & \pi \leq |\text{ph } z| \leq \frac{3}{2}\pi, \end{cases}$$

where  $\chi(\ell) = \pi^{\frac{1}{2}} \Gamma(\frac{1}{2}\ell + 1) / \Gamma(\frac{1}{2}\ell + \frac{1}{2})$ ; see §9.7(i).

A similar result for (10.40.1) is obtained by combining (10.34.3), with  $m = 0$ , and (10.40.10)–(10.40.12); see Olver (1997b, p. 269).

**10.40(iv) Exponentially-Improved Expansions**

In (10.40.10)

**10.40.13**

$$R_\ell(\nu, z) = (-1)^\ell 2 \cos(\nu\pi) \times \left(\sum_{k=0}^{m-1} \frac{a_k(\nu)}{z^k} G_{\ell-k}(2z) + R_{m,\ell}(\nu, z)\right),$$

where  $G_p(z)$  is given by (10.17.16). If  $z \rightarrow \infty$  with  $|\ell - 2|z||$  bounded and  $m (\geq 0)$  fixed, then

$$10.40.14 \quad R_{m,\ell}(\nu, z) = O\left(e^{-2|z|} z^{-m}\right), \quad |\text{ph } z| \leq \pi.$$

For higher re-expansions of the remainder term see Olde Daalhuis and Olver (1995a), Olde Daalhuis (1995, 1996), and Paris (2001a,b).

**10.41 Asymptotic Expansions for Large Order**

**10.41(i) Asymptotic Forms**

If  $\nu \rightarrow \infty$  through positive real values with  $z (\neq 0)$  fixed, then

$$10.41.1 \quad I_\nu(z) \sim \frac{1}{\sqrt{2\pi\nu}} \left(\frac{ez}{2\nu}\right)^\nu,$$

$$10.41.2 \quad K_\nu(z) \sim \sqrt{\frac{\pi}{2\nu}} \left(\frac{ez}{2\nu}\right)^{-\nu}.$$

**10.41(ii) Uniform Expansions for Real Variable**

As  $\nu \rightarrow \infty$  through positive real values,

$$10.41.3 \quad I_\nu(\nu z) \sim \frac{e^{\nu\eta}}{(2\pi\nu)^{\frac{1}{2}}(1+z^2)^{\frac{1}{4}}} \sum_{k=0}^{\infty} \frac{U_k(p)}{\nu^k},$$

$$10.41.4 \quad K_\nu(\nu z) \sim \left(\frac{\pi}{2\nu}\right)^{\frac{1}{2}} \frac{e^{-\nu\eta}}{(1+z^2)^{\frac{1}{4}}} \sum_{k=0}^{\infty} (-1)^k \frac{U_k(p)}{\nu^k},$$

$$10.41.5 \quad I'_\nu(\nu z) \sim \frac{(1+z^2)^{\frac{1}{4}} e^{\nu\eta}}{(2\pi\nu)^{\frac{1}{2}} z} \sum_{k=0}^{\infty} \frac{V_k(p)}{\nu^k},$$

**10.41.6**

$$K'_\nu(\nu z) \sim -\left(\frac{\pi}{2\nu}\right)^{\frac{1}{2}} \frac{(1+z^2)^{\frac{1}{4}} e^{-\nu\eta}}{z} \sum_{k=0}^{\infty} (-1)^k \frac{V_k(p)}{\nu^k},$$

uniformly for  $0 < z < \infty$ . Here

$$10.41.7 \quad \eta = (1+z^2)^{\frac{1}{2}} + \ln \frac{z}{1+(1+z^2)^{\frac{1}{2}}},$$

$$10.41.8 \quad p = (1+z^2)^{-\frac{1}{2}},$$

where the branches assume their principal values. Also,  $U_k(p)$  and  $V_k(p)$  are polynomials in  $p$  of degree  $3k$ , given by  $U_0(p) = V_0(p) = 1$ , and

$$10.41.9 \quad U_{k+1}(p) = \frac{1}{2}p^2(1-p^2)U'_k(p) + \frac{1}{8} \int_0^p (1-5t^2)U_k(t) dt,$$

$$V_{k+1}(p) = U_{k+1}(p) - \frac{1}{2}p(1-p^2)U_k(p) - p^2(1-p^2)U'_k(p), \quad k = 0, 1, 2, \dots$$

For  $k = 1, 2, 3$ ,

$$10.41.10 \quad U_1(p) = \frac{1}{24}(3p-5p^3), \quad U_2(p) = \frac{1}{1152}(81p^2-462p^4+385p^6),$$

$$U_3(p) = \frac{1}{414720}(30375p^3-369603p^5+765765p^7-425425p^9),$$

$$10.41.11 \quad V_1(p) = \frac{1}{24}(-9p+7p^3), \quad V_2(p) = \frac{1}{1152}(-135p^2+594p^4-455p^6),$$

$$V_3(p) = \frac{1}{414720}(-42525p^3+451737p^5-883575p^7+475475p^9).$$

For  $U_4(p)$ ,  $U_5(p)$ ,  $U_6(p)$ , see Bickley *et al.* (1952, p. xxxv).

For numerical tables of  $\eta = \eta(z)$  and the coefficients  $U_k(p)$ ,  $V_k(p)$ , see Olver (1962, pp. 43–51).

**10.41(iii) Uniform Expansions for Complex Variable**

The expansions (10.41.3)–(10.41.6) also hold uniformly in the sector  $|\text{ph } z| \leq \frac{1}{2}\pi - \delta$  ( $< \frac{1}{2}\pi$ ), with the branches of the fractional powers in (10.41.3)–(10.41.8) extended by continuity from the positive real  $z$ -axis.

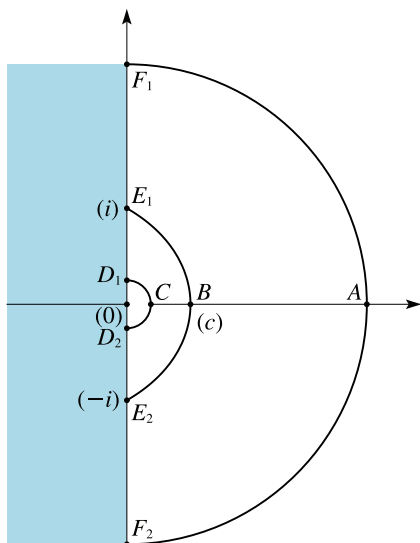


Figure 10.41.1:  $z$ -plane.

Figures 10.41.1 and 10.41.2 show corresponding points of the mapping of the  $z$ -plane and the  $\eta$ -plane. The curve  $E_1BE_2$  in the  $z$ -plane is the upper boundary of the domain  $\mathbf{K}$  depicted in Figure 10.20.3 and rotated through an angle  $-\frac{1}{2}\pi$ . Thus  $B$  is the point  $z = c$ , where  $c$  is given by (10.20.18).

For derivations of the results in this subsection, and also error bounds, see Olver (1997b, pp. 374–378). For extensions of the regions of validity in the  $z$ -plane and extensions to complex values of  $\nu$  see Olver (1997b, pp. 378–382).

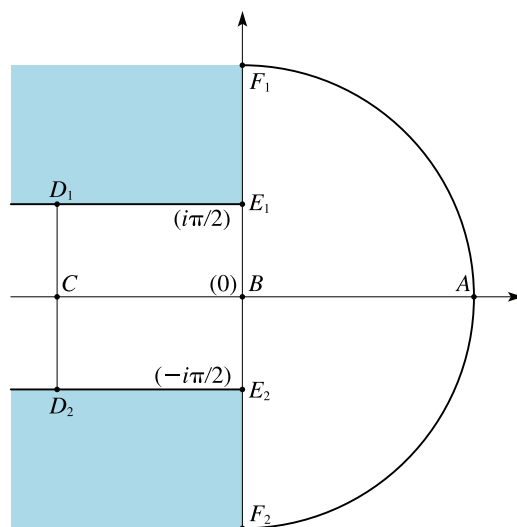


Figure 10.41.2:  $\eta$ -plane.

For expansions in inverse factorial series see Dunster *et al.* (1993).

**10.41(iv) Double Asymptotic Properties**

The series (10.41.3)–(10.41.6) can also be regarded as generalized asymptotic expansions for large  $|z|$ . Thus as  $z \rightarrow \infty$  with  $\ell$  ( $\geq 1$ ) and  $\nu$  ( $> 0$ ) both fixed,

10.41.12

$$I_\nu(\nu z) = \frac{e^{\nu\eta}}{(2\pi\nu)^{\frac{1}{2}}(1+z^2)^{\frac{1}{4}}} \left( \sum_{k=0}^{\ell-1} \frac{U_k(p)}{\nu^k} + O\left(\frac{1}{z^\ell}\right) \right),$$

$$|\text{ph } z| \leq \frac{1}{2}\pi - \delta,$$

$$K_\nu(\nu z) = \left(\frac{\pi}{2\nu}\right)^{\frac{1}{2}} \frac{e^{-\nu\eta}}{(1+z^2)^{\frac{1}{4}}}$$

10.41.13

$$\times \left( \sum_{k=0}^{\ell-1} (-1)^k \frac{U_k(p)}{\nu^k} + O\left(\frac{1}{z^\ell}\right) \right),$$

$$|\text{ph } z| \leq \frac{3}{2}\pi - \delta.$$

Similarly for (10.41.5) and (10.41.6).

In the case of (10.41.13) with positive real values of  $z$  the result is a consequence of the error bounds given in Olver (1997b, pp. 377–378). Then by expanding the quantities  $\eta$ ,  $(1+z^2)^{-\frac{1}{4}}$ , and  $U_k(p)$ ,  $k = 0, 1, \dots, \ell - 1$ , and rearranging, we arrive at an expansion of the right-hand side of (10.41.13) in powers of  $z^{-1}$ . Moreover, because of the uniqueness property of asymptotic expansions (§2.1(iii)) this expansion must agree with (10.40.2), with  $z$  replaced by  $\nu z$ , up to and including the term in  $z^{-(\ell-1)}$ . It also enjoys the same sector of validity.

To establish (10.41.12) we substitute into (10.34.3), with  $m = 0$  and  $z$  replaced by  $\nu z$ , by means of (10.41.13) observing that when  $|z|$  is large the effect of replacing  $z$  by  $ze^{\pm\pi i}$  is to replace  $\eta$ ,  $(1+z^2)^{\frac{1}{4}}$ , and  $p$  by  $-\eta$ ,  $\pm i(1+z^2)^{\frac{1}{4}}$ , and  $-p$ , respectively.

**10.41(v) Double Asymptotic Properties (Continued)**

Similar analysis can be developed for the uniform asymptotic expansions in terms of Airy functions given in §10.20. We first prove that for the expansions (10.20.6) for the Hankel functions  $H_\nu^{(1)}(\nu z)$  and  $H_\nu^{(2)}(\nu z)$  the  $z$ -asymptotic property applies when  $z \rightarrow \pm i\infty$ , respectively. This is a consequence of the error bounds associated with these expansions. We then extend the validity of this property from  $z \rightarrow \pm i\infty$  to  $z \rightarrow \infty$  in the sector  $-\pi + \delta \leq \text{ph } z \leq 2\pi - \delta$  in the case of  $H_\nu^{(1)}(\nu z)$ , and to  $z \rightarrow \infty$  in the sector  $-2\pi + \delta \leq \text{ph } z \leq \pi - \delta$  in the case of  $H_\nu^{(2)}(\nu z)$ . This is done by re-expansion with the aid of (10.20.10), (10.20.11), and §10.41(ii), followed by comparison with (10.17.5) and (10.17.6), with  $z$  replaced by  $\nu z$ . Lastly, we substitute into (10.4.4), again with  $z$  replaced by  $\nu z$ . The final results are:

**10.41.14**

$$J_\nu(\nu z) = \left(\frac{4\zeta}{1-z^2}\right)^{\frac{1}{4}} \left(\frac{\text{Ai}(\nu^{\frac{2}{3}}\zeta)}{\nu^{\frac{1}{3}}} \left(\sum_{k=0}^{\ell} \frac{A_k(\zeta)}{\nu^{2k}} + O\left(\frac{1}{\zeta^{3\ell+3}}\right)\right) + \frac{\text{Ai}'(\nu^{\frac{2}{3}}\zeta)}{\nu^{\frac{5}{3}}} \left(\sum_{k=0}^{\ell-1} \frac{B_k(\zeta)}{\nu^{2k}} + O\left(\frac{1}{\zeta^{3\ell+1}}\right)\right)\right),$$

**10.41.15**

$$Y_\nu(\nu z) = -\left(\frac{4\zeta}{1-z^2}\right)^{\frac{1}{4}} \left(\frac{\text{Bi}(\nu^{\frac{2}{3}}\zeta)}{\nu^{\frac{1}{3}}} \left(\sum_{k=0}^{\ell} \frac{A_k(\zeta)}{\nu^{2k}} + O\left(\frac{1}{\zeta^{3\ell+3}}\right)\right) + \frac{\text{Bi}'(\nu^{\frac{2}{3}}\zeta)}{\nu^{\frac{5}{3}}} \left(\sum_{k=0}^{\ell-1} \frac{B_k(\zeta)}{\nu^{2k}} + O\left(\frac{1}{\zeta^{3\ell+1}}\right)\right)\right),$$

as  $z \rightarrow \infty$  in  $|\text{ph } z| \leq \pi - \delta$ , or equivalently as  $\zeta \rightarrow \infty$  in  $|\text{ph}(-\zeta)| \leq \frac{2}{3}\pi - \delta$ , for fixed  $\ell (\geq 0)$  and fixed  $\nu (> 0)$ .

It needs to be noted that the results (10.41.14) and (10.41.15) do not apply when  $z \rightarrow 0+$  or equivalently  $\zeta \rightarrow +\infty$ . This is because  $A_k(\zeta)$  and  $\zeta^{-\frac{1}{2}}B_k(\zeta), k = 0, 1, \dots$ , do not form an asymptotic scale (§2.1(v)) as  $\zeta \rightarrow +\infty$ ; see Olver (1997b, pp. 422–425).

**10.42 Zeros**

Properties of the zeros of  $I_\nu(z)$  and  $K_\nu(z)$  may be deduced from those of  $J_\nu(z)$  and  $H_\nu^{(1)}(z)$ , respectively, by application of the transformations (10.27.6) and (10.27.8).

For example, if  $\nu$  is real, then the zeros of  $I_\nu(z)$  are all complex unless  $-2\ell < \nu < -(2\ell-1)$  for some positive integer  $\ell$ , in which event  $I_\nu(z)$  has two real zeros.

The distribution of the zeros of  $K_n(nz)$  in the sector  $-\frac{3}{2}\pi \leq \text{ph } z \leq \frac{1}{2}\pi$  in the cases  $n = 1, 5, 10$  is obtained on rotating Figures 10.21.2, 10.21.4, 10.21.6, respectively, through an angle  $-\frac{1}{2}\pi$  so that in each case the cut lies along the positive imaginary axis. The zeros in the sector  $-\frac{1}{2}\pi \leq \text{ph } z \leq \frac{3}{2}\pi$  are their conjugates.

$K_n(z)$  has no zeros in the sector  $|\text{ph } z| \leq \frac{1}{2}\pi$ ; this result remains true when  $n$  is replaced by any real number  $\nu$ . For the number of zeros of  $K_\nu(z)$  in the sector  $|\text{ph } z| \leq \pi$ , when  $\nu$  is real, see Watson (1944, pp. 511–513).

See also Kerimov and Skorokhodov (1984b,a).

**10.43 Integrals**

**10.43(i) Indefinite Integrals**

Let  $\mathcal{Z}_\nu(z)$  be defined as in §10.25(ii). Then

$$10.43.1 \quad \int z^{\nu+1} \mathcal{Z}_\nu(z) dz = z^{\nu+1} \mathcal{Z}_{\nu+1}(z),$$

$$\int z^{-\nu+1} \mathcal{Z}_\nu(z) dz = z^{-\nu+1} \mathcal{Z}_{\nu-1}(z).$$

**10.43.2**

$$\int z^\nu \mathcal{Z}_\nu(z) dz = \pi^{\frac{1}{2}} 2^{\nu-1} \Gamma\left(\nu + \frac{1}{2}\right) z \times (\mathcal{Z}_\nu(z) \mathbf{L}_{\nu-1}(z) - \mathcal{Z}_{\nu-1}(z) \mathbf{L}_\nu(z)), \quad \nu \neq -\frac{1}{2}.$$

For the modified Struve function  $\mathbf{L}_\nu(z)$  see §11.2(i).

**10.43.3**

$$\int e^{\pm z} z^\nu \mathcal{Z}_\nu(z) dz = \frac{e^{\pm z} z^{\nu+1}}{2\nu+1} (\mathcal{Z}_\nu(z) \mp \mathcal{Z}_{\nu+1}(z)), \quad \nu \neq -\frac{1}{2},$$

$$\int e^{\pm z} z^{-\nu} \mathcal{Z}_\nu(z) dz = \frac{e^{\pm z} z^{-\nu+1}}{1-2\nu} (\mathcal{Z}_\nu(z) \mp \mathcal{Z}_{\nu-1}(z)), \quad \nu \neq \frac{1}{2}.$$

**10.43(ii) Integrals over the Intervals (0, x) and (x, ∞)**

**10.43.4**

$$\int_0^x \frac{I_0(t) - 1}{t} dt = \frac{1}{2} \sum_{k=1}^{\infty} (-1)^{k-1} \frac{\psi(k+1) - \psi(1)}{k!} \left(\frac{1}{2}x\right)^k I_k(x) = \frac{2}{x} \sum_{k=0}^{\infty} (-1)^k (2k+3)(\psi(k+2) - \psi(1)) I_{2k+3}(x).$$

**10.43.5**

$$\int_x^\infty \frac{K_0(t)}{t} dt = \frac{1}{2} (\ln(\frac{1}{2}x) + \gamma)^2 + \frac{\pi^2}{24} - \sum_{k=1}^{\infty} \left(\psi(k+1) + \frac{1}{2k} - \ln(\frac{1}{2}x)\right) \frac{(\frac{1}{2}x)^{2k}}{2k(k!)^2},$$

where  $\psi = \Gamma'/\Gamma$  and  $\gamma$  is Euler's constant (§5.2).

**10.43.6**

$$\int_0^x e^{-t} I_n(t) dt = xe^{-x}(I_0(x) + I_1(x)) + n(e^{-x} I_0(x) - 1) + 2e^{-x} \sum_{k=1}^{n-1} (n-k) I_k(x),$$

$$n = 0, 1, 2, \dots$$

**10.43.7**  $\int_0^x e^{\pm t} t^\nu I_\nu(t) dt = \frac{e^{\pm x} x^{\nu+1}}{2\nu+1} (I_\nu(x) \mp I_{\nu+1}(x)),$   
 $\Re\nu > -\frac{1}{2},$

**10.43.8**

$$\int_0^x e^{\pm t} t^{-\nu} I_\nu(t) dt = -\frac{e^{\pm x} x^{-\nu+1}}{2\nu-1} (I_\nu(x) \mp I_{\nu-1}(x)) \mp \frac{2^{-\nu+1}}{(2\nu-1)\Gamma(\nu)}, \quad \nu \neq \frac{1}{2}.$$

**10.43.9**

$$\int_0^x e^{\pm t} t^\nu K_\nu(t) dt = \frac{e^{\pm x} x^{\nu+1}}{2\nu+1} (K_\nu(x) \pm K_{\nu+1}(x)) \mp \frac{2^\nu \Gamma(\nu+1)}{2\nu+1}, \quad \Re\nu > -\frac{1}{2},$$

**10.43.10**

$$\int_x^\infty e^t t^{-\nu} K_\nu(t) dt = \frac{e^x x^{-\nu+1}}{2\nu-1} (K_\nu(x) + K_{\nu-1}(x)),$$

$$\Re\nu > \frac{1}{2}.$$

**10.43(iii) Fractional Integrals**

The *Bickley function*  $Ki_\alpha(x)$  is defined by

**10.43.11**  $Ki_\alpha(x) = \frac{1}{\Gamma(\alpha)} \int_x^\infty (t-x)^{\alpha-1} K_0(t) dt,$

when  $\Re\alpha > 0$  and  $x > 0$ , and by analytic continuation elsewhere. Equivalently,

**10.43.12**  $Ki_\alpha(x) = \int_0^\infty \frac{e^{-x \cosh t}}{(\cosh t)^\alpha} dt, \quad x > 0.$

**Properties**

**10.43.13**  $Ki_\alpha(x) = \int_x^\infty Ki_{\alpha-1}(t) dt,$

**10.43.14**  $Ki_0(x) = K_0(x),$

**10.43.15**  $Ki_{-n}(x) = (-1)^n \frac{d^n}{dx^n} K_0(x), \quad n = 1, 2, 3, \dots$

**10.43.16**  $Ki_\alpha(0) = \frac{\sqrt{\pi} \Gamma(\frac{1}{2}\alpha)}{2\Gamma(\frac{1}{2}\alpha + \frac{1}{2})}, \quad \alpha \neq 0, -2, -4, \dots$

**10.43.17**  $\alpha Ki_{\alpha+1}(x) + x Ki_\alpha(x) + (1-\alpha) Ki_{\alpha-1}(x) - x Ki_{\alpha-2}(x) = 0.$

For further properties of the Bickley function, including asymptotic expansions and generalizations, see Amos (1983, 1989) and Luke (1962, Chapter 8).

**10.43(iv) Integrals over the Interval (0, ∞)**

**10.43.18**  $\int_0^\infty K_\nu(t) dt = \frac{1}{2} \pi \sec(\frac{1}{2}\pi\nu), \quad |\Re\nu| < 1.$

**10.43.19**  $\int_0^\infty t^{\mu-1} K_\nu(t) dt = 2^{\mu-2} \Gamma(\frac{1}{2}\mu - \frac{1}{2}\nu) \Gamma(\frac{1}{2}\mu + \frac{1}{2}\nu),$   
 $|\Re\nu| < \Re\mu.$

**10.43.20**  $\int_0^\infty \cos(at) K_0(t) dt = \frac{\pi}{2(1+a^2)^{\frac{1}{2}}}, \quad |\Im a| < 1,$

**10.43.21**  $\int_0^\infty \sin(at) K_0(t) dt = \frac{\operatorname{arcsinh} a}{(1+a^2)^{\frac{1}{2}}}, \quad |\Im a| < 1.$

When  $\Re\mu > |\Re\nu|,$

---

**10.43.22**  $\int_0^\infty t^{\mu-1} e^{-at} K_\nu(t) dt = \begin{cases} (\frac{1}{2}\pi)^{\frac{1}{2}} \Gamma(\mu-\nu) \Gamma(\mu+\nu) (1-a^2)^{-\frac{1}{2}\mu+\frac{1}{4}} P_{\nu-\frac{1}{2}}^{-\mu+\frac{1}{2}}(a), & -1 < a < 1, \\ (\frac{1}{2}\pi)^{\frac{1}{2}} \Gamma(\mu-\nu) \Gamma(\mu+\nu) (a^2-1)^{-\frac{1}{2}\mu+\frac{1}{4}} P_{\nu-\frac{1}{2}}^{-\mu+\frac{1}{2}}(a), & \Re a \geq 0, a \neq 1. \end{cases}$

For the second equation there is a cut in the  $a$ -plane along the interval  $[0, 1]$ , and all quantities assume their principal values (§4.2(i)). For the Ferrers function  $P$  and the associated Legendre function  $P$ , see §§14.3(i) and 14.21(i).

**10.43.23**  $\int_0^\infty t^{\nu+1} I_\nu(bt) \exp(-p^2 t^2) dt = \frac{b^\nu}{(2p^2)^{\nu+1}} \exp\left(\frac{b^2}{4p^2}\right), \quad \Re\nu > -1, \Re(p^2) > 0,$

**10.43.24**  $\int_0^\infty I_\nu(bt) \exp(-p^2 t^2) dt = \frac{\sqrt{\pi}}{2p} \exp\left(\frac{b^2}{8p^2}\right) I_{\frac{1}{2}\nu}\left(\frac{b^2}{8p^2}\right), \quad \Re\nu > -1, \Re(p^2) > 0,$

**10.43.25**  $\int_0^\infty K_\nu(bt) \exp(-p^2 t^2) dt = \frac{\sqrt{\pi}}{4p} \sec(\frac{1}{2}\pi\nu) \exp\left(\frac{b^2}{8p^2}\right) K_{\frac{1}{2}\nu}\left(\frac{b^2}{8p^2}\right), \quad |\Re\nu| < 1, \Re(p^2) > 0.$

$$\begin{aligned}
 10.43.26 \quad \int_0^\infty \frac{K_\mu(at) J_\nu(bt)}{t^\lambda} dt &= \frac{b^\nu \Gamma(\frac{1}{2}\nu - \frac{1}{2}\lambda + \frac{1}{2}\mu + \frac{1}{2}) \Gamma(\frac{1}{2}\nu - \frac{1}{2}\lambda - \frac{1}{2}\mu + \frac{1}{2})}{2^{\lambda+1} a^{\nu-\lambda+1}} \\
 &\times \mathbf{F}\left(\frac{\nu - \lambda + \mu + 1}{2}, \frac{\nu - \lambda - \mu + 1}{2}; \nu + 1; -\frac{b^2}{a^2}\right), \\
 &\Re(\nu + 1 - \lambda) > |\Re\mu|, \Re a > |\Im b|.
 \end{aligned}$$

For the hypergeometric function  $\mathbf{F}$  see §15.2(i).

$$10.43.27 \quad \int_0^\infty t^{\mu+\nu+1} K_\mu(at) J_\nu(bt) dt = \frac{(2a)^\mu (2b)^\nu \Gamma(\mu + \nu + 1)}{(a^2 + b^2)^{\mu+\nu+1}}, \quad \Re(\nu + 1) > |\Re\mu|, \Re a > |\Im b|.$$

$$10.43.28 \quad \int_0^\infty t \exp(-p^2 t^2) I_\nu(at) I_\nu(bt) dt = \frac{1}{2p^2} \exp\left(\frac{a^2 + b^2}{4p^2}\right) I_\nu\left(\frac{ab}{2p^2}\right), \quad \Re\nu > -1, \Re(p^2) > 0,$$

$$10.43.29 \quad \int_0^\infty t \exp(-p^2 t^2) I_0(at) K_0(bt) dt = \frac{1}{4p^2} \exp\left(\frac{a^2}{2p^2}\right) K_0\left(\frac{a^2}{2p^2}\right), \quad \Re(p^2) > 0.$$

For infinite integrals of triple products of modified and unmodified Bessel functions, see Gervois and Navelet (1984, 1985a,b, 1986a,b).

**10.43(v) Kontorovich–Lebedev Transform**

The *Kontorovich–Lebedev transform* of a function  $g(x)$  is defined as

$$10.43.30 \quad f(y) = \frac{2y}{\pi^2} \sinh(\pi y) \int_0^\infty \frac{g(x)}{x} K_{iy}(x) dx.$$

Then

$$10.43.31 \quad g(x) = \int_0^\infty f(y) K_{iy}(x) dy,$$

provided that either of the following sets of conditions is satisfied:

- (a) On the interval  $0 < x < \infty$ ,  $x^{-1}g(x)$  is continuously differentiable and each of  $xg(x)$  and  $x d(x^{-1}g(x))/dx$  is absolutely integrable.
- (b)  $g(x)$  is piecewise continuous and of bounded variation on every compact interval in  $(0, \infty)$ , and each of the following integrals

$$10.43.32 \quad \int_0^{\frac{1}{2}} \frac{g(x)}{x} \ln\left(\frac{1}{x}\right) dx, \quad \int_{\frac{1}{2}}^\infty \frac{|g(x)|}{x^{\frac{1}{2}}} dx,$$

converges.

For asymptotic expansions of the direct transform (10.43.30) see Wong (1981), and for asymptotic expansions of the inverse transform (10.43.31) see Naylor (1990, 1996).

For collections of the Kontorovich–Lebedev transform, see Erdélyi *et al.* (1954b, Chapter 12), Prudnikov *et al.* (1986b, pp. 404–412), and Oberhettinger (1972, Chapter 5).

**10.43(vi) Compendia**

For collections of integrals of the functions  $I_\nu(z)$  and  $K_\nu(z)$ , including integrals with respect to the order, see

Apelblat (1983, §12), Erdélyi *et al.* (1953b, §§7.7.1–7.7.7 and 7.14–7.14.2), Erdélyi *et al.* (1954a,b), Gradshteyn and Ryzhik (2000, §§5.5, 6.5–6.7), Gröbner and Hofreiter (1950, pp. 197–203), Luke (1962), Magnus *et al.* (1966, §3.8), Marichev (1983, pp. 191–216), Oberhettinger (1972), Oberhettinger (1974, §§1.11 and 2.7), Oberhettinger (1990, §§1.17–1.20 and 2.17–2.20), Oberhettinger and Badii (1973, §§1.15 and 2.13), Okui (1974, 1975), Prudnikov *et al.* (1986b, §§1.11–1.12, 2.15–2.16, 3.2.8–3.2.10, and 3.4.1), Prudnikov *et al.* (1992a, §§3.15, 3.16), Prudnikov *et al.* (1992b, §§3.15, 3.16), Watson (1944, Chapter 13), and Wheelon (1968).

**10.44 Sums**

**10.44(i) Multiplication Theorem**

$$10.44.1 \quad \mathcal{L}_\nu(\lambda z) = \lambda^{\pm\nu} \sum_{k=0}^\infty \frac{(\lambda^2 - 1)^k (\frac{1}{2}z)^k}{k!} \mathcal{L}_{\nu \pm k}(z), \quad |\lambda^2 - 1| < 1.$$

If  $\mathcal{L} = I$  and the upper signs are taken, then the restriction on  $\lambda$  is unnecessary.

**Examples**

**10.44.2**

$$I_\nu(z) = \sum_{k=0}^\infty \frac{z^k}{k!} J_{\nu+k}(z), \quad J_\nu(z) = \sum_{k=0}^\infty (-1)^k \frac{z^k}{k!} I_{\nu+k}(z).$$

**10.44(ii) Addition Theorems**

**Neumann’s Addition Theorem**

**10.44.3**

$$\mathcal{L}_\nu(u \pm v) = \sum_{k=-\infty}^\infty (\pm 1)^k \mathcal{L}_{\nu+k}(u) I_k(v), \quad |v| < |u|.$$

The restriction  $|v| < |u|$  is unnecessary when  $\mathcal{L} = I$  and  $\nu$  is an integer.

**Graf's and Gegenbauer's Addition Theorems**

For results analogous to (10.23.7) and (10.23.8) see Watson (1944, §§11.3 and 11.41).

**10.44(iii) Neumann-Type Expansions**

10.44.4 
$$\left(\frac{1}{2}z\right)^\nu = \sum_{k=0}^{\infty} (-1)^k \frac{(\nu+2k)\Gamma(\nu+k)}{k!} I_{\nu+2k}(z),$$

$$\nu \neq 0, -1, -2, \dots$$

10.44.5 
$$K_0(z) = -(\ln(\frac{1}{2}z) + \gamma) I_0(z) + 2 \sum_{k=1}^{\infty} \frac{I_{2k}(z)}{k},$$

10.44.6 
$$K_n(z) = \frac{n!(\frac{1}{2}z)^{-n}}{2} \sum_{k=0}^{n-1} (-1)^k \frac{(\frac{1}{2}z)^k I_k(z)}{k!(n-k)}$$

$$+ (-1)^{n-1} (\ln(\frac{1}{2}z) - \psi(n+1)) I_n(z)$$

$$+ (-1)^n \sum_{k=1}^{\infty} \frac{(n+2k) I_{n+2k}(z)}{k(n+k)},$$

where  $\gamma$  is Euler's constant and  $\psi = \Gamma'/\Gamma$  (§5.2).

**10.44(iv) Compendia**

For collections of sums and series involving modified Bessel functions see Erdélyi *et al.* (1953b, §7.15), Hansen (1975), and Prudnikov *et al.* (1986b, pp. 691–700).

**10.45 Functions of Imaginary Order**

With  $z = x$ , and  $\nu$  replaced by  $i\nu$ , the modified Bessel's equation (10.25.1) becomes

10.45.1 
$$x^2 \frac{d^2 w}{dx^2} + x \frac{dw}{dx} + (\nu^2 - x^2)w = 0.$$

For  $\nu \in \mathbb{R}$  and  $x \in (0, \infty)$  define

10.45.2 
$$\tilde{I}_\nu(x) = \Re(I_{i\nu}(x)), \quad \tilde{K}_\nu(x) = K_{i\nu}(x).$$

Then

10.45.3 
$$\tilde{I}_{-\nu}(x) = \tilde{I}_\nu(x), \quad \tilde{K}_{-\nu}(x) = \tilde{K}_\nu(x),$$

and  $\tilde{I}_\nu(x)$ ,  $\tilde{K}_\nu(x)$  are real and linearly independent solutions of (10.45.1):

10.45.4 
$$\mathscr{W}\{\tilde{K}_\nu(x), \tilde{I}_\nu(x)\} = 1/x.$$

As  $x \rightarrow +\infty$

10.45.5 
$$\tilde{I}_\nu(x) = (2\pi x)^{-\frac{1}{2}} e^x (1 + O(x^{-1})),$$

$$\tilde{K}_\nu(x) = (\pi/(2x))^{\frac{1}{2}} e^{-x} (1 + O(x^{-1})).$$

As  $x \rightarrow 0+$

10.45.6 
$$\tilde{I}_\nu(x) = \left(\frac{\sinh(\pi\nu)}{\pi\nu}\right)^{\frac{1}{2}} \cos(\nu \ln(\frac{1}{2}x) - \gamma_\nu) + O(x^2),$$

where  $\gamma_\nu$  is as in §10.24. The corresponding result for  $\tilde{K}_\nu(x)$  is given by

**10.45.7**

$$\tilde{K}_\nu(x) = -\left(\frac{\pi}{\nu \sinh(\pi\nu)}\right)^{\frac{1}{2}} \sin(\nu \ln(\frac{1}{2}x) - \gamma_\nu) + O(x^2),$$

when  $\nu > 0$ , and

10.45.8 
$$\tilde{K}_0(x) = K_0(x) = -\ln(\frac{1}{2}x) - \gamma + O(x^2 \ln x),$$

where  $\gamma$  again denotes Euler's constant (§5.2(ii)).

In consequence of (10.45.5)–(10.45.7),  $\tilde{I}_\nu(x)$  and  $\tilde{K}_\nu(x)$  comprise a numerically satisfactory pair of solutions of (10.45.1) when  $x$  is large, and either  $\tilde{I}_\nu(x)$  and  $(1/\pi) \sinh(\pi\nu) \tilde{K}_\nu(x)$ , or  $\tilde{I}_\nu(x)$  and  $\tilde{K}_\nu(x)$ , comprise a numerically satisfactory pair when  $x$  is small, depending whether  $\nu \neq 0$  or  $\nu = 0$ .

For graphs of  $\tilde{I}_\nu(x)$  and  $\tilde{K}_\nu(x)$  see §10.26(iii).

For properties of  $\tilde{I}_\nu(x)$  and  $\tilde{K}_\nu(x)$ , including uniform asymptotic expansions for large  $\nu$  and zeros, see Dunster (1990a). In this reference  $\tilde{I}_\nu(x)$  is denoted by  $(1/\pi) \sinh(\pi\nu) L_{i\nu}(x)$ . See also Gil *et al.* (2003a) and Balogh (1967).

**10.46 Generalized and Incomplete Bessel Functions; Mittag-Leffler Function**

The function  $\phi(\rho, \beta; z)$  is defined by

10.46.1 
$$\phi(\rho, \beta; z) = \sum_{k=0}^{\infty} \frac{z^k}{k! \Gamma(\rho k + \beta)}, \quad \rho > -1.$$

From (10.25.2)

10.46.2 
$$I_\nu(z) = \left(\frac{1}{2}z\right)^\nu \phi(1, \nu + 1; \frac{1}{4}z^2).$$

For asymptotic expansions of  $\phi(\rho, \beta; z)$  as  $z \rightarrow \infty$  in various sectors of the complex  $z$ -plane for fixed real values of  $\rho$  and fixed real or complex values of  $\beta$ , see Wright (1935) when  $\rho > 0$ , and Wright (1940b) when  $-1 < \rho < 0$ . For exponentially-improved asymptotic expansions in the same circumstances, together with smooth interpretations of the corresponding Stokes phenomenon (§§2.11(iii)–2.11(v)) see Wong and Zhao (1999a) when  $\rho > 0$ , and Wong and Zhao (1999b) when  $-1 < \rho < 0$ .

The Laplace transform of  $\phi(\rho, \beta; z)$  can be expressed in terms of the *Mittag-Leffler function*:

10.46.3 
$$E_{a,b}(z) = \sum_{k=0}^{\infty} \frac{z^k}{\Gamma(ak + b)}, \quad a > 0.$$

See Paris (2002c). This reference includes exponentially-improved asymptotic expansions for  $E_{a,b}(z)$  when  $|z| \rightarrow \infty$ , together with a smooth interpretation of Stokes phenomena. See also Wong and Zhao (2002a), and for further information on the Mittag-Leffler function see Erdélyi *et al.* (1955, §18.1) and Paris and Kaminski (2001, §5.1.4).

For incomplete modified Bessel functions and Hankel functions, including applications, see Cicchetti and Faraone (2004).

## Spherical Bessel Functions

### 10.47 Definitions and Basic Properties

#### 10.47(i) Differential Equations

$$10.47.1 \quad z^2 \frac{d^2 w}{dz^2} + 2z \frac{dw}{dz} + (z^2 - n(n+1)) w = 0,$$

$$10.47.2 \quad z^2 \frac{d^2 w}{dz^2} + 2z \frac{dw}{dz} - (z^2 + n(n+1)) w = 0.$$

Here, and throughout the remainder of §§10.47–10.60,  $n$  is a nonnegative integer. (This is in contrast to other treatments of spherical Bessel functions, including Abramowitz and Stegun (1964, Chapter 10), in which  $n$  can be any integer. However, there is a gain in symmetry, without any loss of generality in applications, on restricting  $n \geq 0$ .)

Equations (10.47.1) and (10.47.2) each have a regular singularity at  $z = 0$  with indices  $n$ ,  $-n - 1$ , and an irregular singularity at  $z = \infty$  of rank 1; compare §§2.7(i)–2.7(ii).

#### 10.47(ii) Standard Solutions

##### Equation (10.47.1)

10.47.3

$$j_n(z) = \sqrt{\frac{1}{2}\pi/z} J_{n+\frac{1}{2}}(z) = (-1)^n \sqrt{\frac{1}{2}\pi/z} Y_{-n-\frac{1}{2}}(z),$$

10.47.4

$$y_n(z) = \sqrt{\frac{1}{2}\pi/z} Y_{n+\frac{1}{2}}(z) = (-1)^{n+1} \sqrt{\frac{1}{2}\pi/z} J_{-n-\frac{1}{2}}(z),$$

10.47.5

$$h_n^{(1)}(z) = \sqrt{\frac{1}{2}\pi/z} H_{n+\frac{1}{2}}^{(1)}(z) = (-1)^{n+1} i \sqrt{\frac{1}{2}\pi/z} H_{-n-\frac{1}{2}}^{(1)}(z),$$

10.47.6

$$h_n^{(2)}(z) = \sqrt{\frac{1}{2}\pi/z} H_{n+\frac{1}{2}}^{(2)}(z) = (-1)^n i \sqrt{\frac{1}{2}\pi/z} H_{-n-\frac{1}{2}}^{(2)}(z).$$

$j_n(z)$  and  $y_n(z)$  are the *spherical Bessel functions of the first and second kinds*, respectively;  $h_n^{(1)}(z)$  and  $h_n^{(2)}(z)$  are the *spherical Bessel functions of the third kind*.

##### Equation (10.47.2)

$$10.47.7 \quad i_n^{(1)}(z) = \sqrt{\frac{1}{2}\pi/z} I_{n+\frac{1}{2}}(z)$$

$$10.47.8 \quad i_n^{(2)}(z) = \sqrt{\frac{1}{2}\pi/z} I_{-n-\frac{1}{2}}(z)$$

$$10.47.9 \quad k_n(z) = \sqrt{\frac{1}{2}\pi/z} K_{n+\frac{1}{2}}(z) = \sqrt{\frac{1}{2}\pi/z} K_{-n-\frac{1}{2}}(z).$$

$i_n^{(1)}(z)$ ,  $i_n^{(2)}(z)$ , and  $k_n(z)$  are the *modified spherical Bessel functions*.

Many properties of  $j_n(z)$ ,  $y_n(z)$ ,  $h_n^{(1)}(z)$ ,  $h_n^{(2)}(z)$ ,  $i_n^{(1)}(z)$ ,  $i_n^{(2)}(z)$ , and  $k_n(z)$  follow straightforwardly from the above definitions and results given in preceding sections of this chapter. For example,  $z^{-n} j_n(z)$ ,  $z^{n+1} y_n(z)$ ,  $z^{n+1} h_n^{(1)}(z)$ ,  $z^{n+1} h_n^{(2)}(z)$ ,  $z^{-n} i_n^{(1)}(z)$ ,  $z^{n+1} i_n^{(2)}(z)$ , and  $z^{n+1} k_n(z)$  are all entire functions of  $z$ .

#### 10.47(iii) Numerically Satisfactory Pairs of Solutions

For (10.47.1) numerically satisfactory pairs of solutions are given by Table 10.2.1 with the symbols  $J$ ,  $Y$ ,  $H$ , and  $\nu$  replaced by  $j$ ,  $y$ ,  $h$ , and  $n$ , respectively.

For (10.47.2) numerically satisfactory pairs of solutions are  $i_n^{(1)}(z)$  and  $k_n(z)$  in the right half of the  $z$ -plane, and  $i_n^{(1)}(z)$  and  $k_n(-z)$  in the left half of the  $z$ -plane.

#### 10.47(iv) Interrelations

10.47.10

$$h_n^{(1)}(z) = j_n(z) + i y_n(z), \quad h_n^{(2)}(z) = j_n(z) - i y_n(z).$$

$$10.47.11 \quad k_n(z) = (-1)^{n+1} \frac{1}{2} \pi \left( i_n^{(1)}(z) - i_n^{(2)}(z) \right).$$

$$10.47.12 \quad i_n^{(1)}(z) = i^{-n} j_n(iz), \quad i_n^{(2)}(z) = i^{-n-1} y_n(iz).$$

$$10.47.13 \quad k_n(z) = -\frac{1}{2} \pi i^n h_n^{(1)}(iz) = -\frac{1}{2} \pi i^{-n} h_n^{(2)}(-iz).$$

#### 10.47(v) Reflection Formulas

10.47.14

$$j_n(-z) = (-1)^n j_n(z), \quad y_n(-z) = (-1)^{n+1} y_n(z),$$

10.47.15

$$h_n^{(1)}(-z) = (-1)^n h_n^{(2)}(z), \quad h_n^{(2)}(-z) = (-1)^n h_n^{(1)}(z).$$

10.47.16

$$i_n^{(1)}(-z) = (-1)^n i_n^{(1)}(z), \quad i_n^{(2)}(-z) = (-1)^{n+1} i_n^{(2)}(z),$$

$$10.47.17 \quad k_n(-z) = -\frac{1}{2} \pi \left( i_n^{(1)}(z) + i_n^{(2)}(z) \right).$$

### 10.48 Graphs

For unmodified spherical Bessel functions see Figures 10.48.1–10.48.4. For modified spherical Bessel functions see Figures 10.48.5–10.48.7.

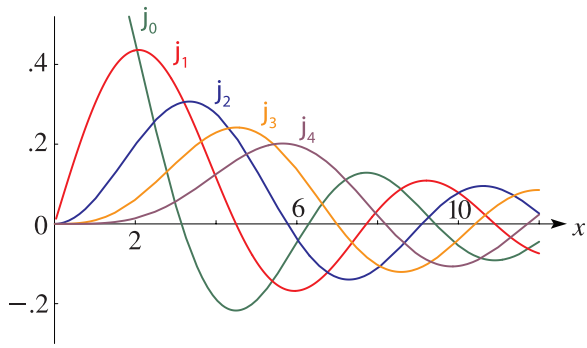


Figure 10.48.1:  $j_n(x), n = 0(1)4, 0 \leq x \leq 12$ .

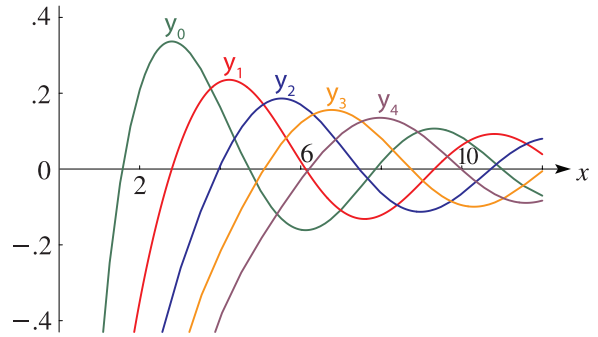


Figure 10.48.2:  $y_n(x), n = 0(1)4, 0 < x \leq 12$ .

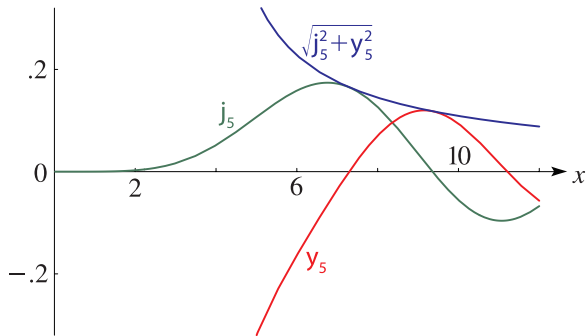


Figure 10.48.3:  $j_5(x), y_5(x), \sqrt{j_5^2(x) + y_5^2(x)}, 0 \leq x \leq 12$ .

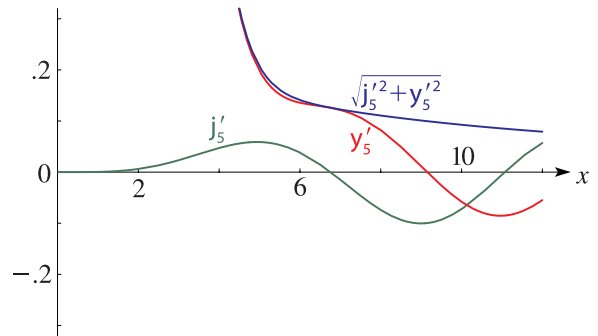


Figure 10.48.4:  $j'_5(x), y'_5(x), \sqrt{j'^2_5(x) + y'^2_5(x)}, 0 \leq x \leq 12$ .

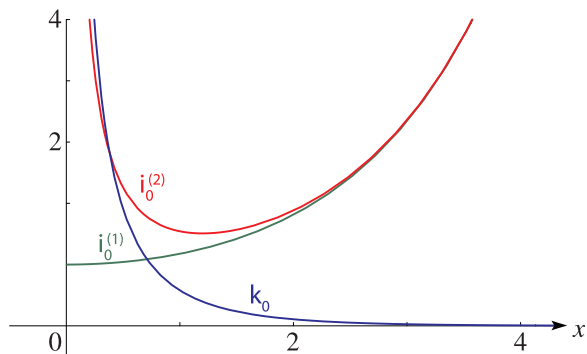


Figure 10.48.5:  $i_0^{(1)}(x), i_0^{(2)}(x), k_0(x), 0 \leq x \leq 4$ .

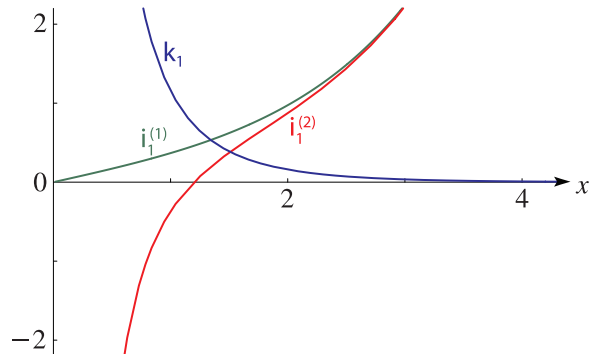


Figure 10.48.6:  $i_1^{(1)}(x), i_1^{(2)}(x), k_1(x), 0 \leq x \leq 4$ .

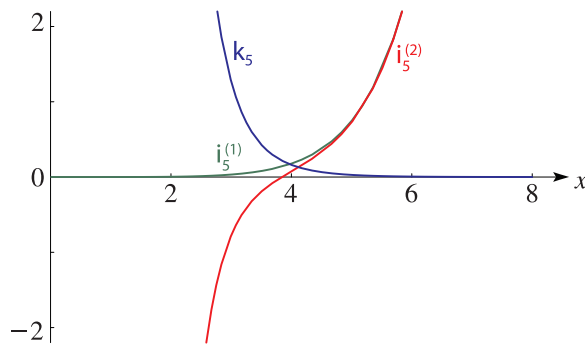


Figure 10.48.7:  $i_5^{(1)}(x), i_5^{(2)}(x), k_5(x), 0 \leq x \leq 8$ .



## 10.49 Explicit Formulas

### 10.49(i) Unmodified Functions

Define  $a_k(\nu)$  as in (10.17.1). Then

10.49.1

$$a_k(n + \frac{1}{2}) = \begin{cases} \frac{(n+k)!}{2^k k! (n-k)!}, & k = 0, 1, \dots, n, \\ 0, & k = n+1, n+2, \dots \end{cases}$$

10.49.2

$$j_n(z) = \sin(z - \frac{1}{2}n\pi) \sum_{k=0}^{\lfloor n/2 \rfloor} (-1)^k \frac{a_{2k}(n + \frac{1}{2})}{z^{2k+1}} \\ + \cos(z - \frac{1}{2}n\pi) \sum_{k=0}^{\lfloor (n-1)/2 \rfloor} (-1)^k \frac{a_{2k+1}(n + \frac{1}{2})}{z^{2k+2}}.$$

10.49.3

$$j_0(z) = \frac{\sin z}{z}, \quad j_1(z) = \frac{\sin z}{z^2} - \frac{\cos z}{z}, \\ j_2(z) = \left(-\frac{1}{z} + \frac{3}{z^3}\right) \sin z - \frac{3}{z^2} \cos z.$$

10.49.4

$$y_n(z) = -\cos(z - \frac{1}{2}n\pi) \sum_{k=0}^{\lfloor n/2 \rfloor} (-1)^k \frac{a_{2k}(n + \frac{1}{2})}{z^{2k+1}} \\ + \sin(z - \frac{1}{2}n\pi) \sum_{k=0}^{\lfloor (n-1)/2 \rfloor} (-1)^k \frac{a_{2k+1}(n + \frac{1}{2})}{z^{2k+2}}.$$

10.49.5

$$y_0(z) = -\frac{\cos z}{z}, \quad y_1(z) = -\frac{\cos z}{z^2} - \frac{\sin z}{z}, \\ y_2(z) = \left(\frac{1}{z} - \frac{3}{z^3}\right) \cos z - \frac{3}{z^2} \sin z.$$

10.49.6

$$h_n^{(1)}(z) = e^{iz} \sum_{k=0}^n i^{k-n-1} \frac{a_k(n + \frac{1}{2})}{z^{k+1}},$$

10.49.7

$$h_n^{(2)}(z) = e^{-iz} \sum_{k=0}^n (-i)^{k-n-1} \frac{a_k(n + \frac{1}{2})}{z^{k+1}}.$$

### 10.49(ii) Modified Functions

Again, with  $a_k(n + \frac{1}{2})$  as in (10.49.1),

10.49.8

$$i_n^{(1)}(z) = \frac{1}{2} e^z \sum_{k=0}^n (-1)^k \frac{a_k(n + \frac{1}{2})}{z^{k+1}} \\ + (-1)^{n+1} \frac{1}{2} e^{-z} \sum_{k=0}^n \frac{a_k(n + \frac{1}{2})}{z^{k+1}}.$$

10.49.9

$$i_0^{(1)}(z) = \frac{\sinh z}{z}, \quad i_1^{(1)}(z) = -\frac{\sinh z}{z^2} + \frac{\cosh z}{z}, \\ i_2^{(1)}(z) = \left(\frac{1}{z} + \frac{3}{z^3}\right) \sinh z - \frac{3}{z^2} \cosh z.$$

$$i_n^{(2)}(z) = \frac{1}{2} e^z \sum_{k=0}^n (-1)^k \frac{a_k(n + \frac{1}{2})}{z^{k+1}}$$

10.49.10

$$+ (-1)^{n+1} \frac{1}{2} e^{-z} \sum_{k=0}^n \frac{a_k(n + \frac{1}{2})}{z^{k+1}}.$$

$$i_0^{(2)}(z) = \frac{\cosh z}{z}, \quad i_1^{(2)}(z) = -\frac{\cosh z}{z^2} + \frac{\sinh z}{z},$$

10.49.11

$$i_2^{(2)}(z) = \left(\frac{1}{z} + \frac{3}{z^3}\right) \cosh z - \frac{3}{z^2} \sinh z.$$

10.49.12

$$k_n(z) = \frac{1}{2} \pi e^{-z} \sum_{k=0}^n \frac{a_k(n + \frac{1}{2})}{z^{k+1}}.$$

$$k_0(z) = \frac{1}{2} \pi \frac{e^{-z}}{z}, \quad k_1(z) = \frac{1}{2} \pi e^{-z} \left(\frac{1}{z} + \frac{1}{z^2}\right),$$

10.49.13

$$k_2(z) = \frac{1}{2} \pi e^{-z} \left(\frac{1}{z} + \frac{3}{z^2} + \frac{3}{z^3}\right).$$

$\sum_{k=0}^n a_k(n + \frac{1}{2}) z^{n-k}$  is sometimes called the *Bessel polynomial of degree n*. For a survey of properties of these polynomials and their generalizations see Grosswald (1978). See also §18.34, de Bruin *et al.* (1981a,b), and Dunster (2001c).

### 10.49(iii) Rayleigh's Formulas

$$j_n(z) = z^n \left(-\frac{1}{z} \frac{d}{dz}\right)^n \frac{\sin z}{z},$$

10.49.14

$$y_n(z) = -z^n \left(-\frac{1}{z} \frac{d}{dz}\right)^n \frac{\cos z}{z}.$$

$$i_n^{(1)}(z) = z^n \left(\frac{1}{z} \frac{d}{dz}\right)^n \frac{\sinh z}{z},$$

10.49.15

$$i_n^{(2)}(z) = z^n \left(\frac{1}{z} \frac{d}{dz}\right)^n \frac{\cosh z}{z}.$$

10.49.16

$$k_n(z) = (-1)^n \frac{1}{2} \pi z^n \left(\frac{1}{z} \frac{d}{dz}\right)^n \frac{e^{-z}}{z}.$$

### 10.49(iv) Sums or Differences of Squares

Denote

$$10.49.17 \quad s_k(n + \frac{1}{2}) = \frac{(2k)!(n+k)!}{2^{2k} (k!)^2 (n-k)!}, \quad k = 0, 1, \dots, n.$$

Then

$$10.49.18 \quad j_n^2(z) + y_n^2(z) = \sum_{k=0}^n \frac{s_k(n + \frac{1}{2})}{z^{2k+2}}.$$

10.49.19

$$j_0^2(z) + y_0^2(z) = z^{-2}, \quad j_1^2(z) + y_1^2(z) = z^{-2} + z^{-4}, \\ j_2^2(z) + y_2^2(z) = z^{-2} + 3z^{-4} + 9z^{-6}.$$

10.49.20

$$\left(i_n^{(1)}(z)\right)^2 - \left(i_n^{(2)}(z)\right)^2 = (-1)^{n+1} \sum_{k=0}^n (-1)^k \frac{s_k(n + \frac{1}{2})}{z^{2k+2}}.$$

10.49.21

$$\begin{aligned} \left(i_0^{(1)}(z)\right)^2 - \left(i_0^{(2)}(z)\right)^2 &= -z^{-2}, \\ \left(i_1^{(1)}(z)\right)^2 - \left(i_1^{(2)}(z)\right)^2 &= z^{-2} - z^{-4}, \\ \left(i_2^{(1)}(z)\right)^2 - \left(i_2^{(2)}(z)\right)^2 &= -z^{-2} + 3z^{-4} - 9z^{-6}. \end{aligned}$$

10.50 Wronskians and Cross-Products

10.50.1  $\mathscr{W}\{j_n(z), y_n(z)\} = z^{-2},$   
 $\mathscr{W}\{h_n^{(1)}(z), h_n^{(2)}(z)\} = -2iz^{-2}.$

10.50.2  $\mathscr{W}\{i_n^{(1)}(z), i_n^{(2)}(z)\} = (-1)^{n+1}z^{-2},$   
 $\mathscr{W}\{i_n^{(1)}(z), k_n(z)\} = \mathscr{W}\{i_n^{(2)}(z), k_n(z)\} = -\frac{1}{2}\pi z^{-2}.$

10.50.3  $j_{n+1}(z)y_n(z) - j_n(z)y_{n+1}(z) = z^{-2},$   
 $j_{n+2}(z)y_n(z) - j_n(z)y_{n+2}(z) = (2n+3)z^{-3}.$

10.50.4  $j_0(z)j_n(z) + y_0(z)y_n(z)$   
 $= \cos\left(\frac{1}{2}n\pi\right) \sum_{k=0}^{\lfloor n/2 \rfloor} (-1)^k \frac{a_{2k}(n + \frac{1}{2})}{z^{2k+2}}$   
 $+ \sin\left(\frac{1}{2}n\pi\right) \sum_{k=0}^{\lfloor (n-1)/2 \rfloor} (-1)^k \frac{a_{2k+1}(n + \frac{1}{2})}{z^{2k+3}},$

where  $a_k(n + \frac{1}{2})$  is given by (10.49.1).

Results corresponding to (10.50.3) and (10.50.4) for  $i_n^{(1)}(z)$  and  $i_n^{(2)}(z)$  are obtainable via (10.47.12).

10.51 Recurrence Relations and Derivatives

10.51(i) Unmodified Functions

Let  $f_n(z)$  denote any of  $j_n(z), y_n(z), h_n^{(1)}(z),$  or  $h_n^{(2)}(z).$  Then

10.51.1  $f_{n-1}(z) + f_{n+1}(z) = ((2n+1)/z)f_n(z),$   
 $nf_{n-1}(z) - (n+1)f_{n+1}(z) = (2n+1)f'_n(z),$   
 $n = 1, 2, \dots,$

10.51.2  $f'_n(z) = f_{n-1}(z) - ((n+1)/z)f_n(z), n = 1, 2, \dots,$   
 $f'_n(z) = -f_{n+1}(z) + (n/z)f_n(z), n = 0, 1, \dots$

10.51.3  $\left(\frac{1}{z} \frac{d}{dz}\right)^m (z^{n+1}f_n(z)) = z^{n-m+1}f_{n-m}(z),$   
 $m = 0, 1, \dots, n,$

10.51.3  $\left(\frac{1}{z} \frac{d}{dz}\right)^m (z^{-n}f_n(z)) = (-1)^m z^{-n-m}f_{n+m}(z),$   
 $m = 0, 1, \dots$

10.51(ii) Modified Functions

Let  $g_n(z)$  denote  $i_n^{(1)}(z), i_n^{(2)}(z),$  or  $(-1)^n k_n(z).$  Then

$g_{n-1}(z) - g_{n+1}(z) = ((2n+1)/z)g_n(z)$   
 10.51.4  $ng_{n-1}(z) + (n+1)g_{n+1}(z) = (2n+1)g'_n(z),$   
 $n = 1, 2, \dots,$

10.51.5  $g'_n(z) = g_{n-1}(z) - ((n+1)/z)g_n(z), n = 1, 2, \dots,$   
 $g'_n(z) = g_{n+1}(z) + (n/z)g_n(z), n = 0, 1, \dots$

$\left(\frac{1}{z} \frac{d}{dz}\right)^m (z^{n+1}g_n(z)) = z^{n-m+1}g_{n-m}(z),$   
 $m = 0, 1, \dots, n,$

10.51.6  $\left(\frac{1}{z} \frac{d}{dz}\right)^m (z^{-n}g_n(z)) = z^{-n-m}g_{n+m}(z),$   
 $m = 0, 1, \dots$

10.52 Limiting Forms

10.52(i)  $z \rightarrow 0$

10.52.1  $j_n(z), i_n^{(1)}(z) \sim z^n/(2n+1)!!,$   
 10.52.2  $-y_n(z), i h_n^{(1)}(z), -i h_n^{(2)}(z), (-1)^n i_n^{(2)}(z), (2/\pi)k_n(z)$   
 $\sim (2n-1)!!/z^{n+1}.$

10.52(ii)  $z \rightarrow \infty$

10.52.3  $j_n(z) = z^{-1} \sin(z - \frac{1}{2}n\pi) + e^{|\Im z|} O(z^{-2}),$   
 $y_n(z) = -z^{-1} \cos(z - \frac{1}{2}n\pi) + e^{|\Im z|} O(z^{-2}),$

10.52.4  $h_n^{(1)}(z) \sim i^{-n-1}z^{-1}e^{iz}, h_n^{(2)}(z) \sim i^{n+1}z^{-1}e^{-iz},$

10.52.5  $i_n^{(1)}(z) \sim i_n^{(2)}(z) \sim \frac{1}{2}z^{-1}e^z, |\text{ph } z| \leq \frac{1}{2}\pi - \delta (< \frac{1}{2}\pi),$

10.52.6  $k_n(z) \sim \frac{1}{2}\pi z^{-1}e^{-z}.$

10.53 Power Series

10.53.1  $j_n(z) = z^n \sum_{k=0}^{\infty} \frac{(-\frac{1}{2}z^2)^k}{k!(2n+2k+1)!!},$   
 $y_n(z) = -\frac{1}{z^{n+1}} \sum_{k=0}^n \frac{(2n-2k-1)!!(\frac{1}{2}z^2)^k}{k!}$   
 10.53.2  $+ \frac{(-1)^{n+1}}{z^{n+1}} \sum_{k=n+1}^{\infty} \frac{(-\frac{1}{2}z^2)^k}{k!(2k-2n-1)!!}.$

$$10.53.3 \quad i_n^{(1)}(z) = z^n \sum_{k=0}^{\infty} \frac{(\frac{1}{2}z^2)^k}{k!(2n+2k+1)!!},$$

$$i_n^{(2)}(z) = \frac{(-1)^n}{z^{n+1}} \sum_{k=0}^n \frac{(2n-2k-1)!!(-\frac{1}{2}z^2)^k}{k!}$$

$$10.53.4 \quad + \frac{1}{z^{n+1}} \sum_{k=n+1}^{\infty} \frac{(\frac{1}{2}z^2)^k}{k!(2k-2n-1)!!}.$$

For  $h_n^{(1)}(z)$  and  $h_n^{(2)}(z)$  combine (10.47.10), (10.53.1), and (10.53.2). For  $k_n(z)$  combine (10.47.11), (10.53.3), and (10.53.4).

### 10.54 Integral Representations

$$10.54.1 \quad j_n(z) = \frac{z^n}{2^{n+1}n!} \int_0^\pi \cos(z \cos \theta) (\sin \theta)^{2n+1} d\theta.$$

$$10.54.2 \quad j_n(z) = \frac{(-i)^n}{2} \int_0^\pi e^{iz \cos \theta} P_n(\cos \theta) \sin \theta d\theta.$$

$$10.54.3 \quad k_n(z) = \frac{\pi}{2} \int_1^\infty e^{-zt} P_n(t) dt, \quad |\text{ph } z| < \frac{1}{2}\pi.$$

$$10.54.4 \quad j_n(z) = \frac{(-i)^{n+1}}{2\pi} \int_{i\infty}^{(-1+,1+)} e^{izt} Q_n(t) dt, \\ |\text{ph } z| < \frac{1}{2}\pi.$$

$$h_n^{(1)}(z) = \frac{(-i)^{n+1}}{\pi} \int_{i\infty}^{(1+)} e^{izt} Q_n(t) dt,$$

$$10.54.5 \quad h_n^{(2)}(z) = \frac{(-i)^{n+1}}{\pi} \int_{i\infty}^{(-1+)} e^{izt} Q_n(t) dt, \\ |\text{ph } z| < \frac{1}{2}\pi.$$

For the Legendre polynomial  $P_n$  and the associated Legendre function  $Q_n$  see §§18.3 and 14.21(i), with  $\mu = 0$  and  $\nu = n$ .

Additional integral representations can be obtained by combining the definitions (10.47.3)–(10.47.9) with the results given in §10.9 and §10.32.

### 10.55 Continued Fractions

For continued fractions for  $j_{n+1}(z)/j_n(z)$  and  $i_{n+1}^{(1)}(z)/i_n^{(1)}(z)$  see Cuyt *et al.* (2008, pp. 350, 353, 362, 363, 367–369).

### 10.56 Generating Functions

When  $2|t| < |z|$ ,

$$10.56.1 \quad \frac{\cos \sqrt{z^2 - 2zt}}{z} = \frac{\cos z}{z} + \sum_{n=1}^{\infty} \frac{t^n}{n!} j_{n-1}(z),$$

$$10.56.2 \quad \frac{\sin \sqrt{z^2 - 2zt}}{z} = \frac{\sin z}{z} + \sum_{n=1}^{\infty} \frac{t^n}{n!} y_{n-1}(z).$$

$$10.56.3 \quad \frac{\cosh \sqrt{z^2 + 2izt}}{z} = \frac{\cosh z}{z} + \sum_{n=1}^{\infty} \frac{(it)^n}{n!} i_{n-1}^{(1)}(z),$$

$$10.56.4 \quad \frac{\sinh \sqrt{z^2 + 2izt}}{z} = \frac{\sinh z}{z} + \sum_{n=1}^{\infty} \frac{(it)^n}{n!} i_{n-1}^{(2)}(z),$$

$$10.56.5 \quad \frac{\exp(-\sqrt{z^2 + 2izt})}{z} = \frac{e^{-z}}{z} + \frac{2}{\pi} \sum_{n=1}^{\infty} \frac{(-it)^n}{n!} k_{n-1}(z).$$

### 10.57 Uniform Asymptotic Expansions for Large Order

Asymptotic expansions for  $j_n((n + \frac{1}{2})z)$ ,  $y_n((n + \frac{1}{2})z)$ ,  $h_n^{(1)}((n + \frac{1}{2})z)$ ,  $h_n^{(2)}((n + \frac{1}{2})z)$ ,  $i_n^{(1)}((n + \frac{1}{2})z)$ , and  $k_n((n + \frac{1}{2})z)$  as  $n \rightarrow \infty$  that are uniform with respect to  $z$  can be obtained from the results given in §§10.20 and 10.41 by use of the definitions (10.47.3)–(10.47.7) and (10.47.9). Subsequently, for  $i_n^{(2)}((n + \frac{1}{2})z)$  the connection formula (10.47.11) is available.

For the corresponding expansion for  $j'_n((n + \frac{1}{2})z)$  use

$$10.57.1 \quad j'_n((n + \frac{1}{2})z) = \frac{\pi^{\frac{1}{2}}}{((2n+1)z)^{\frac{1}{2}}} J'_{n+\frac{1}{2}}((n + \frac{1}{2})z) \\ - \frac{\pi^{\frac{1}{2}}}{((2n+1)z)^{\frac{3}{2}}} J_{n+\frac{1}{2}}((n + \frac{1}{2})z).$$

Similarly for the expansions of the derivatives of the other six functions.

### 10.58 Zeros

For  $n \geq 0$  the  $m$ th positive zeros of  $j_n(x)$ ,  $j'_n(x)$ ,  $y_n(x)$ , and  $y'_n(x)$  are denoted by  $a_{n,m}$ ,  $a'_{n,m}$ ,  $b_{n,m}$ , and  $b'_{n,m}$ , respectively, except that for  $n = 0$  we count  $x = 0$  as the first zero of  $j'_0(x)$ .

With the notation of §10.21(i),

$$10.58.1 \quad a_{n,m} = j_{n+\frac{1}{2},m}, \quad b_{n,m} = y_{n+\frac{1}{2},m},$$

$$j'_n(a_{n,m}) = \sqrt{\frac{\pi}{2j_{n+\frac{1}{2},m}}} J'_{n+\frac{1}{2}}(j_{n+\frac{1}{2},m}),$$

$$10.58.2 \quad y'_n(b_{n,m}) = \sqrt{\frac{\pi}{2y_{n+\frac{1}{2},m}}} Y'_{n+\frac{1}{2}}(y_{n+\frac{1}{2},m}).$$

Hence properties of  $a_{n,m}$  and  $b_{n,m}$  are derivable straightforwardly from results given in §§10.21(i)–10.21(iii), 10.21(vi)–10.21(viii), and 10.21(x). However, there are no simple relations that connect the zeros of the derivatives. For some properties of  $a'_{n,m}$  and  $b'_{n,m}$ , including asymptotic expansions, see Olver (1960, pp. xix–xxi).

See also Davies (1973), de Bruin *et al.* (1981a,b), and Gottlieb (1985).

## 10.59 Integrals

$$10.59.1 \quad \int_{-\infty}^{\infty} e^{ibt} j_n(t) dt = \begin{cases} \pi i^n P_n(b), & -1 < b < 1, \\ \frac{1}{2}\pi(\pm i)^n, & b = \pm 1, \\ 0, & \pm b > 1, \end{cases}$$

where  $P_n$  is the Legendre polynomial (§18.3).

For an integral representation of the Dirac delta in terms of a product of spherical Bessel functions of the first kind see §1.17(ii), and for a generalization see Maximon (1991).

Additional integrals can be obtained by combining the definitions (10.47.3)–(10.47.9) with the results given in §10.22 and §10.43. For integrals of products see also Mehrem *et al.* (1991).

## 10.60 Sums

### 10.60(i) Addition Theorems

Define  $u$ ,  $v$ ,  $w$ , and  $\alpha$  as in §10.23(ii). Then with  $P_n$  again denoting the Legendre polynomial of degree  $n$ ,

$$10.60.1 \quad \frac{\cos w}{w} = -\sum_{n=0}^{\infty} (2n+1) j_n(v) y_n(u) P_n(\cos \alpha),$$

$$|ve^{\pm i\alpha}| < |u|.$$

$$10.60.2 \quad \frac{\sin w}{w} = \sum_{n=0}^{\infty} (2n+1) j_n(v) j_n(u) P_n(\cos \alpha).$$

$$10.60.3 \quad \frac{e^{-w}}{w} = \frac{2}{\pi} \sum_{n=0}^{\infty} (2n+1) i_n^{(1)}(v) k_n(u) P_n(\cos \alpha),$$

$$|ve^{\pm i\alpha}| < |u|.$$

### 10.60(ii) Duplication Formulas

$$10.60.4 \quad j_n(2z) = -n!z^{n+1} \sum_{k=0}^n \frac{2n-2k+1}{k!(2n-k+1)!} j_{n-k}(z) y_{n-k}(z),$$

$$10.60.5 \quad y_n(2z) = n!z^{n+1} \sum_{k=0}^n \frac{n-k+\frac{1}{2}}{k!(2n-k+1)!} (j_{n-k}^2(z) - y_{n-k}^2(z)),$$

$$10.60.6 \quad k_n(2z) = \frac{1}{\pi} n!z^{n+1} \sum_{k=0}^n (-1)^k \frac{2n-2k+1}{k!(2n-k+1)!} k_{n-k}^2(z).$$

### 10.60(iii) Other Series

$$10.60.7 \quad e^{iz \cos \alpha} = \sum_{n=0}^{\infty} (2n+1) i^n j_n(z) P_n(\cos \alpha),$$

$$10.60.8 \quad e^{z \cos \alpha} = \sum_{n=0}^{\infty} (2n+1) i_n^{(1)}(z) P_n(\cos \alpha),$$

$$10.60.9 \quad e^{-z \cos \alpha} = \sum_{n=0}^{\infty} (-1)^n (2n+1) i_n^{(1)}(z) P_n(\cos \alpha).$$

10.60.10

$$J_0(z \sin \alpha) = \sum_{n=0}^{\infty} (4n+1) \frac{(2n)!}{2^{2n}(n!)^2} j_{2n}(z) P_{2n}(\cos \alpha).$$

$$10.60.11 \quad \sum_{n=0}^{\infty} j_n^2(z) = \frac{\text{Si}(2z)}{2z}.$$

For Si see §6.2(ii).

$$10.60.12 \quad \sum_{n=0}^{\infty} (2n+1) j_n^2(z) = 1,$$

$$10.60.13 \quad \sum_{n=0}^{\infty} (-1)^n (2n+1) j_n^2(z) = \frac{\sin(2z)}{2z},$$

$$10.60.14 \quad \sum_{n=0}^{\infty} (2n+1) (j_n'(z))^2 = \frac{1}{3}.$$

For further sums of series of spherical Bessel functions, or modified spherical Bessel functions, see §6.10(ii), Luke (1969b, pp. 55–58), Vavreck and Thompson (1984), Harris (2000), and Rottbrand (2000).

### 10.60(iv) Compendia

For collections of sums of series relevant to spherical Bessel functions or Bessel functions of half odd integer order see Erdélyi *et al.* (1953b, pp. 43–45 and 98–105), Gradshteyn and Ryzhik (2000, §§8.51, 8.53), Hansen (1975), Magnus *et al.* (1966, pp. 106–108 and 123–138), and Prudnikov *et al.* (1986b, pp. 635–637 and 651–700). See also Watson (1944, Chapters 11 and 16).

## Kelvin Functions

### 10.61 Definitions and Basic Properties

#### 10.61(i) Definitions

Throughout §§10.61–§10.71 it is assumed that  $x \geq 0$ ,  $\nu \in \mathbb{R}$ , and  $n$  is a nonnegative integer.

10.61.1

$$\begin{aligned} \text{ber}_{\nu} x + i \text{bei}_{\nu} x &= J_{\nu}(xe^{3\pi i/4}) = e^{\nu\pi i} J_{\nu}(xe^{-\pi i/4}) \\ &= e^{\nu\pi i/2} I_{\nu}(xe^{\pi i/4}) \\ &= e^{3\nu\pi i/2} I_{\nu}(xe^{-3\pi i/4}), \end{aligned}$$

$$\begin{aligned}
 \ker_\nu x + i \operatorname{kei}_\nu x &= e^{-\nu\pi i/2} K_\nu(xe^{\pi i/4}) \\
 10.61.2 \quad &= \frac{1}{2}\pi i H_\nu^{(1)}(xe^{3\pi i/4}) \\
 &= -\frac{1}{2}\pi i e^{-\nu\pi i} H_\nu^{(2)}(xe^{-\pi i/4}).
 \end{aligned}$$

When  $\nu = 0$  suffices on  $\operatorname{ber}$ ,  $\operatorname{bei}$ ,  $\ker$ , and  $\operatorname{kei}$  are usually suppressed.

Most properties of  $\operatorname{ber}_\nu x$ ,  $\operatorname{bei}_\nu x$ ,  $\ker_\nu x$ , and  $\operatorname{kei}_\nu x$  follow straightforwardly from the above definitions and results given in preceding sections of this chapter.

**10.61(ii) Differential Equations**

$$\begin{aligned}
 10.61.3 \quad &x^2 \frac{d^2 w}{dx^2} + x \frac{dw}{dx} - (ix^2 + \nu^2)w = 0, \\
 &w = \operatorname{ber}_\nu x + i \operatorname{bei}_\nu x, \quad \operatorname{ber}_{-\nu} x + i \operatorname{bei}_{-\nu} x \\
 &\quad \operatorname{ker}_\nu x + i \operatorname{kei}_\nu x, \quad \operatorname{ker}_{-\nu} x + i \operatorname{kei}_{-\nu} x. \\
 10.61.4 \quad &x^4 \frac{d^4 w}{dx^4} + 2x^3 \frac{d^3 w}{dx^3} - (1 + 2\nu^2) \left( x^2 \frac{d^2 w}{dx^2} - x \frac{dw}{dx} \right) \\
 &+ (\nu^4 - 4\nu^2 + x^4)w = 0, \\
 &w = \operatorname{ber}_{\pm\nu} x, \operatorname{bei}_{\pm\nu} x, \operatorname{ker}_{\pm\nu} x, \operatorname{kei}_{\pm\nu} x.
 \end{aligned}$$

**10.61(iii) Reflection Formulas for Arguments**

In general, Kelvin functions have a branch point at  $x = 0$  and functions with arguments  $xe^{\pm\pi i}$  are complex. The branch point is absent, however, in the case of  $\operatorname{ber}_\nu$  and  $\operatorname{bei}_\nu$  when  $\nu$  is an integer. In particular,

$$10.61.5 \quad \operatorname{ber}_n(-x) = (-1)^n \operatorname{ber}_n x, \quad \operatorname{bei}_n(-x) = (-1)^n \operatorname{bei}_n x.$$

**10.61(iv) Reflection Formulas for Orders**

$$\begin{aligned}
 &\operatorname{ber}_{-\nu} x = \cos(\nu\pi) \operatorname{ber}_\nu x + \sin(\nu\pi) \operatorname{bei}_\nu x \\
 &\quad + (2/\pi) \sin(\nu\pi) \ker_\nu x, \\
 10.61.6 \quad &\operatorname{bei}_{-\nu} x = -\sin(\nu\pi) \operatorname{ber}_\nu x + \cos(\nu\pi) \operatorname{bei}_\nu x \\
 &\quad + (2/\pi) \sin(\nu\pi) \operatorname{kei}_\nu x.
 \end{aligned}$$

$$\begin{aligned}
 10.61.7 \quad &\ker_{-\nu} x = \cos(\nu\pi) \ker_\nu x - \sin(\nu\pi) \operatorname{kei}_\nu x, \\
 &\operatorname{kei}_{-\nu} x = \sin(\nu\pi) \ker_\nu x + \cos(\nu\pi) \operatorname{kei}_\nu x.
 \end{aligned}$$

$$\begin{aligned}
 10.61.8 \quad &\operatorname{ber}_{-n} x = (-1)^n \operatorname{ber}_n x, \quad \operatorname{bei}_{-n} x = (-1)^n \operatorname{bei}_n x, \\
 &\operatorname{ker}_{-n} x = (-1)^n \operatorname{ker}_n x, \quad \operatorname{kei}_{-n} x = (-1)^n \operatorname{kei}_n x.
 \end{aligned}$$

**10.61(v) Orders  $\pm \frac{1}{2}$**

$$\begin{aligned}
 10.61.9 \quad &\operatorname{ber}_{\frac{1}{2}}(x\sqrt{2}) = \frac{2^{-\frac{3}{4}}}{\sqrt{\pi x}} \left( e^x \cos\left(x + \frac{\pi}{8}\right) \right. \\
 &\quad \left. - e^{-x} \cos\left(x - \frac{\pi}{8}\right) \right), \\
 &\operatorname{bei}_{\frac{1}{2}}(x\sqrt{2}) = \frac{2^{-\frac{3}{4}}}{\sqrt{\pi x}} \left( e^x \sin\left(x + \frac{\pi}{8}\right) \right. \\
 &\quad \left. + e^{-x} \sin\left(x - \frac{\pi}{8}\right) \right).
 \end{aligned}$$

$$\begin{aligned}
 &\operatorname{ber}_{-\frac{1}{2}}(x\sqrt{2}) = \frac{2^{-\frac{3}{4}}}{\sqrt{\pi x}} \left( e^x \sin\left(x + \frac{\pi}{8}\right) \right. \\
 &\quad \left. - e^{-x} \sin\left(x - \frac{\pi}{8}\right) \right), \\
 10.61.10 \quad &\operatorname{bei}_{-\frac{1}{2}}(x\sqrt{2}) = -\frac{2^{-\frac{3}{4}}}{\sqrt{\pi x}} \left( e^x \cos\left(x + \frac{\pi}{8}\right) \right. \\
 &\quad \left. + e^{-x} \cos\left(x - \frac{\pi}{8}\right) \right).
 \end{aligned}$$

$$\begin{aligned}
 10.61.11 \quad &\ker_{\frac{1}{2}}(x\sqrt{2}) = \operatorname{kei}_{-\frac{1}{2}}(x\sqrt{2}) \\
 &= -2^{-\frac{3}{4}} \sqrt{\frac{\pi}{x}} e^{-x} \sin\left(x - \frac{\pi}{8}\right), \\
 &\operatorname{kei}_{\frac{1}{2}}(x\sqrt{2}) = -\ker_{-\frac{1}{2}}(x\sqrt{2}) \\
 10.61.12 \quad &= -2^{-\frac{3}{4}} \sqrt{\frac{\pi}{x}} e^{-x} \cos\left(x - \frac{\pi}{8}\right).
 \end{aligned}$$

**10.62 Graphs**

See Figures 10.62.1–10.62.4. For the modulus functions  $M(x)$  and  $N(x)$  see §10.68(i) with  $\nu = 0$ .

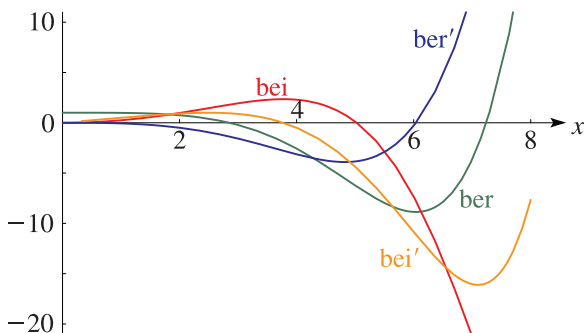


Figure 10.62.1:  $\operatorname{ber} x, \operatorname{bei} x, \operatorname{ber}' x, \operatorname{bei}' x, 0 \leq x \leq 8$ .

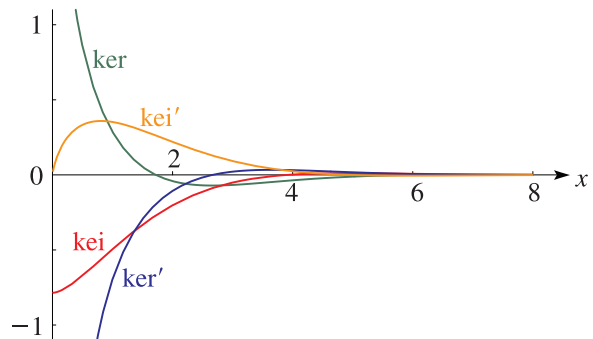


Figure 10.62.2:  $\ker x, \operatorname{kei} x, \ker' x, \operatorname{kei}' x, 0 \leq x \leq 8$ .

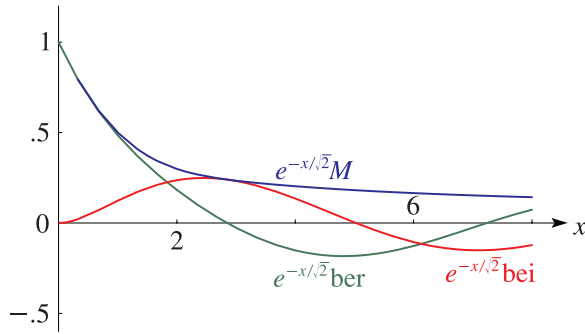


Figure 10.62.3:  $e^{-x/\sqrt{2}} \text{ber } x$ ,  $e^{-x/\sqrt{2}} \text{bei } x$ ,  $e^{-x/\sqrt{2}} M(x)$ ,  $0 \leq x \leq 8$ .

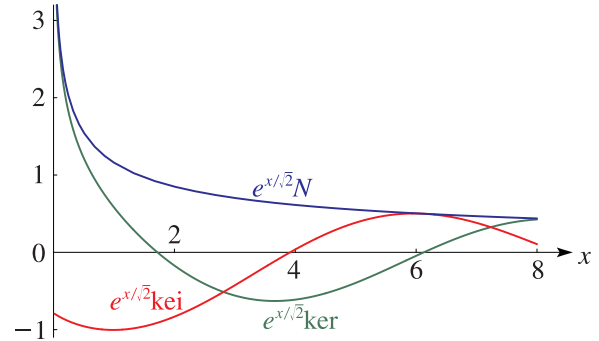


Figure 10.62.4:  $e^{x/\sqrt{2}} \text{ker } x$ ,  $e^{x/\sqrt{2}} \text{kei } x$ ,  $e^{x/\sqrt{2}} N(x)$ ,  $0 \leq x \leq 8$ .

### 10.63 Recurrence Relations and Derivatives

#### 10.63(i) $\text{ber}_\nu x$ , $\text{bei}_\nu x$ , $\text{ker}_\nu x$ , $\text{kei}_\nu x$

Let  $f_\nu(x)$ ,  $g_\nu(x)$  denote any one of the ordered pairs:

- 10.63.1  $\text{ber}_\nu x, \text{bei}_\nu x$ ;  $\text{bei}_\nu x, -\text{ber}_\nu x$ ;  
 $\text{ker}_\nu x, \text{kei}_\nu x$ ;  $\text{kei}_\nu x, -\text{ker}_\nu x$ .

Then

- 10.63.2  $f_{\nu-1}(x) + f_{\nu+1}(x) = -(\nu\sqrt{2}/x)(f_\nu(x) - g_\nu(x))$ ,  
 $f_{\nu+1}(x) + g_{\nu+1}(x) - f_{\nu-1}(x) - g_{\nu-1}(x) = 2\sqrt{2}f'_\nu(x)$ ,  
 $f'_\nu(x) = -(1/\sqrt{2})(f_{\nu-1}(x) + g_{\nu-1}(x)) - (\nu/x)f_\nu(x)$ ,  
 $f'_\nu(x) = (1/\sqrt{2})(f_{\nu+1}(x) + g_{\nu+1}(x)) + (\nu/x)f_\nu(x)$ .

- 10.63.3  $\sqrt{2} \text{ber}' x = \text{ber}_1 x + \text{bei}_1 x$ ,  
 $\sqrt{2} \text{bei}' x = -\text{ber}_1 x + \text{bei}_1 x$ .

- 10.63.4  $\sqrt{2} \text{ker}' x = \text{ker}_1 x + \text{kei}_1 x$ ,  
 $\sqrt{2} \text{kei}' x = -\text{ker}_1 x + \text{kei}_1 x$ .

#### 10.63(ii) Cross-Products

Let

- 10.63.5  $p_\nu = \text{ber}_\nu^2 x + \text{bei}_\nu^2 x$ ,  $q_\nu = \text{ber}_\nu x \text{bei}'_\nu x - \text{ber}'_\nu x \text{bei}_\nu x$ ,  
 $r_\nu = \text{ber}_\nu x \text{ber}'_\nu x + \text{bei}_\nu x \text{bei}'_\nu x$ ,  
 $s_\nu = (\text{ber}'_\nu x)^2 + (\text{bei}'_\nu x)^2$ .

Then

- 10.63.6  $p_{\nu+1} = p_{\nu-1} - (4\nu/x)r_\nu$ ,  
 $q_{\nu+1} = -(\nu/x)p_\nu + r_\nu = -q_{\nu-1} + 2r_\nu$ ,  
 $r_{\nu+1} = -((\nu+1)/x)p_{\nu+1} + q_\nu$ ,  
 $s_\nu = \frac{1}{2}p_{\nu+1} + \frac{1}{2}p_{\nu-1} - (\nu^2/x^2)p_\nu$ ,

and

10.63.7  $p_\nu s_\nu = r_\nu^2 + q_\nu^2$ .

Equations (10.63.6) and (10.63.7) also hold when the symbols ber and bei in (10.63.5) are replaced throughout by ker and kei, respectively.

### 10.64 Integral Representations

#### Schlöfli-Type Integrals

10.64.1  $\text{ber}_n(x\sqrt{2}) = \frac{(-1)^n}{\pi} \int_0^\pi \cos(x \sin t - nt) \cosh(x \sin t) dt$ ,

10.64.2  $\text{bei}_n(x\sqrt{2}) = \frac{(-1)^n}{\pi} \int_0^\pi \sin(x \sin t - nt) \sinh(x \sin t) dt$ .

See Apelblat (1991) for these results, and also for similar representations for  $\text{ber}_\nu(x\sqrt{2})$ ,  $\text{bei}_\nu(x\sqrt{2})$ , and their  $\nu$ -derivatives.

### 10.65 Power Series

#### 10.65(i) $\text{ber}_\nu x$ and $\text{bei}_\nu x$

10.65.1  $\text{ber}_\nu x = (\frac{1}{2}x)^\nu \sum_{k=0}^\infty \frac{\cos(\frac{3}{4}\nu\pi + \frac{1}{2}k\pi)}{k! \Gamma(\nu + k + 1)} (\frac{1}{4}x^2)^k$ ,

$\text{bei}_\nu x = (\frac{1}{2}x)^\nu \sum_{k=0}^\infty \frac{\sin(\frac{3}{4}\nu\pi + \frac{1}{2}k\pi)}{k! \Gamma(\nu + k + 1)} (\frac{1}{4}x^2)^k$ .

10.65.2  $\text{ber } x = 1 - \frac{(\frac{1}{4}x^2)^2}{(2!)^2} + \frac{(\frac{1}{4}x^2)^4}{(4!)^2} - \dots$ ,

$\text{bei } x = \frac{1}{4}x^2 - \frac{(\frac{1}{4}x^2)^3}{(3!)^2} + \frac{(\frac{1}{4}x^2)^5}{(5!)^2} - \dots$ .

**10.65(ii)  $\ker_\nu x$  and  $\text{kei}_\nu x$** 

When  $\nu$  is not an integer combine (10.65.1) with (10.61.6). Also, with  $\psi(x) = \Gamma'(x)/\Gamma(x)$ ,

$$\begin{aligned} \ker_n x &= \frac{1}{2} \left(\frac{1}{2}x\right)^{-n} \sum_{k=0}^{n-1} \frac{(n-k-1)!}{k!} \cos\left(\frac{3}{4}n\pi + \frac{1}{2}k\pi\right) \left(\frac{1}{4}x^2\right)^k - \ln\left(\frac{1}{2}x\right) \text{ber}_n x \\ &+ \frac{1}{4}\pi \text{bei}_n x + \frac{1}{2} \left(\frac{1}{2}x\right)^n \sum_{k=0}^{\infty} \frac{\psi(k+1) + \psi(n+k+1)}{k!(n+k)!} \cos\left(\frac{3}{4}n\pi + \frac{1}{2}k\pi\right) \left(\frac{1}{4}x^2\right)^k, \end{aligned}$$

10.65.3

$$\begin{aligned} \text{kei}_n x &= -\frac{1}{2} \left(\frac{1}{2}x\right)^{-n} \sum_{k=0}^{n-1} \frac{(n-k-1)!}{k!} \sin\left(\frac{3}{4}n\pi + \frac{1}{2}k\pi\right) \left(\frac{1}{4}x^2\right)^k - \ln\left(\frac{1}{2}x\right) \text{bei}_n x \\ &- \frac{1}{4}\pi \text{ber}_n x + \frac{1}{2} \left(\frac{1}{2}x\right)^n \sum_{k=0}^{\infty} \frac{\psi(k+1) + \psi(n+k+1)}{k!(n+k)!} \sin\left(\frac{3}{4}n\pi + \frac{1}{2}k\pi\right) \left(\frac{1}{4}x^2\right)^k. \end{aligned}$$

10.65.4

$$\begin{aligned} \ker x &= -\ln\left(\frac{1}{2}x\right) \text{ber } x + \frac{1}{4}\pi \text{bei } x + \sum_{k=0}^{\infty} (-1)^k \frac{\psi(2k+1)}{((2k)!)^2} \left(\frac{1}{4}x^2\right)^{2k}, \\ \text{kei } x &= -\ln\left(\frac{1}{2}x\right) \text{bei } x - \frac{1}{4}\pi \text{ber } x + \sum_{k=0}^{\infty} (-1)^k \frac{\psi(2k+2)}{((2k+1)!)^2} \left(\frac{1}{4}x^2\right)^{2k+1}. \end{aligned}$$

10.65.5

**10.65(iii) Cross-Products and Sums of Squares**

$$\text{ber}_\nu^2 x + \text{bei}_\nu^2 x = \left(\frac{1}{2}x\right)^{2\nu} \sum_{k=0}^{\infty} \frac{1}{\Gamma(\nu+k+1)\Gamma(\nu+2k+1)} \frac{\left(\frac{1}{4}x^2\right)^{2k}}{k!},$$

10.65.6

$$\text{ber}_\nu x \text{bei}'_\nu x - \text{ber}'_\nu x \text{bei}_\nu x = \left(\frac{1}{2}x\right)^{2\nu+1} \sum_{k=0}^{\infty} \frac{1}{\Gamma(\nu+k+1)\Gamma(\nu+2k+2)} \frac{\left(\frac{1}{4}x^2\right)^{2k}}{k!},$$

10.65.7

$$\text{ber}_\nu x \text{ber}'_\nu x + \text{bei}_\nu x \text{bei}'_\nu x = \frac{1}{2} \left(\frac{1}{2}x\right)^{2\nu-1} \sum_{k=0}^{\infty} \frac{1}{\Gamma(\nu+k+1)\Gamma(\nu+2k)} \frac{\left(\frac{1}{4}x^2\right)^{2k}}{k!},$$

10.65.8

$$\left(\text{ber}'_\nu x\right)^2 + \left(\text{bei}'_\nu x\right)^2 = \left(\frac{1}{2}x\right)^{2\nu-2} \sum_{k=0}^{\infty} \frac{2k^2 + 2\nu k + \frac{1}{4}\nu^2}{\Gamma(\nu+k+1)\Gamma(\nu+2k+1)} \frac{\left(\frac{1}{4}x^2\right)^{2k}}{k!}.$$

10.65.9

**10.65(iv) Compendia**

For further power series summable in terms of Kelvin functions and their derivatives see Hansen (1975).

**10.66 Expansions in Series of Bessel Functions**

$$\text{ber}_\nu x + i \text{bei}_\nu x = \sum_{k=0}^{\infty} \frac{e^{(3\nu+k)\pi i/4} x^k J_{\nu+k}(x)}{2^{k/2} k!} = \sum_{k=0}^{\infty} \frac{e^{(3\nu+3k)\pi i/4} x^k I_{\nu+k}(x)}{2^{k/2} k!}.$$

10.66.1

$$\text{ber}_n(x\sqrt{2}) = \sum_{k=-\infty}^{\infty} (-1)^{n+k} J_{n+2k}(x) I_{2k}(x), \quad \text{bei}_n(x\sqrt{2}) = \sum_{k=-\infty}^{\infty} (-1)^{n+k} J_{n+2k+1}(x) I_{2k+1}(x).$$

10.66.2

### 10.67 Asymptotic Expansions for Large Argument

#### 10.67(i) $\text{ber}_\nu x$ , $\text{bei}_\nu x$ , $\text{ker}_\nu x$ , $\text{kei}_\nu x$ , and Derivatives

Define  $a_k(\nu)$  and  $b_k(\nu)$  as in §§10.17(i) and 10.17(ii). Then as  $x \rightarrow \infty$  with  $\nu$  fixed,

$$10.67.1 \quad \text{ker}_\nu x \sim e^{-x/\sqrt{2}} \left(\frac{\pi}{2x}\right)^{\frac{1}{2}} \sum_{k=0}^{\infty} \frac{a_k(\nu)}{x^k} \cos\left(\frac{x}{\sqrt{2}} + \left(\frac{\nu}{2} + \frac{k}{4} + \frac{1}{8}\right)\pi\right),$$

$$10.67.2 \quad \text{kei}_\nu x \sim -e^{-x/\sqrt{2}} \left(\frac{\pi}{2x}\right)^{\frac{1}{2}} \sum_{k=0}^{\infty} \frac{a_k(\nu)}{x^k} \sin\left(\frac{x}{\sqrt{2}} + \left(\frac{\nu}{2} + \frac{k}{4} + \frac{1}{8}\right)\pi\right).$$

$$10.67.3 \quad \text{ber}_\nu x \sim \frac{e^{x/\sqrt{2}}}{(2\pi x)^{\frac{1}{2}}} \sum_{k=0}^{\infty} \frac{a_k(\nu)}{x^k} \cos\left(\frac{x}{\sqrt{2}} + \left(\frac{\nu}{2} + \frac{3k}{4} - \frac{1}{8}\right)\pi\right) - \frac{1}{\pi}(\sin(2\nu\pi) \text{ker}_\nu x + \cos(2\nu\pi) \text{kei}_\nu x),$$

$$10.67.4 \quad \text{bei}_\nu x \sim \frac{e^{x/\sqrt{2}}}{(2\pi x)^{\frac{1}{2}}} \sum_{k=0}^{\infty} \frac{a_k(\nu)}{x^k} \sin\left(\frac{x}{\sqrt{2}} + \left(\frac{\nu}{2} + \frac{3k}{4} - \frac{1}{8}\right)\pi\right) + \frac{1}{\pi}(\cos(2\nu\pi) \text{ker}_\nu x - \sin(2\nu\pi) \text{kei}_\nu x).$$

$$10.67.5 \quad \text{ker}'_\nu x \sim -e^{-x/\sqrt{2}} \left(\frac{\pi}{2x}\right)^{\frac{1}{2}} \sum_{k=0}^{\infty} \frac{b_k(\nu)}{x^k} \cos\left(\frac{x}{\sqrt{2}} + \left(\frac{\nu}{2} + \frac{k}{4} - \frac{1}{8}\right)\pi\right),$$

$$10.67.6 \quad \text{kei}'_\nu x \sim e^{-x/\sqrt{2}} \left(\frac{\pi}{2x}\right)^{\frac{1}{2}} \sum_{k=0}^{\infty} \frac{b_k(\nu)}{x^k} \sin\left(\frac{x}{\sqrt{2}} + \left(\frac{\nu}{2} + \frac{k}{4} - \frac{1}{8}\right)\pi\right).$$

$$10.67.7 \quad \text{ber}'_\nu x \sim \frac{e^{x/\sqrt{2}}}{(2\pi x)^{\frac{1}{2}}} \sum_{k=0}^{\infty} \frac{b_k(\nu)}{x^k} \cos\left(\frac{x}{\sqrt{2}} + \left(\frac{\nu}{2} + \frac{3k}{4} + \frac{1}{8}\right)\pi\right) - \frac{1}{\pi}(\sin(2\nu\pi) \text{ker}'_\nu x + \cos(2\nu\pi) \text{kei}'_\nu x),$$

$$10.67.8 \quad \text{bei}'_\nu x \sim \frac{e^{x/\sqrt{2}}}{(2\pi x)^{\frac{1}{2}}} \sum_{k=0}^{\infty} \frac{b_k(\nu)}{x^k} \sin\left(\frac{x}{\sqrt{2}} + \left(\frac{\nu}{2} + \frac{3k}{4} + \frac{1}{8}\right)\pi\right) + \frac{1}{\pi}(\cos(2\nu\pi) \text{ker}'_\nu x - \sin(2\nu\pi) \text{kei}'_\nu x).$$

The contributions of the terms in  $\text{ker}_\nu x$ ,  $\text{kei}_\nu x$ ,  $\text{ker}'_\nu x$ , and  $\text{kei}'_\nu x$  on the right-hand sides of (10.67.3), (10.67.4), (10.67.7), and (10.67.8) are exponentially small compared with the other terms, and hence can be neglected in the sense of Poincaré asymptotic expansions (§2.1(iii)). However, their inclusion improves numerical accuracy.

#### 10.67(ii) Cross-Products and Sums of Squares in the Case $\nu = 0$

As  $x \rightarrow \infty$

$$10.67.9 \quad \text{ber}^2 x + \text{bei}^2 x \sim \frac{e^{x\sqrt{2}}}{2\pi x} \left(1 + \frac{1}{4\sqrt{2}} \frac{1}{x} + \frac{1}{64} \frac{1}{x^2} - \frac{33}{256\sqrt{2}} \frac{1}{x^3} - \frac{1797}{8192} \frac{1}{x^4} + \cdots\right),$$

$$10.67.10 \quad \text{ber } x \text{ bei}' x - \text{ber}' x \text{ bei } x \sim \frac{e^{x\sqrt{2}}}{2\pi x} \left(\frac{1}{\sqrt{2}} + \frac{11}{8} \frac{1}{x} + \frac{9}{64\sqrt{2}} \frac{1}{x^2} + \frac{39}{512} \frac{1}{x^3} + \frac{75}{8192\sqrt{2}} \frac{1}{x^4} + \cdots\right),$$

$$10.67.11 \quad \text{ber } x \text{ ber}' x + \text{bei } x \text{ bei}' x \sim \frac{e^{x\sqrt{2}}}{2\pi x} \left(\frac{1}{\sqrt{2}} - \frac{3}{8} \frac{1}{x} - \frac{15}{64\sqrt{2}} \frac{1}{x^2} - \frac{45}{512} \frac{1}{x^3} + \frac{315}{8192\sqrt{2}} \frac{1}{x^4} + \cdots\right),$$

$$10.67.12 \quad (\text{ber}' x)^2 + (\text{bei}' x)^2 \sim \frac{e^{x\sqrt{2}}}{2\pi x} \left(1 - \frac{3}{4\sqrt{2}} \frac{1}{x} + \frac{9}{64} \frac{1}{x^2} + \frac{75}{256\sqrt{2}} \frac{1}{x^3} + \frac{2475}{8192} \frac{1}{x^4} + \cdots\right).$$

$$10.67.13 \quad \text{ker}^2 x + \text{kei}^2 x \sim \frac{\pi}{2x} e^{-x\sqrt{2}} \left(1 - \frac{1}{4\sqrt{2}} \frac{1}{x} + \frac{1}{64} \frac{1}{x^2} + \frac{33}{256\sqrt{2}} \frac{1}{x^3} - \frac{1797}{8192} \frac{1}{x^4} + \cdots\right),$$

$$10.67.14 \quad \text{ker } x \text{ kei}' x - \text{ker}' x \text{ kei } x \sim -\frac{\pi}{2x} e^{-x\sqrt{2}} \left(\frac{1}{\sqrt{2}} - \frac{11}{8} \frac{1}{x} + \frac{9}{64\sqrt{2}} \frac{1}{x^2} - \frac{39}{512} \frac{1}{x^3} + \frac{75}{8192\sqrt{2}} \frac{1}{x^4} + \cdots\right),$$

$$10.67.15 \quad \text{ker } x \text{ ker}' x + \text{kei } x \text{ kei}' x \sim -\frac{\pi}{2x} e^{-x\sqrt{2}} \left(\frac{1}{\sqrt{2}} + \frac{3}{8} \frac{1}{x} - \frac{15}{64\sqrt{2}} \frac{1}{x^2} + \frac{45}{512} \frac{1}{x^3} + \frac{315}{8192\sqrt{2}} \frac{1}{x^4} + \cdots\right),$$

$$10.67.16 \quad (\text{ker}' x)^2 + (\text{kei}' x)^2 \sim \frac{\pi}{2x} e^{-x\sqrt{2}} \left(1 + \frac{3}{4\sqrt{2}} \frac{1}{x} + \frac{9}{64} \frac{1}{x^2} - \frac{75}{256\sqrt{2}} \frac{1}{x^3} + \frac{2475}{8192} \frac{1}{x^4} + \cdots\right).$$



## 10.68 Modulus and Phase Functions

### 10.68(i) Definitions

$$10.68.1 \quad M_\nu(x)e^{i\theta_\nu(x)} = \text{ber}_\nu x + i \text{bei}_\nu x,$$

$$10.68.2 \quad N_\nu(x)e^{i\phi_\nu(x)} = \text{ker}_\nu x + i \text{kei}_\nu x,$$

where  $M_\nu(x) (> 0)$ ,  $N_\nu(x) (> 0)$ ,  $\theta_\nu(x)$ , and  $\phi_\nu(x)$  are continuous real functions of  $x$  and  $\nu$ , with the branches of  $\theta_\nu(x)$  and  $\phi_\nu(x)$  chosen to satisfy (10.68.18) and (10.68.21) as  $x \rightarrow \infty$ . (See also §10.68(iv).)

### 10.68(ii) Basic Properties

$$10.68.3 \quad \text{ber}_\nu x = M_\nu(x) \cos \theta_\nu(x), \quad \text{bei}_\nu x = M_\nu(x) \sin \theta_\nu(x),$$

$$10.68.4 \quad \text{ker}_\nu x = N_\nu(x) \cos \phi_\nu(x), \quad \text{kei}_\nu x = N_\nu(x) \sin \phi_\nu(x).$$

$$10.68.5 \quad M_\nu(x) = (\text{ber}_\nu^2 x + \text{bei}_\nu^2 x)^{1/2}, \quad N_\nu(x) = (\text{ker}_\nu^2 x + \text{kei}_\nu^2 x)^{1/2},$$

$$10.68.6 \quad \theta_\nu(x) = \text{Arctan}(\text{bei}_\nu x / \text{ber}_\nu x), \quad \phi_\nu(x) = \text{Arctan}(\text{kei}_\nu x / \text{ker}_\nu x).$$

$$10.68.7 \quad M_{-n}(x) = M_n(x), \quad \theta_{-n}(x) = \theta_n(x) - n\pi.$$

With arguments ( $x$ ) suppressed,

$$10.68.8 \quad \begin{aligned} \text{ber}'_\nu x &= \frac{1}{2} M_{\nu+1} \cos(\theta_{\nu+1} - \frac{1}{4}\pi) - \frac{1}{2} M_{\nu-1} \cos(\theta_{\nu-1} - \frac{1}{4}\pi) \\ &= (\nu/x) M_\nu \cos \theta_\nu + M_{\nu+1} \cos(\theta_{\nu+1} - \frac{1}{4}\pi) = -(\nu/x) M_\nu \cos \theta_\nu - M_{\nu-1} \cos(\theta_{\nu-1} - \frac{1}{4}\pi), \end{aligned}$$

$$10.68.9 \quad \begin{aligned} \text{bei}'_\nu x &= \frac{1}{2} M_{\nu+1} \sin(\theta_{\nu+1} - \frac{1}{4}\pi) - \frac{1}{2} M_{\nu-1} \sin(\theta_{\nu-1} - \frac{1}{4}\pi) \\ &= (\nu/x) M_\nu \sin \theta_\nu + M_{\nu+1} \sin(\theta_{\nu+1} - \frac{1}{4}\pi) = -(\nu/x) M_\nu \sin \theta_\nu - M_{\nu-1} \sin(\theta_{\nu-1} - \frac{1}{4}\pi). \end{aligned}$$

$$10.68.10 \quad \text{ber}' x = M_1 \cos(\theta_1 - \frac{1}{4}\pi), \quad \text{bei}' x = M_1 \sin(\theta_1 - \frac{1}{4}\pi).$$

$$10.68.11 \quad M'_\nu = (\nu/x) M_\nu + M_{\nu+1} \cos(\theta_{\nu+1} - \theta_\nu - \frac{1}{4}\pi) = -(\nu/x) M_\nu - M_{\nu-1} \cos(\theta_{\nu-1} - \theta_\nu - \frac{1}{4}\pi),$$

$$10.68.12 \quad \theta'_\nu = (M_{\nu+1} / M_\nu) \sin(\theta_{\nu+1} - \theta_\nu - \frac{1}{4}\pi) = -(M_{\nu-1} / M_\nu) \sin(\theta_{\nu-1} - \theta_\nu - \frac{1}{4}\pi).$$

$$10.68.13 \quad M'_0 = M_1 \cos(\theta_1 - \theta_0 - \frac{1}{4}\pi), \quad \theta'_0 = (M_1 / M_0) \sin(\theta_1 - \theta_0 - \frac{1}{4}\pi).$$

$$10.68.14 \quad d(x M_\nu^2 \theta'_\nu) / dx = x M_\nu^2, \quad x^2 M''_\nu + x M'_\nu - \nu^2 M_\nu = x^2 M_\nu \theta'^2_\nu.$$

Equations (10.68.8)–(10.68.14) also hold with the symbols  $\text{ber}$ ,  $\text{bei}$ ,  $M$ , and  $\theta$  replaced throughout by  $\text{ker}$ ,  $\text{kei}$ ,  $N$ , and  $\phi$ , respectively. In place of (10.68.7),

$$10.68.15 \quad N_{-\nu}(x) = N_\nu(x), \quad \phi_{-\nu}(x) = \phi_\nu(x) + \nu\pi.$$

### 10.68(iii) Asymptotic Expansions for Large Argument

When  $\nu$  is fixed,  $\mu = 4\nu^2$ , and  $x \rightarrow \infty$

$$10.68.16 \quad M_\nu(x) = \frac{e^{x/\sqrt{2}}}{(2\pi x)^{\frac{1}{2}}} \left( 1 - \frac{\mu-1}{8\sqrt{2}} \frac{1}{x} + \frac{(\mu-1)^2}{256} \frac{1}{x^2} - \frac{(\mu-1)(\mu^2+14\mu-399)}{6144\sqrt{2}} \frac{1}{x^3} + O\left(\frac{1}{x^4}\right) \right),$$

$$10.68.17 \quad \ln M_\nu(x) = \frac{x}{\sqrt{2}} - \frac{1}{2} \ln(2\pi x) - \frac{\mu-1}{8\sqrt{2}} \frac{1}{x} - \frac{(\mu-1)(\mu-25)}{384\sqrt{2}} \frac{1}{x^3} - \frac{(\mu-1)(\mu-13)}{128} \frac{1}{x^4} + O\left(\frac{1}{x^5}\right),$$

$$10.68.18 \quad \theta_\nu(x) = \frac{x}{\sqrt{2}} + \left(\frac{1}{2}\nu - \frac{1}{8}\right) \pi + \frac{\mu-1}{8\sqrt{2}} \frac{1}{x} + \frac{\mu-1}{16} \frac{1}{x^2} - \frac{(\mu-1)(\mu-25)}{384\sqrt{2}} \frac{1}{x^3} + O\left(\frac{1}{x^5}\right).$$

$$10.68.19 \quad N_\nu(x) = e^{-x/\sqrt{2}} \left(\frac{\pi}{2x}\right)^{\frac{1}{2}} \left( 1 + \frac{\mu-1}{8\sqrt{2}} \frac{1}{x} + \frac{(\mu-1)^2}{256} \frac{1}{x^2} + \frac{(\mu-1)(\mu^2+14\mu-399)}{6144\sqrt{2}} \frac{1}{x^3} + O\left(\frac{1}{x^4}\right) \right),$$

$$10.68.20 \quad \ln N_\nu(x) = -\frac{x}{\sqrt{2}} + \frac{1}{2} \ln\left(\frac{\pi}{2x}\right) + \frac{\mu-1}{8\sqrt{2}} \frac{1}{x} + \frac{(\mu-1)(\mu-25)}{384\sqrt{2}} \frac{1}{x^3} - \frac{(\mu-1)(\mu-13)}{128} \frac{1}{x^4} + O\left(\frac{1}{x^5}\right),$$

$$10.68.21 \quad \phi_\nu(x) = -\frac{x}{\sqrt{2}} - \left(\frac{1}{2}\nu + \frac{1}{8}\right) \pi - \frac{\mu-1}{8\sqrt{2}} \frac{1}{x} + \frac{\mu-1}{16} \frac{1}{x^2} + \frac{(\mu-1)(\mu-25)}{384\sqrt{2}} \frac{1}{x^3} + O\left(\frac{1}{x^5}\right).$$

**10.68(iv) Further Properties**

Additional properties of the modulus and phase functions are given in Young and Kirk (1964, pp. xi–xv). However, care needs to be exercised with the branches of the phases. Thus this reference gives  $\phi_1(0) = \frac{5}{4}\pi$  (Eq. (6.10)), and  $\lim_{x \rightarrow \infty}(\phi_1(x) + (x/\sqrt{2})) = -\frac{5}{8}\pi$  (Eqs. (10.20) and (Eqs. (10.26b)). However, numerical tabulations show that if the second of these equations applies and  $\phi_1(x)$  is continuous, then  $\phi_1(0) = -\frac{3}{4}\pi$ ; compare Abramowitz and Stegun (1964, p. 433).

**10.69 Uniform Asymptotic Expansions for Large Order**

Let  $U_k(p)$  and  $V_k(p)$  be the polynomials defined in §10.41(ii), and

**10.69.1** 
$$\xi = (1 + ix^2)^{1/2}.$$

Then as  $\nu \rightarrow +\infty$ ,

**10.69.2** 
$$\text{ber}_\nu(\nu x) + i \text{bei}_\nu(\nu x) \sim \frac{e^{\nu\xi}}{(2\pi\nu\xi)^{1/2}} \left(\frac{xe^{3\pi i/4}}{1+\xi}\right)^\nu \sum_{k=0}^\infty \frac{U_k(\xi^{-1})}{\nu^k},$$

**10.69.3** 
$$\text{ker}_\nu(\nu x) + i \text{kei}_\nu(\nu x) \sim e^{-\nu\xi} \left(\frac{\pi}{2\nu\xi}\right)^{1/2} \left(\frac{xe^{3\pi i/4}}{1+\xi}\right)^{-\nu} \sum_{k=0}^\infty (-1)^k \frac{U_k(\xi^{-1})}{\nu^k},$$

**10.69.4** 
$$\text{ber}'_\nu(\nu x) + i \text{bei}'_\nu(\nu x) \sim \frac{e^{\nu\xi}}{x} \left(\frac{\xi}{2\pi\nu}\right)^{1/2} \left(\frac{xe^{3\pi i/4}}{1+\xi}\right)^\nu \sum_{k=0}^\infty \frac{V_k(\xi^{-1})}{\nu^k},$$

**10.69.5** 
$$\text{ker}'_\nu(\nu x) + i \text{kei}'_\nu(\nu x) \sim -\frac{e^{-\nu\xi}}{x} \left(\frac{\pi\xi}{2\nu}\right)^{1/2} \left(\frac{xe^{3\pi i/4}}{1+\xi}\right)^{-\nu} \sum_{k=0}^\infty (-1)^k \frac{V_k(\xi^{-1})}{\nu^k},$$

uniformly for  $x \in (0, \infty)$ . All fractional powers take their principal values.

All four expansions also enjoy the same kind of double asymptotic property described in §10.41(iv).

Accuracy in (10.69.2) and (10.69.4) can be increased by including exponentially-small contributions as in (10.67.3), (10.67.4), (10.67.7), and (10.67.8) with  $x$  replaced by  $\nu x$ .

**10.70 Zeros**

Asymptotic approximations for large zeros are as follows. Let  $\mu = 4\nu^2$  and  $f(t)$  denote the formal series

**10.70.1** 
$$\frac{\mu - 1}{16t} + \frac{\mu - 1}{32t^2} + \frac{(\mu - 1)(5\mu + 19)}{1536t^3} + \frac{3(\mu - 1)^2}{512t^4} + \dots.$$

If  $m$  is a large positive integer, then

	zeros of $\text{ber}_\nu x \sim \sqrt{2}(t - f(t))$ ,	$t = (m - \frac{1}{2}\nu - \frac{3}{8})\pi$ ,
<b>10.70.2</b>	zeros of $\text{bei}_\nu x \sim \sqrt{2}(t - f(t))$ ,	$t = (m - \frac{1}{2}\nu + \frac{1}{8})\pi$ ,
	zeros of $\text{ker}_\nu x \sim \sqrt{2}(t + f(-t))$ ,	$t = (m - \frac{1}{2}\nu - \frac{5}{8})\pi$ ,
	zeros of $\text{kei}_\nu x \sim \sqrt{2}(t + f(-t))$ ,	$t = (m - \frac{1}{2}\nu - \frac{1}{8})\pi$ .

In the case  $\nu = 0$ , numerical tabulations (Abramowitz and Stegun (1964, Table 9.12)) indicate that each of (10.70.2) corresponds to the  $m$ th zero of the function on the left-hand side. For the next six terms in the series (10.70.1) see MacLeod (2002a).

## 10.71 Integrals

### 10.71(i) Indefinite Integrals

In the following equations  $f_\nu, g_\nu$  is any one of the four ordered pairs given in (10.63.1), and  $\widehat{f}_\nu, \widehat{g}_\nu$  is either the same ordered pair or any other ordered pair in (10.63.1).

$$10.71.1 \quad \int x^{1+\nu} f_\nu dx = -\frac{x^{1+\nu}}{\sqrt{2}}(f_{\nu+1} - g_{\nu+1}) = -x^{1+\nu} \left( \frac{\nu}{x} g_\nu - g'_\nu \right),$$

$$10.71.2 \quad \int x^{1-\nu} f_\nu dx = \frac{x^{1-\nu}}{\sqrt{2}}(f_{\nu-1} - g_{\nu-1}) = x^{1-\nu} \left( \frac{\nu}{x} g_\nu + g'_\nu \right).$$

$$10.71.3 \quad \int x(f_\nu \widehat{g}_\nu - g_\nu \widehat{f}_\nu) dx = \frac{x}{2\sqrt{2}} \left( \widehat{f}_\nu(f_{\nu+1} + g_{\nu+1}) - \widehat{g}_\nu(f_{\nu+1} - g_{\nu+1}) - f_\nu(\widehat{f}_{\nu+1} + \widehat{g}_{\nu+1}) + g_\nu(\widehat{f}_{\nu+1} - \widehat{g}_{\nu+1}) \right) \\ = \frac{1}{2} x(f'_\nu \widehat{f}_\nu - f_\nu \widehat{f}'_\nu + g'_\nu \widehat{g}_\nu - g_\nu \widehat{g}'_\nu),$$

$$10.71.4 \quad \int x(f_\nu \widehat{g}_\nu + g_\nu \widehat{f}_\nu) dx = \frac{1}{4} x^2 (2f_\nu \widehat{g}_\nu - f_{\nu-1} \widehat{g}_{\nu+1} - f_{\nu+1} \widehat{g}_{\nu-1} + 2g_\nu \widehat{f}_\nu - g_{\nu-1} \widehat{f}_{\nu+1} - g_{\nu+1} \widehat{f}_{\nu-1}).$$

$$10.71.5 \quad \int x(f_\nu^2 + g_\nu^2) dx = x(f_\nu g'_\nu - f'_\nu g_\nu) = -\frac{x}{\sqrt{2}}(f_\nu f_{\nu+1} + g_\nu g_{\nu+1} - f_\nu g_{\nu+1} + f_{\nu+1} g_\nu),$$

$$10.71.6 \quad \int x f_\nu g_\nu dx = \frac{1}{4} x^2 (2f_\nu g_\nu - f_{\nu-1} g_{\nu+1} - f_{\nu+1} g_{\nu-1}),$$

$$10.71.7 \quad \int x(f_\nu^2 - g_\nu^2) dx = \frac{1}{2} x^2 (f_\nu^2 - f_{\nu-1} f_{\nu+1} - g_\nu^2 + g_{\nu-1} g_{\nu+1}).$$

#### Examples

$$10.71.8 \quad \int x M_\nu^2(x) dx = x(\text{ber}_\nu x \text{bei}'_\nu x - \text{ber}'_\nu x \text{bei}_\nu x), \quad \int x N_\nu^2(x) dx = x(\text{ker}_\nu x \text{kei}'_\nu x - \text{ker}'_\nu x \text{kei}_\nu x),$$

where  $M_\nu(x)$  and  $N_\nu(x)$  are the modulus functions introduced in §10.68(i).

### 10.71(ii) Definite Integrals

See Kerr (1978) and Glasser (1979).

### 10.71(iii) Compendia

For infinite double integrals involving Kelvin functions see Prudnikov *et al.* (1986b, pp. 630–631).

For direct and inverse Laplace transforms of Kelvin functions see Prudnikov *et al.* (1992a, §3.19) and Prudnikov *et al.* (1992b, §3.19).

## Applications

### 10.72 Mathematical Applications

#### 10.72(i) Differential Equations with Turning Points

Bessel functions and modified Bessel functions are often used as approximants in the construction of uniform asymptotic approximations and expansions for solutions of linear second-order differential equations containing a

parameter. The canonical form of differential equation for these problems is given by

$$10.72.1 \quad \frac{d^2 w}{dz^2} = (u^2 f(z) + g(z)) w,$$

where  $z$  is a real or complex variable and  $u$  is a large real or complex parameter.

#### Simple Turning Points

In regions in which (10.72.1) has a simple turning point  $z_0$ , that is,  $f(z)$  and  $g(z)$  are analytic (or with weaker conditions if  $z = x$  is a real variable) and  $z_0$  is a simple zero of  $f(z)$ , asymptotic expansions of the solutions  $w$  for large  $u$  can be constructed in terms of Airy functions or equivalently Bessel functions or modified Bessel functions of order  $\frac{1}{3}$  (§9.6(i)). These expansions are uniform with respect to  $z$ , including the turning point  $z_0$  and its neighborhood, and the region of validity often includes cut neighborhoods (§1.10(vi)) of other singularities of the differential equation, especially irregular singularities.

For further information and references see §§2.8(i) and 2.8(iii).

### Multiple or Fractional Turning Points

If  $f(z)$  has a double zero  $z_0$ , or more generally  $z_0$  is a zero of order  $m$ ,  $m = 2, 3, 4, \dots$ , then uniform asymptotic approximations (but *not* expansions) can be constructed in terms of Bessel functions, or modified Bessel functions, of order  $1/(m+2)$ . The number  $m$  can also be replaced by any real constant  $\lambda$  ( $> -2$ ) in the sense that  $(z - z_0)^{-\lambda} f(z)$  is analytic and nonvanishing at  $z_0$ ; moreover,  $g(z)$  is permitted to have a single or double pole at  $z_0$ . The order of the approximating Bessel functions, or modified Bessel functions, is  $1/(\lambda+2)$ , except in the case when  $g(z)$  has a double pole at  $z_0$ . See §2.8(v) for references.

### 10.72(ii) Differential Equations with Poles

In regions in which the function  $f(z)$  has a simple pole at  $z = z_0$  and  $(z - z_0)^2 g(z)$  is analytic at  $z = z_0$  (the case  $\lambda = -1$  in §10.72(i)), asymptotic expansions of the solutions  $w$  of (10.72.1) for large  $u$  can be constructed in terms of Bessel functions and modified Bessel functions of order  $\pm\sqrt{1+4\rho}$ , where  $\rho$  is the limiting value of  $(z - z_0)^2 g(z)$  as  $z \rightarrow z_0$ . These asymptotic expansions are uniform with respect to  $z$ , including cut neighborhoods of  $z_0$ , and again the region of uniformity often includes cut neighborhoods of other singularities of the differential equation.

For further information and references see §§2.8(i) and 2.8(iv).

### 10.72(iii) Differential Equations with a Double Pole and a Movable Turning Point

In (10.72.1) assume  $f(z) = f(z, \alpha)$  and  $g(z) = g(z, \alpha)$  depend continuously on a real parameter  $\alpha$ ,  $f(z, \alpha)$  has a simple zero  $z = z_0(\alpha)$  and a double pole  $z = 0$ , except for a critical value  $\alpha = a$ , where  $z_0(a) = 0$ . Assume that whether or not  $\alpha = a$ ,  $z^2 g(z, \alpha)$  is analytic at  $z = 0$ . Then for large  $u$  asymptotic approximations of the solutions  $w$  can be constructed in terms of Bessel functions, or modified Bessel functions, of variable order (in fact the order depends on  $u$  and  $\alpha$ ). These approximations are uniform with respect to both  $z$  and  $\alpha$ , including  $z = z_0(a)$ , the cut neighborhood of  $z = 0$ , and  $\alpha = a$ . See §2.8(vi) for references.

## 10.73 Physical Applications

### 10.73(i) Bessel and Modified Bessel Functions

Bessel functions first appear in the investigation of a physical problem in Daniel Bernoulli's analysis of the small oscillations of a uniform heavy flexible chain. For this problem and its further generalizations, see Korenev (2002, Chapter 4, §37) and Gray *et al.* (1922, Chapter I, §1, Chapter XVI, §4).

Bessel functions of the first kind,  $J_n(x)$ , arise naturally in applications having cylindrical symmetry in which the physics is described either by Laplace's equation  $\nabla^2 V = 0$ , or by the Helmholtz equation  $(\nabla^2 + k^2)\psi = 0$ .

Laplace's equation governs problems in heat conduction, in the distribution of potential in an electrostatic field, and in hydrodynamics in the irrotational motion of an incompressible fluid. See Jackson (1999, Chapter 3, §§3.7, 3.8, 3.11, 3.13), Lamb (1932, Chapter V, §§100–102; Chapter VIII, §§186, 191–193; Chapter X, §§303, 304), Happel and Brenner (1973, Chapter 3, §3.3; Chapter 7, §7.3), Korenev (2002, Chapter 4, §43), and Gray *et al.* (1922, Chapter XI). In cylindrical coordinates  $r, \phi, z$ , (§1.5(ii)) we have

$$10.73.1 \quad \nabla^2 V = \frac{1}{r} \frac{\partial}{\partial r} \left( r \frac{\partial V}{\partial r} \right) + \frac{1}{r^2} \frac{\partial^2 V}{\partial \phi^2} + \frac{\partial^2 V}{\partial z^2} = 0,$$

and on separation of variables we obtain solutions of the form  $e^{\pm i n \phi} e^{\pm \kappa z} J_n(\kappa r)$ , from which a solution satisfying prescribed boundary conditions may be constructed.

The Helmholtz equation,  $(\nabla^2 + k^2)\psi = 0$ , follows from the wave equation

$$10.73.2 \quad \nabla^2 \psi = \frac{1}{c^2} \frac{\partial^2 \psi}{\partial t^2},$$

on assuming a time dependence of the form  $e^{\pm i k t}$ . This equation governs problems in acoustic and electromagnetic wave propagation. See Jackson (1999, Chapter 9, §9.6), Jones (1986, Chapters 7, 8), and Lord Rayleigh (1945, Vol. I, Chapter IX, §§200–211, 218, 219, 221a; Vol. II, Chapter XIII, §272a; Chapter XV, §302; Chapter XVIII; Chapter XIX, §350; Chapter XX, §357; Chapter XXI, §369). It is fundamental in the study of electromagnetic wave transmission. Consequently, Bessel functions  $J_n(x)$ , and modified Bessel functions  $I_n(x)$ , are central to the analysis of microwave and optical transmission in waveguides, including coaxial and fiber. See Krivoslykov (1994, Chapter 2, §2.2.10; Chapter 5, §5.2.2), Kapany and Burke (1972, Chapters 4–6; Chapter 7, §A.1), and Slater (1942, Chapter 4, §§20, 25).

Bessel functions enter in the study of the scattering of light and other electromagnetic radiation, not only from cylindrical surfaces but also in the statistical analysis involved in scattering from rough surfaces. See Smith (1997, Chapter 3, §3.7; Chapter 6, §6.4), Beckmann and Spizzichino (1963, Chapter 4, §§4.2, 4.3; Chapter 5, §§5.2, 5.3; Chapter 6, §6.1; Chapter 7, §7.1.), Kerker (1969, Chapter 5, §5.6.4; Chapter 7, §7.5.6), and Bayvel and Jones (1981, Chapter 1, §§1.6.5, 1.6.6).

More recently, Bessel functions appear in the inverse problem in wave propagation, with applications in medicine, astronomy, and acoustic imaging. See Colton and Kress (1998, Chapter 2, §§2.4, 2.5; Chapter 3, §3.4).

In the theory of plates and shells, the oscillations of a circular plate are determined by the differential equation

$$10.73.3 \quad \nabla^4 W + \lambda^2 \frac{\partial^2 W}{\partial t^2} = 0.$$

See [Korenev \(2002\)](#). On separation of variables into cylindrical coordinates, the Bessel functions  $J_n(x)$ , and modified Bessel functions  $I_n(x)$  and  $K_n(x)$ , all appear.

### 10.73(ii) Spherical Bessel Functions

The functions  $j_n(x)$ ,  $y_n(x)$ ,  $h_n^{(1)}(x)$ , and  $h_n^{(2)}(x)$  arise in the solution (again by separation of variables) of the Helmholtz equation in spherical coordinates  $\rho, \theta, \phi$  (§1.5(ii)):

10.73.4

$$\begin{aligned} (\nabla^2 + k^2)f = & \frac{1}{\rho^2} \frac{\partial}{\partial \rho} \left( \rho^2 \frac{\partial f}{\partial \rho} \right) + \frac{1}{\rho^2 \sin \theta} \frac{\partial}{\partial \theta} \left( \sin \theta \frac{\partial f}{\partial \theta} \right) \\ & + \frac{1}{\rho^2 \sin^2 \theta} \frac{\partial^2 f}{\partial \phi^2} + k^2 f. \end{aligned}$$

With the spherical harmonic  $Y_{\ell,m}(\theta, \phi)$  defined as in §14.30(i), the solutions are of the form  $f = g_\ell(k\rho) Y_{\ell,m}(\theta, \phi)$  with  $g_\ell = j_\ell, y_\ell, h_\ell^{(1)}$ , or  $h_\ell^{(2)}$ , depending on the boundary conditions. Accordingly, the spherical Bessel functions appear in all problems in three dimensions with spherical symmetry involving the scattering of electromagnetic radiation. See [Jackson \(1999, Chapter 9, §9.6\)](#), [Bayvel and Jones \(1981, Chapter 1, §1.5.1\)](#), and [Konopinski \(1981, Chapter 9, §9.1\)](#). In quantum mechanics the spherical Bessel functions arise in the solution of the Schrödinger wave equation for a particle in a central potential. See [Messiah \(1961, Chapter IX, §§7–10\)](#).

### 10.73(iii) Kelvin Functions

The analysis of the current distribution in circular conductors leads to the Kelvin functions  $\text{ber } x$ ,  $\text{bei } x$ ,  $\text{ker } x$ , and  $\text{kei } x$ . See [Relton \(1965, Chapter X, §§10.2, 10.3\)](#), [Bowman \(1958, Chapter III, §§51–53\)](#), [McLachlan \(1961, Chapters VIII and IX\)](#), and [Russell \(1909\)](#). The McLachlan reference also includes other applications of Kelvin functions.

### 10.73(iv) Bickley Functions

See [Bickley \(1935\)](#) and [Altaç \(1996\)](#).

### 10.73(v) Rayleigh Function

For applications of the Rayleigh function  $\sigma_n(\nu)$  (§10.21(xiii)) to problems of heat conduction and diffusion in liquids see [Kapitsa \(1951b\)](#).

## Computation

### 10.74 Methods of Computation

#### 10.74(i) Series Expansions

The power-series expansions given in §§10.2 and 10.8, together with the connection formulas of §10.4, can be used to compute the Bessel and Hankel functions when the argument  $x$  or  $z$  is sufficiently small in absolute value. In the case of the modified Bessel function  $K_\nu(z)$  see especially [Temme \(1975\)](#).

In other circumstances the power series are prone to slow convergence and heavy numerical cancellation.

If  $x$  or  $|z|$  is large compared with  $|\nu|^2$ , then the asymptotic expansions of §§10.17(i)–10.17(iv) are available. Furthermore, the attainable accuracy can be increased substantially by use of the exponentially-improved expansions given in §10.17(v), even more so by application of the hyperasymptotic expansions to be found in the references in that subsection.

For large positive real values of  $\nu$  the uniform asymptotic expansions of §§10.20(i) and 10.20(ii) can be used. Moreover, because of their double asymptotic properties (§10.41(v)) these expansions can also be used for large  $x$  or  $|z|$ , whether or not  $\nu$  is large. It should be noted, however, that there is a difficulty in evaluating the coefficients  $A_k(\zeta)$ ,  $B_k(\zeta)$ ,  $C_k(\zeta)$ , and  $D_k(\zeta)$ , from the explicit expressions (10.20.10)–(10.20.13) when  $z$  is close to 1 owing to severe cancellation. [Temme \(1997\)](#) shows how to overcome this difficulty by use of the Maclaurin expansions for these coefficients or by use of auxiliary functions.

Similar observations apply to the computation of modified Bessel functions, spherical Bessel functions, and Kelvin functions. In the case of the spherical Bessel functions the explicit formulas given in §§10.49(i) and 10.49(ii) are terminating cases of the asymptotic expansions given in §§10.17(i) and 10.40(i) for the Bessel functions and modified Bessel functions. And since there are no error terms they could, in theory, be used for all values of  $z$ ; however, there may be severe cancellation when  $|z|$  is not large compared with  $n^2$ .

#### 10.74(ii) Differential Equations

A comprehensive and powerful approach is to integrate the differential equations (10.2.1) and (10.25.1) by direct numerical methods. As described in §3.7(ii), to insure stability the integration path must be chosen in such a way that as we proceed along it the wanted solution grows in magnitude at least as fast as all other solutions of the differential equation.

In the interval  $0 < x < \nu$ ,  $J_\nu(x)$  needs to be integrated in the forward direction and  $Y_\nu(x)$  in the backward direction, with initial values for the former obtained from the power-series expansion (10.2.2) and for the latter from asymptotic expansions (§§10.17(i) and 10.20(i)). In the interval  $\nu < x < \infty$  either direction of integration can be used for both functions.

Similarly, to maintain stability in the interval  $0 < x < \infty$  the integration direction has to be forwards in the case of  $I_\nu(x)$  and backwards in the case of  $K_\nu(x)$ , with initial values obtained in an analogous manner to those for  $J_\nu(x)$  and  $Y_\nu(x)$ .

For  $z \in \mathbb{C}$  the function  $H_\nu^{(1)}(z)$ , for example, can always be computed in a stable manner in the sector  $0 \leq \text{ph} z \leq \pi$  by integrating along rays towards the origin.

Similar considerations apply to the spherical Bessel functions and Kelvin functions.

For further information, including parallel methods for solving the differential equations, see Lozier and Olver (1993).

### 10.74(iii) Integral Representations

For evaluation of the Hankel functions  $H_\nu^{(1)}(z)$  and  $H_\nu^{(2)}(z)$  for complex values of  $\nu$  and  $z$  based on the integral representations (10.9.18) see Remenets (1973).

For applications of generalized Gauss–Laguerre quadrature (§3.5(v)) to the evaluation of the modified Bessel functions  $K_\nu(z)$  for  $0 < \nu < 1$  and  $0 < x < \infty$  see Gautschi (2002a). The integral representation used is based on (10.32.8).

For evaluation of  $K_\nu(z)$  from (10.32.14) with  $\nu = n$  and  $z$  complex, see Mechel (1966).

### 10.74(iv) Recurrence Relations

If values of the Bessel functions  $J_\nu(z)$ ,  $Y_\nu(z)$ , or the other functions treated in this chapter, are needed for integer-spaced ranges of values of the order  $\nu$ , then a simple and powerful procedure is provided by recurrence relations typified by the first of (10.6.1).

Suppose, for example,  $\nu = n \in 0, 1, 2, \dots$ , and  $x \in (0, \infty)$ . Then  $J_n(x)$  and  $Y_n(x)$  can be generated by either forward or backward recurrence on  $n$  when  $n < x$ , but if  $n > x$  then to maintain stability  $J_n(x)$  has to be generated by backward recurrence on  $n$ , and  $Y_n(x)$  has to be generated by forward recurrence on  $n$ . In the case of  $J_n(x)$ , the need for initial values can be avoided by application of Olver's algorithm (§3.6(v)) in conjunction with Equation (10.12.4) used as a normalizing condition, or in the case of noninteger orders, (10.23.15).

For further information see Gautschi (1967), Olver and Sookne (1972), Temme (1975), Campbell (1980), and Kerimov and Skorokhodov (1984a).

### 10.74(v) Continued Fractions

For applications of the continued-fraction expansions (10.10.1), (10.10.2), (10.33.1), and (10.33.2) to the computation of Bessel functions and modified Bessel functions see Gargantini and Henrici (1967), Amos (1974), Gautschi and Slavik (1978), Tretter and Walster (1980), Thompson and Barnett (1986), and Cuyt *et al.* (2008).

### 10.74(vi) Zeros and Associated Values

Newton's rule (§3.8(i)) or Halley's rule (§3.8(v)) can be used to compute to arbitrarily high accuracy the real or complex zeros of all the functions treated in this chapter. Necessary values of the first derivatives of the functions are obtained by the use of (10.6.2), for example. Newton's rule is quadratically convergent and Halley's rule is cubically convergent. See also Segura (1998, 2001).

Methods for obtaining initial approximations to the zeros include asymptotic expansions (§§10.21(vi)–10.21(ix)), graphical intersection of 2D graphs in  $\mathbb{R}$  (e.g., §10.3(i)) with the  $x$ -axis, or graphical intersection of 3D complex-variable surfaces (e.g., §10.3(ii)) with the plane  $z = 0$ .

To ensure that no zeros are overlooked, standard tools are the phase principle and Rouché's theorem; see §1.10(iv).

#### Real Zeros

See Olver (1960, pp. xvi–xxix), Grad and Zakrajšek (1973), Temme (1979a), Ikebe *et al.* (1991), Zafirooulos *et al.* (1996), Vrahatis *et al.* (1997a), Ball (2000), and Gil and Segura (2003).

#### Complex Zeros

See Leung and Ghaderpanah (1979), Kerimov and Skorokhodov (1984b,c, 1985a,b), Skorokhodov (1985), Modenov and Filonov (1986), and Vrahatis *et al.* (1997b).

#### Multiple Zeros

See Kerimov and Skorokhodov (1985c, 1986, 1987, 1988).

### 10.74(vii) Integrals

#### Hankel Transform

See Cornille (1972), Johansen and Sørensen (1979), Gabutti (1979), Gabutti and Minetti (1981), Candel (1981), Wong (1982), Lund (1985), Piessens and Branders (1985), Hansen (1985), Bezdova *et al.* (1986), Puskari (1988), Christensen (1990), Campos (1995), Lucas and Stone (1995), Barakat and Parshall (1996), Sidi (1997), Secada (1999).

### Fourier–Bessel Expansion

For the computation of the integral (10.23.19) see Piessens and Branders (1983, 1985), Lewanowicz (1991), and Zhileikin and Kukarkin (1995).

### Spherical Bessel Transform

The *spherical Bessel transform* is the Hankel transform (10.22.76) in the case when  $\nu$  is half an odd positive integer.

See Lehman *et al.* (1981), Puoskari (1988), and Sharafeddin *et al.* (1992).

### Kontorovich–Lebedev Transform

See Ehrenmark (1995).

### Products

For infinite integrals involving products of two Bessel functions of the first kind, see Linz and Kropp (1973), Gabutti (1980), Ikonomidou *et al.* (1995), and Lucas (1995).

## 10.74(viii) Functions of Imaginary Order

For the computation of the functions  $\tilde{I}_\nu(x)$  and  $\tilde{K}_\nu(x)$  defined by (10.45.2) see Temme (1994b) and Gil *et al.* (2002b, 2003a, 2004a).

## 10.75 Tables

### 10.75(i) Introduction

Comprehensive listings and descriptions of tables of the functions treated in this chapter are provided in Bateman and Archibald (1944), Lebedev and Fedorova (1960), Fletcher *et al.* (1962), and Luke (1975, §9.13.2). Only a few of the more comprehensive of these early tables are included in the listings in the following subsections. Also, for additional listings of tables pertaining to complex arguments see Babushkina *et al.* (1997).

### 10.75(ii) Bessel Functions and their Derivatives

- British Association for the Advancement of Science (1937) tabulates  $J_0(x)$ ,  $J_1(x)$ ,  $x = 0(.001)16(.01)25$ , 10D;  $Y_0(x)$ ,  $Y_1(x)$ ,  $x = 0.01(.01)25$ , 8–9S or 8D. Also included are auxiliary functions to facilitate interpolation of the tables of  $Y_0(x)$ ,  $Y_1(x)$  for small values of  $x$ , as well as auxiliary functions to compute all four functions for large values of  $x$ .
- Bickley *et al.* (1952) tabulates  $J_n(x)$ ,  $Y_n(x)$  or  $x^n Y_n(x)$ ,  $n = 2(1)20$ ,  $x = 0(.01 \text{ or } .1) 10(.1)25$ , 8D (for  $J_n(x)$ ), 8S (for  $Y_n(x)$  or  $x^n Y_n(x)$ );  $J_n(x)$ ,  $Y_n(x)$ ,  $n = 0(1)20$ ,  $x = 0 \text{ or } 0.1(.1)25$ , 10D (for  $J_n(x)$ ), 10S (for  $Y_n(x)$ ).

- Olver (1962) provides tables for the uniform asymptotic expansions given in §10.20(i), including  $\zeta$  and  $(4\zeta/(1-x^2))^{\frac{1}{4}}$  as functions of  $x (= z)$  and the coefficients  $A_k(\zeta)$ ,  $B_k(\zeta)$ ,  $C_k(\zeta)$ ,  $D_k(\zeta)$  as functions of  $\zeta$ . These enable  $J_\nu(\nu x)$ ,  $Y_\nu(\nu x)$ ,  $J'_\nu(\nu x)$ ,  $Y'_\nu(\nu x)$  to be computed to 10S when  $\nu \geq 15$ , except in the neighborhoods of zeros.
- The main tables in Abramowitz and Stegun (1964, Chapter 9) give  $J_0(x)$  to 15D,  $J_1(x)$ ,  $J_2(x)$ ,  $Y_0(x)$ ,  $Y_1(x)$  to 10D,  $Y_2(x)$  to 8D,  $x = 0(.1)17.5$ ;  $Y_n(x) - (2/\pi)J_n(x)\ln x$ ,  $n = 0, 1$ ,  $x = 0(.1)2$ , 8D;  $J_n(x)$ ,  $Y_n(x)$ ,  $n = 3(1)9$ ,  $x = 0(.2)20$ , 5D or 5S;  $J_n(x)$ ,  $Y_n(x)$ ,  $n = 0(1)20(10)50, 100$ ,  $x = 1, 2, 5, 10, 50, 100$ , 10S; modulus and phase functions  $\sqrt{x}M_n(x)$ ,  $\theta_n(x) - x$ ,  $n = 0, 1, 2$ ,  $1/x = 0(.01)0.1$ , 8D.
- Achenbach (1986) tabulates  $J_0(x)$ ,  $J_1(x)$ ,  $Y_0(x)$ ,  $Y_1(x)$ ,  $x = 0(.1)8$ , 20D or 18–20S.
- Zhang and Jin (1996, pp. 185–195) tabulates  $J_n(x)$ ,  $J'_n(x)$ ,  $Y_n(x)$ ,  $Y'_n(x)$ ,  $n = 0(1)10(10)50, 100$ ,  $x = 1, 5, 10, 25, 50, 100$ , 9S;  $J_{n+\alpha}(x)$ ,  $J'_{n+\alpha}(x)$ ,  $Y_{n+\alpha}(x)$ ,  $Y'_{n+\alpha}(x)$ ,  $n = 0(1)5, 10, 30, 50, 100$ ,  $\alpha = \frac{1}{4}, \frac{1}{3}, \frac{1}{2}, \frac{2}{3}, \frac{3}{4}$ ,  $x = 1, 5, 10, 50$ , 8S; real and imaginary parts of  $J_{n+\alpha}(z)$ ,  $J'_{n+\alpha}(z)$ ,  $Y_{n+\alpha}(z)$ ,  $Y'_{n+\alpha}(z)$ ,  $n = 0(1)15, 20(10)50, 100$ ,  $\alpha = 0, \frac{1}{2}$ ,  $z = 4+2i, 20+10i$ , 8S.

### 10.75(iii) Zeros and Associated Values of the Bessel Functions, Hankel Functions, and their Derivatives

#### Real Zeros

- British Association for the Advancement of Science (1937) tabulates  $j_{0,m}$ ,  $J_1(j_{0,m})$ ,  $j_{1,m}$ ,  $J_0(j_{1,m})$ ,  $m = 1(1)150$ , 10D;  $y_{0,m}$ ,  $Y_1(y_{0,m})$ ,  $y_{1,m}$ ,  $Y_0(y_{1,m})$ ,  $m = 1(1)50$ , 8D.
- Olver (1960) tabulates  $j_{n,m}$ ,  $J'_n(j_{n,m})$ ,  $j'_{n,m}$ ,  $J_n(j'_{n,m})$ ,  $y_{n,m}$ ,  $Y'_n(y_{n,m})$ ,  $y'_{n,m}$ ,  $Y_n(y'_{n,m})$ ,  $n = 0(\frac{1}{2})20\frac{1}{2}$ ,  $m = 1(1)50$ , 8D. Also included are tables of the coefficients in the uniform asymptotic expansions of these zeros and associated values as  $n \rightarrow \infty$ ; see §10.21(viii), and more fully Olver (1954).
- Morgenthaler and Reismann (1963) tabulates  $j'_{n,m}$  for  $n = 21(1)51$  and  $j'_{n,m} < 100$ , 7–10S.
- Abramowitz and Stegun (1964, Chapter 9) tabulates  $j_{n,m}$ ,  $J'_n(j_{n,m})$ ,  $j'_{n,m}$ ,  $J_n(j'_{n,m})$ ,  $n = 0(1)8$ ,  $m = 1(1)20$ , 5D (10D for  $n = 0$ ),  $y_{n,m}$ ,  $Y'_n(y_{n,m})$ ,  $y'_{n,m}$ ,  $Y_n(y'_{n,m})$ ,  $n = 0(1)8$ ,  $m = 1(1)20$ , 5D

- (8D for  $n = 0$ ),  $J_0(j_{0,m}x)$ ,  $m = 1(1)5$ ,  $x = 0(.02)1$ , 5D. Also included are the first 5 zeros of the functions  $xJ_1(x) - \lambda J_0(x)$ ,  $J_1(x) - \lambda x J_0(x)$ ,  $J_0(x)Y_0(\lambda x) - Y_0(x)J_0(\lambda x)$ ,  $J_1(x)Y_1(\lambda x) - Y_1(x)J_1(\lambda x)$ ,  $J_1(x)Y_0(\lambda x) - Y_1(x)J_0(\lambda x)$  for various values of  $\lambda$  and  $\lambda^{-1}$  in the interval  $[0, 1]$ , 4–8D.
- **Abramowitz and Stegun (1964, Chapter 10)** tabulates  $j_{\nu,m}$ ,  $J'_\nu(j_{\nu,m})$ ,  $j'_{\nu,m}$ ,  $J_\nu(j'_{\nu,m})$ ,  $y_{\nu,m}$ ,  $Y'_\nu(y_{\nu,m})$ ,  $y'_{\nu,m}$ ,  $Y_\nu(y'_{\nu,m})$ ,  $\nu = \frac{1}{2}(1)19\frac{1}{2}$ ,  $m = 1(1)m_\nu$ , where  $m_\nu$  ranges from 8 at  $\nu = \frac{1}{2}$  down to 1 at  $\nu = 19\frac{1}{2}$ , 6–7D.
  - **Makinouchi (1966)** tabulates all values of  $j_{\nu,m}$  and  $y_{\nu,m}$  in the interval  $(0, 100)$ , with at least 29S. These are for  $\nu = 0(1)5, 10, 20$ ;  $\nu = \frac{3}{2}, \frac{5}{2}$ ;  $\nu = m/n$  with  $m = 1(1)n - 1$  and  $n = 3(1)8$ , except for  $\nu = \frac{1}{2}$ .
  - **Döring (1971)** tabulates the first 100 values of  $\nu$  ( $> 1$ ) for which  $J'_{-\nu}(x)$  has the double zero  $x = \nu$ , 10D.
  - **Heller (1976)** tabulates  $j_{0,m}$ ,  $J_1(j_{0,m})$ ,  $j_{1,m}$ ,  $J_0(j_{1,m})$ ,  $J'_1(j_{1,m})$ ,  $J_1(j'_{1,m})$  for  $m = 1(1)100$ , 25D.
  - **Wills *et al.* (1982)** tabulates  $j_{0,m}$ ,  $j_{1,m}$ ,  $y_{0,m}$ ,  $y_{1,m}$  for  $m = 1(1)30$ , 35D.
  - **Kerimov and Skorokhodov (1985c)** tabulates 201 double zeros of  $J''_{-\nu}(x)$ , 10 double zeros of  $J'''_{-\nu}(x)$ , 101 double zeros of  $Y'_{-\nu}(x)$ , 201 double zeros of  $Y''_{-\nu}(x)$ , and 10 double zeros of  $Y'''_{-\nu}(x)$ , all to 8 or 9D.
  - **Zhang and Jin (1996, pp. 196–198)** tabulates  $j_{n,m}$ ,  $j'_{n,m}$ ,  $y_{n,m}$ ,  $y'_{n,m}$ ,  $n = 0(1)3$ ,  $m = 1(1)10$ , 8D; the first five zeros of  $J_n(x)Y_n(\lambda x) - J_n(\lambda x)Y_n(x)$ ,  $J'_n(x)Y'_n(\lambda x) - J'_n(\lambda x)Y'_n(x)$ ,  $n = 0, 1, 2$ ,  $\lambda = 1.1(.1)1.6, 1.8, 2(.5)5$ , 7D.
- **Kerimov and Skorokhodov (1985a)** tabulates 5 (nonreal) complex conjugate pairs of zeros of the principal branches of  $Y_n(z)$  and  $Y'_n(z)$  for  $n = 0(1)5$ , 8D.
  - **Kerimov and Skorokhodov (1985b)** tabulates 50 zeros of the principal branches of  $H_0^{(1)}(z)$  and  $H_1^{(1)}(z)$ , 8D.
  - **Kerimov and Skorokhodov (1987)** tabulates 100 complex double zeros  $\nu$  of  $Y'_\nu'(ze^{-\pi i})$  and  $H_\nu^{(1)}'(ze^{-\pi i})$ , 8D.
  - **MacDonald (1989)** tabulates the first 30 zeros, in ascending order of absolute value in the fourth quadrant, of the function  $J_0(z) - iJ_1(z)$ , 6D. (Other zeros of this function can be obtained by reflection in the imaginary axis).
  - **Zhang and Jin (1996, p. 199)** tabulates the real and imaginary parts of the first 15 conjugate pairs of complex zeros of  $Y_0(z)$ ,  $Y_1(z)$ ,  $Y'_1(z)$  and the corresponding values of  $Y_1(z)$ ,  $Y_0(z)$ ,  $Y_1(z)$ , respectively, 10D.

### Complex Zeros

- **Abramowitz and Stegun (1964, p. 373)** tabulates the three smallest zeros of  $Y_0(z)$ ,  $Y_1(z)$ ,  $Y'_1(z)$  in the sector  $0 < \text{ph } z \leq \pi$ , together with the corresponding values of  $Y_1(z)$ ,  $Y_0(z)$ ,  $Y_1(z)$ , respectively, to 9D. (There is an error in the value of  $Y_0(z)$  at the 3rd zero of  $Y_1(z)$ : the last four digits should be 2533; see **Amos (1985)**.)
- **Döring (1966)** tabulates all zeros of  $Y_0(z)$ ,  $Y_1(z)$ ,  $H_0^{(1)}(z)$ ,  $H_1^{(1)}(z)$ , that lie in the sector  $|z| < 158$ ,  $|\text{ph } z| \leq \pi$ , to 10D. Some of the smaller zeros of  $Y_n(z)$  and  $H_n^{(1)}(z)$  for  $n = 2, 3, 4, 5, 15$  are also included.
- **British Association for the Advancement of Science (1937)** tabulates  $I_0(x)$ ,  $I_1(x)$ ,  $x = 0(.001)5$ , 7–8D;  $K_0(x)$ ,  $K_1(x)$ ,  $x = 0.01(.01)5$ , 7–10D;  $e^{-x}I_0(x)$ ,  $e^{-x}I_1(x)$ ,  $e^xK_0(x)$ ,  $e^xK_1(x)$ ,  $x = 5(.01)10(.1)20$ , 8D. Also included are auxiliary functions to facilitate interpolation of the tables of  $K_0(x)$ ,  $K_1(x)$  for small values of  $x$ .
- **Bickley *et al.* (1952)** tabulates  $x^{-n}I_n(x)$  or  $e^{-x}I_n(x)$ ,  $x^nK_n(x)$  or  $e^xK_n(x)$ ,  $n = 2(1)20$ ,  $x = 0(.01 \text{ or } .1) 10(.1) 20$ , 8S;  $I_n(x)$ ,  $K_n(x)$ ,  $n = 0(1)20$ ,  $x = 0 \text{ or } 0.1(.1)20$ , 10S.
- **Olver (1962)** provides tables for the uniform asymptotic expansions given in §10.41(ii), including  $\eta$  and the coefficients  $U_k(p)$ ,  $V_k(p)$  as functions of  $p = (1 + x^2)^{-\frac{1}{2}}$ . These enable  $I_\nu(\nu x)$ ,  $K_\nu(\nu x)$ ,  $I'_\nu(\nu x)$ ,  $K'_\nu(\nu x)$  to be computed to 10S when  $\nu \geq 16$ .

### 10.75(iv) Integrals of Bessel Functions

- **Abramowitz and Stegun (1964, Chapter 11)** tabulates  $\int_0^x J_0(t) dt$ ,  $\int_0^x Y_0(t) dt$ ,  $x = 0(.1)10$ , 10D;  $\int_0^x t^{-1}(1 - J_0(t)) dt$ ,  $\int_x^\infty t^{-1}Y_0(t) dt$ ,  $x = 0(.1)5$ , 8D.
- **Zhang and Jin (1996, p. 270)** tabulates  $\int_0^x J_0(t) dt$ ,  $\int_0^x t^{-1}(1 - J_0(t)) dt$ ,  $\int_0^x Y_0(t) dt$ ,  $\int_x^\infty t^{-1}Y_0(t) dt$ ,  $x = 0(.1)1(.5)20$ , 8D.

### 10.75(v) Modified Bessel Functions and their Derivatives



- The main tables in Abramowitz and Stegun (1964, Chapter 9) give  $e^{-x} I_n(x)$ ,  $e^x K_n(x)$ ,  $n = 0, 1, 2$ ,  $x = 0(.1)10(.2)20$ , 8D–10D or 10S;  $\sqrt{x}e^{-x} I_n(x)$ ,  $(\sqrt{x}/\pi) e^x K_n(x)$ ,  $n = 0, 1, 2$ ,  $1/x = 0(.002)0.05$ ;  $K_0(x) + I_0(x) \ln x$ ,  $x(K_1(x) - I_1(x) \ln x)$ ,  $x = 0(.1)2$ , 8D;  $e^{-x} I_n(x)$ ,  $e^x K_n(x)$ ,  $n = 3(1)9$ ,  $x = 0(.2)10(.5)20$ , 5S;  $I_n(x)$ ,  $K_n(x)$ ,  $n = 0(1)20(10)50, 100$ ,  $x = 1, 2, 5, 10, 50, 100, 9$ –10S.
- Achenbach (1986) tabulates  $I_0(x)$ ,  $I_1(x)$ ,  $K_0(x)$ ,  $K_1(x)$ ,  $x = 0(.1)8$ , 19D or 19–21S.
- Zhang and Jin (1996, pp. 240–250) tabulates  $I_n(x)$ ,  $I'_n(x)$ ,  $K_n(x)$ ,  $K'_n(x)$ ,  $n = 0(1)10(10)50, 100$ ,  $x = 1, 5, 10, 25, 50, 100$ , 9S;  $I_{n+\alpha}(x)$ ,  $I'_{n+\alpha}(x)$ ,  $K_{n+\alpha}(x)$ ,  $K'_{n+\alpha}(x)$ ,  $n = 0(1)5, 10, 30, 50, 100$ ,  $\alpha = \frac{1}{4}, \frac{1}{3}, \frac{1}{2}, \frac{2}{3}, \frac{3}{4}$ ,  $x = 1, 5, 10, 50$ , 8S; real and imaginary parts of  $I_{n+\alpha}(z)$ ,  $I'_{n+\alpha}(z)$ ,  $K_{n+\alpha}(z)$ ,  $K'_{n+\alpha}(z)$ ,  $n = 0(1)15, 20(10)50, 100$ ,  $\alpha = 0, \frac{1}{2}$ ,  $z = 4 + 2i, 20 + 10i$ , 8S.

### 10.75(vi) Zeros of Modified Bessel Functions and their Derivatives

- Parnes (1972) tabulates all zeros of the principal value of  $K_n(z)$ , for  $n = 2(1)10, 9D$ .
- Leung and Ghaderpanah (1979), tabulates all zeros of the principal value of  $K_n(z)$ , for  $n = 2(1)10, 29S$ .
- Kerimov and Skorokhodov (1984b) tabulates all zeros of the principal values of  $K_n(z)$  and  $K'_n(z)$ , for  $n = 2(1)20, 9S$ .
- Kerimov and Skorokhodov (1984c) tabulates all zeros of  $I_{-n-\frac{1}{2}}(z)$  and  $I'_{-n-\frac{1}{2}}(z)$  in the sector  $0 \leq \text{ph } z \leq \frac{1}{2}\pi$  for  $n = 1(1)20, 9S$ .
- Kerimov and Skorokhodov (1985b) tabulates all zeros of  $K_n(z)$  and  $K'_n(z)$  in the sector  $-\frac{1}{2}\pi < \text{ph } z \leq \frac{3}{2}\pi$  for  $n = 0(1)5, 8D$ .

### 10.75(vii) Integrals of Modified Bessel Functions

- Abramowitz and Stegun (1964, Chapter 11) tabulates  $e^{-x} \int_0^x I_0(t) dt$ ,  $e^x \int_x^\infty K_0(t) dt$ ,  $x = 0(.1)10, 7D$ ;  $e^{-x} \int_0^x t^{-1}(I_0(t) - 1) dt$ ,  $x e^x \int_x^\infty t^{-1} K_0(t) dt$ ,  $x = 0(.1)5, 6D$ .
- Bickley and Nayler (1935) tabulates  $\text{Ki}_n(x)$  (§10.43(iii)) for  $n = 1(1)16$ ,  $x = 0(.05)0.2(.1) 2, 3, 9D$ .
- Zhang and Jin (1996, p. 271) tabulates  $e^{-x} \int_0^x I_0(t) dt$ ,  $e^{-x} \int_0^x t^{-1}(I_0(t) - 1) dt$ ,  $e^x \int_x^\infty K_0(t) dt$ ,  $x e^x \int_x^\infty t^{-1} K_0(t) dt$ ,  $x = 0(.1)1(.5)20, 8D$ .

### 10.75(viii) Modified Bessel Functions of Imaginary or Complex Order

For the notation see §10.45.

- Žurina and Karmazina (1967) tabulates  $\tilde{K}_\nu(x)$  for  $\nu = 0.01(.01)10$ ,  $x = 0.1(.1)10.2, 7S$ .
- Rappoport (1979) tabulates the real and imaginary parts of  $K_{\frac{1}{2}+i\tau}(x)$  for  $\tau = 0.01(.01)10$ ,  $x = 0.1(.2)9.5, 7S$ .

### 10.75(ix) Spherical Bessel Functions, Modified Spherical Bessel Functions, and their Derivatives

- The main tables in Abramowitz and Stegun (1964, Chapter 10) give  $j_n(x)$ ,  $y_n(x)$   $n = 0(1)8$ ,  $x = 0(.1)10, 5$ –8S;  $j_n(x)$ ,  $y_n(x)$   $n = 0(1)20(10)50, 100$ ,  $x = 1, 2, 5, 10, 50, 100, 10S$ ;  $i_n^{(1)}(x)$ ,  $k_n(x)$ ,  $n = 0, 1, 2$ ,  $x = 0(.1)5, 4$ –9D;  $i_n^{(1)}(x)$ ,  $k_n(x)$ ,  $n = 0(1)20(10)50, 100$ ,  $x = 1, 2, 5, 10, 50, 100, 10S$ . (For the notation see §10.1 and §10.47(ii).)
- Zhang and Jin (1996, pp. 296–305) tabulates  $j_n(x)$ ,  $j'_n(x)$ ,  $y_n(x)$ ,  $y'_n(x)$ ,  $i_n^{(1)}(x)$ ,  $i_n^{(1)'}(x)$ ,  $k_n(x)$ ,  $k'_n(x)$ ,  $n = 0(1)10(10)30, 50, 100$ ,  $x = 1, 5, 10, 25, 50, 100, 8S$ ;  $x j_n(x)$ ,  $(x j_n(x))'$ ,  $x y_n(x)$ ,  $(x y_n(x))'$  (Riccati–Bessel functions and their derivatives),  $n = 0(1)10(10)30, 50, 100$ ,  $x = 1, 5, 10, 25, 50, 100, 8S$ ; real and imaginary parts of  $j_n(z)$ ,  $j'_n(z)$ ,  $y_n(z)$ ,  $y'_n(z)$ ,  $i_n^{(1)}(z)$ ,  $i_n^{(1)'}(z)$ ,  $k_n(z)$ ,  $k'_n(z)$ ,  $n = 0(1)15, 20(10)50, 100$ ,  $z = 4 + 2i, 20 + 10i$ , 8S. (For the notation replace  $j, y, i, k$  by  $j, y, i^{(1)}, k$ , respectively.)

### 10.75(x) Zeros and Associated Values of Derivatives of Spherical Bessel Functions

For the notation see §10.58.

- Olver (1960) tabulates  $a'_{n,m}$ ,  $j_n(a'_{n,m})$ ,  $b'_{n,m}$ ,  $y_n(b'_{n,m})$ ,  $n = 1(1)20$ ,  $m = 1(1)50, 8D$ . Also included are tables of the coefficients in the uniform asymptotic expansions of these zeros and associated values as  $n \rightarrow \infty$ .

**10.75(xi) Kelvin Functions and their Derivatives**

- Young and Kirk (1964) tabulates  $\text{ber}_n x$ ,  $\text{bei}_n x$ ,  $\text{ker}_n x$ ,  $\text{kei}_n x$ ,  $n = 0, 1$ ,  $x = 0(.1)10$ , 15D;  $\text{ber}_n x$ ,  $\text{bei}_n x$ ,  $\text{ker}_n x$ ,  $\text{kei}_n x$ , modulus and phase functions  $M_n(x)$ ,  $\theta_n(x)$ ,  $N_n(x)$ ,  $\phi_n(x)$ ,  $n = 0, 1, 2$ ,  $x = 0(.01)2.5$ , 8S, and  $n = 0(1)10$ ,  $x = 0(.1)10$ , 7S. Also included are auxiliary functions to facilitate interpolation of the tables for  $n = 0(1)10$  for small values of  $x$ . (Concerning the phase functions see §10.68(iv).)
- Abramowitz and Stegun (1964, Chapter 9) tabulates  $\text{ber}_n x$ ,  $\text{bei}_n x$ ,  $\text{ker}_n x$ ,  $\text{kei}_n x$ ,  $n = 0, 1$ ,  $x = 0(.1)5$ , 9–10D;  $x^n(\text{ker}_n x + (\text{ber}_n x)(\ln x))$ ,  $x^n(\text{kei}_n x + (\text{bei}_n x)(\ln x))$ ,  $n = 0, 1$ ,  $x = 0(.1)1$ , 9D; modulus and phase functions  $M_n(x)$ ,  $\theta_n(x)$ ,  $N_n(x)$ ,  $\phi_n(x)$ ,  $n = 0, 1$ ,  $x = 0(.2)7$ , 6D;  $\sqrt{x}e^{-x/\sqrt{2}}M_n(x)$ ,  $\theta_n(x) - (x/\sqrt{2})$ ,  $\sqrt{x}e^{x/\sqrt{2}}N_n(x)$ ,  $\phi_n(x) + (x/\sqrt{2})$ ,  $n = 0, 1$ ,  $1/x = 0(.01)0.15$ , 5D.
- Zhang and Jin (1996, p. 322) tabulates  $\text{ber } x$ ,  $\text{ber}'x$ ,  $\text{bei } x$ ,  $\text{bei}'x$ ,  $\text{ker } x$ ,  $\text{ker}'x$ ,  $\text{kei } x$ ,  $\text{kei}'x$ ,  $x = 0(1)20$ , 7S.

**10.75(xii) Zeros of Kelvin Functions and their Derivatives**

- Zhang and Jin (1996, p. 323) tabulates the first 20 real zeros of  $\text{ber } x$ ,  $\text{ber}'x$ ,  $\text{bei } x$ ,  $\text{bei}'x$ ,  $\text{ker } x$ ,  $\text{ker}'x$ ,  $\text{kei } x$ ,  $\text{kei}'x$ , 8D.

**10.76 Approximations****10.76(i) Introduction**

Because of the comprehensive nature of more recent software packages (§10.77), the following subsections include only references that give representative examples of the kind of approximations that can be used to generate the functions that appear in the present chapter. For references to other approximations, see for example, Luke (1975, §9.13.3).

**10.76(ii) Bessel Functions, Hankel Functions, and Modified Bessel Functions****Real Variable and Order : Functions**

Luke (1971a,b, 1972), Luke (1975, Tables 9.1, 9.2, 9.5, 9.6, 9.11–9.15, 9.17–9.21), Weniger and Čížek (1990), Németh (1992, Chapters 4–6).

**Real Variable and Order : Zeros**

Piessens (1984, 1990), Piessens and Ahmed (1986), Németh (1992, Chapter 7).

**Real Variable and Order : Integrals**

Luke (1975, Tables 9.3, 9.4, 9.7–9.9, 9.16, 9.22), Németh (1992, Chapter 10).

**Complex Variable; Real Order**

Luke (1975, Tables 9.23–9.28), Coleman and Monaghan (1983), Coleman (1987), Zhang (1996), Zhang and Belward (1997).

**Real Variable; Imaginary Order**

Poquérusse and Alexiou (1999).

**10.76(iii) Other Functions****Bickley Functions**

Blair *et al.* (1978).

**Spherical Bessel Functions**

Delic (1979).

**Kelvin Functions**

Luke (1975, Table 9.10), Németh (1992, Chapter 9).

**10.77 Software**

See <http://dlmf.nist.gov/10.77>.

**References****General References**

The main references used in writing this chapter are Watson (1944) and Olver (1997b).

**Sources**

The following list gives the references or other indications of proofs that were used in constructing the various sections of this chapter. These sources supplement the references that are quoted in the text.

§10.2 Olver (1997b, pp. 57, 237–238, 242–243) and Watson (1944, pp. 38–45, 57–64, 196–198). The conclusions in §10.2(iii) follow from §2.7(iv) and the limiting forms of the solutions as  $z \rightarrow 0$  and as  $z \rightarrow \infty$ ; see §10.7.

§10.3 These graphics were produced at NIST.

§10.4 Olver (1997b, pp. 56, 238–239, 242–243) and Watson (1944, pp. 74–75).

§10.5 For the Wronskians use (1.13.5) and the limiting forms in §10.7. Then for the cross-products apply (10.6.2).

**§10.6** For (10.6.1) and (10.6.2) see Olver (1997b, pp. 58–59, 240–242) or Watson (1944, pp. 45, 66, 73–74). (10.6.3) are special cases, and (10.6.4), (10.6.5) follow by straightforward substitution. For (10.6.6) see Watson (1944, pp. 46). For (10.6.7) use induction combined with the second of (10.6.1). For (10.6.8)–(10.6.10) see Goodwin (1949b).

**§10.7** For (10.7.1) and (10.7.3) use (10.2.2) and (10.8.2). For (10.7.2) use (10.4.3) and (10.7.1). For (10.7.4) and (10.7.5) use (10.2.3) and (10.7.3) when  $\nu$  is not an integer; (10.4.1), (10.8.1) otherwise. For (10.7.6) use (10.2.3) and (10.7.3). For (10.7.7) use (10.4.3), (10.7.3), and (10.7.4). For (10.7.8) see (10.17.3) and (10.17.4).

**§10.8** Olver (1997b, p. 243) and Watson (1944, p. 147).

**§10.9** Watson (1944, pp. 19–21, 47–48, 68–71, 150, 160–170, 174–180, 436, 438, 441–444). For (10.9.3) see Olver (1997b, p. 244) (with “Exercises 2.2 and 9.5” corrected to “Exercises 2.3 and 9.5”). For (10.9.5), (10.9.10), (10.9.11), (10.9.13), (10.9.14) see Erdélyi *et al.* (1953b, pp. 18, 21, 82). (The condition  $\Re(z \pm \zeta) > 0$  in (10.9.14) is weaker than the corresponding condition in Erdélyi *et al.* (1953b, p. 82, Eq. (18)).) (10.9.15), (10.9.16) follow from (10.9.10), (10.9.11) by change of variables  $z = \zeta \cosh \phi$ ,  $t \rightarrow t - \ln \tanh(\frac{1}{2}\phi)$ ,  $\phi > 0$ . For (10.9.27) see Erdélyi *et al.* (1953b, p. 47). See also Olver (1997b, pp. 340–341).

**§10.10** Watson (1944, §§5.6, 9.65).

**§10.11** For (10.11.1)–(10.11.5) use (10.2.2), (10.2.3), (10.4.3). For (10.11.6)–(10.11.8) take limits. For (10.11.9) use the Schwarz Reflection Principle (§1.10(ii)).

**§10.12** For (10.12.1) see Olver (1997b, pp. 55–56). For (10.12.2)–(10.12.6) set  $t = e^{i\theta}$  and  $ie^{i\theta}$ , and apply other straightforward substitutions, including differentiations with respect to  $\theta$  in the case of (10.12.6). See also Watson (1944, pp. 22–23).

**§10.13** These results are obtainable from (10.2.1) by straightforward substitutions. See also §1.13(v).

**§10.14** Watson (1944, pp. 49, 258–259, 268–270, 406) and Olver (1997b, pp. 59, 426).

**§10.15** For (10.15.1) see Watson (1944, pp. 61–62) or Olver (1997b, p. 243). For (10.15.2) use (10.2.3). For (10.15.3)–(10.15.5) see Olver (1997b, p. 244). (10.15.6)–(10.15.9) appear without proof in Magnus *et al.* (1966, §3.3.3). To derive (10.15.6)

the left-hand side satisfies the differential equation  $x^2(d^2W/dx^2) + x(dW/dx) + (x^2 - \frac{1}{4})W = \sqrt{2/(\pi x)} \sin x$ , obtained by differentiating (10.2.1) with respect to  $\nu$ , setting  $\nu = \frac{1}{2}$ , and referring to (10.16.1) for  $w$ . This inhomogeneous equation for  $W$  can be solved by variation of parameters (§1.13(ii)), using the fact that independent solutions of the corresponding homogeneous equation are  $J_{\frac{1}{2}}(x)$  and  $Y_{\frac{1}{2}}(x)$  with Wronskian  $2/(\pi x)$ , and subsequently referring to (6.2.9) and (6.2.11). Similarly for (10.15.7). (10.15.8) and (10.15.9) follow from (10.15.2), (10.15.6), (10.15.7), and (10.16.1).

**§10.16** For (10.16.3), (10.16.4) see Miller (1955, p. 43). For (10.16.5) and (10.16.6) see Olver (1997b, pp. 255, 259) and apply (10.27.8). For (10.16.7) and (10.16.8) apply (13.14.4) and (13.14.5). For (10.16.9) combine (10.2.2) and (16.2.1).

**§10.17** Olver (1997b, pp. 237–242, 266–269), Watson (1944, pp. 205–206). (10.17.8)–(10.17.12) follow by differentiation of the corresponding expansions in §10.17(i); compare §2.1(iii). For (10.17.16)–(10.17.18) see Olver (1991b, Theorem 1) or Olver (1993a, Theorem 1.1), and (10.16.6).

**§10.18** For (10.18.3) see §10.7(i). (10.18.4)–(10.18.16) are verifiable by straightforward substitutions. For (10.18.17), and also the concluding paragraph of §10.18(iii), see Watson (1944, pp. 448–449). For (10.18.19) substitute into  $N_\nu^2(x) = H_\nu^{(1)'}(x)H_\nu^{(2)'}(x)$  by means of (10.17.11), (10.17.12). The general term in (10.18.20) can be verified via (10.18.10). For (10.18.18) the first two terms can be found from (10.18.7), (10.17.3), (10.17.4), except for an arbitrary integer multiple of  $\pi$ . Higher terms can be calculated via (10.18.8), (10.18.17). By continuity, the multiple of  $\pi$  is independent of  $\nu$ , hence it may be determined, e.g. by setting  $\nu = \frac{1}{2}$  and referring to (10.16.1). Similar methods can be used for (10.18.21), together with the interlacing properties of the zeros of  $J_{1/2}(z)$ ,  $Y_{1/2}(z)$ , and their derivatives (§10.21(i)). See also Bickley *et al.* (1952, p. xxxiv).

**§10.19** (10.19.1), (10.19.2) follow from (10.2.2), (10.2.3), (10.4.3), (10.8.1), (5.5.3), (5.11.3). For (10.19.3) and (10.19.6) see Watson (1944, pp. 241–245) and Bickley *et al.* (1952, p. xxxv). The expansions for the derivatives are established in a similar manner, with the coefficients calculated by term-by-term differentiation; compare §2.1(iii).

**§10.20** Olver (1997b, pp. 419–425), Olver (1954).

- §10.21** For §10.21(i) see Watson (1944, pp. 477–487), Olver (1997b, pp. 244–249), Döring (1971), and Kerimov and Skorokhodov (1985a). For §10.21(ii) see Watson (1944, pp. 508 and 510) and Olver (1950). (In the latter reference  $t$  in (10.21.4) is replaced by  $-t$ .) (10.21.5) and (10.21.6) follow from (10.6.2). (10.21.12) and (10.21.13) follow from (10.18.3), (10.21.2), (10.21.3), and the fact that  $\theta_\nu(x)$  is increasing when  $x > 0$ , whereas  $\phi_\nu(x)$  is decreasing when  $0 < x < \nu$  and increasing when  $x > \nu$ ; compare (10.18.8). For (10.21.15), (10.21.16) see Watson (1944, pp. 497–498). For §10.21(iv) see Watson (1944, pp. 508–510), Lorch (1990, 1995), Wong and Lang (1991), McCann (1977), Lewis and Muldoon (1977), and Mercer (1992). For (10.21.19) see Watson (1944, pp. 503–507) or Olver (1997b, pp. 247–248). Similar methods can be used for (10.21.20). For (10.21.22)–(10.21.40) see Olver (1951, 1952). The zeros depicted in Figures 10.21.1–10.21.6 were computed at NIST using methods referred to in §10.74(vi). For (10.21.48)–(10.21.54) see McMahon (1949), Gray *et al.* (1922, p. 261), and Cochran (1964).
- §10.22** For (10.22.1)–(10.22.3) differentiate and use (10.6.2), (11.4.27), (11.4.28). For (10.22.4)–(10.22.7) see Watson (1944, pp. 132–136). For (10.22.8)–(10.22.12) see Luke (1962, pp. 51–53). To verify (10.22.13) construct the expansion of the left-hand side in powers of  $z$  by use of (10.2.2), followed by term-by-term integration with the aid of (5.12.5) and (5.12.1). Then compare the result with the corresponding expansion of the right-hand side obtained from (10.8.3). Next, the result  $\int_0^{2\pi} J_{2\nu}(2z \sin \theta) e^{\pm 2i\mu\theta} d\theta = \pi e^{\pm i\mu\pi} J_{\nu+\mu}(z) J_{\nu-\mu}(z)$ ,  $\Re \nu > -\frac{1}{2}$ , is proved in a similar manner with the aid of (5.12.6) in place of (5.12.5)—from which (10.22.14) and (10.22.15) both follow. (10.22.17) follows by combining (10.22.13) and (10.2.3); (10.22.16) is a special case of (10.22.14). For (10.22.18) replace  $\theta$  by  $\frac{1}{2}\pi - \theta$  and set  $\mu = n$  in (10.22.17); then apply (10.2.3) and let  $\nu \rightarrow 0$ . For (10.22.19), (10.22.22), (10.22.25), (10.22.26) see Watson (1944, Chapter 12). (In the case of (10.22.25), page 374 of this reference lacks a factor  $\frac{1}{2}$  on the right-hand side.) The verification of (10.22.20) is similar to that of (10.22.13), the role of (5.12.5) now being played by (5.12.2). For (10.22.21) combine (10.2.3) and (10.22.20). For (10.22.23) and (10.22.24) see Luke (1962, p. 302 (36) and p. 303 (39), respectively). For (10.22.27) see Watson (1944, p. 151). For (10.22.28), (10.22.29) differentiate and use (10.6.2). For (10.22.30) with  $n \geq 1$  it follows by differentiation and use of (10.6.2) that the left-hand side equals  $\int_0^x t^{-1} J_n^2(t) dt - \frac{1}{2} J_n^2(x)$ ; application of Watson (1944, p. 152) yields the second result, then for the first result refer to (10.23.3). Some modifications of the proof of (10.22.30) are needed when  $n = 0$ . For (10.22.31)–(10.22.35) see Watson (1944, p. 380). For (10.22.36) replace  $t$  by  $z - t$ , substitute for  $t^\alpha$  via (10.23.15) (with  $z$  replaced by  $t$ , and  $\nu$  replaced by  $\alpha$ ), and then apply (10.22.34). For (10.22.37) use (10.22.4) and (10.22.5); a similar proof applies to (10.22.38) after replacing  $\mathcal{C}_{\mu\pm 1}(az)$  and  $\mathcal{D}_{\mu\pm 1}(bz)$  by  $\mp \mathcal{C}'_\mu(az)$  and  $\mp \mathcal{D}'_\mu(bz)$ , respectively, by means of (10.6.2). For the first result in (10.22.39) use (10.22.43) with  $\nu = 0$  and  $\mu$  replaced by  $\mu - 1$ , split the integration range at  $t = x$  and take limits as  $\mu \rightarrow 0$ ; for the second result substitute into the first result by (10.2.2) and integrate term by term. (10.22.40), is proved in a similar manner, starting from (10.22.44) and substituting by means of (10.8.2) and (10.2.2) with  $\nu = 0$  for the term-by-term integration. For (10.22.41)–(10.22.45) see Luke (1962, pp. 56–57). For (10.22.46) see Erdélyi *et al.* (1953b, p. 96). (10.22.47) is the special case of Eq. (6) of Watson (1944, §13.53) obtained by setting  $\mu = b = 0$ ,  $\rho = \nu + 1$ , and subsequently replacing  $k$  by  $b$ . For (10.22.48) see Sneddon (1966, Eq. (2.1.32)). For (10.22.49)–(10.22.59) see Watson (1944, pp. 385, 394, 403–405, 407; there is an error in Eq. (1), p. 407). For (10.22.60) differentiate (10.22.59) with respect to  $\mu$  and use (10.2.4) with  $n = 0$ . For (10.22.61) see Watson (1944, p. 405). (10.22.62) follows from (10.22.56) with  $\lambda = \nu - \mu - 1$  and (15.4.6). For (10.22.63), (10.22.64) see Watson (1944, p. 404). For (10.22.65) apply (10.22.56) with  $\mu = \nu = 0$ , then let  $\lambda \rightarrow 1$ . For (10.22.66), (10.22.67) see Watson (1944, pp. 389, 395). For (10.22.68) set  $a = b$  in (10.22.67), differentiate with respect to  $\nu$  and apply (10.2.4) and (10.27.5) with  $n = 0$ . For (10.22.69), (10.22.70), see Watson (1944, p. 429, Eqs. (3),(4), with  $\mu = \nu + 1$  in (3)). For (10.22.71), (10.22.72) see Watson (1944, pp. 411, 412). For (10.22.74), (10.22.75) see Watson (1944, pp. 411) and Askey *et al.* (1986).
- §10.23** Watson (1944, §§5.22, 11.3, 11.4, 16.11 and pp. 64, 67, 71, 138). (10.23.2) is obtained from (10.23.7) by taking  $\chi = 0$  and  $\alpha = 0, \pi$ . For (10.23.21) see Temme (1996a, p. 247).
- §10.24** (10.24.6)–(10.24.9) follow from (10.24.2)–(10.24.4) combined with (10.2.2), (10.2.3), (10.8.2), (10.17.3), and (10.17.4). (10.24.5) can be verified from (1.13.5) and either (10.24.6) or

- (10.24.7)–(10.24.9) and their differentiated forms.
- §10.25** Olver (1997b, pp. 60, 236–237, 250). The conclusions in §10.25(iii) follow from §2.7(iv) and the limiting forms of the solutions as  $z \rightarrow 0$  and  $z \rightarrow \infty$ ; see (10.25.3) and §10.30. See also (10.27.3).
- §10.26** These graphics were produced at NIST.
- §10.27** For (10.27.1)–(10.27.6) and (10.27.8) see Olver (1997b, pp. 60–61 and 250–252), Watson (1944, pp. 77–79), and (10.11.5). For (10.27.7), (10.27.9),–(10.27.11) combine these results with (10.4.4), and also use (10.34.2) with  $m = 1$ .
- §10.28** For the Wronskians use (1.13.5) and the limiting forms in §10.30. For the cross-products apply (10.29.2).
- §10.29** Watson (1944, p. 79). For (10.29.5) use induction combined with the second of (10.29.1).
- §10.30** For (10.30.1) use (10.25.2). For (10.30.2) and (10.30.3) use (10.27.4) when  $\nu$  is not an integer; (10.27.3), (10.31.1) otherwise. For (10.30.4), (10.30.5) use (10.40.1) and (10.34.1) with  $m = \pm 1$ .
- §10.31** Olver (1997b, p. 253) or Watson (1944, p. 80). For (10.31.3) combine (10.8.3) and (10.27.6).
- §10.32** Watson (1944, pp. 79, 80, 172, 181–183, 191, 193, 439–441), Erdélyi *et al.* (1953b, p. 82, 97–98), Paris and Kaminski (2001, p. 114). Also use (10.27.8). For (10.32.16) see Dixon and Ferrar (1930). (An error in the conditions has been corrected.) For (10.32.19) see Titchmarsh (1986a, Eq. (7.10.2)).
- §10.33** Combine (10.10.1), (10.10.2) with (10.27.6).
- §10.34** Watson (1944, p. 80) and Olver (1997b, pp. 253, 381). For (10.34.3) take  $m = \pm 1$  in (10.34.2), and combine with (10.34.1).
- §10.35** For (10.35.1) replace  $z$  and  $t$  in (10.12.1) by  $iz$  and  $-it$ , respectively, and apply (10.27.6). (10.35.2)–(10.35.6) are obtained by setting  $t = e^{i\theta}$ ,  $t = -ie^{i\theta}$ , together with other straightforward substitutions.
- §10.37** Olver (1997b, pp. 251–252). For (10.37.1) see Everitt and Jones (1977).
- §10.38** (10.38.1) is obtained by differentiation of (10.25.2); compare (10.15.1). For (10.38.2) use (10.27.4). (10.38.3)–(10.38.5) are proved in a similar way to (10.15.3)–(10.15.5). (10.38.6) and (10.38.7) are stated without proof and in a slightly different notation in Magnus *et al.* (1966, §3.3.3).
- Both cases of (10.38.6) can be derived by a method analogous to that used for (10.15.6) and (10.15.7). (10.38.7) follows from (10.38.2) and (10.38.6).
- §10.39** For (10.39.5)–(10.39.10) combine (10.16.5)–(10.16.10) with (10.27.6) and (10.27.8).
- §10.40** Watson (1944, pp. 202–203, 206–207), Olver (1997b, pp. 250–251, 266–269, 325). Also use (10.27.8). (10.40.3) and (10.40.4) are obtained by differentiation of (10.40.1) and (10.40.2); compare §2.1(iii). (10.40.6) and (10.40.7) are obtained by multiplication of (10.40.1)–(10.40.4): that the coefficients are the same as in (10.18.17) and (10.18.19) is a consequence of the fact that  $I_\nu(x)K_\nu(x)$  and  $I'_\nu(x)K'_\nu(x)$  satisfy the same differential equations as  $M_\nu^2(x) = |H_\nu^{(1)}(x)|^2 = H_\nu^{(1)}(x)H_\nu^{(2)}(x)$  and  $N_\nu^2(x) = |H_\nu^{(1)'}(x)|^2 = H_\nu^{(1)'}(x)H_\nu^{(2)'}(x)$ , respectively, except for replacement of  $x$  by  $ix$ . For the statement concerning the accuracy of (10.40.5) use the error bounds given by (10.40.10)–(10.40.12). For (10.40.14) see Olver (1991b) together with (10.39.6).
- §10.41** Olver (1997b, pp. 374–378). For (10.41.1), (10.41.2) combine (10.19.1), (10.19.2) with (10.27.6), (10.27.8).
- §10.42** Watson (1944, pp. 511–513) and Olver (1997b, p. 254).
- §10.43** For (10.43.1)–(10.43.3) differentiate, apply (10.29.2), and also (11.4.29) and (11.4.30) in the case of (10.43.2). For (10.43.4) replace  $x$  by  $ix$  in (10.22.11), (10.22.12) and use (10.27.6). For (10.43.5) combine (10.22.39) and (10.22.40) by means of (10.4.3) to obtain an expansion for  $\int_x^\infty (H_0^{(1)}(t)/t) dt$ ; then replace  $x$  by  $ix$  and use (10.27.8). For (10.43.6)–(10.43.10) differentiate, apply §10.29(i) and also verify the limiting behavior as  $x \rightarrow 0$  or  $x \rightarrow \infty$ . For (10.43.12) substitute into (10.43.11) by means of (10.32.9) with  $\nu = 0$ , invert the order of integration and apply (5.2.1). (10.43.13)–(10.43.16) follow from (10.43.12), and in the case of (10.43.16), (5.12.1). For (10.43.17) see Bickley and Nayler (1935). For §10.43(iv) see Watson (1944, pp. 388, 394–395, 410). For some results it is necessary to use the connection formulas (10.27.6); for example, to obtain (10.43.23) set  $a = ib$  in Watson (1944, p. 394, Eq. (4)). Equations (10.43.22) follow from Eq. (7) of Watson (1944, §13.21). For (10.43.25) see Erdélyi *et al.* (1953b, p. 51). For (10.43.29) combine (10.22.68),

- (10.27.6), (10.27.10). In §10.43(v), for Conditions (a) see Sneddon (1972, pp. 359–361). For Conditions (b) see Lebedev *et al.* (1965, pp. 194–196).
- §10.44** For (10.44.1) combine (10.23.1) with (10.27.6) or with (10.27.8). Equations (10.44.2) are special cases of (10.23.1) and (10.44.1) with  $\lambda = i$ . For (10.44.3) combine (10.23.2) and (10.27.1) with (10.27.6) or with (10.27.8). For (10.44.4)–(10.44.6) combine (10.23.15)–(10.23.17) with (10.27.6), (10.27.8), and (10.4.3).
- §10.45** Equations (10.45.5)–(10.45.8) follow from (10.25.2), (10.27.4), (10.31.2), (10.40.1), and (10.40.2). The Wronskian (10.45.4) can be verified from (1.13.5) and either (10.45.5) or (10.45.6)–(10.45.8) and their differentiated forms.
- §10.47** For (10.47.3)–(10.47.9) use (10.2.3), (10.4.6), (10.27.3). For §10.47(iii) use §10.52. For (10.47.10)–(10.47.13) use (10.4.3), (10.27.4), (10.27.6), (10.27.8), and the definitions (10.47.3)–(10.47.9). For (10.47.14)–(10.47.16) use (10.11.1), (10.11.2), (10.34.1), with  $m = 1$  in each case, and the definitions (10.47.3)–(10.47.9). For (10.47.17) use (10.47.11) and (10.47.16).
- §10.48** These graphs were produced at NIST.
- §10.49** For (10.49.1)–(10.49.7) observe that when  $\nu = n + \frac{1}{2}$  the asymptotic expansions (10.17.3)–(10.17.6) terminate, and as a consequence of the error bounds of §10.17(iv) they represent the left-hand sides exactly. For (10.49.8)–(10.49.13) use the same method as for (10.49.1)–(10.49.7), or combine the results of §10.49(i) with (10.47.12) and (10.47.13). For the first of (10.49.14) combine the second of (10.51.3), with  $n = 0$  and  $m = n$ , and the first of (10.49.3). Similarly for the second of (10.49.14) and also (10.49.15), (10.49.16). For (10.49.18) observe that from (10.18.6), (10.47.3), and (10.47.4),  $j_n^2(z) + y_n^2(z) = (\pi/(2z)) M_{n+\frac{1}{2}}^2(z)$ . Then apply (10.18.17). To derive (10.49.20) combine (10.47.12) and (10.49.18).
- §10.50** That the Wronskians are constant multiples of  $z^{-2}$  follows from (1.13.5). The constants can be found from the limiting forms (and their derivatives) given in §§10.52(i) or 10.52(ii). For (10.50.3) combine (10.50.1) with (10.51.1) and (10.51.2). For (10.50.4) use (10.49.2)–(10.49.5).
- §10.51** For (10.51.1) and (10.51.2) combine (10.6.1) and (10.6.2) with the definitions (10.47.3)–(10.47.5). For (10.51.3) apply induction with the aid of (10.51.2). For (10.51.4) and (10.51.5) combine (10.29.1) and (10.29.2) with the definitions (10.47.7) and (10.47.9). For (10.51.6) apply induction with the aid of (10.51.5).
- §10.52** For (10.52.1), (10.52.2) use §10.53. For (10.52.3)–(10.52.6) use (10.49.2), (10.49.4), (10.49.6)–(10.49.8), (10.49.10), and (10.49.12).
- §10.53** Combine (10.2.2) and (10.25.2) with (10.47.3), (10.47.4), and (10.47.7).
- §10.54** Watson (1944, pp. 50 and 174–175). For (10.54.1) use (10.9.4).
- §10.56** To verify (10.56.1) and (10.56.2) show that each side of both equations satisfies the differential equation  $(2t - z)(d^2w/dt^2) + (dw/dt) = zw$  via the first of (10.51.1) and (10.49.3), (10.49.5). Then check the initial conditions at  $t = 0$ . (10.56.3) and (10.56.4) follow from (10.56.1) and (10.56.2) via (10.47.12); then (10.56.5) follows from (10.47.11).
- §10.57** For (10.57.1) use the differentiated form of the first of (10.47.3).
- §10.59** For (10.59.1) suppose first  $b \neq 0$ . The left-hand side is  $2i \int_0^\infty \sin(bt) j_n(t) dt$  or  $2 \int_0^\infty \cos(bt) j_n(t) dt$  according as  $n$  is odd or even, see (10.47.14). Next, apply (10.22.64) with  $a = 1$ ,  $\mu = \frac{1}{2}$  or  $-\frac{1}{2}$ , and subsequently replace  $2n + 1$  or  $2n$  by  $n$ . For  $J_{\pm(1/2)}(bt)$  and  $J_{n+(1/2)}(t)$  we have (10.16.1) and (10.47.3); also the function  ${}_2F_1$  is interpreted as a Legendre polynomial for both odd and even  $n$  via (14.3.11), (14.3.13), and (14.3.14). When  $b = 0$ , use (10.22.43), (10.47.3), and also  $P_n(0) = (-1)^{\frac{1}{2}n} (\frac{1}{2})_{\frac{1}{2}n} / (\frac{1}{2}n)!$  or 0, according as the non-negative integer  $n$  is even or odd; see (14.5.1) and §5.5.
- §10.60** For (10.60.1)–(10.60.3) use (10.23.8) with  $\nu = \frac{1}{2}$  and  $\mathcal{C} = Y, J, H^{(1)}$ ; subsequently apply (10.47.12) and (10.47.13) in the case of (10.60.3). For (10.60.4) set  $\mathcal{C}_\nu = Y_\nu$ ,  $u = v = z$ ,  $\nu = -n - \frac{1}{2}$ , and  $\alpha = \pi$  in (10.23.8). Then refer to (10.47.3), (10.47.4), and also apply the following results obtained from Table 18.6.1:  $C_k^{(-n-\frac{1}{2})}(-1)$  equals  $(2n+1)!/(k!(2n+1-k)!)$  when  $k = 0, 1, \dots, 2n+1$ , and equals 0 when  $k = 2n+2, 2n+3, \dots$ . For (10.60.5) use the same procedure, but with  $\mathcal{C}_\nu = J_\nu$ . (10.60.6) follows by combining (10.60.4) and (10.60.5) with §10.47(iv). For (10.60.7)–(10.60.9) see Watson (1944, pp.368–369). For (10.60.10) use Watson (1944, p. 370, Eq. (9)) with  $\nu = \frac{1}{2}$ ,  $\phi = \alpha$ ,  $\phi' = \frac{1}{2}\pi$ ; also

Eq. (18.7.9). For (10.60.11) see Watson (1944, p. 152). For (10.60.12) and (10.60.13) substitute  $u = v = z$ , with  $\alpha = 0$  and  $\pi$ , into (10.60.2). For (10.60.14) see Vavreck and Thompson (1984).

**§10.61** For (10.61.3) set  $z = xe^{3\pi i/4}$  in (10.2.1). (10.61.4) follows by taking real and imaginary parts, and straightforward substitutions. For (10.61.5)–(10.61.8) see Whitehead (1911). (10.61.11) and (10.61.12) follow from the terminating forms of (10.67.1) and (10.67.2). Then (10.61.9) and (10.61.10) follow from these results and the terminating forms of (10.67.3) and (10.67.4). (Compare the derivation of the results given in §10.49(i) from (10.17.3)–(10.17.6).) The version of (10.61.9)–(10.61.10) given in Apelblat (1991) contains two sign errors.

**§10.62** These graphs were produced at NIST.

**§10.63** For (10.63.1)–(10.63.4) set  $z = xe^{3\pi i/4}$  in (10.6.1) and (10.6.2). For (10.63.5)–(10.63.7) set  $a = xe^{3\pi i/4}$ . Then from (10.61.1) and (10.63.5)  $J_\nu(a) J_\nu(\bar{a}) = p_\nu$ ,  $J'_\nu(a) J'_\nu(\bar{a}) = s_\nu$ ,  $J_\nu(a) J'_\nu(\bar{a}) = e^{3\pi i/4}(r_\nu - iq_\nu)$ ,  $J_\nu(\bar{a}) J'_\nu(a) = e^{-3\pi i/4}(r_\nu + iq_\nu)$ . Combine these results with (10.6.2) and eliminate the derivatives. See also Petiau (1955, pp. 266–267) (but this reference contains errors). For the functions  $\ker_\nu x$  and  $\kei_\nu x$  use the second of (10.61.2).

**§10.65** Whitehead (1911). For (10.65.1), (10.65.2) combine (10.2.2), (10.61.1). For (10.65.3)–(10.65.5) combine (10.31.1), (10.61.1), and (10.61.2); see also Young and Kirk (1964, p. x).

**§10.66** For (10.66.1) apply (10.23.1) with  $\mathcal{C} = J$  and  $\lambda = e^{3\pi i/4}$ ; also (10.44.1) with  $\mathcal{L} = I$  and  $\lambda =$

$e^{\pi i/4}$ . For (10.66.2) apply (10.23.2) with  $\mathcal{C} = J$ ,  $\nu = n$ ,  $u = -x$ ,  $v = ix$ , and equate real and imaginary parts.

**§10.67** For (10.67.1)–(10.67.8) combine (10.61.1), (10.61.2), and their differentiated forms with (10.40.1)–(10.40.4). To obtain the exponentially-small terms in (10.67.3), (10.67.4), (10.67.7), and (10.67.8), use the identity  $\pi i I_\nu(xe^{\pi i/4}) = K_\nu(xe^{-3\pi i/4}) - e^{\nu\pi i} K_\nu(xe^{\pi i/4})$ , obtained from (10.27.6) and (10.27.9). The final sentence in §10.67(i) is justified by error bounds obtained as in §10.40(iii). For (10.67.9)–(10.67.16), first replace the cos and sin functions in (10.67.1)–(10.67.4) by exponential functions by constructing the corresponding expansions for  $\text{ber}_\nu x \pm i \text{bei}_\nu x$  and  $\text{ker}_\nu x \pm i \text{kei}_\nu x$  and discarding the exponentially-small terms. Then set  $\nu = 0$  and apply straightforward manipulations.

**§10.68** (10.68.3)–(10.68.15) are derived from the definitions §10.68(i), the differential equation (10.61.3), the reflection formulas in §10.61(iv), and recurrence relations in §10.63(i) by straightforward manipulations. For (10.68.16)–(10.68.21) combine (10.68.5) and (10.68.6) with (10.67.1)–(10.67.4), ignoring the exponentially-small terms in (10.67.3) and (10.67.4). See also Whitehead (1911) and Young and Kirk (1964, pp. xiv–xv).

**§10.69** Combine the results given in §§10.41(ii) and 10.41(iii) with the definitions (10.61.1) and (10.61.2).

**§10.70** Revert (10.68.18) and (10.68.21) (§2.2).

**§10.71** Differentiate and use (10.63.2) and (10.68.5). See also Young and Kirk (1964, pp. xvi–xvii).

## Chapter 11

# Struve and Related Functions

R. B. Paris<sup>1</sup>

<b>Notation</b>	<b>288</b>	11.10 Anger–Weber Functions . . . . .	295
11.1 Special Notation . . . . .	288	11.11 Asymptotic Expansions of Anger–Weber Functions . . . . .	297
<b>Struve and Modified Struve Functions</b>	<b>288</b>	<b>Applications</b>	<b>298</b>
11.2 Definitions . . . . .	288	11.12 Physical Applications . . . . .	298
11.3 Graphics . . . . .	289	<b>Computation</b>	<b>298</b>
11.4 Basic Properties . . . . .	291	11.13 Methods of Computation . . . . .	299
11.5 Integral Representations . . . . .	292	11.14 Tables . . . . .	299
11.6 Asymptotic Expansions . . . . .	293	11.15 Approximations . . . . .	300
11.7 Integrals and Sums . . . . .	293	11.16 Software . . . . .	300
11.8 Analogs to Kelvin Functions . . . . .	294	<b>References</b>	<b>300</b>
<b>Related Functions</b>	<b>294</b>		
11.9 Lommel Functions . . . . .	294		

<sup>1</sup>Division of Mathematical Sciences, University of Abertay Dundee, Dundee, United Kingdom.

**Acknowledgments:** This chapter is based in part on Abramowitz and Stegun (1964, Chapter 12) by M. Abramowitz. The author is indebted to Adri Olde Daalhuis for correcting a long-standing error in Eq. (11.10.23) in previous literature.

**Copyright** © 2009 National Institute of Standards and Technology. All rights reserved.



## Notation

### 11.1 Special Notation

(For other notation see pp. xiv and 873.)

- $x$  real variable.
- $z$  complex variable.
- $\nu$  real or complex order.
- $n$  integer order.
- $k$  nonnegative integer.
- $\delta$  arbitrary small positive constant.

Unless indicated otherwise, primes denote derivatives with respect to the argument. For the functions  $J_\nu(z)$ ,  $Y_\nu(z)$ ,  $H_\nu^{(1)}(z)$ ,  $H_\nu^{(2)}(z)$ ,  $I_\nu(z)$ , and  $K_\nu(z)$  see §§10.2(ii), 10.25(ii).

The functions treated in this chapter are the Struve functions  $\mathbf{H}_\nu(z)$  and  $\mathbf{K}_\nu(z)$ , the modified Struve functions  $\mathbf{L}_\nu(z)$  and  $\mathbf{M}_\nu(z)$ , the Lommel functions  $s_{\mu,\nu}(z)$  and  $S_{\mu,\nu}(z)$ , the Anger function  $\mathbf{J}_\nu(z)$ , the Weber function  $\mathbf{E}_\nu(z)$ , and the associated Anger–Weber function  $\mathbf{A}_\nu(z)$ .

## Struve and Modified Struve Functions

### 11.2 Definitions

#### 11.2(i) Power-Series Expansions

$$11.2.1 \quad \mathbf{H}_\nu(z) = \left(\frac{1}{2}z\right)^{\nu+1} \sum_{n=0}^{\infty} \frac{(-1)^n \left(\frac{1}{2}z\right)^{2n}}{\Gamma\left(n + \frac{3}{2}\right) \Gamma\left(n + \nu + \frac{3}{2}\right)},$$

$$\mathbf{L}_\nu(z) = -ie^{-\frac{1}{2}\pi i\nu} \mathbf{H}_\nu(iz)$$

$$11.2.2 \quad = \left(\frac{1}{2}z\right)^{\nu+1} \sum_{n=0}^{\infty} \frac{\left(\frac{1}{2}z\right)^{2n}}{\Gamma\left(n + \frac{3}{2}\right) \Gamma\left(n + \nu + \frac{3}{2}\right)}.$$

Principal values correspond to principal values of  $\left(\frac{1}{2}z\right)^{\nu+1}$ ; compare §4.2(i).

The expansions (11.2.1) and (11.2.2) are absolutely convergent for all finite values of  $z$ . The functions  $z^{-\nu-1} \mathbf{H}_\nu(z)$  and  $z^{-\nu-1} \mathbf{L}_\nu(z)$  are entire functions of  $z$  and  $\nu$ .

$$11.2.3 \quad \mathbf{H}_0(z) = \frac{2}{\pi} \left( z - \frac{z^3}{1^2 \cdot 3^2} + \frac{z^5}{1^2 \cdot 3^2 \cdot 5^2} - \cdots \right),$$

$$11.2.4 \quad \mathbf{L}_0(z) = \frac{2}{\pi} \left( z + \frac{z^3}{1^2 \cdot 3^2} + \frac{z^5}{1^2 \cdot 3^2 \cdot 5^2} + \cdots \right).$$

$$11.2.5 \quad \mathbf{K}_\nu(z) = \mathbf{H}_\nu(z) - Y_\nu(z),$$

$$11.2.6 \quad \mathbf{M}_\nu(z) = \mathbf{L}_\nu(z) - I_\nu(z).$$

Principal values of  $\mathbf{K}_\nu(z)$  and  $\mathbf{M}_\nu(z)$  correspond to principal values of the functions on the right-hand sides of (11.2.5) and (11.2.6).

Unless indicated otherwise,  $\mathbf{H}_\nu(z)$ ,  $\mathbf{K}_\nu(z)$ ,  $\mathbf{L}_\nu(z)$ , and  $\mathbf{M}_\nu(z)$  assume their principal values throughout this Handbook.

#### 11.2(ii) Differential Equations

##### Struve's Equation

$$11.2.7 \quad \frac{d^2 w}{dz^2} + \frac{1}{z} \frac{dw}{dz} + \left(1 - \frac{\nu^2}{z^2}\right) w = \frac{\left(\frac{1}{2}z\right)^{\nu-1}}{\sqrt{\pi} \Gamma\left(\nu + \frac{1}{2}\right)}.$$

Particular solutions:

$$11.2.8 \quad w = \mathbf{H}_\nu(z), \mathbf{K}_\nu(z).$$

##### Modified Struve's Equation

$$11.2.9 \quad \frac{d^2 w}{dz^2} + \frac{1}{z} \frac{dw}{dz} - \left(1 + \frac{\nu^2}{z^2}\right) w = \frac{\left(\frac{1}{2}z\right)^{\nu-1}}{\sqrt{\pi} \Gamma\left(\nu + \frac{1}{2}\right)}.$$

Particular solutions:

$$11.2.10 \quad w = \mathbf{L}_\nu(z), \mathbf{M}_\nu(z).$$

#### 11.2(iii) Numerically Satisfactory Solutions

In this subsection  $A$  and  $B$  are arbitrary constants.

When  $z = x$ ,  $0 < x < \infty$ , and  $\Re\nu \geq 0$ , numerically satisfactory general solutions of (11.2.7) are given by

$$11.2.11 \quad w = \mathbf{H}_\nu(x) + A J_\nu(x) + B Y_\nu(x),$$

$$11.2.12 \quad w = \mathbf{K}_\nu(x) + A J_\nu(x) + B Y_\nu(x).$$

(11.2.11) applies when  $x$  is bounded, and (11.2.12) applies when  $x$  is bounded away from the origin.

When  $z \in \mathbb{C}$  and  $\Re\nu \geq 0$ , numerically satisfactory general solutions of (11.2.7) are given by

$$11.2.13 \quad w = \mathbf{H}_\nu(z) + A J_\nu(z) + B H_\nu^{(1)}(z),$$

$$11.2.14 \quad w = \mathbf{H}_\nu(z) + A J_\nu(z) + B H_\nu^{(2)}(z),$$

$$11.2.15 \quad w = \mathbf{K}_\nu(z) + A H_\nu^{(1)}(z) + B H_\nu^{(2)}(z).$$

(11.2.13) applies when  $0 \leq \text{ph } z \leq \pi$  and  $|z|$  is bounded. (11.2.14) applies when  $-\pi \leq \text{ph } z \leq 0$  and  $|z|$  is bounded. (11.2.15) applies when  $|\text{ph } z| \leq \pi$  and  $z$  is bounded away from the origin.

When  $\Re\nu \geq 0$ , numerically satisfactory general solutions of (11.2.9) are given by

$$11.2.16 \quad w = \mathbf{L}_\nu(z) + A K_\nu(z) + B I_\nu(z),$$

$$11.2.17 \quad w = \mathbf{M}_\nu(z) + A K_\nu(z) + B I_\nu(z).$$

(11.2.16) applies when  $|\text{ph } z| \leq \frac{1}{2}\pi$  with  $|z|$  bounded. (11.2.17) applies when  $|\text{ph } z| \leq \frac{1}{2}\pi$  with  $z$  bounded away from the origin.

### 11.3 Graphics

#### 11.3(i) Struve Functions

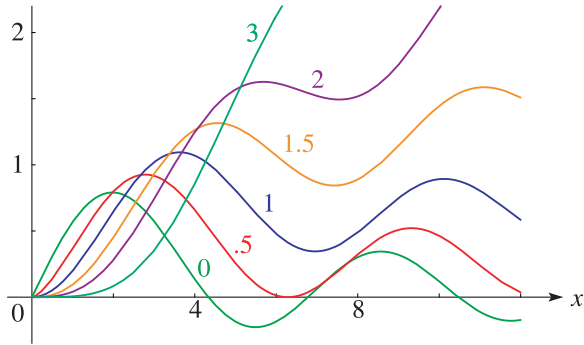


Figure 11.3.1:  $H_\nu(x)$  for  $0 \leq x \leq 12$  and  $\nu = 0, \frac{1}{2}, 1, \frac{3}{2}, 2, 3$ .

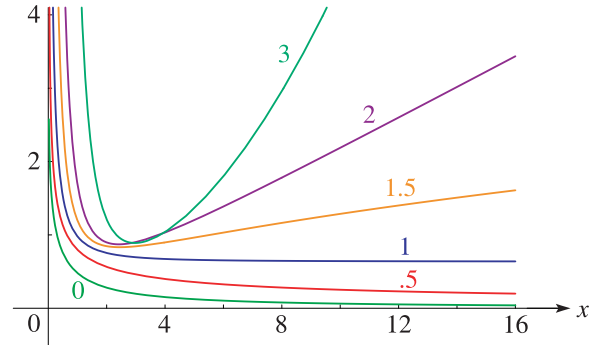


Figure 11.3.2:  $K_\nu(x)$  for  $0 < x \leq 16$  and  $\nu = 0, \frac{1}{2}, 1, \frac{3}{2}, 2, 3$ .

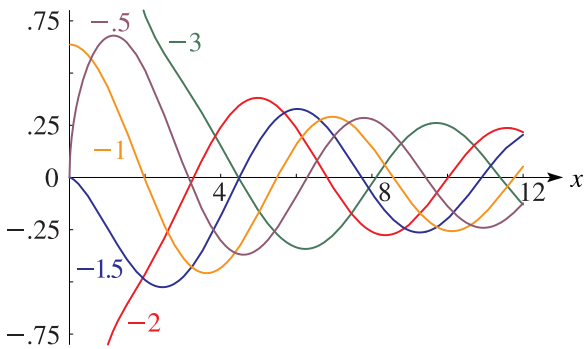


Figure 11.3.3:  $H_\nu(x)$  for  $0 \leq x \leq 12$  and  $\nu = -3, -2, -\frac{3}{2}, -1, -\frac{1}{2}$ .

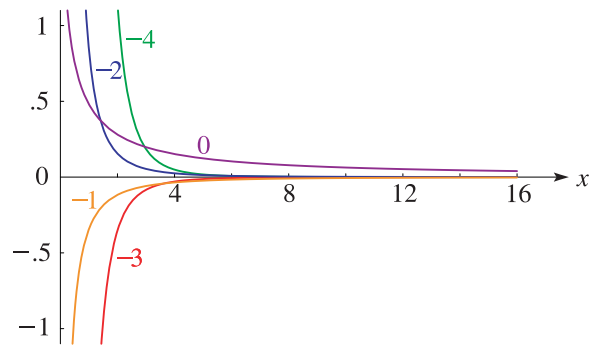


Figure 11.3.4:  $K_\nu(x)$  for  $0 < x \leq 16$  and  $\nu = -4, -3, -2, -1, 0$ . If  $\nu = -\frac{1}{2}, -\frac{3}{2}, \dots$ , then  $K_\nu(x)$  is identically zero.

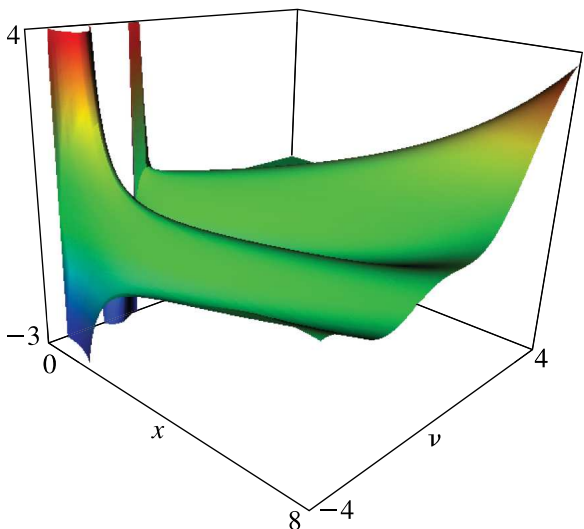


Figure 11.3.5:  $H_\nu(x)$  for  $0 \leq x \leq 8$  and  $-4 \leq \nu \leq 4$ .

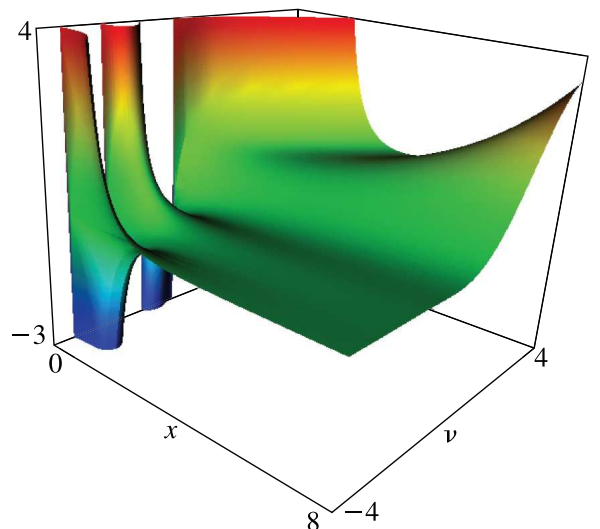


Figure 11.3.6:  $K_\nu(x)$  for  $0 \leq x \leq 8$  and  $-4 \leq \nu \leq 4$ .

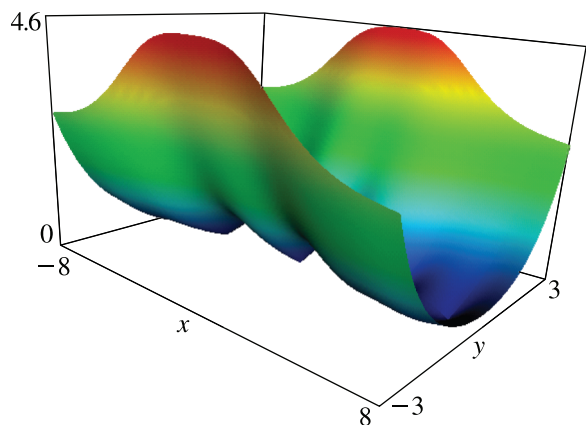


Figure 11.3.7:  $|\mathbf{H}_0(x + iy)|$  for  $-8 \leq x \leq 8$  and  $-3 \leq y \leq 3$ .

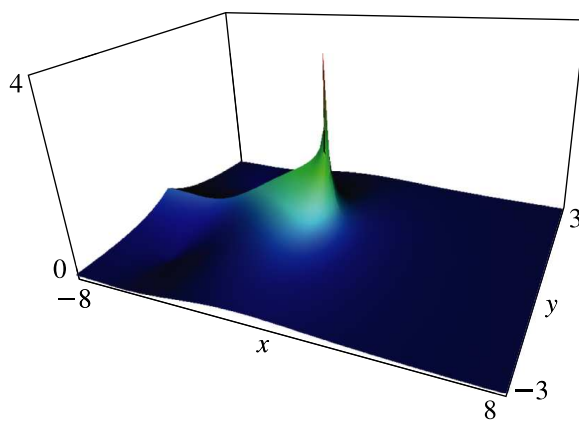


Figure 11.3.8:  $|\mathbf{K}_0(x + iy)|$  (principal value) for  $-8 \leq x \leq 8$  and  $-3 \leq y \leq 3$ . There is a cut along the negative real axis.

For further graphics see <http://dlmf.nist.gov/11.3.i>.

### 11.3(ii) Modified Struve Functions

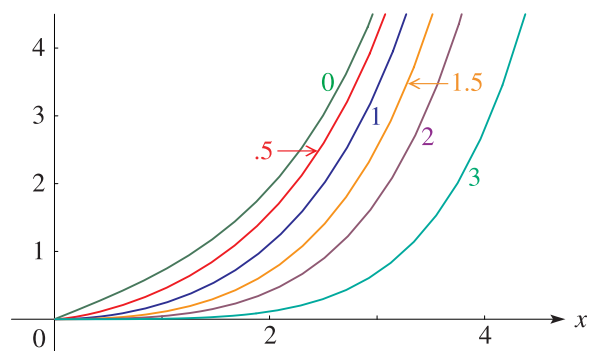


Figure 11.3.13:  $\mathbf{L}_\nu(x)$  for  $0 \leq x < 4.38$  and  $\nu = 0, \frac{1}{2}, 1, \frac{3}{2}, 2, 3$ .

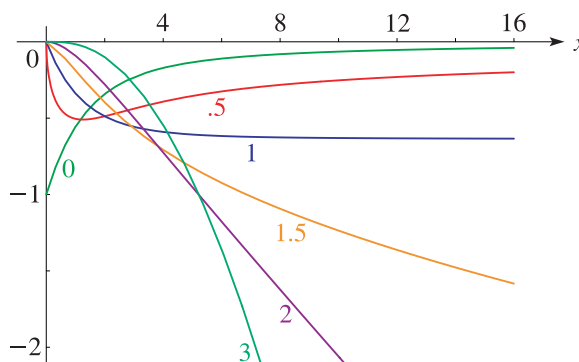


Figure 11.3.14:  $\mathbf{M}_\nu(x)$  for  $0 \leq x \leq 16$  and  $\nu = 0, \frac{1}{2}, 1, \frac{3}{2}, 2, 3$ .

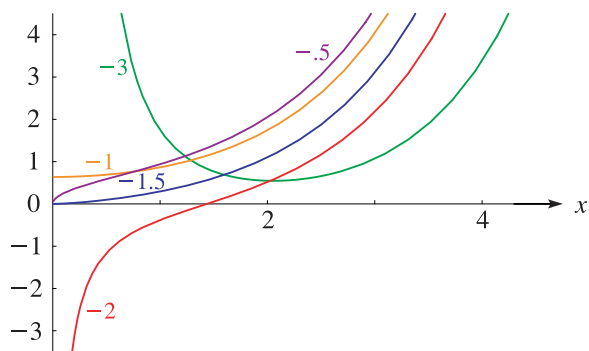


Figure 11.3.15:  $\mathbf{L}_\nu(x)$  for  $0 \leq x < 4.25$  and  $\nu = -3, -2, -\frac{3}{2}, -1, -\frac{1}{2}$ .

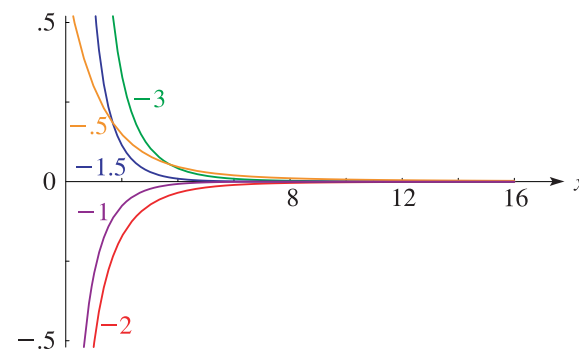


Figure 11.3.16:  $\mathbf{M}_\nu(x)$  for  $0 < x \leq 16$  and  $\nu = -3, -2, -\frac{3}{2}, -1, -\frac{1}{2}$ .

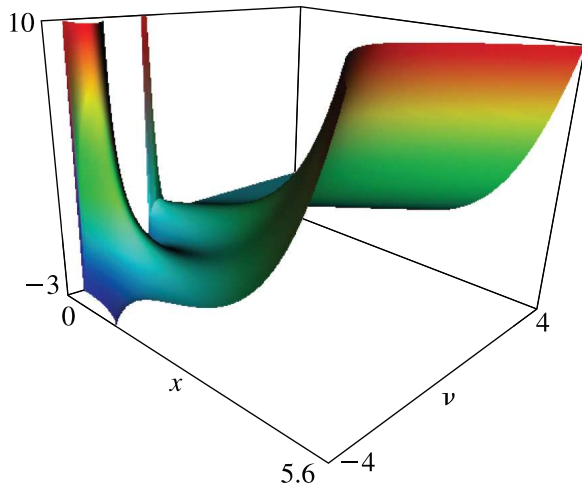


Figure 11.3.17:  $L_\nu(x)$  for  $0 \leq x \leq 5.6$  and  $-4 \leq \nu \leq 4$ .

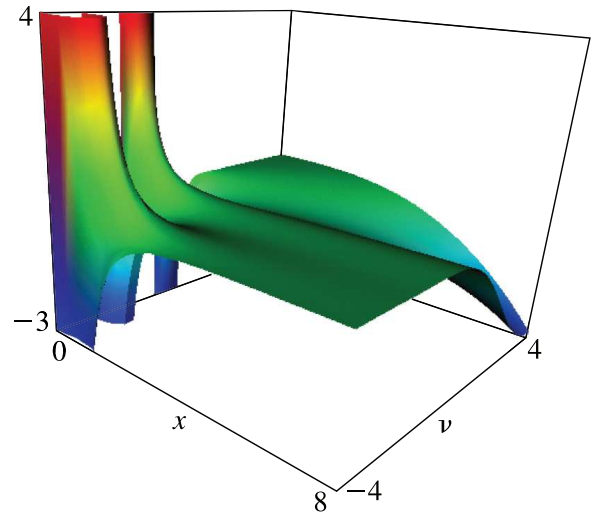


Figure 11.3.18:  $M_\nu(x)$  for  $0 \leq x \leq 8$  and  $-4 \leq \nu \leq 4$ .

For further graphics see <http://dlmf.nist.gov/11.3.ii>.

## 11.4 Basic Properties

### 11.4(i) Half-Integer Orders

For  $n = 0, 1, 2, \dots$ ,

$$11.4.1 \quad \mathbf{K}_{n+\frac{1}{2}}(z) = \left(\frac{2}{\pi z}\right)^{\frac{1}{2}} \sum_{m=0}^n \frac{(2m)! 2^{-2m}}{m!(n-m)!} \left(\frac{1}{2}z\right)^{n-2m},$$

$$11.4.2 \quad \mathbf{L}_{n+\frac{1}{2}}(z) = I_{-n-\frac{1}{2}}(z) - \left(\frac{2}{\pi z}\right)^{\frac{1}{2}} \sum_{m=0}^n \frac{(-1)^m (2m)! 2^{-2m}}{m!(n-m)!} \left(\frac{1}{2}z\right)^{n-2m},$$

$$11.4.3 \quad \mathbf{H}_{-n-\frac{1}{2}}(z) = (-1)^n J_{n+\frac{1}{2}}(z),$$

$$11.4.4 \quad \mathbf{L}_{-n-\frac{1}{2}}(z) = I_{n+\frac{1}{2}}(z).$$

$$11.4.5 \quad \mathbf{H}_{\frac{1}{2}}(z) = \left(\frac{2}{\pi z}\right)^{\frac{1}{2}} (1 - \cos z),$$

$$11.4.6 \quad \mathbf{H}_{-\frac{1}{2}}(z) = \left(\frac{2}{\pi z}\right)^{\frac{1}{2}} \sin z,$$

$$11.4.7 \quad \mathbf{L}_{\frac{1}{2}}(z) = \left(\frac{2}{\pi z}\right)^{\frac{1}{2}} (\cosh z - 1),$$

$$11.4.8 \quad \mathbf{L}_{-\frac{1}{2}}(z) = \left(\frac{2}{\pi z}\right)^{\frac{1}{2}} \sinh z,$$

$$11.4.9 \quad \mathbf{H}_{\frac{3}{2}}(z) = \left(\frac{z}{2\pi}\right)^{\frac{1}{2}} \left(1 + \frac{2}{z^2}\right) - \left(\frac{2}{\pi z}\right)^{\frac{1}{2}} \left(\sin z + \frac{\cos z}{z}\right),$$

$$11.4.10 \quad \mathbf{H}_{-\frac{3}{2}}(z) = \left(\frac{2}{\pi z}\right)^{\frac{1}{2}} \left(\cos z - \frac{\sin z}{z}\right),$$

$$11.4.11 \quad \mathbf{L}_{\frac{3}{2}}(z) = -\left(\frac{z}{2\pi}\right)^{\frac{1}{2}} \left(1 - \frac{2}{z^2}\right) + \left(\frac{2}{\pi z}\right)^{\frac{1}{2}} \left(\sinh z - \frac{\cosh z}{z}\right),$$

$$11.4.12 \quad \mathbf{L}_{-\frac{3}{2}}(z) = \left(\frac{2}{\pi z}\right)^{\frac{1}{2}} \left(\cosh z - \frac{\sinh z}{z}\right).$$

### 11.4(ii) Inequalities

$$11.4.13 \quad \mathbf{H}_\nu(x) \geq 0, \quad x > 0, \nu \geq \frac{1}{2}.$$

$$11.4.14 \quad \mathbf{H}_\nu(z) = \frac{2\left(\frac{1}{2}z\right)^{\nu+1}}{\sqrt{\pi} \Gamma\left(\nu + \frac{3}{2}\right)} (1 + \vartheta), \quad \nu \neq -\frac{3}{2}, -\frac{5}{2}, -\frac{7}{2}, \dots,$$

where

$$11.4.15 \quad |\vartheta| < \frac{2}{3} \exp\left(\frac{\frac{1}{4}|z|^2}{|\nu_0 + \frac{3}{2}|} - 1\right),$$

and  $|\nu_0 + \frac{3}{2}|$  is the smallest of the numbers  $|\nu + \frac{3}{2}|, |\nu + \frac{5}{2}|, |\nu + \frac{7}{2}|, \dots$

### 11.4(iii) Analytic Continuation

$$11.4.16 \quad \mathbf{H}_\nu(z e^{m\pi i}) = e^{m\pi i(\nu+1)} \mathbf{H}_\nu(z), \quad m \in \mathbb{Z},$$

$$11.4.17 \quad \mathbf{L}_\nu(z e^{m\pi i}) = e^{m\pi i(\nu+1)} \mathbf{L}_\nu(z), \quad m \in \mathbb{Z}.$$

**11.4(iv) Expansions in Series of Bessel Functions**

11.4.18

$$\mathbf{H}_\nu(z) = \frac{4}{\pi^{1/2} \Gamma(\nu + \frac{1}{2})} \times \sum_{k=0}^{\infty} \frac{(2k + \nu + 1) \Gamma(k + \nu + 1)}{k!(2k + 1)(2k + 2\nu + 1)} J_{2k+\nu+1}(z),$$

$\nu \neq -1, -2, -3, \dots,$

11.4.19  $\mathbf{H}_\nu(z) = \left(\frac{z}{2\pi}\right)^{1/2} \sum_{k=0}^{\infty} \frac{(\frac{1}{2}z)^k}{k!(k + \frac{1}{2})} J_{k+\nu+\frac{1}{2}}(z),$

11.4.20  $\mathbf{H}_\nu(z) = \frac{(\frac{1}{2}z)^{\nu+\frac{1}{2}}}{\Gamma(\nu + \frac{1}{2})} \sum_{k=0}^{\infty} \frac{(\frac{1}{2}z)^k}{k!(k + \nu + \frac{1}{2})} J_{k+\frac{1}{2}}(z),$

11.4.21

$$\mathbf{H}_0(z) = \frac{4}{\pi} \sum_{k=0}^{\infty} \frac{J_{2k+1}(z)}{2k + 1} = 2 \sum_{k=0}^{\infty} (-1)^k J_{k+\frac{1}{2}}^2\left(\frac{1}{2}z\right),$$

$$\mathbf{H}_1(z) = \frac{2}{\pi} (1 - J_0(z)) + \frac{4}{\pi} \sum_{k=1}^{\infty} \frac{J_{2k}(z)}{4k^2 - 1}$$

11.4.22

$$= 4 \sum_{k=0}^{\infty} J_{2k+\frac{1}{2}}\left(\frac{1}{2}z\right) J_{2k+\frac{3}{2}}\left(\frac{1}{2}z\right).$$

For these and further results see Luke (1969b, §9.4.5), and §10.23(iii).

**11.4(v) Recurrence Relations and Derivatives**

11.4.23

$$\mathbf{H}_{\nu-1}(z) + \mathbf{H}_{\nu+1}(z) = \frac{2\nu}{z} \mathbf{H}_\nu(z) + \frac{(\frac{1}{2}z)^\nu}{\sqrt{\pi} \Gamma(\nu + \frac{3}{2})},$$

11.4.24

$$\mathbf{H}_{\nu-1}(z) - \mathbf{H}_{\nu+1}(z) = 2\mathbf{H}'_\nu(z) - \frac{(\frac{1}{2}z)^\nu}{\sqrt{\pi} \Gamma(\nu + \frac{3}{2})},$$

11.4.25

$$\mathbf{L}_{\nu-1}(z) - \mathbf{L}_{\nu+1}(z) = \frac{2\nu}{z} \mathbf{L}_\nu(z) + \frac{(\frac{1}{2}z)^\nu}{\sqrt{\pi} \Gamma(\nu + \frac{3}{2})},$$

11.4.26

$$\mathbf{L}_{\nu-1}(z) + \mathbf{L}_{\nu+1}(z) = 2\mathbf{L}'_\nu(z) - \frac{(\frac{1}{2}z)^\nu}{\sqrt{\pi} \Gamma(\nu + \frac{3}{2})}.$$

11.4.27

$$\frac{d}{dz} (z^\nu \mathbf{H}_\nu(z)) = z^\nu \mathbf{H}_{\nu-1}(z),$$

11.4.28

$$\frac{d}{dz} (z^{-\nu} \mathbf{H}_\nu(z)) = \frac{2^{-\nu}}{\sqrt{\pi} \Gamma(\nu + \frac{3}{2})} - z^{-\nu} \mathbf{H}_{\nu+1}(z),$$

11.4.29

$$\frac{d}{dz} (z^\nu \mathbf{L}_\nu(z)) = z^\nu \mathbf{L}_{\nu-1}(z),$$

11.4.30

$$\frac{d}{dz} (z^{-\nu} \mathbf{L}_\nu(z)) = \frac{2^{-\nu}}{\sqrt{\pi} \Gamma(\nu + \frac{3}{2})} + z^{-\nu} \mathbf{L}_{\nu+1}(z).$$

11.4.31

$$\mathcal{H}_{\nu-m}(z) = z^{m-\nu} \left(\frac{1}{z} \frac{d}{dz}\right)^m (z^\nu \mathcal{H}_\nu(z)), \quad m = 1, 2, 3, \dots,$$

where  $\mathcal{H}_\nu(z)$  denotes either  $\mathbf{H}_\nu(z)$  or  $\mathbf{L}_\nu(z)$ .

11.4.32  $\mathbf{H}'_0(z) = \frac{2}{\pi} - \mathbf{H}_1(z), \quad \frac{d}{dz} (z \mathbf{H}_1(z)) = z \mathbf{H}_0(z),$

11.4.33  $\mathbf{L}'_0(z) = \frac{2}{\pi} + \mathbf{L}_1(z), \quad \frac{d}{dz} (z \mathbf{L}_1(z)) = z \mathbf{L}_0(z).$

**11.4(vi) Derivatives with Respect to Order**

For derivatives with respect to the order  $\nu$ , see Apelblat (1989) and Brychkov and Geddes (2005).

**11.4(vii) Zeros**

For properties of zeros of  $\mathbf{H}_\nu(x)$  see Steinig (1970).

For asymptotic expansions of zeros of  $\mathbf{H}_0(x)$  see MacLeod (2002a).

**11.5 Integral Representations**

**11.5(i) Integrals Along the Real Line**

11.5.1

$$\mathbf{H}_\nu(z) = \frac{2(\frac{1}{2}z)^\nu}{\sqrt{\pi} \Gamma(\nu + \frac{1}{2})} \int_0^1 (1-t^2)^{\nu-\frac{1}{2}} \sin(zt) dt$$

$$= \frac{2(\frac{1}{2}z)^\nu}{\sqrt{\pi} \Gamma(\nu + \frac{1}{2})} \int_0^{\pi/2} \sin(z \cos \theta) (\sin \theta)^{2\nu} d\theta,$$

$$\Re \nu > -\frac{1}{2},$$

11.5.2

$$\mathbf{K}_\nu(z) = \frac{2(\frac{1}{2}z)^\nu}{\sqrt{\pi} \Gamma(\nu + \frac{1}{2})} \int_0^\infty e^{-zt} (1+t^2)^{\nu-\frac{1}{2}} dt, \quad \Re z > 0,$$

11.5.3

$$\mathbf{K}_0(z) = \frac{2}{\pi} \int_0^\infty e^{-z \sinh t} dt, \quad \Re z > 0,$$

11.5.4

$$\mathbf{M}_\nu(z) = -\frac{2(\frac{1}{2}z)^\nu}{\sqrt{\pi} \Gamma(\nu + \frac{1}{2})} \int_0^1 e^{-zt} (1-t^2)^{\nu-\frac{1}{2}} dt,$$

$$\Re \nu > -\frac{1}{2},$$

11.5.5

$$\mathbf{M}_0(z) = -\frac{2}{\pi} \int_0^{\pi/2} e^{-z \cos \theta} d\theta,$$

11.5.6

$$\mathbf{L}_\nu(z) = \frac{2(\frac{1}{2}z)^\nu}{\sqrt{\pi} \Gamma(\nu + \frac{1}{2})} \int_0^{\pi/2} \sinh(z \cos \theta) (\sin \theta)^{2\nu} d\theta,$$

$$\Re \nu > -\frac{1}{2},$$

11.5.7

$$I_{-\nu}(x) - \mathbf{L}_\nu(x) = \frac{2(\frac{1}{2}x)^\nu}{\sqrt{\pi} \Gamma(\nu + \frac{1}{2})} \int_0^\infty (1+t^2)^{\nu-\frac{1}{2}} \sin(xt) dt,$$

$$x > 0, \Re \nu < \frac{1}{2}.$$

**11.5(ii) Contour Integrals**

For loop-integral versions of (11.5.1), (11.5.2), (11.5.4), and (11.5.7) see Babister (1967, §§3.3 and 3.14).

**Mellin–Barnes Integrals**

**11.5.8**  

$$\left(\frac{1}{2}x\right)^{-\nu-1} \mathbf{H}_\nu(x)$$

$$= -\frac{1}{2\pi i} \int_{-i\infty}^{i\infty} \frac{\pi \csc(\pi s)}{\Gamma\left(\frac{3}{2}+s\right)\Gamma\left(\frac{3}{2}+\nu+s\right)} \left(\frac{1}{4}x^2\right)^s ds,$$

$$x > 0, \Re \nu > -1,$$

**11.5.9**  

$$\left(\frac{1}{2}z\right)^{-\nu-1} \mathbf{L}_\nu(z)$$

$$= \frac{1}{2\pi i} \int_{\infty}^{(0+)} \frac{\pi \csc(\pi s)}{\Gamma\left(\frac{3}{2}+s\right)\Gamma\left(\frac{3}{2}+\nu+s\right)} \left(-\frac{1}{4}z^2\right)^s ds.$$

In (11.5.8) and (11.5.9) the path of integration separates the poles of the integrand at  $s = 0, 1, 2, \dots$  from those at  $s = -1, -2, -3, \dots$ .

**11.5(iii) Compendia**

For further integral representations see Babister (1967, §§3.3, 3.14), Erdélyi *et al.* (1954a, §§5.17, 15.3), Magnus *et al.* (1966, p. 114), Oberhettinger (1972), Oberhettinger (1974, §2.7), Oberhettinger and Badii (1973, §2.14), and Watson (1944, pp. 330, 374, and 426).

**11.6 Asymptotic Expansions**

**11.6(i) Large  $|z|$ , Fixed  $\nu$**

**11.6.1**  

$$\mathbf{K}_\nu(z) \sim \frac{1}{\pi} \sum_{k=0}^{\infty} \frac{\Gamma(k + \frac{1}{2}) \left(\frac{1}{2}z\right)^{\nu-2k-1}}{\Gamma\left(\nu + \frac{1}{2} - k\right)}, \quad |\text{ph } z| \leq \pi - \delta,$$

where  $\delta$  is an arbitrary small positive constant. If the series on the right-hand side of (11.6.1) is truncated after  $m (\geq 0)$  terms, then the remainder term  $R_m(z)$  is  $O(z^{\nu-2m-1})$ . If  $\nu$  is real,  $z$  is positive, and  $m + \frac{1}{2} - \nu \geq 0$ , then  $R_m(z)$  is of the same sign and numerically less than the first neglected term.

**11.6.2**  

$$\mathbf{M}_\nu(z) \sim \frac{1}{\pi} \sum_{k=0}^{\infty} (-1)^{k+1} \frac{\Gamma(k + \frac{1}{2}) \left(\frac{1}{2}z\right)^{\nu-2k-1}}{\Gamma\left(\nu + \frac{1}{2} - k\right)},$$

$$|\text{ph } z| \leq \frac{1}{2}\pi - \delta.$$

For re-expansions of the remainder terms in (11.6.1) and (11.6.2), see Dingle (1973, p. 445).

For the corresponding expansions for  $\mathbf{H}_\nu(z)$  and  $\mathbf{L}_\nu(z)$  combine (11.6.1), (11.6.2) with (11.2.5), (11.2.6), (10.17.4), and (10.40.1).

**11.6.3**  

$$\int_0^z \mathbf{K}_0(t) dt - \frac{2}{\pi} (\ln(2z) + \gamma)$$

$$\sim \frac{2}{\pi} \sum_{k=1}^{\infty} (-1)^{k+1} \frac{(2k)!(2k-1)!}{(k!)^2(2z)^{2k}}, \quad |\text{ph } z| \leq \pi - \delta,$$

**11.6.4**  

$$\int_0^z \mathbf{M}_0(t) dt + \frac{2}{\pi} (\ln(2z) + \gamma)$$

$$\sim \frac{2}{\pi} \sum_{k=1}^{\infty} \frac{(2k)!(2k-1)!}{(k!)^2(2z)^{2k}}, \quad |\text{ph } z| \leq \frac{1}{2}\pi - \delta,$$

where  $\gamma$  is Euler's constant (§5.2(ii)).

**11.6(ii) Large  $|\nu|$ , Fixed  $z$**

**11.6.5**  $\mathbf{H}_\nu(z), \mathbf{L}_\nu(z) \sim \frac{z}{\pi\nu\sqrt{2}} \left(\frac{ez}{2\nu}\right)^\nu, \quad |\text{ph } \nu| \leq \pi - \delta.$

More fully, the series (11.2.1) and (11.2.2) can be regarded as generalized asymptotic expansions (§2.1(v)).

**11.6(iii) Large  $|\nu|$ , Fixed  $z/\nu$**

For fixed  $\lambda (> 1)$

**11.6.6**  

$$\mathbf{K}_\nu(\lambda\nu) \sim \frac{\left(\frac{1}{2}\lambda\nu\right)^{\nu-1}}{\sqrt{\pi}\Gamma\left(\nu + \frac{1}{2}\right)} \sum_{k=0}^{\infty} \frac{k!c_k(\lambda)}{\nu^k}, \quad |\text{ph } \nu| \leq \frac{1}{2}\pi - \delta,$$

and for fixed  $\lambda (> 0)$

**11.6.7**  

$$\mathbf{M}_\nu(\lambda\nu) \sim -\frac{\left(\frac{1}{2}\lambda\nu\right)^{\nu-1}}{\sqrt{\pi}\Gamma\left(\nu + \frac{1}{2}\right)} \sum_{k=0}^{\infty} \frac{k!c_k(i\lambda)}{\nu^k},$$

$$|\text{ph } \nu| \leq \frac{1}{2}\pi - \delta.$$

Here

$$c_0(\lambda) = 1, \quad c_1(\lambda) = 2\lambda^{-2},$$

**11.6.8** 
$$c_2(\lambda) = 6\lambda^{-4} - \frac{1}{2}\lambda^{-2}, \quad c_3(\lambda) = 20\lambda^{-6} - 4\lambda^{-4},$$

$$c_4(\lambda) = 70\lambda^{-8} - \frac{45}{2}\lambda^{-6} + \frac{3}{8}\lambda^{-4},$$

and for higher coefficients  $c_k(\lambda)$  see Dingle (1973, p. 203).

For the corresponding result for  $\mathbf{H}_\nu(\lambda\nu)$  use (11.2.5) and (10.19.6). See also Watson (1944, p. 336).

For fixed  $\lambda (> 0)$

**11.6.9** 
$$\mathbf{L}_\nu(\lambda\nu) \sim I_\nu(\lambda\nu), \quad |\text{ph } \nu| \leq \frac{1}{2}\pi - \delta,$$

and for an estimate of the relative error in this approximation see Watson (1944, p. 336).

**11.7 Integrals and Sums**

**11.7(i) Indefinite Integrals**

**11.7.1** 
$$\int z^\nu \mathbf{H}_{\nu-1}(z) dz = z^\nu \mathbf{H}_\nu(z),$$

**11.7.2** 
$$\int z^{-\nu} \mathbf{H}_{\nu+1}(z) dz = -z^{-\nu} \mathbf{H}_\nu(z) + \frac{2^{-\nu}z}{\sqrt{\pi}\Gamma\left(\nu + \frac{3}{2}\right)},$$

**11.7.3** 
$$\int z^\nu \mathbf{L}_{\nu-1}(z) dz = z^\nu \mathbf{L}_\nu(z),$$

$$11.7.4 \quad \int z^{-\nu} \mathbf{L}_{\nu+1}(z) dz = z^{-\nu} \mathbf{L}_{\nu}(z) - \frac{2^{-\nu} z}{\sqrt{\pi} \Gamma(\nu + \frac{3}{2})}.$$

If

$$11.7.5 \quad f_{\nu}(z) = \int_0^z t^{\nu} \mathbf{H}_{\nu}(t) dt,$$

then

$$11.7.6 \quad f_{\nu+1}(z) = (2\nu + 1)f_{\nu}(z) - z^{\nu+1} \mathbf{H}_{\nu}(z) + \frac{(\frac{1}{2}z^2)^{\nu+1}}{(\nu + 1)\sqrt{\pi} \Gamma(\nu + \frac{3}{2})}, \quad \Re \nu > -1.$$

### 11.7(ii) Definite Integrals

$$11.7.7 \quad \int_0^{\pi/2} \mathbf{H}_{\nu}(z \sin \theta) \frac{(\sin \theta)^{\nu+1}}{(\cos \theta)^{2\nu}} d\theta = \frac{2^{-\nu}}{\sqrt{\pi}} \Gamma(\frac{1}{2} - \nu) z^{\nu-1} (1 - \cos z), \quad -\frac{3}{2} < \Re \nu < \frac{1}{2},$$

$$11.7.8 \quad \int_0^{\infty} \mathbf{H}_0(t) \frac{dt}{t} = \frac{1}{2}\pi, \quad \int_0^{\infty} \mathbf{H}_1(t) \frac{dt}{t^2} = \frac{1}{4}\pi,$$

$$11.7.9 \quad \int_0^{\infty} \mathbf{H}_{\nu}(t) dt = -\cot(\frac{1}{2}\pi\nu), \quad -2 < \Re \nu < 0,$$

$$11.7.10 \quad \int_0^{\infty} t^{-\nu-1} \mathbf{H}_{\nu}(t) dt = \frac{\pi}{2^{\nu+1} \Gamma(\nu + 1)}, \quad \Re \nu > -\frac{3}{2},$$

$$11.7.11 \quad \int_0^{\infty} t^{\mu-\nu-1} \mathbf{H}_{\nu}(t) dt = \frac{\Gamma(\frac{1}{2}\mu) 2^{\mu-\nu-1} \tan(\frac{1}{2}\pi\mu)}{\Gamma(\nu - \frac{1}{2}\mu + 1)}, \quad |\Re \mu| < 1, \Re \nu > \Re \mu - \frac{3}{2},$$

$$11.7.12 \quad \int_0^{\infty} t^{-\mu-\nu} \mathbf{H}_{\mu}(t) \mathbf{H}_{\nu}(t) dt = \frac{\sqrt{\pi} \Gamma(\mu + \nu)}{2^{\mu+\nu} \Gamma(\mu + \nu + \frac{1}{2}) \Gamma(\mu + \frac{1}{2}) \Gamma(\nu + \frac{1}{2})}, \quad \Re(\mu + \nu) > 0.$$

For other integrals involving products of Struve functions see Zanovello (1978, 1995). For integrals involving products of  $\mathbf{M}_{\nu}(t)$  functions, see Paris and Sy (1983, Appendix).

### 11.7(iii) Laplace Transforms

The following Laplace transforms of  $\mathbf{H}_{\nu}(t)$  require  $\Re a > 0$  for convergence, while those of  $\mathbf{L}_{\nu}(t)$  require  $\Re a > 1$ .

$$11.7.13 \quad \int_0^{\infty} e^{-at} \mathbf{H}_0(t) dt = \frac{2}{\pi \sqrt{1+a^2}} \ln \left( \frac{1 + \sqrt{1+a^2}}{a} \right),$$

$$11.7.14 \quad \int_0^{\infty} e^{-at} \mathbf{H}_1(t) dt = \frac{2}{\pi a} - \frac{2a}{\pi \sqrt{1+a^2}} \ln \left( \frac{1 + \sqrt{1+a^2}}{a} \right),$$

$$11.7.15 \quad \int_0^{\infty} e^{-at} \mathbf{L}_0(t) dt = \frac{2}{\pi \sqrt{a^2-1}} \arcsin \left( \frac{1}{a} \right),$$

$$11.7.16 \quad \int_0^{\infty} e^{-at} \mathbf{L}_1(t) dt = \frac{2a}{\pi \sqrt{a^2-1}} \arctan \left( \frac{1}{\sqrt{a^2-1}} \right) - \frac{2}{\pi a}.$$

### 11.7(iv) Integrals with Respect to Order

For integrals of  $\mathbf{H}_{\nu}(x)$  and  $\mathbf{L}_{\nu}(x)$  with respect to the order  $\nu$ , see Apelblat (1989).

### 11.7(v) Compendia

For further integrals see Apelblat (1983, §12.16), Babister (1967, Chapter 3), Erdélyi *et al.* (1954a, §§4.19, 6.8, 8.15, 9.4, 10.3, 11.3, and 15.3), Luke (1962, Chapters 9, 11), Gradshteyn and Ryzhik (2000, §6.8), Marichev (1983, pp. 192–193 and 215–216), Oberhettinger (1972), Oberhettinger (1974, §1.12), Oberhettinger (1990, §§1.21 and 2.21), Oberhettinger and Badii (1973, §1.16), Prudnikov *et al.* (1990, §§1.4 and 2.7), Prudnikov *et al.* (1992a, §3.17), and Prudnikov *et al.* (1992b, §3.17).

For sums of Struve functions see Hansen (1975, p. 456) and Prudnikov *et al.* (1990, §6.4.1).

## 11.8 Analogs to Kelvin Functions

For properties of Struve functions of argument  $xe^{\pm 3\pi i/4}$  see McLachlan and Meyers (1936).

## Related Functions

### 11.9 Lommel Functions

#### 11.9(i) Definitions

The inhomogeneous Bessel differential equation

$$11.9.1 \quad \frac{d^2 w}{dz^2} + \frac{1}{z} \frac{dw}{dz} + \left(1 - \frac{\nu^2}{z^2}\right) w = z^{\mu-1}$$

can be regarded as a generalization of (11.2.7). Provided that  $\mu \pm \nu \neq -1, -3, -5, \dots$ , (11.9.1) has the general solution

$$11.9.2 \quad w = s_{\mu,\nu}(z) + A J_{\nu}(z) + B Y_{\nu}(z),$$

where  $A, B$  are arbitrary constants,  $s_{\mu,\nu}(z)$  is the Lommel function defined by

$$11.9.3 \quad s_{\mu,\nu}(z) = z^{\mu+1} \sum_{k=0}^{\infty} (-1)^k \frac{z^{2k}}{a_{k+1}(\mu, \nu)},$$

and

$$11.9.4 \quad a_k(\mu, \nu) = \prod_{m=1}^k ((\mu + 2m - 1)^2 - \nu^2), \quad k = 0, 1, 2, \dots$$

Another solution of (11.9.1) that is defined for all values of  $\mu$  and  $\nu$  is  $S_{\mu,\nu}(z)$ , where

**11.9.5**  $S_{\mu,\nu}(z) = s_{\mu,\nu}(z) + 2^{\mu-1} \Gamma(\frac{1}{2}\mu + \frac{1}{2}\nu + \frac{1}{2}) \Gamma(\frac{1}{2}\mu - \frac{1}{2}\nu + \frac{1}{2}) (\sin(\frac{1}{2}(\mu - \nu)\pi) J_\nu(z) - \cos(\frac{1}{2}(\mu - \nu)\pi) Y_\nu(z))$ , the right-hand side being replaced by its limiting form when  $\mu \pm \nu$  is an odd negative integer.

#### Reflection Formulas

**11.9.6**  $s_{\mu,-\nu}(z) = s_{\mu,\nu}(z), \quad S_{\mu,-\nu}(z) = S_{\mu,\nu}(z).$

For the foregoing results and further information see Watson (1944, §§10.7–10.73) and Babister (1967, §3.16).

#### 11.9(ii) Expansions in Series of Bessel Functions

When  $\mu \pm \nu \neq -1, -2, -3, \dots$ ,

**11.9.7**  $s_{\mu,\nu}(z) = 2^{\mu+1} \sum_{k=0}^{\infty} \frac{(2k + \mu + 1) \Gamma(k + \mu + 1)}{k!(2k + \mu - \nu + 1)(2k + \mu + \nu + 1)} J_{2k+\mu+1}(z),$

**11.9.8**  $s_{\mu,\nu}(z) = 2^{(\mu+\nu-1)/2} \Gamma(\frac{1}{2}\mu + \frac{1}{2}\nu + \frac{1}{2}) z^{(\mu+1-\nu)/2} \sum_{k=0}^{\infty} \frac{(\frac{1}{2}z)^k}{k!(2k + \mu - \nu + 1)} J_{k+\frac{1}{2}(\mu+\nu+1)}(z).$

For these and further results see Luke (1969b, §9.4.5).

#### 11.9(iii) Asymptotic Expansion

For fixed  $\mu$  and  $\nu$ ,

**11.9.9**  $S_{\mu,\nu}(z) \sim z^{\mu-1} \sum_{k=0}^{\infty} (-1)^k a_k(-\mu, \nu) z^{-2k},$   
 $z \rightarrow \infty, |\text{ph } z| \leq \pi - \delta (< \pi).$

For  $a_k(\mu, \nu)$  see (11.9.4). If either of  $\mu \pm \nu$  equals an odd positive integer, then the right-hand side of (11.9.9) terminates and represents  $S_{\mu,\nu}(z)$  exactly.

For uniform asymptotic expansions, for large  $\nu$  and fixed  $\mu = -1, 0, 1, 2, \dots$ , of solutions of the inhomogeneous modified Bessel differential equation that corresponds to (11.9.1) see Olver (1997b, pp. 388–390).

#### 11.9(iv) References

For further information on Lommel functions see Watson (1944, §§10.7–10.75) and Babister (1967, Chapter 3). For descriptive properties of  $s_{\mu,\nu}(x)$  see Steinig (1972).

For collections of integral representations and integrals see Apelblat (1983, §12.17), Babister (1967, p. 85), Erdélyi *et al.* (1954a, §§4.19 and 5.17), Gradshteyn and Ryzhik (2000, §6.86), Marichev (1983, p. 193), Oberhettinger (1972, pp. 127–128, 168–169, and 188–189), Oberhettinger (1974, §§1.12 and 2.7), Oberhettinger (1990, pp. 105–106 and 191–192), Oberhettinger and Badii (1973, §2.14), Prudnikov *et al.* (1990, §§1.6 and 2.9), Prudnikov *et al.* (1992a, §3.34), and Prudnikov *et al.* (1992b, §3.32).

## 11.10 Anger–Weber Functions

#### 11.10(i) Definitions

The Anger function  $\mathbf{J}_\nu(z)$  and Weber function  $\mathbf{E}_\nu(z)$  are defined by

**11.10.1**  $\mathbf{J}_\nu(z) = \frac{1}{\pi} \int_0^\pi \cos(\nu\theta - z \sin \theta) d\theta,$

**11.10.2**  $\mathbf{E}_\nu(z) = \frac{1}{\pi} \int_0^\pi \sin(\nu\theta - z \sin \theta) d\theta.$

Each is an entire function of  $z$  and  $\nu$ . Also,

**11.10.3**  $\frac{1}{\pi} \int_0^{2\pi} \cos(\nu\theta - z \sin \theta) d\theta = (1 + \cos(2\pi\nu)) \mathbf{J}_\nu(z)$   
 $+ \sin(2\pi\nu) \mathbf{E}_\nu(z).$

The associated Anger–Weber function  $\mathbf{A}_\nu(z)$  is defined by

**11.10.4**  $\mathbf{A}_\nu(z) = \frac{1}{\pi} \int_0^\infty e^{-\nu t - z \sinh t} dt, \quad \Re z > 0.$

(11.10.4) also applies when  $\Re z = 0$  and  $\Re \nu > 0$ .

#### 11.10(ii) Differential Equations

The Anger and Weber functions satisfy the inhomogeneous Bessel differential equation

**11.10.5**  $\frac{d^2 w}{dz^2} + \frac{1}{z} \frac{dw}{dz} + \left(1 - \frac{\nu^2}{z^2}\right) w = f(\nu, z),$

where

**11.10.6**  $f(\nu, z) = \frac{(z - \nu)}{\pi z^2} \sin(\pi\nu), \quad w = \mathbf{J}_\nu(z),$

or

**11.10.7**  $f(\nu, z) = -\frac{1}{\pi z^2} (z + \nu + (z - \nu) \cos(\pi\nu)), \quad w = \mathbf{E}_\nu(z).$



**11.10(iii) Maclaurin Series**

**11.10.8**  $J_\nu(z) = \cos(\frac{1}{2}\pi\nu) S_1(\nu, z) + \sin(\frac{1}{2}\pi\nu) S_2(\nu, z),$

**11.10.9**  $E_\nu(z) = \sin(\frac{1}{2}\pi\nu) S_1(\nu, z) - \cos(\frac{1}{2}\pi\nu) S_2(\nu, z),$   
 where

**11.10.10**  $S_1(\nu, z) = \sum_{k=0}^{\infty} \frac{(-1)^k (\frac{1}{2}z)^{2k}}{\Gamma(k + \frac{1}{2}\nu + 1) \Gamma(k - \frac{1}{2}\nu + 1)},$

**11.10.11**  $S_2(\nu, z) = \sum_{k=0}^{\infty} \frac{(-1)^k (\frac{1}{2}z)^{2k+1}}{\Gamma(k + \frac{1}{2}\nu + \frac{3}{2}) \Gamma(k - \frac{1}{2}\nu + \frac{3}{2})}.$

These expansions converge absolutely for all finite values of  $z$ .

**11.10(iv) Graphics**

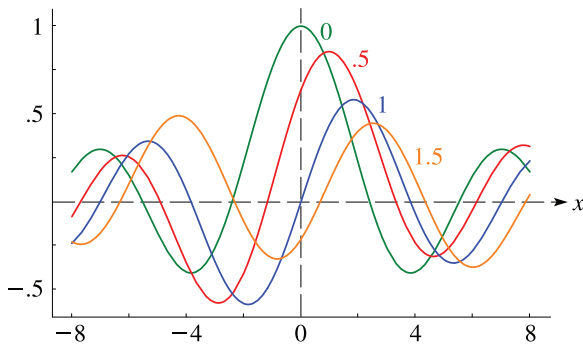


Figure 11.10.1: Anger function  $J_\nu(x)$  for  $-8 \leq x \leq 8$  and  $\nu = 0, \frac{1}{2}, 1, \frac{3}{2}$ .

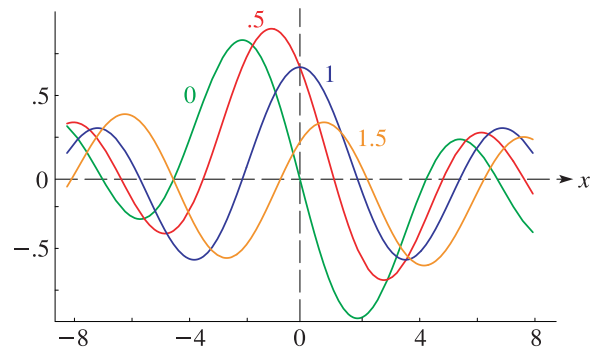


Figure 11.10.2: Weber function  $E_\nu(x)$  for  $-8 \leq x \leq 8$  and  $\nu = 0, \frac{1}{2}, 1, \frac{3}{2}$ .

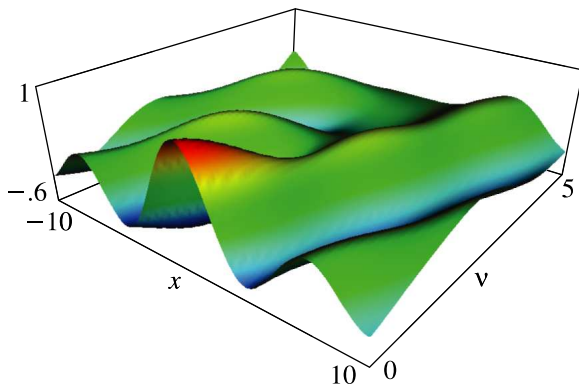


Figure 11.10.3: Anger function  $J_\nu(x)$  for  $-10 \leq x \leq 10$  and  $0 \leq \nu \leq 5$ .

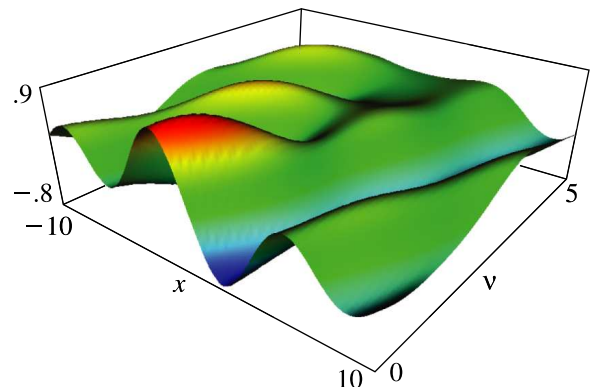


Figure 11.10.4: Weber function  $E_\nu(x)$  for  $-10 \leq x \leq 10$  and  $0 \leq \nu \leq 5$ .

**11.10(v) Interrelations**

**11.10.12**  $J_\nu(-z) = J_{-\nu}(z), \quad E_\nu(-z) = -E_{-\nu}(z).$

**11.10.13**  $\sin(\pi\nu) J_\nu(z) = \cos(\pi\nu) E_\nu(z) - E_{-\nu}(z),$

**11.10.14**  $\sin(\pi\nu) E_\nu(z) = J_{-\nu}(z) - \cos(\pi\nu) J_\nu(z).$

**11.10.15**  $J_\nu(z) = J_\nu(z) + \sin(\pi\nu) A_\nu(z),$

**11.10.16**  $E_\nu(z) = -Y_\nu(z) - \cos(\pi\nu) A_\nu(z) - A_{-\nu}(z).$

**11.10(vi) Relations to Other Functions**

**11.10.17**  $J_\nu(z) = \frac{\sin(\pi\nu)}{\pi} (s_{0,\nu}(z) - \nu s_{-1,\nu}(z)),$

**11.10.18**  $E_\nu(z) = -\frac{1}{\pi} (1 + \cos(\pi\nu)) s_{0,\nu}(z) - \frac{\nu}{\pi} (1 - \cos(\pi\nu)) s_{-1,\nu}(z).$

11.10.19  $J_{-\frac{1}{2}}(z) = \mathbf{E}_{\frac{1}{2}}(z)$   
 $= (\frac{1}{2}\pi z)^{-\frac{1}{2}}(A_+(\chi) \cos z - A_-(\chi) \sin z),$

11.10.20  $J_{\frac{1}{2}}(z) = -\mathbf{E}_{-\frac{1}{2}}(z)$   
 $= (\frac{1}{2}\pi z)^{-\frac{1}{2}}(A_+(\chi) \sin z + A_-(\chi) \cos z),$

where

11.10.21  $A_{\pm}(\chi) = C(\chi) \pm S(\chi), \quad \chi = (2z/\pi)^{\frac{1}{2}}.$

For the Fresnel integrals  $C$  and  $S$  see §7.2(iii).

For  $n = 1, 2, 3, \dots,$

11.10.22 
$$\mathbf{E}_n(z) = -\mathbf{H}_n(z) + \frac{1}{\pi} \sum_{k=0}^{m_1} \frac{\Gamma(k + \frac{1}{2})}{\Gamma(n + \frac{1}{2} - k)} (\frac{1}{2}z)^{n-2k-1},$$

and

11.10.23 
$$\mathbf{E}_{-n}(z) = -\mathbf{H}_{-n}(z) + \frac{(-1)^{n+1}}{\pi} \sum_{k=0}^{m_2} \frac{\Gamma(n-k-\frac{1}{2})}{\Gamma(k + \frac{3}{2})} (\frac{1}{2}z)^{-n+2k+1},$$

where

11.10.24  $m_1 = \lfloor \frac{1}{2}n - \frac{1}{2} \rfloor, \quad m_2 = \lceil \frac{1}{2}n - \frac{3}{2} \rceil.$

**11.10(vii) Special Values**

11.10.25  $J_{\nu}(0) = \frac{\sin(\pi\nu)}{\pi\nu}, \quad \mathbf{E}_{\nu}(0) = \frac{1 - \cos(\pi\nu)}{\pi\nu}.$

11.10.26  $\mathbf{E}_0(z) = -\mathbf{H}_0(z), \quad \mathbf{E}_1(z) = \frac{2}{\pi} - \mathbf{H}_1(z).$

11.10.27  $\left. \frac{\partial}{\partial \nu} J_{\nu}(z) \right|_{\nu=0} = \frac{1}{2}\pi \mathbf{H}_0(z),$

11.10.28  $\left. \frac{\partial}{\partial \nu} \mathbf{E}_{\nu}(z) \right|_{\nu=0} = \frac{1}{2}\pi J_0(z).$

11.10.29  $J_n(z) = \mathbf{J}_n(z), \quad n \in \mathbb{Z}.$

**11.10(viii) Expansions in Series of Products of Bessel Functions**

11.10.30 
$$J_{\nu}(z) = 2 \sin(\frac{1}{2}\nu\pi) \sum_{k=0}^{\infty} (-1)^k J_{k-\frac{1}{2}\nu+\frac{1}{2}}(\frac{1}{2}z) J_{k+\frac{1}{2}\nu+\frac{1}{2}}(\frac{1}{2}z) + 2 \cos(\frac{1}{2}\nu\pi) \sum_{k=0}^{\infty} (-1)^k J_{k-\frac{1}{2}\nu}(\frac{1}{2}z) J_{k+\frac{1}{2}\nu}(\frac{1}{2}z),$$

11.10.31 
$$\mathbf{E}_{\nu}(z) = -2 \cos(\frac{1}{2}\nu\pi) \sum_{k=0}^{\infty} (-1)^k J_{k-\frac{1}{2}\nu+\frac{1}{2}}(\frac{1}{2}z) J_{k+\frac{1}{2}\nu+\frac{1}{2}}(\frac{1}{2}z) + 2 \sin(\frac{1}{2}\nu\pi) \sum_{k=0}^{\infty} (-1)^k J_{k-\frac{1}{2}\nu}(\frac{1}{2}z) J_{k+\frac{1}{2}\nu}(\frac{1}{2}z),$$

where the prime on the second summation symbols means that the first term is to be halved.

**11.10(ix) Recurrence Relations and Derivatives**

11.10.32  $J_{\nu-1}(z) + J_{\nu+1}(z) = \frac{2\nu}{z} J_{\nu}(z) - \frac{2}{\pi z} \sin(\pi\nu),$

11.10.33 
$$\mathbf{E}_{\nu-1}(z) + \mathbf{E}_{\nu+1}(z) = \frac{2\nu}{z} \mathbf{E}_{\nu}(z) - \frac{2}{\pi z} (1 - \cos(\pi\nu)).$$

11.10.34  $2J'_{\nu}(z) = J_{\nu-1}(z) - J_{\nu+1}(z),$

11.10.35  $2\mathbf{E}'_{\nu}(z) = \mathbf{E}_{\nu-1}(z) - \mathbf{E}_{\nu+1}(z),$

11.10.36  $zJ'_{\nu}(z) \pm \nu J_{\nu}(z) = \pm z J_{\nu\mp 1}(z) \pm \frac{\sin(\pi\nu)}{\pi},$

11.10.37 
$$z\mathbf{E}'_{\nu}(z) \pm \nu \mathbf{E}_{\nu}(z) = \pm z \mathbf{E}_{\nu\mp 1}(z) \pm \frac{(1 - \cos(\pi\nu))}{\pi}.$$

**11.10(x) Integrals and Sums**

For collections of integral representations and integrals see Erdélyi *et al.* (1954a, §§4.19 and 5.17), Marichev (1983, pp. 194–195 and 214–215), Oberhettinger (1972, p. 128), Oberhettinger (1974, §§1.12 and 2.7), Oberhettinger (1990, pp. 105 and 189–190), Prudnikov *et al.* (1990, §§1.5 and 2.8), Prudnikov *et al.* (1992a, §3.18), Prudnikov *et al.* (1992b, §3.18), and Zanovello (1977).

For sums see Hansen (1975, pp. 456–457) and Prudnikov *et al.* (1990, §§6.4.2–6.4.3).

**11.11 Asymptotic Expansions of Anger-Weber Functions**

**11.11(i) Large  $|z|$ , Fixed  $\nu$**

Let  $F_0(\nu) = G_0(\nu) = 1$ , and for  $k = 1, 2, 3, \dots,$

11.11.1 
$$F_k(\nu) = (\nu^2 - 1^2)(\nu^2 - 3^2) \dots (\nu^2 - (2k - 1)^2),$$
  
 $G_k(\nu) = (\nu^2 - 2^2)(\nu^2 - 4^2) \dots (\nu^2 - (2k)^2).$

Then as  $z \rightarrow \infty$  in  $|\text{ph } z| \leq \pi - \delta (< \pi)$

11.11.2 
$$J_{\nu}(z) \sim J_{\nu}(z) + \frac{\sin(\pi\nu)}{\pi z} \left( \sum_{k=0}^{\infty} \frac{F_k(\nu)}{z^{2k}} - \frac{\nu}{z} \sum_{k=0}^{\infty} \frac{G_k(\nu)}{z^{2k}} \right),$$

$$\mathbf{E}_{\nu}(z) \sim -Y_{\nu}(z) - \frac{1 + \cos(\pi\nu)}{\pi z} \sum_{k=0}^{\infty} \frac{F_k(\nu)}{z^{2k}}$$

11.11.3 
$$- \frac{\nu(1 - \cos(\pi\nu))}{\pi z^2} \sum_{k=0}^{\infty} \frac{G_k(\nu)}{z^{2k}},$$

11.11.4 
$$\mathbf{A}_{\nu}(z) \sim \frac{1}{\pi z} \sum_{k=0}^{\infty} \frac{F_k(\nu)}{z^{2k}} - \frac{\nu}{\pi z^2} \sum_{k=0}^{\infty} \frac{G_k(\nu)}{z^{2k}}.$$

**11.11(ii) Large  $|\nu|$ , Fixed  $z$**

If  $z$  is fixed, and  $\nu \rightarrow \infty$  in  $|\text{ph } \nu| \leq \pi$  in such a way that  $\nu$  is bounded away from the set of all integers, then

**11.11.5** 
$$\mathbf{J}_\nu(z) = \frac{\sin(\pi\nu)}{\pi\nu} \left( 1 - \frac{\nu z}{\nu^2 - 1} + O\left(\frac{1}{\nu^2}\right) \right),$$

**11.11.6** 
$$\mathbf{E}_\nu(z) = \frac{2}{\pi\nu} \left( \sin^2\left(\frac{1}{2}\pi\nu\right) + \frac{\nu z}{\nu^2 - 1} \cos^2\left(\frac{1}{2}\pi\nu\right) + O\left(\frac{1}{\nu^2}\right) \right).$$

If  $\nu = n (\in \mathbb{Z})$ , then (11.10.29) applies for  $\mathbf{J}_n(z)$ , and

**11.11.7** 
$$\mathbf{E}_{2n}(z) \sim \frac{2z}{(4n^2 - 1)\pi},$$

$$\mathbf{E}_{2n+1}(z) \sim \frac{2}{(2n + 1)\pi}, \quad n \rightarrow \pm\infty.$$

**11.11(iii) Large  $\nu$ , Fixed  $z/\nu$**

For fixed  $\lambda (> 0)$ ,

**11.11.8** 
$$\mathbf{A}_\nu(\lambda\nu) \sim \frac{1}{\pi} \sum_{k=0}^{\infty} \frac{(2k)! a_k(\lambda)}{\nu^{2k+1}},$$

$$\nu \rightarrow \infty, |\text{ph } \nu| \leq \pi - \delta (< \pi),$$

where

**11.11.9** 
$$a_0 = \frac{1}{1 + \lambda}, \quad a_1 = -\frac{\lambda}{2(1 + \lambda)^4},$$

$$a_2 = \frac{9\lambda^2 - \lambda}{24(1 + \lambda)^7}, \quad a_3 = -\frac{225\lambda^3 - 54\lambda^2 + \lambda}{720(1 + \lambda)^{10}}.$$

For fixed  $\lambda (> 1)$ ,

**11.11.10** 
$$\mathbf{A}_{-\nu}(\lambda\nu) \sim -\frac{1}{\pi} \sum_{k=0}^{\infty} \frac{(2k)! a_k(-\lambda)}{\nu^{2k+1}}, \quad \nu \rightarrow +\infty.$$

For fixed  $\lambda, 0 < \lambda < 1$ ,

**11.11.11** 
$$\mathbf{A}_{-\nu}(\lambda\nu) \sim \sqrt{\frac{2}{\pi\nu}} e^{-\nu\mu} \sum_{k=0}^{\infty} \frac{\left(\frac{1}{2}\right)_k b_k(\lambda)}{\nu^k}, \quad \nu \rightarrow +\infty,$$

where

**11.11.12** 
$$\mu = \sqrt{1 - \lambda^2} - \ln\left(\frac{1 + \sqrt{1 - \lambda^2}}{\lambda}\right),$$

and

**11.11.13** 
$$b_0(\lambda) = \frac{1}{(1 - \lambda^2)^{1/4}}, \quad b_1(\lambda) = \frac{2 + 3\lambda^2}{12(1 - \lambda^2)^{7/4}},$$

$$b_2(\lambda) = \frac{4 + 300\lambda^2 + 81\lambda^4}{864(1 - \lambda^2)^{13/4}}.$$

In particular, as  $\nu \rightarrow +\infty$ ,

**11.11.14** 
$$\mathbf{A}_{-\nu}(\lambda\nu) \sim \frac{1}{\pi\nu(\lambda - 1)}, \quad \lambda > 1,$$

**11.11.15**

$$\mathbf{A}_{-\nu}(\lambda\nu) \sim \left(\frac{2}{\pi\nu}\right)^{1/2} \left(\frac{1 + \sqrt{1 - \lambda^2}}{\lambda}\right)^\nu \frac{e^{-\nu\sqrt{1 - \lambda^2}}}{(1 - \lambda^2)^{1/4}},$$

$0 < \lambda < 1.$

Also, as  $\nu \rightarrow +\infty$ ,

**11.11.16** 
$$\mathbf{A}_{-\nu}(\nu) \sim \frac{2^{4/3}}{3^{7/6} \Gamma\left(\frac{2}{3}\right) \nu^{1/3}},$$

and

**11.11.17** 
$$\mathbf{A}_{-\nu}\left(\nu + a\nu^{1/3}\right) = 2^{1/3} \nu^{-1/3} \text{Hi}\left(-2^{1/3}a\right) + O(\nu^{-1}),$$

uniformly for bounded real values of  $a$ . For the Scorer function  $\text{Hi}$  see §9.12(i).

All of (11.11.10)–(11.11.17) can be regarded as special cases of two asymptotic expansions given in Olver (1997b, pp. 352–357) for  $\mathbf{A}_{-\nu}(\lambda\nu)$  as  $\nu \rightarrow +\infty$ , one being uniform for  $\delta \leq \lambda \leq 1$ , where  $\delta$  again denotes an arbitrary small positive constant, and the other being uniform for  $1 \leq \lambda < \infty$ . (Note that Olver’s definition of  $\mathbf{A}_\nu(z)$  omits the factor  $1/\pi$  in (11.10.4).) See also Watson (1944, §10.15).

Lastly, corresponding asymptotic approximations and expansions for  $\mathbf{J}_\nu(\lambda\nu)$  and  $\mathbf{E}_\nu(\lambda\nu)$  follow from (11.10.15) and (11.10.16) and the corresponding asymptotic expansions for the Bessel functions  $J_\nu(z)$  and  $Y_\nu(z)$ ; see §10.19(ii). In particular,

**11.11.18** 
$$\mathbf{J}_\nu(\nu) \sim \frac{2^{1/3}}{3^{2/3} \Gamma\left(\frac{2}{3}\right) \nu^{1/3}}, \quad \nu \rightarrow +\infty,$$

**11.11.19** 
$$\mathbf{E}_\nu(\nu) \sim \frac{2^{1/3}}{3^{7/6} \Gamma\left(\frac{2}{3}\right) \nu^{1/3}}, \quad \nu \rightarrow +\infty.$$

## Applications

### 11.12 Physical Applications

Applications of Struve functions occur in water-wave and surface-wave problems (Hirata (1975) and Ahmadi and Widnall (1985)), unsteady aerodynamics (Shaw (1985) and Wehausen and Laitone (1960)), distribution of fluid pressure over a vibrating disk (McLachlan (1934)), resistive MHD instability theory (Paris and Sy (1983)), and optical diffraction (Levine and Schwinger (1948)). More recently Struve functions have appeared in many particle quantum dynamical studies of spin decoherence (Shao and Hänggi (1998)) and nanotubes (Pedersen (2003)).

## Computation

### 11.13 Methods of Computation

#### 11.13(i) Introduction

Subsequent subsections treat the computation of Struve functions. The treatment of Lommel and Anger–Weber functions is similar. For a review of methods for the computation of  $\mathbf{H}_\nu(z)$  see Zanovello (1975).

#### 11.13(ii) Series Expansions

Although the power-series expansions (11.2.1) and (11.2.2), and the Bessel-function expansions of §11.4(iv) converge for all finite values of  $z$ , they are cumbersome to use when  $|z|$  is large owing to slowness of convergence and cancellation. For large  $|z|$  and/or  $|\nu|$  the asymptotic expansions given in §11.6 should be used instead.

#### 11.13(iii) Quadrature

For numerical purposes the most convenient of the representations given in §11.5, at least for real variables, include the integrals (11.5.2)–(11.5.5) for  $\mathbf{K}_\nu(z)$  and  $\mathbf{M}_\nu(z)$ . Subsequently  $\mathbf{H}_\nu(z)$  and  $\mathbf{L}_\nu(z)$  are obtainable via (11.2.5) and (11.2.6). Other integrals that appear in §11.5(i) have highly oscillatory integrands unless  $z$  is small.

For complex variables the methods described in §§3.5(viii) and 3.5(ix) are available.

#### 11.13(iv) Differential Equations

A comprehensive approach is to integrate the defining inhomogeneous differential equations (11.2.7) and (11.2.9) numerically, using methods described in §3.7. To insure stability the integration path must be chosen so that as we proceed along it the wanted solution grows in magnitude at least as rapidly as the complementary solutions.

Suppose  $\nu \geq 0$  and  $x$  is real and positive. Then from the limiting forms for small argument (§§11.2(i), 10.7(i), 10.30(i)), limiting forms for large argument (§§11.6(i), 10.7(ii), 10.30(ii)), and the connection formulas (11.2.5) and (11.2.6), it is seen that  $\mathbf{H}_\nu(x)$  and  $\mathbf{L}_\nu(x)$  can be computed in a stable manner by integrating forwards, that is, from the origin toward infinity. The solution  $\mathbf{K}_\nu(x)$  needs to be integrated backwards for small  $x$ , and either forwards or backwards for large  $x$  depending whether or not  $\nu$  exceeds  $\frac{1}{2}$ . For  $\mathbf{M}_\nu(x)$  both forward and backward integration are unstable, and boundary-value methods are required (§3.7(iii)).

#### 11.13(v) Difference Equations

Sequences of values of  $\mathbf{H}_\nu(z)$  and  $\mathbf{L}_\nu(z)$ , with  $z$  fixed, can be computed by application of the inhomogeneous difference equations (11.4.23) and (11.4.25). There are similar problems to those described in §11.13(iv) concerning stability. In consequence forward recurrence, backward recurrence, or boundary-value methods may be necessary. See §3.6 for implementation of these methods, and with the Weber function  $\mathbf{E}_n(x)$  as an example.

### 11.14 Tables

#### 11.14(i) Introduction

For tables before 1961 see Fletcher *et al.* (1962) and Lebedev and Fedorova (1960). Tables listed in these Indices are omitted from the subsections that follow.

#### 11.14(ii) Struve Functions

- Abramowitz and Stegun (1964, Chapter 12) tabulates  $\mathbf{H}_n(x)$ ,  $\mathbf{H}_n(x) - Y_n(x)$ , and  $I_n(x) - \mathbf{L}_n(x)$  for  $n = 0, 1$  and  $x = 0(.1)5$ ,  $x^{-1} = 0(.01)0.2$  to 6D or 7D.
- Agrest *et al.* (1982) tabulates  $\mathbf{H}_n(x)$  and  $e^{-x} \mathbf{L}_n(x)$  for  $n = 0, 1$  and  $x = 0(.001)5(.005)15(.01)100$  to 11D.
- Barrett (1964) tabulates  $\mathbf{L}_n(x)$  for  $n = 0, 1$  and  $x = 0.2(.005)4(.05)10(.1)19.2$  to 5 or 6S,  $x = 6(.25)59.5(.5)100$  to 2S.
- Zanovello (1975) tabulates  $\mathbf{H}_n(x)$  for  $n = -4(1)15$  and  $x = 0.5(.5)26$  to 8D or 9S.
- Zhang and Jin (1996) tabulates  $\mathbf{H}_n(x)$  and  $\mathbf{L}_n(x)$  for  $n = -4(1)3$  and  $x = 0(1)20$  to 8D or 7S.

#### 11.14(iii) Integrals

- Abramowitz and Stegun (1964, Chapter 12) tabulates  $\int_0^x (I_0(t) - \mathbf{L}_0(t)) dt$  and  $(2/\pi) \int_x^\infty t^{-1} \mathbf{H}_0(t) dt$  for  $x = 0(.1)5$  to 5D or 7D;  $\int_0^x (\mathbf{H}_0(t) - Y_0(t)) dt - (2/\pi) \ln x$ ,  $\int_0^x (I_0(t) - \mathbf{L}_0(t)) dt - (2/\pi) \ln x$ , and  $\int_x^\infty t^{-1} (\mathbf{H}_0(t) - Y_0(t)) dt$  for  $x^{-1} = 0(.01)0.2$  to 6D.
- Agrest *et al.* (1982) tabulates  $\int_0^x \mathbf{H}_0(t) dt$  and  $e^{-x} \int_0^x \mathbf{L}_0(t) dt$  for  $x = 0(.001)5(.005)15(.01)100$  to 11D.

#### 11.14(iv) Anger–Weber Functions

- Bernard and Ishimaru (1962) tabulates  $\mathbf{J}_\nu(x)$  and  $\mathbf{E}_\nu(x)$  for  $\nu = -10(.1)10$  and  $x = 0(.1)10$  to 5D.
- Jahnke and Emde (1945) tabulates  $\mathbf{E}_n(x)$  for  $n = 1, 2$  and  $x = 0(.01)14.99$  to 4D.

### 11.14(v) Incomplete Functions

- Agrest and Maksimov (1971, Chapter 11) defines *incomplete* Struve, Anger, and Weber functions and includes tables of an incomplete Struve function  $\mathbf{H}_n(x, \alpha)$  for  $n = 0, 1$ ,  $x = 0(.2)10$ , and  $\alpha = 0(.2)1.4, \frac{1}{2}\pi$ , together with surface plots.

## 11.15 Approximations

### 11.15(i) Expansions in Chebyshev Series

- Luke (1975, pp. 416–421) gives Chebyshev-series expansions for  $\mathbf{H}_n(x)$ ,  $\mathbf{L}_n(x)$ ,  $0 \leq |x| \leq 8$ , and  $\mathbf{H}_n(x) - Y_n(x)$ ,  $x \geq 8$ , for  $n = 0, 1$ ;  $\int_0^x t^{-m} \mathbf{H}_0(t) dt$ ,  $\int_0^x t^{-m} \mathbf{L}_0(t) dt$ ,  $0 \leq |x| \leq 8$ ,  $m = 0, 1$  and  $\int_0^x (\mathbf{H}_0(t) - Y_0(t)) dt$ ,  $\int_x^\infty t^{-1} (\mathbf{H}_0(t) - Y_0(t)) dt$ ,  $x \geq 8$ ; the coefficients are to 20D.
- MacLeod (1993) gives Chebyshev-series expansions for  $\mathbf{L}_0(x)$ ,  $\mathbf{L}_1(x)$ ,  $0 \leq x \leq 16$ , and  $I_0(x) - \mathbf{L}_0(x)$ ,  $I_1(x) - \mathbf{L}_1(x)$ ,  $x \geq 16$ ; the coefficients are to 20D.

### 11.15(ii) Rational and Polynomial Approximations

- Newman (1984) gives polynomial approximations for  $\mathbf{H}_n(x)$  for  $n = 0, 1$ ,  $0 \leq x \leq 3$ , and rational-fraction approximations for  $\mathbf{H}_n(x) - Y_n(x)$  for  $n = 0, 1$ ,  $x \geq 3$ . The maximum errors do not exceed  $1.2 \times 10^{-8}$  for the former and  $2.5 \times 10^{-8}$  for the latter.

## 11.16 Software

See <http://dlmf.nist.gov/11.16>.

## References

### General References

The main references used in writing this chapter are Babister (1967, Chapter 3) and Watson (1944, Chapter 10). For additional bibliographic reading see Erdélyi *et al.* (1953b, §7.5), Luke (1969b), Luke (1975, Chapter 10), Magnus *et al.* (1966, §3.10), and Olver (1997b).

## Sources

The following list gives the references or other indications of proofs that were used in constructing the various sections of this chapter. These sources supplement the references that are quoted in the text.

§11.2 Watson (1944, pp. 328–329), Olver (1997b, pp. 274–277). The notation  $\mathbf{M}_\nu(z)$  is new and this function has been introduced to play a similar role to  $\mathbf{L}_\nu(z)$  that  $\mathbf{K}_\nu(z)$  does to  $\mathbf{H}_\nu(z)$ . For §11.2(iii) see §2.7(iv) and Olver (1997b, pp. 274–277). The last reference restricts (11.2.15) to the sector  $|\text{ph } z| \leq \frac{1}{2}\pi$ , and instead covers the sector  $\frac{1}{2}\pi \leq \text{ph } z \leq \frac{3}{2}\pi$  with another set of solutions. (Similarly for the conjugate sector  $-\frac{3}{2}\pi \leq \text{ph } z \leq -\frac{1}{2}\pi$ .)

§11.3 The graphics were produced at NIST.

§11.4 Watson (1944, §§10.4, 10.45). (11.4.1), (11.4.2) both follow from Erdélyi *et al.* (1953b, p. 39, Eq. (64)): for (11.4.1) set  $\xi = z$  and use (11.2.5); for (11.4.2) replace  $Y_{n+\frac{1}{2}}(\xi)$  by  $(-1)^{n+1} J_{-n-\frac{1}{2}}(\xi)$  in consequence of (10.2.3), then set  $\xi = iz$  and use (11.2.2), (10.27.6). For (11.4.3), (11.4.4) see Babister (1967, pp. 64, 75). For (11.4.5)–(11.4.12) combine (11.4.3), (11.4.4) with (10.47.3), (10.47.7), §10.49(i), §10.49(ii), (11.4.23), (11.4.25). (11.4.16), (11.4.17) follow from (11.2.1), (11.2.2). For (11.4.31) see Babister (1967, pp. 60, 74).

§11.5 For (11.5.1)–(11.5.3), (11.5.6), and (11.5.7) see Watson (1944, pp. 328, 331, 332), together with (11.2.5) in the case of (11.5.2) and (11.5.3), and (11.2.2) in the case of (11.5.6). For (11.5.4) and (11.5.5) see Babister (1967, Eq. (3.102)) and collapse the integration path on to the interval  $[0, 1]$ . For (11.5.8) see Babister (1967, §3.7) with modified convergence conditions. For (11.5.9) deform the integration path in (11.5.8) into a loop and use (11.2.2).

§11.6 For (11.6.1) apply Watson's lemma (§2.4(i)) to (11.5.2), or combine Watson (1944, p. 333, Eq. (2)) with (11.2.5). See also the subsequent text in this reference, and Olver (1997b, p. 277, Ex. 15.5). For (11.6.2) convert (11.5.4) to a loop integral  $\int_0^{(1+)}$  to remove the restriction  $\Re \nu > -\frac{1}{2}$ , extend the loop to pass through the point  $t = \infty$  on the positive real axis, then apply Laplace's method (§2.4(iii)) to each of the two integrals with paths from  $t = 0$  to  $t = \infty$ , one passing below  $t = 1$  and the other passing above  $t = 1$ . For (11.6.3) write the integrals over the

intervals  $[0, \infty)$  and  $[z, \infty)$ ; use (11.6.1) with the first term extracted, and a limiting procedure on the integral over  $[0, \infty)$ . For (11.6.4) replace  $z$  by  $iz$  in (11.6.3) and apply (11.2.5), (11.2.6), (10.27.11). For (11.6.5) apply (5.11.7) to (11.2.1), (11.2.2). For (11.6.6) and (11.6.9) see Watson (1944, §10.43): a similar method can be used for (11.6.7), starting from (11.5.4).

§11.7 For (11.7.1)–(11.7.6) use §11.4(v). For (11.7.7)–(11.7.12) see Babister (1967, pp. 68, 71–72), Watson (1944, pp. 392, 397). For (11.7.13)–(11.7.16) see Babister (1967, §§3.13, 3.15).

§11.9 Watson (1944, §10.75).

§11.10 Watson (1944, pp. 308–312). The notation  $\mathbf{A}_\nu(z)$ , without the factor  $1/\pi$ , was introduced in Olver (1997b, p. 84). For (11.10.12) use (11.10.1), (11.10.2). For (11.10.16) combine (11.10.14), (11.10.15), and (10.2.3). For (11.10.19), (11.10.20), use (11.10.8)–(11.10.11) with  $\nu = \pm\frac{1}{2}$  and identify the resulting sums with those associated with the right-hand sides via (7.6.5), (7.6.7). For (11.10.22), (11.10.23) see Watson (1944, pp. 336–337) or Erdélyi *et al.*

(1953b, p. 40). The upper summation limit in (11.10.23) is given incorrectly in Watson (1944, p. 337), and this error is reproduced in Erdélyi *et al.* (1953b), as well as in later printings of Abramowitz and Stegun (1964, Chapter 12)—earlier printings contained a different error. (11.10.23) can be derived by combining (11.2.1) with (11.10.12), (11.10.22). For (11.10.25) use (11.10.1) and (11.10.2). For (11.10.26) use (11.10.22). (11.10.27) and (11.10.28) can be obtained by differentiation of (11.10.1) and (11.10.2), followed by straightforward manipulation of the integrals and comparison with (11.5.1) and (11.10.1). For (11.10.29) use (11.10.1) and (10.9.2). For (11.10.30)–(11.10.31) see Luke (1969b, p. 55).

The graphics were produced at NIST.

§11.11 Watson (1944, §§10.14–10.15). (11.11.2), (11.11.3) follow from (11.10.15), (11.10.16). (11.11.5), (11.11.6) follow from (11.10.8)–(11.10.11). Eqs. (11.11.7) follow from (11.6.5). For (11.11.11), see Dingle (1973, p. 388). For (11.11.8)–(11.11.19), see Olver (1997b, pp. 103 and 352).



## Chapter 12

# Parabolic Cylinder Functions

N. M. Temme<sup>1</sup>

<b>Notation</b>	<b>304</b>	12.12 Integrals . . . . .	313
12.1 Special Notation . . . . .	304	12.13 Sums . . . . .	313
<b>Properties</b>	<b>304</b>	12.14 The Function $W(a, x)$ . . . . .	314
12.2 Differential Equations . . . . .	304	12.15 Generalized Parabolic Cylinder Functions	317
12.3 Graphics . . . . .	305	<b>Applications</b>	<b>317</b>
12.4 Power-Series Expansions . . . . .	307	12.16 Mathematical Applications . . . . .	317
12.5 Integral Representations . . . . .	307	12.17 Physical Applications . . . . .	317
12.6 Continued Fraction . . . . .	308	<b>Computation</b>	<b>317</b>
12.7 Relations to Other Functions . . . . .	308	12.18 Methods of Computation . . . . .	318
12.8 Recurrence Relations and Derivatives . .	309	12.19 Tables . . . . .	318
12.9 Asymptotic Expansions for Large Variable	309	12.20 Approximations . . . . .	318
12.10 Uniform Asymptotic Expansions for Large		12.21 Software . . . . .	318
Parameter . . . . .	309	<b>References</b>	<b>318</b>
12.11 Zeros . . . . .	312		

<sup>1</sup>Centrum voor Wiskunde en Informatica, Department MAS, Amsterdam, The Netherlands.

**Acknowledgments:** This chapter is based in part on Abramowitz and Stegun (1964, Chapter 19) by J. C. P. Miller.

**Copyright** © 2009 National Institute of Standards and Technology. All rights reserved.



## Notation

### 12.1 Special Notation

(For other notation see pp. xiv and 873.)

- $x, y$  real variables.  
 $z$  complex variable.  
 $n, s$  nonnegative integers.  
 $a, \nu$  real or complex parameters.  
 $\delta$  arbitrary small positive constant.

Unless otherwise noted, primes indicate derivatives with respect to the variable, and fractional powers take their principal values.

The main functions treated in this chapter are the parabolic cylinder functions (PCFs), also known as Weber parabolic cylinder functions:  $U(a, z)$ ,  $V(a, z)$ ,  $\bar{U}(a, z)$ , and  $W(a, z)$ . These notations are due to Miller (1952, 1955). An older notation, due to Whittaker (1902), for  $U(a, z)$  is  $D_\nu(z)$ . The notations are related by  $U(a, z) = D_{-a-\frac{1}{2}}(z)$ . Whittaker's notation  $D_\nu(z)$  is useful when  $\nu$  is a nonnegative integer (Hermite polynomial case).

## Properties

### 12.2 Differential Equations

#### 12.2(i) Introduction

PCFs are solutions of the differential equation

$$12.2.1 \quad \frac{d^2 w}{dz^2} + (az^2 + bz + c)w = 0,$$

with three distinct standard forms

$$12.2.2 \quad \frac{d^2 w}{dz^2} - \left(\frac{1}{4}z^2 + a\right)w = 0,$$

$$12.2.3 \quad \frac{d^2 w}{dz^2} + \left(\frac{1}{4}z^2 - a\right)w = 0,$$

$$12.2.4 \quad \frac{d^2 w}{dz^2} + \left(\nu + \frac{1}{2} - \frac{1}{4}z^2\right)w = 0.$$

Each of these equations is transformable into the others. Standard solutions are  $U(a, \pm z)$ ,  $V(a, \pm z)$ ,  $\bar{U}(a, \pm z)$  (not complex conjugate),  $U(-a, \pm iz)$  for (12.2.2);  $W(a, \pm x)$  for (12.2.3);  $D_\nu(\pm z)$  for (12.2.4), where

$$12.2.5 \quad D_\nu(z) = U\left(-\frac{1}{2} - \nu, z\right).$$

All solutions are entire functions of  $z$  and entire functions of  $a$  or  $\nu$ .

For real values of  $z$  ( $= x$ ), numerically satisfactory pairs of solutions (§2.7(iv)) of (12.2.2) are  $U(a, x)$  and

$V(a, x)$  when  $x$  is positive, or  $U(a, -x)$  and  $V(a, -x)$  when  $x$  is negative. For (12.2.3)  $W(a, x)$  and  $W(a, -x)$  comprise a numerically satisfactory pair, for all  $x \in \mathbb{R}$ . The solutions  $W(a, \pm x)$  are treated in §12.14.

In  $\mathbb{C}$ , for  $j = 0, 1, 2, 3$ ,  $U((-1)^{j-1}a, (-i)^{j-1}z)$  and  $U((-1)^j a, (-i)^j z)$  comprise a numerically satisfactory pair of solutions in the half-plane  $\frac{1}{4}(2j-3)\pi \leq \text{ph } z \leq \frac{1}{4}(2j+1)\pi$ .

#### 12.2(ii) Values at $z = 0$

$$12.2.6 \quad U(a, 0) = \frac{\sqrt{\pi}}{2^{\frac{1}{2}a + \frac{1}{4}} \Gamma\left(\frac{3}{4} + \frac{1}{2}a\right)},$$

$$12.2.7 \quad U'(a, 0) = -\frac{\sqrt{\pi}}{2^{\frac{1}{2}a - \frac{1}{4}} \Gamma\left(\frac{1}{4} + \frac{1}{2}a\right)},$$

$$12.2.8 \quad V(a, 0) = \frac{\pi 2^{\frac{1}{2}a + \frac{1}{4}}}{\left(\Gamma\left(\frac{3}{4} - \frac{1}{2}a\right)\right)^2 \Gamma\left(\frac{1}{4} + \frac{1}{2}a\right)},$$

$$12.2.9 \quad V'(a, 0) = \frac{\pi 2^{\frac{1}{2}a + \frac{3}{4}}}{\left(\Gamma\left(\frac{1}{4} - \frac{1}{2}a\right)\right)^2 \Gamma\left(\frac{3}{4} + \frac{1}{2}a\right)}.$$

#### 12.2(iii) Wronskians

$$12.2.10 \quad \mathscr{W}\{U(a, z), V(a, z)\} = \sqrt{2/\pi},$$

$$12.2.11 \quad \mathscr{W}\{U(a, z), U(a, -z)\} = \frac{\sqrt{2\pi}}{\Gamma\left(\frac{1}{2} + a\right)},$$

$$12.2.12 \quad \mathscr{W}\{U(a, z), U(-a, \pm iz)\} = \mp i e^{\pm i\pi\left(\frac{1}{2}a + \frac{1}{4}\right)}.$$

#### 12.2(iv) Reflection Formulas

For  $n = 0, 1, \dots$ ,

$$12.2.13 \quad U\left(-n - \frac{1}{2}, -z\right) = (-1)^n U\left(-n - \frac{1}{2}, z\right),$$

$$12.2.14 \quad V\left(n + \frac{1}{2}, -z\right) = (-1)^n V\left(n + \frac{1}{2}, z\right).$$

#### 12.2(v) Connection Formulas

$$12.2.15 \quad U(a, -z) = -\sin(\pi a) U(a, z) + \frac{\pi}{\Gamma\left(\frac{1}{2} + a\right)} V(a, z),$$

$$12.2.16 \quad V(a, -z) = \frac{\cos(\pi a)}{\Gamma\left(\frac{1}{2} - a\right)} U(a, z) + \sin(\pi a) V(a, z).$$

$$12.2.17 \quad \sqrt{2\pi} U(-a, \pm iz) = \Gamma\left(\frac{1}{2} + a\right) \left( e^{\mp i\pi\left(\frac{1}{2}a - \frac{1}{4}\right)} U(a, z) + e^{\pm i\pi\left(\frac{1}{2}a - \frac{1}{4}\right)} U(a, -z) \right).$$

$$12.2.18 \quad \sqrt{2\pi} U(a, z) = \Gamma\left(\frac{1}{2} - a\right) \left( e^{\mp i\pi\left(\frac{1}{2}a + \frac{1}{4}\right)} U(-a, \pm iz) + e^{\pm i\pi\left(\frac{1}{2}a + \frac{1}{4}\right)} U(-a, \mp iz) \right),$$

$$U(a, z) = \pm i e^{\pm i\pi a} U(a, -z)$$

12.2.19 
$$+ \frac{\sqrt{2\pi}}{\Gamma(\frac{1}{2} + a)} e^{\pm i\pi(\frac{1}{2}a - \frac{1}{4})} U(-a, \pm iz).$$

12.2.20 
$$V(a, z) = \frac{\mp i}{\Gamma(\frac{1}{2} - a)} U(a, z) + \sqrt{\frac{2}{\pi}} e^{\mp i\pi(\frac{1}{2}a - \frac{1}{4})} U(-a, \pm iz).$$

**12.2(vi) Solution  $\bar{U}(a, x)$ ; Modulus and Phase Functions**

When  $z (=x)$  is real the solution  $\bar{U}(a, x)$  is defined by

12.2.21 
$$\bar{U}(a, x) = \Gamma(\frac{1}{2} - a) V(a, x),$$
  
 unless  $a = \frac{1}{2}, \frac{3}{2}, \dots$ , in which case  $\bar{U}(a, x)$  is undefined. Its importance is that when  $a$  is negative and  $|a|$  is large,  $U(a, x)$  and  $\bar{U}(a, x)$  asymptotically have the same envelope (modulus) and are  $\frac{1}{2}\pi$  out of phase in the oscillatory interval  $-2\sqrt{-a} < x < 2\sqrt{-a}$ . Properties of

$\bar{U}(a, x)$  follow immediately from those of  $V(a, x)$  via (12.2.21).

In the oscillatory interval we define

12.2.22 
$$U(a, x) + i\bar{U}(a, x) = F(a, x)e^{i\theta(a, x)},$$

12.2.23 
$$U'(a, x) + i\bar{U}'(a, x) = -G(a, x)e^{i\psi(a, x)},$$
  
 where  $F(a, x) (>0)$ ,  $\theta(a, x)$ ,  $G(a, x) (>0)$ , and  $\psi(a, x)$  are real.  $F$  or  $G$  is the modulus and  $\theta$  or  $\psi$  is the corresponding phase.

For properties of the modulus and phase functions, including differential equations, see Miller (1955, pp. 72–73). For graphs of the modulus functions see §12.3(i).

**12.3 Graphics**

**12.3(i) Real Variables**

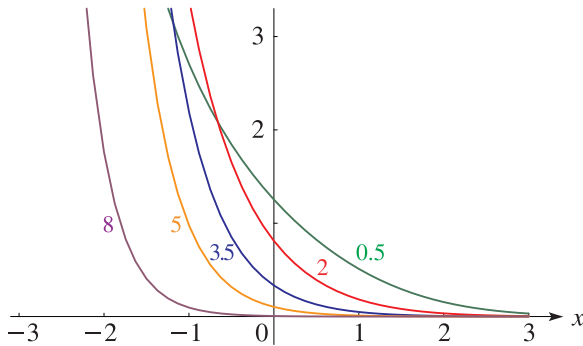


Figure 12.3.1:  $U(a, x)$ ,  $a = 0.5, 2, 3.5, 5, 8$ .

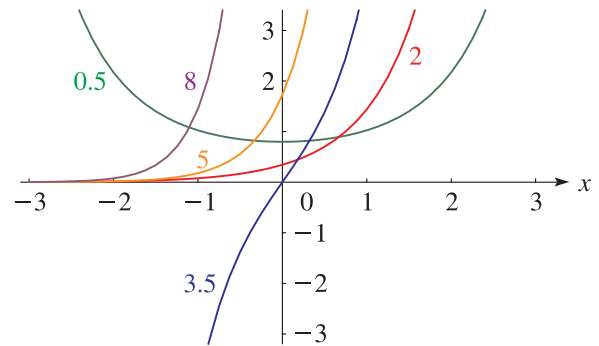


Figure 12.3.2:  $V(a, x)$ ,  $a = 0.5, 2, 3.5, 5, 8$ .

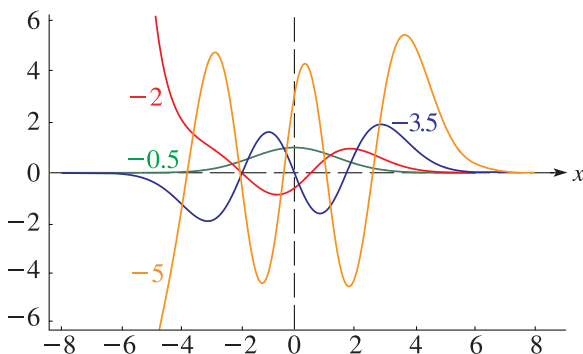


Figure 12.3.3:  $U(a, x)$ ,  $a = -0.5, -2, -3.5, -5$ .

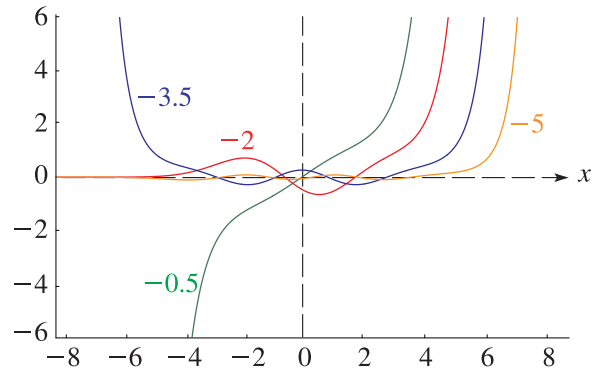


Figure 12.3.4:  $V(a, x)$ ,  $a = -0.5, -2, -3.5, -5$ .

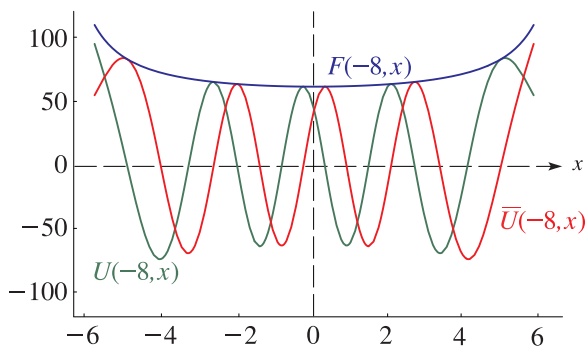


Figure 12.3.5:  $U(-8, x), \bar{U}(-8, x), F(-8, x), -4\sqrt{2} \leq x \leq 4\sqrt{2}$ .

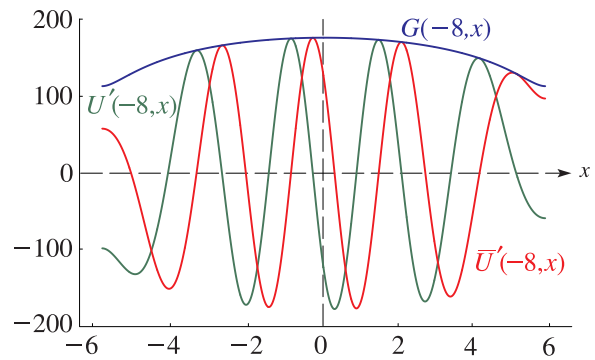


Figure 12.3.6:  $U'(-8, x), \bar{U}'(-8, x), G(-8, x), -4\sqrt{2} \leq x \leq 4\sqrt{2}$ .

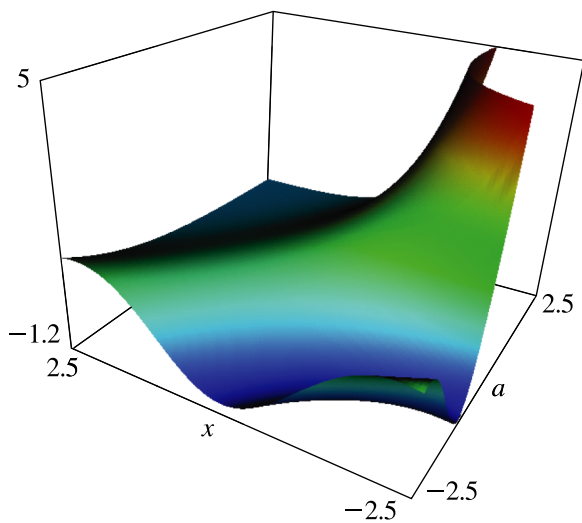


Figure 12.3.7:  $U(a, x), -2.5 \leq a \leq 2.5, -2.5 \leq x \leq 2.5$ .

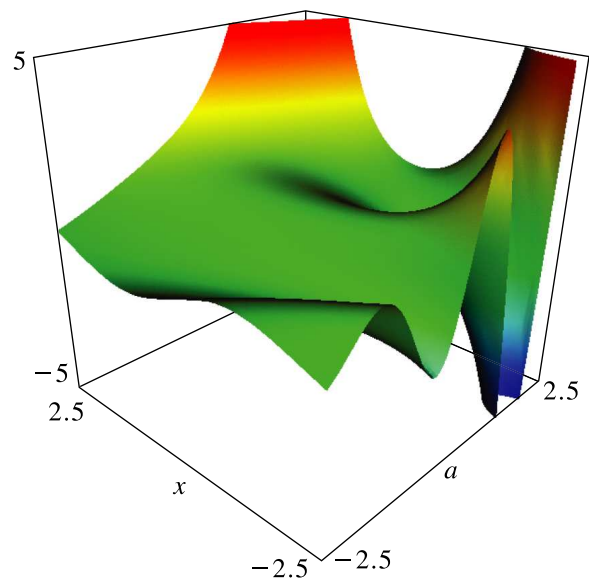


Figure 12.3.8:  $V(a, x), -2.5 \leq a \leq 2.5, -2.5 \leq x \leq 2.5$ .

### 12.3(ii) Complex Variables

In the graphics shown in this subsection, height corresponds to the absolute value of the function and color to the phase. See also p. [xiv](#).

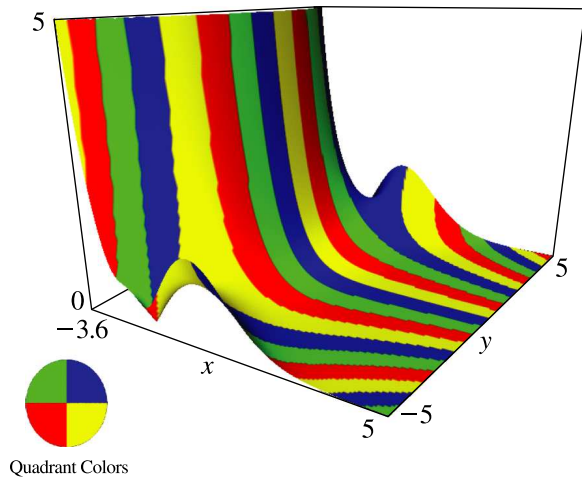


Figure 12.3.9:  $U(3.5, x + iy)$ ,  $-3.6 \leq x \leq 5$ ,  $-5 \leq y \leq 5$ .

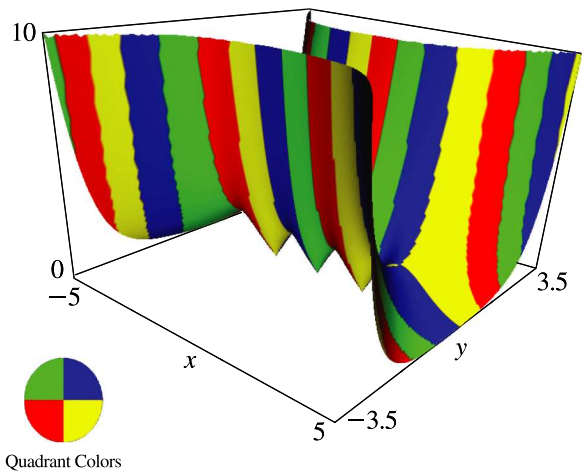


Figure 12.3.10:  $U(-3.5, x + iy)$ ,  $-5 \leq x \leq 5$ ,  $-3.5 \leq y \leq 3.5$ .

## 12.4 Power-Series Expansions

12.4.1  $U(a, z) = U(a, 0)u_1(a, z) + U'(a, 0)u_2(a, z)$ ,

12.4.2  $V(a, z) = V(a, 0)u_1(a, z) + V'(a, 0)u_2(a, z)$ , where the initial values are given by (12.2.6)–(12.2.9), and  $u_1(a, z)$  and  $u_2(a, z)$  are the even and odd solutions of (12.2.2) given by

12.4.3 
$$u_1(a, z) = e^{-\frac{1}{4}z^2} \left( 1 + (a + \frac{1}{2})\frac{z^2}{2!} + (a + \frac{1}{2})(a + \frac{5}{2})\frac{z^4}{4!} + \dots \right),$$

12.4.4 
$$u_2(a, z) = e^{-\frac{1}{4}z^2} \left( z + (a + \frac{3}{2})\frac{z^3}{3!} + (a + \frac{3}{2})(a + \frac{7}{2})\frac{z^5}{5!} + \dots \right).$$

Equivalently,

12.4.5 
$$u_1(a, z) = e^{\frac{1}{4}z^2} \left( 1 + (a - \frac{1}{2})\frac{z^2}{2!} + (a - \frac{1}{2})(a - \frac{5}{2})\frac{z^4}{4!} + \dots \right),$$

12.4.6 
$$u_2(a, z) = e^{\frac{1}{4}z^2} \left( z + (a - \frac{3}{2})\frac{z^3}{3!} + (a - \frac{3}{2})(a - \frac{7}{2})\frac{z^5}{5!} + \dots \right).$$

These series converge for all values of  $z$ .

## 12.5 Integral Representations

### 12.5(i) Integrals Along the Real Line

12.5.1 
$$U(a, z) = \frac{e^{-\frac{1}{4}z^2}}{\Gamma(\frac{1}{2} + a)} \int_0^\infty t^{a-\frac{1}{2}} e^{-\frac{1}{2}t^2 - zt} dt, \quad \Re a > -\frac{1}{2},$$

### 12.5.2

$$U(a, z) = \frac{ze^{-\frac{1}{4}z^2}}{\Gamma(\frac{1}{4} + \frac{1}{2}a)} \int_0^\infty t^{\frac{1}{2}a - \frac{3}{4}} e^{-t} (z^2 + 2t)^{-\frac{1}{2}a - \frac{3}{4}} dt, \quad |\text{ph } z| < \frac{1}{2}\pi, \Re a > -\frac{1}{2},$$

### 12.5.3

$$U(a, z) = \frac{e^{-\frac{1}{4}z^2}}{\Gamma(\frac{3}{4} + \frac{1}{2}a)} \int_0^\infty t^{\frac{1}{2}a - \frac{1}{4}} e^{-t} (z^2 + 2t)^{-\frac{1}{2}a - \frac{1}{4}} dt, \quad |\text{ph } z| < \frac{1}{2}\pi, \Re a > -\frac{3}{2},$$

### 12.5.4

$$U(a, z) = \sqrt{\frac{2}{\pi}} e^{\frac{1}{4}z^2} \times \int_0^\infty t^{-a - \frac{1}{2}} e^{-\frac{1}{2}t^2} \cos(zt + (\frac{1}{2}a + \frac{1}{4})\pi) dt, \quad \Re a < \frac{1}{2}.$$

### 12.5(ii) Contour Integrals

The following integrals correspond to those of §12.5(i).

12.5.5 
$$U(a, z) = \frac{\Gamma(\frac{1}{2} - a)}{2\pi i} e^{-\frac{1}{4}z^2} \int_{-\infty}^{(0+)} e^{zt - \frac{1}{2}t^2} t^{a - \frac{1}{2}} dt, \quad a \neq \frac{1}{2}, \frac{3}{2}, \frac{5}{2}, \dots, -\pi < \text{ph } t < \pi.$$

Restrictions on  $a$  are not needed in the following two representations:

12.5.6 
$$U(a, z) = \frac{e^{\frac{1}{4}z^2}}{i\sqrt{2\pi}} \int_{c-i\infty}^{c+i\infty} e^{-zt + \frac{1}{2}t^2} t^{-a - \frac{1}{2}} dt, \quad -\frac{1}{2}\pi < \text{ph } t < \frac{1}{2}\pi, c > 0,$$

### 12.5.7

$$V(a, z) = \frac{e^{-\frac{1}{4}z^2}}{2\pi} \left( \int_{-ic-\infty}^{-ic+\infty} + \int_{ic-\infty}^{ic+\infty} \right) e^{zt - \frac{1}{2}t^2} t^{a - \frac{1}{2}} dt, \quad -\pi < \text{ph } t < \pi, c > 0.$$

For proofs and further results see Miller (1955, §4) and Whittaker (1902).

### 12.5(iii) Mellin–Barnes Integrals

#### 12.5.8

$$U(a, z) = \frac{e^{-\frac{1}{4}z^2} z^{-a-\frac{1}{2}}}{2\pi i \Gamma(\frac{1}{2} + a)} \times \int_{-i\infty}^{i\infty} \Gamma(t) \Gamma(\frac{1}{2} + a - 2t) 2^t z^{2t} dt,$$

$$a \neq -\frac{1}{2}, -\frac{3}{2}, -\frac{5}{2}, \dots, |\text{ph } z| < \frac{3}{4}\pi,$$

where the contour separates the poles of  $\Gamma(t)$  from those of  $\Gamma(\frac{1}{2} + a - 2t)$ .

#### 12.5.9

$$V(a, z) = \sqrt{\frac{2}{\pi}} \frac{e^{\frac{1}{4}z^2} z^{a-\frac{1}{2}}}{2\pi i \Gamma(\frac{1}{2} - a)} \times \int_{-i\infty}^{i\infty} \Gamma(t) \Gamma(\frac{1}{2} - a - 2t) 2^t z^{2t} \cos(\pi t) dt,$$

$$a \neq \frac{1}{2}, \frac{3}{2}, \frac{5}{2}, \dots, |\text{ph } z| < \frac{1}{4}\pi,$$

where the contour separates the poles of  $\Gamma(t)$  from those of  $\Gamma(\frac{1}{2} - a - 2t)$ .

### 12.5(iv) Compendia

For further collections of integral representations see Apelblat (1983, pp. 427–436), Erdélyi *et al.* (1953b, v. 2, pp. 119–120), Erdélyi *et al.* (1954a, pp. 289–291 and 362), Gradshteyn and Ryzhik (2000, §§9.24–9.25), Magnus *et al.* (1966, pp. 328–330), Oberhettinger (1974, pp. 251–252), and Oberhettinger and Badii (1973, pp. 378–384).

## 12.6 Continued Fraction

For a continued-fraction expansion of the ratio  $U(a, x)/U(a - 1, x)$  see Cuyt *et al.* (2008, pp. 340–341).

## 12.7 Relations to Other Functions

### 12.7(i) Hermite Polynomials

For the notation see §18.3.

$$12.7.1 \quad U(-\frac{1}{2}, z) = D_0(z) = e^{-\frac{1}{4}z^2},$$

$$U(-n - \frac{1}{2}, z) = D_n(z) = e^{-\frac{1}{4}z^2} He_n(z)$$

$$12.7.2 \quad = 2^{-n/2} e^{-\frac{1}{4}z^2} H_n\left(\frac{z}{\sqrt{2}}\right),$$

$$n = 0, 1, 2, \dots,$$

#### 12.7.3

$$V(n + \frac{1}{2}, z) = \sqrt{2/\pi} e^{\frac{1}{4}z^2} (-i)^n He_n(iz)$$

$$= \sqrt{2/\pi} e^{\frac{1}{4}z^2} (-i)^n 2^{-\frac{1}{2}n} H_n\left(\frac{iz}{\sqrt{2}}\right),$$

$$n = 0, 1, 2, \dots$$

### 12.7(ii) Error Functions, Dawson's Integral, and Probability Function

For the notation see §§7.2 and 7.18.

$$12.7.4 \quad V(-\frac{1}{2}, z) = (2/\sqrt{\pi}) e^{\frac{1}{4}z^2} F\left(\frac{z}{\sqrt{2}}\right),$$

$$12.7.5 \quad U(\frac{1}{2}, z) = D_{-1}(z) = \sqrt{\frac{1}{2}\pi} e^{\frac{1}{4}z^2} \text{erfc}\left(\frac{z}{\sqrt{2}}\right),$$

#### 12.7.6

$$U\left(n + \frac{1}{2}, z\right) = D_{-n-1}(z)$$

$$= \sqrt{\frac{\pi}{2}} \frac{(-1)^n}{n!} e^{-\frac{1}{4}z^2} \frac{d^n \left( e^{\frac{1}{2}z^2} \text{erfc}\left(\frac{z}{\sqrt{2}}\right) \right)}{dz^n},$$

$$n = 0, 1, 2, \dots,$$

$$U\left(n + \frac{1}{2}, z\right) = e^{\frac{1}{4}z^2} Hh_n(z)$$

$$12.7.7 \quad = \sqrt{\pi} 2^{\frac{1}{2}(n-1)} e^{\frac{1}{4}z^2} i^n \text{erfc}\left(\frac{z}{\sqrt{2}}\right),$$

$$n = -1, 0, 1, \dots$$

### 12.7(iii) Modified Bessel Functions

For the notation see §10.25(ii).

#### 12.7.8

$$U(-2, z) = \frac{z^{5/2}}{4\sqrt{2}\pi} \left( 2K_{\frac{1}{4}}\left(\frac{1}{4}z^2\right) + 3K_{\frac{3}{4}}\left(\frac{1}{4}z^2\right) - K_{\frac{5}{4}}\left(\frac{1}{4}z^2\right) \right),$$

$$12.7.9 \quad U(-1, z) = \frac{z^{3/2}}{2\sqrt{2}\pi} \left( K_{\frac{1}{4}}\left(\frac{1}{4}z^2\right) + K_{\frac{3}{4}}\left(\frac{1}{4}z^2\right) \right),$$

$$12.7.10 \quad U(0, z) = \sqrt{\frac{z}{2\pi}} K_{\frac{1}{4}}\left(\frac{1}{4}z^2\right),$$

$$12.7.11 \quad U(1, z) = \frac{z^{3/2}}{\sqrt{2}\pi} \left( K_{\frac{3}{4}}\left(\frac{1}{4}z^2\right) - K_{\frac{1}{4}}\left(\frac{1}{4}z^2\right) \right).$$

For these, the corresponding results for  $U(a, z)$  with  $a = 2, \pm 3, -\frac{1}{2}, -\frac{3}{2}, -\frac{5}{2}$ , and the corresponding results for  $V(a, z)$  with  $a = 0, \pm 1, \pm 2, \pm 3, \frac{1}{2}, \frac{3}{2}, \frac{5}{2}$ , see Miller (1955, pp. 42–43 and 77–79).

### 12.7(iv) Confluent Hypergeometric Functions

For the notation see §§13.2(i) and 13.14(i).

The even and odd solutions of (12.2.2) (see (12.4.3)–(12.4.6)) are given by

$$12.7.12 \quad u_1(a, z) = e^{-\frac{1}{4}z^2} M\left(\frac{1}{2}a + \frac{1}{4}, \frac{1}{2}, \frac{1}{2}z^2\right)$$

$$= e^{\frac{1}{4}z^2} M\left(-\frac{1}{2}a + \frac{1}{4}, \frac{1}{2}, -\frac{1}{2}z^2\right),$$

$$12.7.13 \quad u_2(a, z) = ze^{-\frac{1}{4}z^2} M\left(\frac{1}{2}a + \frac{3}{4}, \frac{3}{2}, \frac{1}{2}z^2\right)$$

$$= ze^{\frac{1}{4}z^2} M\left(-\frac{1}{2}a + \frac{3}{4}, \frac{3}{2}, -\frac{1}{2}z^2\right).$$

Also,

$$U(a, z) = 2^{-\frac{1}{4}-\frac{1}{2}a} e^{-\frac{1}{4}z^2} U\left(\frac{1}{2}a + \frac{1}{4}, \frac{1}{2}, \frac{1}{2}z^2\right)$$

$$12.7.14 \quad = 2^{-\frac{3}{4}-\frac{1}{2}a} ze^{-\frac{1}{4}z^2} U\left(\frac{1}{2}a + \frac{3}{4}, \frac{3}{2}, \frac{1}{2}z^2\right)$$

$$= 2^{-\frac{1}{2}a} z^{-\frac{1}{2}} W_{-\frac{1}{2}a, \pm\frac{1}{4}}\left(\frac{1}{2}z^2\right).$$

(It should be observed that the functions on the right-hand sides of (12.7.14) are multivalued; hence, for example,  $z$  cannot be replaced simply by  $-z$ .)

## 12.8 Recurrence Relations and Derivatives

### 12.8(i) Recurrence Relations

$$12.8.1 \quad zU(a, z) - U(a-1, z) + (a + \frac{1}{2})U(a+1, z) = 0,$$

$$12.8.2 \quad U'(a, z) + \frac{1}{2}zU(a, z) + (a + \frac{1}{2})U(a+1, z) = 0,$$

$$12.8.3 \quad U'(a, z) - \frac{1}{2}zU(a, z) + U(a-1, z) = 0,$$

$$12.8.4 \quad 2U'(a, z) + U(a-1, z) + (a + \frac{1}{2})U(a+1, z) = 0.$$

(12.8.1)–(12.8.4) are also satisfied by  $\bar{U}(a, z)$ .

$$12.8.5 \quad zV(a, z) - V(a+1, z) + (a - \frac{1}{2})V(a-1, z) = 0,$$

$$12.8.6 \quad V'(a, z) - \frac{1}{2}zV(a, z) - (a - \frac{1}{2})V(a-1, z) = 0,$$

$$12.8.7 \quad V'(a, z) + \frac{1}{2}zV(a, z) - V(a+1, z) = 0,$$

$$12.8.8 \quad 2V'(a, z) - V(a+1, z) - (a - \frac{1}{2})V(a-1, z) = 0.$$

### 12.8(ii) Derivatives

For  $m = 0, 1, 2, \dots$ ,

$$12.8.9 \quad \frac{d^m}{dz^m} \left( e^{\frac{1}{4}z^2} U(a, z) \right) = (-1)^m \left( \frac{1}{2} + a \right)_m e^{\frac{1}{4}z^2} U(a+m, z),$$

$$12.8.10 \quad \frac{d^m}{dz^m} \left( e^{-\frac{1}{4}z^2} U(a, z) \right) = (-1)^m e^{-\frac{1}{4}z^2} U(a-m, z),$$

$$12.8.11 \quad \frac{d^m}{dz^m} \left( e^{\frac{1}{4}z^2} V(a, z) \right) = e^{\frac{1}{4}z^2} V(a+m, z),$$

$$12.8.12 \quad \frac{d^m}{dz^m} \left( e^{-\frac{1}{4}z^2} V(a, z) \right) \\ = (-1)^m \left( \frac{1}{2} - a \right)_m e^{-\frac{1}{4}z^2} V(a-m, z).$$

## 12.9 Asymptotic Expansions for Large Variable

### 12.9(i) Poincaré-Type Expansions

Throughout this subsection  $\delta$  is an arbitrary small positive constant.

As  $z \rightarrow \infty$

$$12.9.1 \quad U(a, z) \sim e^{-\frac{1}{4}z^2} z^{-a-\frac{1}{2}} \sum_{s=0}^{\infty} (-1)^s \frac{(\frac{1}{2} + a)_{2s}}{s!(2z^2)^s}, \\ |\text{ph } z| \leq \frac{3}{4}\pi - \delta (< \frac{3}{4}\pi),$$

$$12.9.2 \quad V(a, z) \sim \sqrt{\frac{2}{\pi}} e^{\frac{1}{4}z^2} z^{a-\frac{1}{2}} \sum_{s=0}^{\infty} \frac{(\frac{1}{2} - a)_{2s}}{s!(2z^2)^s}, \\ |\text{ph } z| \leq \frac{1}{4}\pi - \delta (< \frac{1}{4}\pi).$$

### 12.9.3

$$U(a, z) \sim e^{-\frac{1}{4}z^2} z^{-a-\frac{1}{2}} \sum_{s=0}^{\infty} (-1)^s \frac{(\frac{1}{2} + a)_{2s}}{s!(2z^2)^s} \\ \pm i \frac{\sqrt{2\pi}}{\Gamma(\frac{1}{2} + a)} e^{\mp i\pi a} e^{\frac{1}{4}z^2} z^{a-\frac{1}{2}} \sum_{s=0}^{\infty} \frac{(\frac{1}{2} - a)_{2s}}{s!(2z^2)^s}, \\ \frac{1}{4}\pi + \delta \leq \pm \text{ph } z \leq \frac{5}{4}\pi - \delta,$$

### 12.9.4

$$V(a, z) \sim \sqrt{\frac{2}{\pi}} e^{\frac{1}{4}z^2} z^{a-\frac{1}{2}} \sum_{s=0}^{\infty} \frac{(\frac{1}{2} - a)_{2s}}{s!(2z^2)^s} \\ \pm \frac{i}{\Gamma(\frac{1}{2} - a)} e^{-\frac{1}{4}z^2} z^{-a-\frac{1}{2}} \sum_{s=0}^{\infty} (-1)^s \frac{(\frac{1}{2} + a)_{2s}}{s!(2z^2)^s}, \\ -\frac{1}{4}\pi + \delta \leq \pm \text{ph } z \leq \frac{3}{4}\pi - \delta.$$

### 12.9(ii) Bounds and Re-Expansions for the Remainder Terms

Bounds and re-expansions for the error term in (12.9.1) can be obtained by use of (12.7.14) and §§13.7(ii), 13.7(iii). Corresponding results for (12.9.2) can be obtained via (12.2.20).

## 12.10 Uniform Asymptotic Expansions for Large Parameter

### 12.10(i) Introduction

In this section we give asymptotic expansions of PCFs for large values of the parameter  $a$  that are uniform with respect to the variable  $z$ , when both  $a$  and  $z (= x)$  are real. These expansions follow from Olver (1959), where detailed information is also given for complex variables.

With the transformations

$$12.10.1 \quad a = \pm \frac{1}{2}\mu^2, \quad x = \mu t\sqrt{2},$$

(12.2.2) becomes

$$12.10.2 \quad \frac{d^2 w}{dt^2} = \mu^4(t^2 \pm 1)w.$$

With the upper sign in (12.10.2), expansions can be constructed for large  $\mu$  in terms of elementary functions that are uniform for  $t \in (-\infty, \infty)$  (§2.8(ii)). With the lower sign there are turning points at  $t = \pm 1$ , which need to be excluded from the regions of validity. These cases are treated in §§12.10(ii)–12.10(vi).

The turning points can be included if expansions in terms of Airy functions are used instead of elementary functions (§2.8(iii)). These cases are treated in §§12.10(vii)–12.10(viii).

Throughout this section the symbol  $\delta$  again denotes an arbitrary small positive constant.

**12.10(ii) Negative  $a$ ,  $2\sqrt{-a} < x < \infty$**

As  $a \rightarrow -\infty$

**12.10.3**  $U\left(-\frac{1}{2}\mu^2, \mu t\sqrt{2}\right) \sim \frac{g(\mu)e^{-\mu^2\xi}}{(t^2-1)^{\frac{1}{4}}} \sum_{s=0}^{\infty} \frac{\mathcal{A}_s(t)}{\mu^{2s}},$

**12.10.4**

$U'\left(-\frac{1}{2}\mu^2, \mu t\sqrt{2}\right) \sim -\frac{\mu}{\sqrt{2}}g(\mu)(t^2-1)^{\frac{1}{4}}e^{-\mu^2\xi} \sum_{s=0}^{\infty} \frac{\mathcal{B}_s(t)}{\mu^{2s}},$

**12.10.5**  $V\left(-\frac{1}{2}\mu^2, \mu t\sqrt{2}\right) \sim \frac{2g(\mu)}{\Gamma\left(\frac{1}{2} + \frac{1}{2}\mu^2\right)} \frac{e^{\mu^2\xi}}{(t^2-1)^{\frac{1}{4}}} \times \sum_{s=0}^{\infty} (-1)^s \frac{\mathcal{A}_s(t)}{\mu^{2s}},$

**12.10.6**  $V'\left(-\frac{1}{2}\mu^2, \mu t\sqrt{2}\right) \sim \frac{\sqrt{2}\mu g(\mu)}{\Gamma\left(\frac{1}{2} + \frac{1}{2}\mu^2\right)} (t^2-1)^{\frac{1}{4}} \times e^{\mu^2\xi} \sum_{s=0}^{\infty} (-1)^s \frac{\mathcal{B}_s(t)}{\mu^{2s}},$

uniformly for  $t \in [1 + \delta, \infty)$ , where

**12.10.7**  $\xi = \frac{1}{2}t\sqrt{t^2-1} - \frac{1}{2}\ln\left(t + \sqrt{t^2-1}\right).$

The coefficients are given by

**12.10.8**  $\mathcal{A}_s(t) = \frac{u_s(t)}{(t^2-1)^{\frac{3}{2}s}}, \quad \mathcal{B}_s(t) = \frac{v_s(t)}{(t^2-1)^{\frac{3}{2}s}},$

where  $u_s(t)$  and  $v_s(t)$  are polynomials in  $t$  of degree  $3s$ , ( $s$  odd),  $3s-2$  ( $s$  even,  $s \geq 2$ ). For  $s = 0, 1, 2$ ,

**12.10.9**  $u_0(t) = 1, \quad u_1(t) = \frac{t(t^2-6)}{24},$   
 $u_2(t) = \frac{-9t^4 + 249t^2 + 145}{1152},$

**12.10.10**  $v_0(t) = 1, \quad v_1(t) = \frac{t(t^2+6)}{24},$   
 $v_2(t) = \frac{15t^4 - 327t^2 - 143}{1152}.$

Higher polynomials  $u_s(t)$  can be calculated from the recurrence relation

**12.10.11**  $(t^2-1)u'_s(t) - 3stu_s(t) = r_{s-1}(t),$

where

**12.10.12**  $8r_s(t) = (3t^2+2)u_s(t) - 12(s+1)tr_{s-1}(t) + 4(t^2-1)r'_{s-1}(t),$

and the  $v_s(t)$  then follow from

**12.10.13**  $v_s(t) = u_s(t) + \frac{1}{2}tu_{s-1}(t) - r_{s-2}(t).$

Lastly, the function  $g(\mu)$  in (12.10.3) and (12.10.4) has the asymptotic expansion:

**12.10.14**  $g(\mu) \sim h(\mu) \left(1 + \frac{1}{2} \sum_{s=1}^{\infty} \frac{\gamma_s}{\left(\frac{1}{2}\mu^2\right)^s}\right),$

where

**12.10.15**  $h(\mu) = 2^{-\frac{1}{4}\mu^2 - \frac{1}{4}} e^{-\frac{1}{4}\mu^2} \mu^{\frac{1}{2}\mu^2 - \frac{1}{2}},$

and the coefficients  $\gamma_s$  are defined by

**12.10.16**  $\Gamma\left(\frac{1}{2} + z\right) \sim \sqrt{2\pi}e^{-z}z^z \sum_{s=0}^{\infty} \frac{\gamma_s}{z^s};$

compare (5.11.8). For  $s \leq 4$

**12.10.17**  $\gamma_0 = 1, \quad \gamma_1 = -\frac{1}{24}, \quad \gamma_2 = \frac{1}{1152},$   
 $\gamma_3 = \frac{1003}{4 \cdot 14720}, \quad \gamma_4 = -\frac{4027}{398 \cdot 13120}.$

**12.10(iii) Negative  $a$ ,  $-\infty < x < -2\sqrt{-a}$**

When  $\mu \rightarrow \infty$ , asymptotic expansions for the functions  $U\left(-\frac{1}{2}\mu^2, -\mu t\sqrt{2}\right)$  and  $V\left(-\frac{1}{2}\mu^2, -\mu t\sqrt{2}\right)$  that are uniform for  $t \in [1 + \delta, \infty)$  are obtainable by substitution into (12.2.15) and (12.2.16) by means of (12.10.3) and (12.10.5). Similarly for  $U'\left(-\frac{1}{2}\mu^2, -\mu t\sqrt{2}\right)$  and  $V'\left(-\frac{1}{2}\mu^2, -\mu t\sqrt{2}\right)$ .

**12.10(iv) Negative  $a$ ,  $-2\sqrt{-a} < x < 2\sqrt{-a}$**

As  $a \rightarrow -\infty$

**12.10.18**  $U\left(-\frac{1}{2}\mu^2, \mu t\sqrt{2}\right) \sim \frac{2g(\mu)}{(1-t^2)^{\frac{1}{4}}} \left(\cos \kappa \sum_{s=0}^{\infty} (-1)^s \frac{\tilde{\mathcal{A}}_{2s}(t)}{\mu^{4s}} - \sin \kappa \sum_{s=0}^{\infty} (-1)^s \frac{\tilde{\mathcal{A}}_{2s+1}(t)}{\mu^{4s+2}}\right),$

**12.10.19**  $U'\left(-\frac{1}{2}\mu^2, \mu t\sqrt{2}\right) \sim \mu\sqrt{2}g(\mu)(1-t^2)^{\frac{1}{4}} \left(\sin \kappa \sum_{s=0}^{\infty} (-1)^s \frac{\tilde{\mathcal{B}}_{2s}(t)}{\mu^{4s}} + \cos \kappa \sum_{s=0}^{\infty} (-1)^s \frac{\tilde{\mathcal{B}}_{2s+1}(t)}{\mu^{4s+2}}\right),$

**12.10.20**  $V\left(-\frac{1}{2}\mu^2, \mu t\sqrt{2}\right) \sim \frac{2g(\mu)}{\Gamma\left(\frac{1}{2} + \frac{1}{2}\mu^2\right)(1-t^2)^{\frac{1}{4}}} \left(\cos \chi \sum_{s=0}^{\infty} (-1)^s \frac{\tilde{\mathcal{A}}_{2s}(t)}{\mu^{4s}} - \sin \chi \sum_{s=0}^{\infty} (-1)^s \frac{\tilde{\mathcal{A}}_{2s+1}(t)}{\mu^{4s+2}}\right),$

**12.10.21**  $V'\left(-\frac{1}{2}\mu^2, \mu t\sqrt{2}\right) \sim \frac{\mu\sqrt{2}g(\mu)(1-t^2)^{\frac{1}{4}}}{\Gamma\left(\frac{1}{2} + \frac{1}{2}\mu^2\right)} \left(\sin \chi \sum_{s=0}^{\infty} (-1)^s \frac{\tilde{\mathcal{B}}_{2s}(t)}{\mu^{4s}} + \cos \chi \sum_{s=0}^{\infty} (-1)^s \frac{\tilde{\mathcal{B}}_{2s+1}(t)}{\mu^{4s+2}}\right),$

uniformly for  $t \in [-1 + \delta, 1 - \delta]$ . The quantities  $\kappa$  and  $\chi$  are defined by

$$12.10.22 \quad \kappa = \mu^2 \eta - \frac{1}{4}\pi, \quad \chi = \mu^2 \eta + \frac{1}{4}\pi,$$

where

$$12.10.23 \quad \eta = \frac{1}{2} \arccos t - \frac{1}{2} t \sqrt{1 - t^2},$$

and the coefficients  $\tilde{A}_s(t)$  and  $\tilde{B}_s(t)$  are given by

$$12.10.24 \quad \tilde{A}_s(t) = \frac{u_s(t)}{(1 - t^2)^{\frac{3}{2}s}}, \quad \tilde{B}_s(t) = \frac{v_s(t)}{(1 - t^2)^{\frac{3}{2}s}};$$

compare (12.10.8).

### 12.10(v) Positive $a$ , $-\infty < x < \infty$

As  $a \rightarrow \infty$

12.10.25

$$U\left(\frac{1}{2}\mu^2, \mu t \sqrt{2}\right) \sim \frac{\bar{g}(\mu) e^{-\mu^2 \bar{\xi}}}{(t^2 + 1)^{\frac{1}{4}}} \sum_{s=0}^{\infty} \frac{\bar{u}_s(t)}{(t^2 + 1)^{\frac{3}{2}s}} \frac{1}{\mu^{2s}},$$

uniformly for  $t \in \mathbb{R}$ . Here bars do not denote complex conjugates; instead

$$12.10.26 \quad \bar{\xi} = \frac{1}{2} t \sqrt{t^2 + 1} + \frac{1}{2} \ln\left(t + \sqrt{t^2 + 1}\right),$$

$$12.10.27 \quad \bar{u}_s(t) = i^s u_s(-it),$$

and the function  $\bar{g}(\mu)$  has the asymptotic expansion

$$12.10.28 \quad \bar{g}(\mu) \sim \frac{1}{\mu \sqrt{2} h(\mu)} \left(1 + \frac{1}{2} \sum_{s=1}^{\infty} (-1)^s \frac{\gamma_s}{\left(\frac{1}{2}\mu^2\right)^s}\right),$$

where  $h(\mu)$  and  $\gamma_s$  are as in §12.10(ii).

With the same conditions

12.10.29

$$U'\left(\frac{1}{2}\mu^2, \mu t \sqrt{2}\right) \sim -\frac{\mu}{\sqrt{2}} \bar{g}(\mu) (t^2 + 1)^{\frac{1}{4}} e^{-\mu^2 \bar{\xi}} \sum_{s=0}^{\infty} \frac{\bar{v}_s(t)}{(t^2 + 1)^{\frac{3}{2}s}} \frac{1}{\mu^{2s}},$$

where

$$12.10.30 \quad \bar{v}_s(t) = i^s v_s(-it).$$

### 12.10(vi) Modifications of Expansions in Elementary Functions

In Temme (2000) modifications are given of Olver's expansions. An example is the following modification of (12.10.3)

$$12.10.31 \quad U\left(-\frac{1}{2}\mu^2, \mu t \sqrt{2}\right) \sim \frac{h(\mu) e^{-\mu^2 \xi}}{(t^2 - 1)^{\frac{1}{4}}} \sum_{s=0}^{\infty} \frac{A_s(\tau)}{\mu^{2s}},$$

where  $\xi$  and  $h(\mu)$  are as in (12.10.7) and (12.10.15),

$$12.10.32 \quad \tau = \frac{1}{2} \left( \frac{t}{\sqrt{t^2 - 1}} - 1 \right),$$

and the coefficients  $A_s(\tau)$  are the product of  $\tau^s$  and a polynomial in  $\tau$  of degree  $2s$ . They satisfy the recursion

$$12.10.33 \quad \begin{aligned} A_{s+1}(\tau) &= -4\tau^2(\tau + 1)^2 \frac{d}{d\tau} A_s(\tau) \\ &\quad - \frac{1}{4} \int_0^\tau (20u^2 + 20u + 3) A_s(u) du, \end{aligned} \quad s = 0, 1, 2, \dots,$$

starting with  $A_0(\tau) = 1$ . Explicitly,

$$12.10.34 \quad \begin{aligned} A_1(\tau) &= -\frac{1}{12} \tau (20\tau^2 + 30\tau + 9), \\ A_2(\tau) &= \frac{1}{288} \tau^2 (6160\tau^4 + 18480\tau^3 + 19404\tau^2 \\ &\quad + 8028\tau + 945). \end{aligned}$$

The modified expansion (12.10.31) shares the property of (12.10.3) that it applies when  $\mu \rightarrow \infty$  uniformly with respect to  $t \in [1 + \delta, \infty)$ . In addition, it enjoys a double asymptotic property: it holds if either or both  $\mu$  and  $t$  tend to infinity. Observe that if  $t \rightarrow \infty$ , then  $A_s(\tau) = O(t^{-2s})$ , whereas  $\mathcal{A}_s(t) = O(1)$  or  $O(t^{-2})$  according as  $s$  is even or odd. The proof of the double asymptotic property then follows with the aid of error bounds; compare §10.41(iv).

For additional information see Temme (2000). See also Olver (1997b, pp. 206–208) and Jones (2006).

### 12.10(vii) Negative $a$ , $-2\sqrt{-a} < x < \infty$ . Expansions in Terms of Airy Functions

The following expansions hold for large positive real values of  $\mu$ , uniformly for  $t \in [-1 + \delta, \infty)$ . (For complex values of  $\mu$  and  $t$  see Olver (1959).)

$$12.10.35 \quad U\left(-\frac{1}{2}\mu^2, \mu t \sqrt{2}\right) \sim 2\pi^{\frac{1}{2}} \mu^{\frac{1}{3}} g(\mu) \phi(\zeta) \left( \text{Ai}\left(\mu^{\frac{4}{3}} \zeta\right) \sum_{s=0}^{\infty} \frac{A_s(\zeta)}{\mu^{4s}} + \frac{\text{Ai}'\left(\mu^{\frac{4}{3}} \zeta\right)}{\mu^{\frac{8}{3}}} \sum_{s=0}^{\infty} \frac{B_s(\zeta)}{\mu^{4s}} \right),$$

$$12.10.36 \quad U'\left(-\frac{1}{2}\mu^2, \mu t \sqrt{2}\right) \sim \frac{(2\pi)^{\frac{1}{2}} \mu^{\frac{2}{3}} g(\mu)}{\phi(\zeta)} \left( \frac{\text{Ai}\left(\mu^{\frac{4}{3}} \zeta\right)}{\mu^{\frac{4}{3}}} \sum_{s=0}^{\infty} \frac{C_s(\zeta)}{\mu^{4s}} + \text{Ai}'\left(\mu^{\frac{4}{3}} \zeta\right) \sum_{s=0}^{\infty} \frac{D_s(\zeta)}{\mu^{4s}} \right),$$



$$12.10.37 \quad V\left(-\frac{1}{2}\mu^2, \mu t\sqrt{2}\right) \sim \frac{2\pi^{\frac{1}{2}}\mu^{\frac{1}{3}}g(\mu)\phi(\zeta)}{\Gamma\left(\frac{1}{2} + \frac{1}{2}\mu^2\right)} \left( \text{Bi}\left(\mu^{\frac{4}{3}}\zeta\right) \sum_{s=0}^{\infty} \frac{A_s(\zeta)}{\mu^{4s}} + \frac{\text{Bi}'\left(\mu^{\frac{4}{3}}\zeta\right)}{\mu^{\frac{8}{3}}} \sum_{s=0}^{\infty} \frac{B_s(\zeta)}{\mu^{4s}} \right),$$

$$12.10.38 \quad V'\left(-\frac{1}{2}\mu^2, \mu t\sqrt{2}\right) \sim \frac{(2\pi)^{\frac{1}{2}}\mu^{\frac{2}{3}}g(\mu)}{\phi(\zeta)\Gamma\left(\frac{1}{2} + \frac{1}{2}\mu^2\right)} \left( \frac{\text{Bi}\left(\mu^{\frac{4}{3}}\zeta\right)}{\mu^{\frac{4}{3}}} \sum_{s=0}^{\infty} \frac{C_s(\zeta)}{\mu^{4s}} + \text{Bi}'\left(\mu^{\frac{4}{3}}\zeta\right) \sum_{s=0}^{\infty} \frac{D_s(\zeta)}{\mu^{4s}} \right).$$

The variable  $\zeta$  is defined by

$$12.10.39 \quad \begin{aligned} \frac{2}{3}\zeta^{\frac{3}{2}} &= \xi, & 1 \leq t, (\zeta \geq 0); \\ \frac{2}{3}(-\zeta)^{\frac{3}{2}} &= \eta, & -1 < t \leq 1, (\zeta \leq 0), \end{aligned}$$

where  $\xi, \eta$  are given by (12.10.7), (12.10.23), respectively, and

$$12.10.40 \quad \phi(\zeta) = \left( \frac{\zeta}{t^2 - 1} \right)^{\frac{1}{4}}.$$

The function  $\zeta = \zeta(t)$  is real for  $t > -1$  and analytic at  $t = 1$ . Inversely, with  $w = 2^{-\frac{1}{3}}\zeta$ ,

$$12.10.41 \quad \begin{aligned} t &= 1 + w - \frac{1}{10}w^2 + \frac{11}{350}w^3 - \frac{823}{63000}w^4 \\ &+ \frac{1}{242} \frac{50653}{55000}w^5 + \dots, \quad |\zeta| < \left(\frac{3}{4}\pi\right)^{\frac{2}{3}}. \end{aligned}$$

For  $g(\mu)$  see (12.10.14). The coefficients  $A_s(\zeta)$  and  $B_s(\zeta)$  are given by

$$12.10.42 \quad A_s(\zeta) = \zeta^{-3s} \sum_{m=0}^{2s} \beta_m(\phi(\zeta))^{6(2s-m)} u_{2s-m}(t),$$

$$\zeta^2 B_s(\zeta) = -\zeta^{-3s} \sum_{m=0}^{2s+1} \alpha_m(\phi(\zeta))^{6(2s-m+1)} u_{2s-m+1}(t),$$

where  $\phi(\zeta)$  is as in (12.10.40),  $u_k(t)$  is as in §12.10(ii),  $\alpha_0 = 1$ , and

$$12.10.43 \quad \alpha_m = \frac{(2m+1)(2m+3)\cdots(6m-1)}{m!(144)^m},$$

$$\beta_m = -\frac{6m+1}{6m-1}\alpha_m.$$

The coefficients  $C_s(\zeta)$  and  $D_s(\zeta)$  in (12.10.36) and (12.10.38) are given by

$$12.10.44 \quad \begin{aligned} C_s(\zeta) &= \chi(\zeta)A_s(\zeta) + A'_s(\zeta) + \zeta B_s(\zeta), \\ D_s(\zeta) &= A_s(\zeta) + \chi(\zeta)B_{s-1}(\zeta) + B'_{s-1}(\zeta), \end{aligned}$$

where

$$12.10.45 \quad \chi(\zeta) = \frac{\phi'(\zeta)}{\phi(\zeta)} = \frac{1 - 2t(\phi(\zeta))^6}{4\zeta}.$$

Explicitly,

$$12.10.46 \quad \zeta C_s(\zeta) = -\zeta^{-3s} \sum_{m=0}^{2s+1} \beta_m(\phi(\zeta))^{6(2s-m+1)} v_{2s-m+1}(t),$$

$$D_s(\zeta) = \zeta^{-3s} \sum_{m=0}^{2s} \alpha_m(\phi(\zeta))^{6(2s-m)} v_{2s-m}(t),$$

where  $v_k(t)$  is as in §12.10(ii).

**Modified Expansions**

The expansions (12.10.35)–(12.10.38) can be modified, again see Temme (2000), and the new expansions hold if either or both  $\mu$  and  $t$  tend to infinity. This is provable by the methods used in §10.41(v).

**12.10(viii) Negative  $a$ ,  $-\infty < x < 2\sqrt{-a}$ .  
Expansions in Terms of Airy Functions**

When  $\mu \rightarrow \infty$ , asymptotic expansions for  $U(-\frac{1}{2}\mu^2, -\mu t\sqrt{2})$  and  $V(-\frac{1}{2}\mu^2, -\mu t\sqrt{2})$  that are uniform for  $t \in [-1 + \delta, \infty)$  are obtained by substitution into (12.2.15) and (12.2.16) by means of (12.10.35) and (12.10.37). Similarly for  $U'(-\frac{1}{2}\mu^2, -\mu t\sqrt{2})$  and  $V'(-\frac{1}{2}\mu^2, -\mu t\sqrt{2})$ .

**12.11 Zeros**

**12.11(i) Distribution of Real Zeros**

If  $a \geq -\frac{1}{2}$ , then  $U(a, x)$  has no real zeros. If  $-\frac{3}{2} < a < -\frac{1}{2}$ , then  $U(a, x)$  has no positive real zeros. If  $-2n - \frac{3}{2} < a < -2n + \frac{1}{2}$ ,  $n = 1, 2, \dots$ , then  $U(a, x)$  has  $n$  positive real zeros. Lastly, when  $a = -n - \frac{1}{2}$ ,  $n = 1, 2, \dots$  (Hermite polynomial case)  $U(a, x)$  has  $n$  zeros and they lie in the interval  $[-2\sqrt{-a}, 2\sqrt{-a}]$ . For further information on these cases see Dean (1966).

If  $a > -\frac{1}{2}$ , then  $V(a, x)$  has no positive real zeros, and if  $a = \frac{3}{2} - 2n$ ,  $n \in \mathbb{Z}$ , then  $V(a, x)$  has a zero at  $x = 0$ .

**12.11(ii) Asymptotic Expansions of Large Zeros**

When  $a > -\frac{1}{2}$ ,  $U(a, z)$  has a string of complex zeros that approaches the ray  $\text{ph } z = \frac{3}{4}\pi$  as  $z \rightarrow \infty$ , and a conjugate string. When  $a > -\frac{1}{2}$  the zeros are asymptotically given by  $z_{a,s}$  and  $\bar{z}_{a,s}$ , where  $s$  is a large positive integer and

$$12.11.1 \quad z_{a,s} = e^{\frac{3}{4}\pi i} \sqrt{2\tau_s} \left( 1 - \frac{ia\lambda_s}{2\tau_s} + \frac{2a^2\lambda_s^2 - 8a^2\lambda_s + 4a^2 + 3}{16\tau_s^2} + O(\lambda_s^3\tau_s^{-3}) \right),$$

with

$$12.11.2 \quad \tau_s = (2s + \frac{1}{2} - a)\pi + i \ln\left(\pi^{-\frac{1}{2}} 2^{-a-\frac{1}{2}} \Gamma\left(\frac{1}{2} + a\right)\right),$$

and

**12.11.3** 
$$\lambda_s = \ln \tau_s - \frac{1}{2}\pi i.$$

When  $a = \frac{1}{2}$  these zeros are the same as the zeros of the complementary error function  $\operatorname{erfc}(z/\sqrt{2})$ ; compare (12.7.5). Numerical calculations in this case show that  $z_{\frac{1}{2},s}$  corresponds to the  $s$ th zero on the string; compare §7.13(ii).

**12.11(iii) Asymptotic Expansions for Large Parameter**

For large negative values of  $a$  the real zeros of  $U(a, x)$ ,  $U'(a, x)$ ,  $V(a, x)$ , and  $V'(a, x)$  can be approximated by reversion of the Airy-type asymptotic expansions of §§12.10(vii) and 12.10(viii). For example, let the  $s$ th real zero of  $U(a, x)$  and  $U'(a, x)$ , counted in descending order away from the point  $z = 2\sqrt{-a}$ , be denoted by  $u_{a,s}$  and  $u'_{a,s}$ , respectively. Then

**12.11.4** 
$$u_{a,s} \sim 2^{\frac{1}{2}}\mu \left( p_0(\alpha) + \frac{p_1(\alpha)}{\mu^4} + \frac{p_2(\alpha)}{\mu^8} + \dots \right),$$

as  $\mu (= \sqrt{-2a}) \rightarrow \infty$ ,  $s$  fixed. Here  $\alpha = \mu^{-\frac{4}{3}}a_s$ ,  $a_s$  denoting the  $s$ th negative zero of the function  $\operatorname{Ai}$  (see §9.9(i)). The first two coefficients are given by

**12.11.5** 
$$p_0(\zeta) = t(\zeta),$$

where  $t(\zeta)$  is the function inverse to  $\zeta(t)$ , defined by (12.10.39) (see also (12.10.41)), and

**12.11.6** 
$$p_1(\zeta) = \frac{t^3 - 6t}{24(t^2 - 1)^2} + \frac{5}{48((t^2 - 1)\zeta^3)^{\frac{1}{2}}}.$$

Similarly, for the zeros of  $U'(a, x)$  we have

**12.11.7** 
$$u'_{a,s} \sim 2^{\frac{1}{2}}\mu \left( q_0(\beta) + \frac{q_1(\beta)}{\mu^4} + \frac{q_2(\beta)}{\mu^8} + \dots \right),$$

where  $\beta = \mu^{-\frac{4}{3}}a'_s$ ,  $a'_s$  denoting the  $s$ th negative zero of the function  $\operatorname{Ai}'$  and

**12.11.8** 
$$q_0(\zeta) = t(\zeta).$$

For the first zero of  $U(a, x)$  we also have

**12.11.9** 
$$u_{a,1} \sim 2^{\frac{1}{2}}\mu \left( 1 - 1.85575\ 708\mu^{-4/3} - 0.34438\ 34\mu^{-8/3} - 0.16871\ 5\mu^{-4} - 0.11414\mu^{-16/3} - 0.0808\mu^{-20/3} - \dots \right),$$

where the numerical coefficients have been rounded off.

For further information, including associated functions, see Olver (1959).

**12.12 Integrals**

**12.12.1** 
$$\int_0^\infty e^{-\frac{1}{4}t^2} t^{\mu-1} U(a, t) dt = \frac{\sqrt{\pi} 2^{-\frac{1}{2}(\mu+a+\frac{1}{2})} \Gamma(\mu)}{\Gamma(\frac{1}{2}(\mu+a+\frac{3}{2}))}, \quad \Re\mu > 0,$$

**12.12.2** 
$$\int_0^\infty e^{-\frac{3}{4}t^2} t^{-a-\frac{3}{2}} U(a, t) dt = 2^{\frac{1}{4}+\frac{1}{2}a} \Gamma(-a-\frac{1}{2}) \cos((\frac{1}{4}a+\frac{1}{8})\pi), \quad \Re a < -\frac{1}{2},$$

**12.12.3** 
$$\int_0^\infty e^{-\frac{1}{4}t^2} t^{-a-\frac{1}{2}} (x^2+t^2)^{-1} U(a, t) dt = \sqrt{\pi/2} \Gamma(\frac{1}{2}-a) x^{-a-\frac{3}{2}} e^{\frac{1}{4}x^2} U(-a, x), \quad \Re a < \frac{1}{2}, x > 0.$$

**Nicholson-type Integral**

**12.12.4** 
$$(U(a, z))^2 + (\overline{U}(a, z))^2 = \frac{2^{\frac{3}{2}}}{\pi} \Gamma(\frac{1}{2}-a) \int_0^\infty \frac{e^{2at+\frac{1}{2}z^2 \tanh t}}{\sqrt{\sinh(2t)}} dt, \quad \Re a < \frac{1}{2}.$$

When  $z (= x)$  is real the left-hand side equals  $(F(a, x))^2$ ; compare (12.2.22).

For further integrals see §§13.10, 13.23, and use (12.7.14).

For compendia of integrals see Erdélyi *et al.* (1953b, v. 2, pp. 121–122), Erdélyi *et al.* (1954a,b, v. 1, pp. 60–61, 115, 210–211, and 336; v. 2, pp. 76–80, 115, 151, 171, and 395–398), Gradshteyn and Ryzhik (2000, §7.7), Magnus *et al.* (1966, pp. 330–331), Marichev (1983, pp. 190–191), Oberhettinger (1974, pp. 144–145), Oberhettinger (1990, pp. 106–108 and 192), Oberhettinger and Badii (1973, pp. 181–185), Prudnikov *et al.* (1986b, pp. 36–37, 155–168, 243–246, 289–290, 327–328, 419–420, and 619), Prudnikov *et al.* (1992a, §3.11), and Prudnikov *et al.* (1992b, §3.11).

See also Barr (1968) and Lowdon (1970).

**12.13 Sums**

**12.13(i) Addition Theorems**

**12.13.1** 
$$U(a, x+y) = e^{\frac{1}{2}xy+\frac{1}{4}y^2} \sum_{m=0}^\infty \frac{(-y)^m}{m!} U(a-m, x),$$

**12.13.2** 
$$U(a, x+y) = e^{-\frac{1}{2}xy-\frac{1}{4}y^2} \sum_{m=0}^\infty \binom{-a-\frac{1}{2}}{m} y^m U(a+m, x),$$

**12.13.3** 
$$V(a, x+y) = e^{\frac{1}{2}xy+\frac{1}{4}y^2} \sum_{m=0}^\infty \binom{a-\frac{1}{2}}{m} y^m V(a-m, x),$$

**12.13.4** 
$$V(a, x+y) = e^{-\frac{1}{2}xy-\frac{1}{4}y^2} \sum_{m=0}^\infty \frac{y^m}{m!} V(a+m, x).$$

**12.13.5**

$$\begin{aligned}
 &U(a, x \cos t + y \sin t) \\
 &= e^{\frac{1}{4}(x \sin t - y \cos t)^2} \\
 &\quad \times \sum_{m=0}^{\infty} \binom{-a - \frac{1}{2}}{m} (\tan t)^m U(m + a, x) U(-m - \frac{1}{2}, y), \\
 &\qquad \qquad \qquad \Re a \leq -\frac{1}{2}, 0 \leq t \leq \frac{1}{4}\pi.
 \end{aligned}$$

**12.13.6**

$$\begin{aligned}
 n! U(n + \frac{1}{2}, z) &= i^n e^{-\frac{1}{2}z^2} \operatorname{erfc}(z/\sqrt{2}) U(-n - \frac{1}{2}, iz) \\
 &\quad + \sum_{m=1}^{\lfloor \frac{1}{2}n + \frac{1}{2} \rfloor} U(2m - n - \frac{1}{2}, z), \\
 &\qquad \qquad \qquad n = 0, 1, 2, \dots
 \end{aligned}$$

For  $\operatorname{erfc}$  see §7.2(i).

**12.13(ii) Other Series**

For other series see Dhar (1940), Hansen (1975, pp. 421–422), Hillion (1997), Miller (1974), Prudnikov *et al.* (1986b, p. 651), Shanker (1940b,a,c), and Varma (1941).

**12.14 The Function  $W(a, x)$**

**12.14(i) Introduction**

In this section solutions of equation (12.2.3) are considered. This equation is important when  $a$  and  $z (= x)$  are real, and we shall assume this to be the case. In other cases the general theory of (12.2.2) is available.  $W(a, x)$  and  $W(a, -x)$  form a numerically satisfactory pair of solutions when  $-\infty < x < \infty$ .

**12.14(ii) Values at  $z = 0$  and Wronskian**

**12.14.1** 
$$W(a, 0) = 2^{-\frac{3}{4}} \left| \frac{\Gamma(\frac{1}{4} + \frac{1}{2}ia)}{\Gamma(\frac{3}{4} + \frac{1}{2}ia)} \right|^{\frac{1}{2}},$$

**12.14.2** 
$$W'(a, 0) = -2^{-\frac{1}{4}} \left| \frac{\Gamma(\frac{3}{4} + \frac{1}{2}ia)}{\Gamma(\frac{1}{4} + \frac{1}{2}ia)} \right|^{\frac{1}{2}}.$$

**12.14.3** 
$$\mathscr{W} \{W(a, x), W(a, -x)\} = 1.$$

**12.14(iii) Graphs**

For the modulus functions  $\tilde{F}(a, x)$  and  $\tilde{G}(a, x)$  see §12.14(x).

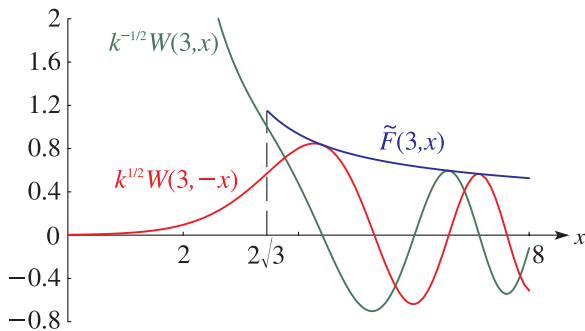


Figure 12.14.1:  $k^{-1/2} W(3, x)$ ,  $k^{1/2} W(3, -x)$ ,  $\tilde{F}(3, x)$ ,  $0 \leq x \leq 8$ .

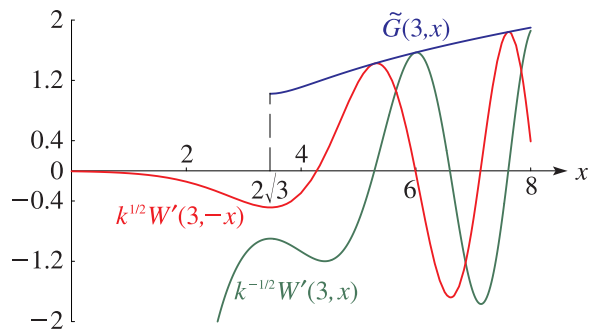


Figure 12.14.2:  $k^{-1/2} W'(3, x)$ ,  $k^{1/2} W'(3, -x)$ ,  $\tilde{G}(3, x)$ ,  $0 \leq x \leq 8$ .

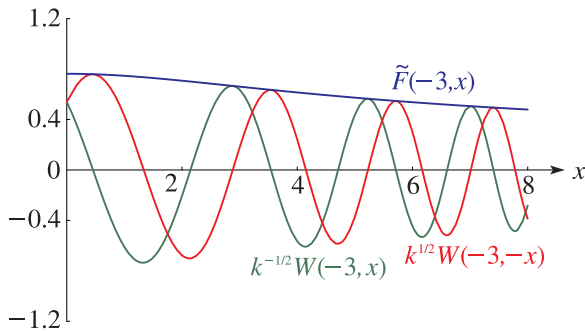


Figure 12.14.3:  $k^{-1/2} W(-3, x)$ ,  $k^{1/2} W(-3, -x)$ ,  $\tilde{F}(-3, x)$ ,  $0 \leq x \leq 8$ .

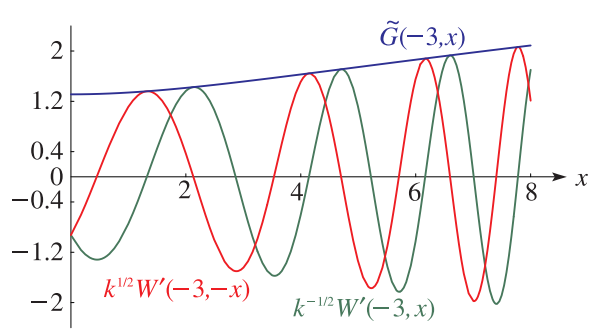


Figure 12.14.4:  $k^{-1/2} W'(-3, x)$ ,  $k^{1/2} W'(-3, -x)$ ,  $\tilde{G}(-3, x)$ ,  $0 \leq x \leq 8$ .

**12.14(iv) Connection Formula**

$$12.14.4 \quad W(a, x) = \sqrt{k/2} e^{\frac{1}{4}\pi a} \left( e^{i\rho} U\left(ia, xe^{-\pi i/4}\right) + e^{-i\rho} U\left(-ia, xe^{\pi i/4}\right) \right),$$

where

$$12.14.5 \quad k = \sqrt{1 + e^{2\pi a}} - e^{\pi a}, \quad 1/k = \sqrt{1 + e^{2\pi a}} + e^{\pi a},$$

$$12.14.6 \quad \rho = \frac{1}{8}\pi + \frac{1}{2}\phi_2,$$

$$12.14.7 \quad \phi_2 = \text{ph} \Gamma\left(\frac{1}{2} + ia\right),$$

the branch of  $\text{ph}$  being zero when  $a = 0$  and defined by continuity elsewhere.

**12.14(v) Power-Series Expansions**

$$12.14.8 \quad W(a, x) = W(a, 0)w_1(a, x) + W'(a, 0)w_2(a, x).$$

Here  $w_1(a, x)$  and  $w_2(a, x)$  are the even and odd solutions of (12.2.3):

$$12.14.9 \quad w_1(a, x) = \sum_{n=0}^{\infty} \alpha_n(a) \frac{x^{2n}}{(2n)!},$$

$$12.14.10 \quad w_2(a, x) = \sum_{n=0}^{\infty} \beta_n(a) \frac{x^{2n+1}}{(2n+1)!},$$

where  $\alpha_n(a)$  and  $\beta_n(a)$  satisfy the recursion relations

$$12.14.11 \quad \begin{aligned} \alpha_{n+2} &= a\alpha_{n+1} - \frac{1}{2}(n+1)(2n+1)\alpha_n, \\ \beta_{n+2} &= a\beta_{n+1} - \frac{1}{2}(n+1)(2n+3)\beta_n, \end{aligned}$$

with

$$12.14.12 \quad \alpha_0(a) = 1, \quad \alpha_1(a) = a, \quad \beta_0(a) = 1, \quad \beta_1(a) = a.$$

Other expansions, involving  $\cos(\frac{1}{4}x^2)$  and  $\sin(\frac{1}{4}x^2)$ , can be obtained from (12.4.3) to (12.4.6) by replacing  $a$  by  $-ia$  and  $z$  by  $xe^{\pi i/4}$ ; see Miller (1955, p. 80), and also (12.14.15) and (12.14.16).

**12.14(vi) Integral Representations**

These follow from the contour integrals of §12.5(ii), which are valid for general complex values of the argument  $z$  and parameter  $a$ . See Miller (1955, p. 26).

**12.14(vii) Relations to Other Functions****Bessel Functions**

For the notation see §10.2(ii). When  $x > 0$

$$12.14.13 \quad W(0, \pm x) = 2^{-\frac{5}{4}} \sqrt{\pi x} \left( J_{-\frac{1}{4}}\left(\frac{1}{4}x^2\right) \mp J_{\frac{1}{4}}\left(\frac{1}{4}x^2\right) \right),$$

$$12.14.14 \quad \frac{d}{dx} W(0, \pm x) = -2^{-\frac{9}{4}} x \sqrt{\pi x} \left( J_{\frac{3}{4}}\left(\frac{1}{4}x^2\right) \pm J_{-\frac{3}{4}}\left(\frac{1}{4}x^2\right) \right).$$

**Confluent Hypergeometric Functions**

For the notation see §13.2(i).

The even and odd solutions of (12.2.3) (see §12.14(v)) are given by

$$12.14.15 \quad \begin{aligned} w_1(a, x) &= e^{-\frac{1}{4}ix^2} M\left(\frac{1}{4} - \frac{1}{2}ia, \frac{1}{2}, \frac{1}{2}ix^2\right) \\ &= e^{\frac{1}{4}ix^2} M\left(\frac{1}{4} + \frac{1}{2}ia, \frac{1}{2}, -\frac{1}{2}ix^2\right), \end{aligned}$$

$$12.14.16 \quad \begin{aligned} w_2(a, x) &= xe^{-\frac{1}{4}ix^2} M\left(\frac{3}{4} - \frac{1}{2}ia, \frac{3}{2}, \frac{1}{2}ix^2\right) \\ &= xe^{\frac{1}{4}ix^2} M\left(\frac{3}{4} + \frac{1}{2}ia, \frac{3}{2}, -\frac{1}{2}ix^2\right). \end{aligned}$$

**12.14(viii) Asymptotic Expansions for Large Variable**

Write

$$12.14.17 \quad W(a, x) = \sqrt{\frac{2k}{x}} (s_1(a, x) \cos \omega - s_2(a, x) \sin \omega),$$

12.14.18

$$W(a, -x) = \sqrt{\frac{2}{kx}} (s_1(a, x) \sin \omega + s_2(a, x) \cos \omega),$$

where

$$12.14.19 \quad \omega = \frac{1}{4}x^2 - a \ln x + \frac{1}{4}\pi + \frac{1}{2}\phi_2,$$

with  $\phi_2$  given by (12.14.7). Then as  $x \rightarrow \infty$

12.14.20

$$s_1(a, x) \sim 1 + \frac{d_2}{1!2x^2} - \frac{c_4}{2!2^2x^4} - \frac{d_6}{3!2^3x^6} + \frac{c_8}{4!2^4x^8} + \dots,$$

12.14.21

$$s_2(a, x) \sim -\frac{c_2}{1!2x^2} - \frac{d_4}{2!2^2x^4} + \frac{c_6}{3!2^3x^6} + \frac{d_8}{4!2^4x^8} - \dots.$$

The coefficients  $c_{2r}$  and  $d_{2r}$  are obtainable by equating real and imaginary parts in

$$12.14.22 \quad c_{2r} + id_{2r} = \frac{\Gamma(2r + \frac{1}{2} + ia)}{\Gamma(\frac{1}{2} + ia)}.$$

Equivalently,

$$12.14.23 \quad s_1(a, x) + is_2(a, x) \sim \sum_{r=0}^{\infty} (-i)^r \frac{(\frac{1}{2} + ia)_{2r}}{2^r r! x^{2r}}.$$

**12.14(ix) Uniform Asymptotic Expansions for Large Parameter**

The differential equation

$$12.14.24 \quad \frac{d^2 w}{dt^2} = \mu^4(1 - t^2)w$$

follows from (12.2.3), and has solutions  $W(\frac{1}{2}\mu^2, \pm\mu t\sqrt{2})$ . For real  $\mu$  and  $t$  oscillations occur outside the  $t$ -interval  $[-1, 1]$ . Airy-type uniform asymptotic expansions can be used to include either one of the turning points  $\pm 1$ . In the following expansions, obtained from Olver (1959),  $\mu$  is large and positive, and  $\delta$  is again an arbitrary small positive constant.

**Positive  $a$ ,  $2\sqrt{a} < x < \infty$**

$$12.14.25 \quad W\left(\frac{1}{2}\mu^2, \mu t\sqrt{2}\right) \sim \frac{2^{-\frac{1}{2}}e^{-\frac{1}{4}\pi\mu^2}l(\mu)}{(t^2-1)^{\frac{1}{4}}} \left( \cos\sigma \sum_{s=0}^{\infty} (-1)^s \frac{\mathcal{A}_{2s}(t)}{\mu^{4s}} - \sin\sigma \sum_{s=0}^{\infty} (-1)^s \frac{\mathcal{A}_{2s+1}(t)}{\mu^{4s+2}} \right),$$

**12.14.26**

$$W\left(\frac{1}{2}\mu^2, -\mu t\sqrt{2}\right) \sim \frac{2^{\frac{1}{2}}e^{\frac{1}{4}\pi\mu^2}l(\mu)}{(t^2-1)^{\frac{1}{4}}} \left( \sin\sigma \sum_{s=0}^{\infty} (-1)^s \frac{\mathcal{A}_{2s}(t)}{\mu^{4s}} + \cos\sigma \sum_{s=0}^{\infty} (-1)^s \frac{\mathcal{A}_{2s+1}(t)}{\mu^{4s+2}} \right),$$

uniformly for  $t \in [1 + \delta, \infty)$ . Here  $\mathcal{A}_s(t)$  is as in §12.10(ii),  $\sigma$  is defined by

$$12.14.27 \quad \sigma = \mu^2\xi + \frac{1}{4}\pi,$$

with  $\xi$  given by (12.10.7), and

$$12.14.28 \quad l(\mu) = \sqrt{2}e^{\frac{1}{8}\pi\mu^2}e^{i(\frac{1}{2}\phi_2 - \frac{1}{8}\pi)}g(\mu e^{-\frac{1}{4}\pi i}),$$

with  $g(\mu)$  as in §12.10(ii). The function  $l(\mu)$  has the asymptotic expansion

$$12.14.29 \quad l(\mu) \sim \frac{2^{\frac{1}{4}}}{\mu^{\frac{1}{2}}} \sum_{s=0}^{\infty} \frac{l_s}{\mu^{4s}},$$

with

$$12.14.30 \quad l_0 = 1, \quad l_1 = -\frac{1}{1152}, \quad l_2 = -\frac{16123}{398\,13120}.$$

**Positive  $a$ ,  $-2\sqrt{a} < x < 2\sqrt{a}$**

**12.14.31**

$$W\left(\frac{1}{2}\mu^2, \mu t\sqrt{2}\right) \sim \frac{l(\mu)e^{\mu^2\eta}}{2^{\frac{1}{2}}e^{\frac{1}{4}\pi\mu^2}(1-t^2)^{\frac{1}{4}}} \sum_{s=0}^{\infty} (-1)^s \frac{\tilde{\mathcal{A}}_s(t)}{\mu^{2s}},$$

uniformly for  $t \in [-1 + \delta, 1 - \delta]$ , with  $\eta$  given by (12.10.23) and  $\tilde{\mathcal{A}}_s(t)$  given by (12.10.24).

The expansions for the derivatives corresponding to (12.14.25), (12.14.26), and (12.14.31) may be obtained by formal term-by-term differentiation with respect to  $t$ ; compare the analogous results in §§12.10(ii)–12.10(v).

**Airy-type Uniform Expansions**

$$12.14.32 \quad W\left(\frac{1}{2}\mu^2, \mu t\sqrt{2}\right) \sim \frac{\pi^{\frac{1}{2}}\mu^{\frac{1}{3}}l(\mu)}{2^{\frac{1}{2}}e^{\frac{1}{4}\pi\mu^2}}\phi(\zeta) \left( \text{Bi}\left(-\mu^{\frac{4}{3}}\zeta\right) \sum_{s=0}^{\infty} (-1)^s \frac{A_s(\zeta)}{\mu^{4s}} + \frac{\text{Bi}'\left(-\mu^{\frac{4}{3}}\zeta\right)}{\mu^{\frac{8}{3}}} \sum_{s=0}^{\infty} (-1)^s \frac{B_s(\zeta)}{\mu^{4s}} \right),$$

$$12.14.33 \quad W\left(\frac{1}{2}\mu^2, -\mu t\sqrt{2}\right) \sim \frac{\pi^{\frac{1}{2}}\mu^{\frac{1}{3}}l(\mu)}{2^{-\frac{1}{2}}e^{-\frac{1}{4}\pi\mu^2}}\phi(\zeta) \left( \text{Ai}\left(-\mu^{\frac{4}{3}}\zeta\right) \sum_{s=0}^{\infty} (-1)^s \frac{A_s(\zeta)}{\mu^{4s}} + \frac{\text{Ai}'\left(-\mu^{\frac{4}{3}}\zeta\right)}{\mu^{\frac{8}{3}}} \sum_{s=0}^{\infty} (-1)^s \frac{B_s(\zeta)}{\mu^{4s}} \right),$$

uniformly for  $t \in [-1 + \delta, \infty)$ , with  $\zeta$ ,  $\phi(\zeta)$ ,  $A_s(\zeta)$ , and  $B_s(\zeta)$  as in §12.10(vii). For the corresponding expansions for the derivatives see Olver (1959).

**Negative  $a$ ,  $-\infty < x < \infty$**

In this case there are no real turning points, and the solutions of (12.2.3), with  $z$  replaced by  $x$ , oscillate on the entire real  $x$ -axis.

$$12.14.34 \quad W\left(-\frac{1}{2}\mu^2, \mu t\sqrt{2}\right) \sim \frac{l(\mu)}{(t^2+1)^{\frac{1}{4}}} \left( \cos\bar{\sigma} \sum_{s=0}^{\infty} \frac{(-1)^s\bar{u}_{2s}(t)}{(t^2+1)^{3s}\mu^{4s}} - \sin\bar{\sigma} \sum_{s=0}^{\infty} \frac{(-1)^s\bar{u}_{2s+1}(t)}{(t^2+1)^{3s+\frac{3}{2}}\mu^{4s+2}} \right),$$

$$12.14.35 \quad W'\left(-\frac{1}{2}\mu^2, \mu t\sqrt{2}\right) \sim -\frac{\mu}{\sqrt{2}}l(\mu)(t^2+1)^{\frac{1}{4}} \left( \sin\bar{\sigma} \sum_{s=0}^{\infty} \frac{(-1)^s\bar{v}_{2s}(t)}{(t^2+1)^{3s}\mu^{4s}} + \cos\bar{\sigma} \sum_{s=0}^{\infty} \frac{(-1)^s\bar{v}_{2s+1}(t)}{(t^2+1)^{3s+\frac{3}{2}}\mu^{4s+2}} \right),$$

uniformly for  $t \in \mathbb{R}$ , where

$$12.14.36 \quad \bar{\sigma} = \mu^2\bar{\xi} + \frac{1}{4}\pi,$$

and  $\bar{\xi}$  and the coefficients  $\bar{u}_s(t)$  and  $\bar{v}_s(t)$  as in §12.10(v).

**12.14(x) Modulus and Phase Functions**

As noted in §12.14(ix), when  $a$  is negative the solutions of (12.2.3), with  $z$  replaced by  $x$ , are oscillatory on the whole real line; also, when  $a$  is positive there is a central interval  $-2\sqrt{a} < x < 2\sqrt{a}$  in which the solutions

are exponential in character. In the oscillatory intervals we write

**12.14.37**

$$k^{-1/2} W(a, x) + ik^{1/2} W(a, -x) = \tilde{F}(a, x)e^{i\tilde{\theta}(a, x)},$$

**12.14.38**

$$k^{-1/2} W'(a, x) + ik^{1/2} W'(a, -x) = -\tilde{G}(a, x)e^{i\tilde{\psi}(a, x)},$$

where  $k$  is defined in (12.14.5), and  $\tilde{F}(a, x)$  ( $>0$ ),  $\tilde{\theta}(a, x)$ ,  $\tilde{G}(a, x)$  ( $>0$ ), and  $\tilde{\psi}(a, x)$  are real.  $\tilde{F}$  or  $\tilde{G}$  is the *modulus* and  $\tilde{\theta}$  or  $\tilde{\psi}$  is the corresponding *phase*. Compare §12.2(vi).

For properties of the modulus and phase functions, including differential equations and asymptotic expansions for large  $x$ , see Miller (1955, pp. 87–88). For graphs of the modulus functions see §12.14(iii).

**12.14(xi) Zeros of  $W(a, x)$ ,  $W'(a, x)$** 

For asymptotic expansions of the zeros of  $W(a, x)$  and  $W'(a, x)$ , see Olver (1959).

**12.15 Generalized Parabolic Cylinder Functions**

The equation

$$12.15.1 \quad \frac{d^2 w}{dz^2} + (\nu + \lambda^{-1} - \lambda^{-2} z^\lambda) w = 0$$

can be viewed as a generalization of (12.2.4). This equation arises in the study of non-self-adjoint elliptic boundary-value problems involving an indefinite weight function. See Faierman (1992) for power series and asymptotic expansions of a solution of (12.15.1).

**Applications****12.16 Mathematical Applications**

PCFs are used as basic approximating functions in the theory of contour integrals with a coalescing saddle point and an algebraic singularity, and in the theory of differential equations with two coalescing turning points; see §§2.4(vi) and 2.8(vi). For examples see §§13.20(iii), 13.20(iv), 14.15(v), and 14.26.

Sleeman (1968b) considers certain orthogonality properties of the PCFs and corresponding eigenvalues. In Brazel *et al.* (1992) exponential asymptotics are considered in connection with an eigenvalue problem involving PCFs.

PCFs are also used in integral transforms with respect to the parameter, and inversion formulas exist for kernels containing PCFs. See Erdélyi (1941a), Cherry (1948), and Lowdon (1970). Integral transforms and sampling expansions are considered in Jerri (1982).

**12.17 Physical Applications**

The main applications of PCFs in mathematical physics arise when solving the Helmholtz equation

$$12.17.1 \quad \nabla^2 w + k^2 w = 0,$$

where  $k$  is a constant, and  $\nabla^2$  is the Laplacian

$$12.17.2 \quad \nabla^2 = \frac{\partial^2}{\partial x^2} + \frac{\partial^2}{\partial y^2} + \frac{\partial^2}{\partial z^2}$$

in Cartesian coordinates  $x, y, z$  of three-dimensional space (§1.5(ii)). By using instead coordinates of the parabolic cylinder  $\xi, \eta, \zeta$ , defined by

$$12.17.3 \quad x = \xi\eta, \quad y = \frac{1}{2}\xi^2 - \frac{1}{2}\eta^2, \quad z = \zeta,$$

(12.17.1) becomes

$$12.17.4 \quad \frac{1}{\xi^2 + \eta^2} \left( \frac{\partial^2 w}{\partial \xi^2} + \frac{\partial^2 w}{\partial \eta^2} \right) + \frac{\partial^2 w}{\partial \zeta^2} + k^2 w = 0.$$

Setting  $w = U(\xi)V(\eta)W(\zeta)$  and separating variables, we obtain

$$12.17.5 \quad \begin{aligned} \frac{d^2 U}{d\xi^2} + (\sigma\xi^2 + \lambda)U &= 0, \\ \frac{d^2 V}{d\eta^2} + (\sigma\eta^2 - \lambda)V &= 0, \\ \frac{d^2 W}{d\zeta^2} + (k^2 - \sigma)W &= 0, \end{aligned}$$

with arbitrary constants  $\sigma, \lambda$ . The first two equations can be transformed into (12.2.2) or (12.2.3).

In a similar manner coordinates of the paraboloid of revolution transform the Helmholtz equation into equations related to the differential equations considered in this chapter. See Buchholz (1969, §4) and Morse and Feshbach (1953a, pp. 515 and 553).

Buchholz (1969) collects many results on boundary-value problems involving PCFs. Miller (1974) treats separation of variables by group theoretic methods. Dean (1966) describes the role of PCFs in quantum mechanical systems closely related to the one-dimensional harmonic oscillator.

Problems on high-frequency scattering in homogeneous media by parabolic cylinders lead to asymptotic methods for integrals involving PCFs. For this topic and other boundary-value problems see Boyd (1973), Hillion (1997), Magnus (1941), Morse and Feshbach (1953a,b), Müller (1988), Ott (1985), Rice (1954), and Shanmugam (1978).

Lastly, parabolic cylinder functions arise in the description of ultra cold atoms in harmonic trapping potentials; see Busch *et al.* (1998) and Edwards *et al.* (1999).

## Computation

### 12.18 Methods of Computation

Because PCFs are special cases of confluent hypergeometric functions, the methods of computation described in §13.29 are applicable to PCFs. These include the use of power-series expansions, recursion, integral representations, differential equations, asymptotic expansions, and expansions in series of Bessel functions. See, especially, Temme (2000) and Gil *et al.* (2004b, 2006b,c).

### 12.19 Tables

- Abramowitz and Stegun (1964, Chapter 19) includes  $U(a, x)$  and  $V(a, x)$  for  $\pm a = 0(.1)1(.5)5$ ,  $x = 0(.1)5$ , 5S;  $W(a, \pm x)$  for  $\pm a = 0(.1)1(1)5$ ,  $x = 0(.1)5$ , 4-5D or 4-5S.
- Miller (1955) includes  $W(a, x)$ ,  $W(a, -x)$ , and reduced derivatives for  $a = -10(1)10$ ,  $x = 0(.1)10$ , 8D or 8S. Modulus and phase functions, and also other auxiliary functions are tabulated.
- Fox (1960) includes modulus and phase functions for  $W(a, x)$  and  $W(a, -x)$ , and several auxiliary functions for  $x^{-1} = 0(.005)0.1$ ,  $a = -10(1)10$ , 8S.
- Kireyeva and Karpov (1961) includes  $D_p(x(1+i))$  for  $\pm x = 0(.1)5$ ,  $p = 0(.1)2$ , and  $\pm x = 5(.01)10$ ,  $p = 0(.5)2$ , 7D.
- Karpov and Čistova (1964) includes  $D_p(x)$  for  $p = -2(.1)0$ ,  $\pm x = 0(.01)5$ ;  $p = -2(.05)0$ ,  $\pm x = 5(.01)10$ , 6D.
- Karpov and Čistova (1968) includes  $e^{-\frac{1}{4}x^2} D_p(-x)$  and  $e^{-\frac{1}{4}x^2} D_p(ix)$  for  $x = 0(.01)5$  and  $x^{-1} = 0(.001$  or  $.0001)5$ ,  $p = -1(.1)1$ , 7D or 8S.
- Murzewski and Sowa (1972) includes  $D_{-n}(x)$  ( $= U(n - \frac{1}{2}, x)$ ) for  $n = 1(1)20$ ,  $x = 0(.05)3$ , 7S.
- Zhang and Jin (1996, pp. 455–473) includes  $U(\pm n - \frac{1}{2}, x)$ ,  $V(\pm n - \frac{1}{2}, x)$ ,  $U(\pm \nu - \frac{1}{2}, x)$ ,  $V(\pm \nu - \frac{1}{2}, x)$ , and derivatives,  $\nu = n + \frac{1}{2}$ ,  $n = 0(1)10(10)30$ ,  $x = 0.5, 1, 5, 10, 30, 50$ , 8S;  $W(a, \pm x)$ ,  $W(-a, \pm x)$ , and derivatives,  $a = h(1)5 + h$ ,  $x = 0.5, 1$  and  $a = h(1)5 + h$ ,  $x = 5$ ,  $h = 0, 0.5$ , 8S. Also, first zeros of  $U(a, x)$ ,  $V(a, x)$ , and of derivatives,  $a = -6(.5)-1$ , 6D; first three zeros of  $W(a, -x)$  and of derivative,  $a = 0(.5)4$ , 6D; first three zeros of  $W(-a, \pm x)$  and of derivative,  $a = 0.5(.5)5.5$ , 6D; real and imaginary

parts of  $U(a, z)$ ,  $a = -1.5(1)1.5$ ,  $z = x + iy$ ,  $x = 0.5, 1, 5, 10$ ,  $y = 0(.5)10$ , 8S.

For other tables prior to 1961 see Fletcher *et al.* (1962) and Lebedev and Fedorova (1960).

### 12.20 Approximations

Luke (1969b, pp. 25 and 35) gives Chebyshev-series expansions for the confluent hypergeometric functions  $U(a, b, x)$  and  $M(a, b, x)$  (§13.2(i)) whose regions of validity include intervals with endpoints  $x = \infty$  and  $x = 0$ , respectively. As special cases of these results a Chebyshev-series expansion for  $U(a, x)$  valid when  $\lambda \leq x < \infty$  follows from (12.7.14), and Chebyshev-series expansions for  $U(a, x)$  and  $V(a, x)$  valid when  $0 \leq x \leq \lambda$  follow from (12.4.1), (12.4.2), (12.7.12), and (12.7.13). Here  $\lambda$  denotes an arbitrary positive constant.

### 12.21 Software

See <http://dlmf.nist.gov/12.21>.

## References

### General References

The main references used in writing this chapter are Erdélyi *et al.* (1953b, v. 2), Miller (1955), and Olver (1959). For additional bibliographic reading see Buchholz (1969), Lebedev (1965), Magnus *et al.* (1966), Olver (1997b), and Temme (1996a).

### Sources

The following list gives the references or other indications of proofs that were used in constructing the various sections of this chapter. These sources supplement the references that are quoted in the text.

§12.2 See Miller (1955, pp. 9–10, 17, 63–64, and 72), Miller (1952), Miller (1950), and Olver (1997b, Chapter 5, §3.3).

§12.3 These graphics were produced at NIST.

§12.4 See Miller (1955, pp. 61–63).

§12.5 See Whittaker (1902) and Miller (1955, pp. 19 and 25–26). For (12.5.4) combine (12.2.18) and (12.5.1). In Miller (1955, p. 26) the conditions on  $a$  given in Eqs. (12.5.8) and (12.5.9) are missing. These conditions are needed to ensure that in each integrand no poles of the two gamma functions coincide.

- §12.7 See Miller (1955, pp. 40–43, 73–74, 76, and 77–79). For (12.7.7) combine (7.18.11) and (7.18.12).
- §12.8 See Miller (1955, p. 65). (12.8.9), (12.8.10), (12.8.11), and (12.8.12) can be obtained from (12.5.1), (12.5.6), (12.5.7), and (12.5.9), respectively.
- §12.9 (12.9.1) is obtained from (12.7.14) and (13.7.3). (12.9.2)–(12.9.4) follow from (12.2.18) and (12.2.20). See also Whittaker (1902) and Whittaker and Watson (1927, pp. 348–349).
- §12.10 See Olver (1959). Equations (12.10.42)–(12.10.46) are rearrangements of Olver’s results and have the advantage of avoiding the many-valued functions in the explicit expressions for  $A_s(\zeta)$ ,  $B_s(\zeta)$ ,  $C_s(\zeta)$ , and  $D_s(\zeta)$ .
- §12.11 See Whittaker and Watson (1927, p. 354), Dean (1966), Riekstynš (1991, p. 195), and Olver (1959). (12.11.9) is obtained by truncating (12.11.4) at its second term, and applying (12.10.41) with terms up to and including  $w^5$ .
- §12.12 See Erdélyi *et al.* (1953b, Chapter 8). For (12.12.4) see Durand (1975).
- §12.13 (12.13.1)–(12.13.4) follow from the results in §12.8(ii) and Taylor’s theorem (§1.10(i)). For (12.13.5) see Shanker (1939) or Erdélyi *et al.* (1953b, Chapter 8). For (12.13.6) see Lepe (1985).
- §12.14 See Miller (1955, pp. 17–18, 26, 43, 80–82, 87, 89), Miller (1952), and Olver (1959). The graphs were produced at NIST.
- §12.17 See Jeffreys and Jeffreys (1956, §§18.04 and 23.08) and Morse and Feshbach (1953a,b, pp. 553, 1403–1405).





## Chapter 13

# Confluent Hypergeometric Functions

A. B. Olde Daalhuis<sup>1</sup>

<b>Notation</b>	<b>322</b>	13.18 Relations to Other Functions . . . . .	338
13.1 Special Notation . . . . .	322	13.19 Asymptotic Expansions for Large Argument	339
<b>Kummer Functions</b>	<b>322</b>	13.20 Uniform Asymptotic Approximations for Large $\mu$ . . . . .	339
13.2 Definitions and Basic Properties . . . . .	322	13.21 Uniform Asymptotic Approximations for Large $\kappa$ . . . . .	341
13.3 Recurrence Relations and Derivatives . .	325	13.22 Zeros . . . . .	342
13.4 Integral Representations . . . . .	326	13.23 Integrals . . . . .	343
13.5 Continued Fractions . . . . .	327	13.24 Series . . . . .	344
13.6 Relations to Other Functions . . . . .	327	13.25 Products . . . . .	345
13.7 Asymptotic Expansions for Large Argument	328	13.26 Addition and Multiplication Theorems . .	345
13.8 Asymptotic Approximations for Large Pa- rameters . . . . .	330	<b>Applications</b>	<b>345</b>
13.9 Zeros . . . . .	331	13.27 Mathematical Applications . . . . .	345
13.10 Integrals . . . . .	332	13.28 Physical Applications . . . . .	346
13.11 Series . . . . .	333	<b>Computation</b>	<b>346</b>
13.12 Products . . . . .	333	13.29 Methods of Computation . . . . .	346
13.13 Addition and Multiplication Theorems . .	333	13.30 Tables . . . . .	347
<b>Whittaker Functions</b>	<b>334</b>	13.31 Approximations . . . . .	347
13.14 Definitions and Basic Properties . . . . .	334	13.32 Software . . . . .	347
13.15 Recurrence Relations and Derivatives . .	336	<b>References</b>	<b>347</b>
13.16 Integral Representations . . . . .	337		
13.17 Continued Fractions . . . . .	338		

<sup>1</sup>School of Mathematics, Edinburgh University, Edinburgh, United Kingdom.

**Acknowledgments:** This chapter is based in part on Abramowitz and Stegun (1964, Chapter 13) by L.J. Slater. The author is indebted to J. Wimp for several references.

**Copyright** © 2009 National Institute of Standards and Technology. All rights reserved.

## Notation

### 13.1 Special Notation

(For other notation see pp. xiv and 873.)

$m$	integer.
$n, s$	nonnegative integers.
$x, y$	real variables.
$z$	complex variable.
$\delta$	arbitrary small positive constant.
$\gamma$	Euler's constant (§5.2(ii)).
$\Gamma(x)$	Gamma function (§5.2(i)).
$\psi(x)$	$\Gamma'(x)/\Gamma(x)$ .

The main functions treated in this chapter are the Kummer functions  $M(a, b, z)$  and  $U(a, b, z)$ , Olver's function  $\mathbf{M}(a, b, z)$ , and the Whittaker functions  $M_{\kappa, \mu}(z)$  and  $W_{\kappa, \mu}(z)$ .

Other notations are:  ${}_1F_1(a; b; z)$  (§16.2(i)) and  $\Phi(a; b; z)$  (Humbert (1920)) for  $M(a, b, z)$ ;  $\Psi(a; b; z)$  (Erdélyi *et al.* (1953a, §6.5)) for  $U(a, b, z)$ ;  $V(b - a, b, z)$  (Olver (1997b, p. 256)) for  $e^z U(a, b, -z)$ ;  $\Gamma(1 + 2\mu)\mathcal{M}_{\kappa, \mu}$  (Buchholz (1969, p. 12)) for  $M_{\kappa, \mu}(z)$ .

For an historical account of notations see Slater (1960, Chapter 1).

## Kummer Functions

### 13.2 Definitions and Basic Properties

#### 13.2(i) Differential Equation

**Kummer's Equation**

$$13.2.1 \quad z \frac{d^2 w}{dz^2} + (b - z) \frac{dw}{dz} - aw = 0.$$

This equation has a regular singularity at the origin with indices 0 and  $1 - b$ , and an irregular singularity at infinity of rank one. It can be regarded as the limiting form of the hypergeometric differential equation (§15.10(i)) that is obtained on replacing  $z$  by  $z/b$ , letting  $b \rightarrow \infty$ , and subsequently replacing the symbol  $c$  by  $b$ . In effect, the regular singularities of the hypergeometric differential equation at  $b$  and  $\infty$  coalesce into an irregular singularity at  $\infty$ .

#### Standard Solutions

The first two standard solutions are:

**13.2.2**

$$M(a, b, z) = \sum_{s=0}^{\infty} \frac{(a)_s}{(b)_s s!} z^s = 1 + \frac{a}{b} z + \frac{a(a+1)}{b(b+1)2!} z^2 + \dots,$$

and

$$13.2.3 \quad \mathbf{M}(a, b, z) = \sum_{s=0}^{\infty} \frac{(a)_s}{\Gamma(b+s)s!} z^s,$$

except that  $M(a, b, z)$  does not exist when  $b$  is a nonpositive integer. In other cases

$$13.2.4 \quad M(a, b, z) = \Gamma(b) \mathbf{M}(a, b, z).$$

The series (13.2.2) and (13.2.3) converge for all  $z \in \mathbb{C}$ .  $M(a, b, z)$  is entire in  $z$  and  $a$ , and is a meromorphic function of  $b$ .  $\mathbf{M}(a, b, z)$  is entire in  $z$ ,  $a$ , and  $b$ .

Although  $M(a, b, z)$  does not exist when  $b = -n$ ,  $n = 0, 1, 2, \dots$ , many formulas containing  $M(a, b, z)$  continue to apply in their limiting form. In particular,

**13.2.5**

$$\begin{aligned} \lim_{b \rightarrow -n} \frac{M(a, b, z)}{\Gamma(b)} &= \mathbf{M}(a, -n, z) \\ &= \frac{(a)_{n+1}}{(n+1)!} z^{n+1} M(a+n+1, n+2, z). \end{aligned}$$

When  $a = -n$ ,  $n = 0, 1, 2, \dots$ ,  $\mathbf{M}(a, b, z)$  is a polynomial in  $z$  of degree not exceeding  $n$ ; this is also true of  $M(a, b, z)$  provided that  $b$  is not a nonpositive integer.

Another standard solution of (13.2.1) is  $U(a, b, z)$ , which is determined uniquely by the property

$$13.2.6 \quad U(a, b, z) \sim z^{-a}, \quad z \rightarrow \infty, \quad |\text{ph } z| \leq \frac{3}{2}\pi - \delta,$$

where  $\delta$  is an arbitrary small positive constant. In general,  $U(a, b, z)$  has a branch point at  $z = 0$ . The *principal branch* corresponds to the *principal value* of  $z^{-a}$  in (13.2.6), and has a cut in the  $z$ -plane along the interval  $(-\infty, 0]$ ; compare §4.2(i).

When  $a = -n$ ,  $n = 0, 1, 2, \dots$ ,  $U(a, b, z)$  is a polynomial in  $z$  of degree  $n$ :

$$13.2.7 \quad U(-n, b, z) = (-1)^n \sum_{s=0}^n \binom{n}{s} (b+s)_{n-s} (-z)^s.$$

Similarly, when  $a - b + 1 = -n$ ,  $n = 0, 1, 2, \dots$ ,

$$13.2.8 \quad U(a, a+n+1, z) = z^{-a} \sum_{s=0}^n \binom{n}{s} (a)_s z^{-s}.$$

When  $b = n + 1$ ,  $n = 0, 1, 2, \dots$ ,

$$13.2.9 \quad U(a, n + 1, z) = \frac{(-1)^{n+1}}{n! \Gamma(a - n)} \sum_{k=0}^{\infty} \frac{(a)_k}{(n + 1)_k k!} z^k (\ln z + \psi(a + k) - \psi(1 + k) - \psi(n + k + 1)) \\ + \frac{1}{\Gamma(a)} \sum_{k=1}^n \frac{(k - 1)!(1 - a + k)_{n-k}}{(n - k)!} z^{-k},$$

if  $a \neq 0, -1, -2, \dots$ , or

$$13.2.10 \quad U(a, n + 1, z) = (-1)^a \sum_{k=0}^{-a} \binom{-a}{k} (n + k + 1)_{-a-k} (-z)^k,$$

if  $a = 0, -1, -2, \dots$ .

When  $b = -n$ ,  $n = 0, 1, 2, \dots$ , the following equation can be combined with (13.2.9) and (13.2.10):

$$13.2.11 \quad U(a, -n, z) = z^{n+1} U(a + n + 1, n + 2, z).$$

### 13.2(ii) Analytic Continuation

When  $m \in \mathbb{Z}$ ,

$$13.2.12 \quad U(a, b, ze^{2\pi im}) = \frac{2\pi i e^{-\pi ibm} \sin(\pi bm)}{\Gamma(1 + a - b) \sin(\pi b)} \mathbf{M}(a, b, z) \\ + e^{-2\pi ibm} U(a, b, z).$$

Except when  $z = 0$  each branch of  $U(a, b, z)$  is entire in  $a$  and  $b$ . Unless specified otherwise, however,  $U(a, b, z)$  is assumed to have its principal value.

### 13.2(iii) Limiting Forms as $z \rightarrow 0$

$$13.2.13 \quad M(a, b, z) = 1 + O(z).$$

Next, in cases when  $a = -n$  or  $-n + b - 1$ , where  $n$  is a nonnegative integer,

$$13.2.14 \quad U(-n, b, z) = (-1)^n (b)_n + O(z),$$

$$13.2.15 \quad U(-n + b - 1, b, z) = (-1)^n (2 - b)_n z^{1-b} + O(z^{2-b}).$$

In all other cases

$$13.2.16 \quad U(a, b, z) = \frac{\Gamma(b - 1)}{\Gamma(a)} z^{1-b} + O(z^{2-\Re b}), \quad \Re b \geq 2, b \neq 2,$$

$$13.2.17 \quad U(a, 2, z) = \frac{1}{\Gamma(a)} z^{-1} + O(\ln z),$$

$$13.2.18 \quad U(a, b, z) = \frac{\Gamma(b - 1)}{\Gamma(a)} z^{1-b} + \frac{\Gamma(1 - b)}{\Gamma(a - b + 1)} + O(z^{2-\Re b}), \\ 1 \leq \Re b < 2, b \neq 1,$$

$$13.2.19 \quad U(a, 1, z) = -\frac{1}{\Gamma(a)} (\ln z + \psi(a) + 2\gamma) + O(z \ln z),$$

$$13.2.20 \quad U(a, b, z) = \frac{\Gamma(1 - b)}{\Gamma(a - b + 1)} + O(z^{1-\Re b}), \quad 0 < \Re b < 1,$$

$$13.2.21 \quad U(a, 0, z) = \frac{1}{\Gamma(a + 1)} + O(z \ln z),$$

$$13.2.22 \quad U(a, b, z) = \frac{\Gamma(1 - b)}{\Gamma(a - b + 1)} + O(z), \quad \Re b \leq 0, b \neq 0.$$

### 13.2(iv) Limiting Forms as $z \rightarrow \infty$

Except when  $a = 0, -1, \dots$  (polynomial cases),

$$13.2.23 \quad \mathbf{M}(a, b, z) \sim e^z z^{a-b} / \Gamma(a), \quad |\text{ph } z| \leq \frac{1}{2}\pi - \delta,$$

where  $\delta$  is an arbitrary small positive constant.

For  $U(a, b, z)$  see (13.2.6).

### 13.2(v) Numerically Satisfactory Solutions

Fundamental pairs of solutions of (13.2.1) that are numerically satisfactory (§2.7(iv)) in the neighborhood of infinity are

$$13.2.24 \quad U(a, b, z), \quad e^z U(b - a, b, e^{-\pi i} z), \\ -\frac{1}{2}\pi \leq \text{ph } z \leq \frac{3}{2}\pi,$$

$$13.2.25 \quad U(a, b, z), \quad e^z U(b - a, b, e^{\pi i} z), \\ -\frac{3}{2}\pi \leq \text{ph } z \leq \frac{1}{2}\pi.$$

A fundamental pair of solutions that is numerically satisfactory near the origin is

$$13.2.26 \quad M(a, b, z), \quad z^{1-b} M(a - b + 1, 2 - b, z), \quad b \notin \mathbb{Z}.$$

When  $b = n + 1 = 1, 2, 3, \dots$ , a fundamental pair that is numerically satisfactory near the origin is  $M(a, n + 1, z)$  and

$$13.2.27 \quad \sum_{k=1}^n \frac{n!(k-1)!}{(n-k)!(1-a)_k} z^{-k} - \sum_{k=0}^{\infty} \frac{(a)_k}{(n+1)_k k!} z^k (\ln z + \psi(a+k) - \psi(1+k) - \psi(n+k+1)),$$

if  $a - n \neq 0, -1, -2, \dots$ , or  $M(a, n + 1, z)$  and

$$13.2.28 \quad \sum_{k=1}^n \frac{n!(k-1)!}{(n-k)!(1-a)_k} z^{-k} - \sum_{k=0}^{-a} \frac{(a)_k}{(n+1)_k k!} z^k (\ln z + \psi(1-a-k) - \psi(1+k) - \psi(n+k+1)) + (-1)^{1-a} (-a)! \sum_{k=1-a}^{\infty} \frac{(k-1+a)!}{(n+1)_k k!} z^k,$$

if  $a = 0, -1, -2, \dots$ , or  $M(a, n + 1, z)$  and

$$13.2.29 \quad \sum_{k=a}^n \frac{(k-1)!}{(n-k)!(k-a)!} z^{-k},$$

if  $a = 1, 2, \dots, n$ .

When  $b = -n = 0, -1, -2, \dots$ , a fundamental pair that is numerically satisfactory near the origin is  $z^{n+1} \times M(a + n + 1, n + 2, z)$  and

$$13.2.30 \quad \sum_{k=1}^{n+1} \frac{(n+1)!(k-1)!}{(n-k+1)!(-a-n)_k} z^{n-k+1} - \sum_{k=0}^{\infty} \frac{(a+n+1)_k}{(n+2)_k k!} z^{n+k+1} (\ln z + \psi(a+n+k+1) - \psi(1+k) - \psi(n+k+2)),$$

if  $a \neq 0, -1, -2, \dots$ , or  $z^{n+1} M(a + n + 1, n + 2, z)$  and

$$13.2.31 \quad \sum_{k=1}^{n+1} \frac{(n+1)!(k-1)!}{(n-k+1)!(-a-n)_k} z^{n-k+1} - \sum_{k=0}^{-a-n-1} \frac{(a+n+1)_k}{(n+2)_k k!} z^{n+k+1} (\ln z + \psi(-a-n-k) - \psi(1+k) - \psi(n+k+2)) + (-1)^{n-a} (-a-n-1)! \sum_{k=-a-n}^{\infty} \frac{(k+a+n)!}{(n+2)_k k!} z^{n+k+1},$$

if  $a = -n - 1, -n - 2, -n - 3, \dots$ , or  $z^{n+1} M(a + n + 1, n + 2, z)$  and

$$13.2.32 \quad \sum_{k=a+n+1}^{n+1} \frac{(k-1)!}{(n-k+1)!(k-a-n-1)!} z^{n-k+1},$$

if  $a = 0, -1, \dots, -n$ .

### 13.2(vi) Wronskians

$$13.2.33 \quad \mathscr{W} \{ \mathbf{M}(a, b, z), z^{1-b} \mathbf{M}(a-b+1, 2-b, z) \} = \sin(\pi b) z^{-b} e^z / \pi,$$

$$13.2.34 \quad \mathscr{W} \{ \mathbf{M}(a, b, z), U(a, b, z) \} = -z^{-b} e^z / \Gamma(a),$$

$$13.2.35 \quad \mathscr{W} \{ \mathbf{M}(a, b, z), e^z U(b-a, b, e^{\pm\pi i} z) \} = e^{\mp b\pi i} z^{-b} e^z / \Gamma(b-a),$$

$$13.2.36 \quad \mathscr{W} \{ z^{1-b} \mathbf{M}(a-b+1, 2-b, z), U(a, b, z) \} = -z^{-b} e^z / \Gamma(a-b+1),$$

$$13.2.37 \quad \mathscr{W} \{ z^{1-b} \mathbf{M}(a-b+1, 2-b, z), e^z U(b-a, b, e^{\pm\pi i} z) \} = -z^{-b} e^z / \Gamma(1-a),$$

$$13.2.38 \quad \mathscr{W} \{ U(a, b, z), e^z U(b-a, b, e^{\pm\pi i} z) \} = e^{\pm(a-b)\pi i} z^{-b} e^z.$$

**13.2(vii) Connection Formulas****Kummer's Transformations**

$$13.2.39 \quad M(a, b, z) = e^z M(b - a, b, -z),$$

$$13.2.40 \quad U(a, b, z) = z^{1-b} U(a - b + 1, 2 - b, z).$$

$$13.2.41 \quad \frac{1}{\Gamma(b)} M(a, b, z) = \frac{e^{\mp a\pi i}}{\Gamma(b-a)} U(a, b, z) + \frac{e^{\pm(b-a)\pi i}}{\Gamma(a)} e^z U(b - a, b, e^{\pm\pi i} z).$$

Also, when  $b$  is not an integer

$$13.2.42 \quad U(a, b, z) = \frac{\Gamma(1-b)}{\Gamma(a-b+1)} M(a, b, z) + \frac{\Gamma(b-1)}{\Gamma(a)} z^{1-b} M(a - b + 1, 2 - b, z).$$

**13.3 Recurrence Relations and Derivatives****13.3(i) Recurrence Relations**

$$13.3.1 \quad (b-a)M(a-1, b, z) + (2a-b+z)M(a, b, z) - aM(a+1, b, z) = 0,$$

$$13.3.2 \quad b(b-1)M(a, b-1, z) + b(1-b-z)M(a, b, z) + z(b-a)M(a, b+1, z) = 0,$$

$$13.3.3 \quad (a-b+1)M(a, b, z) - aM(a+1, b, z) + (b-1)M(a, b-1, z) = 0,$$

$$13.3.4 \quad bM(a, b, z) - bM(a-1, b, z) - zM(a, b+1, z) = 0,$$

$$13.3.5 \quad b(a+z)M(a, b, z) + z(a-b)M(a, b+1, z) - abM(a+1, b, z) = 0,$$

$$13.3.6 \quad (a-1+z)M(a, b, z) + (b-a)M(a-1, b, z) + (1-b)M(a, b-1, z) = 0,$$

$$13.3.7 \quad U(a-1, b, z) + (b-2a-z)U(a, b, z) + a(a-b+1)U(a+1, b, z) = 0,$$

$$13.3.8 \quad (b-a-1)U(a, b-1, z) + (1-b-z)U(a, b, z) + zU(a, b+1, z) = 0,$$

$$13.3.9 \quad U(a, b, z) - aU(a+1, b, z) - U(a, b-1, z) = 0,$$

$$13.3.10 \quad (b-a)U(a, b, z) + U(a-1, b, z) - zU(a, b+1, z) = 0,$$

$$13.3.11 \quad (a+z)U(a, b, z) - zU(a, b+1, z) + a(b-a-1)U(a+1, b, z) = 0,$$

$$13.3.12 \quad (a-1+z)U(a, b, z) - U(a-1, b, z) + (a-b+1)U(a, b-1, z) = 0.$$

Kummer's differential equation (13.2.1) is equivalent to

$$13.3.13 \quad (a+1)zM(a+2, b+2, z) + (b+1)(b-z)M(a+1, b+1, z) - b(b+1)M(a, b, z) = 0,$$

and

$$13.3.14 \quad (a+1)zU(a+2, b+2, z) + (z-b)U(a+1, b+1, z) - U(a, b, z) = 0.$$

**13.3(ii) Differentiation Formulas**

$$13.3.15 \quad \frac{d}{dz} M(a, b, z) = \frac{a}{b} M(a+1, b+1, z),$$

$$13.3.16 \quad \frac{d^n}{dz^n} M(a, b, z) = \frac{(a)_n}{(b)_n} M(a+n, b+n, z),$$

$$13.3.17 \quad \left(z \frac{d}{dz} z\right)^n (z^{a-1} M(a, b, z)) = (a)_n z^{a+n-1} M(a+n, b, z),$$

$$13.3.18 \quad \frac{d^n}{dz^n} (z^{b-1} M(a, b, z)) = (b-n)_n z^{b-n-1} M(a, b-n, z),$$

$$13.3.19 \quad \begin{aligned} & \left(z \frac{d}{dz} z\right)^n (z^{b-a-1} e^{-z} M(a, b, z)) \\ &= (b-a)_n z^{b-a+n-1} e^{-z} M(a-n, b, z), \end{aligned}$$

$$13.3.20 \quad \begin{aligned} & \frac{d^n}{dz^n} (e^{-z} M(a, b, z)) \\ &= (-1)^n \frac{(b-a)_n}{(b)_n} e^{-z} M(a, b+n, z), \end{aligned}$$

$$13.3.21 \quad \begin{aligned} & \frac{d^n}{dz^n} (z^{b-1} e^{-z} M(a, b, z)) \\ &= (b-n)_n z^{b-n-1} e^{-z} M(a-n, b-n, z). \end{aligned}$$

13.3.22  $\frac{d}{dz} U(a, b, z) = -a U(a + 1, b + 1, z),$   
 13.3.23  $\frac{d^n}{dz^n} U(a, b, z) = (-1)^n (a)_n U(a + n, b + n, z),$   
 13.3.24  $\left(z \frac{d}{dz} z\right)^n (z^{a-1} U(a, b, z))$   
 $= (a)_n (a - b + 1)_n z^{a+n-1} U(a + n, b, z),$   
 13.3.25  $\frac{d^n}{dz^n} (z^{b-1} U(a, b, z))$   
 $= (-1)^n (a - b + 1)_n z^{b-n-1} U(a, b - n, z),$   
 13.3.26  $\left(z \frac{d}{dz} z\right)^n (z^{b-a-1} e^{-z} U(a, b, z))$   
 $= (-1)^n z^{b-a+n-1} e^{-z} U(a - n, b, z),$   
 13.3.27  $\frac{d^n}{dz^n} (e^{-z} U(a, b, z)) = (-1)^n e^{-z} U(a, b + n, z),$   
 13.3.28  $\frac{d^n}{dz^n} (z^{b-1} e^{-z} U(a, b, z))$   
 $= (-1)^n z^{b-n-1} e^{-z} U(a - n, b - n, z).$

Other versions of several of the identities in this subsection can be constructed with the aid of the operator identity

13.3.29  $\left(z \frac{d}{dz} z\right)^n = z^n \frac{d^n}{dz^n} z^n, \quad n = 1, 2, 3, \dots$

### 13.4 Integral Representations

#### 13.4(i) Integrals Along the Real Line

13.4.1  $M(a, b, z) = \frac{1}{\Gamma(a) \Gamma(b - a)} \int_0^1 e^{zt} t^{a-1} (1 - t)^{b-a-1} dt,$   
 $\Re b > \Re a > 0,$

13.4.2  $M(a, b, z) = \frac{1}{\Gamma(b - c)} \int_0^1 M(a, c, zt) t^{c-1} (1 - t)^{b-c-1} dt,$   
 $\Re b > \Re c > 0,$

13.4.3  $M(a, b, -z) = \frac{z^{\frac{1}{2} - \frac{1}{2}b}}{\Gamma(a)} \int_0^\infty e^{-t} t^{a - \frac{1}{2}b - \frac{1}{2}} J_{b-1}(2\sqrt{zt}) dt,$   
 $\Re a > 0.$

For the function  $J_{b-1}$  see §10.2(ii).

13.4.4  $U(a, b, z) = \frac{1}{\Gamma(a)} \int_0^\infty e^{-zt} t^{a-1} (1 + t)^{b-a-1} dt,$   
 $\Re a > 0, |\text{ph } z| < \frac{1}{2}\pi,$

13.4.5  $U(a, b, z)$   
 $= \frac{z^{1-a}}{\Gamma(a) \Gamma(1 + a - b)} \int_0^\infty \frac{U(b - a, b, t) e^{-t} t^{a-1}}{t + z} dt,$   
 $|\text{ph } z| < \pi, \Re a > \max(\Re b - 1, 0),$

13.4.6  $U(a, b, z)$   
 $= \frac{(-1)^n z^{1-b-n}}{\Gamma(1 + a - b)} \int_0^\infty \frac{M(b - a, b, t) e^{-t} t^{b+n-1}}{t + z} dt,$   
 $|\text{ph } z| < \pi, n = 0, 1, 2, \dots, -\Re b < n < 1 + \Re(a - b),$

$U(a, b, z) = \frac{2z^{\frac{1}{2} - \frac{1}{2}b}}{\Gamma(a) \Gamma(a - b + 1)}$   
 13.4.7  $\times \int_0^\infty e^{-t} t^{a - \frac{1}{2}b - \frac{1}{2}} K_{b-1}(2\sqrt{zt}) dt,$   
 $\Re a > \max(\Re b - 1, 0),$

13.4.8  $U(a, b, z) = z^{c-a}$   
 $\times \int_0^\infty e^{-zt} t^{c-1} {}_2F_1(a, a - b + 1; c; -t) dt,$   
 $|\text{ph } z| < \frac{1}{2}\pi,$

where  $c$  is arbitrary,  $\Re c > 0$ . For the functions  $K_{b-1}$  and  ${}_2F_1$  see §10.25(ii) and §§15.1, 15.2(i).

#### 13.4(ii) Contour Integrals

13.4.9  $M(a, b, z) = \frac{\Gamma(1 + a - b)}{2\pi i \Gamma(a)} \int_0^{(1+)} e^{zt} t^{a-1} (t - 1)^{b-a-1} dt,$   
 $b - a \neq 1, 2, 3, \dots, \Re a > 0.$

13.4.10  $M(a, b, z)$   
 $= e^{-a\pi i} \frac{\Gamma(1 - a)}{2\pi i \Gamma(b - a)} \int_1^{(0+)} e^{zt} t^{a-1} (1 - t)^{b-a-1} dt,$   
 $a \neq 1, 2, 3, \dots, \Re(b - a) > 0.$

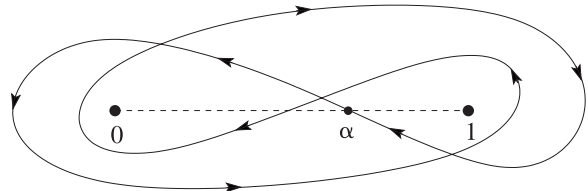


Figure 13.4.1: Contour of integration in (13.4.11). (Compare Figure 5.12.3.)

13.4.11  $M(a, b, z)$   
 $= e^{-b\pi i} \Gamma(1 - a) \Gamma(1 + a - b)$   
 $\times \frac{1}{4\pi^2} \int_\alpha^{(0+, 1+, 0-, 1-)} e^{zt} t^{a-1} (1 - t)^{b-a-1} dt,$   
 $a, b - a \neq 1, 2, 3, \dots$

The contour of integration starts and terminates at a point  $\alpha$  on the real axis between 0 and 1. It encircles  $t = 0$  and  $t = 1$  once in the positive sense, and then once in the negative sense. See Figure 13.4.1. The fractional powers are continuous and assume their principal

values at  $t = \alpha$ . Similar conventions also apply to the remaining integrals in this subsection.

**13.4.12**

$$\begin{aligned} \mathbf{M}(a, c, z) &= \frac{\Gamma(b)}{2\pi i} z^{1-b} \int_{-\infty}^{(0+,1+)} e^{zt} t^{-b} {}_2\mathbf{F}_1(a, b; c; 1/t) dt, \\ & \quad b \neq 0, -1, -2, \dots, |\operatorname{ph} z| < \frac{1}{2}\pi. \end{aligned}$$

At the point where the contour crosses the interval  $(1, \infty)$ ,  $t^{-b}$  and the  ${}_2\mathbf{F}_1$  function assume their principal values; compare §§15.1 and 15.2(i). A special case

---


$$\mathbf{13.4.15} \quad \frac{U(a, b, z)}{\Gamma(c)\Gamma(c-b+1)} = \frac{z^{1-c}}{2\pi i} \int_{-\infty}^{(0+)} e^{zt} t^{-c} {}_2\mathbf{F}_1\left(a, c; a+c-b+1; 1-\frac{1}{t}\right) dt, \quad |\operatorname{ph} z| < \frac{1}{2}\pi.$$

Again,  $t^{-c}$  and the  ${}_2\mathbf{F}_1$  function assume their principal values where the contour intersects the positive real axis.

**13.4(iii) Mellin–Barnes Integrals**

If  $a \neq 0, -1, -2, \dots$ , then

**13.4.16**

$$\mathbf{M}(a, b, -z) = \frac{1}{2\pi i \Gamma(a)} \int_{-i\infty}^{i\infty} \frac{\Gamma(a+t)\Gamma(-t)}{\Gamma(b+t)} z^t dt, \quad |\operatorname{ph} z| < \frac{1}{2}\pi,$$

where the contour of integration separates the poles of  $\Gamma(a+t)$  from those of  $\Gamma(-t)$ .

If  $a$  and  $a-b+1 \neq 0, -1, -2, \dots$ , then

**13.4.17**

$$\begin{aligned} U(a, b, z) &= \frac{z^{-a}}{2\pi i} \int_{-i\infty}^{i\infty} \frac{\Gamma(a+t)\Gamma(1+a-b+t)\Gamma(-t)}{\Gamma(a)\Gamma(1+a-b)} z^{-t} dt, \\ & \quad |\operatorname{ph} z| < \frac{3}{2}\pi, \end{aligned}$$

where the contour of integration separates the poles of  $\Gamma(a+t)\Gamma(1+a-b+t)$  from those of  $\Gamma(-t)$ .

**13.4.18**

$$U(a, b, z) = \frac{z^{1-b} e^z}{2\pi i} \int_{-i\infty}^{i\infty} \frac{\Gamma(b-1+t)\Gamma(t)}{\Gamma(a+t)} z^{-t} dt, \quad |\operatorname{ph} z| < \frac{1}{2}\pi,$$

where the contour of integration passes all the poles of  $\Gamma(b-1+t)\Gamma(t)$  on the right-hand side.

**13.5 Continued Fractions**

If  $a, b \in \mathbb{C}$  such that  $a \neq -1, -2, -3, \dots$ , and  $a-b \neq 0, 1, 2, \dots$ , then

$$\mathbf{13.5.1} \quad \frac{M(a, b, z)}{M(a+1, b+1, z)} = 1 + \frac{u_1 z}{1+} \frac{u_2 z}{1+} \dots,$$

is

$$\mathbf{13.4.13} \quad \mathbf{M}(a, b, z) = \frac{z^{1-b}}{2\pi i} \int_{-\infty}^{(0+,1+)} e^{zt} t^{-b} \left(1 - \frac{1}{t}\right)^{-a} dt, \quad |\operatorname{ph} z| < \frac{1}{2}\pi.$$

**13.4.14**

$$\begin{aligned} U(a, b, z) &= e^{-a\pi i} \frac{\Gamma(1-a)}{2\pi i} \int_{\infty}^{(0+)} e^{-zt} t^{a-1} (1+t)^{b-a-1} dt, \\ & \quad a \neq 1, 2, 3, \dots, |\operatorname{ph} z| < \frac{1}{2}\pi. \end{aligned}$$

The contour cuts the real axis between  $-1$  and  $0$ . At this point the fractional powers are determined by  $\operatorname{ph} t = \pi$  and  $\operatorname{ph}(1+t) = 0$ .

where

$$\begin{aligned} \mathbf{13.5.2} \quad u_{2n+1} &= \frac{a-b-n}{(b+2n)(b+2n+1)}, \\ u_{2n} &= \frac{a+n}{(b+2n-1)(b+2n)}. \end{aligned}$$

This continued fraction converges to the meromorphic function of  $z$  on the left-hand side everywhere in  $\mathbb{C}$ . For more details on how a continued fraction converges to a meromorphic function see Jones and Thron (1980).

If  $a, b \in \mathbb{C}$  such that  $a \neq 0, -1, -2, \dots$ , and  $b-a \neq 2, 3, 4, \dots$ , then

$$\mathbf{13.5.3} \quad \frac{U(a, b, z)}{U(a, b-1, z)} = 1 + \frac{v_1/z}{1+} \frac{v_2/z}{1+} \dots,$$

where

$$\mathbf{13.5.4} \quad v_{2n+1} = a+n, \quad v_{2n} = a-b+n+1.$$

This continued fraction converges to the meromorphic function of  $z$  on the left-hand side throughout the sector  $|\operatorname{ph} z| < \pi$ .

See also Cuyt *et al.* (2008, pp. 322–330).

**13.6 Relations to Other Functions****13.6(i) Elementary Functions**

$$\mathbf{13.6.1} \quad M(a, a, z) = e^z,$$

$$\mathbf{13.6.2} \quad M(1, 2, 2z) = \frac{e^z}{z} \sinh z,$$

$$\mathbf{13.6.3} \quad M(0, b, z) = U(0, b, z) = 1,$$

$$\mathbf{13.6.4} \quad U(a, a+1, z) = z^{-a}.$$



### 13.6(ii) Incomplete Gamma Functions

For the notation see §§6.2(i), 7.2(i), 8.2(i), and 8.19(i). When  $a - b$  is an integer or  $a$  is a positive integer the Kummer functions can be expressed as incomplete gamma functions (or generalized exponential integrals). For example,

$$13.6.5 \quad M(a, a+1, -z) = e^{-z} M(1, a+1, z) = az^{-a} \gamma(a, z),$$

$$13.6.6 \quad \begin{aligned} U(a, a, z) &= z^{1-a} U(1, 2-a, z) \\ &= z^{1-a} e^z E_a(z) = e^z \Gamma(1-a, z). \end{aligned}$$

Special cases are the error functions

$$13.6.7 \quad M\left(\frac{1}{2}, \frac{3}{2}, -z^2\right) = \frac{\sqrt{\pi}}{2z} \operatorname{erf}(z),$$

$$13.6.8 \quad U\left(\frac{1}{2}, \frac{1}{2}, z^2\right) = \sqrt{\pi} e^{z^2} \operatorname{erfc}(z).$$

### 13.6(iii) Modified Bessel Functions

When  $b = 2a$  the Kummer functions can be expressed as modified Bessel functions. For the notation see §§10.25(ii) and 9.2(i).

$$13.6.9 \quad M\left(\nu + \frac{1}{2}, 2\nu + 1, 2z\right) = \Gamma(1 + \nu) e^z (z/2)^{-\nu} I_\nu(z),$$

$$13.6.10 \quad U\left(\nu + \frac{1}{2}, 2\nu + 1, 2z\right) = \frac{1}{\sqrt{\pi}} e^z (2z)^{-\nu} K_\nu(z),$$

$$13.6.11 \quad U\left(\frac{5}{6}, \frac{5}{3}, \frac{4}{3} z^{3/2}\right) = \sqrt{\pi} \frac{3^{5/6} \exp\left(\frac{2}{3} z^{3/2}\right)}{2^{2/3} z} \operatorname{Ai}(z).$$

### 13.6(iv) Parabolic Cylinder Functions

For the notation see §12.2.

$$13.6.12 \quad U\left(\frac{1}{2}a + \frac{1}{4}, \frac{1}{2}, \frac{1}{2}z^2\right) = 2^{\frac{1}{2}a + \frac{1}{4}} e^{\frac{1}{4}z^2} U(a, z),$$

$$13.6.13 \quad U\left(\frac{1}{2}a + \frac{3}{4}, \frac{3}{2}, \frac{1}{2}z^2\right) = 2^{\frac{1}{2}a + \frac{3}{4}} \frac{e^{\frac{1}{4}z^2}}{z} U(a, z).$$

$$13.6.14 \quad M\left(\frac{1}{2}a + \frac{1}{4}, \frac{1}{2}, \frac{1}{2}z^2\right) = \frac{2^{\frac{1}{2}a - \frac{3}{4}} \Gamma\left(\frac{1}{2}a + \frac{3}{4}\right) e^{\frac{1}{4}z^2}}{\sqrt{\pi}} \\ \times (U(a, z) + U(a, -z)),$$

$$13.6.15 \quad M\left(\frac{1}{2}a + \frac{3}{4}, \frac{3}{2}, \frac{1}{2}z^2\right) = \frac{2^{\frac{1}{2}a - \frac{5}{4}} \Gamma\left(\frac{1}{2}a + \frac{1}{4}\right) e^{\frac{1}{4}z^2}}{z\sqrt{\pi}} \\ \times (U(a, -z) - U(a, z)).$$

### 13.7.2

$$\mathbf{M}(a, b, z) \sim \frac{e^z z^{a-b}}{\Gamma(a)} \sum_{s=0}^{\infty} \frac{(1-a)_s (b-a)_s}{s!} z^{-s} + \frac{e^{\pm\pi ia} z^{-a}}{\Gamma(b-a)} \sum_{s=0}^{\infty} \frac{(a)_s (a-b+1)_s}{s!} (-z)^{-s}, \quad -\frac{1}{2}\pi + \delta \leq \pm \operatorname{ph} z \leq \frac{3}{2}\pi - \delta,$$

unless  $a = 0, -1, \dots$  and  $b - a = 0, -1, \dots$ . Here  $\delta$  denotes an arbitrary small positive constant. Also,

$$13.7.3 \quad U(a, b, z) \sim z^{-a} \sum_{s=0}^{\infty} \frac{(a)_s (a-b+1)_s}{s!} (-z)^{-s}, \quad |\operatorname{ph} z| \leq \frac{3}{2}\pi - \delta.$$

### 13.6(v) Orthogonal Polynomials

Special cases of §13.6(iv) are as follows. For the notation see §§18.3, 18.19.

#### Hermite Polynomials

$$13.6.16 \quad M\left(-n, \frac{1}{2}, z^2\right) = (-1)^n \frac{n!}{(2n)!} H_{2n}(z),$$

$$13.6.17 \quad M\left(-n, \frac{3}{2}, z^2\right) = (-1)^n \frac{n!}{(2n+1)! 2z} H_{2n+1}(z),$$

$$13.6.18 \quad U\left(\frac{1}{2} - \frac{1}{2}n, \frac{3}{2}, z^2\right) = 2^{-n} z^{-1} H_n(z).$$

#### Laguerre Polynomials

$$13.6.19 \quad \begin{aligned} U(-n, \alpha + 1, z) &= (-1)^n (\alpha + 1)_n M(-n, \alpha + 1, z) \\ &= (-1)^n n! L_n^{(\alpha)}(z). \end{aligned}$$

#### Charlier Polynomials

$$13.6.20 \quad \begin{aligned} U(-n, z - n + 1, a) &= (-z)_n M(-n, z - n + 1, a) \\ &= a^n C_n(z, a). \end{aligned}$$

### 13.6(vi) Generalized Hypergeometric Functions

$$13.6.21 \quad U(a, b, z) = z^{-a} {}_2F_0(a, a - b + 1; -; -z^{-1}).$$

For the definition of  ${}_2F_0(a, a - b + 1; -; -z^{-1})$  when neither  $a$  nor  $a - b + 1$  is a nonpositive integer see §16.5.

## 13.7 Asymptotic Expansions for Large Argument

### 13.7(i) Poincaré-Type Expansions

As  $x \rightarrow \infty$

$$13.7.1 \quad \mathbf{M}(a, b, x) \sim \frac{e^x x^{a-b}}{\Gamma(a)} \sum_{s=0}^{\infty} \frac{(1-a)_s (b-a)_s}{s!} x^{-s},$$

provided that  $a \neq 0, -1, \dots$

As  $z \rightarrow \infty$

**13.7(ii) Error Bounds**

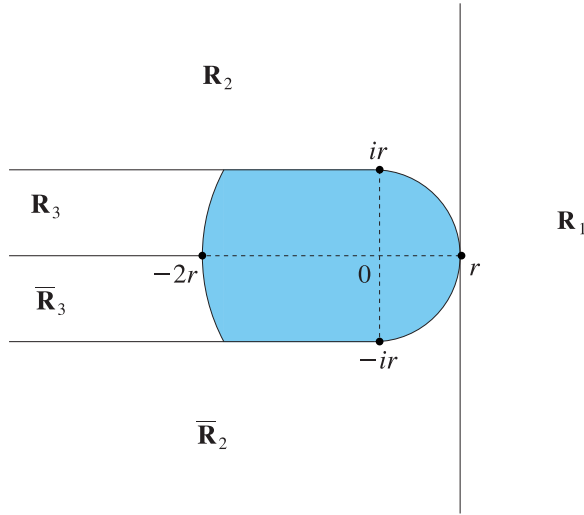


Figure 13.7.1: Regions  $\mathbf{R}_1$ ,  $\mathbf{R}_2$ ,  $\overline{\mathbf{R}}_2$ ,  $\mathbf{R}_3$ , and  $\overline{\mathbf{R}}_3$  are the closures of the indicated unshaded regions bounded by the straight lines and circular arcs centered at the origin, with  $r = |b - 2a|$ .

**13.7.4**

$$U(a, b, z) = z^{-a} \sum_{s=0}^{n-1} \frac{(a)_s (a-b+1)_s}{s!} (-z)^{-s} + \varepsilon_n(z),$$

**13.7(iii) Exponentially-Improved Expansion**

Let

**13.7.10**

$$U(a, b, z) = z^{-a} \sum_{s=0}^{n-1} \frac{(a)_s (a-b+1)_s}{s!} (-z)^{-s} + R_n(a, b, z),$$

and

**13.7.11**

$$R_n(a, b, z) = \frac{(-1)^n 2\pi z^{a-b}}{\Gamma(a)\Gamma(a-b+1)} \left( \sum_{s=0}^{m-1} \frac{(1-a)_s (b-a)_s}{s!} (-z)^{-s} G_{n+2a-b-s}(z) + (1-a)_m (b-a)_m R_{m,n}(a, b, z) \right),$$

where  $m$  is an arbitrary nonnegative integer, and

**13.7.12**

$$G_p(z) = \frac{e^z}{2\pi} \Gamma(p) \Gamma(1-p, z).$$

(For the notation see §8.2(i).) Then as  $z \rightarrow \infty$  with  $||z| - n|$  bounded and  $a, b, m$  fixed

**13.7.13**

$$R_{m,n}(a, b, z) = \begin{cases} O(e^{-|z|} z^{-m}), & |\text{ph } z| \leq \pi, \\ O(e^z z^{-m}), & \pi \leq |\text{ph } z| \leq \frac{5}{2}\pi - \delta. \end{cases}$$

For proofs see Olver (1991b, 1993a). For extensions to hyperasymptotic expansions see Olde Daalhuis and Olver (1995a).

where

$$|\varepsilon_n(z)|, \beta^{-1} |\varepsilon'_n(z)| \leq 2\alpha C_n \left| \frac{(a)_n (a-b+1)_n}{n! z^{a+n}} \right| \exp\left(\frac{2\alpha\rho C_1}{|z|}\right),$$

and with the notation of Figure 13.7.1

**13.7.6**  $C_n = 1$ ,  $\chi(n)$ ,  $(\chi(n) + \sigma\nu^2 n)\nu^n$ , according as

**13.7.7**  $z \in \mathbf{R}_1$ ,  $z \in \mathbf{R}_2 \cup \overline{\mathbf{R}}_2$ ,  $z \in \mathbf{R}_3 \cup \overline{\mathbf{R}}_3$ , respectively, with

**13.7.8**

$$\sigma = |(b-2a)/z|, \quad \nu = \left(\frac{1}{2} + \frac{1}{2}\sqrt{1-4\sigma^2}\right)^{-1/2},$$

$$\chi(n) = \sqrt{\pi} \Gamma(\frac{1}{2}n + 1) / \Gamma(\frac{1}{2}n + \frac{1}{2}).$$

Also, when  $z \in \mathbf{R}_1 \cup \mathbf{R}_2 \cup \overline{\mathbf{R}}_2$

**13.7.9**

$$\alpha = \frac{1}{1-\sigma}, \quad \beta = \frac{1-\sigma^2 + \sigma|z|^{-1}}{2(1-\sigma)},$$

$$\rho = \frac{1}{2} |2a^2 - 2ab + b| + \frac{\sigma(1 + \frac{1}{4}\sigma)}{(1-\sigma)^2},$$

and when  $z \in \mathbf{R}_3 \cup \overline{\mathbf{R}}_3$   $\sigma$  is replaced by  $\nu\sigma$  and  $|z|^{-1}$  is replaced by  $\nu|z|^{-1}$  everywhere in (13.7.9).

For numerical values of  $\chi(n)$  see Table 9.7.1.

Corresponding error bounds for (13.7.2) can be constructed by combining (13.2.41) with (13.7.4)–(13.7.9).

**13.8 Asymptotic Approximations for Large Parameters**

**13.8(i) Large  $|b|$ , Fixed  $a$  and  $z$**

If  $b \rightarrow \infty$  in  $\mathbb{C}$  in such a way that  $|b + n| \geq \delta > 0$  for all  $n = 0, 1, 2, \dots$ , then

**13.8.1** 
$$M(a, b, z) = \sum_{s=0}^{n-1} \frac{(a)_s}{(b)_s s!} z^s + O(|b|^{-n}).$$

For fixed  $a$  and  $z$  in  $\mathbb{C}$

**13.8.2** 
$$M(a, b, z) \sim \frac{\Gamma(b)}{\Gamma(b-a)} \sum_{s=0}^{\infty} (a)_s q_s(z, a) b^{-s-a},$$

as  $b \rightarrow \infty$  in  $|\text{ph } b| \leq \pi - \delta$ , where  $q_0(z, a) = 1$  and

**13.8.3**

$$(e^t - 1)^{a-1} \exp(t + z(1 - e^{-t})) = \sum_{s=0}^{\infty} q_s(z, a) t^{s+a-1}.$$

When the foregoing results are combined with Kummer's transformation (13.2.39), an approximation is obtained for the case when  $|b|$  is large, and  $|b - a|$  and  $|z|$  are bounded.

**13.8(ii) Large  $b$  and  $z$ , Fixed  $a$  and  $b/z$**

Let  $\lambda = z/b > 0$  and  $\zeta = \sqrt{2(\lambda - 1 - \ln \lambda)}$  with  $\text{sign}(\zeta) = \text{sign}(\lambda - 1)$ . Then

---

**13.8.4** 
$$M(a, b, z) \sim b^{\frac{1}{2}a} e^{\frac{1}{4}\zeta^2 b} \left( \lambda \left( \frac{\lambda - 1}{\zeta} \right)^{a-1} U\left(a - \frac{1}{2}, -\zeta\sqrt{b}\right) + \left( \lambda \left( \frac{\lambda - 1}{\zeta} \right)^{a-1} - \left( \frac{\zeta}{\lambda - 1} \right)^a \right) \frac{U\left(a - \frac{3}{2}, -\zeta\sqrt{b}\right)}{\zeta\sqrt{b}} \right)$$

and

**13.8.5** 
$$U(a, b, z) \sim b^{-\frac{1}{2}a} e^{\frac{1}{4}\zeta^2 b} \left( \lambda \left( \frac{\lambda - 1}{\zeta} \right)^{a-1} U\left(a - \frac{1}{2}, \zeta\sqrt{b}\right) - \left( \lambda \left( \frac{\lambda - 1}{\zeta} \right)^{a-1} - \left( \frac{\zeta}{\lambda - 1} \right)^a \right) \frac{U\left(a - \frac{3}{2}, \zeta\sqrt{b}\right)}{\zeta\sqrt{b}} \right)$$

as  $b \rightarrow \infty$ , uniformly in compact  $\lambda$ -intervals of  $(0, \infty)$  and compact real  $a$ -intervals. For the parabolic cylinder function  $U$  see §12.2, and for an extension to an asymptotic expansion see Temme (1978).

Special cases are

**13.8.6** 
$$M(a, b, b) = \sqrt{\pi} \left( \frac{b}{2} \right)^{\frac{1}{2}a} \left( \frac{1}{\Gamma(\frac{1}{2}(a+1))} + \frac{(a+1)\sqrt{8/b}}{3\Gamma(\frac{1}{2}a)} + O\left(\frac{1}{b}\right) \right),$$

and

**13.8.7** 
$$U(a, b, b) = \sqrt{\pi} (2b)^{-\frac{1}{2}a} \left( \frac{1}{\Gamma(\frac{1}{2}(a+1))} - \frac{(a+1)\sqrt{8/b}}{3\Gamma(\frac{1}{2}a)} + O\left(\frac{1}{b}\right) \right).$$

To obtain approximations for  $M(a, b, z)$  and  $U(a, b, z)$  that hold as  $b \rightarrow \infty$ , with  $a > \frac{1}{2} - b$  and  $z > 0$  combine (13.14.4), (13.14.5) with §13.20(i).

Also, more complicated—but more powerful—uniform asymptotic approximations can be obtained by combining (13.14.4), (13.14.5) with §§13.20(iii) and 13.20(iv).

**13.8(iii) Large  $a$**

For the notation see §§10.2(ii), 10.25(ii), and 2.8(iv).

When  $a \rightarrow +\infty$  with  $b (\leq 1)$  fixed,

**13.8.8** 
$$U(a, b, x) = \frac{2e^{\frac{1}{2}x}}{\Gamma(a)} \left( \sqrt{\frac{2}{\beta} \tanh\left(\frac{w}{2}\right)} \left( \frac{1 - e^{-w}}{\beta} \right)^{-b} \beta^{1-b} K_{1-b}(2\beta a) + a^{-1} \left( \frac{a^{-1} + \beta}{1 + \beta} \right)^{1-b} e^{-2\beta a} O(1) \right),$$

where  $w = \text{arccosh}(1 + (2a)^{-1}x)$ , and  $\beta = (w + \sinh w)/2$ . (13.8.8) holds uniformly with respect to  $x \in [0, \infty)$ . For the case  $b > 1$  the transformation (13.2.40) can be used.

For an extension to an asymptotic expansion complete with error bounds see Temme (1990b), and for related results see §13.21(i).

When  $a \rightarrow -\infty$  with  $b (\geq 1)$  fixed,

**13.8.9** 
$$M(a, b, x) = \Gamma(b) e^{\frac{1}{2}x} \left( \left( \frac{1}{2}b - a \right) x \right)^{\frac{1}{2} - \frac{1}{2}b} \left( J_{b-1}\left(\sqrt{2x(b-2a)}\right) + \text{env } J_{b-1}\left(\sqrt{2x(b-2a)}\right) O\left(|a|^{-\frac{1}{2}}\right) \right),$$

and

$$\begin{aligned}
 U(a, b, x) = & \Gamma\left(\frac{1}{2}b - a + \frac{1}{2}\right) e^{\frac{1}{2}x} x^{\frac{1}{2} - \frac{1}{2}b} \left( \cos(a\pi) J_{b-1}\left(\sqrt{2x(b-2a)}\right) - \sin(a\pi) Y_{b-1}\left(\sqrt{2x(b-2a)}\right) \right. \\
 & \left. + \operatorname{env} Y_{b-1}\left(\sqrt{2x(b-2a)}\right) O\left(|a|^{-\frac{1}{2}}\right) \right),
 \end{aligned}$$

uniformly with respect to bounded positive values of  $x$  in each case.

For asymptotic approximations to  $M(a, b, x)$  and  $U(a, b, x)$  as  $a \rightarrow -\infty$  that hold uniformly with respect to  $x \in (0, \infty)$  and bounded positive values of  $(b-1)/|a|$ , combine (13.14.4), (13.14.5) with §§13.21(ii), 13.21(iii).

### 13.9 Zeros

#### 13.9(i) Zeros of $M(a, b, z)$

If  $a$  and  $b - a \neq 0, -1, -2, \dots$ , then  $M(a, b, z)$  has infinitely many  $z$ -zeros in  $\mathbb{C}$ . When  $a, b \in \mathbb{R}$  the number of real zeros is finite. Let  $p(a, b)$  be the number of positive zeros. Then

**13.9.1**  $p(a, b) = \lceil -a \rceil, \quad a < 0, b \geq 0,$

**13.9.2**  $p(a, b) = 0, \quad a \geq 0, b \geq 0,$

**13.9.3**  $p(a, b) = 1, \quad a \geq 0, -1 < b < 0,$

**13.9.4**  $p(a, b) = \lfloor -\frac{1}{2}b \rfloor - \lfloor -\frac{1}{2}(b+1) \rfloor, \quad a \geq 0, b \leq -1.$

**13.9.5**  $p(a, b) = \lceil -a \rceil - \lceil -b \rceil, \quad \lceil -a \rceil \geq \lceil -b \rceil, a < 0, b < 0,$

**13.9.6**  $p(a, b) = \lfloor \frac{1}{2}(\lceil -b \rceil - \lceil -a \rceil + 1) \rfloor - \lfloor \frac{1}{2}(\lceil -b \rceil - \lceil -a \rceil) \rfloor, \quad \lceil -b \rceil > \lceil -a \rceil > 0.$

The number of negative real zeros  $n(a, b)$  is given by

**13.9.7**  $n(a, b) = p(b - a, b).$

When  $a < 0$  and  $b > 0$  let  $\phi_r, r = 1, 2, 3, \dots$ , be the positive zeros of  $M(a, b, x)$  arranged in increasing order of magnitude, and let  $j_{b-1,r}$  be the  $r$ th positive zero of the Bessel function  $J_{b-1}(x)$  (§10.21(i)). Then

**13.9.8** 
$$\phi_r = \frac{j_{b-1,r}^2}{2b - 4a} \left( 1 + \frac{2b(b-2) + j_{b-1,r}^2}{3(2b - 4a)^2} \right) + O\left(\frac{1}{a^5}\right),$$

as  $a \rightarrow -\infty$  with  $r$  fixed.

Inequalities for  $\phi_r$  are given in Gatteschi (1990), and identities involving infinite series of all of the complex zeros of  $M(a, b, x)$  are given in Ahmed and Muldoon (1980).

For fixed  $a, b \in \mathbb{C}$  the large  $z$ -zeros of  $M(a, b, z)$  satisfy

**13.9.9** 
$$z = \pm(2n + a)\pi i + \ln\left(-\frac{\Gamma(a)}{\Gamma(b-a)} (\pm 2n\pi i)^{b-2a}\right) + O(n^{-1} \ln n),$$

where  $n$  is a large positive integer, and the logarithm takes its principal value (§4.2(i)).

Let  $P_\alpha$  denote the closure of the domain that is bounded by the parabola  $y^2 = 4\alpha(x + \alpha)$  and contains the origin. Then  $M(a, b, z)$  has no zeros in the regions  $P_{b/a}$ , if  $0 < b \leq a$ ;  $P_1$ , if  $1 \leq a \leq b$ ;  $P_\alpha$ , where  $\alpha = (2a - b + ab)/(a(a + 1))$ , if  $0 < a < 1$  and  $a \leq b < 2a/(1 - a)$ . The same results apply for the  $n$ th partial sums of the Maclaurin series (13.2.2) of  $M(a, b, z)$ .

More information on the location of real zeros can be found in Zarzo *et al.* (1995).

For fixed  $b$  and  $z$  in  $\mathbb{C}$  the large  $a$ -zeros of  $M(a, b, z)$  are given by

**13.9.10** 
$$a = -\frac{\pi^2}{4z} \left( n^2 + \left(b - \frac{3}{2}\right)n \right) - \frac{1}{16z} \left( \left(b - \frac{3}{2}\right)^2 \pi^2 + \frac{4}{3}z^2 - 8b(z - 1) - 4b^2 - 3 \right) + O(n^{-1}),$$

where  $n$  is a large positive integer.

For fixed  $a$  and  $z$  in  $\mathbb{C}$  the function  $M(a, b, z)$  has only a finite number of  $b$ -zeros.

#### 13.9(ii) Zeros of $U(a, b, z)$

For fixed  $a$  and  $b$  in  $\mathbb{C}$ ,  $U(a, b, z)$  has a finite number of  $z$ -zeros in the sector  $|\operatorname{ph} z| \leq \frac{3}{2}\pi - \delta (< \frac{3}{2}\pi)$ . Let  $T(a, b)$  be the total number of zeros in the sector  $|\operatorname{ph} z| < \pi$ ,  $P(a, b)$  be the corresponding number of positive zeros, and  $a, b$ , and  $a - b + 1$  be nonintegers. For the case  $b \leq 1$

**13.9.11**  $T(a, b) = \lceil -a \rceil + 1, \quad a < 0, \Gamma(a)\Gamma(a - b + 1) > 0,$

**13.9.12**  $T(a, b) = \lfloor -a \rfloor, \quad a < 0, \Gamma(a)\Gamma(a - b + 1) < 0,$

**13.9.13**  $T(a, b) = 0, \quad a > 0,$  and

**13.9.14**  $P(a, b) = \lceil b - a - 1 \rceil, \quad a + 1 < b,$

**13.9.15**  $P(a, b) = 0, \quad a + 1 \geq b.$

For the case  $b \geq 1$  we can use  $T(a, b) = T(a - b + 1, 2 - b)$  and  $P(a, b) = P(a - b + 1, 2 - b)$ .

In Wimp (1965) it is shown that if  $a, b \in \mathbb{R}$  and  $2a - b > -1$ , then  $U(a, b, z)$  has no zeros in the sector  $|\operatorname{ph} z| \leq \frac{1}{2}\pi$ .

Inequalities for the zeros of  $U(a, b, x)$  are given in Gatteschi (1990).

For fixed  $b$  and  $z$  in  $\mathbb{C}$  the large  $a$ -zeros of  $U(a, b, z)$  are given by

**13.9.16**

$$a \sim -n - \frac{2}{\pi} \sqrt{zn} - \frac{2z}{\pi^2} + \frac{1}{2}b + \frac{1}{4} + \frac{z^2 \left(\frac{1}{3} - 4\pi^{-2}\right) + z - (b-1)^2 + \frac{1}{4}}{4\pi\sqrt{zn}} + O\left(\frac{1}{n}\right),$$

where  $n$  is a large positive integer.

For fixed  $a$  and  $z$  in  $\mathbb{C}$ ,  $U(a, b, z)$  has two infinite strings of  $b$ -zeros that are asymptotic to the imaginary axis as  $|b| \rightarrow \infty$ .

### 13.10 Integrals

#### 13.10(i) Indefinite Integrals

When  $a \neq 1$ ,

**13.10.1**  $\int \mathbf{M}(a, b, z) dz = \frac{1}{a-1} \mathbf{M}(a-1, b-1, z),$

**13.10.2**  $\int U(a, b, z) dz = -\frac{1}{a-1} U(a-1, b-1, z).$

Other formulas of this kind can be constructed by inversion of the differentiation formulas given in §13.3(ii).

#### 13.10(ii) Laplace Transforms

For the notation see §§15.1, 15.2(i), and 10.25(ii).

**13.10.3**

$$\int_0^\infty e^{-zt} t^{b-1} \mathbf{M}(a, c, kt) dt = \Gamma(b) z^{-b} {}_2F_1(a, b; c; k/z),$$

$\Re b > 0, \Re z > \max(\Re k, 0),$

**13.10.4**  $\int_0^\infty e^{-zt} t^{b-1} \mathbf{M}(a, b, t) dt = z^{-b} \left(1 - \frac{1}{z}\right)^{-a},$

$\Re b > 0, \Re z > 1,$

**13.10.5**  $\int_0^\infty e^{-t} t^{b-1} \mathbf{M}(a, c, t) dt = \frac{\Gamma(b) \Gamma(c-a-b)}{\Gamma(c-a) \Gamma(c-b)},$

$\Re(c-a) > \Re b > 0,$

**13.10.6**

$$\int_0^\infty e^{-zt-t^2} t^{2b-2} \mathbf{M}(a, b, t^2) dt = \frac{1}{2} \pi^{-\frac{1}{2}} \Gamma\left(b - \frac{1}{2}\right) U\left(b - \frac{1}{2}, a + \frac{1}{2}, \frac{1}{4}z^2\right),$$

$\Re b > \frac{1}{2}, \Re z > 0,$

**13.10.7**

$$\int_0^\infty e^{-zt} t^{b-1} U(a, c, t) dt = \Gamma(b) \Gamma(b-c+1) \times z^{-b} {}_2F_1\left(a, b; a+b-c+1; 1 - \frac{1}{z}\right),$$

$\Re b > \max(\Re c - 1, 0), \Re z > 0.$

#### Loop Integrals

**13.10.8**

$$\frac{1}{2\pi i} \int_{-\infty}^{(0+)} e^{tz} t^{-a} \mathbf{M}(a, b, y/t) dt = \frac{1}{\Gamma(a)} z^{\frac{1}{2}(2a-b-1)} y^{\frac{1}{2}(1-b)} I_{b-1}(2\sqrt{zy}),$$

$\Re z > 0.$

**13.10.9**

$$\frac{1}{2\pi i} \int_{-\infty}^{(0+)} e^{tz} t^{-a} U(a, b, y/t) dt = \frac{2z^{\frac{1}{2}(2a-b-1)} y^{\frac{1}{2}(1-b)}}{\Gamma(a) \Gamma(a-b+1)} K_{b-1}(2\sqrt{zy}),$$

$\Re z > 0.$

For additional Laplace transforms see Erdélyi *et al.* (1954a, §§4.22, 5.20), Oberhettinger and Badii (1973, §1.17), and Prudnikov *et al.* (1992a, §§3.34, 3.35). Inverse Laplace transforms are given in Oberhettinger and Badii (1973, §2.16) and Prudnikov *et al.* (1992b, §§3.33, 3.34).

#### 13.10(iii) Mellin Transforms

**13.10.10**

$$\int_0^\infty t^{\lambda-1} \mathbf{M}(a, b, -t) dt = \frac{\Gamma(\lambda) \Gamma(a-\lambda)}{\Gamma(a) \Gamma(b-\lambda)}, \quad 0 < \Re \lambda < \Re a,$$

**13.10.11**

$$\int_0^\infty t^{\lambda-1} U(a, b, t) dt = \frac{\Gamma(\lambda) \Gamma(a-\lambda) \Gamma(\lambda-b+1)}{\Gamma(a) \Gamma(a-b+1)},$$

$\max(\Re b - 1, 0) < \Re \lambda < \Re a.$

For additional Mellin transforms see Erdélyi *et al.* (1954a, §§6.9, 7.5), Marichev (1983, pp. 283–287), and Oberhettinger (1974, §§1.13, 2.8).

#### 13.10(iv) Fourier Transforms

**13.10.12**

$$\int_0^\infty \cos(2xt) \mathbf{M}(a, b, -t^2) dt = \frac{\sqrt{\pi}}{2\Gamma(a)} x^{2a-1} e^{-x^2} U\left(b - \frac{1}{2}, a + \frac{1}{2}, x^2\right),$$

$\Re a > 0.$

For additional Fourier transforms see Erdélyi *et al.* (1954a, §§1.14, 2.14, 3.3) and Oberhettinger (1990, §§1.22, 2.22).

#### 13.10(v) Hankel Transforms

For the notation see §10.2(ii).

**13.10.13**

$$\int_0^\infty e^{-t} t^{b-1-\frac{1}{2}\nu} \mathbf{M}(a, b, t) J_\nu(2\sqrt{xt}) dt = x^{-a+\frac{1}{2}\nu} e^{-x} \mathbf{M}(\nu-b+1, \nu-a+1, x),$$

$x > 0, 2\Re a < \Re \nu + \frac{5}{2}, \Re b > 0,$

**13.10.14**

$$\int_0^\infty e^{-t} t^{\frac{1}{2}\nu} \mathbf{M}(a, b, t) J_\nu(2\sqrt{xt}) dt = \frac{x^{\frac{1}{2}\nu} e^{-x}}{\Gamma(b-a)} U(a, a-b+\nu+2, x),$$

$x > 0, -1 < \Re \nu < 2\Re(b-a) - \frac{1}{2},$

13.10.15

$$\int_0^\infty t^{\frac{1}{2}\nu} U(a, b, t) J_\nu(2\sqrt{xt}) dt \\ = \frac{\Gamma(\nu - b + 2)}{\Gamma(a)} x^{\frac{1}{2}\nu} U(\nu - b + 2, \nu - a + 2, x), \\ x > 0, \max(\Re b - 2, -1) < \Re \nu < 2\Re a + \frac{1}{2},$$

13.10.16

$$\int_0^\infty e^{-t} t^{\frac{1}{2}\nu} U(a, b, t) J_\nu(2\sqrt{xt}) dt \\ = \Gamma(\nu - b + 2) x^{\frac{1}{2}\nu} e^{-x} \mathbf{M}(a, a - b + \nu + 2, x), \\ x > 0, \max(\Re b - 2, -1) < \Re \nu.$$

For additional Hankel transforms and also other Bessel transforms see Erdélyi *et al.* (1954b, §8.18) and Oberhettinger (1972, §§1.16 and 3.4.42–46, 4.4.45–47, 5.94–97).

### 13.10(vi) Other Integrals

For integral transforms in terms of Whittaker functions see §13.23(iv). Additional integrals can be found in Apelblat (1983, pp. 388–392), Erdélyi *et al.* (1954b), Gradshteyn and Ryzhik (2000, §7.6), Magnus *et al.* (1966, §6.1.2), Prudnikov *et al.* (1990, §§1.13, 1.14, 2.19, 4.2.2), Prudnikov *et al.* (1992a, §§3.35, 3.36), and Prudnikov *et al.* (1992b, §§3.33, 3.34). See also (13.4.2), (13.4.5), (13.4.6).

### 13.11 Series

For  $z \in \mathbb{C}$ ,

$$M(a, b, z) = \Gamma(a - \frac{1}{2}) e^{\frac{1}{2}z} \left(\frac{1}{4}z\right)^{\frac{1}{2}-a} \\ \times \sum_{s=0}^{\infty} \frac{(2a-1)_s (2a-b)_s}{(b)_s s!} \\ \times \left(a - \frac{1}{2} + s\right) I_{a-\frac{1}{2}+s}\left(\frac{1}{2}z\right), \\ a + \frac{1}{2}, b \neq 0, -1, -2, \dots$$

(13.6.9) is a special case.

For additional expansions combine (13.14.4), (13.14.5), and §13.24. For other series expansions see Hansen (1975, §§66 and 87), Prudnikov *et al.* (1990, §6.6), and Tricomi (1954, §1.8). See also §13.13.

### 13.12 Products

13.12.1

$$M(a, b, z) M(-a, -b, -z) \\ + \frac{a(a-b)z^2}{b^2(1-b^2)} M(1+a, 2+b, z) M(1-a, 2-b, -z) = 1.$$

For generalizations of this quadratic relation see Majima *et al.* (2000).

For integral representations, integrals, and series containing products of  $M(a, b, z)$  and  $U(a, b, z)$  see Erdélyi *et al.* (1953a, §6.15.3).

## 13.13 Addition and Multiplication Theorems

### 13.13(i) Addition Theorems for $M(a, b, z)$

The function  $M(a, b, x+y)$  has the following expansions:

$$13.13.1 \quad \sum_{n=0}^{\infty} \frac{(a)_n y^n}{(b)_n n!} M(a+n, b+n, x),$$

13.13.2

$$\left(\frac{x+y}{x}\right)^{1-b} \sum_{n=0}^{\infty} \frac{(1-b)_n (-y/x)^n}{n!} M(a, b-n, x), \\ |y| < |x|,$$

13.13.3

$$\left(\frac{x}{x+y}\right)^a \sum_{n=0}^{\infty} \frac{(a)_n y^n}{n!(x+y)^n} M(a+n, b, x), \quad \Re(y/x) > -\frac{1}{2},$$

$$13.13.4 \quad e^y \sum_{n=0}^{\infty} \frac{(b-a)_n (-y)^n}{(b)_n n!} M(a, b+n, x),$$

$$e^y \left(\frac{x}{x+y}\right)^{b-a} \sum_{n=0}^{\infty} \frac{(b-a)_n y^n}{n!(x+y)^n} \\ \times M(a-n, b, x), \quad \Re((y+x)/x) > \frac{1}{2},$$

13.13.5

$$e^y \left(\frac{x+y}{x}\right)^{1-b} \sum_{n=0}^{\infty} \frac{(1-b)_n (-y)^n}{n! x^n} \\ \times M(a-n, b-n, x), \quad |y| < |x|.$$

13.13.6

### 13.13(ii) Addition Theorems for $U(a, b, z)$

The function  $U(a, b, x+y)$  has the following expansions:

$$13.13.7 \quad \sum_{n=0}^{\infty} \frac{(a)_n (-y)^n}{n!} U(a+n, b+n, x), \quad |y| < |x|,$$

13.13.8

$$\left(\frac{x+y}{x}\right)^{1-b} \sum_{n=0}^{\infty} \frac{(1+a-b)_n (-y/x)^n}{n!} U(a, b-n, x), \\ |y| < |x|,$$

13.13.9

$$\left(\frac{x}{x+y}\right)^a \sum_{n=0}^{\infty} \frac{(a)_n (1+a-b)_n y^n}{n!(x+y)^n} U(a+n, b, x), \\ \Re(y/x) > -\frac{1}{2},$$

$$13.13.10 \quad e^y \sum_{n=0}^{\infty} \frac{(-y)^n}{n!} U(a, b+n, x), \quad |y| < |x|,$$

$$13.13.11 \quad e^y \left(\frac{x}{x+y}\right)^{b-a} \sum_{n=0}^{\infty} \frac{(-y)^n}{n!(x+y)^n} U(a-n, b, x), \\ \Re(y/x) > -\frac{1}{2},$$

13.13.12

$$e^y \left(\frac{x+y}{x}\right)^{1-b} \sum_{n=0}^{\infty} \frac{(-y)^n}{n! x^n} U(a-n, b-n, x), \quad |y| < |x|.$$

**13.13(iii) Multiplication Theorems for  $M(a, b, z)$  and  $U(a, b, z)$**

To obtain similar expansions for  $M(a, b, xy)$  and  $U(a, b, xy)$ , replace  $y$  in the previous two subsections by  $(y - 1)x$ .

**Whittaker Functions**

**13.14 Definitions and Basic Properties**

**13.14(i) Differential Equation**

**Whittaker's Equation**

**13.14.1** 
$$\frac{d^2W}{dz^2} + \left(-\frac{1}{4} + \frac{\kappa}{z} + \frac{\frac{1}{4} - \mu^2}{z^2}\right)W = 0.$$

This equation is obtained from Kummer's equation (13.2.1) via the substitutions  $W = e^{-\frac{1}{2}z}z^{\frac{1}{2}+\mu}w$ ,  $\kappa = \frac{1}{2}b - a$ , and  $\mu = \frac{1}{2}b - \frac{1}{2}$ . It has a regular singularity at the origin with indices  $\frac{1}{2} \pm \mu$ , and an irregular singularity at infinity of rank one.

**Standard Solutions**

Standard solutions are:

**13.14.2**  $M_{\kappa,\mu}(z) = e^{-\frac{1}{2}z}z^{\frac{1}{2}+\mu}M\left(\frac{1}{2} + \mu - \kappa, 1 + 2\mu, z\right),$

**13.14.3**  $W_{\kappa,\mu}(z) = e^{-\frac{1}{2}z}z^{\frac{1}{2}+\mu}U\left(\frac{1}{2} + \mu - \kappa, 1 + 2\mu, z\right),$   
 except that  $M_{\kappa,\mu}(z)$  does not exist when  $2\mu = -1, -2, -3, \dots$

Conversely,

**13.14.4**  $M(a, b, z) = e^{\frac{1}{2}z}z^{-\frac{1}{2}b}M_{\frac{1}{2}b-a, \frac{1}{2}b-\frac{1}{2}}(z),$

**13.14.5**  $U(a, b, z) = e^{\frac{1}{2}z}z^{-\frac{1}{2}b}W_{\frac{1}{2}b-a, \frac{1}{2}b-\frac{1}{2}}(z).$

The series

**13.14.6**

$$M_{\kappa,\mu}(z) = e^{-\frac{1}{2}z}z^{\frac{1}{2}+\mu} \sum_{s=0}^{\infty} \frac{\left(\frac{1}{2} + \mu - \kappa\right)_s}{(1 + 2\mu)_s s!} z^s$$

$$= z^{\frac{1}{2}+\mu} \sum_{n=0}^{\infty} {}_2F_1\left(\begin{matrix} -n, \frac{1}{2} + \mu - \kappa \\ 1 + 2\mu \end{matrix}; 2\right) \frac{\left(-\frac{1}{2}z\right)^n}{n!},$$

$2\mu \neq -1, -2, -3, \dots,$

converge for all  $z \in \mathbb{C}$ .

In general  $M_{\kappa,\mu}(z)$  and  $W_{\kappa,\mu}(z)$  are many-valued functions of  $z$  with branch points at  $z = 0$  and  $z = \infty$ . The *principal branches* correspond to the principal branches of the functions  $z^{\frac{1}{2}+\mu}$  and  $U\left(\frac{1}{2} + \mu - \kappa, 1 + 2\mu, z\right)$  on the right-hand sides of the equations (13.14.2) and (13.14.3); compare §4.2(i).

Although  $M_{\kappa,\mu}(z)$  does not exist when  $2\mu = -1, -2, -3, \dots$ , many formulas containing  $M_{\kappa,\mu}(z)$  continue to apply in their limiting form. For example, if  $n = 0, 1, 2, \dots$ , then

**13.14.7**

$$\lim_{2\mu \rightarrow -n-1} \frac{M_{\kappa,\mu}(z)}{\Gamma(2\mu + 1)} = \frac{\left(-\frac{1}{2}n - \kappa\right)_{n+1}}{(n + 1)!} M_{\kappa, \frac{1}{2}(n+1)}(z)$$

$$= e^{-\frac{1}{2}z}z^{-\frac{1}{2}n} \sum_{s=n+1}^{\infty} \frac{\left(-\frac{1}{2}n - \kappa\right)_s}{\Gamma(s - n)s!} z^s.$$

If  $2\mu = \pm n$ , where  $n = 0, 1, 2, \dots$ , then

$$W_{\kappa, \pm \frac{1}{2}n}(z) = \frac{(-1)^n e^{-\frac{1}{2}z} z^{\frac{1}{2}n + \frac{1}{2}}}{n! \Gamma\left(\frac{1}{2} - \frac{1}{2}n - \kappa\right)} \left( \sum_{k=1}^n \frac{n!(k-1)!}{(n-k)! \left(\kappa + \frac{1}{2} - \frac{1}{2}n\right)_k} z^{-k} \right.$$

$$\left. - \sum_{k=0}^{\infty} \frac{\left(\frac{1}{2}n + \frac{1}{2} - \kappa\right)_k}{(n+1)_k k!} z^k \left( \ln z + \psi\left(\frac{1}{2}n + \frac{1}{2} - \kappa + k\right) - \psi(1+k) - \psi(n+1+k) \right) \right),$$

$\kappa - \frac{1}{2}n - \frac{1}{2} \neq 0, 1, 2, \dots,$

or

**13.14.9**

$$W_{\kappa, \pm \frac{1}{2}n}(z) = (-1)^{\kappa - \frac{1}{2}n - \frac{1}{2}} e^{-\frac{1}{2}z} z^{\frac{1}{2}n + \frac{1}{2}} \sum_{k=0}^{\kappa - \frac{1}{2}n - \frac{1}{2}} \binom{\kappa - \frac{1}{2}n - \frac{1}{2}}{k} (n+1+k)_{\kappa - k - \frac{1}{2}n - \frac{1}{2}} (-z)^k, \quad \kappa - \frac{1}{2}n - \frac{1}{2} = 0, 1, 2, \dots$$

**13.14(ii) Analytic Continuation**

**13.14.10**

$$M_{\kappa,\mu}(ze^{\pm\pi i}) = \pm i e^{\pm\mu\pi i} M_{-\kappa,\mu}(z).$$

In (13.14.11)–(13.14.13)  $m$  is any integer.

**13.14.11**

$$M_{\kappa,\mu}(ze^{2m\pi i}) = (-1)^m e^{2m\mu\pi i} M_{\kappa,\mu}(z).$$

$$13.14.12 \quad W_{\kappa,\mu}(ze^{2m\pi i}) = \frac{(-1)^{m+1}2\pi i \sin(2\pi\mu m)}{\Gamma(\frac{1}{2} - \mu - \kappa) \Gamma(1 + 2\mu) \sin(2\pi\mu)} M_{\kappa,\mu}(z) + (-1)^m e^{-2m\mu\pi i} W_{\kappa,\mu}(z).$$

$$13.14.13 \quad (-1)^m W_{\kappa,\mu}(ze^{2m\pi i}) = -\frac{e^{2\kappa\pi i} \sin(2m\mu\pi) + \sin((2m-2)\mu\pi)}{\sin(2\mu\pi)} W_{\kappa,\mu}(z) \\ - \frac{\sin(2m\mu\pi)2\pi i e^{\kappa\pi i}}{\sin(2\mu\pi) \Gamma(\frac{1}{2} + \mu - \kappa) \Gamma(\frac{1}{2} - \mu - \kappa)} W_{-\kappa,\mu}(ze^{\pi i}).$$

Except when  $z = 0$ , each branch of the functions  $M_{\kappa,\mu}(z)/\Gamma(2\mu + 1)$  and  $W_{\kappa,\mu}(z)$  is entire in  $\kappa$  and  $\mu$ . Also, unless specified otherwise  $M_{\kappa,\mu}(z)$  and  $W_{\kappa,\mu}(z)$  are assumed to have their principal values.

**13.14(iii) Limiting Forms as  $z \rightarrow 0$**

$$13.14.14 \quad M_{\kappa,\mu}(z) = z^{\mu+\frac{1}{2}}(1 + O(z)), \quad 2\mu \neq -1, -2, -3, \dots$$

In cases when  $\frac{1}{2} - \kappa \pm \mu = -n$ , where  $n$  is a nonnegative integer,

$$13.14.15 \quad W_{\frac{1}{2}\pm\mu+n,\mu}(z) = (-1)^n (1 \pm 2\mu)_n z^{\frac{1}{2}\pm\mu} + O(z^{\frac{3}{2}\pm\mu}).$$

In all other cases

$$13.14.16 \quad W_{\kappa,\mu}(z) = \frac{\Gamma(2\mu)}{\Gamma(\frac{1}{2} + \mu - \kappa)} z^{\frac{1}{2}-\mu} + O(z^{\frac{3}{2}-\Re\mu}), \\ \Re\mu \geq \frac{1}{2}, \mu \neq \frac{1}{2},$$

$$13.14.17 \quad W_{\kappa,\frac{1}{2}}(z) = \frac{1}{\Gamma(1 - \kappa)} + O(z \ln z),$$

$$13.14.18 \quad W_{\kappa,\mu}(z) = \frac{\Gamma(2\mu)}{\Gamma(\frac{1}{2} + \mu - \kappa)} z^{\frac{1}{2}-\mu} + \frac{\Gamma(-2\mu)}{\Gamma(\frac{1}{2} - \mu - \kappa)} z^{\frac{1}{2}+\mu} \\ + O(z^{\frac{3}{2}-\Re\mu}), \quad 0 \leq \Re\mu < \frac{1}{2}, \mu \neq 0,$$

$$13.14.19 \quad W_{\kappa,0}(z) = -\frac{\sqrt{z}}{\Gamma(\frac{1}{2} - \kappa)} (\ln z + \psi(\frac{1}{2} - \kappa) + 2\gamma) \\ + O(z^{3/2} \ln z).$$

For  $W_{\kappa,\mu}(z)$  with  $\Re\mu < 0$  use (13.14.31).

**13.14(iv) Limiting Forms as  $z \rightarrow \infty$**

Except when  $\mu - \kappa = -\frac{1}{2}, -\frac{3}{2}, \dots$  (polynomial cases),

$$13.14.20 \quad M_{\kappa,\mu}(z) \sim \Gamma(1 + 2\mu) e^{\frac{1}{2}z} z^{-\kappa} / \Gamma(\frac{1}{2} + \mu - \kappa), \\ |\text{ph } z| \leq \frac{1}{2}\pi - \delta,$$

where  $\delta$  is an arbitrary small positive constant. Also,

$$13.14.21 \quad W_{\kappa,\mu}(z) \sim e^{-\frac{1}{2}z} z^\kappa, \quad |\text{ph } z| \leq \frac{3}{2}\pi - \delta.$$

**13.14(v) Numerically Satisfactory Solutions**

Fundamental pairs of solutions of (13.14.1) that are numerically satisfactory (§2.7(iv)) in the neighborhood of infinity are

$$13.14.22 \quad W_{\kappa,\mu}(z), \quad W_{-\kappa,\mu}(e^{-\pi i} z), \quad -\frac{1}{2}\pi \leq \text{ph } z \leq \frac{3}{2}\pi,$$

$$13.14.23 \quad W_{\kappa,\mu}(z), \quad W_{-\kappa,\mu}(e^{\pi i} z), \quad -\frac{3}{2}\pi \leq \text{ph } z \leq \frac{1}{2}\pi.$$

A fundamental pair of solutions that is numerically satisfactory in the sector  $|\text{ph } z| \leq \pi$  near the origin is

$$13.14.24 \quad M_{\kappa,\mu}(z), \quad M_{\kappa,-\mu}(z), \quad 2\mu \notin \mathbb{Z}.$$

When  $2\mu$  is an integer we may use the results of §13.2(v) with the substitutions  $b = 2\mu + 1$ ,  $a = \mu - \kappa + \frac{1}{2}$ , and  $W = e^{-\frac{1}{2}z} z^{\frac{1}{2}+\mu} w$ , where  $W$  is the solution of (13.14.1) corresponding to the solution  $w$  of (13.2.1).

**13.14(vi) Wronskians**

$$13.14.25 \quad \mathscr{W} \{M_{\kappa,\mu}(z), M_{\kappa,-\mu}(z)\} = -2\mu,$$

$$13.14.26 \quad \mathscr{W} \{M_{\kappa,\mu}(z), W_{\kappa,\mu}(z)\} = -\frac{\Gamma(1 + 2\mu)}{\Gamma(\frac{1}{2} + \mu - \kappa)},$$

$$13.14.27 \quad \mathscr{W} \{M_{\kappa,\mu}(z), W_{-\kappa,\mu}(e^{\pm\pi i} z)\} = \frac{\Gamma(1 + 2\mu)}{\Gamma(\frac{1}{2} + \mu + \kappa)} e^{\mp(\frac{1}{2}+\mu)\pi i},$$

$$13.14.28 \quad \mathscr{W} \{M_{\kappa,-\mu}(z), W_{\kappa,\mu}(z)\} = -\frac{\Gamma(1 - 2\mu)}{\Gamma(\frac{1}{2} - \mu - \kappa)},$$

$$\mathscr{W} \{M_{\kappa,-\mu}(z), W_{-\kappa,\mu}(e^{\pm\pi i} z)\} \\ 13.14.29 \quad = \frac{\Gamma(1 - 2\mu)}{\Gamma(\frac{1}{2} - \mu + \kappa)} e^{\mp(\frac{1}{2}-\mu)\pi i},$$

$$13.14.30 \quad \mathscr{W} \{W_{\kappa,\mu}(z), W_{-\kappa,\mu}(e^{\pm\pi i} z)\} = e^{\mp\kappa\pi i}.$$

**13.14(vii) Connection Formulas**

$$13.14.31 \quad W_{\kappa,\mu}(z) = W_{\kappa,-\mu}(z).$$

$$13.14.32 \quad \frac{1}{\Gamma(1 + 2\mu)} M_{\kappa,\mu}(z) = \frac{e^{\pm(\kappa-\mu-\frac{1}{2})\pi i}}{\Gamma(\frac{1}{2} + \mu + \kappa)} W_{\kappa,\mu}(z) \\ + \frac{e^{\pm\kappa\pi i}}{\Gamma(\frac{1}{2} + \mu - \kappa)} W_{-\kappa,\mu}(e^{\pm\pi i} z).$$

When  $2\mu$  is not an integer

$$13.14.33 \quad W_{\kappa,\mu}(z) = \frac{\Gamma(-2\mu)}{\Gamma(\frac{1}{2} - \mu - \kappa)} M_{\kappa,\mu}(z) \\ + \frac{\Gamma(2\mu)}{\Gamma(\frac{1}{2} + \mu - \kappa)} M_{\kappa,-\mu}(z).$$



### 13.15 Recurrence Relations and Derivatives

#### 13.15(i) Recurrence Relations

$$13.15.1 \quad (\kappa - \mu - \frac{1}{2}) M_{\kappa-1, \mu}(z) + (z - 2\kappa) M_{\kappa, \mu}(z) + (\kappa + \mu + \frac{1}{2}) M_{\kappa+1, \mu}(z) = 0,$$

$$13.15.2 \quad 2\mu(1 + 2\mu)\sqrt{z} M_{\kappa-\frac{1}{2}, \mu-\frac{1}{2}}(z) - (z + 2\mu)(1 + 2\mu) M_{\kappa, \mu}(z) + (\kappa + \mu + \frac{1}{2})\sqrt{z} M_{\kappa+\frac{1}{2}, \mu+\frac{1}{2}}(z) = 0,$$

$$13.15.3 \quad (\kappa - \mu - \frac{1}{2}) M_{\kappa-\frac{1}{2}, \mu+\frac{1}{2}}(z) + (1 + 2\mu)\sqrt{z} M_{\kappa, \mu}(z) - (\kappa + \mu + \frac{1}{2}) M_{\kappa+\frac{1}{2}, \mu+\frac{1}{2}}(z) = 0,$$

$$13.15.4 \quad 2\mu M_{\kappa-\frac{1}{2}, \mu-\frac{1}{2}}(z) - 2\mu M_{\kappa+\frac{1}{2}, \mu-\frac{1}{2}}(z) - \sqrt{z} M_{\kappa, \mu}(z) = 0,$$

$$13.15.5 \quad 2\mu(1 + 2\mu) M_{\kappa, \mu}(z) - 2\mu(1 + 2\mu)\sqrt{z} M_{\kappa-\frac{1}{2}, \mu-\frac{1}{2}}(z) - (\kappa - \mu - \frac{1}{2})\sqrt{z} M_{\kappa-\frac{1}{2}, \mu+\frac{1}{2}}(z) = 0,$$

$$13.15.6 \quad 2\mu(1 + 2\mu)\sqrt{z} M_{\kappa+\frac{1}{2}, \mu-\frac{1}{2}}(z) + (z - 2\mu)(1 + 2\mu) M_{\kappa, \mu}(z) + (\kappa - \mu - \frac{1}{2})\sqrt{z} M_{\kappa-\frac{1}{2}, \mu+\frac{1}{2}}(z) = 0,$$

$$13.15.7 \quad 2\mu(1 + 2\mu)\sqrt{z} M_{\kappa+\frac{1}{2}, \mu-\frac{1}{2}}(z) - 2\mu(1 + 2\mu) M_{\kappa, \mu}(z) + (\kappa + \mu + \frac{1}{2})\sqrt{z} M_{\kappa+\frac{1}{2}, \mu+\frac{1}{2}}(z) = 0.$$

$$13.15.8 \quad W_{\kappa+\frac{1}{2}, \mu+\frac{1}{2}}(z) - \sqrt{z} W_{\kappa, \mu}(z) + (\kappa - \mu - \frac{1}{2}) W_{\kappa-\frac{1}{2}, \mu+\frac{1}{2}}(z) = 0,$$

$$13.15.9 \quad W_{\kappa+\frac{1}{2}, \mu-\frac{1}{2}}(z) - \sqrt{z} W_{\kappa, \mu}(z) + (\kappa + \mu - \frac{1}{2}) W_{\kappa-\frac{1}{2}, \mu-\frac{1}{2}}(z) = 0,$$

$$13.15.10 \quad 2\mu W_{\kappa, \mu}(z) - \sqrt{z} W_{\kappa+\frac{1}{2}, \mu+\frac{1}{2}}(z) + \sqrt{z} W_{\kappa+\frac{1}{2}, \mu-\frac{1}{2}}(z) = 0,$$

$$13.15.11 \quad W_{\kappa+1, \mu}(z) + (2\kappa - z) W_{\kappa, \mu}(z) + (\kappa - \mu - \frac{1}{2})(\kappa + \mu - \frac{1}{2}) W_{\kappa-1, \mu}(z) = 0,$$

$$13.15.12 \quad (\kappa - \mu - \frac{1}{2})\sqrt{z} W_{\kappa-\frac{1}{2}, \mu+\frac{1}{2}}(z) + 2\mu W_{\kappa, \mu}(z) - (\kappa + \mu - \frac{1}{2})\sqrt{z} W_{\kappa-\frac{1}{2}, \mu-\frac{1}{2}}(z) = 0,$$

$$13.15.13 \quad (\kappa + \mu - \frac{1}{2})\sqrt{z} W_{\kappa-\frac{1}{2}, \mu-\frac{1}{2}}(z) - (z + 2\mu) W_{\kappa, \mu}(z) + \sqrt{z} W_{\kappa+\frac{1}{2}, \mu+\frac{1}{2}}(z) = 0,$$

$$13.15.14 \quad (\kappa - \mu - \frac{1}{2})\sqrt{z} W_{\kappa-\frac{1}{2}, \mu+\frac{1}{2}}(z) - (z - 2\mu) W_{\kappa, \mu}(z) + \sqrt{z} W_{\kappa+\frac{1}{2}, \mu-\frac{1}{2}}(z) = 0.$$

#### 13.15(ii) Differentiation Formulas

$$13.15.15 \quad \frac{d^n}{dz^n} \left( e^{\frac{1}{2}z} z^{\mu-\frac{1}{2}} M_{\kappa, \mu}(z) \right) = (-1)^n (-2\mu)_n e^{\frac{1}{2}z} z^{\mu-\frac{1}{2}(n+1)} M_{\kappa-\frac{1}{2}n, \mu-\frac{1}{2}n}(z),$$

$$13.15.16 \quad \frac{d^n}{dz^n} \left( e^{\frac{1}{2}z} z^{-\mu-\frac{1}{2}} M_{\kappa, \mu}(z) \right) = \frac{(\frac{1}{2} + \mu - \kappa)_n}{(1 + 2\mu)_n} e^{\frac{1}{2}z} z^{-\mu-\frac{1}{2}(n+1)} M_{\kappa-\frac{1}{2}n, \mu+\frac{1}{2}n}(z),$$

$$13.15.17 \quad \left( z \frac{d}{dz} z \right)^n \left( e^{\frac{1}{2}z} z^{-\kappa-1} M_{\kappa, \mu}(z) \right) = \left( \frac{1}{2} + \mu - \kappa \right)_n e^{\frac{1}{2}z} z^{n-\kappa-1} M_{\kappa-n, \mu}(z),$$

$$13.15.18 \quad \frac{d^n}{dz^n} \left( e^{-\frac{1}{2}z} z^{\mu-\frac{1}{2}} M_{\kappa, \mu}(z) \right) = (-1)^n (-2\mu)_n e^{-\frac{1}{2}z} z^{\mu-\frac{1}{2}(n+1)} M_{\kappa+\frac{1}{2}n, \mu-\frac{1}{2}n}(z),$$

$$13.15.19 \quad \frac{d^n}{dz^n} \left( e^{-\frac{1}{2}z} z^{-\mu-\frac{1}{2}} M_{\kappa, \mu}(z) \right) = (-1)^n \frac{(\frac{1}{2} + \mu + \kappa)_n}{(1 + 2\mu)_n} e^{-\frac{1}{2}z} z^{-\mu-\frac{1}{2}(n+1)} M_{\kappa+\frac{1}{2}n, \mu+\frac{1}{2}n}(z),$$

$$13.15.20 \quad \left( z \frac{d}{dz} z \right)^n \left( e^{-\frac{1}{2}z} z^{\kappa-1} M_{\kappa, \mu}(z) \right) = \left( \frac{1}{2} + \mu + \kappa \right)_n e^{-\frac{1}{2}z} z^{\kappa+n-1} M_{\kappa+n, \mu}(z).$$

$$13.15.21 \quad \frac{d^n}{dz^n} \left( e^{\frac{1}{2}z} z^{-\mu-\frac{1}{2}} W_{\kappa, \mu}(z) \right) = (-1)^n \left( \frac{1}{2} + \mu - \kappa \right)_n e^{\frac{1}{2}z} z^{-\mu-\frac{1}{2}(n+1)} W_{\kappa-\frac{1}{2}n, \mu+\frac{1}{2}n}(z),$$

$$13.15.22 \quad \frac{d^n}{dz^n} \left( e^{\frac{1}{2}z} z^{\mu-\frac{1}{2}} W_{\kappa, \mu}(z) \right) = (-1)^n \left( \frac{1}{2} - \mu - \kappa \right)_n e^{\frac{1}{2}z} z^{\mu-\frac{1}{2}(n+1)} W_{\kappa-\frac{1}{2}n, \mu-\frac{1}{2}n}(z),$$

$$13.15.23 \quad \left( z \frac{d}{dz} z \right)^n \left( e^{\frac{1}{2}z} z^{-\kappa-1} W_{\kappa, \mu}(z) \right) = \left( \frac{1}{2} + \mu - \kappa \right)_n \left( \frac{1}{2} - \mu - \kappa \right)_n e^{\frac{1}{2}z} z^{n-\kappa-1} W_{\kappa-n, \mu}(z),$$

$$13.15.24 \quad \frac{d^n}{dz^n} \left( e^{-\frac{1}{2}z} z^{-\mu-\frac{1}{2}} W_{\kappa, \mu}(z) \right) = (-1)^n e^{-\frac{1}{2}z} z^{-\mu-\frac{1}{2}(n+1)} W_{\kappa+\frac{1}{2}n, \mu+\frac{1}{2}n}(z),$$

$$13.15.25 \quad \frac{d^n}{dz^n} \left( e^{-\frac{1}{2}z} z^{\mu-\frac{1}{2}} W_{\kappa, \mu}(z) \right) = (-1)^n e^{-\frac{1}{2}z} z^{\mu-\frac{1}{2}(n+1)} W_{\kappa+\frac{1}{2}n, \mu-\frac{1}{2}n}(z),$$

$$13.15.26 \quad \left( z \frac{d}{dz} z \right)^n \left( e^{-\frac{1}{2}z} z^{\kappa-1} W_{\kappa, \mu}(z) \right) = (-1)^n e^{-\frac{1}{2}z} z^{\kappa+n-1} W_{\kappa+n, \mu}(z).$$

Other versions of several of the identities in this subsection can be constructed by use of (13.3.29).

### 13.16 Integral Representations

#### 13.16(i) Integrals Along the Real Line

In this subsection see §§10.2(ii), 10.25(ii) for the functions  $J_{2\mu}$ ,  $I_{2\mu}$ , and  $K_{2\mu}$ , and §§15.1, 15.2(i) for  ${}_2F_1$ .

$$13.16.1 \quad M_{\kappa,\mu}(z) = \frac{\Gamma(1+2\mu)z^{\mu+\frac{1}{2}}2^{-2\mu}}{\Gamma(\frac{1}{2}+\mu-\kappa)\Gamma(\frac{1}{2}+\mu+\kappa)} \int_{-1}^1 e^{\frac{1}{2}zt}(1+t)^{\mu-\frac{1}{2}-\kappa}(1-t)^{\mu-\frac{1}{2}+\kappa} dt, \quad \Re\mu + \frac{1}{2} > |\Re\kappa|,$$

$$13.16.2 \quad M_{\kappa,\mu}(z) = \frac{\Gamma(1+2\mu)z^\lambda}{\Gamma(1+2\mu-2\lambda)\Gamma(2\lambda)} \int_0^1 M_{\kappa-\lambda,\mu-\lambda}(zt)e^{\frac{1}{2}z(t-1)}t^{\mu-\lambda-\frac{1}{2}}(1-t)^{2\lambda-1} dt, \quad \Re\mu + \frac{1}{2} > \Re\lambda > 0,$$

$$13.16.3 \quad \frac{1}{\Gamma(1+2\mu)} M_{\kappa,\mu}(z) = \frac{\sqrt{z}e^{\frac{1}{2}z}}{\Gamma(\frac{1}{2}+\mu+\kappa)} \int_0^\infty e^{-t}t^{\kappa-\frac{1}{2}} J_{2\mu}(2\sqrt{zt}) dt, \quad \Re(\kappa+\mu) + \frac{1}{2} > 0,$$

$$13.16.4 \quad \frac{1}{\Gamma(1+2\mu)} M_{\kappa,\mu}(z) = \frac{\sqrt{z}e^{-\frac{1}{2}z}}{\Gamma(\frac{1}{2}+\mu-\kappa)} \int_0^\infty e^{-t}t^{-\kappa-\frac{1}{2}} I_{2\mu}(2\sqrt{zt}) dt, \quad \Re(\kappa-\mu) - \frac{1}{2} > 0.$$

$$13.16.5 \quad W_{\kappa,\mu}(z) = \frac{z^{\mu+\frac{1}{2}}2^{-2\mu}}{\Gamma(\frac{1}{2}+\mu-\kappa)} \int_1^\infty e^{-\frac{1}{2}zt}(t-1)^{\mu-\frac{1}{2}-\kappa}(t+1)^{\mu-\frac{1}{2}+\kappa} dt, \quad \Re\mu + \frac{1}{2} > \Re\kappa, \quad |\text{ph } z| < \frac{1}{2}\pi,$$

13.16.6

$$W_{\kappa,\mu}(z) = \frac{e^{-\frac{1}{2}z}z^{\kappa+1}}{\Gamma(\frac{1}{2}+\mu-\kappa)\Gamma(\frac{1}{2}-\mu-\kappa)} \int_0^\infty \frac{W_{-\kappa,\mu}(t)e^{-\frac{1}{2}t}t^{-\kappa-1}}{t+z} dt, \quad |\text{ph } z| < \pi, \quad \Re(\frac{1}{2}+\mu-\kappa) > \max(2\Re\mu, 0),$$

$$13.16.7 \quad W_{\kappa,\mu}(z) = \frac{(-1)^n e^{-\frac{1}{2}z}z^{\frac{1}{2}-\mu-n}}{\Gamma(1+2\mu)\Gamma(\frac{1}{2}-\mu-\kappa)} \int_0^\infty \frac{M_{-\kappa,\mu}(t)e^{-\frac{1}{2}t}t^{n+\mu-\frac{1}{2}}}{t+z} dt, \\ |\text{ph } z| < \pi, \quad n = 0, 1, 2, \dots, \quad -\Re(1+2\mu) < n < |\Re\mu| + \Re\kappa < \frac{1}{2},$$

$$13.16.8 \quad W_{\kappa,\mu}(z) = \frac{2\sqrt{z}e^{-\frac{1}{2}z}}{\Gamma(\frac{1}{2}+\mu-\kappa)\Gamma(\frac{1}{2}-\mu-\kappa)} \int_0^\infty e^{-t}t^{-\kappa-\frac{1}{2}} K_{2\mu}(2\sqrt{zt}) dt, \quad \Re(\mu-\kappa) + \frac{1}{2} > 0,$$

$$13.16.9 \quad W_{\kappa,\mu}(z) = e^{-\frac{1}{2}z}z^{\kappa+c} \int_0^\infty e^{-zt}t^{c-1} {}_2F_1\left(\frac{1}{2}+\mu-\kappa, \frac{1}{2}-\mu-\kappa; -t\right) dt, \quad |\text{ph } z| < \frac{1}{2}\pi,$$

where  $c$  is arbitrary,  $\Re c > 0$ .

#### 13.16(ii) Contour Integrals

For contour integral representations combine (13.14.2) and (13.14.3) with §13.4(ii). See Buchholz (1969, §2.3), Erdélyi *et al.* (1953a, §6.11.3), and Slater (1960, Chapter 3). See also §13.16(iii).

#### 13.16(iii) Mellin–Barnes Integrals

If  $\frac{1}{2} + \mu - \kappa \neq 0, -1, -2, \dots$ , then

$$13.16.10 \quad \frac{1}{\Gamma(1+2\mu)} M_{\kappa,\mu}(e^{\pm\pi i}z) = \frac{e^{\frac{1}{2}z \pm (\frac{1}{2}+\mu)\pi i}}{2\pi i \Gamma(\frac{1}{2}+\mu-\kappa)} \int_{-i\infty}^{i\infty} \frac{\Gamma(t-\kappa)\Gamma(\frac{1}{2}+\mu-t)}{\Gamma(\frac{1}{2}+\mu+t)} z^t dt, \quad |\text{ph } z| < \frac{1}{2}\pi,$$

where the contour of integration separates the poles of  $\Gamma(t-\kappa)$  from those of  $\Gamma(\frac{1}{2}+\mu-t)$ .

If  $\frac{1}{2} \pm \mu - \kappa \neq 0, -1, -2, \dots$ , then

$$13.16.11 \quad W_{\kappa,\mu}(z) = \frac{e^{-\frac{1}{2}z}}{2\pi i} \int_{-i\infty}^{i\infty} \frac{\Gamma(\frac{1}{2}+\mu+t)\Gamma(\frac{1}{2}-\mu+t)\Gamma(-\kappa-t)}{\Gamma(\frac{1}{2}+\mu-\kappa)\Gamma(\frac{1}{2}-\mu-\kappa)} z^{-t} dt, \quad |\text{ph } z| < \frac{3}{2}\pi,$$

where the contour of integration separates the poles of  $\Gamma(\frac{1}{2}+\mu+t)\Gamma(\frac{1}{2}-\mu+t)$  from those of  $\Gamma(-\kappa-t)$ .

$$13.16.12 \quad W_{\kappa,\mu}(z) = \frac{e^{\frac{1}{2}z}}{2\pi i} \int_{-i\infty}^{i\infty} \frac{\Gamma(\frac{1}{2}+\mu+t)\Gamma(\frac{1}{2}-\mu+t)}{\Gamma(1-\kappa+t)} z^{-t} dt, \quad |\text{ph } z| < \frac{1}{2}\pi,$$

where the contour of integration passes all the poles of  $\Gamma(\frac{1}{2}+\mu+t)\Gamma(\frac{1}{2}-\mu+t)$  on the right-hand side.

### 13.17 Continued Fractions

If  $\kappa, \mu \in \mathbb{C}$  such that  $\mu \pm (\kappa - \frac{1}{2}) \neq -1, -2, -3, \dots$ , then

$$13.17.1 \quad \frac{\sqrt{z} M_{\kappa, \mu}(z)}{M_{\kappa - \frac{1}{2}, \mu + \frac{1}{2}}(z)} = 1 + \frac{u_1 z}{1 +} \frac{u_2 z}{1 +} \dots,$$

where

$$13.17.2 \quad u_{2n+1} = -\frac{\frac{1}{2} + \mu + \kappa + n}{(2\mu + 2n + 1)(2\mu + 2n + 2)},$$

$$u_{2n} = \frac{\frac{1}{2} + \mu - \kappa + n}{(2\mu + 2n)(2\mu + 2n + 1)}.$$

This continued fraction converges to the meromorphic function of  $z$  on the left-hand side for all  $z \in \mathbb{C}$ . For more details on how a continued fraction converges to a meromorphic function see Jones and Thron (1980).

If  $\kappa, \mu \in \mathbb{C}$  such that  $\mu + \frac{1}{2} \pm (\kappa + 1) \neq -1, -2, -3, \dots$ , then

$$13.17.3 \quad \frac{W_{\kappa, \mu}(z)}{\sqrt{z} W_{\kappa - \frac{1}{2}, \mu - \frac{1}{2}}(z)} = 1 + \frac{v_1/z}{1 +} \frac{v_2/z}{1 +} \dots,$$

where

$$13.17.4 \quad v_{2n+1} = \frac{1}{2} + \mu - \kappa + n, \quad v_{2n} = \frac{1}{2} - \mu - \kappa + n.$$

This continued fraction converges to the meromorphic function of  $z$  on the left-hand side throughout the sector  $|\text{ph } z| < \pi$ .

See also Cuyt *et al.* (2008, pp. 336–337).

### 13.18 Relations to Other Functions

#### 13.18(i) Elementary Functions

$$13.18.1 \quad M_{0, \frac{1}{2}}(2z) = 2 \sinh z,$$

13.18.2

$$M_{\kappa, \kappa - \frac{1}{2}}(z) = W_{\kappa, \kappa - \frac{1}{2}}(z) = W_{\kappa, -\kappa + \frac{1}{2}}(z) = e^{-\frac{1}{2}z} z^{\kappa},$$

$$13.18.3 \quad M_{\kappa, -\kappa - \frac{1}{2}}(z) = e^{\frac{1}{2}z} z^{-\kappa}.$$

#### 13.18(ii) Incomplete Gamma Functions

For the notation see §§6.2(i), 7.2(i), and 8.2(i). When  $\frac{1}{2} - \kappa \pm \mu$  is an integer the Whittaker functions can be expressed as incomplete gamma functions (or generalized exponential integrals). For example,

$$13.18.4 \quad M_{\mu - \frac{1}{2}, \mu}(z) = 2\mu e^{\frac{1}{2}z} z^{\frac{1}{2} - \mu} \gamma(2\mu, z),$$

$$13.18.5 \quad W_{\mu - \frac{1}{2}, \mu}(z) = e^{\frac{1}{2}z} z^{\frac{1}{2} - \mu} \Gamma(2\mu, z).$$

Special cases are the error functions

$$13.18.6 \quad M_{-\frac{1}{4}, \frac{1}{4}}(z^2) = \frac{1}{2} e^{\frac{1}{2}z^2} \sqrt{\pi z} \operatorname{erf}(z),$$

$$13.18.7 \quad W_{-\frac{1}{4}, -\frac{1}{4}}(z^2) = e^{\frac{1}{2}z^2} \sqrt{\pi z} \operatorname{erfc}(z).$$

#### 13.18(iii) Modified Bessel Functions

When  $\kappa = 0$  the Whittaker functions can be expressed as modified Bessel functions. For the notation see §§10.25(ii) and 9.2(i).

$$13.18.8 \quad M_{0, \nu}(2z) = 2^{2\nu + \frac{1}{2}} \Gamma(1 + \nu) \sqrt{z} I_{\nu}(z),$$

$$13.18.9 \quad W_{0, \nu}(2z) = \sqrt{2z/\pi} K_{\nu}(z),$$

$$13.18.10 \quad W_{0, \frac{1}{3}}\left(\frac{4}{3}z^{\frac{3}{2}}\right) = 2\sqrt{\pi} z^{\frac{1}{4}} \operatorname{Ai}(z).$$

#### 13.18(iv) Parabolic Cylinder Functions

For the notation see §12.2.

$$13.18.11 \quad W_{-\frac{1}{2}a, \pm \frac{1}{4}}\left(\frac{1}{2}z^2\right) = 2^{\frac{1}{2}a} \sqrt{z} U(a, z),$$

$$13.18.12 \quad M_{-\frac{1}{2}a, -\frac{1}{4}}\left(\frac{1}{2}z^2\right) = 2^{\frac{1}{2}a-1} \Gamma\left(\frac{1}{2}a + \frac{3}{4}\right) \sqrt{z/\pi} \\ \times (U(a, z) + U(a, -z)),$$

$$13.18.13 \quad M_{-\frac{1}{2}a, \frac{1}{4}}\left(\frac{1}{2}z^2\right) = 2^{\frac{1}{2}a-2} \Gamma\left(\frac{1}{2}a + \frac{1}{4}\right) \sqrt{z/\pi} \\ \times (U(a, -z) - U(a, z)).$$

#### 13.18(v) Orthogonal Polynomials

Special cases of §13.18(iv) are as follows. For the notation see §18.3.

##### Hermite Polynomials

$$13.18.14 \quad M_{\frac{1}{4}+n, -\frac{1}{4}}(z^2) = (-1)^n \frac{n!}{(2n)!} e^{-\frac{1}{2}z^2} \sqrt{z} H_{2n}(z),$$

13.18.15

$$M_{\frac{3}{4}+n, \frac{1}{4}}(z^2) = (-1)^n \frac{n!}{(2n+1)!} \frac{e^{-\frac{1}{2}z^2} \sqrt{z}}{2} H_{2n+1}(z),$$

$$13.18.16 \quad W_{\frac{1}{4} + \frac{1}{2}n, \frac{1}{4}}(z^2) = 2^{-n} e^{-\frac{1}{2}z^2} \sqrt{z} H_n(z).$$

##### Laguerre Polynomials

13.18.17

$$W_{\frac{1}{2}\alpha + \frac{1}{2} + n, \frac{1}{2}\alpha}(z) = (-1)^n (\alpha + 1)_n M_{\frac{1}{2}\alpha + \frac{1}{2} + n, \frac{1}{2}\alpha}(z) \\ = (-1)^n n! e^{-\frac{1}{2}z} z^{\frac{1}{2}\alpha + \frac{1}{2}} L_n^{(\alpha)}(z).$$

### 13.19 Asymptotic Expansions for Large Argument

As  $x \rightarrow \infty$

$$13.19.1 \quad M_{\kappa,\mu}(x) \sim \frac{\Gamma(1+2\mu)}{\Gamma(\frac{1}{2}+\mu-\kappa)} e^{\frac{1}{2}x} x^{-\kappa} \sum_{s=0}^{\infty} \frac{(\frac{1}{2}-\mu+\kappa)_s (\frac{1}{2}+\mu+\kappa)_s}{s!} x^{-s}, \quad \mu-\kappa \neq -\frac{1}{2}, -\frac{3}{2}, \dots$$

As  $z \rightarrow \infty$

$$13.19.2 \quad M_{\kappa,\mu}(z) \sim \frac{\Gamma(1+2\mu)}{\Gamma(\frac{1}{2}+\mu-\kappa)} e^{\frac{1}{2}z} z^{-\kappa} \sum_{s=0}^{\infty} \frac{(\frac{1}{2}-\mu+\kappa)_s (\frac{1}{2}+\mu+\kappa)_s}{s!} z^{-s} \\ + \frac{\Gamma(1+2\mu)}{\Gamma(\frac{1}{2}+\mu+\kappa)} e^{-\frac{1}{2}z \pm (\frac{1}{2}+\mu-\kappa)\pi i} z^{\kappa} \sum_{s=0}^{\infty} \frac{(\frac{1}{2}+\mu-\kappa)_s (\frac{1}{2}-\mu-\kappa)_s}{s!} (-z)^{-s}, \\ -\frac{1}{2}\pi + \delta \leq \pm \text{ph } z \leq \frac{3}{2}\pi - \delta,$$

provided that both  $\mu \mp \kappa \neq -\frac{1}{2}, -\frac{3}{2}, \dots$ . Again,  $\delta$  denotes an arbitrary small positive constant. Also,

$$13.19.3 \quad W_{\kappa,\mu}(z) \sim e^{-\frac{1}{2}z} z^{\kappa} \sum_{s=0}^{\infty} \frac{(\frac{1}{2}+\mu-\kappa)_s (\frac{1}{2}-\mu-\kappa)_s}{s!} (-z)^{-s}, \quad |\text{ph } z| \leq \frac{3}{2}\pi - \delta.$$

Error bounds and exponentially-improved expansions are derivable by combining §§13.7(ii) and 13.7(iii) with (13.14.2) and (13.14.3). See also Olver (1965).

For an asymptotic expansion of  $W_{\kappa,\mu}(z)$  as  $z \rightarrow \infty$  that is valid in the sector  $|\text{ph } z| \leq \pi - \delta$  and where the real parameters  $\kappa, \mu$  are subject to the growth conditions  $\kappa = o(z), \mu = o(\sqrt{z})$ , see Wong (1973a).

### 13.20 Uniform Asymptotic Approximations for Large $\mu$

#### 13.20(i) Large $\mu$ , Fixed $\kappa$

When  $\mu \rightarrow \infty$  in the sector  $|\text{ph } \mu| \leq \frac{1}{2}\pi - \delta (< \frac{1}{2}\pi)$ , with  $\kappa (\in \mathbb{C})$  fixed

$$13.20.1 \quad M_{\kappa,\mu}(z) = z^{\mu+\frac{1}{2}} (1 + O(\mu^{-1})),$$

uniformly for bounded values of  $|z|$ ; also

#### 13.20.2

$W_{\kappa,\mu}(x) = \pi^{-\frac{1}{2}} \Gamma(\kappa + \mu) (\frac{1}{4}x)^{\frac{1}{2}-\mu} (1 + O(\mu^{-1}))$ , uniformly for bounded positive values of  $x$ . For an extension of (13.20.1) to an asymptotic expansion, together with error bounds, see Olver (1997b, Chapter 10, Ex. 3.4).

#### 13.20(ii) Large $\mu$ , $0 \leq \kappa \leq (1 - \delta)\mu$

Let

$$13.20.3 \quad X = \sqrt{4\mu^2 - 4\kappa x + x^2}.$$

Then as  $\mu \rightarrow \infty$

#### 13.20.4

$$M_{\kappa,\mu}(x) = \sqrt{\frac{2\mu x}{X}} \left( \frac{4\mu^2 x}{2\mu^2 - \kappa x + \mu X} \right)^{\mu} \\ \times \left( \frac{2(\mu - \kappa)}{X + x - 2\kappa} \right)^{\kappa} e^{\frac{1}{2}X - \mu} \left( 1 + O\left(\frac{1}{\mu}\right) \right),$$

#### 13.20.5

$$W_{\kappa,\mu}(x) = \sqrt{\frac{x}{X}} \left( \frac{2\mu^2 - \kappa x + \mu X}{(\mu - \kappa)x} \right)^{\mu} \left( \frac{X + x - 2\kappa}{2} \right)^{\kappa} \\ \times e^{-\frac{1}{2}X - \kappa} \left( 1 + O\left(\frac{1}{\mu}\right) \right),$$

uniformly with respect to  $x \in (0, \infty)$  and  $\kappa \in [0, (1 - \delta)\mu]$ , where  $\delta$  again denotes an arbitrary small positive constant.

#### 13.20(iii) Large $\mu$ , $-(1 - \delta)\mu \leq \kappa \leq \mu$

Let

$$13.20.6 \quad \alpha = \sqrt{2|\kappa - \mu|/\mu},$$

$$13.20.7 \quad X = \sqrt{|x^2 - 4\kappa x + 4\mu^2|},$$

$$13.20.8 \quad \Phi(\kappa, \mu, x) = \left( \frac{\mu^2 \zeta^2 - 2\kappa\mu + 2\mu^2}{x^2 - 4\kappa x + 4\mu^2} \right)^{\frac{1}{4}} \sqrt{x},$$

with the variable  $\zeta$  defined implicitly as follows:

(a) In the case  $-\mu < \kappa < \mu$

#### 13.20.9

$$\zeta \sqrt{\zeta^2 + \alpha^2} + \alpha^2 \operatorname{arcsinh} \left( \frac{\zeta}{\alpha} \right) \\ = \frac{X}{\mu} - \frac{2\kappa}{\mu} \ln \left( \frac{X + x - 2\kappa}{2\sqrt{\mu^2 - \kappa^2}} \right) - 2 \ln \left( \frac{\mu X + 2\mu^2 - \kappa x}{x\sqrt{\mu^2 - \kappa^2}} \right).$$

(b) In the case  $\mu = \kappa$

$$13.20.10 \quad \zeta = \pm \sqrt{\frac{x}{\mu} - 2 - 2 \ln \left( \frac{x}{2\mu} \right)},$$

the upper or lower sign being taken according as  $x \geq 2\mu$ .

(In both cases (a) and (b) the  $x$ -interval  $(0, \infty)$  is mapped one-to-one onto the  $\zeta$ -interval  $(-\infty, \infty)$ , with

$x = 0$  and  $\infty$  corresponding to  $\zeta = -\infty$  and  $\infty$ , respectively.) Then as  $\mu \rightarrow \infty$

**13.20.11**

$$W_{\kappa,\mu}(x) = \left(\frac{1}{2}\mu\right)^{-\frac{1}{4}} \left(\frac{\kappa + \mu}{e}\right)^{\frac{1}{2}(\kappa+\mu)} \Phi(\kappa, \mu, x) \times U\left(\mu - \kappa, \zeta\sqrt{2\mu}\right) \left(1 + O(\mu^{-1} \ln \mu)\right),$$

**13.20.12**

$$M_{\kappa,\mu}(x) = (8\mu)^{\frac{1}{4}} \left(\frac{2\mu}{e}\right)^{2\mu} \left(\frac{e}{\kappa + \mu}\right)^{\frac{1}{2}(\kappa+\mu)} \Phi(\kappa, \mu, x) \times U\left(\mu - \kappa, -\zeta\sqrt{2\mu}\right) \left(1 + O(\mu^{-1} \ln \mu)\right),$$

uniformly with respect to  $x \in (0, \infty)$  and  $\kappa \in [-(1 - \delta)\mu, \mu]$ . For the parabolic cylinder function  $U$  see §12.2.

These results are proved in Olver (1980b). This reference also supplies error bounds and corresponding approximations when  $x$ ,  $\kappa$ , and  $\mu$  are replaced by  $ix$ ,  $i\kappa$ , and  $i\mu$ , respectively.

**13.20(iv) Large  $\mu$ ,  $\mu \leq \kappa \leq \mu/\delta$**

Again define  $\alpha$ ,  $X$ , and  $\Phi(\kappa, \mu, x)$  by (13.20.6)–(13.20.8), but with  $\zeta$  now defined by

**13.20.13**

$$\zeta\sqrt{\zeta^2 - \alpha^2} - \alpha^2 \operatorname{arccosh}\left(\frac{\zeta}{\alpha}\right) = \frac{X}{\mu} - \frac{2\kappa}{\mu} \ln\left(\frac{X + x - 2\kappa}{2\sqrt{\kappa^2 - \mu^2}}\right) - 2 \ln\left(\frac{\kappa x - \mu X - 2\mu^2}{x\sqrt{\kappa^2 - \mu^2}}\right), \quad x \geq 2\kappa + 2\sqrt{\kappa^2 - \mu^2},$$

**13.20.14**

$$\zeta\sqrt{\alpha^2 - \zeta^2} + \alpha^2 \arcsin\left(\frac{\zeta}{\alpha}\right) = \frac{X}{\mu} + \frac{2\kappa}{\mu} \arctan\left(\frac{x - 2\kappa}{X}\right) - 2 \arctan\left(\frac{\kappa x - 2\mu^2}{\mu X}\right),$$

$$2\kappa - 2\sqrt{\kappa^2 - \mu^2} \leq x \leq 2\kappa + 2\sqrt{\kappa^2 - \mu^2},$$

**13.20.15**

$$-\zeta\sqrt{\zeta^2 - \alpha^2} - \alpha^2 \operatorname{arccosh}\left(-\frac{\zeta}{\alpha}\right) = -\frac{X}{\mu} + \frac{2\kappa}{\mu} \ln\left(\frac{2\kappa - X - x}{2\sqrt{\kappa^2 - \mu^2}}\right) + 2 \ln\left(\frac{\mu X + 2\mu^2 - \kappa x}{x\sqrt{\kappa^2 - \mu^2}}\right),$$

$$0 < x \leq 2\kappa - 2\sqrt{\kappa^2 - \mu^2},$$

when  $\mu < \kappa$ , and by (13.20.10) when  $\mu = \kappa$ . (As in §13.20(iii)  $x = 0$  and  $\infty$  correspond to  $\zeta = -\infty$  and  $\infty$ , respectively). Then as  $\mu \rightarrow \infty$

**13.20.16**  $W_{\kappa,\mu}(x) = \left(\frac{1}{2}\mu\right)^{-\frac{1}{4}} \left(\frac{\kappa + \mu}{e}\right)^{\frac{1}{2}(\kappa+\mu)} \Phi(\kappa, \mu, x) \left(U\left(\mu - \kappa, \zeta\sqrt{2\mu}\right) + \operatorname{env}U\left(\mu - \kappa, \zeta\sqrt{2\mu}\right) O\left(\mu^{-\frac{2}{3}}\right)\right),$

**13.20.17**  $M_{\kappa,\mu}(x) = (8\mu)^{\frac{1}{4}} \left(\frac{2\mu}{e}\right)^{2\mu} \left(\frac{e}{\kappa + \mu}\right)^{\frac{1}{2}(\kappa+\mu)} \Phi(\kappa, \mu, x) \left(U\left(\mu - \kappa, -\zeta\sqrt{2\mu}\right) + \operatorname{env}\bar{U}\left(\mu - \kappa, \zeta\sqrt{2\mu}\right) O\left(\mu^{-\frac{2}{3}}\right)\right),$

uniformly with respect to  $\zeta \in [0, \infty)$  and  $\kappa \in [\mu, \mu/\delta]$ .

Also,

**13.20.18**  $W_{\kappa,\mu}(x) = \left(\frac{1}{2}\mu\right)^{-\frac{1}{4}} \left(\frac{\kappa + \mu}{e}\right)^{\frac{1}{2}(\kappa+\mu)} \Phi(\kappa, \mu, x) \left(U\left(\mu - \kappa, \zeta\sqrt{2\mu}\right) + \operatorname{env}\bar{U}\left(\mu - \kappa, -\zeta\sqrt{2\mu}\right) O\left(\mu^{-\frac{2}{3}}\right)\right),$

**13.20.19**

$$M_{\kappa,\mu}(x) = (8\mu)^{\frac{1}{4}} \left(\frac{2\mu}{e}\right)^{2\mu} \left(\frac{e}{\kappa + \mu}\right)^{\frac{1}{2}(\kappa+\mu)} \Phi(\kappa, \mu, x) \left(U\left(\mu - \kappa, -\zeta\sqrt{2\mu}\right) + \operatorname{env}U\left(\mu - \kappa, -\zeta\sqrt{2\mu}\right) O\left(\mu^{-\frac{2}{3}}\right)\right),$$

uniformly with respect to  $\zeta \in (-\infty, 0]$  and  $\kappa \in [\mu, \mu/\delta]$ .

For the parabolic cylinder functions  $U$  and  $\bar{U}$  see §12.2, and for the env functions associated with  $U$  and  $\bar{U}$  see §14.15(v).

These results are proved in Olver (1980b). Equations (13.20.17) and (13.20.18) are simpler than (6.10) and (6.11) in this reference. Olver (1980b) also supplies error bounds and corresponding approximations when

$x$ ,  $\kappa$ , and  $\mu$  are replaced by  $ix$ ,  $i\kappa$ , and  $i\mu$ , respectively.

It should be noted that (13.20.11), (13.20.16), and (13.20.18) differ only in the common error terms. Hence without the error terms the approximation holds for  $-(1 - \delta)\mu \leq \kappa \leq \mu/\delta$ . Similarly for (13.20.12), (13.20.17), and (13.20.19).

**13.20(v) Large  $\mu$ , Other Expansions**

For uniform approximations valid when  $\mu$  is large,  $x/i \in (0, \infty)$ , and  $\kappa/i \in [0, \mu/\delta]$ , see Olver (1997b, pp. 401–403). These approximations are in terms of Airy functions.

For uniform approximations of  $M_{\kappa, i\mu}(z)$  and  $W_{\kappa, i\mu}(z)$ ,  $\kappa$  and  $\mu$  real, one or both large, see Dunster (2003a).

**13.21 Uniform Asymptotic Approximations for Large  $\kappa$** **13.21(i) Large  $\kappa$ , Fixed  $\mu$** 

For the notation see §§10.2(ii), 10.25(ii), and 2.8(iv).

When  $\kappa \rightarrow \infty$  through positive real values with  $\mu (\geq 0)$  fixed

$$13.21.1 \quad M_{\kappa, \mu}(x) = \sqrt{x} \Gamma(2\mu + 1) \kappa^{-\mu} \left( J_{2\mu}(2\sqrt{x\kappa}) + \text{env} J_{2\mu}(2\sqrt{x\kappa}) O\left(\kappa^{-\frac{1}{2}}\right) \right),$$

$$13.21.2 \quad W_{\kappa, \mu}(x) = \sqrt{x} \Gamma\left(\kappa + \frac{1}{2}\right) \left( \sin(\kappa\pi - \mu\pi) J_{2\mu}(2\sqrt{x\kappa}) - \cos(\kappa\pi - \mu\pi) Y_{2\mu}(2\sqrt{x\kappa}) + \text{env} Y_{2\mu}(2\sqrt{x\kappa}) O\left(\kappa^{-\frac{1}{2}}\right) \right),$$

$$13.21.3 \quad W_{-\kappa, \mu}(xe^{-\pi i}) = \frac{\pi\sqrt{x}}{\Gamma\left(\kappa + \frac{1}{2}\right)} e^{\mu\pi i} \left( H_{2\mu}^{(1)}(2\sqrt{x\kappa}) + \text{env} Y_{2\mu}(2\sqrt{x\kappa}) O\left(\kappa^{-\frac{1}{2}}\right) \right),$$

$$13.21.4 \quad W_{-\kappa, \mu}(xe^{\pi i}) = \frac{\pi\sqrt{x}}{\Gamma\left(\kappa + \frac{1}{2}\right)} e^{-\mu\pi i} \left( H_{2\mu}^{(2)}(2\sqrt{x\kappa}) + \text{env} Y_{2\mu}(2\sqrt{x\kappa}) O\left(\kappa^{-\frac{1}{2}}\right) \right),$$

uniformly with respect to  $x \in (0, A]$  in each case, where  $A$  is an arbitrary positive constant.

Other types of approximations when  $\kappa \rightarrow \infty$  through positive real values with  $\mu (\geq 0)$  fixed are as follows. Define

$$13.21.5 \quad 2\sqrt{\zeta} = \sqrt{x + x^2} + \ln(\sqrt{x} + \sqrt{1 + x}).$$

Then

$$13.21.6 \quad M_{-\kappa, \mu}(4\kappa x) = \frac{2\Gamma(2\mu + 1)}{\kappa^{\mu - \frac{1}{2}}} \left( \frac{x\zeta}{1 + x} \right)^{\frac{1}{4}} I_{2\mu}\left(4\kappa\zeta^{\frac{1}{2}}\right) (1 + O(\kappa^{-1})),$$

$$13.21.7 \quad W_{-\kappa, \mu}(4\kappa x) = \frac{\sqrt{8/\pi} e^{\kappa}}{\kappa^{\kappa - \frac{1}{2}}} \left( \frac{x\zeta}{1 + x} \right)^{\frac{1}{4}} K_{2\mu}\left(4\kappa\zeta^{\frac{1}{2}}\right) (1 + O(\kappa^{-1})),$$

uniformly with respect to  $x \in (0, \infty)$ .

For (13.21.6), (13.21.7), and extensions to asymptotic expansions and error bounds, see Olver (1997b, Chapter 12, Exs. 12.4.5, 12.4.6). For extensions to complex values of  $x$  see López (1999).

**13.21(ii) Large  $\kappa$ ,  $0 \leq \mu \leq (1 - \delta)\kappa$** 

Let

$$13.21.8 \quad c(\kappa, \mu) = e^{\mu\pi i} \sqrt{\frac{1}{2}\pi} \left( \frac{\kappa - \mu}{\kappa + \mu} \right)^{\frac{1}{2}\mu} \left( \frac{e^2}{\kappa^2 - \mu^2} \right)^{\frac{1}{2}\kappa},$$

$$13.21.9 \quad X = \sqrt{|x^2 - 4\kappa x + 4\mu^2|},$$

$$13.21.10 \quad \Psi(\kappa, \mu, x) = \left( \frac{4\mu^2 - \kappa\zeta}{x^2 - 4\kappa x + 4\mu^2} \right)^{\frac{1}{4}} \sqrt{x},$$

with the variable  $\zeta$  defined implicitly by

$$13.21.11 \quad \sqrt{4\mu^2 - \kappa\zeta} - \mu \ln \left( \frac{2\mu + \sqrt{4\mu^2 - \kappa\zeta}}{2\mu - \sqrt{4\mu^2 - \kappa\zeta}} \right) = \frac{1}{2}X + \mu \ln \left( \frac{x\sqrt{\kappa^2 - \mu^2}}{2\mu^2 - \kappa x + \mu X} \right) + \kappa \ln \left( \frac{2\sqrt{\kappa^2 - \mu^2}}{2\kappa - x - X} \right),$$

$$0 < x \leq 2\kappa - 2\sqrt{\kappa^2 - \mu^2},$$

and

$$13.21.12 \quad \sqrt{\kappa\zeta - 4\mu^2} - 2\mu \arctan \left( \frac{\sqrt{\kappa\zeta - 4\mu^2}}{2\mu} \right) = \frac{1}{2}(X - \pi\mu) - \mu \arctan \left( \frac{x\kappa - 2\mu^2}{\mu X} \right) + \kappa \arcsin \left( \frac{X}{2\sqrt{\kappa^2 - \mu^2}} \right),$$

$$2\kappa - 2\sqrt{\kappa^2 - \mu^2} \leq x < 2\kappa + 2\sqrt{\kappa^2 - \mu^2}.$$

Then as  $\kappa \rightarrow \infty$

$$13.21.13 \quad M_{\kappa, \mu}(x) = \Gamma(2\mu + 1) \left( \frac{e^2}{\kappa^2 - \mu^2} \right)^{\frac{1}{2}\mu} \left( \frac{\kappa - \mu}{\kappa + \mu} \right)^{\frac{1}{2}\kappa} \Psi(\kappa, \mu, x) \left( J_{2\mu}(\sqrt{\zeta\kappa}) + \text{env} J_{2\mu}(\sqrt{\zeta\kappa}) O(\kappa^{-1}) \right),$$

$$13.21.14 \quad W_{\kappa, \mu}(x) = \frac{e^{-\mu\pi i}}{\pi} \Gamma\left(\kappa + \mu + \frac{1}{2}\right) \Gamma\left(\kappa - \mu + \frac{1}{2}\right) c(\kappa, \mu) \Psi(\kappa, \mu, x) \\ \times \left( \sin(\kappa\pi - \mu\pi) J_{2\mu}(\sqrt{\zeta\kappa}) - \cos(\kappa\pi - \mu\pi) Y_{2\mu}(\sqrt{\zeta\kappa}) + \text{env} Y_{2\mu}(\sqrt{\zeta\kappa}) O(\kappa^{-1}) \right),$$

13.21.15

$$W_{-\kappa,\mu}(xe^{-\pi i}) = c(\kappa, \mu)\Psi(\kappa, \mu, x) \left( H_{2\mu}^{(1)}(\sqrt{\zeta\kappa}) + \text{env}Y_{2\mu}(\sqrt{\zeta\kappa}) O(\kappa^{-1}) \right),$$

13.21.16

$$W_{-\kappa,\mu}(xe^{\pi i}) = e^{-2\mu\pi i}c(\kappa, \mu)\Psi(\kappa, \mu, x) \left( H_{2\mu}^{(2)}(\sqrt{\zeta\kappa}) + \text{env}Y_{2\mu}(\sqrt{\zeta\kappa}) O(\kappa^{-1}) \right),$$

uniformly with respect to  $\mu \in [0, (1 - \delta)\kappa]$  and  $x \in (0, (1 - \delta)(2\kappa + 2\sqrt{\kappa^2 - \mu^2})]$ , where  $\delta$  again denotes an arbitrary small positive constant. For the functions  $J_{2\mu}$ ,  $Y_{2\mu}$ ,  $H_{2\mu}^{(1)}$ , and  $H_{2\mu}^{(2)}$  see §10.2(ii), and for the env functions associated with  $J_{2\mu}$  and  $Y_{2\mu}$  see §2.8(iv).

These approximations are proved in Dunster (1989).

This reference also includes error bounds and extensions to asymptotic expansions and complex values of  $x$ .

13.21(iii) Large  $\kappa$ ,  $0 \leq \mu \leq (1 - \delta)\kappa$   
(Continued)

Let

13.21.17  $\widehat{c}(\kappa, \mu) = \sqrt{2\pi\kappa}^{\frac{1}{6}} \left( \frac{\kappa - \mu}{\kappa + \mu} \right)^{\frac{1}{2}\mu} \left( \frac{e^2}{\kappa^2 - \mu^2} \right)^{\frac{1}{2}\kappa},$

13.21.18  $X = \sqrt{|x^2 - 4\kappa x + 4\mu^2|},$

13.21.19  $\widehat{\Psi}(\kappa, \mu, x) = \left( \frac{\widehat{\zeta}}{x^2 - 4\kappa x + 4\mu^2} \right)^{\frac{1}{4}} \sqrt{2x},$

and define the variable  $\widehat{\zeta}$  implicitly by

13.21.20 
$$\widehat{\zeta} = - \left( \frac{3}{2\kappa} \left( -\frac{1}{2}X + 2\mu \arctan \left( \frac{x\kappa - x\sqrt{\kappa^2 - \mu^2} - 2\mu^2}{\mu X} \right) + \kappa \arccos \left( \frac{x - 2\kappa}{2\sqrt{\kappa^2 - \mu^2}} \right) \right) \right)^{2/3},$$
  

$$2\kappa - 2\sqrt{\kappa^2 - \mu^2} < x \leq 2\kappa + 2\sqrt{\kappa^2 - \mu^2},$$

and

13.21.21 
$$\widehat{\zeta} = \left( \frac{3}{2\kappa} \left( \frac{1}{2}X + \mu \ln \left( \frac{x\sqrt{\kappa^2 - \mu^2}}{\kappa x - 2\mu^2 - \mu X} \right) + \kappa \ln \left( \frac{2\sqrt{\kappa^2 - \mu^2}}{x - 2\kappa + X} \right) \right) \right)^{2/3}, \quad x \geq 2\kappa + 2\sqrt{\kappa^2 - \mu^2}.$$

Then as  $\kappa \rightarrow \infty$

13.21.22 
$$M_{\kappa,\mu}(x) = \frac{1}{2\pi} \Gamma(2\mu + 1) \Gamma(\kappa - \mu + \frac{1}{2}) \widehat{c}(\kappa, \mu) \widehat{\Psi}(\kappa, \mu, x) \times \left( \sin(\kappa\pi - \mu\pi) \text{Ai} \left( \kappa^{\frac{2}{3}} \widehat{\zeta} \right) + \cos(\kappa\pi - \mu\pi) \text{Bi} \left( \kappa^{\frac{2}{3}} \widehat{\zeta} \right) + \text{envBi} \left( \kappa^{\frac{2}{3}} \widehat{\zeta} \right) O(\kappa^{-1}) \right),$$

13.21.23 
$$W_{\kappa,\mu}(x) = \sqrt{2\pi\kappa}^{\frac{1}{6}} \left( \frac{\kappa + \mu}{\kappa - \mu} \right)^{\frac{1}{2}\mu} \left( \frac{\kappa^2 - \mu^2}{e^2} \right)^{\frac{1}{2}\kappa} \widehat{\Psi}(\kappa, \mu, x) \left( \text{Ai} \left( \kappa^{\frac{2}{3}} \widehat{\zeta} \right) + \text{envAi} \left( \kappa^{\frac{2}{3}} \widehat{\zeta} \right) O(\kappa^{-1}) \right),$$

13.21.24 
$$W_{-\kappa,\mu}(xe^{-\pi i}) = e^{(\kappa - \frac{1}{6})\pi i} \widehat{c}(\kappa, \mu) \widehat{\Psi}(\kappa, \mu, x) \left( \text{Ai} \left( \kappa^{\frac{2}{3}} \widehat{\zeta} e^{-\frac{2}{3}\pi i} \right) + \text{envBi} \left( \kappa^{\frac{2}{3}} \widehat{\zeta} \right) O(\kappa^{-1}) \right),$$

13.21.25 
$$W_{-\kappa,\mu}(xe^{\pi i}) = e^{-(\kappa - \frac{1}{6})\pi i} \widehat{c}(\kappa, \mu) \widehat{\Psi}(\kappa, \mu, x) \left( \text{Ai} \left( \kappa^{\frac{2}{3}} \widehat{\zeta} e^{\frac{2}{3}\pi i} \right) + \text{envBi} \left( \kappa^{\frac{2}{3}} \widehat{\zeta} \right) O(\kappa^{-1}) \right),$$

uniformly with respect to  $\mu \in [0, (1 - \delta)\kappa]$  and  $x \in [(1 + \delta)(2\kappa - 2\sqrt{\kappa^2 - \mu^2}), \infty)$ . For the functions Ai and Bi see §9.2(i), and for the env functions associated with Ai and Bi see §2.8(iii).

These approximations are proved in Dunster (1989). This reference also includes error bounds and extensions to asymptotic expansions and complex values of  $x$ .

13.21(iv) Large  $\kappa$ , Other Expansions

For a uniform asymptotic expansion in terms of Airy functions for  $W_{\kappa,\mu}(4\kappa x)$  when  $\kappa$  is large and positive,  $\mu$  is real with  $|\mu|$  bounded, and  $x \in [\delta, \infty)$  see Olver (1997b, Chapter 11, Ex. 7.3). This expansion is simpler

in form than the expansions of Dunster (1989) that correspond to the approximations given in §13.21(iii), but the conditions on  $\mu$  are more restrictive.

For asymptotic expansions having double asymptotic properties see Skovgaard (1966).

See also §13.20(v).

13.22 Zeros

From (13.14.2) and (13.14.3)  $M_{\kappa,\mu}(z)$  has the same zeros as  $M(\frac{1}{2} + \mu - \kappa, 1 + 2\mu, z)$  and  $W_{\kappa,\mu}(z)$  has the same zeros as  $U(\frac{1}{2} + \mu - \kappa, 1 + 2\mu, z)$ , hence the results given in §13.9 can be adopted.

Asymptotic approximations to the zeros when the parameters  $\kappa$  and/or  $\mu$  are large can be found by rever-

sion of the uniform approximations provided in §§13.20 and 13.21. For example, if  $\mu(\geq 0)$  is fixed and  $\kappa(> 0)$  is large, then the  $r$ th positive zero  $\phi_r$  of  $M_{\kappa,\mu}(z)$  is given by

$$13.22.1 \quad \phi_r = \frac{j_{2\mu,r}^2}{4\kappa} + j_{2\mu,r} O\left(\kappa^{-\frac{3}{2}}\right),$$

where  $j_{2\mu,r}$  is the  $r$ th positive zero of the Bessel function  $J_{2\mu}(x)$  (§10.21(i)). (13.22.1) is a weaker version of (13.9.8).

## 13.23 Integrals

### 13.23(i) Laplace and Mellin Transforms

For the notation see §§15.1, 15.2(i), and 10.25(ii).

$$13.23.1 \quad \int_0^\infty e^{-zt} t^{\nu-1} M_{\kappa,\mu}(t) dt = \frac{\Gamma(\mu + \nu + \frac{1}{2})}{(z + \frac{1}{2})^{\mu + \nu + \frac{1}{2}}} {}_2F_1\left(\frac{1}{2} + \mu - \kappa, \frac{1}{2} + \mu + \nu; \frac{1}{z + \frac{1}{2}}\right), \quad \Re(\mu + \nu + \frac{1}{2}) > 0, \Re z > \frac{1}{2}.$$

$$13.23.2 \quad \int_0^\infty e^{-zt} t^{\mu-\frac{1}{2}} M_{\kappa,\mu}(t) dt = \Gamma(2\mu + 1) (z + \frac{1}{2})^{-\kappa - \mu - \frac{1}{2}} (z - \frac{1}{2})^{\kappa - \mu - \frac{1}{2}}, \quad \Re\mu > -\frac{1}{2}, \Re z > \frac{1}{2},$$

$$13.23.3 \quad \frac{1}{\Gamma(1 + 2\mu)} \int_0^\infty e^{-\frac{1}{2}t} t^{\nu-1} M_{\kappa,\mu}(t) dt = \frac{\Gamma(\mu + \nu + \frac{1}{2}) \Gamma(\kappa - \nu)}{\Gamma(\frac{1}{2} + \mu + \kappa) \Gamma(\frac{1}{2} + \mu - \nu)}, \quad -\frac{1}{2} - \Re\mu < \Re\nu < \Re\kappa.$$

$$13.23.4 \quad \int_0^\infty e^{-zt} t^{\nu-1} W_{\kappa,\mu}(t) dt = \Gamma(\frac{1}{2} + \mu + \nu) \Gamma(\frac{1}{2} - \mu + \nu) {}_2F_1\left(\frac{1}{2} - \mu + \nu, \frac{1}{2} + \mu + \nu; \frac{1}{2} - z\right), \\ \Re(\nu + \frac{1}{2}) > |\Re\mu|, \Re z > -\frac{1}{2},$$

$$13.23.5 \quad \int_0^\infty e^{\frac{1}{2}t} t^{\nu-1} W_{\kappa,\mu}(t) dt = \frac{\Gamma(\frac{1}{2} + \mu + \nu) \Gamma(\frac{1}{2} - \mu + \nu) \Gamma(-\kappa - \nu)}{\Gamma(\frac{1}{2} + \mu - \kappa) \Gamma(\frac{1}{2} - \mu - \kappa)}, \quad |\Re\mu| - \frac{1}{2} < \Re\nu < -\Re\kappa.$$

$$13.23.6 \quad \frac{1}{\Gamma(1 + 2\mu) 2\pi i} \int_{-\infty}^{(0+)} e^{zt + \frac{1}{2}t^{-1}} t^\kappa M_{\kappa,\mu}(t^{-1}) dt = \frac{z^{-\kappa - \frac{1}{2}}}{\Gamma(\frac{1}{2} + \mu - \kappa)} I_{2\mu}(2\sqrt{z}), \quad \Re z > 0.$$

$$13.23.7 \quad \frac{1}{2\pi i} \int_{-\infty}^{(0+)} e^{zt + \frac{1}{2}t^{-1}} t^\kappa W_{\kappa,\mu}(t^{-1}) dt = \frac{2z^{-\kappa - \frac{1}{2}}}{\Gamma(\frac{1}{2} + \mu - \kappa) \Gamma(\frac{1}{2} - \mu - \kappa)} K_{2\mu}(2\sqrt{z}), \quad \Re z > 0.$$

For additional Laplace and Mellin transforms see Erdélyi *et al.* (1954a, §§4.22, 5.20, 6.9, 7.5), Marichev (1983, pp. 283–287), Oberhettinger and Badii (1973, §1.17), Oberhettinger (1974, §§1.13, 2.8), and Prudnikov *et al.* (1992a, §§3.34, 3.35). Inverse Laplace transforms are given in Oberhettinger and Badii (1973, §2.16) and Prudnikov *et al.* (1992b, §§3.33, 3.34).

### 13.23(ii) Fourier Transforms

$$13.23.8 \quad \frac{1}{\Gamma(1 + 2\mu)} \int_0^\infty \cos(2xt) e^{-\frac{1}{2}t^2} t^{-2\mu-1} M_{\kappa,\mu}(t^2) dt = \frac{\sqrt{\pi} e^{-\frac{1}{2}x^2} x^{\mu + \kappa - 1}}{2\Gamma(\frac{1}{2} + \mu + \kappa)} W_{\frac{1}{2}\kappa - \frac{3}{2}\mu, \frac{1}{2}\kappa + \frac{1}{2}\mu}(x^2), \quad \Re(\kappa + \mu) > -\frac{1}{2}.$$

For additional Fourier transforms see Erdélyi *et al.* (1954a, §§1.14, 2.14, 3.3) and Oberhettinger (1990, §§1.22, 2.22).

### 13.23(iii) Hankel Transforms

For the notation see §10.2(ii).

$$13.23.9 \quad \int_0^\infty e^{-\frac{1}{2}t} t^{\mu - \frac{1}{2}(\nu+1)} M_{\kappa,\mu}(t) J_\nu(2\sqrt{xt}) dt = \frac{\Gamma(1 + 2\mu)}{\Gamma(\frac{1}{2} - \mu + \kappa + \nu)} e^{-\frac{1}{2}x} x^{\frac{1}{2}(\kappa - \mu - \frac{3}{2})} M_{\frac{1}{2}(\kappa + 3\mu - \nu + \frac{1}{2}), \frac{1}{2}(\kappa - \mu + \nu - \frac{1}{2})}(x), \\ x > 0, -\frac{1}{2} < \Re\mu < \Re(\kappa + \frac{1}{2}\nu) + \frac{3}{4},$$



$$13.23.10 \quad \frac{1}{\Gamma(1+2\mu)} \int_0^\infty e^{-\frac{1}{2}t} t^{\frac{1}{2}(\nu-1)-\mu} M_{\kappa,\mu}(t) J_\nu(2\sqrt{xt}) dt = \frac{e^{-\frac{1}{2}x} x^{\frac{1}{2}(\kappa+\mu-\frac{3}{2})}}{\Gamma(\frac{1}{2}+\mu+\kappa)} W_{\frac{1}{2}(\kappa-3\mu+\nu+\frac{1}{2}), \frac{1}{2}(\kappa+\mu-\nu-\frac{1}{2})}(x),$$

$$x > 0, -1 < \Re\nu < 2\Re(\mu+\kappa) + \frac{1}{2}.$$

$$13.23.11 \quad \int_0^\infty e^{\frac{1}{2}t} t^{\frac{1}{2}(\nu-1)-\mu} W_{\kappa,\mu}(t) J_\nu(2\sqrt{xt}) dt = \frac{\Gamma(\nu-2\mu+1)}{\Gamma(\frac{1}{2}+\mu-\kappa)} e^{\frac{1}{2}x} x^{\frac{1}{2}(\mu-\kappa-\frac{3}{2})} W_{\frac{1}{2}(\kappa+3\mu-\nu-\frac{1}{2}), \frac{1}{2}(\kappa-\mu+\nu+\frac{1}{2})}(x),$$

$$x > 0, \max(2\Re\mu-1, -1) < \Re\nu < 2\Re(\mu-\kappa) + \frac{3}{2},$$

$$13.23.12 \quad \int_0^\infty e^{-\frac{1}{2}t} t^{\frac{1}{2}(\nu-1)-\mu} W_{\kappa,\mu}(t) J_\nu(2\sqrt{xt}) dt = \frac{\Gamma(\nu-2\mu+1)}{\Gamma(\frac{3}{2}-\mu-\kappa+\nu)} e^{-\frac{1}{2}x} x^{\frac{1}{2}(\mu+\kappa-\frac{3}{2})} M_{\frac{1}{2}(\kappa-3\mu+\nu+\frac{1}{2}), \frac{1}{2}(\nu-\mu-\kappa+\frac{1}{2})}(x),$$

$$x > 0, \max(2\Re\mu-1, -1) < \Re\nu.$$

For additional Hankel transforms and also other Bessel transforms see Erdélyi *et al.* (1954b, §8.18) and Oberhettinger (1972, §1.16 and 3.4.42–46, 4.4.45–47, 5.94–97).

### 13.23(iv) Integral Transforms in terms of Whittaker Functions

Let  $f(x)$  be absolutely integrable on the interval  $[r, R]$  for all positive  $r < R$ ,  $f(x) = O(x^{\rho_0})$  as  $x \rightarrow 0+$ , and  $f(x) = O(e^{-\rho_1 x})$  as  $x \rightarrow +\infty$ , where  $\rho_1 > \frac{1}{2}$ . Then for  $\mu$  in the half-plane  $\Re\mu \geq \mu_1 > \max(-\rho_0, \Re\kappa - \frac{1}{2})$

$$13.23.13 \quad g(\mu) = \frac{1}{\Gamma(1+2\mu)} \int_0^\infty f(x) x^{-\frac{3}{2}} M_{\kappa,\mu}(x) dx,$$

$$13.23.14 \quad f(x) = \frac{1}{\pi i \sqrt{x}} \int_{\mu_1-i\infty}^{\mu_1+i\infty} \mu g(\mu) \Gamma(\frac{1}{2}+\mu-\kappa) W_{\kappa,\mu}(x) d\mu.$$

For additional integral transforms see Magnus *et al.* (1966, p. 189), Prudnikov *et al.* (1992b, §§4.3.39–4.3.42), and Wimp (1964).

### 13.23(v) Other Integrals

Additional integrals involving confluent hypergeometric functions can be found in Apelblat (1983, pp. 388–392), Erdélyi *et al.* (1954b), Gradshteyn and Ryzhik (2000, §7.6), and Prudnikov *et al.* (1990, §§1.13, 1.14, 2.19, 4.2.2). See also (13.16.2), (13.16.6), (13.16.7).

## 13.24 Series

### 13.24(i) Expansions in Series of Whittaker Functions

For expansions of arbitrary functions in series of  $M_{\kappa,\mu}(z)$  functions see Schäfer (1961b).

### 13.24(ii) Expansions in Series of Bessel Functions

For  $z \in \mathbb{C}$ , and again with the notation of §§10.2(ii) and 10.25(ii),

13.24.1

$$M_{\kappa,\mu}(z) = \Gamma(\kappa+\mu) 2^{2\kappa+2\mu} z^{\frac{1}{2}-\kappa} \sum_{s=0}^{\infty} (-1)^s \frac{(2\kappa+2\mu)_s (2\kappa)_s}{(1+2\mu)_s s!} (\kappa+\mu+s) I_{\kappa+\mu+s}\left(\frac{1}{2}z\right), \quad 2\mu, \kappa+\mu \neq -1, -2, -3, \dots,$$

and

$$13.24.2 \quad \frac{1}{\Gamma(1+2\mu)} M_{\kappa,\mu}(z) = 2^{2\mu} z^{\mu+\frac{1}{2}} \sum_{s=0}^{\infty} p_s^{(\mu)}(z) (2\sqrt{\kappa z})^{-2\mu-s} J_{2\mu+s}(2\sqrt{\kappa z}),$$

where  $p_0^{(\mu)}(z) = 1$ ,  $p_1^{(\mu)}(z) = \frac{1}{6}z^2$ , and higher polynomials  $p_s^{(\mu)}(z)$  are defined by

$$13.24.3 \quad \exp\left(-\frac{1}{2}z \left(\coth t - \frac{1}{t}\right)\right) \left(\frac{t}{\sinh t}\right)^{1-2\mu} = \sum_{s=0}^{\infty} p_s^{(\mu)}(z) \left(-\frac{t}{z}\right)^s.$$

(13.18.8) is a special case of (13.24.1).

Additional expansions in terms of Bessel functions are given in Luke (1959). See also López (1999).

For other series expansions see Prudnikov *et al.* (1990, §6.6). See also §13.26.

### 13.25 Products

13.25.1

$$M_{\kappa,\mu}(z) M_{\kappa,-\mu-1}(z) + \frac{(\frac{1}{2} + \mu + \kappa)(\frac{1}{2} + \mu - \kappa)}{4\mu(1 + \mu)(1 + 2\mu)^2} M_{\kappa,\mu+1}(z) M_{\kappa,-\mu}(z) = 1.$$

For integral representations, integrals, and series containing products of  $M_{\kappa,\mu}(z)$  and  $W_{\kappa,\mu}(z)$  see Erdélyi *et al.* (1953a, §6.15.3).

### 13.26 Addition and Multiplication Theorems

#### 13.26(i) Addition Theorems for $M_{\kappa,\mu}(z)$

The function  $M_{\kappa,\mu}(x + y)$  has the following expansions:

13.26.1 
$$e^{-\frac{1}{2}y} \left(\frac{x}{x+y}\right)^{\mu-\frac{1}{2}} \sum_{n=0}^{\infty} \frac{(-2\mu)_n}{n!} \left(\frac{-y}{\sqrt{x}}\right)^n \times M_{\kappa-\frac{1}{2}n,\mu-\frac{1}{2}n}(x), \quad |y| < |x|,$$

13.26.2 
$$e^{-\frac{1}{2}y} \left(\frac{x+y}{x}\right)^{\mu+\frac{1}{2}} \sum_{n=0}^{\infty} \frac{(\frac{1}{2} + \mu - \kappa)_n}{(1 + 2\mu)_n n!} \left(\frac{y}{\sqrt{x}}\right)^n \times M_{\kappa-\frac{1}{2}n,\mu+\frac{1}{2}n}(x),$$

13.26.3 
$$e^{-\frac{1}{2}y} \left(\frac{x+y}{x}\right)^{\kappa} \sum_{n=0}^{\infty} \frac{(\frac{1}{2} + \mu - \kappa)_n y^n}{n!(x+y)^n} M_{\kappa-n,\mu}(x), \quad \Re(y/x) > -\frac{1}{2},$$

13.26.4 
$$e^{\frac{1}{2}y} \left(\frac{x}{x+y}\right)^{\mu-\frac{1}{2}} \sum_{n=0}^{\infty} \frac{(-2\mu)_n}{n!} \left(\frac{-y}{\sqrt{x}}\right)^n \times M_{\kappa+\frac{1}{2}n,\mu-\frac{1}{2}n}(x), \quad |y| < |x|,$$

13.26.5 
$$e^{\frac{1}{2}y} \left(\frac{x+y}{x}\right)^{\mu+\frac{1}{2}} \sum_{n=0}^{\infty} \frac{(\frac{1}{2} + \mu + \kappa)_n}{(1 + 2\mu)_n n!} \left(\frac{-y}{\sqrt{x}}\right)^n \times M_{\kappa+\frac{1}{2}n,\mu+\frac{1}{2}n}(x),$$

13.26.6 
$$e^{\frac{1}{2}y} \left(\frac{x}{x+y}\right)^{\kappa} \sum_{n=0}^{\infty} \frac{(\frac{1}{2} + \mu + \kappa)_n y^n}{n!(x+y)^n} M_{\kappa+n,\mu}(x), \quad \Re((y+x)/x) > \frac{1}{2}.$$

#### 13.26(ii) Addition Theorems for $W_{\kappa,\mu}(z)$

The function  $W_{\kappa,\mu}(x + y)$  has the following expansions:

13.26.7 
$$e^{-\frac{1}{2}y} \left(\frac{x}{x+y}\right)^{\mu-\frac{1}{2}} \sum_{n=0}^{\infty} \frac{(\frac{1}{2} - \mu - \kappa)_n}{n!} \left(\frac{-y}{\sqrt{x}}\right)^n \times W_{\kappa-\frac{1}{2}n,\mu-\frac{1}{2}n}(x), \quad |y| < |x|,$$

13.26.8 
$$e^{-\frac{1}{2}y} \left(\frac{x+y}{x}\right)^{\mu+\frac{1}{2}} \sum_{n=0}^{\infty} \frac{(\frac{1}{2} + \mu - \kappa)_n}{n!} \left(\frac{-y}{\sqrt{x}}\right)^n \times W_{\kappa-\frac{1}{2}n,\mu+\frac{1}{2}n}(x), \quad |y| < |x|,$$

13.26.9 
$$e^{-\frac{1}{2}y} \left(\frac{x+y}{x}\right)^{\kappa} \sum_{n=0}^{\infty} \frac{(\frac{1}{2} + \mu - \kappa)_n (\frac{1}{2} - \mu - \kappa)_n}{n!} \times \left(\frac{y}{x+y}\right)^n W_{\kappa-n,\mu}(x), \quad \Re(y/x) > -\frac{1}{2},$$

13.26.10 
$$e^{\frac{1}{2}y} \left(\frac{x}{x+y}\right)^{\mu-\frac{1}{2}} \sum_{n=0}^{\infty} \frac{1}{n!} \left(\frac{-y}{\sqrt{x}}\right)^n \times W_{\kappa+\frac{1}{2}n,\mu-\frac{1}{2}n}(x), \quad |y| < |x|,$$

13.26.11 
$$e^{\frac{1}{2}y} \left(\frac{x+y}{x}\right)^{\mu+\frac{1}{2}} \sum_{n=0}^{\infty} \frac{1}{n!} \left(\frac{-y}{\sqrt{x}}\right)^n \times W_{\kappa+\frac{1}{2}n,\mu+\frac{1}{2}n}(x), \quad |y| < |x|,$$

13.26.12 
$$e^{\frac{1}{2}y} \left(\frac{x}{x+y}\right)^{\kappa} \sum_{n=0}^{\infty} \frac{1}{n!} \left(\frac{-y}{x+y}\right)^n W_{\kappa+n,\mu}(x), \quad \Re(y/x) > -\frac{1}{2}.$$

#### 13.26(iii) Multiplication Theorems for $M_{\kappa,\mu}(z)$ and $W_{\kappa,\mu}(z)$

To obtain similar expansions for  $M_{\kappa,\mu}(xy)$  and  $W_{\kappa,\mu}(xy)$ , replace  $y$  in the previous two subsections by  $(y - 1)x$ .

## Applications

### 13.27 Mathematical Applications

Confluent hypergeometric functions are connected with representations of the group of third-order triangular matrices. The elements of this group are of the form

13.27.1 
$$g = \begin{pmatrix} 1 & \alpha & \beta \\ 0 & \gamma & \delta \\ 0 & 0 & 1 \end{pmatrix},$$

where  $\alpha, \beta, \gamma, \delta$  are real numbers, and  $\gamma > 0$ . Vilenkin (1968, Chapter 8) constructs irreducible representations of this group, in which the diagonal matrices correspond to operators of multiplication by an exponential function. The other group elements correspond to integral operators whose kernels can be expressed in terms of Whittaker functions. This identification can be used to obtain various properties of the Whittaker functions, including recurrence relations and derivatives.

For applications of Whittaker functions to the uniform asymptotic theory of differential equations with a coalescing turning point and simple pole see §§2.8(vi) and 18.15(i).

## 13.28 Physical Applications

### 13.28(i) Exact Solutions of the Wave Equation

The reduced wave equation  $\nabla^2 w = k^2 w$  in paraboloidal coordinates,  $x = 2\sqrt{\xi\eta}\cos\phi$ ,  $y = 2\sqrt{\xi\eta}\sin\phi$ ,  $z = \xi - \eta$ , can be solved via separation of variables  $w = f_1(\xi)f_2(\eta)e^{ip\phi}$ , where

#### 13.28.1

$$f_1(\xi) = \xi^{-\frac{1}{2}} V_{\kappa, \frac{1}{2}p}^{(1)}(2ik\xi), \quad f_2(\eta) = \eta^{-\frac{1}{2}} V_{\kappa, \frac{1}{2}p}^{(2)}(-2ik\eta),$$

and  $V_{\kappa, \mu}^{(j)}(z)$ ,  $j = 1, 2$ , denotes any pair of solutions of Whittaker's equation (13.14.1). See Hochstadt (1971, Chapter 7).

For potentials in quantum mechanics that are solvable in terms of confluent hypergeometric functions see Negro *et al.* (2000).

### 13.28(ii) Coulomb Functions

See Chapter 33.

### 13.28(iii) Other Applications

For dynamics of many-body systems see Meden and Schönhammer (1992); for tomography see D'Ariano *et al.* (1994); for generalized coherent states see Barut and Girardello (1971); for relativistic cosmology see Crisóstomo *et al.* (2004).

## Computation

## 13.29 Methods of Computation

### 13.29(i) Series Expansions

Although the Maclaurin series expansion (13.2.2) converges for all finite values of  $z$ , it is cumbersome to use when  $|z|$  is large owing to slowness of convergence and cancellation. For large  $|z|$  the asymptotic expansions of §13.7 should be used instead. Accuracy is limited by the magnitude of  $|z|$ . However, this accuracy can be increased considerably by use of the exponentially-improved forms of expansion supplied by the combination of (13.7.10) and (13.7.11), or by use of the hyperasymptotic expansions given in Olde Daalhuis and Olver (1995a). For large values of the parameters  $a$  and  $b$  the approximations in §13.8 are available.

Similarly for the Whittaker functions.

### 13.29(ii) Differential Equations

A comprehensive and powerful approach is to integrate the differential equations (13.2.1) and (13.14.1) by direct numerical methods. As described in §3.7(ii), to insure stability the integration path must be chosen in such a way that as we proceed along it the wanted solution grows in magnitude at least as fast as all other solutions of the differential equation.

For  $M(a, b, z)$  and  $M_{\kappa, \mu}(z)$  this means that in the sector  $|\text{ph } z| \leq \pi$  we may integrate along outward rays from the origin with initial values obtained from (13.2.2) and (13.14.2).

For  $U(a, b, z)$  and  $W_{\kappa, \mu}(z)$  we may integrate along outward rays from the origin in the sectors  $\frac{1}{2}\pi < |\text{ph } z| < \frac{3}{2}\pi$ , with initial values obtained from connection formulas in §13.2(vii), §13.14(vii). In the sector  $|\text{ph } z| < \frac{1}{2}\pi$  the integration has to be towards the origin, with starting values computed from asymptotic expansions (§§13.7 and 13.19). On the rays  $\text{ph } z = \pm \frac{1}{2}\pi$ , integration can proceed in either direction.

### 13.29(iii) Integral Representations

The integral representations (13.4.1) and (13.4.4) can be used to compute the Kummer functions, and (13.16.1) and (13.16.5) for the Whittaker functions. In Allasia and Besenghi (1991) and Allasia and Besenghi (1987b) the high accuracy of the trapezoidal rule for the computation of Kummer functions is described. Gauss quadrature methods are discussed in Gautschi (2002b).

### 13.29(iv) Recurrence Relations

The recurrence relations in §§13.3(i) and 13.15(i) can be used to compute the confluent hypergeometric functions in an efficient way. In the following two examples Olver's algorithm (§3.6(v)) can be used.

#### Example 1

We assume  $2\mu \neq -1, -2, -3, \dots$ . Then we have

$$\begin{aligned} & \frac{z^2(n + \mu - \frac{1}{2})((n + \mu + \frac{1}{2})^2 - \kappa^2)}{(n + \mu)(n + \mu + \frac{1}{2})(n + \mu + 1)} y(n + 1) \\ \text{13.29.1} \quad & + 16((n + \mu)^2 - \frac{1}{2}\kappa z - \frac{1}{4}) y(n) \\ & - 16((n + \mu)^2 - \frac{1}{4}) y(n - 1) = 0, \end{aligned}$$

with recessive solution

$$\text{13.29.2} \quad y(n) = z^{-n-\mu-\frac{1}{2}} M_{\kappa, n+\mu}(z),$$

normalizing relation

$$\text{13.29.3} \quad e^{-\frac{1}{2}z} = \sum_{s=0}^{\infty} \frac{(2\mu)_s (\frac{1}{2} + \mu - \kappa)_s}{(2\mu)_{2s} s!} (-z)^s y(s),$$

and estimate

$$\text{13.29.4} \quad y(n) = 1 + O(n^{-1}), \quad n \rightarrow \infty.$$

**Example 2**

We assume  $a, a + 1 - b \neq 0, -1, -2, \dots$ . Then we have

$$13.29.5 \quad (n+a)w(n) - (2(n+a+1) + z - b)w(n+1) \\ + (n+a-b+2)w(n+2) = 0,$$

with recessive solution

$$13.29.6 \quad w(n) = (a)_n U(n+a, b, z),$$

normalizing relation

$$13.29.7 \quad z^{-a} = \sum_{s=0}^{\infty} \frac{(a-b+1)_s}{s!} w(s),$$

and estimate

$$13.29.8 \quad w(n) \sim \frac{\sqrt{\pi} e^{\frac{1}{2}z} z^{\frac{1}{4}(4a-2b+1)}}{\Gamma(a)\Gamma(a+1-b)} n^{\frac{1}{4}(4a-2b-3)} e^{-2\sqrt{nz}},$$

as  $n \rightarrow \infty$ . See Temme (1983), and also Wimp (1984, Chapter 5).

**13.30 Tables**

- Žurina and Osipova (1964) tabulates  $M(a, b, x)$  and  $U(a, b, x)$  for  $b = 2$ ,  $a = -0.98(.02)1.10$ ,  $x = 0(.01)4$ , 7D or 7S.
- Slater (1960) tabulates  $M(a, b, x)$  for  $a = -1(.1)1$ ,  $b = 0.1(.1)1$ , and  $x = 0.1(.1)10$ , 7–9S;  $M(a, b, 1)$  for  $a = -11(.2)2$  and  $b = -4(.2)1$ , 7D; the smallest positive  $x$ -zero of  $M(a, b, x)$  for  $a = -4(.1)-0.1$  and  $b = 0.1(.1)2.5$ , 7D.
- Abramowitz and Stegun (1964, Chapter 13) tabulates  $M(a, b, x)$  for  $a = -1(.1)1$ ,  $b = 0.1(.1)1$ , and  $x = 0.1(.1)1(1)10$ , 8S. Also the smallest positive  $x$ -zero of  $M(a, b, x)$  for  $a = -1(.1)-0.1$  and  $b = 0.1(.1)1$ , 7D.
- Zhang and Jin (1996, pp. 411–423) tabulates  $M(a, b, x)$  and  $U(a, b, x)$  for  $a = -5(.5)5$ ,  $b = 0.5(.5)5$ , and  $x = 0.1, 1, 5, 10, 20, 30$ , 8S (for  $M(a, b, x)$ ) and 7S (for  $U(a, b, x)$ ).

For other tables prior to 1961 see Fletcher *et al.* (1962) and Lebedev and Fedorova (1960).

**13.31 Approximations****13.31(i) Chebyshev-Series Expansions**

Luke (1969b, pp. 35 and 25) provides Chebyshev-series expansions of  $M(a, b, x)$  and  $U(a, b, x)$  that include the intervals  $0 \leq x \leq \alpha$  and  $\alpha \leq x < \infty$ , respectively, where  $\alpha$  is an arbitrary positive constant.

**13.31(ii) Padé Approximations**

For a discussion of the convergence of the Padé approximants that are related to the continued fraction (13.5.1) see Wimp (1985).

**13.31(iii) Rational Approximations**

In Luke (1977a) the following rational approximation is given, together with its rate of convergence. For the notation see §16.2(i).

Let  $a, a + 1 - b \neq 0, -1, -2, \dots$ ,  $|\operatorname{ph} z| < \pi$ ,

**13.31.1**

$$A_n(z) = \sum_{s=0}^n \frac{(-n)_s (n+1)_s (a)_s (b)_s}{(a+1)_s (b+1)_s (n!)^2} \\ \times {}_3F_3 \left( \begin{matrix} -n+s, n+1+s, 1 \\ 1+s, a+1+s, b+1+s \end{matrix}; -z \right),$$

and

$$13.31.2 \quad B_n(z) = {}_2F_2 \left( \begin{matrix} -n, n+1 \\ a+1, b+1 \end{matrix}; -z \right).$$

Then

$$13.31.3 \quad z^a U(a, 1+a-b, z) = \lim_{n \rightarrow \infty} \frac{A_n(z)}{B_n(z)}.$$

**13.32 Software**

See <http://dlmf.nist.gov/13.32>.

**References****General References**

The main references used in writing this chapter are Buchholz (1969), Erdélyi *et al.* (1953a), Olver (1997b), Slater (1960), and Temme (1996a). For additional bibliographic reading see Andrews *et al.* (1999), Hochstadt (1971), Luke (1969a,b), Wang and Guo (1989), and Whittaker and Watson (1927).

**Sources**

The following list gives the references or other indications of proofs that were used in constructing the various sections this chapter. These sources supplement the references that are quoted in the text.

§13.2 Olver (1997b, Chapter 7, §§3, 9, 10), Slater (1960, §§1.5, 1.5.1, 2.1.2), and Temme (1996a, §§7.1, 7.2). (13.2.7) and (13.2.8) are terminating forms of the asymptotic expansion (13.7.3) (that the  $\sim$  sign can be replaced by  $=$  in these circumstances follows from (13.7.4) and (13.7.5).)

To verify (13.2.12) replace the  $U$  functions by  $\mathbf{M}$  functions by means of (13.2.42) and (13.2.4), then recall that each  $\mathbf{M}$  function is an entire function of  $z$ . For (13.2.13)–(13.2.22) see Temme (1996a, Ex. 7.6: an error in the equation that corresponds to (13.2.19) has been corrected). For (13.2.23) see (13.7.2). (13.2.27)–(13.2.32) are obtained by considering limiting forms of the connection formulas in §13.2(vii); see Olver (1997b, Chapter 7, Ex. 10.6) and Slater (1960, §§1.5–1.5.1).

§13.3 Slater (1960, §§2.1, 2.2). Note that in this reference (2.2.7) and (2.1.32) contain errors. The correct versions are (13.3.13) and (13.3.28), respectively. To see that (13.3.13) and (13.3.14) are equivalent to (13.2.1) use (13.3.16) and (13.3.23). For the operator identity (13.3.29) see Fleury and Turbiner (1994).

§13.4 Buchholz (1969, §1.4), Erdélyi *et al.* (1953a, §6.11), and Slater (1960, Chapter 3). For (13.4.5) use (13.2.41); compare the proof of Lemma 3.1 in Olde Daalhuis and Olver (1994). For (13.4.16)–(13.4.18) combine the results of Buchholz (1969, §5.4) with (13.14.2), (13.14.3).

§13.5 Jones and Thron (1980, Theorems 6.3 and 6.5).

§13.6 See Temme (1996a, §§7.2–7.3 and p. 254) and Buchholz (1969, §3.3). In the former reference each of the equations on p. 180 that correspond to (13.6.7) and (13.6.8) contains an error. For (13.6.16)–(13.6.18) combine §13.6(iv) with §12.7(i) and (18.5.18). (The last equation is needed to illustrate that  $x^n H_n(x)$  is an even function of  $x$ .) For (13.6.19) see (18.11.2). For (13.6.20) combine (18.20.8) with (16.2.3), replace the  ${}_1F_1$  notation by  $M$  (§13.1), and then use (13.2.42) (in which the final term vanishes). Alternatively, for (13.6.20) combine (16.2.3) with Andrews *et al.* (1999, p. 347). When neither  $a$  nor  $a - b + 1$  is a nonpositive integer (13.6.21) can be verified by comparison of (13.4.17) and (16.5.1). If  $a$  is a nonpositive integer, then both sides of (13.6.21) reduce to a polynomial in  $z$  (compare §§13.2(i) and 16.2(iv)), and (13.6.21) follows by comparing coefficients. Similarly if  $a - b + 1$  is a nonpositive integer, then both sides of (13.6.21) reduce to  $z^{1-b}$  times a polynomial in  $z$  with identical coefficients.

§13.7 Temme (1996a, §7.2) or Olver (1997b, pp. 256–258), and Olver (1965).

§13.8 Slater (1960, §4.3), Temme (1978), and Temme (1990b). For (13.8.2) and (13.8.3) use Watson's

lemma for loop integrals (Olver (1997b, §4.5) and (13.4.10).

§13.9 Buchholz (1969, Chapter 17), Erdélyi *et al.* (1953a, §6.16), Slater (1960, Chapter 6), and Tricomi (1950a). The proof of (13.9.8) is given in Tricomi (1947). (13.9.9) follows from (13.7.2). For the paragraph following (13.9.9) see Andrews *et al.* (1999, §4.16). For (13.9.10) and (13.9.16) use (13.8.9), (13.8.10), and the asymptotics of zeros of Bessel functions (§10.21(vi)). For the final paragraph of §13.9(ii) apply Kummer's transformation (13.2.39) to the final term in the connection relation (13.2.42) and then use the asymptotic relation (13.8.1).

§13.10 Erdélyi *et al.* (1953a, §§6.10, 6.15.2) and Slater (1960, Chapter 3). Also Buchholz (1969, §11.1), including the references given there. (13.10.14) and (13.10.16) are from Erdélyi *et al.* (1954b, §8.18). For (13.10.14) substitute the integral (13.4.1) for  $\mathbf{M}(a, b, t)$ , interchange the order of integration, then apply (13.4.3) and (13.6.1) followed by (13.4.4). For (13.10.16) interchange the roles of (13.4.1) and (13.4.4).

§13.11 Slater (1960, §2.7.3: Eq. (2.7.14) has errors).

§13.12 (13.12.1) follows from the fact that its left-hand side is bounded at infinity: use (13.2.39), (13.2.41), and (13.7.3).

§13.13 Erdélyi *et al.* (1953a, §6.14) and Slater (1960, §§2.3–2.3.3). In the first reference Equation (2) needs the constraint  $|\lambda - 1| < 1$  and Equation (6) should have no constraint. In the second reference Eq. (2.3.6) contains an error:  $(x + y)^n$  should be replaced by  $(x + y)^{-n}$ .

§13.14 Olver (1997b, Chapter 7, §§9–11, and Ex. 11.2), Buchholz (1969, §2.3a), Slater (1960, §§1.7.1, 2.4.2), Temme (1996a, §7.2). For (13.14.8) and (13.14.9) take limiting values in (13.14.33), using (13.14.2) and (13.2.2). For (13.14.14)–(13.14.19) combine §13.2(iii) and (13.14.4), (13.14.5). For (13.14.20), (13.14.21) use (13.19.2), (13.19.3). For (13.14.32) and (13.14.33) combine (13.2.41) and (13.2.42) with (13.14.4) and (13.14.5). (13.14.31) follows from (13.14.33).

§13.15 Slater (1960, §§2.4, 2.4.1, 2.5). Note that (2.5.4) and (2.5.10) contain errors: the correct versions are (13.15.2) and (13.15.10), respectively.

§13.16 Buchholz (1969, §5.4), Erdélyi *et al.* (1953a, §6.11), and Slater (1960, Chapter 3). For §13.16(i) combine §13.4(i) with (13.14.4) and (13.14.5).

- §13.17 Jones and Thron (1980, Theorems 6.3 and 6.5).
- §13.18 Combine §13.6 with (13.14.4) and (13.14.5).
- §13.19 Temme (1996a, §7.2).
- §13.20 Olver (1997b, Chapter 7, §11.2). For (13.20.2) use (13.14.3) and apply the method of steepest descents (§2.4(iv)) to the integral representation (13.4.14).
- §13.21 Slater (1960, §4.4.3). The asymptotic approximations (13.21.2)–(13.21.4) follow from §13.21(ii) and (5.11.7).
- §13.22 Olver (1997b, Chapter 12, (7.05)).
- §13.23 Buchholz (1969, §§10, 11.1), Erdélyi *et al.* (1953a, §§6.10, 6.15.2), Slater (1960, Chapter 3), and Snow (1952, Chapter XI). (13.23.3) and (13.23.5) can also be derived as limiting forms of (13.23.1) and (13.23.4), respectively; compare (15.4.20). For (13.23.9)–(13.23.12) combine §13.10(v) with (13.14.4) and (13.14.5).
- §13.24 Slater (1960, §2.7.3) and Buchholz (1969, §7.4). In the first reference (2.7.16) contains an error.
- §13.25 For (13.25.1) combine (13.12.1) with (13.14.4).
- §13.26 Slater (1960, §§2.6–2.6.3). Note that (2.6.3) and (2.6.6) contain errors; the correct versions are (13.26.3) and (13.26.6), respectively.



## Chapter 14

# Legendre and Related Functions

T. M. Dunster<sup>1</sup>

<b>Notation</b>	<b>352</b>	14.20 Conical (or Mehler) Functions . . . . .	372
14.1 Special Notation . . . . .	352	<b>Complex Arguments</b>	<b>375</b>
<b>Real Arguments</b>	<b>352</b>	14.21 Definitions and Basic Properties . . . . .	375
14.2 Differential Equations . . . . .	352	14.22 Graphics . . . . .	375
14.3 Definitions and Hypergeometric Representations . . . . .	353	14.23 Values on the Cut . . . . .	376
14.4 Graphics . . . . .	355	14.24 Analytic Continuation . . . . .	376
14.5 Special Values . . . . .	359	14.25 Integral Representations . . . . .	377
14.6 Integer Order . . . . .	360	14.26 Uniform Asymptotic Expansions . . . . .	377
14.7 Integer Degree and Order . . . . .	360	14.27 Zeros . . . . .	377
14.8 Behavior at Singularities . . . . .	361	14.28 Sums . . . . .	377
14.9 Connection Formulas . . . . .	362	14.29 Generalizations . . . . .	377
14.10 Recurrence Relations and Derivatives . . . . .	362	<b>Applications</b>	<b>378</b>
14.11 Derivatives with Respect to Degree or Order	363	14.30 Spherical and Spheroidal Harmonics . . . . .	378
14.12 Integral Representations . . . . .	363	14.31 Other Applications . . . . .	379
14.13 Trigonometric Expansions . . . . .	364	<b>Computation</b>	<b>379</b>
14.14 Continued Fractions . . . . .	364	14.32 Methods of Computation . . . . .	379
14.15 Uniform Asymptotic Approximations . . . . .	365	14.33 Tables . . . . .	380
14.16 Zeros . . . . .	368	14.34 Software . . . . .	380
14.17 Integrals . . . . .	368	<b>References</b>	<b>380</b>
14.18 Sums . . . . .	370		
14.19 Toroidal (or Ring) Functions . . . . .	371		

<sup>1</sup>Department of Mathematics and Statistics, San Diego State University, San Diego, California.

**Acknowledgments:** This chapter is based in part on Abramowitz and Stegun (1964, Chapter 8) by Irene A. Stegun. The author is indebted to Richard Paris for correcting a long-standing error in Eq. (14.18.3) in previous literature.

**Copyright** © 2009 National Institute of Standards and Technology. All rights reserved.



## Notation

### 14.1 Special Notation

(For other notation see pp. xiv and 873.)

$x, y, \tau$	real variables.
$z = x + iy$	complex variable.
$m, n$	nonnegative integers used for order and degree, respectively.
$\mu, \nu$	general order and degree, respectively.
$-\frac{1}{2} + i\tau$	complex degree, $\tau \in \mathbb{R}$ .
$\gamma$	Euler's constant (§5.2(ii)).
$\delta$	arbitrary small positive constant.
$\psi(x)$	logarithmic derivative of gamma function (§5.2(i)).
$\psi'(x)$	$d\psi(x)/dx$ .
$\mathbf{F}(a, b; c; z)$	Olver's scaled hypergeometric function: $F(a, b; c; z)/\Gamma(c)$ .

Multivalued functions take their principal values (§4.2(i)) unless indicated otherwise.

The main functions treated in this chapter are the Legendre functions  $P_\nu(x), Q_\nu(x), P_\nu(z), Q_\nu(z)$ ; Ferrers functions  $P_\nu^\mu(x), Q_\nu^\mu(x)$  (also known as the Legendre functions on the cut); associated Legendre functions  $P_\nu^\mu(z), Q_\nu^\mu(z), \mathbf{Q}_\nu^\mu(z)$ ; conical functions  $P_{-\frac{1}{2}+i\tau}^\mu(x), Q_{-\frac{1}{2}+i\tau}^\mu(x), \widehat{Q}_{-\frac{1}{2}+i\tau}^\mu(x), P_{-\frac{1}{2}+i\tau}^\mu(x), Q_{-\frac{1}{2}+i\tau}^\mu(x)$  (also known as Mehler functions).

Among other notations commonly used in the literature Erdélyi *et al.* (1953a) and Olver (1997b) denote  $P_\nu^\mu(x)$  and  $Q_\nu^\mu(x)$  by  $P_\nu^\mu(x)$  and  $Q_\nu^\mu(x)$ , respectively. Magnus *et al.* (1966) denotes  $P_\nu^\mu(x), Q_\nu^\mu(x), P_\nu^\mu(z),$  and  $Q_\nu^\mu(z)$  by  $P_\nu^\mu(x), Q_\nu^\mu(x), \mathfrak{P}_\nu^\mu(z),$  and  $\mathfrak{Q}_\nu^\mu(z)$ , respectively. Hobson (1931) denotes both  $P_\nu^\mu(x)$  and  $P_\nu^\mu(x)$  by  $P_\nu^\mu(x)$ ; similarly for  $Q_\nu^\mu(x)$  and  $Q_\nu^\mu(x)$ .

## Real Arguments

### 14.2 Differential Equations

#### 14.2(i) Legendre's Equation

**14.2.1**  $(1 - x^2) \frac{d^2w}{dx^2} - 2x \frac{dw}{dx} + \nu(\nu + 1)w = 0.$

Standard solutions:  $P_\nu(\pm x), Q_\nu(\pm x), Q_{-\nu-1}(\pm x), P_\nu(\pm x), Q_\nu(\pm x), Q_{-\nu-1}(\pm x)$ .  $P_\nu(x)$  and  $Q_\nu(x)$  are real when  $\nu \in \mathbb{R}$  and  $x \in (-1, 1)$ , and  $P_\nu(x)$  and  $Q_\nu(x)$  are real when  $\nu \in \mathbb{R}$  and  $x \in (1, \infty)$ .

#### 14.2(ii) Associated Legendre Equation

**14.2.2**

$$(1 - x^2) \frac{d^2w}{dx^2} - 2x \frac{dw}{dx} + \left( \nu(\nu + 1) - \frac{\mu^2}{1 - x^2} \right) w = 0.$$

Standard solutions:  $P_\nu^\mu(\pm x), P_\nu^{-\mu}(\pm x), Q_\nu^\mu(\pm x), Q_\nu^{-\mu}(\pm x), P_\nu^\mu(\pm x), P_\nu^{-\mu}(\pm x), \mathbf{Q}_\nu^\mu(\pm x), \mathbf{Q}_\nu^{-\mu}(\pm x)$ .

(14.2.2) reduces to (14.2.1) when  $\mu = 0$ . Ferrers functions and the associated Legendre functions are related to the Legendre functions by the equations  $P_\nu^0(x) = P_\nu(x), Q_\nu^0(x) = Q_\nu(x), P_\nu^0(x) = P_\nu(x), Q_\nu^0(x) = Q_\nu(x), \mathbf{Q}_\nu^0(x) = \mathbf{Q}_\nu(x) = Q_\nu(x)/\Gamma(\nu + 1)$ .

$P_\nu^\mu(x), P_{-\frac{1}{2}+i\tau}^\mu(x),$  and  $Q_\nu^\mu(x)$  are real when  $\nu, \mu,$  and  $\tau \in \mathbb{R}$ , and  $x \in (-1, 1)$ ;  $P_\nu^\mu(x), Q_\nu^\mu(x),$  and  $\mathbf{Q}_\nu^\mu(x)$  are real when  $\nu$  and  $\mu \in \mathbb{R}$ , and  $x \in (1, \infty)$ .

Unless stated otherwise in §§14.2–14.20 it is assumed that the arguments of the functions  $P_\nu^\mu(x)$  and  $Q_\nu^\mu(x)$  lie in the interval  $(-1, 1)$ , and the arguments of the functions  $P_\nu^\mu(x), Q_\nu^\mu(x),$  and  $\mathbf{Q}_\nu^\mu(x)$  lie in the interval  $(1, \infty)$ . For extensions to complex arguments see §§14.21–14.28.

#### 14.2(iii) Numerically Satisfactory Solutions

Equation (14.2.2) has regular singularities at  $x = 1, -1,$  and  $\infty$ , with exponent pairs  $\{-\frac{1}{2}\mu, \frac{1}{2}\mu\}, \{-\frac{1}{2}\mu, \frac{1}{2}\mu\},$  and  $\{-\nu - 1, \nu\}$ , respectively; compare §2.7(i).

When  $\mu - \nu \neq 0, -1, -2, \dots,$  and  $\mu + \nu \neq -1, -2, -3, \dots,$   $P_\nu^{-\mu}(x)$  and  $P_\nu^{-\mu}(-x)$  are linearly independent, and when  $\Re\mu \geq 0$  they are recessive at  $x = 1$  and  $x = -1$ , respectively. Hence they comprise a numerically satisfactory pair of solutions (§2.7(iv)) of (14.2.2) in the interval  $-1 < x < 1$ . When  $\mu - \nu = 0, -1, -2, \dots,$  or  $\mu + \nu = -1, -2, -3, \dots,$   $P_\nu^{-\mu}(x)$  and  $P_\nu^{-\mu}(-x)$  are linearly dependent, and in these cases either may be paired with almost any linearly independent solution to form a numerically satisfactory pair.

When  $\Re\mu \geq 0$  and  $\Re\nu \geq -\frac{1}{2},$   $P_\nu^{-\mu}(x)$  and  $Q_\nu^\mu(x)$  are linearly independent, and recessive at  $x = 1$  and  $x = \infty$ , respectively. Hence they comprise a numerically satisfactory pair of solutions of (14.2.2) in the interval  $1 < x < \infty$ . With the same conditions,  $P_\nu^{-\mu}(-x)$  and  $Q_\nu^\mu(-x)$  comprise a numerically satisfactory pair of solutions in the interval  $-\infty < x < -1$ .

#### 14.2(iv) Wronskians and Cross-Products

**14.2.3** 
$$\frac{\mathscr{W} \{P_\nu^{-\mu}(x), P_\nu^{-\mu}(-x)\}}{2} = \frac{\Gamma(\mu - \nu) \Gamma(\nu + \mu + 1) (1 - x^2)}{\Gamma(\nu + \mu + 1)}$$

**14.2.4** 
$$\mathscr{W} \{P_\nu^\mu(x), Q_\nu^\mu(x)\} = \frac{\Gamma(\nu + \mu + 1)}{\Gamma(\nu - \mu + 1) (1 - x^2)},$$

**14.2.5** 
$$P_{\nu+1}^\mu(x) Q_\nu^\mu(x) - P_\nu^\mu(x) Q_{\nu+1}^\mu(x) = \frac{\Gamma(\nu + \mu + 1)}{\Gamma(\nu - \mu + 2)},$$

$$14.2.6 \quad \mathscr{W} \{P_\nu^{-\mu}(x), Q_\nu^\mu(x)\} = \frac{\cos(\mu\pi)}{1-x^2},$$

$$14.2.7 \quad \mathscr{W} \{P_\nu^{-\mu}(x), P_\nu^\mu(x)\} = -\frac{2\sin(\mu\pi)}{\pi(x^2-1)},$$

$$14.2.8 \quad \mathscr{W} \{P_\nu^{-\mu}(x), Q_\nu^\mu(x)\} = -\frac{1}{\Gamma(\nu+\mu+1)(x^2-1)},$$

$$14.2.9 \quad \mathscr{W} \{Q_\nu^\mu(x), Q_{-\nu-1}^\mu(x)\} = \frac{\cos(\nu\pi)}{x^2-1},$$

14.2.10

$$\mathscr{W} \{P_\nu^\mu(x), Q_\nu^\mu(x)\} = -e^{\mu\pi i} \frac{\Gamma(\nu+\mu+1)}{\Gamma(\nu-\mu+1)(x^2-1)},$$

14.2.11

$$P_{\nu+1}^\mu(x) Q_\nu^\mu(x) - P_\nu^\mu(x) Q_{\nu+1}^\mu(x) = e^{\mu\pi i} \frac{\Gamma(\nu+\mu+1)}{\Gamma(\nu-\mu+2)}.$$

## 14.3 Definitions and Hypergeometric Representations

### 14.3(i) Interval $-1 < x < 1$

The following are real-valued solutions of (14.2.2) when  $\mu, \nu \in \mathbb{R}$  and  $x \in (-1, 1)$ .

#### Ferrers Function of the First Kind

$$14.3.1 \quad P_\nu^\mu(x) = \left(\frac{1+x}{1-x}\right)^{\mu/2} \mathbf{F}(\nu+1, -\nu; 1-\mu; \tfrac{1}{2} - \tfrac{1}{2}x).$$

#### Ferrers Function of the Second Kind

$$14.3.2 \quad Q_\nu^\mu(x) = \frac{\pi}{2\sin(\mu\pi)} \left( \cos(\mu\pi) \left(\frac{1+x}{1-x}\right)^{\mu/2} \mathbf{F}(\nu+1, -\nu; 1-\mu; \tfrac{1}{2} - \tfrac{1}{2}x) \right. \\ \left. - \frac{\Gamma(\nu+\mu+1)}{\Gamma(\nu-\mu+1)} \left(\frac{1-x}{1+x}\right)^{\mu/2} \mathbf{F}(\nu+1, -\nu; 1+\mu; \tfrac{1}{2} - \tfrac{1}{2}x) \right).$$

Here and elsewhere in this chapter

$$14.3.3 \quad \mathbf{F}(a, b; c; x) = \frac{1}{\Gamma(c)} F(a, b; c; x)$$

is Olver's hypergeometric function (§15.1).

$P_\nu^\mu(x)$  exists for all values of  $\mu$  and  $\nu$ .  $Q_\nu^\mu(x)$  is undefined when  $\mu + \nu = -1, -2, -3, \dots$

When  $\mu = m = 0, 1, 2, \dots$ , (14.3.1) reduces to

$$14.3.4 \quad P_\nu^m(x) = (-1)^m \frac{\Gamma(\nu+m+1)}{2^m \Gamma(\nu-m+1)} (1-x^2)^{m/2} \mathbf{F}(\nu+m+1, m-\nu; m+1; \tfrac{1}{2} - \tfrac{1}{2}x);$$

equivalently,

$$14.3.5 \quad P_\nu^m(x) = (-1)^m \frac{\Gamma(\nu+m+1)}{\Gamma(\nu-m+1)} \left(\frac{1-x}{1+x}\right)^{m/2} \mathbf{F}(\nu+1, -\nu; m+1; \tfrac{1}{2} - \tfrac{1}{2}x).$$

When  $\mu = m \in \mathbb{Z}$  (14.3.2) is replaced by its limiting value; see Hobson (1931, §132) for details. See also (14.3.12)–(14.3.14) for this case.

### 14.3(ii) Interval $1 < x < \infty$

#### Associated Legendre Function of the First Kind

$$14.3.6 \quad P_\nu^\mu(x) = \left(\frac{x+1}{x-1}\right)^{\mu/2} \mathbf{F}(\nu+1, -\nu; 1-\mu; \tfrac{1}{2} - \tfrac{1}{2}x).$$

**Associated Legendre Function of the Second Kind**

14.3.7

$$Q_{\nu}^{\mu}(x) = e^{\mu\pi i} \frac{\pi^{1/2} \Gamma(\nu + \mu + 1) (x^2 - 1)^{\mu/2}}{2^{\nu+1} x^{\nu+\mu+1}} \mathbf{F}\left(\frac{1}{2}\nu + \frac{1}{2}\mu + 1, \frac{1}{2}\nu + \frac{1}{2}\mu + \frac{1}{2}; \nu + \frac{3}{2}; \frac{1}{x^2}\right), \quad \mu + \nu \neq -1, -2, -3, \dots$$

When  $\mu = m = 1, 2, 3, \dots$ , (14.3.6) reduces to

$$14.3.8 \quad P_{\nu}^m(x) = \frac{\Gamma(\nu + m + 1)}{2^m \Gamma(\nu - m + 1)} (x^2 - 1)^{m/2} \mathbf{F}(\nu + m + 1, m - \nu; m + 1; \frac{1}{2} - \frac{1}{2}x).$$

As standard solutions of (14.2.2) we take the pair  $P_{\nu}^{-\mu}(x)$  and  $Q_{\nu}^{\mu}(x)$ , where

$$14.3.9 \quad P_{\nu}^{-\mu}(x) = \left(\frac{x-1}{x+1}\right)^{\mu/2} \mathbf{F}(\nu + 1, -\nu; \mu + 1; \frac{1}{2} - \frac{1}{2}x),$$

and

$$14.3.10 \quad Q_{\nu}^{\mu}(x) = e^{-\mu\pi i} \frac{Q_{\nu}^{\mu}(x)}{\Gamma(\nu + \mu + 1)}.$$

Like  $P_{\nu}^{\mu}(x)$ , but unlike  $Q_{\nu}^{\mu}(x)$ ,  $Q_{\nu}^{\mu}(x)$  is real-valued when  $\nu, \mu \in \mathbb{R}$  and  $x \in (1, \infty)$ , and is defined for all values of  $\nu$  and  $\mu$ . The notation  $Q_{\nu}^{\mu}(x)$  is due to Olver (1997b, pp. 170 and 178).

**14.3(iii) Alternative Hypergeometric Representations**

$$14.3.11 \quad P_{\nu}^{\mu}(x) = \cos\left(\frac{1}{2}(\nu + \mu)\pi\right) w_1(\nu, \mu, x) + \sin\left(\frac{1}{2}(\nu + \mu)\pi\right) w_2(\nu, \mu, x),$$

$$14.3.12 \quad Q_{\nu}^{\mu}(x) = -\frac{1}{2}\pi \sin\left(\frac{1}{2}(\nu + \mu)\pi\right) w_1(\nu, \mu, x) + \frac{1}{2}\pi \cos\left(\frac{1}{2}(\nu + \mu)\pi\right) w_2(\nu, \mu, x),$$

where

$$14.3.13 \quad w_1(\nu, \mu, x) = \frac{2^{\mu} \Gamma\left(\frac{1}{2}\nu + \frac{1}{2}\mu + \frac{1}{2}\right)}{\Gamma\left(\frac{1}{2}\nu - \frac{1}{2}\mu + 1\right)} (1 - x^2)^{-\mu/2} \mathbf{F}\left(-\frac{1}{2}\nu - \frac{1}{2}\mu, \frac{1}{2}\nu - \frac{1}{2}\mu + \frac{1}{2}; \frac{1}{2}; x^2\right),$$

$$14.3.14 \quad w_2(\nu, \mu, x) = \frac{2^{\mu} \Gamma\left(\frac{1}{2}\nu + \frac{1}{2}\mu + 1\right)}{\Gamma\left(\frac{1}{2}\nu - \frac{1}{2}\mu + \frac{1}{2}\right)} x (1 - x^2)^{-\mu/2} \mathbf{F}\left(\frac{1}{2} - \frac{1}{2}\nu - \frac{1}{2}\mu, \frac{1}{2}\nu - \frac{1}{2}\mu + 1; \frac{3}{2}; x^2\right).$$

$$14.3.15 \quad P_{\nu}^{-\mu}(x) = 2^{-\mu} (x^2 - 1)^{\mu/2} \mathbf{F}\left(\mu - \nu, \nu + \mu + 1; \mu + 1; \frac{1}{2} - \frac{1}{2}x\right),$$

$$14.3.16 \quad \begin{aligned} \cos(\nu\pi) P_{\nu}^{-\mu}(x) &= \frac{2^{\nu} \pi^{1/2} x^{\nu-\mu} (x^2 - 1)^{\mu/2}}{\Gamma(\nu + \mu + 1)} \mathbf{F}\left(\frac{1}{2}\mu - \frac{1}{2}\nu, \frac{1}{2}\mu - \frac{1}{2}\nu + \frac{1}{2}; \frac{1}{2} - \nu; \frac{1}{x^2}\right) \\ &\quad - \frac{\pi^{1/2} (x^2 - 1)^{\mu/2}}{2^{\nu+1} \Gamma(\mu - \nu) x^{\nu+\mu+1}} \mathbf{F}\left(\frac{1}{2}\nu + \frac{1}{2}\mu + 1, \frac{1}{2}\nu + \frac{1}{2}\mu + \frac{1}{2}; \nu + \frac{3}{2}; \frac{1}{x^2}\right), \end{aligned}$$

$$14.3.17 \quad P_{\nu}^{-\mu}(x) = \frac{\pi (x^2 - 1)^{\mu/2}}{2^{\mu}} \left( \frac{\mathbf{F}\left(\frac{1}{2}\mu - \frac{1}{2}\nu, \frac{1}{2}\nu + \frac{1}{2}\mu + \frac{1}{2}; \frac{1}{2}; x^2\right)}{\Gamma\left(\frac{1}{2}\mu - \frac{1}{2}\nu + \frac{1}{2}\right) \Gamma\left(\frac{1}{2}\nu + \frac{1}{2}\mu + 1\right)} - \frac{x \mathbf{F}\left(\frac{1}{2}\mu - \frac{1}{2}\nu + \frac{1}{2}, \frac{1}{2}\nu + \frac{1}{2}\mu + 1; \frac{3}{2}; x^2\right)}{\Gamma\left(\frac{1}{2}\mu - \frac{1}{2}\nu\right) \Gamma\left(\frac{1}{2}\nu + \frac{1}{2}\mu + \frac{1}{2}\right)} \right),$$

$$14.3.18 \quad P_{\nu}^{-\mu}(x) = 2^{-\mu} x^{\nu-\mu} (x^2 - 1)^{\mu/2} \mathbf{F}\left(\frac{1}{2}\mu - \frac{1}{2}\nu, \frac{1}{2}\mu - \frac{1}{2}\nu + \frac{1}{2}; \mu + 1; 1 - \frac{1}{x^2}\right),$$

$$14.3.19 \quad Q_{\nu}^{\mu}(x) = \frac{2^{\nu} \Gamma(\nu + 1) (x + 1)^{\mu/2}}{(x - 1)^{(\mu/2) + \nu + 1}} \mathbf{F}\left(\nu + 1, \nu + \mu + 1; 2\nu + 2; \frac{2}{1 - x}\right),$$

$$14.3.20 \quad \begin{aligned} \frac{2 \sin(\mu\pi)}{\pi} Q_{\nu}^{\mu}(x) &= \frac{(x + 1)^{\mu/2}}{\Gamma(\nu + \mu + 1) (x - 1)^{\mu/2}} \mathbf{F}\left(\nu + 1, -\nu; 1 - \mu; \frac{1}{2} - \frac{1}{2}x\right) \\ &\quad - \frac{(x - 1)^{\mu/2}}{\Gamma(\nu - \mu + 1) (x + 1)^{\mu/2}} \mathbf{F}\left(\nu + 1, -\nu; \mu + 1; \frac{1}{2} - \frac{1}{2}x\right). \end{aligned}$$

For further hypergeometric representations of  $P_{\nu}^{\mu}(x)$  and  $Q_{\nu}^{\mu}(x)$  see Erdélyi *et al.* (1953a, pp. 123–139), Andrews *et al.* (1999, §3.1), Magnus *et al.* (1966, pp. 153–163), and §15.8(iv).

**14.3(iv) Relations to Other Functions**

In terms of the Gegenbauer function  $C_{\alpha}^{(\beta)}(x)$  and the Jacobi function  $\phi_{\lambda}^{(\alpha,\beta)}(t)$  (§§15.9(iii), 15.9(ii)):

14.3.21 
$$P_{\nu}^{\mu}(x) = \frac{2^{\mu} \Gamma(1 - 2\mu) \Gamma(\nu + \mu + 1)}{\Gamma(\nu - \mu + 1) \Gamma(1 - \mu) (1 - x^2)^{\mu/2}} C_{\nu+\mu}^{(\frac{1}{2}-\mu)}(x).$$

14.3.22 
$$P_{\nu}^{\mu}(x) = \frac{2^{\mu} \Gamma(1 - 2\mu) \Gamma(\nu + \mu + 1)}{\Gamma(\nu - \mu + 1) \Gamma(1 - \mu) (x^2 - 1)^{\mu/2}} C_{\nu+\mu}^{(\frac{1}{2}-\mu)}(x).$$

14.3.23 
$$P_{\nu}^{\mu}(x) = \frac{1}{\Gamma(1 - \mu)} \left( \frac{x+1}{x-1} \right)^{\mu/2} \phi_{-i(2\nu+1)}^{(-\mu,\mu)} \left( \operatorname{arcsinh} \left( \left( \frac{1}{2}x - \frac{1}{2} \right)^{1/2} \right) \right).$$

Compare also (18.11.1).

**14.4 Graphics**

**14.4(i) Ferrers Functions: 2D Graphs**

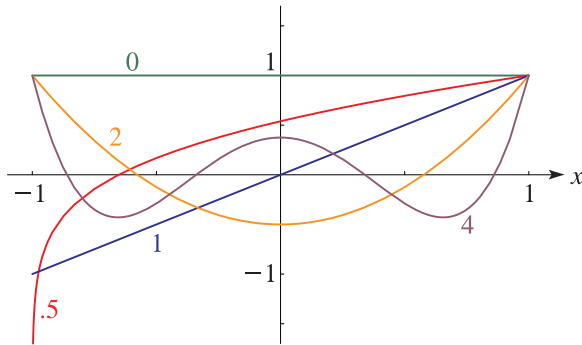


Figure 14.4.1:  $P_{\nu}^0(x), \nu = 0, \frac{1}{2}, 1, 2, 4.$

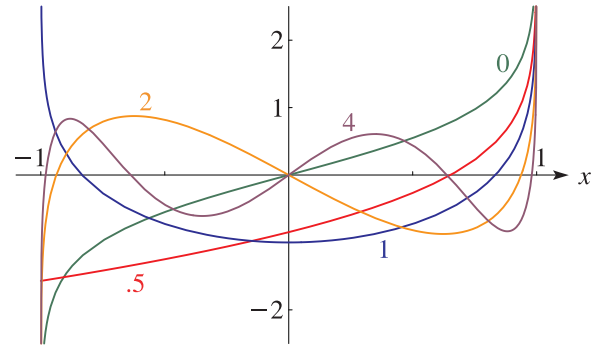


Figure 14.4.2:  $Q_{\nu}^0(x), \nu = 0, \frac{1}{2}, 1, 2, 4.$

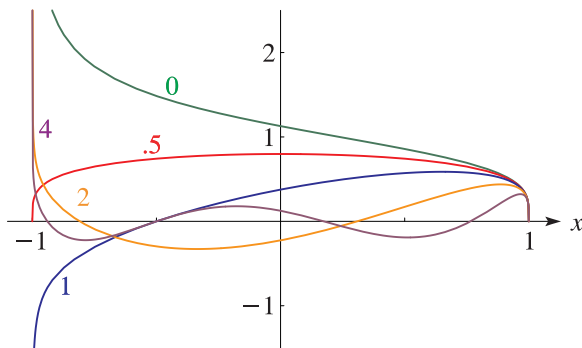


Figure 14.4.3:  $P_{\nu}^{-1/2}(x), \nu = 0, \frac{1}{2}, 1, 2, 4.$

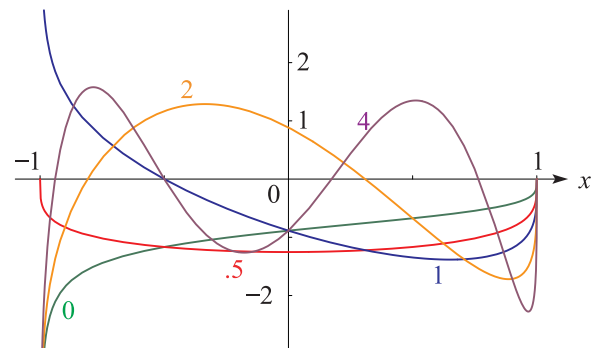


Figure 14.4.4:  $Q_{\nu}^{1/2}(x), \nu = 0, \frac{1}{2}, 1, 2, 4.$

For additional graphs see <http://dlmf.nist.gov/14.4.i>.

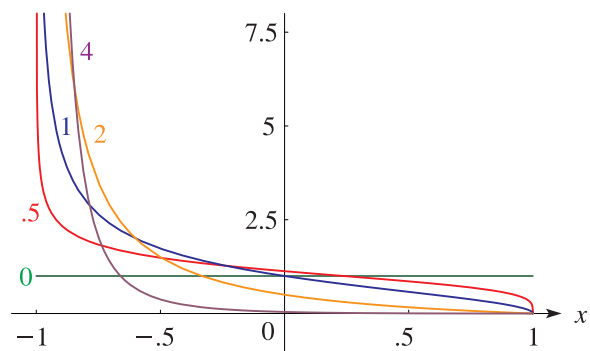


Figure 14.4.7:  $P_0^{-\mu}(x), \mu = 0, \frac{1}{2}, 1, 2, 4.$

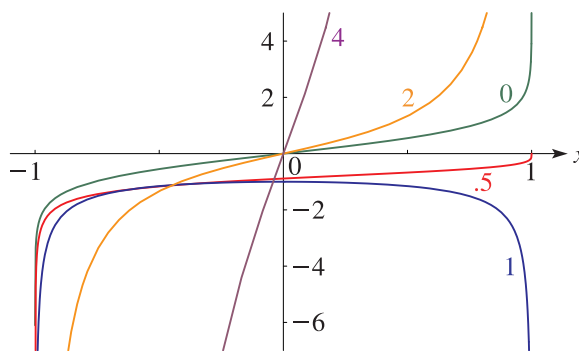


Figure 14.4.8:  $Q_0^{\mu}(x), \mu = 0, \frac{1}{2}, 1, 2, 4.$

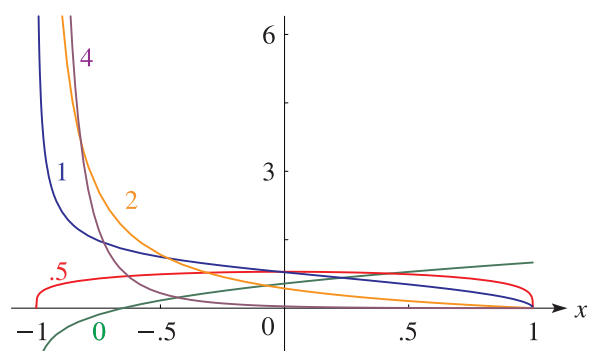


Figure 14.4.9:  $P_{1/2}^{-\mu}(x), \mu = 0, \frac{1}{2}, 1, 2, 4.$

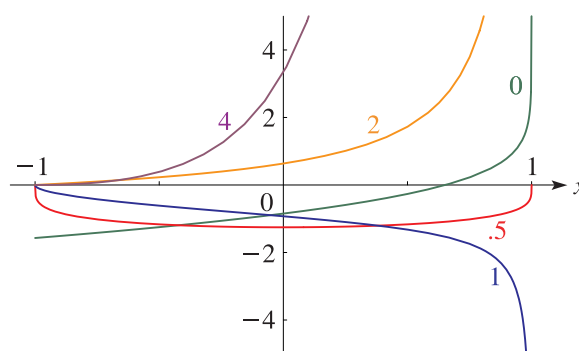


Figure 14.4.10:  $Q_{1/2}^{\mu}(x), \mu = 0, \frac{1}{2}, 1, 2, 4.$

For additional graphs see <http://dlmf.nist.gov/14.4.i>.

**14.4(ii) Ferrers Functions: 3D Surfaces**

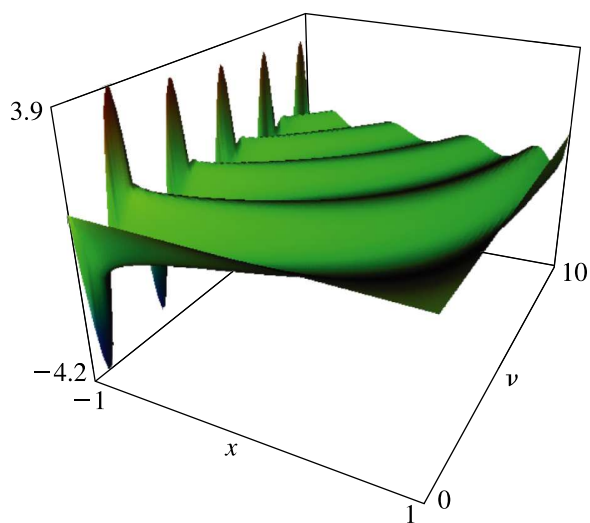


Figure 14.4.13:  $P_{\nu}^0(x), 0 \leq \nu \leq 10, -1 < x < 1.$

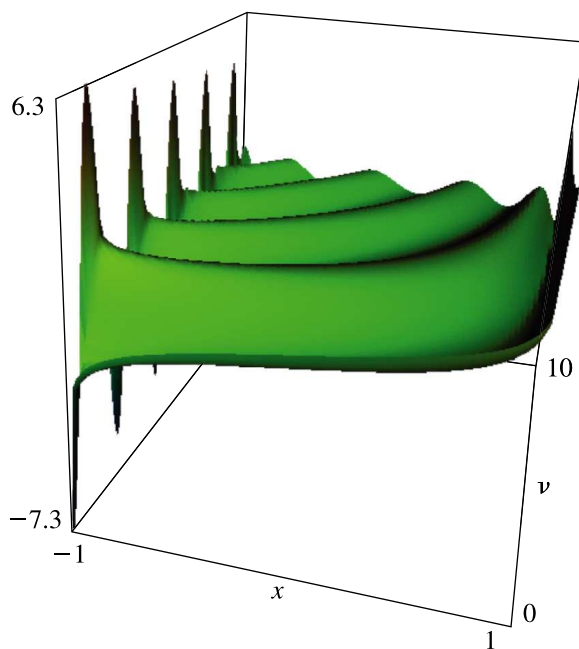


Figure 14.4.14:  $Q_{\nu}^0(x), 0 \leq \nu \leq 10, -1 < x < 1.$

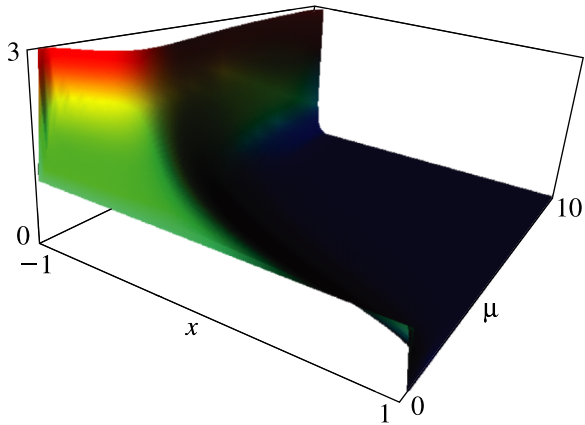


Figure 14.4.15:  $P_0^{-\mu}(x), 0 \leq \mu \leq 10, -1 < x < 1$ .

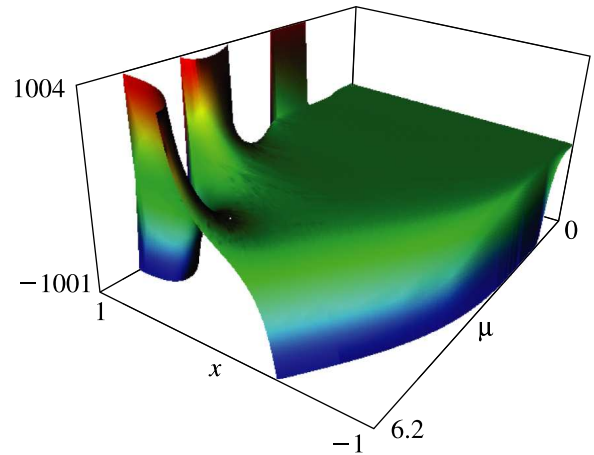


Figure 14.4.16:  $Q_0^\mu(x), 0 \leq \mu \leq 6.2, -1 < x < 1$ .

14.4(iii) Associated Legendre Functions: 2D Graphs

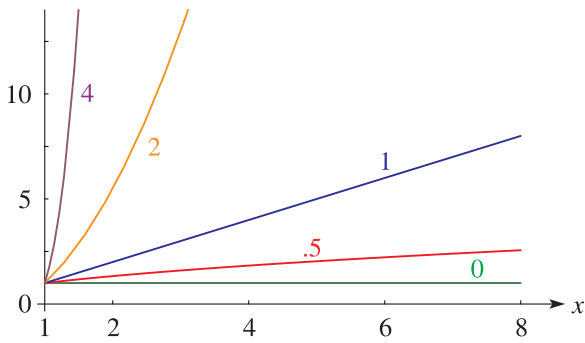


Figure 14.4.17:  $P_\nu^0(x), \nu = 0, \frac{1}{2}, 1, 2, 4$ .

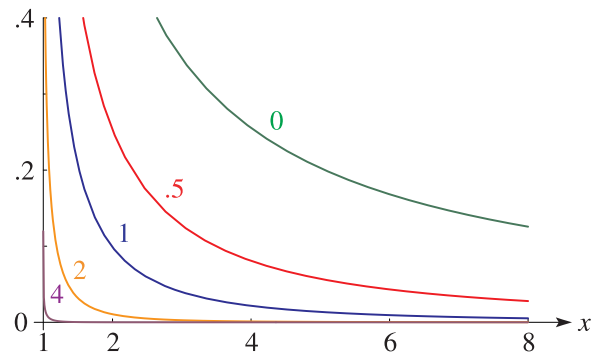


Figure 14.4.18:  $Q_\nu^0(x), \nu = 0, \frac{1}{2}, 1, 2, 4$ .

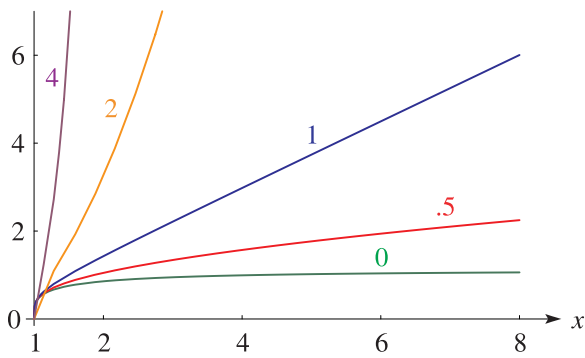


Figure 14.4.19:  $P_\nu^{-1/2}(x), \nu = 0, \frac{1}{2}, 1, 2, 4$ .

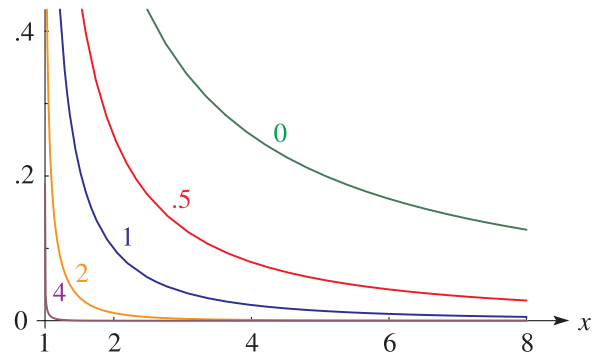


Figure 14.4.20:  $Q_\nu^{1/2}(x), \nu = 0, \frac{1}{2}, 1, 2, 4$ .

For additional graphs see <http://dlmf.nist.gov/14.4.iii>.

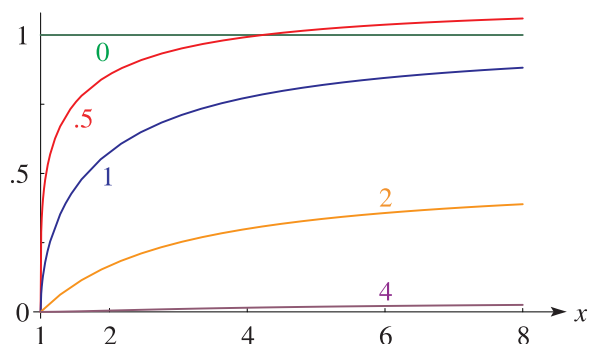


Figure 14.4.23:  $P_0^{-\mu}(x), \mu = 0, \frac{1}{2}, 1, 2, 4.$

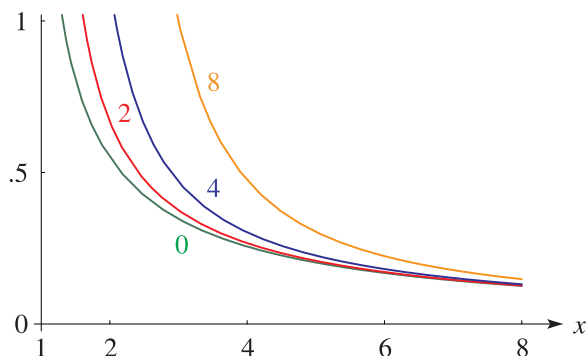


Figure 14.4.24:  $Q_0^{\mu}(x), \mu = 0, 2, 4, 8.$

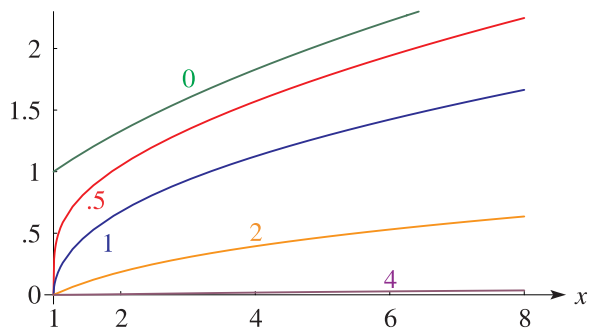


Figure 14.4.25:  $P_{1/2}^{-\mu}(x), \mu = 0, \frac{1}{2}, 1, 2, 4.$

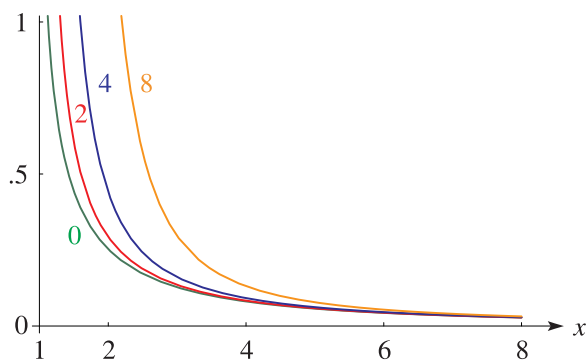


Figure 14.4.26:  $Q_{1/2}^{\mu}(x), \mu = 0, 2, 4, 8.$

For additional graphs see <http://dlmf.nist.gov/14.4.iii>.

**14.4(iv) Associated Legendre Functions: 3D Surfaces**

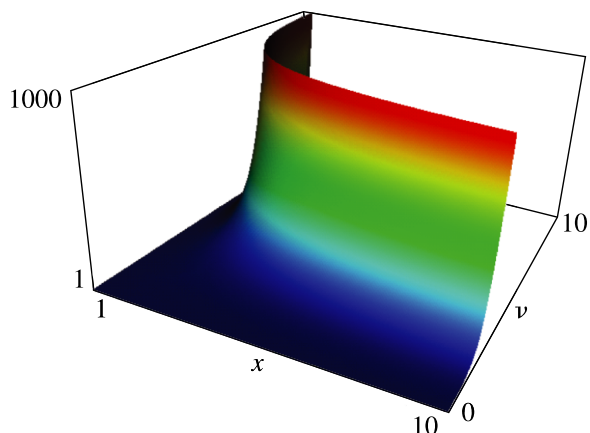


Figure 14.4.29:  $P_{\nu}^0(x), 0 \leq \nu \leq 10, 1 < x < 10.$

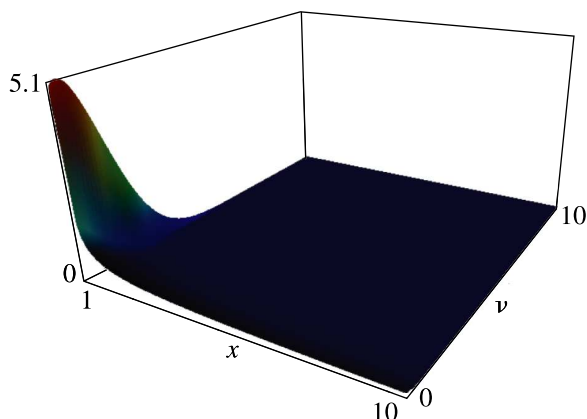


Figure 14.4.30:  $Q_{\nu}^0(x), 0 \leq \nu \leq 10, 1 < x < 10.$

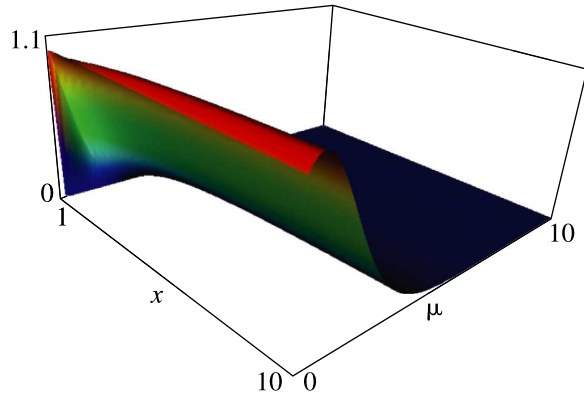


Figure 14.4.31:  $P_0^{-\mu}(x), 0 \leq \mu \leq 10, 1 < x < 10$ .

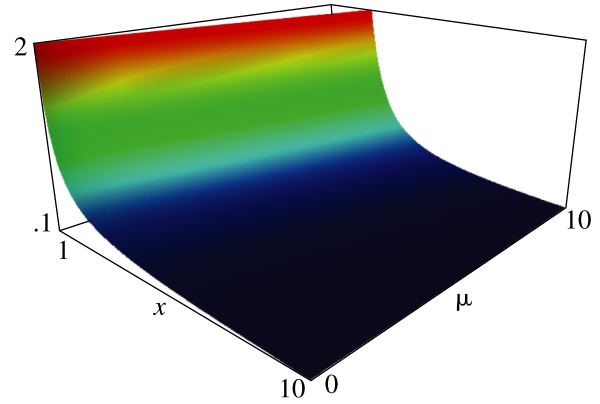


Figure 14.4.32:  $Q_0^\mu(x), 0 \leq \mu \leq 10, 1 < x < 10$ .

### 14.5 Special Values

#### 14.5(i) $x = 0$

$$14.5.1 \quad P_\nu^\mu(0) = \frac{2^\mu \pi^{1/2}}{\Gamma(\frac{1}{2}\nu - \frac{1}{2}\mu + 1) \Gamma(\frac{1}{2} - \frac{1}{2}\nu - \frac{1}{2}\mu)},$$

$$14.5.2 \quad \left. \frac{dP_\nu^\mu(x)}{dx} \right|_{x=0} = -\frac{2^{\mu+1} \pi^{1/2}}{\Gamma(\frac{1}{2}\nu - \frac{1}{2}\mu + \frac{1}{2}) \Gamma(-\frac{1}{2}\nu - \frac{1}{2}\mu)},$$

$$14.5.3 \quad Q_\nu^\mu(0) = -\frac{2^{\mu-1} \pi^{1/2} \sin(\frac{1}{2}(\nu + \mu)\pi) \Gamma(\frac{1}{2}\nu + \frac{1}{2}\mu + \frac{1}{2})}{\Gamma(\frac{1}{2}\nu - \frac{1}{2}\mu + 1)},$$

$\nu + \mu \neq -1, -3, -5, \dots$

$$14.5.4 \quad \left. \frac{dQ_\nu^\mu(x)}{dx} \right|_{x=0} = \frac{2^\mu \pi^{1/2} \cos(\frac{1}{2}(\nu + \mu)\pi) \Gamma(\frac{1}{2}\nu + \frac{1}{2}\mu + 1)}{\Gamma(\frac{1}{2}\nu - \frac{1}{2}\mu + \frac{1}{2})},$$

$\nu + \mu \neq -2, -4, -6, \dots$

#### 14.5(ii) $\mu = 0, \nu = 0, 1$

$$14.5.5 \quad P_0(x) = P_0(x) = 1,$$

$$14.5.6 \quad P_1(x) = P_1(x) = x.$$

$$14.5.7 \quad Q_0(x) = \frac{1}{2} \ln\left(\frac{1+x}{1-x}\right),$$

$$14.5.8 \quad Q_1(x) = \frac{x}{2} \ln\left(\frac{1+x}{1-x}\right) - 1.$$

$$14.5.9 \quad Q_0(x) = \frac{1}{2} \ln\left(\frac{x+1}{x-1}\right),$$

$$14.5.10 \quad Q_1(x) = \frac{x}{2} \ln\left(\frac{x+1}{x-1}\right) - 1.$$

#### 14.5(iii) $\mu = \pm \frac{1}{2}$

In this subsection and the next two,  $0 < \theta < \pi$  and  $\xi > 0$ .

$$14.5.11 \quad P_\nu^{1/2}(\cos \theta) = \left(\frac{2}{\pi \sin \theta}\right)^{1/2} \cos\left((\nu + \frac{1}{2})\theta\right),$$

$$14.5.12 \quad P_\nu^{-1/2}(\cos \theta) = \left(\frac{2}{\pi \sin \theta}\right)^{1/2} \frac{\sin\left((\nu + \frac{1}{2})\theta\right)}{\nu + \frac{1}{2}},$$

$$14.5.13 \quad Q_\nu^{1/2}(\cos \theta) = -\left(\frac{\pi}{2 \sin \theta}\right)^{1/2} \sin\left((\nu + \frac{1}{2})\theta\right),$$

$$14.5.14 \quad Q_\nu^{-1/2}(\cos \theta) = -\left(\frac{\pi}{2 \sin \theta}\right)^{1/2} \frac{\cos\left((\nu + \frac{1}{2})\theta\right)}{\nu + \frac{1}{2}}.$$

$$14.5.15 \quad P_\nu^{1/2}(\cosh \xi) = \left(\frac{2}{\pi \sinh \xi}\right)^{1/2} \cosh\left((\nu + \frac{1}{2})\xi\right),$$

$$14.5.16 \quad P_\nu^{-1/2}(\cosh \xi) = \left(\frac{2}{\pi \sinh \xi}\right)^{1/2} \frac{\sinh\left((\nu + \frac{1}{2})\xi\right)}{\nu + \frac{1}{2}},$$

$$14.5.17 \quad Q_\nu^{\pm 1/2}(\cosh \xi) = \left(\frac{\pi}{2 \sinh \xi}\right)^{1/2} \frac{\exp\left(-(\nu + \frac{1}{2})\xi\right)}{\Gamma(\nu + \frac{3}{2})}.$$

#### 14.5(iv) $\mu = -\nu$

$$14.5.18 \quad P_\nu^{-\nu}(\cos \theta) = \frac{(\sin \theta)^\nu}{2^\nu \Gamma(\nu + 1)},$$

$$14.5.19 \quad P_\nu^{-\nu}(\cosh \xi) = \frac{(\sinh \xi)^\nu}{2^\nu \Gamma(\nu + 1)}.$$



**14.5(v)  $\mu = 0, \nu = \pm \frac{1}{2}$**

In this subsection  $K(k)$  and  $E(k)$  denote the complete elliptic integrals of the first and second kinds; see §19.2(ii).

**14.5.20**  $P_{\frac{1}{2}}(\cos \theta) = \frac{2}{\pi} (2E(\sin(\frac{1}{2}\theta)) - K(\sin(\frac{1}{2}\theta))),$

**14.5.21**  $P_{-\frac{1}{2}}(\cos \theta) = \frac{2}{\pi} K(\sin(\frac{1}{2}\theta)),$

**14.5.22**  $Q_{\frac{1}{2}}(\cos \theta) = K(\cos(\frac{1}{2}\theta)) - 2E(\cos(\frac{1}{2}\theta)),$

**14.5.23**  $Q_{-\frac{1}{2}}(\cos \theta) = K(\cos(\frac{1}{2}\theta)).$

**14.5.24**  $P_{\frac{1}{2}}(\cosh \xi) = \frac{2}{\pi} e^{\xi/2} E((1 - e^{-2\xi})^{1/2}),$

**14.5.25**  $P_{-\frac{1}{2}}(\cosh \xi) = \frac{2}{\pi \cosh(\frac{1}{2}\xi)} K(\tanh(\frac{1}{2}\xi)),$

**14.5.26**  
 $Q_{\frac{1}{2}}(\cosh \xi) = 2\pi^{-1/2} \cosh \xi \operatorname{sech}(\frac{1}{2}\xi) K(\operatorname{sech}(\frac{1}{2}\xi))$   
 $- 4\pi^{-1/2} \cosh(\frac{1}{2}\xi) E(\operatorname{sech}(\frac{1}{2}\xi)),$

**14.5.27**  $Q_{-\frac{1}{2}}(\cosh \xi) = 2\pi^{-1/2} e^{-\xi/2} K(e^{-\xi}).$

**14.6 Integer Order**

**14.6(i) Nonnegative Integer Orders**

For  $m = 0, 1, 2, \dots,$

**14.6.1**  $P_{\nu}^m(x) = (-1)^m (1 - x^2)^{m/2} \frac{d^m P_{\nu}(x)}{dx^m},$

**14.6.2**  $Q_{\nu}^m(x) = (-1)^m (1 - x^2)^{m/2} \frac{d^m Q_{\nu}(x)}{dx^m}.$

**14.6.3**  $P_{\nu}^m(x) = (x^2 - 1)^{m/2} \frac{d^m P_{\nu}(x)}{dx^m},$

**14.6.4**  $Q_{\nu}^m(x) = (x^2 - 1)^{m/2} \frac{d^m Q_{\nu}(x)}{dx^m},$

**14.6.5**  $(\nu + 1)_m Q_{\nu}^m(x) = (-1)^m (x^2 - 1)^{m/2} \frac{d^m Q_{\nu}(x)}{dx^m}.$

**14.6(ii) Negative Integer Orders**

For  $m = 1, 2, 3, \dots,$

**14.6.6**  $P_{\nu}^{-m}(x) = (1 - x^2)^{-m/2} \int_x^1 \dots \int_x^1 P_{\nu}(x) (dx)^m.$

**14.6.7**  $P_{\nu}^{-m}(x) = (x^2 - 1)^{-m/2} \int_1^x \dots \int_1^x P_{\nu}(x) (dx)^m,$

**14.6.8**  
 $Q_{\nu}^{-m}(x) = (-1)^m (x^2 - 1)^{-m/2}$   
 $\times \int_x^{\infty} \dots \int_x^{\infty} Q_{\nu}(x) (dx)^m.$

For connections between positive and negative integer orders see (14.9.3), (14.9.4), and (14.9.13).

**14.7 Integer Degree and Order**

**14.7(i)  $\mu = 0$**

For  $n = 0, 1, 2, \dots,$

**14.7.1**  $P_n^0(x) = P_n(x) = P_n^0(x) = P_n(x), \quad x \in \mathbb{R},$   
 where  $P_n(x)$  is the Legendre polynomial of degree  $n$ . For additional properties of  $P_n(x)$  see Chapter 18.

**14.7.2**

$Q_n^0(x) = Q_n(x) = \frac{1}{2} P_n(x) \ln\left(\frac{1+x}{1-x}\right) - W_{n-1}(x),$

where  $W_{-1}(x) = 0,$  and for  $n \geq 1,$

**14.7.3**

$W_{n-1}(x) = \sum_{s=0}^{n-1} \frac{(n+s)! (\psi(n+1) - \psi(s+1))}{2^s (n-s)! (s!)^2} (x-1)^s;$

equivalently,

**14.7.4**  $W_{n-1}(x) = \sum_{k=1}^n \frac{1}{k} P_{k-1}(x) P_{n-k}(x).$

**14.7.5**  $W_0(x) = 1, \quad W_1(x) = \frac{3}{2}x, \quad W_2(x) = \frac{5}{2}x^2 - \frac{2}{3}.$

Next,

**14.7.6**  $Q_n^0(x) = Q_n(x) = n! Q_n^0(x) = n! Q_n(x),$

where

**14.7.7**

$Q_n(x) = \frac{1}{2} P_n(x) \ln\left(\frac{x+1}{x-1}\right) - W_{n-1}(x), \quad n = 0, 1, 2, \dots$

**14.7(ii) Rodrigues-Type Formulas**

For  $m = 0, 1, 2, \dots,$  and  $n = 0, 1, 2, \dots,$

**14.7.8**  $P_n^m(x) = (-1)^m (1 - x^2)^{m/2} \frac{d^m P_n(x)}{dx^m},$

**14.7.9**  $Q_n^m(x) = (-1)^m (1 - x^2)^{m/2} \frac{d^m Q_n(x)}{dx^m},$

**14.7.10**

$P_n^m(x) = (-1)^{m+n} \frac{(1 - x^2)^{m/2}}{2^n n!} \frac{d^{m+n}}{dx^{m+n}} (1 - x^2)^n.$

**14.7.11**  $P_n^m(x) = (x^2 - 1)^{m/2} \frac{d^m P_n(x)}{dx^m},$

**14.7.12**  $Q_n^m(x) = (x^2 - 1)^{m/2} \frac{d^m Q_n(x)}{dx^m},$

**14.7.13**  $P_n(x) = \frac{1}{2^n n!} \frac{d^n}{dx^n} (x^2 - 1)^n,$

**14.7.14**  $P_n^m(x) = \frac{(x^2 - 1)^{m/2}}{2^n n!} \frac{d^{m+n}}{dx^{m+n}} (x^2 - 1)^n,$

**14.7.15**  $P_m^m(x) = \frac{(2m)!}{2^m m!} (x^2 - 1)^{m/2}.$

When  $m$  is even and  $m \leq n,$   $P_n^m(x)$  and  $P_n^m(x)$  are polynomials of degree  $n$ . Also,

**14.7.16**  $P_n^m(x) = P_n^m(x) = 0, \quad m > n.$

**14.7(iii) Reflection Formulas**

14.7.17  $P_n^m(-x) = (-1)^{n-m} P_n^m(x),$

14.7.18  $Q_n^{\pm m}(-x) = (-1)^{n-m-1} Q_n^{\pm m}(x).$

**14.7(iv) Generating Functions**

When  $-1 < x < 1$  and  $|h| < 1,$

14.7.19 
$$\sum_{n=0}^{\infty} P_n(x)h^n = (1 - 2xh + h^2)^{-1/2},$$

14.7.20 
$$\sum_{n=0}^{\infty} Q_n(x)h^n = \frac{1}{(1 - 2xh + h^2)^{1/2}} \times \ln\left(\frac{x - h + (1 - 2xh + h^2)^{1/2}}{(1 - x^2)^{1/2}}\right).$$

When  $-1 < x < 1$  and  $|h| > 1,$

14.7.21 
$$\sum_{n=0}^{\infty} P_n(x)h^{-n-1} = (1 - 2xh + h^2)^{-1/2}.$$

When  $x > 1,$  (14.7.19) applies with  $|h| < x - (x^2 - 1)^{1/2}.$  Also, with the same conditions

14.7.22 
$$\sum_{n=0}^{\infty} Q_n(x)h^n = \frac{1}{(1 - 2xh + h^2)^{1/2}} \times \ln\left(\frac{x - h + (1 - 2xh + h^2)^{1/2}}{(x^2 - 1)^{1/2}}\right).$$

Lastly, when  $x > 1,$  (14.7.21) applies with  $|h| > x + (x^2 - 1)^{1/2}.$

For other generating functions see Magnus *et al.* (1966, pp. 232–233) and Rainville (1960, pp. 163–165, 168, 170–171, 184).

**14.8 Behavior at Singularities**

**14.8(i)  $x \rightarrow 1-$  or  $x \rightarrow -1+$**

As  $x \rightarrow 1-,$

14.8.1 
$$P_\nu^\mu(x) \sim \frac{1}{\Gamma(1 - \mu)} \left(\frac{2}{1 - x}\right)^{\mu/2}, \quad \mu \neq 1, 2, 3, \dots,$$

14.8.2 
$$P_\nu^m(x) \sim (-1)^m \frac{(\nu - m + 1)_{2m}}{m!} \left(\frac{1 - x}{2}\right)^{m/2},$$

$$m = 1, 2, 3, \dots, \nu \neq m - 1, m - 2, \dots, -m,$$

14.8.3 
$$Q_\nu(x) = \frac{1}{2} \ln\left(\frac{2}{1 - x}\right) - \gamma - \psi(\nu + 1) + O(1 - x),$$

$$\nu \neq -1, -2, -3, \dots,$$

where  $\gamma$  is Euler’s constant (§5.2(ii)). In the next three relations  $\Re\mu > 0.$

14.8.4 
$$Q_\nu^\mu(x) \sim \frac{1}{2} \cos(\mu\pi) \Gamma(\mu) \left(\frac{2}{1 - x}\right)^{\mu/2}, \quad \mu \neq \frac{1}{2}, \frac{3}{2}, \frac{5}{2}, \dots,$$

14.8.5 
$$Q_\nu^\mu(x) \sim (-1)^{\mu+(1/2)} \frac{\pi \Gamma(\nu + \mu + 1)}{2 \Gamma(\mu + 1) \Gamma(\nu - \mu + 1)} \left(\frac{1 - x}{2}\right)^{\mu/2},$$

$$\mu = \frac{1}{2}, \frac{3}{2}, \frac{5}{2}, \dots, \nu \pm \mu \neq -1, -2, -3, \dots,$$

14.8.6 
$$Q_\nu^{-\mu}(x) \sim \frac{\Gamma(\mu) \Gamma(\nu - \mu + 1)}{2 \Gamma(\nu + \mu + 1)} \left(\frac{2}{1 - x}\right)^{\mu/2},$$

$$\nu \pm \mu \neq -1, -2, -3, \dots$$

The behavior of  $P_\nu^\mu(x)$  and  $Q_\nu^\mu(x)$  as  $x \rightarrow -1+$  follows from the above results and the connection formulas (14.9.8) and (14.9.10).

**14.8(ii)  $x \rightarrow 1+$**

14.8.7 
$$P_\nu^\mu(x) \sim \frac{1}{\Gamma(1 - \mu)} \left(\frac{2}{x - 1}\right)^{\mu/2}, \quad \mu \neq 1, 2, 3, \dots,$$

14.8.8 
$$P_\nu^m(x) \sim \frac{\Gamma(\nu + m + 1)}{m! \Gamma(\nu - m + 1)} \left(\frac{x - 1}{2}\right)^{m/2},$$

$$m = 1, 2, 3, \dots, \nu \pm m \neq -1, -2, -3, \dots,$$

14.8.9 
$$Q_\nu(x) = -\frac{\ln(x - 1)}{2 \Gamma(\nu + 1)} + \frac{\frac{1}{2} \ln 2 - \gamma - \psi(\nu + 1)}{\Gamma(\nu + 1)}$$

$$+ O(x - 1), \quad \nu \neq -1, -2, -3, \dots,$$

14.8.10 
$$Q_{-n}(x) \rightarrow (-1)^{n+1} (n - 1)!, \quad n = 1, 2, 3, \dots,$$

14.8.11 
$$Q_\nu^\mu(x) \sim \frac{\Gamma(\mu)}{2 \Gamma(\nu + \mu + 1)} \left(\frac{2}{x - 1}\right)^{\mu/2},$$

$$\Re\mu > 0, \nu + \mu \neq -1, -2, -3, \dots$$

**14.8(iii)  $x \rightarrow \infty$**

14.8.12 
$$P_\nu^\mu(x) \sim \frac{\Gamma(\nu + \frac{1}{2})}{\pi^{1/2} \Gamma(\nu - \mu + 1)} (2x)^\nu,$$

$$\Re\nu > -\frac{1}{2}, \mu - \nu \neq 1, 2, 3, \dots,$$

14.8.13 
$$P_\nu^\mu(x) \sim \frac{\Gamma(-\nu - \frac{1}{2})}{\pi^{1/2} \Gamma(-\mu - \nu)} (2x)^{\nu+1},$$

$$\Re\nu < -\frac{1}{2}, \nu + \mu \neq 0, 1, 2, \dots,$$

14.8.14 
$$P_{-1/2}^\mu(x) \sim \frac{1}{\Gamma(\frac{1}{2} - \mu)} \left(\frac{2}{\pi x}\right)^{1/2} \ln x,$$

$$\mu \neq \frac{1}{2}, \frac{3}{2}, \frac{5}{2}, \dots,$$

14.8.15

$$Q_\nu^\mu(x) \sim \frac{\pi^{1/2}}{\Gamma(\nu + \frac{3}{2})(2x)^{\nu+1}}, \quad \nu \neq -\frac{3}{2}, -\frac{5}{2}, -\frac{7}{2}, \dots,$$

$$14.8.16 \quad Q_{-n-(1/2)}^\mu(x) \sim \frac{\pi^{1/2} \Gamma(\mu + n + \frac{1}{2})}{n! \Gamma(\mu - n + \frac{1}{2})(2x)^{n+(1/2)}},$$

$$n = 1, 2, 3, \dots, \mu - n + \frac{1}{2} \neq 0, -1, -2, \dots$$

## 14.9 Connection Formulas

### 14.9(i) Connections Between $P_\nu^{\pm\mu}(x)$ , $Q_{-\nu-1}^{\pm\mu}(x)$ , $Q_\nu^{\pm\mu}(x)$ , $Q_{-\nu-1}^\mu(x)$

$$14.9.1 \quad \frac{\pi \sin(\mu\pi)}{2\Gamma(\nu - \mu + 1)} P_\nu^{-\mu}(x) = -\frac{1}{\Gamma(\nu + \mu + 1)} Q_\nu^\mu(x) + \frac{\cos(\mu\pi)}{\Gamma(\nu - \mu + 1)} Q_\nu^{-\mu}(x).$$

$$14.9.2 \quad \frac{2 \sin(\mu\pi)}{\pi \Gamma(\nu - \mu + 1)} Q_\nu^{-\mu}(x) = \frac{1}{\Gamma(\nu + \mu + 1)} P_\nu^\mu(x) - \frac{\cos(\mu\pi)}{\Gamma(\nu - \mu + 1)} P_\nu^{-\mu}(x),$$

$$14.9.3 \quad P_\nu^{-m}(x) = (-1)^m \frac{\Gamma(\nu - m + 1)}{\Gamma(\nu + m + 1)} P_\nu^m(x),$$

$$14.9.4 \quad Q_\nu^{-m}(x) = (-1)^m \frac{\Gamma(\nu - m + 1)}{\Gamma(\nu + m + 1)} Q_\nu^m(x),$$

$$\nu \neq m - 1, m - 2, \dots$$

$$14.9.5 \quad P_{-\nu-1}^\mu(x) = P_\nu^\mu(x), \quad P_{-\nu-1}^{-\mu}(x) = P_\nu^{-\mu}(x),$$

$$14.9.6 \quad \pi \cos(\nu\pi) \cos(\mu\pi) P_\nu^\mu(x) = \sin((\nu + \mu)\pi) Q_\nu^\mu(x) - \sin((\nu - \mu)\pi) Q_{-\nu-1}^\mu(x).$$

### 14.9(ii) Connections Between $P_\nu^{\pm\mu}(\pm x)$ , $Q_\nu^{-\mu}(\pm x)$ , $Q_\nu^\mu(x)$

$$14.9.7 \quad \frac{\sin((\nu - \mu)\pi)}{\Gamma(\nu + \mu + 1)} P_\nu^\mu(x) = \frac{\sin(\nu\pi)}{\Gamma(\nu - \mu + 1)} P_\nu^{-\mu}(x) - \frac{\sin(\mu\pi)}{\Gamma(\nu - \mu + 1)} P_\nu^{-\mu}(-x),$$

$$14.9.8 \quad \frac{1}{2} \pi \sin((\nu - \mu)\pi) P_\nu^{-\mu}(x) = -\cos((\nu - \mu)\pi) Q_\nu^{-\mu}(x) - Q_\nu^{-\mu}(-x),$$

$$14.9.9 \quad \frac{2}{\Gamma(\nu + \mu + 1) \Gamma(\mu - \nu)} Q_\nu^\mu(x) = -\cos(\nu\pi) P_\nu^{-\mu}(x) + \cos(\mu\pi) P_\nu^{-\mu}(-x),$$

$$14.9.10 \quad (2/\pi) \sin((\nu - \mu)\pi) Q_\nu^{-\mu}(x) = \cos((\nu - \mu)\pi) P_\nu^{-\mu}(x) - P_\nu^{-\mu}(-x).$$

### 14.9(iii) Connections Between $P_\nu^{\pm\mu}(x)$ , $P_{-\nu-1}^{\pm\mu}(x)$ , $Q_\nu^{\pm\mu}(x)$ , $Q_{-\nu-1}^\mu(x)$

$$14.9.11 \quad P_{-\nu-1}^{-\mu}(x) = P_\nu^{-\mu}(x), \quad P_{-\nu-1}^\mu(x) = P_\nu^\mu(x),$$

$$14.9.12 \quad \cos(\nu\pi) P_\nu^{-\mu}(x) = -\frac{Q_\nu^\mu(x)}{\Gamma(\mu - \nu)} + \frac{Q_{-\nu-1}^\mu(x)}{\Gamma(\nu + \mu + 1)}.$$

14.9.13

$$P_\nu^{-m}(x) = \frac{\Gamma(\nu - m + 1)}{\Gamma(\nu + m + 1)} P_\nu^m(x), \quad \nu \neq m - 1, m - 2, \dots$$

$$14.9.14 \quad Q_\nu^{-\mu}(x) = Q_\nu^\mu(x),$$

14.9.15

$$\frac{2 \sin(\mu\pi)}{\pi} Q_\nu^\mu(x) = \frac{P_\nu^\mu(x)}{\Gamma(\nu + \mu + 1)} - \frac{P_\nu^{-\mu}(x)}{\Gamma(\nu - \mu + 1)}.$$

### 14.9(iv) Whipple's Formula

14.9.16

$$Q_\nu^\mu(x) = \left(\frac{1}{2}\pi\right)^{1/2} (x^2 - 1)^{-1/4} P_{-\mu-(1/2)}^{-\nu-(1/2)}(x(x^2 - 1)^{-1/2}).$$

Equivalently,

14.9.17

$$P_\nu^\mu(x) = (2/\pi)^{1/2} (x^2 - 1)^{-1/4} Q_{-\mu-(1/2)}^{\nu+(1/2)}(x(x^2 - 1)^{-1/2}).$$

## 14.10 Recurrence Relations and Derivatives

$$14.10.1 \quad P_\nu^{\mu+2}(x) + 2(\mu + 1)x(1 - x^2)^{-1/2} P_\nu^{\mu+1}(x) + (\nu - \mu)(\nu + \mu + 1) P_\nu^\mu(x) = 0,$$

$$14.10.2 \quad (1 - x^2)^{1/2} P_\nu^{\mu+1}(x) - (\nu - \mu + 1) P_{\nu+1}^\mu(x) + (\nu + \mu + 1)x P_\nu^\mu(x) = 0,$$

$$14.10.3 \quad (\nu - \mu + 2) P_{\nu+2}^\mu(x) - (2\nu + 3)x P_{\nu+1}^\mu(x) + (\nu + \mu + 1) P_\nu^\mu(x) = 0,$$

$$14.10.4 \quad (1 - x^2) \frac{dP_\nu^\mu(x)}{dx} = (\mu - \nu - 1) P_{\nu+1}^\mu(x) + (\nu + 1)x P_\nu^\mu(x),$$

$$14.10.5 \quad (1 - x^2) \frac{dP_\nu^\mu(x)}{dx} = (\nu + \mu) P_{\nu-1}^\mu(x) - \nu x P_\nu^\mu(x).$$

$Q_\nu^\mu(x)$  also satisfies (14.10.1)–(14.10.5).

$$14.10.6 \quad P_\nu^{\mu+2}(x) + 2(\mu + 1)x(x^2 - 1)^{-1/2} P_\nu^{\mu+1}(x) - (\nu - \mu)(\nu + \mu + 1) P_\nu^\mu(x) = 0,$$

$$14.10.7 \quad (x^2 - 1)^{1/2} P_\nu^{\mu+1}(x) - (\nu - \mu + 1) P_{\nu+1}^\mu(x) + (\nu + \mu + 1)x P_\nu^\mu(x) = 0.$$

$Q_\nu^\mu(x)$  also satisfies (14.10.6) and (14.10.7). In addition,  $P_\nu^\mu(x)$  and  $Q_\nu^\mu(x)$  satisfy (14.10.3)–(14.10.5).

### 14.11 Derivatives with Respect to Degree or Order

$$14.11.1 \quad \frac{\partial}{\partial \nu} P_\nu^\mu(x) = \pi \cot(\nu\pi) P_\nu^\mu(x) - \frac{1}{\pi} A_\nu^\mu(x),$$

$$14.11.2 \quad \frac{\partial}{\partial \nu} Q_\nu^\mu(x) = -\frac{1}{2}\pi^2 P_\nu^\mu(x) + \frac{\pi \sin(\mu\pi)}{\sin(\nu\pi) \sin((\nu + \mu)\pi)} Q_\nu^\mu(x) - \frac{1}{2} \cot((\nu + \mu)\pi) A_\nu^\mu(x) + \frac{1}{2} \csc((\nu + \mu)\pi) A_\nu^\mu(-x),$$

where

$$14.11.3 \quad A_\nu^\mu(x) = \sin(\nu\pi) \left( \frac{1+x}{1-x} \right)^{\mu/2} \sum_{k=0}^{\infty} \frac{\left(\frac{1}{2} - \frac{1}{2}x\right)^k \Gamma(k - \nu) \Gamma(k + \nu + 1)}{k! \Gamma(k - \mu + 1)} (\psi(k + \nu + 1) - \psi(k - \nu)).$$

$$14.11.4 \quad \left. \frac{\partial}{\partial \mu} P_\nu^\mu(x) \right|_{\mu=0} = (\psi(-\nu) - \pi \cot(\nu\pi)) P_\nu(x) + Q_\nu(x),$$

$$14.11.5 \quad \left. \frac{\partial}{\partial \mu} Q_\nu^\mu(x) \right|_{\mu=0} = -\frac{1}{4}\pi^2 P_\nu(x) + (\psi(-\nu) - \pi \cot(\nu\pi)) Q_\nu(x).$$

(14.11.1) holds if  $P_\nu^\mu(x)$  is replaced by  $P_\nu^\mu(x)$ , provided that the factor  $((1+x)/(1-x))^{\mu/2}$  in (14.11.3) is replaced by  $((x+1)/(x-1))^{\mu/2}$ . (14.11.4) holds if  $P_\nu^\mu(x)$ ,  $P_\nu(x)$ , and  $Q_\nu(x)$  are replaced by  $P_\nu^\mu(x)$ ,  $P_\nu(x)$ , and  $Q_\nu(x)$ , respectively.

For further results see Magnus *et al.* (1966, pp. 177–178).

### 14.12 Integral Representations

#### 14.12(i) $-1 < x < 1$

##### Mehler–Dirichlet Formula

$$14.12.1 \quad P_\nu^\mu(\cos \theta) = \frac{2^{1/2}(\sin \theta)^\mu}{\pi^{1/2} \Gamma(\frac{1}{2} - \mu)} \int_0^\theta \frac{\cos((\nu + \frac{1}{2})t)}{(\cos t - \cos \theta)^{\mu+(1/2)}} dt, \quad 0 < \theta < \pi, \Re \mu < \frac{1}{2}.$$

$$14.12.2 \quad P_\nu^{-\mu}(x) = \frac{(1-x^2)^{-\mu/2}}{\Gamma(\mu)} \int_x^1 P_\nu(t)(t-x)^{\mu-1} dt, \quad \Re \mu > 0;$$

compare (14.6.6).

##### 14.12.3

$$Q_\nu^\mu(\cos \theta) = \frac{\pi^{1/2} \Gamma(\nu + \mu + 1)(\sin \theta)^\mu}{2^{\mu+1} \Gamma(\mu + \frac{1}{2}) \Gamma(\nu - \mu + 1)} \left( \int_0^\infty \frac{(\sinh t)^{2\mu}}{(\cos \theta + i \sin \theta \cosh t)^{\nu+\mu+1}} dt + \int_0^\infty \frac{(\sinh t)^{2\mu}}{(\cos \theta - i \sin \theta \cosh t)^{\nu+\mu+1}} dt \right),$$

$$0 < \theta < \pi, \Re \mu > -\frac{1}{2}, \Re(\nu \pm \mu) > -1.$$

#### 14.12(ii) $1 < x < \infty$

$$14.12.4 \quad P_\nu^{-\mu}(x) = \frac{2^{1/2} \Gamma(\mu + \frac{1}{2}) (x^2 - 1)^{\mu/2}}{\pi^{1/2} \Gamma(\nu + \mu + 1) \Gamma(\mu - \nu)} \int_0^\infty \frac{\cosh((\nu + \frac{1}{2})t)}{(x + \cosh t)^{\mu+(1/2)}} dt, \quad \nu + \mu \neq -1, -2, -3, \dots, \Re(\mu - \nu) > 0.$$

$$14.12.5 \quad P_\nu^{-\mu}(x) = \frac{(x^2 - 1)^{-\mu/2}}{\Gamma(\mu)} \int_1^x P_\nu(t)(x-t)^{\mu-1} dt, \quad \Re \mu > 0.$$

$$14.12.6 \quad Q_\nu^\mu(x) = \frac{\pi^{1/2} (x^2 - 1)^{\mu/2}}{2^\mu \Gamma(\mu + \frac{1}{2}) \Gamma(\nu - \mu + 1)} \int_0^\infty \frac{(\sinh t)^{2\mu}}{(x + (x^2 - 1)^{1/2} \cosh t)^{\nu+\mu+1}} dt, \quad \Re(\nu + 1) > \Re \mu > -\frac{1}{2}.$$

$$14.12.7 \quad P_\nu^m(x) = \frac{(\nu + 1)_m}{\pi} \int_0^\pi (x + (x^2 - 1)^{1/2} \cos \phi)^\nu \cos(m\phi) d\phi,$$

$$14.12.8 \quad P_n^m(x) = \frac{2^m m! (n + m)! (x^2 - 1)^{m/2}}{(2m)!(n - m)! \pi} \int_0^\pi (x + (x^2 - 1)^{1/2} \cos \phi)^{n-m} (\sin \phi)^{2m} d\phi, \quad n \geq m.$$

$$14.12.9 \quad \mathcal{Q}_n^m(x) = \frac{1}{n!} \int_0^u \left(x - (x^2 - 1)^{1/2} \cosh t\right)^n \cosh(mt) dt,$$

where

$$14.12.10 \quad u = \frac{1}{2} \ln \left( \frac{x+1}{x-1} \right).$$

$$14.12.11 \quad \mathcal{Q}_n^m(x) = \frac{(x^2 - 1)^{m/2}}{2^{n+1} n!} \int_{-1}^1 \frac{(1-t^2)^n}{(x-t)^{n+m+1}} dt,$$

$$14.12.12 \quad \mathcal{Q}_n^m(x) = \frac{1}{(n-m)!} P_n^m(x) \int_x^\infty \frac{dt}{(t^2 - 1)(P_n^m(t))^2}, \quad n \geq m.$$

#### Neumann's Integral

$$14.12.13 \quad \mathcal{Q}_n(x) = \frac{1}{2(n!)} \int_{-1}^1 \frac{P_n(t)}{x-t} dt.$$

#### Heine's Integral

$$14.12.14 \quad \mathcal{Q}_n(x) = \frac{1}{n!} \int_0^\infty \frac{dt}{(x + (x^2 - 1)^{1/2} \cosh t)^{n+1}}.$$

For further integral representations see Erdélyi *et al.* (1953a, pp. 158–159) and Magnus *et al.* (1966, pp. 184–190), and for contour integrals and other representations see §14.25.

### 14.13 Trigonometric Expansions

When  $0 < \theta < \pi$ ,

$$14.13.1 \quad P_\nu^\mu(\cos \theta) = \frac{2^{\mu+1} (\sin \theta)^\mu}{\pi^{1/2}} \sum_{k=0}^\infty \frac{\Gamma(\nu + \mu + k + 1)}{\Gamma(\nu + k + \frac{3}{2})} \frac{(\mu + \frac{1}{2})_k}{k!} \sin((\nu + \mu + 2k + 1)\theta),$$

$$14.13.2 \quad Q_\nu^\mu(\cos \theta) = \pi^{1/2} 2^\mu (\sin \theta)^\mu \sum_{k=0}^\infty \frac{\Gamma(\nu + \mu + k + 1)}{\Gamma(\nu + k + \frac{3}{2})} \frac{(\mu + \frac{1}{2})_k}{k!} \cos((\nu + \mu + 2k + 1)\theta),$$

$$14.13.3 \quad P_n(\cos \theta) = \frac{2^{2n+2} (n!)^2}{\pi (2n+1)!} \sum_{k=0}^\infty \frac{1 \cdot 3 \cdots (2k-1)}{k!} \frac{(n+1)(n+2) \cdots (n+k)}{(2n+3)(2n+5) \cdots (2n+2k+1)} \sin((n+2k+1)\theta),$$

$$14.13.4 \quad Q_n(\cos \theta) = \frac{2^{2n+1} (n!)^2}{(2n+1)!} \sum_{k=0}^\infty \frac{1 \cdot 3 \cdots (2k-1)}{k!} \frac{(n+1)(n+2) \cdots (n+k)}{(2n+3)(2n+5) \cdots (2n+2k+1)} \cos((n+2k+1)\theta).$$

For these and other trigonometric expansions see Erdélyi *et al.* (1953a, pp. 146–147).

### 14.14 Continued Fractions

$$14.14.1 \quad \frac{1}{2} (x^2 - 1)^{1/2} \frac{P_\nu^\mu(x)}{P_\nu^{\mu-1}(x)} = \frac{x_0}{y_0 +} \frac{x_1}{y_1 +} \frac{x_2}{y_2 +} \cdots,$$

where

$$14.14.2 \quad x_k = \frac{1}{4} (\nu - \mu - k + 1)(\nu + \mu + k) (x^2 - 1), \quad y_k = (\mu + k)x,$$

provided that  $x_{k+1}$  and  $y_k$  do not vanish simultaneously for any  $k = 0, 1, 2, \dots$

$$14.14.3 \quad (\nu - \mu) \frac{Q_\nu^\mu(x)}{Q_{\nu-1}^\mu(x)} = \frac{x_0}{y_0 -} \frac{x_1}{y_1 -} \frac{x_2}{y_2 -} \cdots, \quad \nu \neq \mu,$$

where now

$$14.14.4 \quad x_k = (\nu + \mu + k)(\nu - \mu + k), \quad y_k = (2\nu + 2k + 1)x,$$

again provided  $x_{k+1}$  and  $y_k$  do not vanish simultaneously for any  $k = 0, 1, 2, \dots$

### 14.15 Uniform Asymptotic Approximations

#### 14.15(i) Large $\mu$ , Fixed $\nu$

For the interval  $-1 < x < 1$  with fixed  $\nu$ , real  $\mu$ , and arbitrary fixed values of the nonnegative integer  $J$ ,

$$14.15.1 \quad P_\nu^{-\mu}(\pm x) = \left(\frac{1 \mp x}{1 \pm x}\right)^{\mu/2} \left(\sum_{j=0}^{J-1} \frac{(\nu+1)_j (-\nu)_j}{j! \Gamma(j+1+\mu)} \left(\frac{1 \mp x}{2}\right)^j + O\left(\frac{1}{\Gamma(J+1+\mu)}\right)\right)$$

as  $\mu \rightarrow \infty$ , uniformly with respect to  $x$ . In other words, the convergent hypergeometric series expansions of  $P_\nu^{-\mu}(\pm x)$  are also generalized (and uniform) asymptotic expansions as  $\mu \rightarrow \infty$ , with scale  $1/\Gamma(j+1+\mu)$ ,  $j = 0, 1, 2, \dots$ ; compare §2.1(v).

Provided that  $\mu - \nu \notin \mathbb{Z}$  the corresponding expansions for  $P_\nu^\mu(x)$  and  $Q_\nu^{\mp\mu}(x)$  can be obtained from the connection formulas (14.9.7), (14.9.9), and (14.9.10).

For the interval  $1 < x < \infty$  the following asymptotic approximations hold when  $\mu \rightarrow \infty$ , with  $\nu (\geq -\frac{1}{2})$  fixed, uniformly with respect to  $x$ :

$$14.15.2 \quad P_\nu^{-\mu}(x) = \frac{1}{\Gamma(\mu+1)} \left(\frac{2\mu u}{\pi}\right)^{1/2} K_{\nu+\frac{1}{2}}(\mu u) \left(1 + O\left(\frac{1}{\mu}\right)\right),$$

$$14.15.3 \quad Q_\nu^\mu(x) = \frac{1}{\mu^{\nu+(1/2)}} \left(\frac{\pi u}{2}\right)^{1/2} I_{\nu+\frac{1}{2}}(\mu u) \left(1 + O\left(\frac{1}{\mu}\right)\right),$$

where  $u$  is given by (14.12.10). Here  $I$  and  $K$  are the modified Bessel functions (§10.25(ii)).

For asymptotic expansions and explicit error bounds, see Dunster (2003b) and Gil *et al.* (2000).

#### 14.15(ii) Large $\mu$ , $0 \leq \nu + \frac{1}{2} \leq (1 - \delta)\mu$

In this and subsequent subsections  $\delta$  denotes an arbitrary constant such that  $0 < \delta < 1$ .

As  $\mu \rightarrow \infty$ ,

$$14.15.4 \quad P_\nu^{-\mu}(x) = \frac{1}{\Gamma(\mu+1)} (1 - \alpha^2)^{-\mu/2} \left(\frac{1 - \alpha}{1 + \alpha}\right)^{(\nu/2)+(1/4)} \left(\frac{p}{x}\right)^{1/2} e^{-\mu\rho} \left(1 + O\left(\frac{1}{\mu}\right)\right),$$

uniformly with respect to  $x \in (-1, 1)$  and  $\nu + \frac{1}{2} \in [0, (1 - \delta)\mu]$ , where

$$14.15.5 \quad \alpha = \frac{\nu + \frac{1}{2}}{\mu} (< 1),$$

$$14.15.6 \quad p = \frac{x}{(\alpha^2 x^2 + 1 - \alpha^2)^{1/2}},$$

and

$$14.15.7 \quad \rho = \frac{1}{2} \ln\left(\frac{1+p}{1-p}\right) + \frac{1}{2} \alpha \ln\left(\frac{1-\alpha p}{1+\alpha p}\right).$$

With the same conditions, the corresponding approximation for  $P_\nu^{-\mu}(-x)$  is obtained by replacing  $e^{-\mu\rho}$  by  $e^{\mu\rho}$  on the right-hand side of (14.15.4). Approximations for  $P_\nu^\mu(x)$  and  $Q_\nu^{\mp\mu}(x)$  can then be achieved via (14.9.7), (14.9.9), and (14.9.10).

Next,

$$14.15.8 \quad P_\nu^{-\mu}(x) = \left(\frac{2\mu}{\pi}\right)^{1/2} \frac{1}{\Gamma(\mu+1)} \left(\frac{1 - \alpha}{1 + \alpha}\right)^{(\nu/2)+(1/4)} (1 - \alpha^2)^{-\mu/2} \left(\frac{\alpha^2 + \eta^2}{\alpha^2(x^2 - 1) + 1}\right)^{1/4} K_{\nu+\frac{1}{2}}(\mu\eta) \left(1 + O\left(\frac{1}{\mu}\right)\right),$$

$$14.15.9 \quad Q_\nu^\mu(x) = \left(\frac{\pi}{2}\right)^{1/2} \left(\frac{e}{\mu}\right)^{\nu+(1/2)} \left(\frac{1 - \alpha}{1 + \alpha}\right)^{\mu/2} (1 - \alpha^2)^{-(\nu/2)-(1/4)} \left(\frac{\alpha^2 + \eta^2}{\alpha^2(x^2 - 1) + 1}\right)^{1/4} I_{\nu+\frac{1}{2}}(\mu\eta) \left(1 + O\left(\frac{1}{\mu}\right)\right),$$

uniformly with respect to  $x \in (1, \infty)$  and  $\nu + \frac{1}{2} \in [0, (1 - \delta)\mu]$ . Here  $\alpha$  is again given by (14.15.5), and  $\eta$  is defined implicitly by

$$14.15.10 \quad \alpha \ln\left((\alpha^2 + \eta^2)^{1/2} + \alpha\right) - \alpha \ln \eta - (\alpha^2 + \eta^2)^{1/2} = \frac{1}{2} \ln\left(\frac{(1 + \alpha^2)x^2 + 1 - \alpha^2 - 2x(\alpha^2 x^2 - \alpha^2 + 1)^{1/2}}{(x^2 - 1)(1 - \alpha^2)}\right) + \frac{1}{2} \alpha \ln\left(\frac{\alpha^2(2x^2 - 1) + 1 + 2\alpha x(\alpha^2 x^2 - \alpha^2 + 1)^{1/2}}{1 - \alpha^2}\right).$$

The interval  $1 < x < \infty$  is mapped one-to-one to the interval  $0 < \eta < \infty$ , with the points  $x = 1$  and  $x = \infty$  corresponding to  $\eta = \infty$  and  $\eta = 0$ , respectively. For asymptotic expansions and explicit error bounds, see Dunster (2003b).

### 14.15(iii) Large $\nu$ , Fixed $\mu$

For  $\nu \rightarrow \infty$  and fixed  $\mu (\geq 0)$ ,

$$14.15.11 \quad P_{\nu}^{-\mu}(\cos \theta) = \frac{1}{\nu^{\mu}} \left( \frac{\theta}{\sin \theta} \right)^{1/2} \left( J_{\mu}((\nu + \frac{1}{2})\theta) + O\left(\frac{1}{\nu}\right) \text{env} J_{\mu}((\nu + \frac{1}{2})\theta) \right),$$

$$14.15.12 \quad Q_{\nu}^{-\mu}(\cos \theta) = -\frac{\pi}{2\nu^{\mu}} \left( \frac{\theta}{\sin \theta} \right)^{1/2} \left( Y_{\mu}((\nu + \frac{1}{2})\theta) + O\left(\frac{1}{\nu}\right) \text{env} Y_{\mu}((\nu + \frac{1}{2})\theta) \right),$$

uniformly for  $\theta \in (0, \pi - \delta]$ . For the Bessel functions  $J$  and  $Y$  see §10.2(ii), and for the env functions associated with  $J$  and  $Y$  see §2.8(iv).

Next,

$$14.15.13 \quad P_{\nu}^{-\mu}(\cosh \xi) = \frac{1}{\nu^{\mu}} \left( \frac{\xi}{\sinh \xi} \right)^{1/2} I_{\mu}((\nu + \frac{1}{2})\xi) \left( 1 + O\left(\frac{1}{\nu}\right) \right),$$

$$14.15.14 \quad Q_{\nu}^{\mu}(\cosh \xi) = \frac{\nu^{\mu}}{\Gamma(\nu + \mu + 1)} \left( \frac{\xi}{\sinh \xi} \right)^{1/2} K_{\mu}((\nu + \frac{1}{2})\xi) \left( 1 + O\left(\frac{1}{\nu}\right) \right),$$

uniformly for  $\xi \in (0, \infty)$ .

For asymptotic expansions and explicit error bounds, see Olver (1997b, Chapter 12, §§12, 13) and Jones (2001). For convergent series expansions see Dunster (2004).

See also Olver (1997b, pp. 311–313) and §18.15(iii) for a generalized asymptotic expansion in terms of elementary functions for Legendre polynomials  $P_n(\cos \theta)$  as  $n \rightarrow \infty$  with  $\theta$  fixed.

### 14.15(iv) Large $\nu$ , $0 \leq \mu \leq (1 - \delta)(\nu + \frac{1}{2})$

As  $\nu \rightarrow \infty$ ,

$$14.15.15 \quad P_{\nu}^{-\mu}(x) = \beta \left( \frac{y - \alpha^2}{1 - \alpha^2 - x^2} \right)^{1/4} \left( J_{\mu}((\nu + \frac{1}{2})y^{1/2}) + O\left(\frac{1}{\nu}\right) \text{env} J_{\mu}((\nu + \frac{1}{2})y^{1/2}) \right),$$

$$14.15.16 \quad Q_{\nu}^{-\mu}(x) = -\frac{\pi\beta}{2} \left( \frac{y - \alpha^2}{1 - \alpha^2 - x^2} \right)^{1/4} \left( Y_{\mu}((\nu + \frac{1}{2})y^{1/2}) + O\left(\frac{1}{\nu}\right) \text{env} Y_{\mu}((\nu + \frac{1}{2})y^{1/2}) \right),$$

uniformly with respect to  $x \in [0, 1)$  and  $\mu \in [0, (1 - \delta)(\nu + \frac{1}{2})]$ . For  $\alpha$ ,  $\beta$ , and  $y$  see below.

Next,

$$14.15.17 \quad P_{\nu}^{-\mu}(x) = \beta \left( \frac{\alpha^2 - y}{x^2 - 1 + \alpha^2} \right)^{1/4} I_{\mu}((\nu + \frac{1}{2})|y|^{1/2}) \left( 1 + O\left(\frac{1}{\nu}\right) \right),$$

$$14.15.18 \quad Q_{\nu}^{\mu}(x) = \frac{1}{\beta\Gamma(\nu + \mu + 1)} \left( \frac{\alpha^2 - y}{x^2 - 1 + \alpha^2} \right)^{1/4} K_{\mu}((\nu + \frac{1}{2})|y|^{1/2}) \left( 1 + O\left(\frac{1}{\nu}\right) \right),$$

uniformly with respect to  $x \in (1, \infty)$  and  $\mu \in [0, (1 - \delta)(\nu + \frac{1}{2})]$ . In (14.15.15)–(14.15.18)

$$14.15.19 \quad \alpha = \frac{\mu}{\nu + \frac{1}{2}} (< 1),$$

$$14.15.20 \quad \beta = e^{\mu} \left( \frac{\nu - \mu + \frac{1}{2}}{\nu + \mu + \frac{1}{2}} \right)^{(\nu/2) + (1/4)} \left( (\nu + \frac{1}{2})^2 - \mu^2 \right)^{-\mu/2},$$

and the variable  $y$  is defined implicitly by

$$14.15.21 \quad (y - \alpha^2)^{1/2} - \alpha \arctan \left( \frac{(y - \alpha^2)^{1/2}}{\alpha} \right) = \arccos \left( \frac{x}{(1 - \alpha^2)^{1/2}} \right) - \frac{\alpha}{2} \arccos \left( \frac{(1 + \alpha^2)x^2 - 1 + \alpha^2}{(1 - \alpha^2)(1 - x^2)} \right),$$

$$x \leq (1 - \alpha^2)^{1/2}, y \geq \alpha^2,$$

and

$$\begin{aligned}
 & (\alpha^2 - y)^{1/2} + \frac{1}{2}\alpha \ln |y| - \alpha \ln \left( (\alpha^2 - y)^{1/2} + \alpha \right) \\
 14.15.22 \quad & = \ln \left( \frac{x + (x^2 - 1 + \alpha^2)^{1/2}}{(1 - \alpha^2)^{1/2}} \right) + \frac{\alpha}{2} \ln \left( \frac{(1 - \alpha^2) |1 - x^2|}{(1 + \alpha^2)x^2 - 1 + \alpha^2 + 2\alpha x (x^2 - 1 + \alpha^2)^{1/2}} \right), \\
 & \qquad \qquad \qquad x \geq (1 - \alpha^2)^{1/2}, y \leq \alpha^2,
 \end{aligned}$$

where the inverse trigonometric functions take their principal values (§4.23(ii)). The points  $x = (1 - \alpha^2)^{1/2}$ ,  $x = 1$ , and  $x = \infty$  are mapped to  $y = \alpha^2$ ,  $y = 0$ , and  $y = -\infty$ , respectively. The interval  $0 \leq x < \infty$  is mapped one-to-one to the interval  $-\infty < y \leq y_0$ , where  $y = y_0$  is the (positive) solution of (14.15.21) when  $x = 0$ .

For asymptotic expansions and explicit error bounds, see Boyd and Dunster (1986).

### 14.15(v) Large $\nu$ , $(\nu + \frac{1}{2})\delta \leq \mu \leq (\nu + \frac{1}{2})/\delta$

Here we introduce the envelopes of the parabolic cylinder functions  $U(-c, x)$ ,  $\bar{U}(-c, x)$ , which are defined in §12.2. For  $f(x) = U(-c, x)$  or  $\bar{U}(-c, x)$ , with  $c$  and  $x$  nonnegative,

$$14.15.23 \quad \text{env } f(x) = \begin{cases} ((U(-c, x))^2 + (\bar{U}(-c, x))^2)^{1/2}, & 0 \leq x \leq X_c, \\ \sqrt{2}f(x), & X_c \leq x < \infty, \end{cases}$$

where  $x = X_c$  denotes the largest positive root of the equation  $U(-c, x) = \bar{U}(-c, x)$ .

As  $\nu \rightarrow \infty$ ,

$$14.15.24 \quad \begin{aligned}
 P_\nu^{-\mu}(x) &= \frac{1}{(\nu + \frac{1}{2})^{1/4} 2^{(\nu+\mu)/2} \Gamma(\frac{1}{2}\nu + \frac{1}{2}\mu + \frac{3}{4})} \left( \frac{\zeta^2 - \alpha^2}{x^2 - a^2} \right)^{1/4} \\
 &\quad \times \left( U\left(\mu - \nu - \frac{1}{2}, (2\nu + 1)^{1/2} \zeta\right) + O(\nu^{-2/3}) \text{env} U\left(\mu - \nu - \frac{1}{2}, (2\nu + 1)^{1/2} \zeta\right) \right),
 \end{aligned}$$

$$14.15.25 \quad \begin{aligned}
 Q_\nu^{-\mu}(x) &= \frac{\pi}{(\nu + \frac{1}{2})^{1/4} 2^{(\nu+\mu+2)/2} \Gamma(\frac{1}{2}\nu + \frac{1}{2}\mu + \frac{3}{4})} \left( \frac{\zeta^2 - \alpha^2}{x^2 - a^2} \right)^{1/4} \\
 &\quad \times \left( \bar{U}\left(\mu - \nu - \frac{1}{2}, (2\nu + 1)^{1/2} \zeta\right) + O(\nu^{-2/3}) \text{env} \bar{U}\left(\mu - \nu - \frac{1}{2}, (2\nu + 1)^{1/2} \zeta\right) \right),
 \end{aligned}$$

uniformly with respect to  $x \in [0, 1)$  and  $\mu \in [\delta(\nu + \frac{1}{2}), \nu + \frac{1}{2}]$ . Here

$$14.15.26 \quad a = \frac{((\nu + \mu + \frac{1}{2}) |\nu - \mu + \frac{1}{2}|)^{1/2}}{\nu + \frac{1}{2}}, \quad \alpha = \left( \frac{2 |\nu - \mu + \frac{1}{2}|}{\nu + \frac{1}{2}} \right)^{1/2},$$

and the variable  $\zeta$  is defined implicitly by

$$14.15.27 \quad \frac{1}{2}\zeta (\zeta^2 - \alpha^2)^{1/2} - \frac{1}{2}\alpha^2 \text{arccosh}\left(\frac{\zeta}{\alpha}\right) = (1 - a^2)^{1/2} \text{arctanh}\left(\frac{1}{x} \left(\frac{x^2 - a^2}{1 - a^2}\right)^{1/2}\right) - \text{arccosh}\left(\frac{x}{a}\right), \quad a \leq x < 1, \alpha \leq \zeta < \infty,$$

and

$$14.15.28 \quad \frac{1}{2}\alpha^2 \arcsin\left(\frac{\zeta}{\alpha}\right) + \frac{1}{2}\zeta (\alpha^2 - \zeta^2)^{1/2} = \arcsin\left(\frac{x}{a}\right) - (1 - a^2)^{1/2} \arctan\left(x \left(\frac{1 - a^2}{a^2 - x^2}\right)^{1/2}\right), \quad -a \leq x \leq a, -\alpha \leq \zeta \leq \alpha,$$

when  $a > 0$ , and

$$14.15.29 \quad \zeta^2 = -\ln(1 - x^2), \quad -1 < x < 1,$$

when  $a = 0$ . The inverse hyperbolic and trigonometric functions take their principal values (§§4.23(ii), 4.37(ii)).

When  $a > 0$  the interval  $-a \leq x < 1$  is mapped one-to-one to the interval  $-\alpha \leq \zeta < \infty$ , with the points  $x = -a$ ,  $x = a$ , and  $x = 1$  corresponding to  $\zeta = -\alpha$ ,  $\zeta = \alpha$ , and  $\zeta = \infty$ , respectively. When  $a = 0$  the interval  $-1 < x < 1$  is mapped one-to-one to the interval  $-\infty < \zeta < \infty$ , with the points  $x = -1$ ,  $0$ , and  $1$  corresponding to  $\zeta = -\infty$ ,  $0$ , and  $\infty$ , respectively.



Next, as  $\nu \rightarrow \infty$ ,

$$14.15.30 \quad P_\nu^{-\mu}(x) = \frac{1}{(\nu + \frac{1}{2})^{1/4} 2^{(\nu+\mu)/2} \Gamma(\frac{1}{2}\nu + \frac{1}{2}\mu + \frac{3}{4})} \left(\frac{\zeta^2 + \alpha^2}{x^2 + a^2}\right)^{1/4} U\left(\mu - \nu - \frac{1}{2}, (2\nu + 1)^{1/2} \zeta\right) (1 + O(\nu^{-1} \ln \nu)),$$

uniformly with respect to  $x \in (-1, 1)$  and  $\mu \in [\nu + \frac{1}{2}, (1/\delta)(\nu + \frac{1}{2})]$ . Here  $\zeta$  is defined implicitly by

$$14.15.31 \quad \frac{1}{2}\zeta (\zeta^2 + \alpha^2)^{1/2} + \frac{1}{2}\alpha^2 \operatorname{arcsinh}\left(\frac{\zeta}{\alpha}\right) = (1 + a^2)^{1/2} \operatorname{arctanh}\left(x \left(\frac{1 + a^2}{x^2 + a^2}\right)^{1/2}\right) - \operatorname{arcsinh}\left(\frac{x}{a}\right),$$

$-1 < x < 1, -\infty < \zeta < \infty,$

when  $a > 0$ , which maps the interval  $-1 < x < 1$  one-to-one to the interval  $-\infty < \zeta < \infty$ : the points  $x = -1$  and  $x = 1$  correspond to  $\zeta = -\infty$  and  $\zeta = \infty$ , respectively. When  $a = 0$  (14.15.29) again applies. (The inverse hyperbolic functions again take their principal values.)

Since (14.15.30) holds for negative  $x$ , corresponding approximations for  $Q_\nu^{\mp\mu}(x)$ , uniformly valid in the interval  $-1 < x < 1$ , can be obtained from (14.9.9) and (14.9.10).

For error bounds and other extensions see Olver (1975b).

## 14.16 Zeros

### 14.16(i) Notation

Throughout this section we assume that  $\mu$  and  $\nu$  are real, and when they are not integers we write

$$14.16.1 \quad \mu = m + \delta_\mu, \quad \nu = n + \delta_\nu,$$

where  $m, n \in \mathbb{Z}$  and  $\delta_\mu, \delta_\nu \in (0, 1)$ . For all cases concerning  $P_\nu^\mu(x)$  and  $Q_\nu^\mu(x)$  we assume that  $\nu \geq -\frac{1}{2}$  without loss of generality (see (14.9.5) and (14.9.11)).

### 14.16(ii) Interval $-1 < x < 1$

The number of zeros of  $P_\nu^\mu(x)$  in the interval  $(-1, 1)$  is  $\max(\lceil \nu - |\mu| \rceil, 0)$  if any of the following sets of conditions hold:

- (a)  $\mu \leq 0$ .
- (b)  $\mu > 0, n \geq m$ , and  $\delta_\nu > \delta_\mu$ .
- (c)  $\mu > 0, n < m$ , and  $m - n$  is odd.
- (d)  $\nu = 0, 1, 2, 3, \dots$

The number of zeros of  $P_\nu^\mu(x)$  in the interval  $(-1, 1)$  is  $\max(\lceil \nu - |\mu| \rceil, 0) + 1$  if either of the following sets of conditions holds:

- (a)  $\mu > 0, n > m$ , and  $\delta_\nu \leq \delta_\mu$ .
- (b)  $\mu > 0, n < m$ , and  $m - n$  is even.

The zeros of  $Q_\nu^\mu(x)$  in the interval  $(-1, 1)$  interlace those of  $P_\nu^\mu(x)$ .  $Q_\nu^\mu(x)$  has  $\max(\lceil \nu - |\mu| \rceil, 0) + k$  zeros in the interval  $(-1, 1)$ , where  $k$  can take one of the values  $-1, 0, 1, 2$ , subject to  $\max(\lceil \nu - |\mu| \rceil, 0) + k$  being

even or odd according as  $\cos(\nu\pi)$  and  $\cos(\mu\pi)$  have opposite signs or the same sign. In the special case  $\mu = 0$  and  $\nu = n = 0, 1, 2, 3, \dots$ ,  $Q_n(x)$  has  $n + 1$  zeros in the interval  $-1 < x < 1$ .

For uniform asymptotic approximations for the zeros of  $P_n^{-m}(x)$  in the interval  $-1 < x < 1$  when  $n \rightarrow \infty$  with  $m (\geq 0)$  fixed, see Olver (1997b, p. 469).

### 14.16(iii) Interval $1 < x < \infty$

$P_\nu^\mu(x)$  has exactly one zero in the interval  $(1, \infty)$  if either of the following sets of conditions holds:

- (a)  $\mu > 0, \mu > \nu, \mu \notin \mathbb{Z}$ , and  $\sin((\mu - \nu)\pi)$  and  $\sin(\mu\pi)$  have opposite signs.
- (b)  $\mu \leq \nu, \mu \notin \mathbb{Z}$ , and  $\lfloor \mu \rfloor$  is odd.

For all other values of  $\mu$  and  $\nu$  (with  $\nu \geq -\frac{1}{2}$ )  $P_\nu^\mu(x)$  has no zeros in the interval  $(1, \infty)$ .

$Q_\nu^\mu(x)$  has no zeros in the interval  $(1, \infty)$  when  $\nu > -1$ , and at most one zero in the interval  $(1, \infty)$  when  $\nu < -1$ .

## 14.17 Integrals

### 14.17(i) Indefinite Integrals

#### 14.17.1

$$\int (1 - x^2)^{-\mu/2} P_\nu^\mu(x) dx = - (1 - x^2)^{-(\mu-1)/2} P_\nu^{\mu-1}(x).$$

#### 14.17.2

$$\int (1 - x^2)^{\mu/2} P_\nu^\mu(x) dx = \frac{(1 - x^2)^{(\mu+1)/2}}{(\nu - \mu)(\nu + \mu + 1)} P_\nu^{\mu+1}(x),$$

$\mu \neq \nu$  or  $-\nu - 1$ .

## 14.17.3

$$\int x P_\nu^\mu(x) Q_\nu^\mu(x) dx = \frac{1}{2\nu(\nu+1)} ((\mu^2 - (\nu+1)(\nu+x^2)) P_\nu^\mu(x) Q_\nu^\mu(x) \\ + (\nu+1)(\nu-\mu+1)x(P_\nu^\mu(x) Q_{\nu+1}^\mu(x) + P_{\nu+1}^\mu(x) Q_\nu^\mu(x)) - (\nu-\mu+1)^2 P_{\nu+1}^\mu(x) Q_{\nu+1}^\mu(x)), \\ \nu \neq 0, -1.$$

## 14.17.4

$$\int \frac{x}{(1-x^2)^{3/2}} P_\nu^\mu(x) Q_\nu^\mu(x) dx \\ = \frac{1}{(1-4\mu^2)(1-x^2)^{1/2}} ((1-2\mu^2+2\nu(\nu+1)) P_\nu^\mu(x) Q_\nu^\mu(x) + (2\nu+1)(\mu-\nu-1)x(P_\nu^\mu(x) Q_{\nu+1}^\mu(x) + P_{\nu+1}^\mu(x) Q_\nu^\mu(x)) \\ + 2(\mu-\nu-1)^2 P_{\nu+1}^\mu(x) Q_{\nu+1}^\mu(x)), \\ \mu \neq \pm \frac{1}{2}.$$

In (14.17.1)–(14.17.4), P may be replaced by Q, and in (14.17.3) and (14.17.4), Q may be replaced by P.

For further results, see Maximon (1955) and Prudnikov *et al.* (1990, pp. 37–39). See also (14.12.2), (14.12.5), and (14.12.12).

## 14.17(ii) Barnes' Integral

$$14.17.5 \quad \int_0^1 x^\sigma (1-x^2)^{\mu/2} P_\nu^{-\mu}(x) dx = \frac{\Gamma(\frac{1}{2}\sigma + \frac{1}{2}) \Gamma(\frac{1}{2}\sigma + 1)}{2^{\mu+1} \Gamma(\frac{1}{2}\sigma - \frac{1}{2}\nu + \frac{1}{2}\mu + 1) \Gamma(\frac{1}{2}\sigma + \frac{1}{2}\nu + \frac{1}{2}\mu + \frac{3}{2})}, \quad \Re\sigma > -1, \Re\mu > -1.$$

## 14.17(iii) Orthogonality Properties

For  $l, m, n = 0, 1, 2, \dots$ ,

$$14.17.6 \quad \int_{-1}^1 P_l^m(x) P_n^m(x) dx = \delta_{l,n} \frac{(n+m)!}{(n-m)! (n+\frac{1}{2})},$$

$$14.17.7 \quad \int_{-1}^1 P_l^m(x) P_n^{-m}(x) dx = (-1)^m \delta_{l,n} \frac{1}{l+\frac{1}{2}},$$

$$14.17.8 \quad \int_{-1}^1 \frac{P_n^l(x) P_n^m(x)}{1-x^2} dx = \delta_{l,m} \frac{(n+m)!}{(n-m)! m}, \quad m > 0,$$

$$14.17.9 \quad \int_{-1}^1 \frac{P_n^l(x) P_n^{-m}(x)}{1-x^2} dx = (-1)^l \delta_{l,m} \frac{1}{l}, \quad l > 0.$$

## 14.17(iv) Definite Integrals of Products

With  $\psi(x) = \Gamma'(x)/\Gamma(x)$  (§5.2(i)),

$$14.17.10 \quad \int_{-1}^1 P_\nu(x) P_\lambda(x) dx = \frac{2(2\sin(\nu\pi)\sin(\lambda\pi)(\psi(\nu+1) - \psi(\lambda+1)) + \pi\sin((\lambda-\nu)\pi))}{\pi^2(\lambda-\nu)(\lambda+\nu+1)}, \quad \lambda \neq \nu \text{ or } -\nu-1.$$

$$14.17.11 \quad \int_{-1}^1 (P_\nu(x))^2 dx = \frac{\pi^2 - 2\sin^2(\nu\pi)\psi'(\nu+1)}{\pi^2(\nu+\frac{1}{2})}, \quad \nu \neq -\frac{1}{2}.$$

$$14.17.12 \quad \int_{-1}^1 Q_\nu(x) Q_\lambda(x) dx = \frac{((\psi(\nu+1) - \psi(\lambda+1))(1 + \cos(\nu\pi)\cos(\lambda\pi)) + \frac{1}{2}\pi\sin((\lambda-\nu)\pi))}{(\lambda-\nu)(\lambda+\nu+1)}, \\ \lambda \neq \nu \text{ or } -\nu-1, \lambda \text{ and } \nu \neq -1, -2, -3, \dots$$

$$14.17.13 \quad \int_{-1}^1 (Q_\nu(x))^2 dx = \frac{\pi^2 - 2(1 + \cos^2(\nu\pi))\psi'(\nu+1)}{2(2\nu+1)}, \quad \nu \neq -\frac{1}{2} \text{ or } -1, -2, -3, \dots$$

## 14.17.14

$$\int_{-1}^1 P_\nu(x) Q_\lambda(x) dx = \frac{2\sin(\nu\pi)\cos(\lambda\pi)(\psi(\nu+1) - \psi(\lambda+1)) + \pi\cos((\lambda-\nu)\pi) - \pi}{\pi(\lambda-\nu)(\lambda+\nu+1)}, \quad \Re\lambda > 0, \Re\nu > 0, \lambda \neq \nu.$$

14.17.15

$$\int_{-1}^1 P_\nu(x) Q_\nu(x) dx = -\frac{\sin(2\nu\pi) \psi'(\nu+1)}{\pi(2\nu+1)}, \quad \Re\nu > 0.$$

14.17.16

$$\int_{-1}^1 P_l^m(x) Q_n^m(x) dx = \frac{(1 - (-1)^{l+n}) (l+m)!}{(l-n)(l+n+1)(l-m)!},$$

$$l, m, n = 0, 1, 2, \dots, l \neq n.$$

14.17.17

$$\int_0^\pi Q_l(\cos\theta) P_m(\cos\theta) P_n(\cos\theta) \sin\theta d\theta$$

$$= 0, \quad l, m, n = 1, 2, 3, \dots, |m-n| < l < m+n.$$

(When  $l+m+n$  is even the condition  $|m-n| < l < m+n$  is not needed.) Next,

$$14.17.18 \quad \int_{-1}^\infty P_\nu(x) Q_\lambda(x) dx = \frac{1}{(\lambda-\nu)(\nu+\lambda+1)},$$

$$\Re\lambda > \Re\nu > 0.$$

14.17.19

$$\int_1^\infty Q_\nu(x) Q_\lambda(x) dx$$

$$= \frac{\psi(\lambda+1) - \psi(\nu+1)}{(\lambda-\nu)(\lambda+\nu+1)},$$

$$\Re(\lambda+\nu) > -1, \lambda \neq \nu, \lambda \text{ and } \nu \neq -1, -2, -3, \dots$$

$$14.17.20 \quad \int_1^\infty (Q_\nu(x))^2 dx = \frac{\psi'(\nu+1)}{2\nu+1}, \quad \Re\nu > -\frac{1}{2}.$$

For further results, see Prudnikov *et al.* (1990, pp. 194–240); also (34.3.21).

### 14.17(v) Laplace Transforms

For Laplace transforms and inverse Laplace transforms involving associated Legendre functions, see Erdélyi *et al.* (1954a, pp. 179–181, 270–272), Oberhettinger and Badii (1973, pp. 113–118, 317–324), Prudnikov *et al.* (1992a, §§3.22, 3.32, and 3.33), and Prudnikov *et al.* (1992b, §§3.20, 3.30, and 3.31).

### 14.17(vi) Mellin Transforms

For Mellin transforms involving associated Legendre functions see Oberhettinger (1974, pp. 69–82) and Marichev (1983, pp. 247–283), and for inverse transforms see Oberhettinger (1974, pp. 205–215).

## 14.18 Sums

### 14.18(i) Expansion Theorem

For expansions of arbitrary functions in series of Legendre polynomials see §18.18(i), and for expansions of arbitrary functions in series of associated Legendre functions see Schäfke (1961b).

### 14.18(ii) Addition Theorems

In (14.18.1) and (14.18.2),  $\theta_1, \theta_2$ , and  $\theta_1 + \theta_2$  all lie in  $[0, \pi)$ , and  $\phi$  is real.

$$14.18.1 \quad P_\nu(\cos\theta_1 \cos\theta_2 + \sin\theta_1 \sin\theta_2 \cos\phi) = P_\nu(\cos\theta_1) P_\nu(\cos\theta_2) + 2 \sum_{m=1}^{\infty} (-1)^m P_\nu^{-m}(\cos\theta_1) P_\nu^m(\cos\theta_2) \cos(m\phi),$$

$$14.18.2 \quad P_n(\cos\theta_1 \cos\theta_2 + \sin\theta_1 \sin\theta_2 \cos\phi) = \sum_{m=-n}^n (-1)^m P_n^{-m}(\cos\theta_1) P_n^m(\cos\theta_2) \cos(m\phi).$$

In (14.18.3),  $\theta_1$  lies in  $(0, \frac{1}{2}\pi)$ ,  $\theta_2$  and  $\theta_1 + \theta_2$  both lie in  $(0, \pi)$ ,  $\theta_1 < \theta_2$ ,  $\phi$  is real, and  $\nu \neq -1, -2, -3, \dots$

$$14.18.3 \quad Q_\nu(\cos\theta_1 \cos\theta_2 + \sin\theta_1 \sin\theta_2 \cos\phi) = P_\nu(\cos\theta_1) Q_\nu(\cos\theta_2) + 2 \sum_{m=1}^{\infty} (-1)^m P_\nu^{-m}(\cos\theta_1) Q_\nu^m(\cos\theta_2) \cos(m\phi).$$

In (14.18.4) and (14.18.5),  $\xi_1$  and  $\xi_2$  are positive, and  $\phi$  is real; also in (14.18.5)  $\xi_1 < \xi_2$  and  $\nu \neq -1, -2, -3, \dots$

14.18.4

$$P_\nu(\cosh\xi_1 \cosh\xi_2 - \sinh\xi_1 \sinh\xi_2 \cos\phi) = P_\nu(\cosh\xi_1) P_\nu(\cosh\xi_2) + 2 \sum_{m=1}^{\infty} (-1)^m P_\nu^{-m}(\cosh\xi_1) P_\nu^m(\cosh\xi_2) \cos(m\phi),$$

14.18.5

$$Q_\nu(\cosh\xi_1 \cosh\xi_2 - \sinh\xi_1 \sinh\xi_2 \cos\phi) = P_\nu(\cosh\xi_1) Q_\nu(\cosh\xi_2) + 2 \sum_{m=1}^{\infty} (-1)^m P_\nu^{-m}(\cosh\xi_1) Q_\nu^m(\cosh\xi_2) \cos(m\phi).$$

**14.18(iii) Other Sums**

$$14.18.6 \quad (x-y) \sum_{k=0}^n (2k+1) P_k(x) P_k(y) = (n+1) (P_{n+1}(x) P_n(y) - P_n(x) P_{n+1}(y)),$$

$$14.18.7 \quad (x-y) \sum_{k=0}^n (2k+1) P_k(x) Q_k(y) = (n+1) (P_{n+1}(x) Q_n(y) - P_n(x) Q_{n+1}(y)) - 1.$$

**Zonal Harmonic Series**

$$14.18.8 \quad P_\nu(-x) = \frac{\sin(\nu\pi)}{\pi} \sum_{n=0}^{\infty} \frac{2n+1}{(\nu-n)(\nu+n+1)} P_n(x), \quad \nu \notin \mathbb{Z}.$$

**Dougall's Expansion**

$$14.18.9 \quad P_\nu^{-\mu}(x) = \frac{\sin(\nu\pi)}{\pi} \sum_{n=0}^{\infty} (-1)^n \frac{2n+1}{(\nu-n)(\nu+n+1)} P_n^{-\mu}(x), \quad -1 < x \leq 1, \mu \geq 0, \nu \notin \mathbb{Z}.$$

For a series representation of the Dirac delta in terms of products of Legendre polynomials see (1.17.22).

**14.18(iv) Compendia**

For collections of sums involving associated Legendre functions, see Hansen (1975, pp. 367–377, 457–460, and 475), Erdélyi *et al.* (1953a, §3.10), Gradshteyn and Ryzhik (2000, §8.92), Magnus *et al.* (1966, pp. 178–184), and Prudnikov *et al.* (1990, §§5.2, 6.5). See also §18.18 and (34.3.19).

**14.19 Toroidal (or Ring) Functions****14.19(i) Introduction**

When  $\nu = n - \frac{1}{2}$ ,  $n = 0, 1, 2, \dots$ ,  $\mu \in \mathbb{R}$ , and  $x \in (1, \infty)$  solutions of (14.2.2) are known as *toroidal* or *ring functions*. This form of the differential equation arises when Laplace's equation is transformed into *toroidal coordinates*  $(\eta, \theta, \phi)$ , which are related to Cartesian coordinates  $(x, y, z)$  by

$$14.19.1 \quad x = \frac{c \sinh \eta \cos \phi}{\cosh \eta - \cos \theta}, \quad y = \frac{c \sinh \eta \sin \phi}{\cosh \eta - \cos \theta}, \quad z = \frac{c \sin \theta}{\cosh \eta - \cos \theta},$$

where the constant  $c$  is a scaling factor. Most required properties of toroidal functions come directly from the results for  $P_\nu^\mu(x)$  and  $Q_\nu^\mu(x)$ . In particular, for  $\mu = 0$  and  $\nu = \pm \frac{1}{2}$  see §14.5(v).

**14.19(ii) Hypergeometric Representations**

With  $\mathbf{F}$  as in §14.3 and  $\xi > 0$ ,

$$14.19.2 \quad P_{\nu-\frac{1}{2}}^\mu(\cosh \xi) = \frac{\Gamma(1-2\mu)2^{2\mu}}{\Gamma(1-\mu)(1-e^{-2\xi})^\mu e^{(\nu+(1/2))\xi}} \mathbf{F}\left(\frac{1}{2}-\mu, \frac{1}{2}+\nu-\mu; 1-2\mu; e^{-2\xi}\right), \quad \mu \neq \frac{1}{2}.$$

$$14.19.3 \quad Q_{\nu-\frac{1}{2}}^\mu(\cosh \xi) = \frac{\pi^{1/2}(1-e^{-2\xi})^\mu}{e^{(\nu+(1/2))\xi}} \mathbf{F}\left(\mu+\frac{1}{2}, \nu+\mu+\frac{1}{2}; \nu+1; e^{-2\xi}\right).$$

**14.19(iii) Integral Representations**

With  $\xi > 0$ ,

$$14.19.4 \quad P_{n-\frac{1}{2}}^m(\cosh \xi) = \frac{\Gamma(n+m+\frac{1}{2})(\sinh \xi)^m}{2^m \pi^{1/2} \Gamma(n-m+\frac{1}{2}) \Gamma(m+\frac{1}{2})} \int_0^\pi \frac{(\sin \phi)^{2m}}{(\cosh \xi + \cos \phi \sinh \xi)^{n+m+(1/2)}} d\phi,$$

$$14.19.5 \quad Q_{n-\frac{1}{2}}^m(\cosh \xi) = \frac{\Gamma(n+\frac{1}{2})}{\Gamma(n+m+\frac{1}{2}) \Gamma(n-m+\frac{1}{2})} \int_0^\infty \frac{\cosh(mt)}{(\cosh \xi + \cosh t \sinh \xi)^{n+(1/2)}} dt, \quad m < n + \frac{1}{2}.$$

**14.19(iv) Sums**

With  $\xi > 0$ ,

$$14.19.6 \quad Q_{-\frac{1}{2}}^{\mu}(\cosh \xi) + 2 \sum_{n=1}^{\infty} \frac{\Gamma(\mu + n + \frac{1}{2})}{\Gamma(\mu + \frac{1}{2})} Q_{n-\frac{1}{2}}^{\mu}(\cosh \xi) \cos(n\phi) = \frac{(\frac{1}{2}\pi)^{1/2} (\sinh \xi)^{\mu}}{(\cosh \xi - \cos \phi)^{\mu+(1/2)}}, \quad \Re \mu > -\frac{1}{2}.$$

**14.19(v) Whipple's Formula for Toroidal Functions**

With  $\xi > 0$ ,

$$14.19.7 \quad P_{n-\frac{1}{2}}^m(\cosh \xi) = \frac{\Gamma(n + m + \frac{1}{2})}{\Gamma(n - m + \frac{1}{2})} \left( \frac{2}{\pi \sinh \xi} \right)^{1/2} Q_{m-\frac{1}{2}}^n(\coth \xi),$$

$$14.19.8 \quad Q_{n-\frac{1}{2}}^m(\cosh \xi) = \frac{\Gamma(m - n + \frac{1}{2})}{\Gamma(m + n + \frac{1}{2})} \left( \frac{\pi}{2 \sinh \xi} \right)^{1/2} P_{m-\frac{1}{2}}^n(\coth \xi).$$

**14.20 Conical (or Mehler) Functions****14.20(i) Definitions and Wronskians**

Throughout §14.20 we assume that  $\nu = -\frac{1}{2} + i\tau$ , with  $\mu \geq 0$  and  $\tau \geq 0$ . (14.2.2) takes the form

$$14.20.1 \quad (1 - x^2) \frac{d^2 w}{dx^2} - 2x \frac{dw}{dx} - \left( \tau^2 + \frac{1}{4} + \frac{\mu^2}{1 - x^2} \right) w = 0.$$

Solutions are known as *conical* or *Mehler functions*. For  $-1 < x < 1$  and  $\tau > 0$ , a numerically satisfactory pair of real conical functions is  $P_{-\frac{1}{2}+i\tau}^{-\mu}(x)$  and  $P_{-\frac{1}{2}+i\tau}^{-\mu}(-x)$ .

Another real-valued solution  $\widehat{Q}_{-\frac{1}{2}+i\tau}^{-\mu}(x)$  of (14.20.1) was introduced in Dunster (1991). This is defined by

$$14.20.2 \quad \widehat{Q}_{-\frac{1}{2}+i\tau}^{-\mu}(x) = \Re \left( e^{\mu\pi i} Q_{-\frac{1}{2}+i\tau}^{-\mu}(x) \right) - \frac{1}{2} \pi \sin(\mu\pi) P_{-\frac{1}{2}+i\tau}^{-\mu}(x).$$

Equivalently,

$$14.20.3 \quad \widehat{Q}_{-\frac{1}{2}+i\tau}^{-\mu}(x) = \frac{\pi e^{-\tau\pi} \sin(\mu\pi) \sinh(\tau\pi)}{2(\cosh^2(\tau\pi) - \sin^2(\mu\pi))} P_{-\frac{1}{2}+i\tau}^{-\mu}(x) + \frac{\pi(e^{-\tau\pi} \cos^2(\mu\pi) + \sinh(\tau\pi))}{2(\cosh^2(\tau\pi) - \sin^2(\mu\pi))} P_{-\frac{1}{2}+i\tau}^{-\mu}(-x).$$

$\widehat{Q}_{-\frac{1}{2}+i\tau}^{-\mu}(x)$  exists except when  $\mu = \frac{1}{2}, \frac{3}{2}, \dots$  and  $\tau = 0$ ; compare §14.3(i). It is an important companion solution to  $P_{-\frac{1}{2}+i\tau}^{-\mu}(x)$  when  $\tau$  is large; compare §§14.20(vii), 14.20(viii), and 10.25(iii).

$$14.20.4 \quad \mathscr{W} \left\{ P_{-\frac{1}{2}+i\tau}^{-\mu}(x), P_{-\frac{1}{2}+i\tau}^{-\mu}(-x) \right\} = \frac{2}{|\Gamma(\mu + \frac{1}{2} + i\tau)|^2 (1 - x^2)}.$$

$$14.20.5 \quad \mathscr{W} \left\{ P_{-\frac{1}{2}+i\tau}^{-\mu}(x), \widehat{Q}_{-\frac{1}{2}+i\tau}^{-\mu}(x) \right\} = \frac{\pi(e^{-\tau\pi} \cos^2(\mu\pi) + \sinh(\tau\pi))}{|\Gamma(\mu + \frac{1}{2} + i\tau)|^2 (\cosh^2(\tau\pi) - \sin^2(\mu\pi)) (1 - x^2)},$$

provided that  $\widehat{Q}_{-\frac{1}{2}+i\tau}^{-\mu}(x)$  exists.

Lastly, for the range  $1 < x < \infty$ ,  $P_{-\frac{1}{2}+i\tau}^{-\mu}(x)$  is a real-valued solution of (14.20.1); in terms of  $Q_{-\frac{1}{2}\pm i\tau}^{\mu}(x)$  (which are complex-valued in general):

$$14.20.6 \quad P_{-\frac{1}{2}+i\tau}^{-\mu}(x) = \frac{ie^{-\mu\pi i}}{\sinh(\tau\pi) |\Gamma(\mu + \frac{1}{2} + i\tau)|^2} \left( Q_{-\frac{1}{2}+i\tau}^{\mu}(x) - Q_{-\frac{1}{2}-i\tau}^{\mu}(x) \right), \quad \tau \neq 0.$$

14.20(ii) Graphics

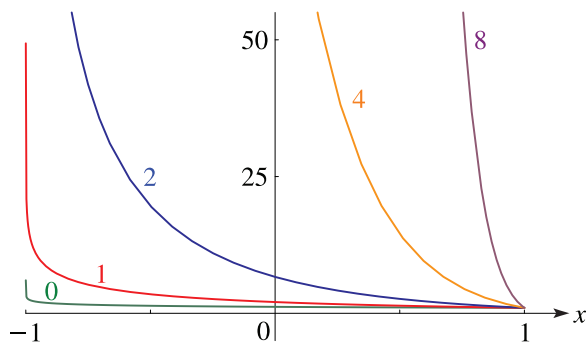


Figure 14.20.1:  $P_{-\frac{1}{2}+i\tau}^0(x), \tau = 0, 1, 2, 4, 8.$

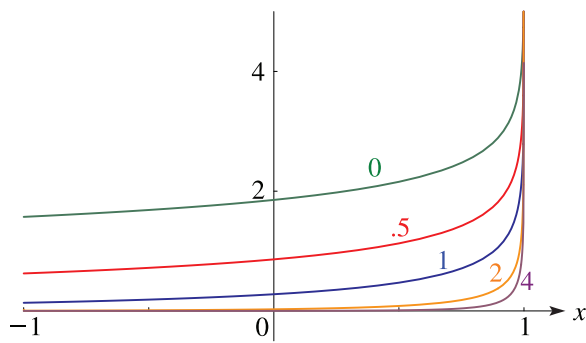


Figure 14.20.2:  $\hat{Q}_{-\frac{1}{2}+i\tau}^0(x), \tau = 0, \frac{1}{2}, 1, 2, 4.$

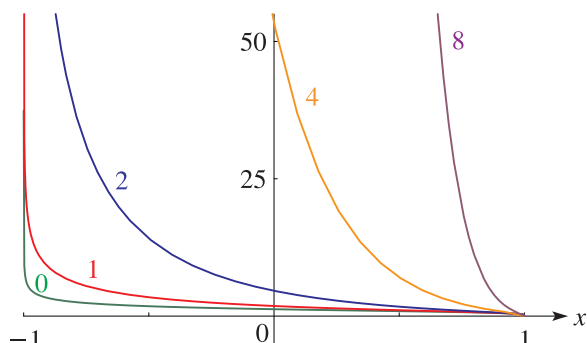


Figure 14.20.3:  $P_{-\frac{1}{2}+i\tau}^{-1/2}(x), \tau = 0, 1, 2, 4, 8.$

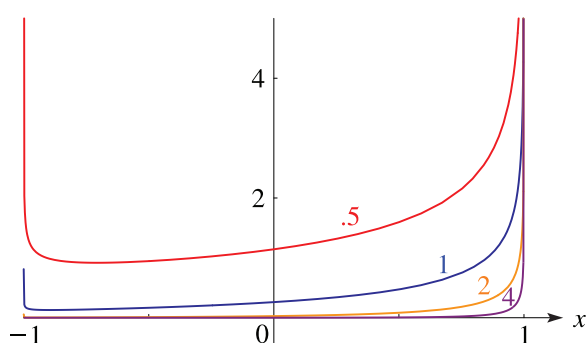


Figure 14.20.4:  $\hat{Q}_{-\frac{1}{2}+i\tau}^{-1/2}(x), \tau = \frac{1}{2}, 1, 2, 4.$  (This function does not exist when  $\tau = 0.$ )

For additional graphs see <http://dlmf.nist.gov/14.20.ii>.

14.20(iii) Behavior as  $x \rightarrow 1$

The behavior of  $P_{-\frac{1}{2}+i\tau}^{-\mu}(\pm x)$  as  $x \rightarrow 1-$  is given in §14.8(i). For  $\mu > 0$  and  $x \rightarrow 1-$ ,

14.20.7 
$$\hat{Q}_{-\frac{1}{2}+i\tau}^{\mu}(x) \sim \frac{1}{2} \Gamma(\mu) \left( \frac{2}{1-x} \right)^{\mu/2},$$

14.20.8

$$\hat{Q}_{-\frac{1}{2}+i\tau}^{-\mu}(x) \sim \frac{\pi \Gamma(\mu) (e^{-\tau\pi} \cos^2(\mu\pi) + \sinh(\tau\pi))}{2(\cosh^2(\tau\pi) - \sin^2(\mu\pi)) |\Gamma(\mu + \frac{1}{2} + i\tau)|^2} \times \left( \frac{2}{1-x} \right)^{\mu/2}.$$

14.20(iv) Integral Representation

When  $0 < \theta < \pi$ ,

14.20.9 
$$P_{-\frac{1}{2}+i\tau}(\cos \theta) = \frac{2}{\pi} \int_0^{\theta} \frac{\cosh(\tau\phi)}{\sqrt{2(\cos \phi - \cos \theta)}} d\phi.$$

14.20(v) Trigonometric Expansion

14.20.10

$$P_{-\frac{1}{2}+i\tau}(\cos \theta) = 1 + \frac{4\tau^2 + 1^2}{2^2} \sin^2\left(\frac{1}{2}\theta\right) + \frac{(4\tau^2 + 1^2)(4\tau^2 + 3^2)}{2^2 \cdot 4^2} \sin^4\left(\frac{1}{2}\theta\right) + \dots, \quad 0 \leq \theta \leq \pi.$$

From (14.20.9) or (14.20.10) it is evident that  $P_{-\frac{1}{2}+i\tau}(\cos \theta)$  is positive for real  $\theta$ .

14.20(vi) Generalized Mehler–Fock Transformation

14.20.11

$$f(\tau) = \frac{\tau}{\pi} \sinh(\tau\pi) \Gamma\left(\frac{1}{2} - \mu + i\tau\right) \times \Gamma\left(\frac{1}{2} - \mu - i\tau\right) \int_1^{\infty} P_{-\frac{1}{2}+i\tau}^{\mu}(x) g(x) dx,$$

where

14.20.12 
$$g(x) = \int_0^{\infty} P_{-\frac{1}{2}+i\tau}^{\mu}(x) f(\tau) d\tau.$$

Special cases:

$$14.20.13 \quad P_{-\frac{1}{2}+i\tau}(x) = \frac{\cosh(\tau\pi)}{\pi} \int_1^\infty \frac{P_{-\frac{1}{2}+i\tau}(t)}{x+t} dt,$$

$$14.20.14 \quad \pi \int_0^\infty \frac{\tau \tanh(\tau\pi)}{\cosh(\tau\pi)} P_{-\frac{1}{2}+i\tau}(x) P_{-\frac{1}{2}+i\tau}(y) d\tau = \frac{1}{y+x}.$$

**14.20(vii) Asymptotic Approximations: Large  $\tau$ , Fixed  $\mu$**

For  $\tau \rightarrow \infty$  and fixed  $\mu$ ,

$$14.20.15 \quad P_{-\frac{1}{2}+i\tau}^{-\mu}(\cos \theta) = \frac{1}{\tau^\mu} \left( \frac{\theta}{\sin \theta} \right)^{1/2} I_\mu(\tau\theta) \times (1 + O(1/\tau)),$$

$$14.20.16 \quad \widehat{Q}_{-\frac{1}{2}+i\tau}^{-\mu}(\cos \theta) = \frac{1}{\tau^\mu} \left( \frac{\theta}{\sin \theta} \right)^{1/2} K_\mu(\tau\theta) \times (1 + O(1/\tau)),$$

uniformly for  $\theta \in (0, \pi - \delta]$ , where  $I$  and  $K$  are the modified Bessel functions (§10.25(ii)) and  $\delta$  is an arbitrary constant such that  $0 < \delta < \pi$ . For asymptotic expansions and explicit error bounds, see Olver (1997b, pp. 473–474). See also Žurina and Karmazina (1966).

**14.20(viii) Asymptotic Approximations: Large  $\tau$ ,  $0 \leq \mu \leq A\tau$**

In this subsection and §14.20(ix),  $A$  and  $\delta$  denote arbitrary constants such that  $A > 0$  and  $0 < \delta < 2$ .

As  $\tau \rightarrow \infty$ ,

14.20.17

$$P_{-\frac{1}{2}+i\tau}^{-\mu}(x) = \sigma(\mu, \tau) \left( \frac{\alpha^2 + \eta}{1 + \alpha^2 - x^2} \right)^{1/4} I_\mu(\tau\eta^{1/2}) \times (1 + O(1/\tau)),$$

14.20.18

$$\widehat{Q}_{-\frac{1}{2}+i\tau}^{-\mu}(x) = \sigma(\mu, \tau) \left( \frac{\alpha^2 + \eta}{1 + \alpha^2 - x^2} \right)^{1/4} K_\mu(\tau\eta^{1/2}) \times (1 + O(1/\tau)),$$

uniformly for  $x \in [-1 + \delta, 1)$  and  $\mu \in [0, A\tau]$ . Here

14.20.19

$$\alpha = \mu/\tau,$$

14.20.20

$$\sigma(\mu, \tau) = \frac{\exp(\mu - \tau \arctan \alpha)}{(\mu^2 + \tau^2)^{\mu/2}}.$$

The variable  $\eta$  is defined implicitly by

$$14.20.21 \quad (\alpha^2 + \eta)^{1/2} + \frac{1}{2}\alpha \ln \eta - \alpha \ln \left( (\alpha^2 + \eta)^{1/2} + \alpha \right) = \arccos \left( \frac{x}{(1 + \alpha^2)^{1/2}} \right) + \frac{\alpha}{2} \ln \left( \frac{1 + \alpha^2 + (\alpha^2 - 1)x^2 - 2\alpha x(1 + \alpha^2 - x^2)^{1/2}}{(1 + \alpha^2)(1 - x^2)} \right),$$

where the inverse trigonometric functions take their principal values. The interval  $-1 < x < 1$  is mapped one-to-one to the interval  $0 < \eta < \infty$ , with the points  $x = -1$  and  $x = 1$  corresponding to  $\eta = \infty$  and  $\eta = 0$ , respectively.

For extensions to complex arguments (including the range  $1 < x < \infty$ ), asymptotic expansions, and explicit error bounds, see Dunster (1991).

**14.20(ix) Asymptotic Approximations: Large  $\mu$ ,  $0 \leq \tau \leq A\mu$**

As  $\mu \rightarrow \infty$ ,

$$14.20.22 \quad P_{-\frac{1}{2}+i\tau}^{-\mu}(x) = \frac{\beta \exp(\mu\beta \arctan \beta)}{\Gamma(\mu + 1) (1 + \beta^2)^{\mu/2}} \frac{e^{-\mu\rho}}{(1 + \beta^2 - x^2\beta^2)^{1/4}} \left( 1 + O\left(\frac{1}{\mu}\right) \right),$$

uniformly for  $x \in (-1, 1)$  and  $\tau \in [0, A\mu]$ . Here

14.20.23

$$\beta = \tau/\mu,$$

and the variable  $\rho$  is defined by

$$14.20.24 \quad \rho = \frac{1}{2} \ln \left( \frac{(1 - \beta^2)x^2 + 1 + \beta^2 + 2x(1 + \beta^2 - \beta^2x^2)^{1/2}}{1 - x^2} \right) + \beta \arctan \left( \frac{\beta x}{\sqrt{1 + \beta^2 - \beta^2x^2}} \right) - \frac{1}{2} \ln(1 + \beta^2),$$

with the inverse tangent taking its principal value. The interval  $-1 < x < 1$  is mapped one-to-one to the interval  $-\infty < \rho < \infty$ , with the points  $x = -1$ ,  $x = 0$ , and  $x = 1$  corresponding to  $\rho = -\infty$ ,  $\rho = 0$ , and  $\rho = \infty$ ,

respectively.

With the same conditions, the corresponding approximation for  $P_{-\frac{1}{2}+i\tau}^{-\mu}(-x)$  is obtainable by replacing  $e^{-\mu\rho}$  by  $e^{\mu\rho}$  on the right-hand side of (14.20.22). Ap-

proximations for  $P_{-\frac{1}{2}+i\tau}^\mu(x)$  and  $\widehat{Q}_{-\frac{1}{2}+i\tau}^{-\mu}(x)$  can then be achieved via (14.9.7) and (14.20.3).

For extensions to complex arguments (including the range  $1 < x < \infty$ ), asymptotic expansions, and explicit error bounds, see Dunster (1991).

**14.20(x) Zeros and Integrals**

For zeros of  $P_{-\frac{1}{2}+i\tau}(x)$  see Hobson (1931, §237).

For integrals with respect to  $\tau$  involving  $P_{-\frac{1}{2}+i\tau}(x)$ , see Prudnikov *et al.* (1990, pp. 218–228).

**Complex Arguments**

**14.21 Definitions and Basic Properties**

**14.21(i) Associated Legendre Equation**

14.21.1

$$(1 - z^2) \frac{d^2 w}{dz^2} - 2z \frac{dw}{dz} + \left( \nu(\nu + 1) - \frac{\mu^2}{1 - z^2} \right) w = 0.$$

Standard solutions: the associated Legendre functions  $P_\nu^\mu(z)$ ,  $P_\nu^{-\mu}(z)$ ,  $Q_\nu^\mu(z)$ , and  $Q_\nu^{-\mu}(z)$ .  $P_\nu^{\pm\mu}(z)$  and  $Q_\nu^\mu(z)$  exist for all values of  $\nu$ ,  $\mu$ , and  $z$ , except possibly  $z = \pm 1$  and  $\infty$ , which are branch points (or poles) of the functions, in general. When  $z$  is complex  $P_\nu^{\pm\mu}(z)$ ,  $Q_\nu^\mu(z)$ , and  $Q_\nu^{-\mu}(z)$  are defined by (14.3.6)–(14.3.10) with  $x$  replaced by  $z$ : the principal branches are obtained by taking the principal values of all the multivalued functions appearing in these representations when  $z \in (1, \infty)$ , and by continuity elsewhere

in the  $z$ -plane with a cut along the interval  $(-\infty, 1]$ ; compare §4.2(i). The principal branches of  $P_\nu^{\pm\mu}(z)$  and  $Q_\nu^\mu(z)$  are real when  $\nu, \mu \in \mathbb{R}$  and  $z \in (1, \infty)$ .

**14.21(ii) Numerically Satisfactory Solutions**

When  $\Re \nu \geq -\frac{1}{2}$  and  $\Re \mu \geq 0$ , a numerically satisfactory pair of solutions of (14.21.1) in the half-plane  $|\text{ph } z| \leq \frac{1}{2}\pi$  is given by  $P_\nu^{-\mu}(z)$  and  $Q_\nu^\mu(z)$ .

**14.21(iii) Properties**

Many of the properties stated in preceding sections extend immediately from the  $x$ -interval  $(1, \infty)$  to the cut  $z$ -plane  $\mathbb{C} \setminus (-\infty, 1]$ . This includes, for example, the Wronskian relations (14.2.7)–(14.2.11); hypergeometric representations (14.3.6)–(14.3.10) and (14.3.15)–(14.3.20); results for integer orders (14.6.3)–(14.6.5), (14.6.7), (14.6.8), (14.7.6), (14.7.7), and (14.7.11)–(14.7.16); behavior at singularities (14.8.7)–(14.8.16); connection formulas (14.9.11)–(14.9.16); recurrence relations (14.10.3)–(14.10.7). The generating function expansions (14.7.19) (with  $P$  replaced by  $P$ ) and (14.7.22) apply when  $|h| < \min |z \pm (z^2 - 1)^{1/2}|$ ; (14.7.21) (with  $P$  replaced by  $P$ ) applies when  $|h| > \max |z \pm (z^2 - 1)^{1/2}|$ .

**14.22 Graphics**

In the graphics shown in this section, height corresponds to the absolute value of the function and color to the phase. See also p. xiv.

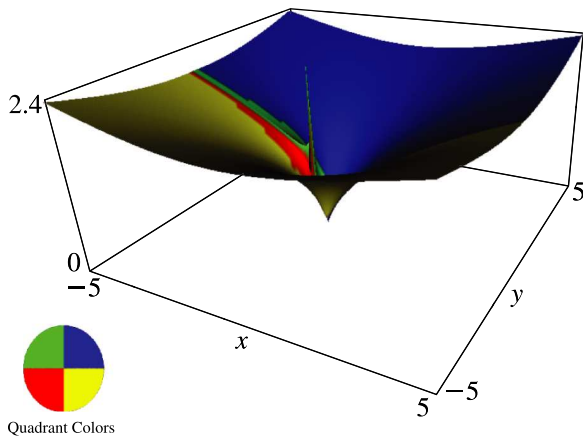


Figure 14.22.1:  $P_{1/2}^0(x + iy)$ ,  $-5 \leq x \leq 5, -5 \leq y \leq 5$ . There is a cut along the real axis from  $-\infty$  to  $-1$ .

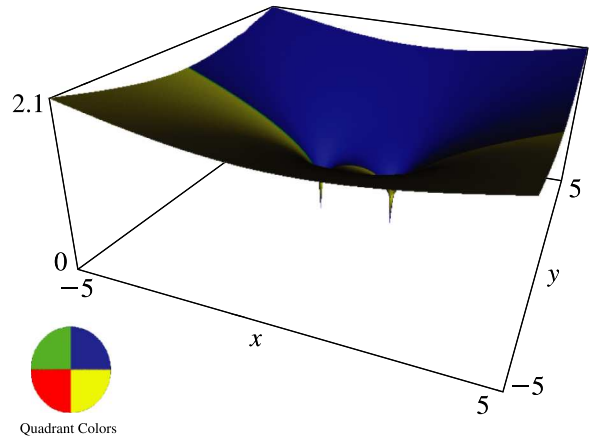


Figure 14.22.2:  $P_{1/2}^{-1/2}(x + iy)$ ,  $-5 \leq x \leq 5, -5 \leq y \leq 5$ . There is a cut along the real axis from  $-\infty$  to  $1$ .



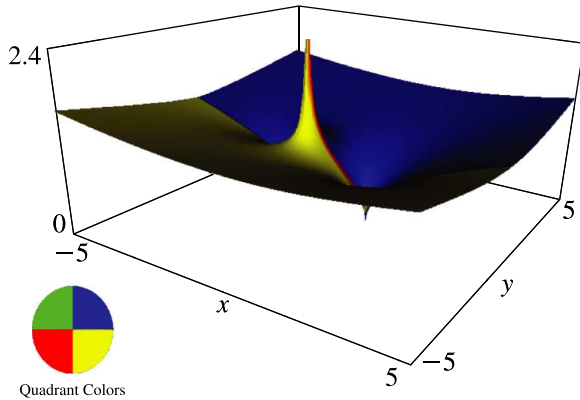


Figure 14.22.3:  $P_{1/2}^{-1}(x + iy)$ ,  $-5 \leq x \leq 5, -5 \leq y \leq 5$ . There is a cut along the real axis from  $-\infty$  to 1.

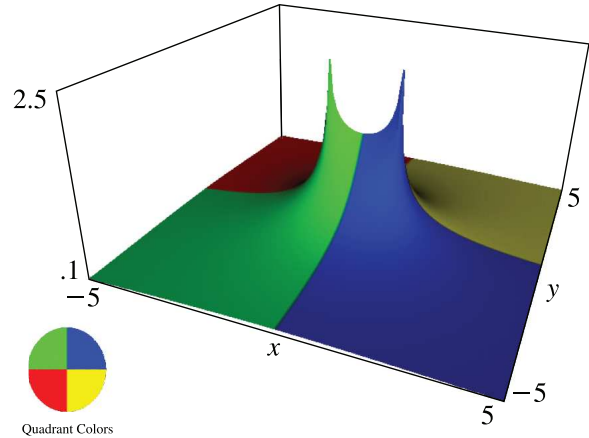


Figure 14.22.4:  $Q_0^0(x + iy)$ ,  $-5 \leq x \leq 5, -5 \leq y \leq 5$ . There is a cut along the real axis from  $-1$  to 1.

### 14.23 Values on the Cut

When  $-1 < x < 1$ ,

14.23.1 
$$P_\nu^\mu(x \pm i0) = e^{\mp \mu \pi i/2} P_\nu^\mu(x),$$

14.23.2 
$$Q_\nu^\mu(x \pm i0) = \frac{e^{\pm \mu \pi i/2}}{\Gamma(\nu + \mu + 1)} (Q_\nu^\mu(x) \mp \frac{1}{2} \pi i P_\nu^\mu(x)).$$

In terms of the hypergeometric function  $\mathbf{F}$  (§14.3(i))

14.23.3 
$$Q_\nu^\mu(x \pm i0) = \frac{e^{\mp \nu \pi i/2} \pi^{3/2} (1 - x^2)^{\mu/2}}{2\nu + 1} \left( \frac{x \mathbf{F}(\frac{1}{2}\mu - \frac{1}{2}\nu + \frac{1}{2}, \frac{1}{2}\nu + \frac{1}{2}\mu + 1; \frac{3}{2}; x^2)}{\Gamma(\frac{1}{2}\nu - \frac{1}{2}\mu + \frac{1}{2}) \Gamma(\frac{1}{2}\nu + \frac{1}{2}\mu + \frac{1}{2})} \mp i \frac{\mathbf{F}(\frac{1}{2}\mu - \frac{1}{2}\nu, \frac{1}{2}\nu + \frac{1}{2}\mu + \frac{1}{2}; \frac{1}{2}; x^2)}{\Gamma(\frac{1}{2}\nu - \frac{1}{2}\mu + 1) \Gamma(\frac{1}{2}\nu + \frac{1}{2}\mu + 1)} \right).$$

Conversely,

14.23.4 
$$P_\nu^\mu(x) = e^{\pm \mu \pi i/2} P_\nu^\mu(x \pm i0),$$

14.23.5 
$$Q_\nu^\mu(x) = \frac{1}{2} \Gamma(\nu + \mu + 1) \left( e^{-\mu \pi i/2} Q_\nu^\mu(x + i0) + e^{\mu \pi i/2} Q_\nu^\mu(x - i0) \right),$$

or equivalently,

14.23.6 
$$Q_\nu^\mu(x) = e^{\mp \mu \pi i/2} \Gamma(\nu + \mu + 1) Q_\nu^\mu(x \pm i0) \pm \frac{1}{2} \pi i e^{\pm \mu \pi i/2} P_\nu^\mu(x \pm i0).$$

If cuts are introduced along the intervals  $(-\infty, -1]$  and  $[1, \infty)$ , then (14.23.4) and (14.23.6) could be used to extend the definitions of  $P_\nu^\mu(x)$  and  $Q_\nu^\mu(x)$  to complex  $x$ .

The conical function defined by (14.20.2) can be represented similarly by

14.23.7 
$$\widehat{Q}_{-\frac{1}{2}+i\tau}^{-\mu}(x) = \frac{1}{2} e^{3\mu\pi i/2} Q_{-\frac{1}{2}+i\tau}^{-\mu}(x - i0) + \frac{1}{2} e^{-3\mu\pi i/2} Q_{-\frac{1}{2}-i\tau}^{-\mu}(x + i0).$$

### 14.24 Analytic Continuation

Let  $s$  be an arbitrary integer, and  $P_\nu^{-\mu}(ze^{s\pi i})$  and  $Q_\nu^\mu(ze^{s\pi i})$  denote the branches obtained from the principal branches by making  $\frac{1}{2}s$  circuits, in the positive sense, of the ellipse having  $\pm 1$  as foci and passing through  $z$ . Then

14.24.1 
$$P_\nu^{-\mu}(ze^{s\pi i}) = e^{s\nu\pi i} P_\nu^{-\mu}(z) + \frac{2i \sin((\nu + \frac{1}{2})s\pi) e^{-s\pi i/2}}{\cos(\nu\pi) \Gamma(\mu - \nu)} Q_\nu^\mu(z),$$

14.24.2 
$$Q_\nu^\mu(ze^{s\pi i}) = (-1)^s e^{-s\nu\pi i} Q_\nu^\mu(z),$$

the limiting value being taken in (14.24.1) when  $2\nu$  is an odd integer.

Next, let  $P_{\nu,s}^{-\mu}(z)$  and  $Q_{\nu,s}^\mu(z)$  denote the branches obtained from the principal branches by encircling the branch point 1 (but not the branch point  $-1$ )  $s$  times in the positive sense. Then

14.24.3 
$$P_{\nu,s}^{-\mu}(z) = e^{s\mu\pi i} P_\nu^{-\mu}(z),$$

$$14.24.4 \quad \begin{aligned} Q_{\nu,s}^\mu(z) &= e^{-s\mu\pi i} Q_\nu^\mu(z) \\ &- \frac{\pi i \sin(s\mu\pi)}{\sin(\mu\pi)\Gamma(\nu-\mu+1)} P_\nu^{-\mu}(z), \end{aligned}$$

the limiting value being taken in (14.24.4) when  $\mu \in \mathbb{Z}$ .

For fixed  $z$ , other than  $\pm 1$  or  $\infty$ , each branch of  $P_\nu^{-\mu}(z)$  and  $Q_\nu^\mu(z)$  is an entire function of each parameter  $\nu$  and  $\mu$ .

The behavior of  $P_\nu^{-\mu}(z)$  and  $Q_\nu^\mu(z)$  as  $z \rightarrow -1$  from the left on the upper or lower side of the cut from  $-\infty$  to 1 can be deduced from (14.8.7)–(14.8.11), combined with (14.24.1) and (14.24.2) with  $s = \pm 1$ .

### 14.25 Integral Representations

The principal values of  $P_\nu^{-\mu}(z)$  and  $Q_\nu^\mu(z)$  (§14.21(i)) are given by

$$14.25.1 \quad \begin{aligned} P_\nu^{-\mu}(z) &= \frac{(z^2-1)^{\mu/2}}{2^\nu \Gamma(\mu-\nu)\Gamma(\nu+1)} \int_0^\infty \frac{(\sinh t)^{2\nu+1}}{(z+\cosh t)^{\nu+\mu+1}} dt, \\ &\quad \Re\mu > \Re\nu > -1, \end{aligned}$$

$$14.25.2 \quad \begin{aligned} Q_\nu^\mu(z) &= \frac{\pi^{1/2} (z^2-1)^{\mu/2}}{2^\mu \Gamma(\mu+\frac{1}{2})\Gamma(\nu-\mu+1)} \\ &\times \int_0^\infty \frac{(\sinh t)^{2\mu}}{(z+(z^2-1)^{1/2} \cosh t)^{\nu+\mu+1}} dt, \\ &\quad \Re(\nu+1) > \Re\mu > -\frac{1}{2}, \end{aligned}$$

where the multivalued functions have their principal values when  $1 < z < \infty$  and are continuous in  $\mathbb{C} \setminus (-\infty, 1]$ .

For corresponding contour integrals, with less restrictions on  $\mu$  and  $\nu$ , see Olver (1997b, pp. 174–179), and for further integral representations see Magnus *et al.* (1966, §4.6.1).

### 14.26 Uniform Asymptotic Expansions

The uniform asymptotic approximations given in §14.15 for  $P_\nu^{-\mu}(x)$  and  $Q_\nu^\mu(x)$  for  $1 < x < \infty$  are extended to domains in the complex plane in the following references: §§14.15(i) and 14.15(ii), Dunster (2003b); §14.15(iii), Olver (1997b, Chapter 12); §14.15(iv), Boyd and Dunster (1986). For an extension of §14.15(iv) to complex argument and imaginary parameters, see Dunster (1990b).

See also Frenzen (1990), Gil *et al.* (2000), Shivakumar and Wong (1988), Ursell (1984), and Wong (1989) for uniform asymptotic approximations obtained from integral representations.

### 14.27 Zeros

$P_\nu^\mu(x \pm i0)$  (either side of the cut) has exactly one zero in the interval  $(-\infty, -1)$  if either of the following sets of conditions holds:

- (a)  $\mu < 0$ ,  $\mu \notin \mathbb{Z}$ ,  $\nu \in \mathbb{Z}$ , and  $\sin((\mu-\nu)\pi)$  and  $\sin(\mu\pi)$  have opposite signs.
- (b)  $\mu, \nu \in \mathbb{Z}$ ,  $\mu + \nu < 0$ , and  $\nu$  is odd.

For all other values of the parameters  $P_\nu^\mu(x \pm i0)$  has no zeros in the interval  $(-\infty, -1)$ .

For complex zeros of  $P_\nu^\mu(z)$  see Hobson (1931, §§233, 234, and 238).

### 14.28 Sums

#### 14.28(i) Addition Theorem

When  $\Re z_1 > 0$ ,  $\Re z_2 > 0$ ,  $|\text{ph}(z_1 - 1)| < \pi$ , and  $|\text{ph}(z_2 - 1)| < \pi$ ,

$$14.28.1 \quad \begin{aligned} &P_\nu(z_1 z_2 - (z_1^2 - 1)^{1/2} (z_2^2 - 1)^{1/2} \cos \phi) \\ &= P_\nu(z_1) P_\nu(z_2) + 2 \sum_{m=1}^\infty (-1)^m \frac{\Gamma(\nu - m + 1)}{\Gamma(\nu + m + 1)} \\ &\quad \times P_\nu^m(z_1) P_\nu^m(z_2) \cos(m\phi), \end{aligned}$$

where the branches of the square roots have their principal values when  $z_1, z_2 \in (1, \infty)$  and are continuous when  $z_1, z_2 \in \mathbb{C} \setminus (0, 1]$ . For this and similar results see Erdélyi *et al.* (1953a, §3.11).

#### 14.28(ii) Heine's Formula

$$14.28.2 \quad \sum_{n=0}^\infty (2n+1) Q_n(z_1) P_n(z_2) = \frac{1}{z_1 - z_2}, \quad z_1 \in \mathcal{E}_1, z_2 \in \mathcal{E}_2,$$

where  $\mathcal{E}_1$  and  $\mathcal{E}_2$  are ellipses with foci at  $\pm 1$ ,  $\mathcal{E}_2$  being properly interior to  $\mathcal{E}_1$ . The series converges uniformly for  $z_1$  outside or on  $\mathcal{E}_1$ , and  $z_2$  within or on  $\mathcal{E}_2$ .

#### 14.28(iii) Other Sums

See §14.18(iv).

### 14.29 Generalizations

Solutions of the equation

$$14.29.1 \quad \begin{aligned} &(1-z^2) \frac{d^2 w}{dz^2} - 2z \frac{dw}{dz} \\ &+ \left( \nu(\nu+1) - \frac{\mu_1^2}{2(1-z)} - \frac{\mu_2^2}{2(1+z)} \right) w \\ &= 0 \end{aligned}$$

are called *Generalized Associated Legendre Functions*. As in the case of (14.21.1), the solutions are hypergeometric functions, and (14.29.1) reduces to (14.21.1) when  $\mu_1 = \mu_2 = \mu$ . For properties see Virchenko and Fedotova (2001) and Braaksma and Meulenbeld (1967).

For inhomogeneous versions of the associated Legendre equation, and properties of their solutions, see Babister (1967, pp. 252–264).

## Applications

### 14.30 Spherical and Spheroidal Harmonics

#### 14.30(i) Definitions

With  $l$  and  $m$  integers such that  $0 \leq m \leq l$ , and  $\theta$  and  $\phi$  angles such that  $0 \leq \theta \leq \pi$ ,  $0 \leq \phi \leq 2\pi$ ,

##### 14.30.1

$$Y_{l,m}(\theta, \phi) = \left( \frac{(l-m)!(2l+1)}{4\pi(l+m)!} \right)^{1/2} e^{im\phi} P_l^m(\cos \theta),$$

---

#### Explicit Representation

14.30.3 
$$Y_{l,m}(\theta, \phi) = \frac{(-1)^{l+m}}{2^l l!} \left( \frac{(l-m)!(2l+1)}{4\pi(l+m)!} \right)^{1/2} e^{im\phi} (\sin \theta)^m \left( \frac{d}{d(\cos \theta)} \right)^{l+m} (\sin \theta)^{2l}.$$

#### Special Values

14.30.4 
$$Y_{l,m}(0, \phi) = \begin{cases} \left( \frac{2l+1}{4\pi} \right)^{1/2}, & m = 0, \\ 0, & m = 1, 2, 3, \dots \end{cases}$$

14.30.5 
$$Y_{l,m}\left(\frac{1}{2}\pi, \phi\right) = \begin{cases} \frac{(-1)^{(l+m)/2} e^{im\phi}}{2^l \left(\frac{1}{2}l - \frac{1}{2}m\right)! \left(\frac{1}{2}l + \frac{1}{2}m\right)!} \left( \frac{(l-m)!(l+m)!(2l+1)}{4\pi} \right)^{1/2}, & \frac{1}{2}l + \frac{1}{2}m \in \mathbb{Z}, \\ 0, & \frac{1}{2}l + \frac{1}{2}m \notin \mathbb{Z}. \end{cases}$$

#### Symmetry

14.30.6 
$$Y_{l,-m}(\theta, \phi) = (-1)^m Y_{l,m}^*(\theta, \phi).$$

#### Parity Operation

14.30.7 
$$Y_{l,m}(\pi - \theta, \phi + \pi) = (-1)^l Y_{l,m}(\theta, \phi).$$

#### Orthogonality

14.30.8 
$$\int_0^{2\pi} \int_0^\pi Y_{l_1, m_1}^*(\theta, \phi) Y_{l_2, m_2}(\theta, \phi) \sin \theta \, d\theta \, d\phi = \delta_{l_1, l_2} \delta_{m_1, m_2};$$

here and elsewhere in this section the asterisk (\*) denotes complex conjugate.

See also (34.3.22), and for further related integrals see Askey *et al.* (1986).

#### 14.30.2

$$Y_l^m(\theta, \phi) = \cos(m\phi) P_l^m(\cos \theta) \text{ or } \sin(m\phi) P_l^m(\cos \theta).$$

$Y_{l,m}(\theta, \phi)$  are known as *spherical harmonics*.  $Y_l^m(\theta, \phi)$  are known as *surface harmonics of the first kind: tesseral* for  $m < l$  and *sectorial* for  $m = l$ . Sometimes  $Y_{l,m}(\theta, \phi)$  is denoted by  $i^{-l} \mathfrak{D}_{lm}(\theta, \phi)$ ; also the definition of  $Y_{l,m}(\theta, \phi)$  can differ from (14.30.1), for example, by inclusion of a factor  $(-1)^m$ .

$P_n^m(x)$  and  $Q_n^m(x)$  ( $x > 1$ ) are often referred to as the *prolate spheroidal harmonics of the first and second kinds*, respectively.  $P_n^m(ix)$  and  $Q_n^m(ix)$  ( $x > 0$ ) are known as *oblate spheroidal harmonics of the first and second kinds*, respectively. Segura and Gil (1999) introduced the scaled oblate spheroidal harmonics  $R_n^m(x) = e^{-i\pi n/2} P_n^m(ix)$  and  $T_n^m(x) = ie^{i\pi n/2} Q_n^m(ix)$  which are real when  $x > 0$  and  $n = 0, 1, 2, \dots$

#### 14.30(ii) Basic Properties

Most mathematical properties of  $Y_{l,m}(\theta, \phi)$  can be derived directly from (14.30.1) and the properties of the Ferrers function of the first kind given earlier in this chapter.

### 14.30(iii) Sums

#### Distributional Completeness

For a series representation of the product of two Dirac deltas in terms of products of spherical harmonics see §1.17(iii).

#### Addition Theorem

$$P_l(\cos \theta_1 \cos \theta_2 + \sin \theta_1 \sin \theta_2 \cos(\phi_1 - \phi_2))$$

$$= \frac{4\pi}{2l+1} \sum_{m=-l}^l Y_{l,m}^*(\theta_1, \phi_1) Y_{l,m}(\theta_2, \phi_2).$$

See also (18.18.9) and (34.3.19).

### 14.30(iv) Applications

In general, *spherical harmonics* are defined as the class of homogeneous harmonic polynomials. See Andrews *et al.* (1999, Chapter 9). The special class of spherical harmonics  $Y_{l,m}(\theta, \phi)$ , defined by (14.30.1), appear in many physical applications. As an example, Laplace's equation  $\nabla^2 W = 0$  in spherical coordinates (§1.5(ii)):

$$\frac{1}{\rho^2} \frac{\partial}{\partial \rho} \left( \rho^2 \frac{\partial W}{\partial \rho} \right) + \frac{1}{\rho^2 \sin \theta} \frac{\partial}{\partial \theta} \left( \sin \theta \frac{\partial W}{\partial \theta} \right)$$

$$+ \frac{1}{\rho^2 \sin^2 \theta} \frac{\partial^2 W}{\partial \phi^2} = 0,$$

has solutions  $W(\rho, \theta, \phi) = \rho^l Y_{l,m}(\theta, \phi)$ , which are everywhere one-valued and continuous.

In the quantization of angular momentum the spherical harmonics  $Y_{l,m}(\theta, \phi)$  are normalized solutions of the eigenvalue equation

$$L^2 Y_{l,m} = \hbar^2 l(l+1) Y_{l,m},$$

where  $\hbar$  is the reduced Planck's constant, and  $L^2$  is the *angular momentum operator* in spherical coordinates:

$$L^2 = -\hbar^2 \left( \frac{1}{\sin \theta} \frac{\partial}{\partial \theta} \left( \sin \theta \frac{\partial}{\partial \theta} \right) + \frac{1}{\sin^2 \theta} \frac{\partial^2}{\partial \phi^2} \right);$$

see Edmonds (1974, §2.5).

For applications in geophysics see Stacey (1977, §§4.2, 6.3, and 8.1).

## 14.31 Other Applications

### 14.31(i) Toroidal Functions

Applications of toroidal functions include expansion of vacuum magnetic fields in stellarators and tokamaks (van Milligen and López Fraguas (1994)), analytic solutions of Poisson's equation in channel-like geometries (Hoyles *et al.* (1998)), and Dirichlet problems with toroidal symmetry (Gil *et al.* (2000)).

### 14.31(ii) Conical Functions

The conical functions  $P_{-\frac{1}{2}+i\tau}^m(x)$  appear in boundary-value problems for the Laplace equation in toroidal coordinates (§14.19(i)) for regions bounded by cones, by two intersecting spheres, or by one or two confocal hyperboloids of revolution (Kölbig (1981)). These functions are also used in the Mehler–Fock integral transform (§14.20(vi)) for problems in potential and heat theory, and in elementary particle physics (Sneddon (1972, Chapter 7) and Braaksma and Meulenbeld (1967)). The conical functions and Mehler–Fock transform generalize to Jacobi functions and the Jacobi transform; see Koornwinder (1984a) and references therein.

### 14.31(iii) Miscellaneous

Many additional physical applications of Legendre polynomials and associated Legendre functions include solution of the Helmholtz equation, as well as the Laplace equation, in spherical coordinates (Temme (1996a)), quantum mechanics (Edmonds (1974)), and high-frequency scattering by a sphere (Nussenzweig (1965)). See also §18.39.

Legendre functions  $P_\nu(x)$  of complex degree  $\nu$  appear in the application of complex angular momentum techniques to atomic and molecular scattering (Connor and Mackay (1979)).

## Computation

### 14.32 Methods of Computation

Essentially the same comments that are made in §15.19 concerning the computation of hypergeometric functions apply to the functions described in the present chapter. In particular, for small or moderate values of the parameters  $\mu$  and  $\nu$  the power-series expansions of the various hypergeometric function representations given in §§14.3(i)–14.3(iii), 14.19(ii), and 14.20(i) can be selected in such a way that convergence is stable, and reasonably rapid, especially when the argument of the functions is real. In other cases recurrence relations (§14.10) provide a powerful method when applied in a stable direction (§3.6); see Olver and Smith (1983) and Gautschi (1967).

Other methods include:

- Application of the uniform asymptotic expansions for large values of the parameters given in §§14.15 and 14.20(vii)–14.20(ix).
- Numerical integration (§3.7) of the defining differential equations (14.2.2), (14.20.1), and (14.21.1).

- Quadrature (§3.5) of the integral representations given in §§14.12, 14.19(iii), 14.20(iv), and 14.25; see Segura and Gil (1999) and Gil *et al.* (2000).
- Evaluation (§3.10) of the continued fractions given in §14.14. See Gil and Segura (2000).

### 14.33 Tables

- Abramowitz and Stegun (1964, Chapter 8) tabulates  $P_n(x)$  for  $n = 0(1)3, 9, 10$ ,  $x = 0(.01)1$ , 5–8D;  $P'_n(x)$  for  $n = 1(1)4, 9, 10$ ,  $x = 0(.01)1$ , 5–7D;  $Q_n(x)$  and  $Q'_n(x)$  for  $n = 0(1)3, 9, 10$ ,  $x = 0(.01)1$ , 6–8D;  $P_n(x)$  and  $P'_n(x)$  for  $n = 0(1)5, 9, 10$ ,  $x = 1(.2)10$ , 6S;  $Q_n(x)$  and  $Q'_n(x)$  for  $n = 0(1)3, 9, 10$ ,  $x = 1(.2)10$ , 6S. (Here primes denote derivatives with respect to  $x$ .)
- Zhang and Jin (1996, Chapter 4) tabulates  $P_n(x)$  for  $n = 2(1)5, 10$ ,  $x = 0(.1)1$ , 7D;  $P_n(\cos \theta)$  for  $n = 1(1)4, 10$ ,  $\theta = 0(5^\circ)90^\circ$ , 8D;  $Q_n(x)$  for  $n = 0(1)2, 10$ ,  $x = 0(.1)0.9$ , 8S;  $Q_n(\cos \theta)$  for  $n = 0(1)3, 10$ ,  $\theta = 0(5^\circ)90^\circ$ , 8D;  $P_n^m(x)$  for  $m = 1(1)4$ ,  $n - m = 0(1)2$ ,  $n = 10$ ,  $x = 0, 0.5$ , 8S;  $Q_n^m(x)$  for  $m = 1(1)4$ ,  $n = 0(1)2, 10$ , 8S;  $P_\nu^m(\cos \theta)$  for  $m = 0(1)3$ ,  $\nu = 0(.25)5$ ,  $\theta = 0(15^\circ)90^\circ$ , 5D;  $P_n(x)$  for  $n = 2(1)5, 10$ ,  $x = 1(1)10$ , 7S;  $Q_n(x)$  for  $n = 0(1)2, 10$ ,  $x = 2(1)10$ , 8S. Corresponding values of the derivative of each function are also included, as are 6D values of the first 5  $\nu$ -zeros of  $P_\nu^m(\cos \theta)$  and of its derivative for  $m = 0(1)4$ ,  $\theta = 10^\circ, 30^\circ, 150^\circ$ .
- Belousov (1962) tabulates  $P_n^m(\cos \theta)$  (normalized) for  $m = 0(1)36$ ,  $n - m = 0(1)56$ ,  $\theta = 0(2.5^\circ)90^\circ$ , 6D.
- Žurina and Karmazina (1964, 1965) tabulate the conical functions  $P_{-\frac{1}{2}+i\tau}(x)$  for  $\tau = 0(.01)50$ ,  $x = -0.9(.1)0.9$ , 7S;  $P_{-\frac{1}{2}+i\tau}(x)$  for  $\tau = 0(.01)50$ ,  $x = 1.1(.1)2(.2)5(.5)10(10)60$ , 7D. Auxiliary tables are included to facilitate computation for larger values of  $\tau$  when  $-1 < x < 1$ .
- Žurina and Karmazina (1963) tabulates the conical functions  $P_{-\frac{1}{2}+i\tau}^1(x)$  for  $\tau = 0(.01)25$ ,  $x = -0.9(.1)0.9$ , 7S;  $P_{-\frac{1}{2}+i\tau}^1(x)$  for  $\tau = 0(.01)25$ ,  $x = 1.1(.1)2(.2)5(.5)10(10)60$ , 7S. Auxiliary tables are included to assist computation for larger values of  $\tau$  when  $-1 < x < 1$ .

For tables prior to 1961 see Fletcher *et al.* (1962) and Lebedev and Fedorova (1960).

### 14.34 Software

See <http://dlmf.nist.gov/14.34>.

## References

### General References

The main reference used in writing this chapter is Olver (1997b). For additional bibliographic reading see Erdélyi *et al.* (1953a, Chapter III), Hobson (1931), Jeffreys and Jeffreys (1956), MacRobert (1967), Magnus *et al.* (1966), Robin (1957, 1958, 1959), Snow (1952), Szegő (1967), Temme (1996a), and Wong (1989).

### Sources

The following list gives the references or other indications of proofs that were used in constructing the various sections of this chapter. These sources supplement the references that are quoted in the text.

- §14.2 For §§14.2(i), 14.2(ii) see Olver (1997b, pp. 169). For §14.2(iii) see Olver (1997b, p. 172) for the pair  $P_\nu^{-\mu}(x)$  and  $Q_\nu^\mu(x)$ . The result for  $P_\nu^{-\mu}(x)$  and  $P_\nu^{-\mu}(-x)$  follows from the fact that when  $\Re \mu \geq 0$ ,  $P_\nu^{-\mu}(x)$  is recessive as  $x \rightarrow 1^-$  and  $P_\nu^{-\mu}(-x)$  is recessive as  $x \rightarrow -1^+$ ; see §14.8(i). For §14.2(iv) see Olver (1997b, p. 172) for (14.2.4), (14.2.5); the other results may be derived in a similar manner, or by application of the connection formulas in §14.9.
- §14.3 For (14.3.1)–(14.3.4) see Olver (1997b, pp. 159, 186). The version of (14.3.4) given in Hobson (1931, p. 386) has an error. For (14.3.5) use (14.3.1) and (14.9.3). For (14.3.8) see Olver (1997b, p. 159, Eq. (9.05)). For (14.3.11) and (14.3.12) see Olver (1997b, p. 187). For (14.3.16)–(14.3.20) see Erdélyi *et al.* (1953a, pp. 123–139). For (14.3.21) combine (14.3.22) and (14.23.4). For (14.3.22) see Erdélyi *et al.* (1953a, p. 175). For (14.3.23) see (14.3.6) and Olver (1997b, p. 167).
- §14.4 These graphics were produced at NIST.
- §14.5 (14.5.1)–(14.5.4) may be derived from (14.3.11)–(14.3.14) and also (14.10.4) with P replaced by Q. For (14.5.5)–(14.5.10) use §14.7(i). For (14.5.11)–(14.5.19) see Erdélyi *et al.* (1953a, p. 150). (14.5.20)–(14.5.27) are given in Magnus *et al.* (1966, p. 173): to verify these compare the hypergeometric representations of the Legendre functions and elliptic integrals (§§14.3 and 19.5).
- §14.6 See Erdélyi *et al.* (1953a, pp. 148–149). For (14.6.5) combine (14.3.10) and (14.6.4).

- §14.7 Olver (1997b, pp. 174, 181–182, 188). For (14.7.17), (14.7.18) use (14.9.8), (14.9.10). For (14.7.19)–(14.7.22) see Erdélyi *et al.* (1953a, p. 154) and Olver (1997b, pp. 51, 85).
- §14.8 Olver (1997b, pp. 171, 173, 186), Erdélyi *et al.* (1953a, p. 163). (14.8.5) may be derived from (14.8.1), (14.9.2). (14.8.10) may be derived from (14.8.7), (14.9.12). (14.8.16) may be derived from (14.8.15), (14.9.12).
- §14.9 Olver (1997b, pp. 171, 174, 186, 188). For (14.9.3), (14.9.4) use (14.9.1), (14.9.2). For (14.9.17) use (14.9.14), (14.9.16).
- §14.10 Erdélyi *et al.* (1953a, pp. 160–161).
- §14.11 (14.11.1) may be derived from (14.3.1). (14.11.2) may be derived from (14.9.10) and (14.11.1). (14.11.4) may be derived from (14.3.1) and the hypergeometric expansion for  $Q_\nu(x)$  (Hobson (1931, §132)). (14.11.5) may be derived from (14.9.8), (14.9.10), and (14.11.4).
- §14.12 Erdélyi *et al.* (1953a, pp. 155–159), Olver (1997b, pp. 181–183, 185).
- §14.13 Erdélyi *et al.* (1953a, pp. 146, 151).
- §14.14 (14.14.1) follows from (14.10.6). (14.14.3) follows from (14.10.3), with  $P_\nu^\mu(x)$  replaced by  $Q_\nu^\mu(x)$ . For further details see Gil *et al.* (2000).
- §14.15 Dunster (2003b), Olver (1997b, pp. 463–469), Boyd and Dunster (1986). (14.15.1) may be derived from (14.3.1) and §15.12(ii). For (14.15.24)–(14.15.31) see Olver (1975b).
- §14.16 Hobson (1931, pp. 386–389, 399–401).
- §14.17 Erdélyi *et al.* (1953a, pp. 170–172), Olver (1997b, pp. 188–189). (14.17.1)–(14.17.4) may be verified by differentiation and using the recurrence relations (§14.10). (14.17.7), (14.17.9) may be derived from (14.9.3), (14.17.6), (14.17.8). The version of (14.17.16) given in Erdélyi *et al.* (1953a, p. 171, Eq. (18)) is incorrect. For (14.17.17) see Din (1981).
- §14.18 Erdélyi *et al.* (1953a, pp. 162, 167–169), Olver (1997b, p. 183). Errors in Erdélyi *et al.* (1953a, pp. 168–169) have been corrected. (14.18.2) may be derived from (14.7.16), (14.9.3), (14.18.1). (14.18.8) may be derived from (14.7.17), (14.18.9).
- §14.19 Erdélyi *et al.* (1953a, pp. 156–157, 166, 173). For (14.19.7), (14.19.8) combine (14.9.16), (14.9.17) with (14.9.11)–(14.9.13).
- §14.20 (14.20.3) follows from (14.9.10), (14.20.2). (14.20.4), (14.20.5) follow from (14.2.3), (14.20.3). (14.20.6) follows from (14.3.10), (14.9.12). (14.20.7), (14.20.8) follow from §14.8(i) and (14.20.3). (14.20.9) follows from (14.12.1). For (14.20.10) see Erdélyi *et al.* (1953a, p. 174). For (14.20.11)–(14.20.14) see Braaksma and Meulenbeld (1967). For (14.20.15) see Olver (1997b, p. 473). (14.20.16) may be derived from (14.20.18). For §§14.20(viii), 14.20(ix) see Dunster (1991, Eqs. (5.11), (5.14) have been corrected). The graphs were produced at NIST.
- §14.21 Olver (1997b, pp. 169–185), Erdélyi *et al.* (1953a, Chapter 3).
- §14.22 These graphics were produced at NIST.
- §14.23 For (14.23.1), (14.23.5) see Olver (1997b, p. 185). For (14.23.7) see Dunster (1991). (14.23.2) may be derived from (14.23.4), (14.24.2). (14.23.3) may be derived from (14.3.11), (14.3.12), (14.9.14). (14.23.4) may be derived from (14.23.1). (14.23.6) may be derived from (14.23.1), (14.23.2).
- §14.24 Olver (1997b, p. 179).
- §14.25 For (14.25.1) see Olver (1997b, p. 179). For (14.25.2) see Erdélyi *et al.* (1953a, p. 155).
- §14.27 Hobson (1931, pp. 391–399).
- §14.28 Erdélyi *et al.* (1953a, p. 168) or Olver (1997b, p. 473).
- §14.30 Edmonds (1974, pp. 20–24, 63). (Note that Edmonds'  $P_l^m(x)$  differs by a factor  $(-1)^m$  from  $P_l^m(x)$ .) (14.30.4) may be derived from (14.8.1), (14.8.2), (14.30.1). (14.30.5) may be derived from (14.5.1), (14.30.1). (14.30.7) may be derived from (14.7.17), (14.30.1). (14.30.3) also follows from (14.30.1), (14.7.10).



## Chapter 15

# Hypergeometric Function

A. B. Olde Daalhuis<sup>1</sup>

<b>Notation</b>	<b>384</b>	15.12 Asymptotic Approximations . . . . .	396
15.1 Special Notation . . . . .	384	15.13 Zeros . . . . .	398
<b>Properties</b>	<b>384</b>	15.14 Integrals . . . . .	398
15.2 Definitions and Analytical Properties . . .	384	15.15 Sums . . . . .	399
15.3 Graphics . . . . .	385	15.16 Products . . . . .	399
15.4 Special Cases . . . . .	386	<b>Applications</b>	<b>399</b>
15.5 Derivatives and Contiguous Functions . .	387	15.17 Mathematical Applications . . . . .	399
15.6 Integral Representations . . . . .	388	15.18 Physical Applications . . . . .	400
15.7 Continued Fractions . . . . .	389	<b>Computation</b>	<b>400</b>
15.8 Transformations of Variable . . . . .	390	15.19 Methods of Computation . . . . .	400
15.9 Relations to Other Functions . . . . .	393	15.20 Software . . . . .	401
15.10 Hypergeometric Differential Equation . .	394	<b>References</b>	<b>401</b>
15.11 Riemann's Differential Equation . . . . .	396		

<sup>1</sup>School of Mathematics, Edinburgh University, Edinburgh, United Kingdom.

**Acknowledgments:** This chapter is based in part on Chapter 15 of Abramowitz and Stegun (1964) by Fritz Oberhettinger. The author thanks Richard Askey and Simon Ruijsenaars for many helpful recommendations.

**Copyright** © 2009 National Institute of Standards and Technology. All rights reserved.



## Notation

### 15.1 Special Notation

(For other notation see pp. xiv and 873.)

$x$	real variable.
$z = x + iy$	complex variable.
$a, b, c$	real or complex parameters.
$k, \ell, m, n$	integers.
$s$	nonnegative integer.
$\delta$	arbitrary small positive constant.
$\Gamma(z)$	gamma function (§5.2(i)).
$\psi(z)$	$\Gamma'(z)/\Gamma(z)$ .

Unless indicated otherwise primes denote derivatives with respect to the variable.

We use the following notations for the hypergeometric function:

$$15.1.1 \quad {}_2F_1(a, b; c; z) = F(a, b; c; z) = F\left(\begin{matrix} a, b \\ c \end{matrix}; z\right),$$

and also

$$15.1.2 \quad \frac{F(a, b; c; z)}{\Gamma(c)} = \mathbf{F}(a, b; c; z) = \mathbf{F}\left(\begin{matrix} a, b \\ c \end{matrix}; z\right) = {}_2\mathbf{F}_1(a, b; c; z),$$

(Olver (1997b, Chapter 5)).

## Properties

### 15.2 Definitions and Analytical Properties

#### 15.2(i) Gauss Series

The hypergeometric function  $F(a, b; c; z)$  is defined by the *Gauss series*

$$15.2.1 \quad \begin{aligned} F(a, b; c; z) &= \sum_{s=0}^{\infty} \frac{(a)_s (b)_s}{(c)_s s!} z^s \\ &= 1 + \frac{ab}{c} z + \frac{a(a+1)b(b+1)}{c(c+1)2!} z^2 + \dots \\ &= \frac{\Gamma(c)}{\Gamma(a)\Gamma(b)} \sum_{s=0}^{\infty} \frac{\Gamma(a+s)\Gamma(b+s)}{\Gamma(c+s)s!} z^s, \end{aligned}$$

on the disk  $|z| < 1$ , and by analytic continuation elsewhere. In general,  $F(a, b; c; z)$  does not exist when

$c = 0, -1, -2, \dots$ . The branch obtained by introducing a cut from 1 to  $+\infty$  on the real  $z$ -axis, that is, the branch in the sector  $|\text{ph}(1-z)| \leq \pi$ , is the *principal branch* (or *principal value*) of  $F(a, b; c; z)$ .

For all values of  $c$

$$15.2.2 \quad \mathbf{F}(a, b; c; z) = \sum_{s=0}^{\infty} \frac{(a)_s (b)_s}{\Gamma(c+s)s!} z^s, \quad |z| < 1,$$

again with analytic continuation for other values of  $z$ , and with the principal branch defined in a similar way.

*Except where indicated otherwise* principal branches of  $F(a, b; c; z)$  and  $\mathbf{F}(a, b; c; z)$  are assumed throughout this Handbook.

The difference between the principal branches on the two sides of the branch cut (§4.2(i)) is given by

$$15.2.3 \quad \begin{aligned} &\mathbf{F}\left(\begin{matrix} a, b \\ c \end{matrix}; x + i0\right) - \mathbf{F}\left(\begin{matrix} a, b \\ c \end{matrix}; x - i0\right) \\ &= \frac{2\pi i}{\Gamma(a)\Gamma(b)} (x-1)^{c-a-b} \mathbf{F}\left(\begin{matrix} c-a, c-b \\ c-a-b+1 \end{matrix}; 1-x\right), \end{aligned}$$

$x > 1$ .

On the circle of convergence,  $|z| = 1$ , the Gauss series:

- (a) Converges absolutely when  $\Re(c-a-b) > 0$ .
- (b) Converges conditionally when  $-1 < \Re(c-a-b) \leq 0$  and  $z = 1$  is excluded.
- (c) Diverges when  $\Re(c-a-b) \leq -1$ .

For the case  $z = 1$  see also §15.4(ii).

#### 15.2(ii) Analytic Properties

The principal branch of  $\mathbf{F}(a, b; c; z)$  is an entire function of  $a$ ,  $b$ , and  $c$ . The same is true of other branches, provided that  $z = 0, 1$ , and  $\infty$  are excluded. As a multi-valued function of  $z$ ,  $\mathbf{F}(a, b; c; z)$  is analytic everywhere except for possible branch points at  $z = 0, 1$ , and  $\infty$ . The same properties hold for  $F(a, b; c; z)$ , except that as a function of  $c$ ,  $F(a, b; c; z)$  in general has poles at  $c = 0, -1, -2, \dots$ .

Because of the analytic properties with respect to  $a$ ,  $b$ , and  $c$ , it is usually legitimate to take limits in formulas involving functions that are undefined for certain values of the parameters.

For example, when  $a = -m$ ,  $m = 0, 1, 2, \dots$ , and  $c \neq 0, -1, -2, \dots$ ,  $F(a, b; c; z)$  is a polynomial:

$$F(-m, b; c; z)$$

$$15.2.4 \quad = \sum_{n=0}^m \frac{(-m)_n (b)_n}{(c)_n n!} z^n = \sum_{n=0}^m (-1)^n \binom{m}{n} \frac{(b)_n}{(c)_n} z^n.$$

This formula is also valid when  $c = -m - \ell$ ,  $\ell = 0, 1, 2, \dots$ , provided that we use the interpretation

$$15.2.5 \quad F\left(\begin{matrix} -m, b \\ -m - \ell \end{matrix}; z\right) = \lim_{c \rightarrow -m - \ell} \left( \lim_{a \rightarrow -m} F\left(\begin{matrix} a, b \\ c \end{matrix}; z\right) \right),$$

and not

$$15.2.6 \quad F\left(\begin{matrix} -m, b \\ -m - \ell \end{matrix}; z\right) = \lim_{a \rightarrow -m} F\left(\begin{matrix} a, b \\ a - \ell \end{matrix}; z\right),$$

which is sometimes used in the literature. (Both interpretations give solutions of the hypergeometric differential equation (15.10.1), as does  $F(a, b; c; z)$ , which is analytic at  $c = 0, -1, -2, \dots$ .) For illustration see Figures 15.3.6 and 15.3.7.

In the case  $c = -m$  the right-hand side of (15.2.4) becomes the first  $m + 1$  terms of the Maclaurin series for  $(1 - z)^{-b}$ .

### 15.3 Graphics

#### 15.3(i) Graphs

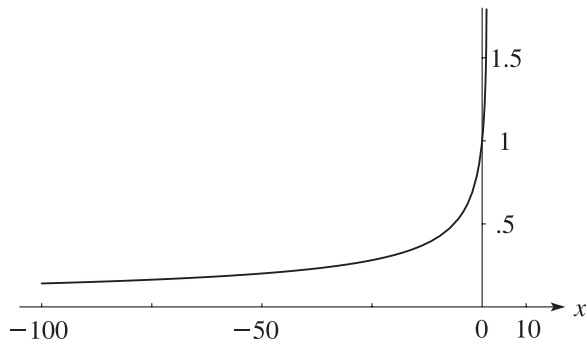


Figure 15.3.1:  $F\left(\frac{4}{3}, \frac{9}{16}; \frac{14}{5}; x\right)$ ,  $-100 \leq x \leq 1$ .

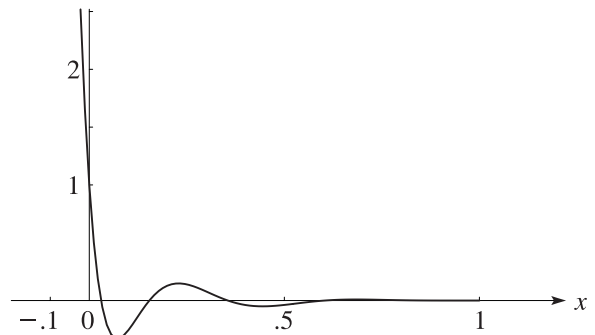


Figure 15.3.2:  $F(5, -10; 1; x)$ ,  $-0.023 \leq x \leq 1$ .

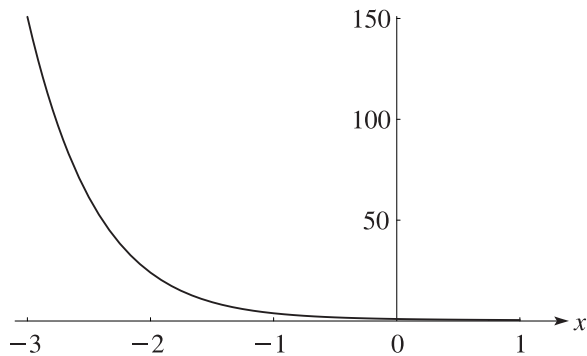


Figure 15.3.3:  $F(1, -10; 10; x)$ ,  $-3 \leq x \leq 1$ .

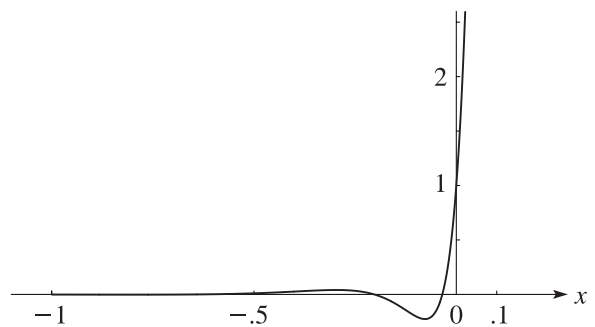


Figure 15.3.4:  $F(5, 10; 1; x)$ ,  $-1 \leq x \leq 0.022$ .

### 15.3(ii) Surfaces

In Figures 15.3.5 and 15.3.6, height corresponds to the absolute value of the function and color to the phase. See also p. xiv.

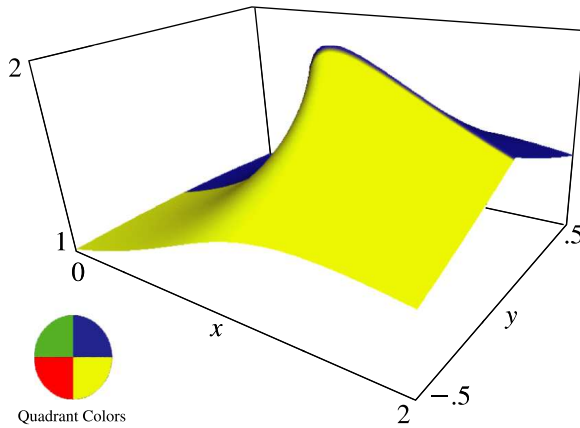


Figure 15.3.5:  $F\left(\frac{4}{3}, \frac{9}{16}; \frac{14}{5}; x + iy\right)$ ,  $0 \leq x \leq 2$ ,  $-0.5 \leq y \leq 0.5$ . (There is a cut along the real axis from 1 to  $\infty$ .)

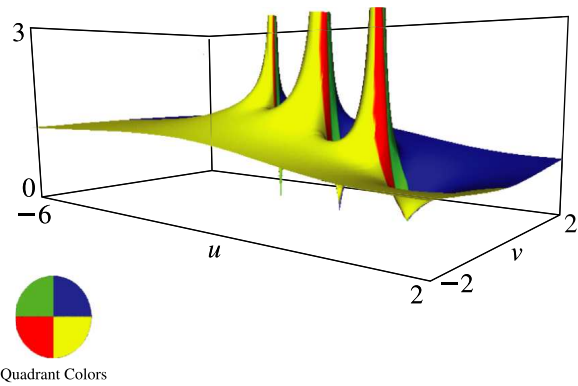


Figure 15.3.6:  $F\left(-3, \frac{3}{5}; u + iv; \frac{1}{2}\right)$ ,  $-6 \leq u \leq 2$ ,  $-2 \leq v \leq 2$ . (With  $c = u + iv$  the only poles occur at  $c = 0, -1, -2$ ; compare §15.2(ii).)

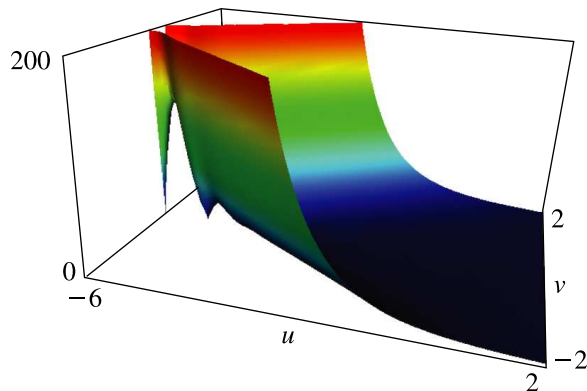


Figure 15.3.7:  $|F(-3, \frac{3}{5}; u + iv; \frac{1}{2})|$ ,  $-6 \leq u \leq 2$ ,  $-2 \leq v \leq 2$ .

## 15.4 Special Cases

### 15.4(i) Elementary Functions

The following results hold for principal branches when  $|z| < 1$ , and by analytic continuation elsewhere. Exceptions are (15.4.8) and (15.4.10), that hold for  $|z| < \pi/4$ , and (15.4.12), (15.4.14), and (15.4.16), that hold for  $|z| < \pi/2$ .

$$15.4.1 \quad F(1, 1; 2; z) = -z^{-1} \ln(1 - z),$$

$$15.4.2 \quad F\left(\frac{1}{2}, 1; \frac{3}{2}; z^2\right) = \frac{1}{2z} \ln\left(\frac{1+z}{1-z}\right),$$

$$15.4.3 \quad F\left(\frac{1}{2}, 1; \frac{3}{2}; -z^2\right) = z^{-1} \arctan z,$$

$$15.4.4 \quad F\left(\frac{1}{2}, \frac{1}{2}; \frac{3}{2}; z^2\right) = z^{-1} \arcsin z,$$

$$15.4.5 \quad F\left(\frac{1}{2}, \frac{1}{2}; \frac{3}{2}; -z^2\right) = z^{-1} \ln\left(z + \sqrt{1+z^2}\right).$$

$$15.4.6 \quad F(a, b; b; z) = (1 - z)^{-a};$$

compare §15.2(ii).

$$15.4.7 \quad F\left(a, \frac{1}{2} + a; \frac{1}{2}; z^2\right) = \frac{1}{2} \left( (1+z)^{-2a} + (1-z)^{-2a} \right),$$

$$15.4.8 \quad F\left(a, \frac{1}{2} + a; \frac{1}{2}; -\tan^2 z\right) = (\cos z)^{2a} \cos(2az).$$

$$15.4.9 \quad F\left(a, \frac{1}{2} + a; \frac{3}{2}; z^2\right) = \frac{1}{(2-4a)z} \left( (1+z)^{1-2a} - (1-z)^{1-2a} \right),$$

15.4.10

$$F\left(a, \frac{1}{2} + a; \frac{3}{2}; -\tan^2 z\right) = (\cos z)^{2a} \frac{\sin((1-2a)z)}{(1-2a)\sin z}.$$

$$15.4.11 \quad F\left(-a, a; \frac{1}{2}; -z^2\right) = \frac{1}{2} \left( \left( \sqrt{1+z^2} + z \right)^{2a} + \left( \sqrt{1+z^2} - z \right)^{2a} \right),$$

$$15.4.12 \quad F\left(-a, a; \frac{1}{2}; \sin^2 z\right) = \cos(2az).$$

15.4.13

$$F\left(a, 1-a; \frac{1}{2}; -z^2\right) = \frac{1}{2\sqrt{1+z^2}} \left( \left( \sqrt{1+z^2} + z \right)^{2a-1} + \left( \sqrt{1+z^2} - z \right)^{2a-1} \right),$$

$$15.4.14 \quad F\left(a, 1-a; \frac{1}{2}; \sin^2 z\right) = \frac{\cos((2a-1)z)}{\cos z}.$$

15.4.15

$$F\left(a, 1-a; \frac{3}{2}; -z^2\right) = \frac{1}{(2-4a)z} \left( \left( \sqrt{1+z^2} + z \right)^{1-2a} - \left( \sqrt{1+z^2} - z \right)^{1-2a} \right),$$

15.4.16  $F\left(a, 1-a; \frac{3}{2}; \sin^2 z\right) = \frac{\sin((2a-1)z)}{(2a-1)\sin z}.$

15.4.17  $F\left(a, \frac{1}{2}+a; 1+2a; z\right) = \left(\frac{1}{2} + \frac{1}{2}\sqrt{1-z}\right)^{-2a},$

15.4.18  $F\left(a, \frac{1}{2}+a; 2a; z\right) = \frac{1}{\sqrt{1-z}} \left(\frac{1}{2} + \frac{1}{2}\sqrt{1-z}\right)^{1-2a}.$

15.4.19  $F(a+1, b; a; z) = (1 - (1 - (b/a))z)(1-z)^{-1-b}.$

For an extensive list of elementary representations see Prudnikov *et al.* (1990, pp. 468–488).

15.4(ii) Argument Unity

If  $\Re(c-a-b) > 0$ , then

15.4.20  $F(a, b; c; 1) = \frac{\Gamma(c)\Gamma(c-a-b)}{\Gamma(c-a)\Gamma(c-b)}.$

If  $c = a + b$ , then

15.4.21  $\lim_{z \rightarrow 1^-} \frac{F(a, b; a+b; z)}{-\ln(1-z)} = \frac{\Gamma(a+b)}{\Gamma(a)\Gamma(b)}.$

If  $\Re(c-a-b) = 0$  and  $c \neq a + b$ , then

15.4.22  $\lim_{z \rightarrow 1^-} (1-z)^{a+b-c} \left( F(a, b; c; z) - \frac{\Gamma(c)\Gamma(c-a-b)}{\Gamma(c-a)\Gamma(c-b)} \right) = \frac{\Gamma(c)\Gamma(a+b-c)}{\Gamma(a)\Gamma(b)}.$

If  $\Re(c-a-b) < 0$ , then

15.4.23  $\lim_{z \rightarrow 1^-} \frac{F(a, b; c; z)}{(1-z)^{c-a-b}} = \frac{\Gamma(c)\Gamma(a+b-c)}{\Gamma(a)\Gamma(b)}.$

Chu–Vandermonde Identity

15.4.24  $F(-n, b; c; 1) = \frac{(c-b)_n}{(c)_n}, \quad n = 0, 1, 2, \dots$

Dougall’s Bilateral Sum

This is a generalization of (15.4.20). If  $a, b$  are not integers and  $\Re(c+d-a-b) > 1$ , then

15.4.25 
$$\sum_{n=-\infty}^{\infty} \frac{\Gamma(a+n)\Gamma(b+n)}{\Gamma(c+n)\Gamma(d+n)} = \frac{\pi^2}{\sin(\pi a)\sin(\pi b)} \frac{\Gamma(c+d-a-b-1)}{\Gamma(c-a)\Gamma(d-a)\Gamma(c-b)\Gamma(d-b)}.$$

15.4(iii) Other Arguments

15.4.26  $F(a, b; a-b+1; -1) = \frac{\Gamma(a-b+1)\Gamma(\frac{1}{2}a+1)}{\Gamma(a+1)\Gamma(\frac{1}{2}a-b+1)}.$

15.4.27  $F(1, a; a+1; -1) = \frac{1}{2}a(\psi(\frac{1}{2}a+\frac{1}{2}) - \psi(\frac{1}{2}a)).$

15.4.28

$$F\left(a, b; \frac{1}{2}a + \frac{1}{2}b + \frac{1}{2}; \frac{1}{2}\right) = \sqrt{\pi} \frac{\Gamma(\frac{1}{2}a + \frac{1}{2}b + \frac{1}{2})}{\Gamma(\frac{1}{2}a + \frac{1}{2})\Gamma(\frac{1}{2}b + \frac{1}{2})}.$$

15.4.29

$$F\left(a, b; \frac{1}{2}a + \frac{1}{2}b + 1; \frac{1}{2}\right) = \frac{2\sqrt{\pi}}{a-b} \Gamma\left(\frac{1}{2}a + \frac{1}{2}b + 1\right) \times \left( \frac{1}{\Gamma(\frac{1}{2}a)\Gamma(\frac{1}{2}b + \frac{1}{2})} - \frac{1}{\Gamma(\frac{1}{2}a + \frac{1}{2})\Gamma(\frac{1}{2}b)} \right).$$

15.4.30  $F\left(a, 1-a; b; \frac{1}{2}\right) = \frac{2^{1-b}\sqrt{\pi}\Gamma(b)}{\Gamma(\frac{1}{2}a + \frac{1}{2}b)\Gamma(\frac{1}{2}b - \frac{1}{2}a + \frac{1}{2})}.$

15.4.31

$$F\left(a, \frac{1}{2}+a; \frac{3}{2}-2a; -\frac{1}{3}\right) = \left(\frac{8}{9}\right)^{-2a} \frac{\Gamma(\frac{4}{3})\Gamma(\frac{3}{2}-2a)}{\Gamma(\frac{3}{2})\Gamma(\frac{4}{3}-2a)}.$$

$$F\left(a, \frac{1}{2}+a; \frac{5}{6} + \frac{2}{3}a; \frac{1}{9}\right)$$

15.4.32  $= \sqrt{\pi} \left(\frac{3}{4}\right)^a \frac{\Gamma(\frac{5}{6} + \frac{2}{3}a)}{\Gamma(\frac{1}{2} + \frac{1}{3}a)\Gamma(\frac{5}{6} + \frac{1}{3}a)}.$

$$F\left(3a, \frac{1}{3}+a; \frac{2}{3}+2a; e^{i\pi/3}\right)$$

15.4.33  $= \sqrt{\pi} e^{i\pi a/2} \left(\frac{16}{27}\right)^{(3a+1)/6} \frac{\Gamma(\frac{5}{6}+a)}{\Gamma(\frac{2}{3}+a)\Gamma(\frac{2}{3})}.$

15.5 Derivatives and Contiguous Functions

15.5(i) Differentiation Formulas

15.5.1  $\frac{d}{dz} F(a, b; c; z) = \frac{ab}{c} F(a+1, b+1; c+1; z),$

15.5.2

$$\frac{d^n}{dz^n} F(a, b; c; z) = \frac{(a)_n (b)_n}{(c)_n} F(a+n, b+n; c+n; z).$$

15.5.3  $\left(z \frac{d}{dz} z\right)^n (z^{a-1} F(a, b; c; z))$

$$= (a)_n z^{a+n-1} F(a+n, b; c; z).$$

15.5.4  $\frac{d^n}{dz^n} (z^{c-1} F(a, b; c; z))$

$$= (c-n)_n z^{c-n-1} F(a, b; c-n; z).$$

15.5.5

$$\left(z \frac{d}{dz} z\right)^n (z^{c-a-1} (1-z)^{a+b-c} F(a, b; c; z)) = (c-a)_n z^{c-a+n-1} (1-z)^{a-n+b-c} F(a-n, b; c; z).$$

**15.5.6**

$$\begin{aligned} & \frac{d^n}{dz^n} ((1-z)^{a+b-c} F(a, b; c; z)) \\ &= \frac{(c-a)_n (c-b)_n}{(c)_n} (1-z)^{a+b-c-n} F(a, b; c+n; z). \end{aligned}$$

**15.5.7**

$$\begin{aligned} & \left( (1-z) \frac{d}{dz} (1-z) \right)^n ((1-z)^{a-1} F(a, b; c; z)) \\ &= (-1)^n \frac{(a)_n (c-b)_n}{(c)_n} (1-z)^{a+n-1} \\ & \quad \times F(a+n, b; c+n; z). \end{aligned}$$

**15.5.8**

$$\begin{aligned} & \left( (1-z) \frac{d}{dz} (1-z) \right)^n (z^{c-1} (1-z)^{b-c} F(a, b; c; z)) \\ &= (c-n)_n z^{c-n-1} (1-z)^{b-c+n} F(a-n, b; c-n; z). \end{aligned}$$

**15.5.9**

$$\begin{aligned} & \frac{d^n}{dz^n} (z^{c-1} (1-z)^{a+b-c} F(a, b; c; z)) \\ &= (c-n)_n z^{c-n-1} (1-z)^{a+b-c-n} \\ & \quad \times F(a-n, b-n; c-n; z). \end{aligned}$$

Other versions of several of the identities in this subsection can be constructed with the aid of the operator identity

$$\left( z \frac{d}{dz} z \right)^n = z^n \frac{d^n}{dz^n} z^n, \quad n = 1, 2, 3, \dots$$

See Erdélyi *et al.* (1953a, pp. 102–103).

**15.5(ii) Contiguous Functions**

The six functions  $F(a \pm 1, b; c; z)$ ,  $F(a, b \pm 1; c; z)$ ,  $F(a, b; c \pm 1; z)$  are said to be *contiguous* to  $F(a, b; c; z)$ .

$$\begin{aligned} & (c-a) F(a-1, b; c; z) \\ & + (2a-c+(b-a)z) F(a, b; c; z) \\ & + a(z-1) F(a+1, b; c; z) = 0, \end{aligned}$$

$$\begin{aligned} & (b-a) F(a, b; c; z) + a F(a+1, b; c; z) \\ & - b F(a, b+1; c; z) = 0, \end{aligned}$$

$$\begin{aligned} & (c-a-b) F(a, b; c; z) \\ & + a(1-z) F(a+1, b; c; z) \\ & - (c-b) F(a, b-1; c; z) = 0, \end{aligned}$$

$$\begin{aligned} & c(a+(b-c)z) F(a, b; c; z) \\ & - ac(1-z) F(a+1, b; c; z) \\ & + (c-a)(c-b)z F(a, b; c+1; z) = 0, \end{aligned}$$

$$\begin{aligned} & (c-a-1) F(a, b; c; z) + a F(a+1, b; c; z) \\ & - (c-1) F(a, b; c-1; z) = 0, \end{aligned}$$

$$\begin{aligned} & c(1-z) F(a, b; c; z) - c F(a-1, b; c; z) \\ & + (c-b)z F(a, b; c+1; z) = 0, \end{aligned}$$

$$\begin{aligned} & (a-1+(b+1-c)z) F(a, b; c; z) \\ & + (c-a) F(a-1, b; c; z) \\ & - (c-1)(1-z) F(a, b; c-1; z) = 0, \end{aligned}$$

$$c(c-1)(z-1) F(a, b; c-1; z)$$

$$\begin{aligned} & + c(c-1-(2c-a-b-1)z) F(a, b; c; z) \\ & + (c-a)(c-b)z F(a, b; c+1; z) = 0. \end{aligned}$$

By repeated applications of (15.5.11)–(15.5.18) any function  $F(a+k, b+\ell; c+m; z)$ , in which  $k, \ell, m$  are integers, can be expressed as a linear combination of  $F(a, b; c; z)$  and any one of its contiguous functions, with coefficients that are rational functions of  $a, b, c$ , and  $z$ .

An equivalent equation to the hypergeometric differential equation (15.10.1) is

**15.5.19**

$$\begin{aligned} & z(1-z)(a+1)(b+1) F(a+2, b+2; c+2; z) \\ & + (c-(a+b+1)z)(c+1) F(a+1, b+1; c+1; z) \\ & - c(c+1) F(a, b; c; z) = 0. \end{aligned}$$

Further contiguous relations include:

**15.5.20**

$$\begin{aligned} & z(1-z) (dF(a, b; c; z)/dz) \\ & = (c-a) F(a-1, b; c; z) + (a-c+bz) F(a, b; c; z) \\ & = (c-b) F(a, b-1; c; z) + (b-c+az) F(a, b; c; z), \end{aligned}$$

**15.5.21**

$$\begin{aligned} & c(1-z) (dF(a, b; c; z)/dz) \\ & = (c-a)(c-b) F(a, b; c+1; z) + c(a+b-c) F(a, b; c; z). \end{aligned}$$

**15.6 Integral Representations**

The function  $\mathbf{F}(a, b; c; z)$  (not  $F(a, b; c; z)$ ) has the following integral representations:

**15.6.1**

$$\frac{1}{\Gamma(b)\Gamma(c-b)} \int_0^1 \frac{t^{b-1}(1-t)^{c-b-1}}{(1-zt)^a} dt, \quad \Re c > \Re b > 0.$$

**15.6.2**

$$\begin{aligned} & \frac{\Gamma(1+b-c)}{2\pi i \Gamma(b)} \int_0^{(1+)} \frac{t^{b-1}(t-1)^{c-b-1}}{(1-zt)^a} dt, \\ & c-b \neq 1, 2, 3, \dots, \Re b > 0. \end{aligned}$$

**15.6.3**

$$\begin{aligned} & e^{-b\pi i} \frac{\Gamma(1-b)}{2\pi i \Gamma(c-b)} \int_{\infty}^{(0+)} \frac{t^{b-1}(t+1)^{a-c}}{(t-zt+1)^a} dt, \\ & b \neq 1, 2, 3, \dots, \Re(c-b) > 0. \end{aligned}$$

**15.6.4**

$$\begin{aligned} & e^{-b\pi i} \frac{\Gamma(1-b)}{2\pi i \Gamma(c-b)} \int_1^{(0+)} \frac{t^{b-1}(1-t)^{c-b-1}}{(1-zt)^a} dt, \\ & b \neq 1, 2, 3, \dots, \Re(c-b) > 0. \end{aligned}$$

**15.6.5**

$$\begin{aligned} & e^{-c\pi i} \Gamma(1-b) \Gamma(1+b-c) \\ & \times \frac{1}{4\pi^2} \int_A^{(0+, 1+, 0-, 1-)} \frac{t^{b-1}(1-t)^{c-b-1}}{(1-zt)^a} dt, \\ & b, c-b \neq 1, 2, 3, \dots \end{aligned}$$

**15.6.6**

$$\begin{aligned} & \frac{1}{2\pi i \Gamma(a)\Gamma(b)} \int_{-i\infty}^{i\infty} \frac{\Gamma(a+t)\Gamma(b+t)\Gamma(-t)}{\Gamma(c+t)} (-z)^t dt, \\ & a, b \neq 0, -1, -2, \dots \end{aligned}$$

$$15.6.7 \quad \frac{1}{2\pi i \Gamma(a) \Gamma(b) \Gamma(c-a) \Gamma(c-b)} \int_{-i\infty}^{i\infty} \Gamma(a+t) \Gamma(b+t) \Gamma(c-a-b-t) \Gamma(-t) (1-z)^t dt, \quad a, b, c-a, c-b \neq 0, -1, -2, \dots$$

$$15.6.8 \quad \frac{1}{\Gamma(c-d)} \int_0^1 \mathbf{F}(a, b; d; zt) t^{d-1} (1-t)^{c-d-1} dt, \quad \Re c > \Re d > 0.$$

$$15.6.9 \quad \int_0^1 \frac{t^{d-1} (1-t)^{c-d-1}}{(1-zt)^{a+b-\lambda}} \mathbf{F}\left(\begin{matrix} \lambda-a, \lambda-b \\ d \end{matrix}; zt\right) \mathbf{F}\left(\begin{matrix} a+b-\lambda, \lambda-d \\ c-d \end{matrix}; \frac{(1-t)z}{1-zt}\right) dt, \quad \Re c > \Re d > 0.$$

These representations are valid when  $|\text{ph}(1-z)| < \pi$ , except (15.6.6) which holds for  $|\text{ph}(-z)| < \pi$ . In all cases the integrands are continuous functions of  $t$  on the integration paths, except possibly at the endpoints. In addition:

In (15.6.1) all functions in the integrand assume their principal values.

In (15.6.2) the point  $1/z$  lies outside the integration contour,  $t^{b-1}$  and  $(t-1)^{c-b-1}$  assume their principal values where the contour cuts the interval  $(1, \infty)$ , and  $(1-zt)^a = 1$  at  $t = 0$ .

In (15.6.3) the point  $1/(z-1)$  lies outside the integration contour, the contour cuts the real axis between  $t = -1$  and  $0$ , at which point  $\text{ph} t = \pi$  and  $\text{ph}(1+t) = 0$ .

In (15.6.4) the point  $1/z$  lies outside the integration contour, and at the point where the contour cuts the negative real axis  $\text{ph} t = \pi$  and  $\text{ph}(1-t) = 0$ .

In (15.6.5) the integration contour starts and terminates at a point  $A$  on the real axis between  $0$  and  $1$ . It encircles  $t = 0$  and  $t = 1$  once in the positive direction, and then once in the negative direction. See Figure 15.6.1. At the starting point  $\text{ph} t$  and  $\text{ph}(1-t)$  are zero. Compare Figure 5.12.3.

In (15.6.6) the integration contour separates the poles of  $\Gamma(a+t)$  and  $\Gamma(b+t)$  from those of  $\Gamma(-t)$ , and  $(-z)^t$  has its principal value.

In (15.6.7) the integration contour separates the poles of  $\Gamma(a+t)$  and  $\Gamma(b+t)$  from those of  $\Gamma(c-a-b-t)$  and  $\Gamma(-t)$ , and  $(1-z)^t$  has its principal value.

In each of (15.6.8) and (15.6.9) all functions in the integrand assume their principal values.

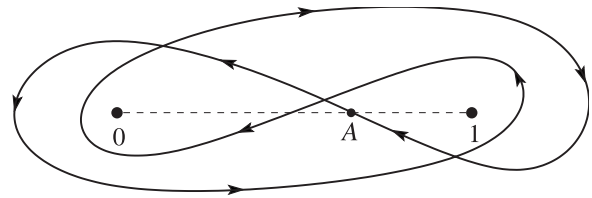


Figure 15.6.1:  $t$ -plane. Contour of integration in (15.6.5).

### 15.7 Continued Fractions

If  $|\text{ph}(1-z)| < \pi$ , then

$$15.7.1 \quad \frac{\mathbf{F}(a, b; c; z)}{\mathbf{F}(a, b+1; c+1; z)} = t_0 - \frac{u_1 z}{t_1 -} \frac{u_2 z}{t_2 -} \frac{u_3 z}{t_3 -} \dots,$$

where

$$15.7.2 \quad \begin{aligned} t_n &= c+n, & u_{2n+1} &= (a+n)(c-b+n), \\ u_{2n} &= (b+n)(c-a+n). \end{aligned}$$

If  $|z| < 1$ , then

$$15.7.3 \quad \frac{\mathbf{F}(a, b; c; z)}{\mathbf{F}(a, b+1; c+1; z)} = v_0 - \frac{w_1}{v_1 -} \frac{w_2}{v_2 -} \frac{w_3}{v_3 -} \dots,$$

where

$$15.7.4 \quad \begin{aligned} v_n &= c+n+(b-a+n+1)z, \\ w_n &= (b+n)(c-a+n)z. \end{aligned}$$

If  $\Re z < \frac{1}{2}$ , then

$$15.7.5 \quad \frac{\mathbf{F}(a, b; c; z)}{\mathbf{F}(a+1, b+1; c+1; z)} = x_0 + \frac{y_1}{x_1 +} \frac{y_2}{x_2 +} \frac{y_3}{x_3 +} \dots,$$

where

$$15.7.6 \quad \begin{aligned} x_n &= c+n-(a+b+2n+1)z, \\ y_n &= (a+n)(b+n)z(1-z). \end{aligned}$$

See also Cuyt *et al.* (2008, pp. 295–309).

## 15.8 Transformations of Variable

### 15.8(i) Linear Transformations

All functions in this subsection and §15.8(ii) assume their principal values.

$$15.8.1 \quad \mathbf{F}\left(\begin{matrix} a, b \\ c \end{matrix}; z\right) = (1-z)^{-a} \mathbf{F}\left(\begin{matrix} a, c-b \\ c \end{matrix}; \frac{z}{z-1}\right) = (1-z)^{-b} \mathbf{F}\left(\begin{matrix} c-a, b \\ c \end{matrix}; \frac{z}{z-1}\right) = (1-z)^{c-a-b} \mathbf{F}\left(\begin{matrix} c-a, c-b \\ c \end{matrix}; z\right), \\ | \text{ph}(1-z) | < \pi.$$

$$15.8.2 \quad \frac{\sin(\pi(b-a))}{\pi} \mathbf{F}\left(\begin{matrix} a, b \\ c \end{matrix}; z\right) = \frac{(-z)^{-a}}{\Gamma(b)\Gamma(c-a)} \mathbf{F}\left(\begin{matrix} a, a-c+1 \\ a-b+1 \end{matrix}; \frac{1}{z}\right) - \frac{(-z)^{-b}}{\Gamma(a)\Gamma(c-b)} \mathbf{F}\left(\begin{matrix} b, b-c+1 \\ b-a+1 \end{matrix}; \frac{1}{z}\right), \quad | \text{ph}(-z) | < \pi.$$

$$15.8.3 \quad \frac{\sin(\pi(b-a))}{\pi} \mathbf{F}\left(\begin{matrix} a, b \\ c \end{matrix}; z\right) = \frac{(1-z)^{-a}}{\Gamma(b)\Gamma(c-a)} \mathbf{F}\left(\begin{matrix} a, c-b \\ a-b+1 \end{matrix}; \frac{1}{1-z}\right) - \frac{(1-z)^{-b}}{\Gamma(a)\Gamma(c-b)} \mathbf{F}\left(\begin{matrix} b, c-a \\ b-a+1 \end{matrix}; \frac{1}{1-z}\right), \\ | \text{ph}(-z) | < \pi.$$

$$15.8.4 \quad \frac{\sin(\pi(c-a-b))}{\pi} \mathbf{F}\left(\begin{matrix} a, b \\ c \end{matrix}; z\right) = \frac{1}{\Gamma(c-a)\Gamma(c-b)} \mathbf{F}\left(\begin{matrix} a, b \\ a+b-c+1 \end{matrix}; 1-z\right) - \frac{(1-z)^{c-a-b}}{\Gamma(a)\Gamma(b)} \mathbf{F}\left(\begin{matrix} c-a, c-b \\ c-a-b+1 \end{matrix}; 1-z\right), \\ | \text{ph} z | < \pi, \quad | \text{ph}(1-z) | < \pi.$$

$$15.8.5 \quad \frac{\sin(\pi(c-a-b))}{\pi} \mathbf{F}\left(\begin{matrix} a, b \\ c \end{matrix}; z\right) = \frac{z^{-a}}{\Gamma(c-a)\Gamma(c-b)} \mathbf{F}\left(\begin{matrix} a, a-c+1 \\ a+b-c+1 \end{matrix}; 1-\frac{1}{z}\right) \\ - \frac{(1-z)^{c-a-b} z^{a-c}}{\Gamma(a)\Gamma(b)} \mathbf{F}\left(\begin{matrix} c-a, 1-a \\ c-a-b+1 \end{matrix}; 1-\frac{1}{z}\right), \quad | \text{ph} z | < \pi, \quad | \text{ph}(1-z) | < \pi.$$

### 15.8(ii) Linear Transformations: Limiting Cases

With  $m = 0, 1, 2, \dots$ , polynomial cases of (15.8.2)–(15.8.5) are given by

$$15.8.6 \quad F\left(\begin{matrix} -m, b \\ c \end{matrix}; z\right) = \frac{(b)_m}{(c)_m} (-z)^m F\left(\begin{matrix} -m, 1-c-m \\ 1-b-m \end{matrix}; \frac{1}{z}\right) = \frac{(b)_m}{(c)_m} (1-z)^m F\left(\begin{matrix} -m, c-b \\ 1-b-m \end{matrix}; \frac{1}{1-z}\right),$$

$$15.8.7 \quad F\left(\begin{matrix} -m, b \\ c \end{matrix}; z\right) = \frac{(c-b)_m}{(c)_m} F\left(\begin{matrix} -m, b \\ b-c-m+1 \end{matrix}; 1-z\right) = \frac{(c-b)_m}{(c)_m} z^m F\left(\begin{matrix} -m, 1-c-m \\ b-c-m+1 \end{matrix}; 1-\frac{1}{z}\right),$$

with the understanding that if  $b = -\ell$ ,  $\ell = 0, 1, 2, \dots$ , then  $m \leq \ell$ .

When  $b-a$  is an integer limits are taken in (15.8.2) and (15.8.3) as follows.

If  $b-a$  is a nonnegative integer, then

$$15.8.8 \quad \mathbf{F}\left(\begin{matrix} a, a+m \\ c \end{matrix}; z\right) = \frac{(-z)^{-a}}{\Gamma(a+m)} \sum_{k=0}^{m-1} \frac{(a)_k (m-k-1)!}{k! \Gamma(c-a-k)} z^{-k} + \frac{(-z)^{-a}}{\Gamma(a)} \sum_{k=0}^{\infty} \frac{(a+m)_k}{k!(k+m)! \Gamma(c-a-k-m)} (-1)^k z^{-k-m} \\ \times (\ln(-z) + \psi(k+1) + \psi(k+m+1) - \psi(a+k+m) - \psi(c-a-k-m)), \\ |z| > 1, \quad | \text{ph}(-z) | < \pi,$$

$$15.8.9 \quad \mathbf{F}\left(\begin{matrix} a, a+m \\ c \end{matrix}; z\right) = \frac{(1-z)^{-a}}{\Gamma(a+m)\Gamma(c-a)} \sum_{k=0}^{m-1} \frac{(a)_k (c-a-m)_k (m-k-1)!}{k!} (z-1)^{-k} \\ + \frac{(-1)^m (1-z)^{-a-m}}{\Gamma(a)\Gamma(c-a-m)} \sum_{k=0}^{\infty} \frac{(a+m)_k (c-a)_k}{k!(k+m)!} (1-z)^{-k} \\ \times (\ln(1-z) + \psi(k+1) + \psi(k+m+1) - \psi(a+k+m) - \psi(c-a+k)), \\ |z-1| > 1, \quad | \text{ph}(1-z) | < \pi.$$

In (15.8.8) when  $c-a-k-m$  is a nonpositive integer  $\psi(c-a-k-m)/\Gamma(c-a-k-m)$  is interpreted as  $(-1)^{m+k+a-c+1}(m+k+a-c)!$ . Also, if  $a$  is a nonpositive integer, then (15.8.6) applies.

Alternatively, if  $b - a$  is a negative integer, then we interchange  $a$  and  $b$  in  $\mathbf{F}(a, b; c; z)$ .

In a similar way, when  $c - a - b$  is an integer limits are taken in (15.8.4) and (15.8.5) as follows.

If  $c - a - b$  is a nonnegative integer, then

**15.8.10**

$$\mathbf{F}\left(\begin{matrix} a, b \\ a + b + m \end{matrix}; z\right) = \frac{1}{\Gamma(a+m)\Gamma(b+m)} \sum_{k=0}^{m-1} \frac{(a)_k(b)_k(m-k-1)!}{k!} (z-1)^k - \frac{(z-1)^m}{\Gamma(a)\Gamma(b)} \sum_{k=0}^{\infty} \frac{(a+m)_k(b+m)_k}{k!(k+m)!} (1-z)^k$$

$$\times (\ln(1-z) - \psi(k+1) - \psi(k+m+1) + \psi(a+k+m) + \psi(b+k+m)),$$

$$|z-1| < 1, |\text{ph}(1-z)| < \pi,$$

**15.8.11**

$$\mathbf{F}\left(\begin{matrix} a, b \\ a + b + m \end{matrix}; z\right) = \frac{z^{-a}}{\Gamma(a+m)} \sum_{k=0}^{m-1} \frac{(a)_k(m-k-1)!}{k!\Gamma(b+m-k)} \left(1 - \frac{1}{z}\right)^k - \frac{z^{-a}}{\Gamma(a)} \sum_{k=0}^{\infty} \frac{(a+m)_k}{k!(k+m)! \Gamma(b-k)} (-1)^k \left(1 - \frac{1}{z}\right)^{k+m}$$

$$\times \left(\ln\left(\frac{1-z}{z}\right) - \psi(k+1) - \psi(k+m+1) + \psi(a+k+m) + \psi(b-k)\right),$$

$$\Re z > \frac{1}{2}, |\text{ph } z| < \pi, |\text{ph}(1-z)| < \pi.$$

In (15.8.11) when  $b - k$  is a nonpositive integer,  $\psi(b - k)/\Gamma(b - k)$  is interpreted as  $(-1)^{k-b+1}(k - b)!$ . Also, if  $a$  or  $b$  or both are nonpositive integers, then (15.8.7) applies.

Lastly, if  $c - a - b$  is a negative integer, then we first apply the transformation

**15.8.12**

$$\mathbf{F}(a, b; a + b - m; z) = (1 - z)^{-m} \mathbf{F}(\tilde{a}, \tilde{b}; \tilde{a} + \tilde{b} + m; z),$$

$$\tilde{a} = a - m, \tilde{b} = b - m.$$

**15.8(iii) Quadratic Transformations**

A quadratic transformation relates two hypergeometric functions, with the variable in one a quadratic function of the variable in the other, possibly combined with a fractional linear transformation.

A necessary and sufficient condition that there exists a quadratic transformation is that at least one of the equations shown in Table 15.8.1 is satisfied.

Table 15.8.1: Quadratic transformations of the hypergeometric function.

Group 1	Group 2	Group 3	Group 4
	$c = a - b + 1$	$a = b + \frac{1}{2}$	
$c = 2a$	$c = b - a + 1$	$b = a + \frac{1}{2}$	$c = \frac{1}{2}$
$c = 2b$	$c = \frac{1}{2}(a + b + 1)$	$c = a + b + \frac{1}{2}$	$c = \frac{3}{2}$
	$a + b = 1$	$c = a + b - \frac{1}{2}$	

The hypergeometric functions that correspond to Groups 1 and 2 have  $z$  as variable. The hypergeometric functions that correspond to Groups 3 and 4 have a nonlinear function of  $z$  as variable. The transformation formulas between two hypergeometric functions in Group 2, or two hypergeometric functions in Group 3, are the linear transformations (15.8.1).

In the equations that follow in this subsection all functions take their principal values.

**Group 1 → Group 3**

**15.8.13** 
$$F\left(\begin{matrix} a, b \\ 2b \end{matrix}; z\right) = (1 - \frac{1}{2}z)^{-a} F\left(\begin{matrix} \frac{1}{2}a, \frac{1}{2}a + \frac{1}{2} \\ b + \frac{1}{2} \end{matrix}; \left(\frac{z}{2-z}\right)^2\right),$$
  $|\text{ph}(1-z)| < \pi,$

**15.8.14** 
$$F\left(\begin{matrix} a, b \\ 2b \end{matrix}; z\right) = (1 - z)^{-a/2} F\left(\begin{matrix} \frac{1}{2}a, b - \frac{1}{2}a \\ b + \frac{1}{2} \end{matrix}; \frac{z^2}{4z - 4}\right),$$
  $|\text{ph}(1-z)| < \pi.$

**Group 2 → Group 3**

**15.8.15** 
$$F\left(\begin{matrix} a, b \\ a - b + 1 \end{matrix}; z\right) = (1 + z)^{-a} F\left(\begin{matrix} \frac{1}{2}a, \frac{1}{2}a + \frac{1}{2} \\ a - b + 1 \end{matrix}; \frac{4z}{(1+z)^2}\right),$$
  $|z| < 1,$

**15.8.16** 
$$F\left(\begin{matrix} a, b \\ a - b + 1 \end{matrix}; z\right) = (1 - z)^{-a} F\left(\begin{matrix} \frac{1}{2}a, \frac{1}{2}a - b + \frac{1}{2} \\ a - b + 1 \end{matrix}; \frac{-4z}{(1-z)^2}\right),$$
  $|z| < 1.$



$$15.8.17 \quad F\left(\begin{matrix} a, b \\ \frac{1}{2}(a+b+1) \end{matrix}; z\right) = (1-2z)^{-a} F\left(\begin{matrix} \frac{1}{2}a, \frac{1}{2}a + \frac{1}{2} \\ \frac{1}{2}(a+b+1) \end{matrix}; \frac{4z(z-1)}{(1-2z)^2}\right), \quad \Re z < \frac{1}{2},$$

$$15.8.18 \quad F\left(\begin{matrix} a, b \\ \frac{1}{2}(a+b+1) \end{matrix}; z\right) = F\left(\begin{matrix} \frac{1}{2}a, \frac{1}{2}b \\ \frac{1}{2}(a+b+1) \end{matrix}; 4z(1-z)\right), \quad \Re z < \frac{1}{2}.$$

$$15.8.19 \quad F\left(\begin{matrix} a, 1-a \\ c \end{matrix}; z\right) = (1-2z)^{1-a-c} (1-z)^{c-1} F\left(\begin{matrix} \frac{1}{2}(a+c), \frac{1}{2}(a+c-1) \\ c \end{matrix}; \frac{4z(z-1)}{(1-2z)^2}\right), \quad \Re z < \frac{1}{2},$$

$$15.8.20 \quad F\left(\begin{matrix} a, 1-a \\ c \end{matrix}; z\right) = (1-z)^{c-1} F\left(\begin{matrix} \frac{1}{2}(c-a), \frac{1}{2}(a+c-1) \\ c \end{matrix}; 4z(1-z)\right), \quad \Re z < \frac{1}{2}.$$

**Group 2**  $\longrightarrow$  **Group 1**

$$15.8.21 \quad F\left(\begin{matrix} a, b \\ a-b+1 \end{matrix}; z\right) = (1+\sqrt{z})^{-2a} F\left(\begin{matrix} a, a-b+\frac{1}{2} \\ 2a-2b+1 \end{matrix}; \frac{4\sqrt{z}}{(1+\sqrt{z})^2}\right), \quad |\operatorname{ph} z| < \pi, |z| < 1.$$

$$15.8.22 \quad F\left(\begin{matrix} a, b \\ \frac{1}{2}(a+b+1) \end{matrix}; z\right) = \left(\frac{\sqrt{1-z^{-1}}-1}{\sqrt{1-z^{-1}}+1}\right)^a F\left(\begin{matrix} a, \frac{1}{2}(a+b) \\ a+b \end{matrix}; \frac{4\sqrt{1-z^{-1}}}{(\sqrt{1-z^{-1}}+1)^2}\right), \quad |\operatorname{ph}(-z)| < \pi, \Re z < \frac{1}{2}.$$

15.8.23

$$F\left(\begin{matrix} a, 1-a \\ c \end{matrix}; z\right) = (\sqrt{1-z^{-1}}-1)^{1-a} (\sqrt{1-z^{-1}}+1)^{a-2c+1} (1-z^{-1})^{c-1} F\left(\begin{matrix} c-a, c-\frac{1}{2} \\ 2c-1 \end{matrix}; \frac{4\sqrt{1-z^{-1}}}{(\sqrt{1-z^{-1}}+1)^2}\right), \quad |\operatorname{ph}(-z)| < \pi, \Re z < \frac{1}{2}.$$

**Group 2**  $\longrightarrow$  **Group 4**

$$15.8.24 \quad F\left(\begin{matrix} a, b \\ a-b+1 \end{matrix}; z\right) = (1-z)^{-a} \frac{\Gamma(a-b+1)\Gamma(\frac{1}{2})}{\Gamma(\frac{1}{2}a+\frac{1}{2})\Gamma(\frac{1}{2}a-b+1)} F\left(\begin{matrix} \frac{1}{2}a, \frac{1}{2}a-b+\frac{1}{2} \\ \frac{1}{2} \end{matrix}; \left(\frac{z+1}{z-1}\right)^2\right) \\ + (1+z)(1-z)^{-a-1} \frac{\Gamma(a-b+1)\Gamma(-\frac{1}{2})}{\Gamma(\frac{1}{2}a)\Gamma(\frac{1}{2}a-b+\frac{1}{2})} F\left(\begin{matrix} \frac{1}{2}a+\frac{1}{2}, \frac{1}{2}a-b+1 \\ \frac{3}{2} \end{matrix}; \left(\frac{z+1}{z-1}\right)^2\right), \quad |\operatorname{ph}(-z)| < \pi.$$

$$15.8.25 \quad F\left(\begin{matrix} a, b \\ \frac{1}{2}(a+b+1) \end{matrix}; z\right) = \frac{\Gamma(\frac{1}{2}(a+b+1))\Gamma(\frac{1}{2})}{\Gamma(\frac{1}{2}a+\frac{1}{2})\Gamma(\frac{1}{2}b+\frac{1}{2})} F\left(\begin{matrix} \frac{1}{2}a, \frac{1}{2}b \\ \frac{1}{2} \end{matrix}; (1-2z)^2\right) \\ + (1-2z) \frac{\Gamma(\frac{1}{2}(a+b+1))\Gamma(-\frac{1}{2})}{\Gamma(\frac{1}{2}a)\Gamma(\frac{1}{2}b)} F\left(\begin{matrix} \frac{1}{2}a+\frac{1}{2}, \frac{1}{2}b+\frac{1}{2} \\ \frac{3}{2} \end{matrix}; (1-2z)^2\right), \quad |\operatorname{ph} z| < \pi, |\operatorname{ph}(1-z)| < \pi.$$

$$15.8.26 \quad F\left(\begin{matrix} a, 1-a \\ c \end{matrix}; z\right) = (1-z)^{c-1} \frac{\Gamma(c)\Gamma(\frac{1}{2})}{\Gamma(\frac{1}{2}(c-a+1))\Gamma(\frac{1}{2}c+\frac{1}{2}a)} F\left(\begin{matrix} \frac{1}{2}c-\frac{1}{2}a, \frac{1}{2}c+\frac{1}{2}a-\frac{1}{2} \\ \frac{1}{2} \end{matrix}; (1-2z)^2\right) \\ + (1-2z)(1-z)^{c-1} \frac{\Gamma(c)\Gamma(-\frac{1}{2})}{\Gamma(\frac{1}{2}c-\frac{1}{2}a)\Gamma(\frac{1}{2}(c+a-1))} F\left(\begin{matrix} \frac{1}{2}c-\frac{1}{2}a+\frac{1}{2}, \frac{1}{2}c+\frac{1}{2}a \\ \frac{3}{2} \end{matrix}; (1-2z)^2\right), \quad |\operatorname{ph} z| < \pi, |\operatorname{ph}(1-z)| < \pi.$$

**Group 4**  $\longrightarrow$  **Group 2**

$$15.8.27 \quad \frac{2\Gamma(\frac{1}{2})\Gamma(a+b+\frac{1}{2})}{\Gamma(a+\frac{1}{2})\Gamma(b+\frac{1}{2})} F(a, b; \frac{1}{2}; z) = F(2a, 2b; a+b+\frac{1}{2}; \frac{1}{2}-\frac{1}{2}\sqrt{z}) + F(2a, 2b; a+b+\frac{1}{2}; \frac{1}{2}+\frac{1}{2}\sqrt{z}), \quad |\operatorname{ph} z| < \pi, |\operatorname{ph}(1-z)| < \pi.$$

**15.8.28**

$$\frac{2\sqrt{z}\Gamma(-\frac{1}{2})\Gamma(a+b-\frac{1}{2})}{\Gamma(a-\frac{1}{2})\Gamma(b-\frac{1}{2})} F(a, b; \frac{3}{2}; z) = F(2a-1, 2b-1; a+b-\frac{1}{2}; \frac{1}{2}-\frac{1}{2}\sqrt{z}) \\ - F(2a-1, 2b-1; a+b-\frac{1}{2}; \frac{1}{2}+\frac{1}{2}\sqrt{z}), \quad |\text{ph } z| < \pi, |\text{ph}(1-z)| < \pi.$$

**15.8(iv) Quadratic Transformations (Continued)**

When the intersection of two groups in Table 15.8.1 is not empty there exist special quadratic transformations, with only one free parameter, between two hypergeometric functions in the same group.

**Examples**

$b = \frac{1}{3}a + \frac{1}{3}$ ,  $c = 2b = a - b + 1$  in Groups 1 and 2.

(15.8.21) becomes

$$15.8.29 \quad F\left(a, \frac{1}{3}a + \frac{1}{3}; \frac{2}{3}a + \frac{2}{3}; z\right) = (1 + \sqrt{z})^{-2a} F\left(a, \frac{2}{3}a + \frac{1}{6}; \frac{4\sqrt{z}}{(1 + \sqrt{z})^2}\right).$$

This is a quadratic transformation between two cases in Group 1.

We can also use (15.8.13), followed by the inverse of (15.8.15), and obtain

$$15.8.30 \quad (1 - \frac{1}{2}z)^{-a} F\left(\frac{1}{2}a, \frac{1}{2}a + \frac{1}{2}; \frac{1}{3}a + \frac{5}{6}; \left(\frac{z}{2-z}\right)^2\right) = F\left(a, \frac{1}{3}a + \frac{1}{3}; \frac{2}{3}a + \frac{2}{3}; z\right) = (1+z)^{-a} F\left(\frac{1}{2}a, \frac{1}{2}a + \frac{1}{2}; \frac{4z}{(1+z)^2}\right),$$

which is a quadratic transformation between two cases in Group 3.

For further examples see Andrews *et al.* (1999, pp. 130–132 and 176–177).

**15.8(v) Cubic Transformations****Examples**

$$15.8.31 \quad F\left(3a, 3a + \frac{1}{2}; 4a + \frac{2}{3}; z\right) = (1 - \frac{9}{8}z)^{-2a} F\left(a, a + \frac{1}{2}; 2a + \frac{5}{6}; \frac{27z^2(z-1)}{(9z-8)^2}\right), \quad \Re z < \frac{8}{9}.$$

With  $\zeta = e^{2\pi i/3}(1-z)/(z - e^{4\pi i/3})$

$$15.8.32 \quad \frac{(1-z^3)^a}{(-z)^{3a}} \left( \frac{1}{\Gamma(a+\frac{2}{3})\Gamma(\frac{2}{3})} F\left(a, a + \frac{1}{3}; \frac{2}{3}; z^{-3}\right) + \frac{e^{\frac{1}{3}\pi i}}{z\Gamma(a)\Gamma(\frac{4}{3})} F\left(a + \frac{1}{3}, a + \frac{2}{3}; \frac{4}{3}; z^{-3}\right) \right) \\ = \frac{3^{\frac{3}{2}a + \frac{1}{2}} e^{\frac{1}{2}a\pi i} \Gamma(a + \frac{1}{3})(1-\zeta)^a}{2\pi\Gamma(2a + \frac{2}{3})(-\zeta)^{2a}} F\left(a + \frac{1}{3}, 3a; 2a + \frac{2}{3}; \zeta^{-1}\right), \quad |z| > 1, |\text{ph}(-z)| < \frac{1}{3}\pi.$$

**Ramanujan's Cubic Transformation****15.8.33**

$$F\left(\frac{1}{3}, \frac{2}{3}; 1 - \left(\frac{1-z}{1+2z}\right)^3\right) = (1+2z) F\left(\frac{1}{3}, \frac{2}{3}; z^3\right),$$

provided that  $z$  lies in the intersection of the open disks  $|z - \frac{1}{4} \pm \frac{1}{4}\sqrt{3}i| < \frac{1}{2}\sqrt{3}$ , or equivalently,  $|\text{ph}((1-z)/(1+2z))| < \pi/3$ . This is used in a cubic analog of the arithmetic-geometric mean. See Borwein and Borwein (1991), and also Berndt *et al.* (1995).

For further examples and higher-order transformations see Goursat (1881), Watson (1910), and Vidūnas (2005); see also Erdélyi *et al.* (1953a, pp. 67 and 113–114).

**15.9 Relations to Other Functions****15.9(i) Orthogonal Polynomials**

For the notation see §§18.3 and 18.19.

**Jacobi****15.9.1**

$$P_n^{(\alpha, \beta)}(x) = \frac{(\alpha+1)_n}{n!} F\left(\begin{matrix} -n, n + \alpha + \beta + 1 \\ \alpha + 1 \end{matrix}; \frac{1-x}{2}\right).$$

**Gegenbauer (or Ultraspherical)**

$$15.9.2 \quad C_n^{(\lambda)}(x) = \frac{(2\lambda)_n}{n!} F\left(\begin{matrix} -n, n + 2\lambda \\ \lambda + \frac{1}{2} \end{matrix}; \frac{1-x}{2}\right).$$

$$15.9.3 \quad C_n^{(\lambda)}(x) = (2x)^n \frac{(\lambda)_n}{n!} F\left(\begin{matrix} -\frac{1}{2}n, \frac{1}{2}(1-n) \\ 1 - \lambda - n \end{matrix}; \frac{1}{x^2}\right).$$

$$15.9.4 \quad C_n^{(\lambda)}(\cos \theta) = e^{ni\theta} \frac{(\lambda)_n}{n!} F\left(\begin{matrix} -n, \lambda \\ 1 - \lambda - n \end{matrix}; e^{-2i\theta}\right).$$

**Chebyshev**

$$15.9.5 \quad T_n(x) = F\left(\begin{matrix} -n, n \\ \frac{1}{2} \end{matrix}; \frac{1-x}{2}\right).$$

$$15.9.6 \quad U_n(x) = (n+1) F\left(\begin{matrix} -n, n+2 \\ \frac{3}{2} \end{matrix}; \frac{1-x}{2}\right).$$

**Legendre**

$$15.9.7 \quad P_n(x) = F\left(\begin{matrix} -n, n+1 \\ 1 \end{matrix}; \frac{1-x}{2}\right).$$

**15.9(ii) Jacobi Function**

This is a generalization of Jacobi polynomials (§18.3) and has the representation

$$15.9.11 \quad \phi_\lambda^{(\alpha, \beta)}(t) = F\left(\begin{matrix} \frac{1}{2}(\alpha + \beta + 1 - i\lambda), \frac{1}{2}(\alpha + \beta + 1 + i\lambda) \\ \alpha + 1 \end{matrix}; -\sinh^2 t\right).$$

The *Jacobi transform* is defined as

$$15.9.12 \quad \tilde{f}(\lambda) = \int_0^\infty f(t) \phi_\lambda^{(\alpha, \beta)}(t) (2 \sinh t)^{2\alpha+1} (2 \cosh t)^{2\beta+1} dt,$$

with inverse

$$15.9.13 \quad f(t) = \frac{1}{2\pi i} \int_{-i\infty}^{i\infty} \tilde{f}(i\lambda) \Phi_{i\lambda}^{(\alpha, \beta)}(t) \frac{\Gamma(\frac{1}{2}(\alpha + \beta + 1 + \lambda)) \Gamma(\frac{1}{2}(\alpha - \beta + 1 + \lambda))}{\Gamma(\alpha + 1) \Gamma(\lambda) 2^{\alpha+\beta+1-\lambda}} d\lambda,$$

where the contour of integration is located to the right of the poles of the gamma functions in the integrand, and

$$15.9.14 \quad \Phi_\lambda^{(\alpha, \beta)}(t) = (2 \cosh t)^{i\lambda - \alpha - \beta - 1} F\left(\begin{matrix} \frac{1}{2}(\alpha + \beta + 1 - i\lambda), \frac{1}{2}(\alpha - \beta + 1 - i\lambda) \\ 1 - i\lambda \end{matrix}; \operatorname{sech}^2 t\right).$$

For this result, together with restrictions on the functions  $f(t)$  and  $\tilde{f}(\lambda)$ , see Koornwinder (1984a).

**15.9(iii) Gegenbauer Function**

This is a generalization of Gegenbauer (or ultraspherical) polynomials (§18.3). It is defined by:

$$15.9.15 \quad C_\alpha^{(\lambda)}(z) = \frac{\Gamma(\alpha + 2\lambda)}{\Gamma(2\lambda) \Gamma(\alpha + 1)} F\left(\begin{matrix} -\alpha, \alpha + 2\lambda \\ \lambda + \frac{1}{2} \end{matrix}; \frac{1-z}{2}\right).$$

**15.9(iv) Associated Legendre Functions; Ferrers Functions**

Any hypergeometric function for which a quadratic transformation exists can be expressed in terms of associated Legendre functions or Ferrers functions. For examples see §§14.3(i)–14.3(iii) and 14.21(iii).

For further examples see <http://dlmf.nist.gov/15.9.iv>.

**Krawtchouk****15.9.8**

$$K_n(x; p, N) = F\left(\begin{matrix} -n, -x \\ -N \end{matrix}; \frac{1}{p}\right), \quad n = 0, 1, 2, \dots, N;$$

compare also §15.2(ii).

**Meixner**

$$15.9.9 \quad M_n(x; \beta, c) = F\left(\begin{matrix} -n, -x \\ \beta \end{matrix}; 1 - \frac{1}{c}\right).$$

**Meixner–Pollaczek****15.9.10**

$$P_n^{(\lambda)}(x; \phi) = \frac{(2\lambda)_n}{n!} e^{ni\phi} F\left(\begin{matrix} -n, \lambda + ix \\ 2\lambda \end{matrix}; 1 - e^{-2i\phi}\right).$$

**15.10 Hypergeometric Differential Equation****15.10(i) Fundamental Solutions**

$$15.10.1 \quad z(1-z) \frac{d^2 w}{dz^2} + (c - (a+b+1)z) \frac{dw}{dz} - abw = 0.$$

This is the *hypergeometric differential equation*. It has regular singularities at  $z = 0, 1, \infty$ , with corresponding exponent pairs  $\{0, 1-c\}$ ,  $\{0, c-a-b\}$ ,  $\{a, b\}$ , respectively. When none of the exponent pairs differ by an integer, that is, when none of  $c$ ,  $c-a-b$ ,  $a-b$  is an integer, we have the following pairs  $f_1(z)$ ,  $f_2(z)$  of fundamental solutions. They are also numerically satisfactory (§2.7(iv)) in the neighborhood of the corresponding singularity.

**Singularity  $z = 0$**

15.10.2 
$$f_1(z) = F\left(\begin{matrix} a, b \\ c \end{matrix}; z\right),$$

$$f_2(z) = z^{1-c} F\left(\begin{matrix} a-c+1, b-c+1 \\ 2-c \end{matrix}; z\right),$$

15.10.3  $\mathscr{W}\{f_1(z), f_2(z)\} = (1-c)z^{-c}(1-z)^{c-a-b-1}.$

**Singularity  $z = 1$**

15.10.4 
$$f_1(z) = F\left(\begin{matrix} a, b \\ a+b+1-c \end{matrix}; 1-z\right),$$

$$f_2(z) = (1-z)^{c-a-b} F\left(\begin{matrix} c-a, c-b \\ c-a-b+1 \end{matrix}; 1-z\right),$$

15.10.5  $\mathscr{W}\{f_1(z), f_2(z)\} = (a+b-c)z^{-c}(1-z)^{c-a-b-1}.$

**Singularity  $z = \infty$**

15.10.6 
$$f_1(z) = z^{-a} F\left(\begin{matrix} a, a-c+1 \\ a-b+1 \end{matrix}; \frac{1}{z}\right),$$

$$f_2(z) = z^{-b} F\left(\begin{matrix} b, b-c+1 \\ b-a+1 \end{matrix}; \frac{1}{z}\right),$$

15.10.7  $\mathscr{W}\{f_1(z), f_2(z)\} = (a-b)z^{-c}(z-1)^{c-a-b-1}.$

(a) If  $c$  equals  $n = 1, 2, 3, \dots$ , and  $a = 1, 2, \dots, n-1$ , then fundamental solutions in the neighborhood of  $z = 0$  are given by (15.10.2) with the interpretation (15.2.5) for  $f_2(z)$ .

(b) If  $c$  equals  $n = 1, 2, 3, \dots$ , and  $a \neq 1, 2, \dots, n-1$ , then fundamental solutions in the neighborhood of  $z = 0$  are given by  $F(a, b; n; z)$  and

15.10.8 
$$F\left(\begin{matrix} a, b \\ n \end{matrix}; z\right) \ln z - \sum_{k=1}^{n-1} \frac{(n-1)!(k-1)!}{(n-k-1)!(1-a)_k(1-b)_k} (-z)^{-k}$$

$$+ \sum_{k=0}^{\infty} \frac{(a)_k(b)_k}{(n)_k k!} z^k (\psi(a+k) + \psi(b+k) - \psi(1+k) - \psi(n+k)), \quad a, b \neq n-1, n-2, \dots, 0, -1, -2, \dots,$$

or

15.10.9 
$$F\left(\begin{matrix} -m, b \\ n \end{matrix}; z\right) \ln z - \sum_{k=1}^{n-1} \frac{(n-1)!(k-1)!}{(n-k-1)!(m+1)_k(1-b)_k} (-z)^{-k}$$

$$+ \sum_{k=0}^m \frac{(-m)_k(b)_k}{(n)_k k!} z^k (\psi(1+m-k) + \psi(b+k) - \psi(1+k) - \psi(n+k))$$

$$+ (-1)^m m! \sum_{k=m+1}^{\infty} \frac{(k-1-m)!(b)_k}{(n)_k k!} z^k, \quad a = -m, m = 0, 1, 2, \dots; b \neq n-1, n-2, \dots, 0, -1, -2, \dots,$$

or

15.10.10 
$$F\left(\begin{matrix} -m, -\ell \\ n \end{matrix}; z\right) \ln z - \sum_{k=1}^{n-1} \frac{(n-1)!(k-1)!}{(n-k-1)!(m+1)_k(\ell+1)_k} (-z)^{-k}$$

$$+ \sum_{k=0}^{\ell} \frac{(-m)_k(-\ell)_k}{(n)_k k!} z^k (\psi(1+m-k) + \psi(1+\ell-k) - \psi(1+k) - \psi(n+k))$$

$$+ (-1)^{\ell} \ell! \sum_{k=\ell+1}^m \frac{(k-1-\ell)!(-m)_k}{(n)_k k!} z^k, \quad a = -m, m = 0, 1, 2, \dots; b = -\ell, \ell = 0, 1, 2, \dots, m.$$

Moreover, in (15.10.9) and (15.10.10) the symbols  $a$  and  $b$  are interchangeable.

(c) If  $c$  equals  $2-n = 0, -1, -2, \dots$ , then fundamental solutions in the neighborhood of  $z = 0$  are given by  $z^{n-1}$  times those in (a) and (b) with  $a$  and  $b$  replaced by  $a+n-1$  and  $b+n-1$ , respectively.

(d) If  $a+b+1-c$  equals  $n = 1, 2, 3, \dots$ , or  $2-n = 0, -1, -2, \dots$ , then fundamental solutions in the neighborhood of  $z = 1$  are given by those in (a), (b), and (c) with  $z$  replaced by  $1-z$ .

(e) Finally, if  $a-b+1$  equals  $n = 1, 2, 3, \dots$ , or  $2-n = 0, -1, -2, \dots$ , then fundamental solutions in the

neighborhood of  $z = \infty$  are given by  $z^{-a}$  times those in (a), (b), and (c) with  $b$  and  $z$  replaced by  $a-c+1$  and  $1/z$ , respectively.

**15.10(ii) Kummer's 24 Solutions and Connection Formulas**

The three pairs of fundamental solutions given by (15.10.2), (15.10.4), and (15.10.6) can be transformed into 18 other solutions by means of (15.8.1), leading to a total of 24 solutions known as *Kummer's solutions*. See <http://dlmf.nist.gov/15.10.ii> for Kummer's solutions and their connection formulas.

### 15.11 Riemann's Differential Equation

#### 15.11(i) Equations with Three Singularities

The importance of (15.10.1) is that any homogeneous linear differential equation of the second order with at most three distinct singularities, all regular, in the extended plane can be transformed into (15.10.1). The most general form is given by

$$15.11.1 \quad \frac{d^2w}{dz^2} + \left( \frac{1 - a_1 - a_2}{z - \alpha} + \frac{1 - b_1 - b_2}{z - \beta} + \frac{1 - c_1 - c_2}{z - \gamma} \right) \frac{dw}{dz} + \left( \frac{(\alpha - \beta)(\alpha - \gamma)a_1a_2}{z - \alpha} + \frac{(\beta - \alpha)(\beta - \gamma)b_1b_2}{z - \beta} + \frac{(\gamma - \alpha)(\gamma - \beta)c_1c_2}{z - \gamma} \right) \frac{w}{(z - \alpha)(z - \beta)(z - \gamma)} = 0,$$

with

$$15.11.2 \quad a_1 + a_2 + b_1 + b_2 + c_1 + c_2 = 1.$$

Here  $\{a_1, a_2\}$ ,  $\{b_1, b_2\}$ ,  $\{c_1, c_2\}$  are the exponent pairs at the points  $\alpha, \beta, \gamma$ , respectively. Cases in which there are fewer than three singularities are included automatically by allowing the choice  $\{0, 1\}$  for exponent pairs. Also, if any of  $\alpha, \beta, \gamma$ , is at infinity, then we take the corresponding limit in (15.11.1).

The complete set of solutions of (15.11.1) is denoted by *Riemann's P-symbol*:

$$15.11.3 \quad w = P \left\{ \begin{matrix} \alpha & \beta & \gamma \\ a_1 & b_1 & c_1 \\ a_2 & b_2 & c_2 \end{matrix} \middle| z \right\}.$$

In particular,

$$15.11.4 \quad w = P \left\{ \begin{matrix} 0 & 1 & \infty \\ 0 & 0 & a \\ 1 - c & c - a - b & b \end{matrix} \middle| z \right\}$$

denotes the set of solutions of (15.10.1).

#### 15.11(ii) Transformation Formulas

A conformal mapping of the extended complex plane onto itself has the form

$$15.11.5 \quad t = (\kappa z + \lambda) / (\mu z + \nu),$$

where  $\kappa, \lambda, \mu, \nu$  are real or complex constants such that  $\kappa\nu - \lambda\mu = 1$ . These constants can be chosen to map any two sets of three distinct points  $\{\alpha, \beta, \gamma\}$  and  $\{\tilde{\alpha}, \tilde{\beta}, \tilde{\gamma}\}$  onto each other. Symbolically:

$$15.11.6 \quad P \left\{ \begin{matrix} \alpha & \beta & \gamma \\ a_1 & b_1 & c_1 \\ a_2 & b_2 & c_2 \end{matrix} \middle| z \right\} = P \left\{ \begin{matrix} \tilde{\alpha} & \tilde{\beta} & \tilde{\gamma} \\ a_1 & b_1 & c_1 \\ a_2 & b_2 & c_2 \end{matrix} \middle| t \right\}.$$

The reduction of a general homogeneous linear differential equation of the second order with at most three regular singularities to the hypergeometric differential equation is given by

$$15.11.7 \quad P \left\{ \begin{matrix} \alpha & \beta & \gamma \\ a_1 & b_1 & c_1 \\ a_2 & b_2 & c_2 \end{matrix} \middle| z \right\} = \left( \frac{z - \alpha}{z - \gamma} \right)^{a_1} \left( \frac{z - \beta}{z - \gamma} \right)^{b_1} P \left\{ \begin{matrix} 0 & 1 & \infty \\ 0 & 0 & a_1 + b_1 + c_1 \\ a_2 - a_1 & b_2 - b_1 & a_1 + b_1 + c_2 \end{matrix} \middle| \frac{(z - \alpha)(\beta - \gamma)}{(z - \gamma)(\beta - \alpha)} \right\}.$$

We also have

$$15.11.8 \quad z^\lambda (1 - z)^\mu P \left\{ \begin{matrix} 0 & 1 & \infty \\ a_1 & b_1 & c_1 \\ a_2 & b_2 & c_2 \end{matrix} \middle| z \right\} = P \left\{ \begin{matrix} 0 & 1 & \infty \\ a_1 + \lambda & b_1 + \mu & c_1 - \lambda - \mu \\ a_2 + \lambda & b_2 + \mu & c_2 - \lambda - \mu \end{matrix} \middle| z \right\},$$

for arbitrary  $\lambda$  and  $\mu$ .

### 15.12 Asymptotic Approximations

#### 15.12(i) Large Variable

For the asymptotic behavior of  $\mathbf{F}(a, b; c; z)$  as  $z \rightarrow \infty$  with  $a, b, c$  fixed, combine (15.2.2) with (15.8.2) or (15.8.8).

#### 15.12(ii) Large $c$

Let  $\delta$  denote an arbitrary small positive constant. Also let  $a, b, z$  be real or complex and fixed, and at least one of the following conditions be satisfied:

- (a)  $a$  and/or  $b \in \{0, -1, -2, \dots\}$ .
- (b)  $\Re z < \frac{1}{2}$  and  $|c + n| \geq \delta$  for all  $n \in \{0, 1, 2, \dots\}$ .

- (c)  $\Re z = \frac{1}{2}$  and  $|\text{ph } c| \leq \pi - \delta$ .
- (d)  $\Re z > \frac{1}{2}$  and  $\alpha_- - \frac{1}{2}\pi + \delta \leq \text{ph } c \leq \alpha_+ + \frac{1}{2}\pi - \delta$ , where

**15.12.1** 
$$\alpha_{\pm} = \arctan\left(\frac{\text{ph } z - \text{ph}(1-z) \mp \pi}{\ln|1-z^{-1}|}\right),$$

with  $z$  restricted so that  $\pm\alpha_{\pm} \in [0, \frac{1}{2}\pi)$ .

Then for fixed  $m \in \{0, 1, 2, \dots\}$ ,

**15.12.2**

$$F(a, b; c; z) = \sum_{s=0}^{m-1} \frac{(a)_s (b)_s}{(c)_s s!} z^s + O(c^{-m}), \quad |c| \rightarrow \infty.$$

Similar results for other sectors are given in Wagner (1988). For the more general case in which  $a^2 = o(c)$  and  $b^2 = o(c)$  see Wagner (1990).

**15.12(iii) Other Large Parameters**

Again, throughout this subsection  $\delta$  denotes an arbitrary small positive constant, and  $a, b, c, z$  are real or

complex and fixed.

As  $\lambda \rightarrow \infty$ ,

**15.12.3**

$$F\left(\begin{matrix} a, b \\ c + \lambda \end{matrix}; z\right) \sim \frac{\Gamma(c + \lambda)}{\Gamma(c - b + \lambda)} \sum_{s=0}^{\infty} q_s(z) (b)_s \lambda^{-s-b},$$

where  $q_0(z) = 1$  and  $q_s(z)$ ,  $s = 1, 2, \dots$ , are defined by the generating function

**15.12.4**

$$\left(\frac{e^t - 1}{t}\right)^{b-1} e^{t(1-c)} (1 - z + ze^{-t})^{-a} = \sum_{s=0}^{\infty} q_s(z) t^s.$$

If  $|\text{ph}(1-z)| < \pi$ , then (15.12.3) applies when  $|\text{ph } \lambda| \leq \frac{1}{2}\pi - \delta$ . If  $\Re z \leq \frac{1}{2}$ , then (15.12.3) applies when  $|\text{ph } \lambda| \leq \pi - \delta$ .

If  $|\text{ph}(z-1)| < \pi$ , then as  $\lambda \rightarrow \infty$  with  $|\text{ph } \lambda| \leq \pi - \delta$ ,

**15.12.5**

$$\begin{aligned} & \mathbf{F}\left(\begin{matrix} a + \lambda, b - \lambda \\ c \end{matrix}; \frac{1}{2} - \frac{1}{2}z\right) \\ &= 2^{(a+b-1)/2} \frac{(z+1)^{(c-a-b-1)/2}}{(z-1)^{c/2}} \sqrt{\zeta \sinh \zeta} (\lambda + \frac{1}{2}a - \frac{1}{2}b)^{1-c} \left( I_{c-1}((\lambda + \frac{1}{2}a - \frac{1}{2}b)\zeta) (1 + O(\lambda^{-2})) \right. \\ & \quad \left. + \frac{I_{c-2}((\lambda + \frac{1}{2}a - \frac{1}{2}b)\zeta)}{2\lambda + a - b} \left( (c - \frac{1}{2})(c - \frac{3}{2}) \left( \frac{1}{\zeta} - \coth \zeta \right) + \frac{1}{2}(2c - a - b - 1)(a + b - 1) \tanh(\frac{1}{2}\zeta) + O(\lambda^{-2}) \right) \right), \end{aligned}$$

where

**15.12.6**

$$\zeta = \text{arccosh } z.$$

For  $I_{\nu}(z)$  see §10.25(ii). For this result and an extension to an asymptotic expansion with error bounds see Jones (2001).

See also Dunster (1999) where the asymptotics of Jacobi polynomials is described; compare (15.9.1).

If  $|\text{ph } z| < \pi$ , then as  $\lambda \rightarrow \infty$  with  $|\text{ph } \lambda| \leq \pi - \delta$ ,

$$\begin{aligned} & F\left(\begin{matrix} a, b - \lambda \\ c + \lambda \end{matrix}; -z\right) \\ \mathbf{15.12.7} \quad &= 2^{b-c+(1/2)} \left(\frac{z+1}{2\sqrt{z}}\right)^{\lambda} \left( \lambda^{a/2} U\left(a - \frac{1}{2}, -\alpha\sqrt{\lambda}\right) \left( (1+z)^{c-a-b} z^{1-c} \left(\frac{\alpha}{z-1}\right)^{1-a} + O(\lambda^{-1}) \right) \right. \\ & \quad \left. + \frac{\lambda^{(a-1)/2}}{\alpha} U\left(a - \frac{3}{2}, -\alpha\sqrt{\lambda}\right) \left( (1+z)^{c-a-b} z^{1-c} \left(\frac{\alpha}{z-1}\right)^{1-a} - 2^{c-b-(1/2)} \left(\frac{\alpha}{z-1}\right)^a + O(\lambda^{-1}) \right) \right), \end{aligned}$$

where

**15.12.8**

$$\alpha = \left( -2 \ln \left( 1 - \left( \frac{z-1}{z+1} \right)^2 \right) \right)^{1/2},$$

with the branch chosen to be continuous and  $\Re \alpha > 0$  when  $\Re((z-1)/(z+1)) > 0$ . For  $U(a, z)$  see §12.2, and for an extension to an asymptotic expansion see Olde Daalhuis (2003a).

If  $|\text{ph } z| < \pi$ , then as  $\lambda \rightarrow \infty$  with  $|\text{ph } \lambda| \leq \frac{1}{2}\pi - \delta$ ,

**15.12.9**

$$(z + 1)^{3\lambda/2} (2\lambda)^{c-1} \mathbf{F}\left(\begin{matrix} a + \lambda, b + 2\lambda \\ c \end{matrix}; -z\right) \\ = \lambda^{-1/3} \left( e^{\pi i(a-c+\lambda+(1/3))} \text{Ai}\left(e^{-2\pi i/3} \lambda^{2/3} \beta^2\right) + e^{\pi i(c-a-\lambda-(1/3))} \text{Ai}\left(e^{2\pi i/3} \lambda^{2/3} \beta^2\right) \right) (a_0(\zeta) + O(\lambda^{-1})) \\ + \lambda^{-2/3} \left( e^{\pi i(a-c+\lambda+(2/3))} \text{Ai}'\left(e^{-2\pi i/3} \lambda^{2/3} \beta^2\right) + e^{\pi i(c-a-\lambda-(2/3))} \text{Ai}'\left(e^{2\pi i/3} \lambda^{2/3} \beta^2\right) \right) (a_1(\zeta) + O(\lambda^{-1})),$$

where

**15.12.10**

$$\zeta = \text{arccosh}\left(\frac{1}{4}z - 1\right),$$

**15.12.11**

$$\beta = \left(-\frac{3}{2}\zeta + \frac{9}{4} \ln\left(\frac{2 + e^\zeta}{2 + e^{-\zeta}}\right)\right)^{1/3},$$

with the branch chosen to be continuous and  $\beta > 0$  when  $\zeta > 0$ . Also,

**15.12.12**

$$a_0(\zeta) = \frac{1}{2}G_0(\beta) + \frac{1}{2}G_0(-\beta), \quad a_1(\zeta) = \left(\frac{1}{2}G_0(\beta) - \frac{1}{2}G_0(-\beta)\right) / \beta,$$

where

**15.12.13**

$$G_0(\pm\beta) = (2 + e^{\pm\zeta})^{c-b-(1/2)} (1 + e^{\pm\zeta})^{a-c+(1/2)} (z - 1 - e^{\pm\zeta})^{-a+(1/2)} \sqrt{\frac{\beta}{e^\zeta - e^{-\zeta}}}.$$

For  $\text{Ai}(z)$  see §9.2, and for further information and an extension to an asymptotic expansion see Olde Daalhuis (2003b). (Two errors in this reference are corrected in (15.12.9).)

By combination of the foregoing results of this subsection with the linear transformations of §15.8(i) and the connection formulas of §15.10(ii), similar asymptotic approximations for  $F(a + e_1\lambda, b + e_2\lambda; c + e_3\lambda; z)$  can be obtained with  $e_j = \pm 1$  or  $0$ ,  $j = 1, 2, 3$ . For more details see Olde Daalhuis (2010). For other extensions, see Wagner (1986) and Temme (2003).

### 15.13 Zeros

Let  $N(a, b, c)$  denote the number of zeros of  $F(a, b, c; z)$  in the sector  $|\text{ph}(1 - z)| < \pi$ . If  $a, b, c$  are real,  $a, b, c, c - a, c - b \neq 0, -1, -2, \dots$ , and, without loss of generality,  $b \geq a, c \geq a + b$  (compare (15.8.1)), then

**15.13.1**

$$N(a, b, c) = \begin{cases} 0, & a > 0, \\ \lfloor -a \rfloor + \frac{1}{2}(1 + S), & a < 0, c - a > 0, \\ \lfloor -a \rfloor + \frac{1}{2}(1 + S) + \lfloor a - c + 1 \rfloor S, & a < 0, c - a < 0, \end{cases}$$

where  $S = \text{sign}(\Gamma(a)\Gamma(b)\Gamma(c-a)\Gamma(c-b))$ .

If  $a, b, c, c - a$ , or  $c - b \in \{0, -1, -2, \dots\}$ , then  $F(a, b, c; z)$  is not defined, or reduces to a polynomial, or reduces to  $(1 - z)^{c-a-b}$  times a polynomial.

For further information on the location of real zeros see Zarzo *et al.* (1995). A small table of zeros is given in Conde and Kalla (1981).

### 15.14 Integrals

The Mellin transform of the hypergeometric function of negative argument is given by

**15.14.1**

$$\int_0^\infty x^{s-1} \mathbf{F}\left(\begin{matrix} a, b \\ c \end{matrix}; -x\right) dx = \frac{\Gamma(s)\Gamma(a-s)\Gamma(b-s)}{\Gamma(a)\Gamma(b)\Gamma(c-s)}, \\ \min(\Re a, \Re b) > \Re s > 0.$$

Integrals of the form  $\int x^\alpha(x+t)^\beta F(a, b, c; x) dx$  and more complicated forms are given in Apelblat (1983,

pp. 370–387), Prudnikov *et al.* (1990, §§1.15 and 2.21), and Gradshteyn and Ryzhik (2000, §7.5).

Fourier transforms of hypergeometric functions are given in Erdélyi *et al.* (1954a, §§1.14 and 2.14). Laplace transforms of hypergeometric functions are given in Erdélyi *et al.* (1954a, §4.21), Oberhettinger and Badii (1973, §1.19), and Prudnikov *et al.* (1992a, §3.37). Inverse Laplace transforms of hypergeometric functions are given in Erdélyi *et al.* (1954a, §5.19), Oberhettinger and Badii (1973, §2.18), and Prudnikov *et al.* (1992b, §3.35). Mellin transforms of hypergeometric functions are given in Erdélyi *et al.* (1954a, §6.9), Oberhettinger (1974, §1.15), and Marichev (1983, pp. 288–299). Inverse Mellin transforms are given in Erdélyi *et al.* (1954a, §7.5). Hankel transforms of hypergeometric functions are given in Oberhettinger (1972, §1.17) and Erdélyi *et al.* (1954b, §8.17).

For other integral transforms see Erdélyi *et al.* (1954b), Prudnikov *et al.* (1992b, §4.3.43), and also §15.9(ii).

### 15.15 Sums

$$15.15.1 \quad \mathbf{F}\left(\begin{matrix} a, b \\ c \end{matrix}; \frac{1}{z}\right) = \left(1 - \frac{z_0}{z}\right)^{-a} \sum_{s=0}^{\infty} \frac{(a)_s}{s!} \\ \times \mathbf{F}\left(\begin{matrix} -s, b \\ c \end{matrix}; \frac{1}{z_0}\right) \left(1 - \frac{z}{z_0}\right)^{-s}.$$

Here  $z_0 (\neq 0)$  is an arbitrary complex constant and the expansion converges when  $|z - z_0| > \max(|z_0|, |z_0 - 1|)$ . For further information see Bühring (1987a) and Kalla (1992).

Also,

$$15.16.3 \quad F\left(\begin{matrix} a, b \\ c \end{matrix}; z\right) F\left(\begin{matrix} a, b \\ c \end{matrix}; \zeta\right) = \sum_{s=0}^{\infty} \frac{(a)_s (b)_s (c-a)_s (c-b)_s}{(c)_s (c)_{2s} s!} (z\zeta)^s F\left(\begin{matrix} a+s, b+s \\ c+2s \end{matrix}; z+\zeta-z\zeta\right), \\ |z| < 1, |\zeta| < 1, |z+\zeta-z\zeta| < 1.$$

$$15.16.4 \quad F\left(\begin{matrix} a, b \\ c \end{matrix}; z\right) F\left(\begin{matrix} -a, -b \\ -c \end{matrix}; z\right) + \frac{ab(a-c)(b-c)}{c^2(1-c^2)} z^2 F\left(\begin{matrix} 1+a, 1+b \\ 2+c \end{matrix}; z\right) F\left(\begin{matrix} 1-a, 1-b \\ 2-c \end{matrix}; z\right) = 1.$$

#### Generalized Legendre's Relation

$$15.16.5 \quad F\left(\begin{matrix} \frac{1}{2} + \lambda, -\frac{1}{2} - \nu \\ 1 + \lambda + \mu \end{matrix}; z\right) F\left(\begin{matrix} \frac{1}{2} - \lambda, \frac{1}{2} + \nu \\ 1 + \nu + \mu \end{matrix}; 1-z\right) + F\left(\begin{matrix} \frac{1}{2} + \lambda, \frac{1}{2} - \nu \\ 1 + \lambda + \mu \end{matrix}; z\right) F\left(\begin{matrix} -\frac{1}{2} - \lambda, \frac{1}{2} + \nu \\ 1 + \nu + \mu \end{matrix}; 1-z\right) \\ - F\left(\begin{matrix} \frac{1}{2} + \lambda, \frac{1}{2} - \nu \\ 1 + \lambda + \mu \end{matrix}; z\right) F\left(\begin{matrix} \frac{1}{2} - \lambda, \frac{1}{2} + \nu \\ 1 + \nu + \mu \end{matrix}; 1-z\right) = \frac{\Gamma(1 + \lambda + \mu) \Gamma(1 + \nu + \mu)}{\Gamma(\lambda + \mu + \nu + \frac{3}{2}) \Gamma(\frac{1}{2} + \nu)}, \\ |\text{ph } z| < \pi, |\text{ph}(1-z)| < \pi.$$

For further results of this kind, and also series of products of hypergeometric functions, see Erdélyi *et al.* (1953a, §2.5.2).

## Applications

### 15.17 Mathematical Applications

#### 15.17(i) Differential Equations

This topic is treated in §§15.10 and 15.11.

The logarithmic derivatives of some hypergeometric functions for which quadratic transformations exist (§15.8(iii)) are solutions of Painlevé equations. See §32.10(vi).

For compendia of finite sums and infinite series involving hypergeometric functions see Prudnikov *et al.* (1990, §§5.3 and 6.7) and Hansen (1975).

### 15.16 Products

$$15.16.1 \quad F\left(\begin{matrix} a, b \\ c - \frac{1}{2} \end{matrix}; z\right) F\left(\begin{matrix} c-a, c-b \\ c + \frac{1}{2} \end{matrix}; z\right) \\ = \sum_{s=0}^{\infty} \frac{(c)_s}{(c + \frac{1}{2})_s} A_s z^s, \quad |z| < 1,$$

where  $A_0 = 1$  and  $A_s, s = 1, 2, \dots$ , are defined by the generating function

$$15.16.2 \quad (1-z)^{a+b-c} F(2a, 2b; 2c-1; z) = \sum_{s=0}^{\infty} A_s z^s, \quad |z| < 1.$$

#### 15.17(ii) Conformal Mappings

The quotient of two solutions of (15.10.1) maps the closed upper half-plane  $\Im z \geq 0$  conformally onto a curvilinear triangle. See Klein (1894) and Hochstadt (1971). Hypergeometric functions, especially complete elliptic integrals, also play an important role in quasi-conformal mapping. See Anderson *et al.* (1997).

#### 15.17(iii) Group Representations

For harmonic analysis it is more natural to represent hypergeometric functions as a Jacobi function (§15.9(ii)). For special values of  $\alpha$  and  $\beta$  there are many group-theoretic interpretations. First, as spherical functions on noncompact Riemannian symmetric spaces of rank one, but also as associated spherical functions, intertwining functions, matrix elements of  $SL(2, \mathbb{R})$ , and spherical functions on certain nonsymmetric Gelfand



pairs. Harmonic analysis can be developed for the Jacobi transform either as a generalization of the Fourier-cosine transform (§1.14(ii)) or as a specialization of a group Fourier transform. For further information see Koornwinder (1984a).

### 15.17(iv) Combinatorics

In combinatorics, hypergeometric identities classify single sums of products of binomial coefficients. See Egorchev (1984, §2.3).

Quadratic transformations give insight into the relation of elliptic integrals to the arithmetic-geometric mean (§19.22(ii)). See Andrews *et al.* (1999, §3.2).

### 15.17(v) Monodromy Groups

The three singular points in Riemann's differential equation (15.11.1) lead to an interesting Riemann sheet structure. By considering, as a group, all analytic transformations of a basis of solutions under analytic continuation around all paths on the Riemann sheet, we obtain the monodromy group. These monodromy groups are finite iff the solutions of Riemann's differential equation are all algebraic. For a survey of this topic see Gray (2000).

## 15.18 Physical Applications

The hypergeometric function has allowed the development of "solvable" models for one-dimensional quantum scattering through and over barriers (Eckart (1930), Bhattacharjie and Sudarshan (1962)), and generalized to include position-dependent effective masses (Dekar *et al.* (1999)).

More varied applications include photon scattering from atoms (Gavrila (1967)), energy distributions of particles in plasmas (Mace and Hellberg (1995)), conformal field theory of critical phenomena (Burkhardt and Xue (1991)), quantum chromo-dynamics (Atkinson and Johnson (1988)), and general parametrization of the effective potentials of interaction between atoms in diatomic molecules (Herrick and O'Connor (1998)).

## Computation

### 15.19 Methods of Computation

#### 15.19(i) Maclaurin Expansions

The Gauss series (15.2.1) converges for  $|z| < 1$ . For  $z \in \mathbb{R}$  it is always possible to apply one of the linear

transformations in §15.8(i) in such a way that the hypergeometric function is expressed in terms of hypergeometric functions with an argument in the interval  $[0, \frac{1}{2}]$ .

For  $z \in \mathbb{C}$  it is possible to use the linear transformations in such a way that the new arguments lie within the unit circle, except when  $z = e^{\pm\pi i/3}$ . This is because the linear transformations map the pair  $\{e^{\pi i/3}, e^{-\pi i/3}\}$  onto itself. However, by appropriate choice of the constant  $z_0$  in (15.15.1) we can obtain an infinite series that converges on a disk containing  $z = e^{\pm\pi i/3}$ . Moreover, it is also possible to accelerate convergence by appropriate choice of  $z_0$ .

Large values of  $|a|$  or  $|b|$ , for example, delay convergence of the Gauss series, and may also lead to severe cancellation.

For further information see Bühring (1987a), Forrey (1997), and Kalla (1992).

#### 15.19(ii) Differential Equation

A comprehensive and powerful approach is to integrate the hypergeometric differential equation (15.10.1) by direct numerical methods. As noted in §3.7(ii), the integration path should be chosen so that the wanted solution grows in magnitude at least as fast as all other solutions. However, since the growth near the singularities of the differential equation is algebraic rather than exponential, the resulting instabilities in the numerical integration might be tolerable in some cases.

#### 15.19(iii) Integral Representations

The representation (15.6.1) can be used to compute the hypergeometric function in the sector  $|\text{ph}(1-z)| < \pi$ . Gauss quadrature approximations are discussed in Gautschi (2002b).

#### 15.19(iv) Recurrence Relations

The relations in §15.5(ii) can be used to compute  $F(a, b; c; z)$ , provided that care is taken to apply these relations in a stable manner; see §3.6(ii). Initial values for moderate values of  $|a|$  and  $|b|$  can be obtained by the methods of §15.19(i), and for large values of  $|a|$ ,  $|b|$ , or  $|c|$  via the asymptotic expansions of §§15.12(ii) and 15.12(iii).

For example, in the half-plane  $\Re z \leq \frac{1}{2}$  we can use (15.12.2) or (15.12.3) to compute  $F(a, b; c + N + 1; z)$  and  $F(a, b; c + N; z)$ , where  $N$  is a large positive integer, and then apply (15.5.18) in the backward direction. When  $\Re z > \frac{1}{2}$  it is better to begin with one of the linear transformations (15.8.4), (15.8.7), or (15.8.8). For further information see Gil *et al.* (2006a, 2007b).

## 15.20 Software

See <http://dlmf.nist.gov/15.20>.

## References

### General References

The main references used in writing this chapter are Andrews *et al.* (1999) and Temme (1996a). For additional bibliographic reading see Erdélyi *et al.* (1953a), Hochstadt (1971), Luke (1969a), Olver (1997b), Slater (1966), Wang and Guo (1989), and Whittaker and Watson (1927).

### Sources

The following list gives the references or other indications of proofs that were used in constructing the various sections of this chapter. These sources supplement the references that are quoted in the text.

- §15.2 Andrews *et al.* (1999, §2.1), Olver (1997b, Chapter 5, Theorem 9.1), Temme (1996a, §5.1). (15.2.3) is a consequence of (15.8.4).
- §15.3 These graphics were produced at NIST.
- §15.4 Andrews *et al.* (1999, §2.2). For (15.4.1)–(15.4.6) see Temme (1996a, §5.1). For (15.4.7) use (15.8.27), (15.4.6), and (5.5.5). For (15.4.9) use (15.8.28), (15.4.6), and (5.5.5). For (15.4.11) use (15.8.1) and (15.4.7). For (15.4.13) use (15.8.1) and (15.4.11). For (15.4.15) use (15.8.1) and (15.4.9). For (15.4.17) and (15.4.18) use (15.8.15) and (15.4.6). For (15.4.19) use (15.5.11) and (15.4.6). For (15.4.21) use (15.8.10). For (15.4.22) and (15.4.23) use (15.8.4), (5.5.3), and (5.5.1). For (15.4.25) see Dougall (1907) or Andrews *et al.* (1999, §2.8). For (15.4.26) use (15.8.24) and (5.5.5). For (15.4.27) use (15.2.1) and (5.7.7). For (15.4.28) use (15.8.1), (15.4.26), and (5.5.5). For (15.4.29) use (15.8.1), (15.5.15), (15.4.26), (5.5.5), and (5.5.1). For (15.4.30) use (15.8.1) and (15.4.28). For (15.4.31) use (15.8.1), Erdélyi *et al.* (1953a, Eq. (2.11.41)), (15.4.20), and (5.5.5). For (15.4.32) use (15.8.30), (15.4.28), (5.5.5), and (5.5.6). (Note that Erdélyi *et al.* (1953a, Eq. (2.8.54)) contains an error.) For (15.4.33) let  $z \rightarrow -\infty$  in (15.8.32) and use (5.5.5).
- §15.5 Andrews *et al.* (1999, §2.5). For (15.5.2)–(15.5.9) use induction. For (15.5.10) see Fleury and Turbiner (1994).
- §15.6 Andrews *et al.* (1999, §§2.2, 2.4, 2.9), Erdélyi *et al.* (1953a, §2.1.3), and Whittaker and Watson (1927, pp. 290–291). (15.6.3) follows from (15.6.4).
- §15.7 Andrews *et al.* (1999, pp. 94, 97–98, and Ex. 26 on p. 119), Lorentzen and Waadeland (1992, §6.1), and Berndt (1989, pp. 134–137). These references contain several restrictions on the parameters  $a$ ,  $b$ , and  $c$ . This is because they use the function  $F(a, b; c; z)$ . No restrictions are needed for  $\mathbf{F}(a, b; c; z)$ .
- §15.8 For (15.8.1)–(15.8.4) see Olver (1997b, Chapter 5, §10). For (15.8.5) combine (15.8.1) and (15.8.2). (15.8.6) and (15.8.7) are obtained as limits of (15.8.2)–(15.8.5) as  $a \rightarrow -m$ , together with (5.5.3). For (15.8.8) and (15.8.10) see Erdélyi *et al.* (1953a, §§2.1.4 and 2.3.1). (15.8.9) and (15.8.11) follow from (15.8.10) and (15.8.8), respectively, via (15.8.1). For §15.8(iii) see Andrews *et al.* (1999, §3.1). For (15.8.31) and (15.8.32) see Goursat (1881, Eq. (110)) and Watson (1910). The version of (15.8.31) given in Erdélyi *et al.* (1953a, p. 114 (40)) contains a typographical error. For (15.8.33) see Chan (1998).
- §15.9 For (15.9.1)–(15.9.10) see §§18.5(ii) and 18.20(ii). For (15.9.15) see Erdélyi *et al.* (1953a, §§3.15.1 and 3.15.2).
- §15.10 Andrews *et al.* (1999, §2.3), Olver (1997b, pp. 163–168), and Luke (1969a, Chapter III). (15.10.9) is a corrected version of (2.3.20) in the first reference.
- §15.11 Andrews *et al.* (1999, §2.3) or Olver (1997b, pp. 156–158).
- §15.12 For (15.12.2) see Wagner (1988). The region of validity given in Luke (1969a, p. 235) is incorrect. For (15.12.3) see Luke (1969a, §7.2) and Olver (1997b, p. 162). The sector of validity given in the first reference is incorrect. See the third footnote in the second reference.
- §15.13 Runckel (1971).
- §15.14 Andrews *et al.* (1999, §2.4).
- §15.16 Burchnall and Chaundy (1940, 1948) and Elliott (1903). For (15.16.4) use (15.8.2) and (15.8.4), combined with (15.8.1) to show that the left-hand side of (15.16.4) is an entire function of  $z$ . Then apply Liouville’s theorem (1.9(iii)).



## Chapter 16

# Generalized Hypergeometric Functions and Meijer $G$ -Function

R. A. Askey<sup>1</sup> and A. B. Olde Daalhuis<sup>2</sup>

<b>Notation</b>	<b>404</b>	16.16 Transformations of Variables . . . . .	414
16.1 Special Notation . . . . .	404	<b>Meijer <math>G</math>-Function</b>	<b>415</b>
<b>Generalized Hypergeometric Functions</b>	<b>404</b>	16.17 Definition . . . . .	415
16.2 Definition and Analytic Properties . . . . .	404	16.18 Special Cases . . . . .	416
16.3 Derivatives and Contiguous Functions . . . . .	405	16.19 Identities . . . . .	416
16.4 Argument Unity . . . . .	405	16.20 Integrals and Series . . . . .	416
16.5 Integral Representations and Integrals . . . . .	408	16.21 Differential Equation . . . . .	417
16.6 Transformations of Variable . . . . .	408	16.22 Asymptotic Expansions . . . . .	417
16.7 Relations to Other Functions . . . . .	409	<b>Applications</b>	<b>417</b>
16.8 Differential Equations . . . . .	409	16.23 Mathematical Applications . . . . .	417
16.9 Zeros . . . . .	410	16.24 Physical Applications . . . . .	417
16.10 Expansions in Series of ${}_pF_q$ Functions . . . . .	410	<b>Computation</b>	<b>418</b>
16.11 Asymptotic Expansions . . . . .	411	16.25 Methods of Computation . . . . .	418
16.12 Products . . . . .	412	16.26 Approximations . . . . .	418
<b>Two-Variable Hypergeometric Functions</b>	<b>412</b>	16.27 Software . . . . .	418
16.13 Appell Functions . . . . .	412	<b>References</b>	<b>418</b>
16.14 Partial Differential Equations . . . . .	413		
16.15 Integral Representations and Integrals . . . . .	414		

<sup>1</sup>Department of Mathematics, University of Wisconsin, Madison, Wisconsin.

<sup>2</sup>School of Mathematics, Edinburgh University, Edinburgh, United Kingdom.

**Acknowledgments:** The authors are pleased to acknowledge the assistance of B. L. J. Braaksma with §§16.5 and 16.11.

**Copyright** © 2009 National Institute of Standards and Technology. All rights reserved.

## Notation

### 16.1 Special Notation

(For other notation see pp. [xiv](#) and [873](#).)

$p, q$	nonnegative integers.
$k, n$	nonnegative integers, unless stated otherwise.
$z$	complex variable.
$a_1, a_2, \dots, a_p$ $b_1, b_2, \dots, b_q$	real or complex parameters.
$\delta$	arbitrary small positive constant.
$\mathbf{a}$	vector $(a_1, a_2, \dots, a_p)$ .
$\mathbf{b}$	vector $(b_1, b_2, \dots, b_q)$ .
$(\mathbf{a})_k$	$(a_1)_k (a_2)_k \cdots (a_p)_k$ .
$(\mathbf{b})_k$	$(b_1)_k (b_2)_k \cdots (b_q)_k$ .
$D$	$d/dz$ .
$\vartheta$	$z d/dz$ .

The main functions treated in this chapter are the generalized hypergeometric function  ${}_pF_q\left(\begin{smallmatrix} a_1, \dots, a_p \\ b_1, \dots, b_q \end{smallmatrix}; z\right)$ , the Appell (two-variable hypergeometric) functions  $F_1(\alpha; \beta, \beta'; \gamma; x, y)$ ,  $F_2(\alpha; \beta, \beta'; \gamma, \gamma'; x, y)$ ,  $F_3(\alpha, \alpha'; \beta, \beta'; \gamma; x, y)$ ,  $F_4(\alpha; \beta; \gamma, \gamma'; x, y)$ , and the Meijer  $G$ -function  $G_{p,q}^{m,n}\left(z; \begin{smallmatrix} a_1, \dots, a_p \\ b_1, \dots, b_q \end{smallmatrix}\right)$ . Alternative notations are  ${}_pF_q\left(\begin{smallmatrix} \mathbf{a} \\ \mathbf{b} \end{smallmatrix}; z\right)$ ,  ${}_pF_q(a_1, \dots, a_p; b_1, \dots, b_q; z)$ , and  ${}_pF_q(\mathbf{a}; \mathbf{b}; z)$  for the generalized hypergeometric function,  $F_1(\alpha, \beta, \beta'; \gamma; x, y)$ ,  $F_2(\alpha, \beta, \beta'; \gamma, \gamma'; x, y)$ ,  $F_3(\alpha, \alpha', \beta, \beta'; \gamma; x, y)$ ,  $F_4(\alpha, \beta; \gamma, \gamma'; x, y)$ , for the Appell functions, and  $G_{p,q}^{m,n}(z; \mathbf{a}; \mathbf{b})$  for the Meijer  $G$ -function.

## Generalized Hypergeometric Functions

### 16.2 Definition and Analytic Properties

#### 16.2(i) Generalized Hypergeometric Series

Throughout this chapter it is assumed that none of the bottom parameters  $b_1, b_2, \dots, b_q$  is a nonpositive integer, *unless stated otherwise*. Then formally

$$16.2.1 \quad {}_pF_q\left(\begin{smallmatrix} a_1, \dots, a_p \\ b_1, \dots, b_q \end{smallmatrix}; z\right) = \sum_{k=0}^{\infty} \frac{(a_1)_k \cdots (a_p)_k}{(b_1)_k \cdots (b_q)_k} \frac{z^k}{k!}.$$

Equivalently, the function is denoted by  ${}_pF_q\left(\begin{smallmatrix} \mathbf{a} \\ \mathbf{b} \end{smallmatrix}; z\right)$  or  ${}_pF_q(\mathbf{a}; \mathbf{b}; z)$ , and sometimes, for brevity, by  ${}_pF_q(z)$ .

#### 16.2(ii) Case $p \leq q$

When  $p \leq q$  the series (16.2.1) converges for all finite values of  $z$  and defines an entire function.

#### 16.2(iii) Case $p = q + 1$

Suppose first one or more of the top parameters  $a_j$  is a nonpositive integer. Then the series (16.2.1) terminates and the generalized hypergeometric function is a polynomial in  $z$ .

If none of the  $a_j$  is a nonpositive integer, then the radius of convergence of the series (16.2.1) is 1, and outside the open disk  $|z| < 1$  the generalized hypergeometric function is defined by analytic continuation with respect to  $z$ . The branch obtained by introducing a cut from 1 to  $+\infty$  on the real axis, that is, the branch in the sector  $|\text{ph}(1 - z)| \leq \pi$ , is the *principal branch* (or *principal value*) of  ${}_qF_q(\mathbf{a}; \mathbf{b}; z)$ ; compare §4.2(i). Elsewhere the generalized hypergeometric function is a multivalued function that is analytic except for possible branch points at  $z = 0, 1$ , and  $\infty$ . *Unless indicated otherwise* it is assumed that in this Handbook generalized hypergeometric functions assume their principal values.

On the circle  $|z| = 1$  the series (16.2.1) is absolutely convergent if  $\Re \gamma_q > 0$ , convergent except at  $z = 1$  if  $-1 < \Re \gamma_q \leq 0$ , and divergent if  $\Re \gamma_q \leq -1$ , where

$$16.2.2 \quad \gamma_q = (b_1 + \cdots + b_q) - (a_1 + \cdots + a_{q+1}).$$

#### 16.2(iv) Case $p > q + 1$

##### Polynomials

In general the series (16.2.1) diverges for all nonzero values of  $z$ . However, when one or more of the top parameters  $a_j$  is a nonpositive integer the series terminates and the generalized hypergeometric function is a polynomial in  $z$ . Note that if  $-m$  is the value of the numerically largest  $a_j$  that is a nonpositive integer, then the identity

##### 16.2.3

$${}_pF_q\left(\begin{smallmatrix} -m, \mathbf{a} \\ \mathbf{b} \end{smallmatrix}; z\right) = \frac{(\mathbf{a})_m (-z)^m}{(\mathbf{b})_m} {}_{q+1}F_p\left(\begin{smallmatrix} -m, 1 - m - \mathbf{b} \\ 1 - m - \mathbf{a} \end{smallmatrix}; \frac{(-1)^{p+q}}{z}\right)$$

can be used to interchange  $p$  and  $q$ .

Note also that any partial sum of the generalized hypergeometric series can be represented as a generalized hypergeometric function via

##### 16.2.4

$$\sum_{k=0}^m \frac{(\mathbf{a})_k}{(\mathbf{b})_k} \frac{z^k}{k!} = \frac{(\mathbf{a})_m}{(\mathbf{b})_m} \frac{z^m}{m!} {}_{q+2}F_p\left(\begin{smallmatrix} -m, 1, 1 - m - \mathbf{b} \\ 1 - m - \mathbf{a} \end{smallmatrix}; \frac{(-1)^{p+q+1}}{z}\right).$$

##### Non-Polynomials

See §16.5 for the definition of  ${}_pF_q(\mathbf{a}; \mathbf{b}; z)$  as a contour integral when  $p > q + 1$  and none of the  $a_k$  is a nonpositive integer. (However, *except where indicated otherwise* in this Handbook we assume that when  $p > q + 1$  at least one of the  $a_k$  is a nonpositive integer.)

**16.2(v) Behavior with Respect to Parameters**

Let

**16.2.5** 
$${}_pF_q(\mathbf{a}; \mathbf{b}; z) = {}_pF_q\left(\begin{matrix} a_1, \dots, a_p \\ b_1, \dots, b_q \end{matrix}; z\right) / (\Gamma(b_1) \cdots \Gamma(b_q)) = \sum_{k=0}^{\infty} \frac{(a_1)_k \cdots (a_p)_k}{\Gamma(b_1+k) \cdots \Gamma(b_q+k)} \frac{z^k}{k!};$$

compare (15.2.2) in the case  $p = 2, q = 1$ . When  $p \leq q + 1$  and  $z$  is fixed and not a branch point, any branch of  ${}_pF_q(\mathbf{a}; \mathbf{b}; z)$  is an entire function of each of the parameters  $a_1, \dots, a_p, b_1, \dots, b_q$ .

**16.3 Derivatives and Contiguous Functions**

**16.3(i) Differentiation Formulas**

**16.3.1** 
$$\frac{d^n}{dz^n} {}_pF_q\left(\begin{matrix} a_1, \dots, a_p \\ b_1, \dots, b_q \end{matrix}; z\right) = \frac{(\mathbf{a})_n}{(\mathbf{b})_n} {}_pF_q\left(\begin{matrix} a_1 + n, \dots, a_p + n \\ b_1 + n, \dots, b_q + n \end{matrix}; z\right),$$

**16.3.2** 
$$\frac{d^n}{dz^n} \left( z^\gamma {}_pF_q\left(\begin{matrix} a_1, \dots, a_p \\ b_1, \dots, b_q \end{matrix}; z\right) \right) = (\gamma - n + 1)_n z^{\gamma-n} {}_{p+1}F_{q+1}\left(\begin{matrix} \gamma + 1, a_1, \dots, a_p \\ \gamma + 1 - n, b_1, \dots, b_q \end{matrix}; z\right),$$

**16.3.3** 
$$\left( z \frac{d}{dz} z \right)^n \left( z^{\gamma-1} {}_{p+1}F_q\left(\begin{matrix} \gamma, a_1, \dots, a_p \\ b_1, \dots, b_q \end{matrix}; z\right) \right) = (\gamma)_n z^{\gamma+n-1} {}_{p+1}F_q\left(\begin{matrix} \gamma + n, a_1, \dots, a_p \\ b_1, \dots, b_q \end{matrix}; z\right),$$

**16.3.4** 
$$\frac{d^n}{dz^n} \left( z^{\gamma-1} {}_pF_{q+1}\left(\begin{matrix} a_1, \dots, a_p \\ \gamma, b_1, \dots, b_q \end{matrix}; z\right) \right) = (\gamma - n)_n z^{\gamma-n-1} {}_pF_{q+1}\left(\begin{matrix} a_1, \dots, a_p \\ \gamma - n, b_1, \dots, b_q \end{matrix}; z\right).$$

Other versions of these identities can be constructed with the aid of the operator identity

**16.3.5** 
$$\left( z \frac{d}{dz} z \right)^n = z^n \frac{d^n}{dz^n} z^n, \quad n = 1, 2, \dots$$

**16.3(ii) Contiguous Functions**

Two generalized hypergeometric functions  ${}_pF_q(\mathbf{a}; \mathbf{b}; z)$  are (*generalized*) *contiguous* if they have the same pair of values of  $p$  and  $q$ , and corresponding parameters differ by integers. If  $p \leq q + 1$ , then any  $q + 2$  distinct contiguous functions are linearly related. Examples are provided by the following recurrence relations:

**16.3.6** 
$$z {}_0F_1(-; b + 1; z) + b(b - 1) {}_0F_1(-; b; z) - b(b - 1) {}_0F_1(-; b - 1; z) = 0,$$

$${}_3F_2\left(\begin{matrix} a_1 + 2, a_2, a_3 \\ b_1, b_2 \end{matrix}; z\right) a_1(a_1 + 1)(1 - z) + {}_3F_2\left(\begin{matrix} a_1 + 1, a_2, a_3 \\ b_1, b_2 \end{matrix}; z\right) a_1(b_1 + b_2 - 3a_1 - 2 + z(2a_1 - a_2 - a_3 + 1))$$

**16.3.7** 
$$+ {}_3F_2\left(\begin{matrix} a_1, a_2, a_3 \\ b_1, b_2 \end{matrix}; z\right) ((2a_1 - b_1)(2a_1 - b_2) + a_1 - a_1^2 - z(a_1 - a_2)(a_1 - a_3))$$

$$- {}_3F_2\left(\begin{matrix} a_1 - 1, a_2, a_3 \\ b_1, b_2 \end{matrix}; z\right) (a_1 - b_1)(a_1 - b_2) = 0.$$

For further examples see §§13.3(i), 15.5(ii), and the following references: Rainville (1960, §48), Wimp (1968), and Luke (1975, §5.13).

**16.4 Argument Unity**

**16.4(i) Classification**

The function  ${}_{q+1}F_q(\mathbf{a}; \mathbf{b}; z)$  is *well-poised* if

**16.4.1** 
$$a_1 + b_1 = \cdots = a_q + b_q = a_{q+1} + 1.$$

It is *very well-poised* if it is well-poised and  $a_1 = b_1 + 1$ .

The special case  ${}_{q+1}F_q(\mathbf{a}; \mathbf{b}; 1)$  is *k-balanced* if  $a_{q+1}$  is a nonpositive integer and

**16.4.2** 
$$a_1 + \cdots + a_{q+1} + k = b_1 + \cdots + b_q.$$

When  $k = 1$  the function is said to be *balanced* or *Saalschützian*.

**16.4(ii) Examples**

The function  ${}_qF_q$  with argument unity and general values of the parameters is discussed in Bühring (1992). Special cases are as follows:

**Pfaff–Saalschütz Balanced Sum**

16.4.3 
$${}_3F_2\left(\begin{matrix} -n, a, b \\ c, d \end{matrix}; 1\right) = \frac{(c-a)_n(c-b)_n}{(c)_n(c-a-b)_n},$$

when  $c + d = a + b + 1 - n$ ,  $n = 0, 1, \dots$ . See Erdélyi *et al.* (1953a, §4.4(4)) for a non-terminating balanced identity.

**Dixon’s Well-Poised Sum**

16.4.4 
$${}_3F_2\left(\begin{matrix} a, b, c \\ a-b+1, a-c+1 \end{matrix}; 1\right) = \frac{\Gamma(\frac{1}{2}a+1)\Gamma(a-b+1)\Gamma(a-c+1)\Gamma(\frac{1}{2}a-b-c+1)}{\Gamma(a+1)\Gamma(\frac{1}{2}a-b+1)\Gamma(\frac{1}{2}a-c+1)\Gamma(a-b-c+1)},$$

when  $\Re(a - 2b - 2c) > -2$ , or when the series terminates with  $a = -n$ :

16.4.5 
$${}_3F_2\left(\begin{matrix} -n, b, c \\ 1-b-n, 1-c-n \end{matrix}; 1\right) = \begin{cases} 0, & n = 2k + 1, \\ \frac{(2k)!\Gamma(b+k)\Gamma(c+k)\Gamma(b+c+2k)}{k!\Gamma(b+2k)\Gamma(c+2k)\Gamma(b+c+k)}, & n = 2k, \end{cases}$$

where  $k = 0, 1, \dots$

**Watson’s Sum**

16.4.6 
$${}_3F_2\left(\begin{matrix} a, b, c \\ \frac{1}{2}(a+b+1), 2c \end{matrix}; 1\right) = \frac{\Gamma(\frac{1}{2})\Gamma(c+\frac{1}{2})\Gamma(\frac{1}{2}(a+b+1))\Gamma(c+\frac{1}{2}(1-a-b))}{\Gamma(\frac{1}{2}(a+1))\Gamma(\frac{1}{2}(b+1))\Gamma(c+\frac{1}{2}(1-a))\Gamma(c+\frac{1}{2}(1-b))},$$

when  $\Re(2c - a - b) > -1$ , or when the series terminates with  $a = -n$ .

**Whipple’s Sum**

16.4.7 
$${}_3F_2\left(\begin{matrix} a, 1-a, c \\ d, 2c-d+1 \end{matrix}; 1\right) = \frac{\pi\Gamma(d)\Gamma(2c-d+1)2^{1-2c}}{\Gamma(c+\frac{1}{2}(a-d+1))\Gamma(c+1-\frac{1}{2}(a+d))\Gamma(\frac{1}{2}(a+d))\Gamma(\frac{1}{2}(d-a+1))},$$

when  $\Re c > 0$  or when  $a$  is an integer.

**Džrbasjan’s Sum**

This is (16.4.7) in the case  $c = -n$ :

16.4.8 
$${}_3F_2\left(\begin{matrix} -n, a, 1-a \\ d, 1-d-2n \end{matrix}; 1\right) = \frac{(\frac{1}{2}(a+d))_n(\frac{1}{2}(d-a+1))_n}{(\frac{1}{2}d)_n(\frac{1}{2}(d+1))_n}, \quad n = 0, 1, \dots$$

**Rogers–Dougall Very Well-Poised Sum**

16.4.9 
$${}_5F_4\left(\begin{matrix} a, \frac{1}{2}a+1, b, c, d \\ \frac{1}{2}a, a-b+1, a-c+1, a-d+1 \end{matrix}; 1\right) = \frac{\Gamma(a-b+1)\Gamma(a-c+1)\Gamma(a-d+1)\Gamma(a-b-c-d+1)}{\Gamma(a+1)\Gamma(a-b-c+1)\Gamma(a-b-d+1)\Gamma(a-c-d+1)},$$

when  $\Re(b + c + d - a) < 1$ , or when the series terminates with  $d = -n$ .

**Dougall’s Very Well-Poised Sum**

16.4.10 
$$\begin{aligned} & {}_7F_6\left(\begin{matrix} a, \frac{1}{2}a+1, b, c, d, f, -n \\ \frac{1}{2}a, a-b+1, a-c+1, a-d+1, a-f+1, a+n+1 \end{matrix}; 1\right) \\ &= \frac{(a+1)_n(a-b-c+1)_n(a-b-d+1)_n(a-c-d+1)_n}{(a-b+1)_n(a-c+1)_n(a-d+1)_n(a-b-c-d+1)_n}, \end{aligned} \quad n = 0, 1, \dots,$$

when  $2a + 1 = b + c + d + f - n$ . The last condition is equivalent to the sum of the top parameters plus 2 equals the sum of the bottom parameters, that is, the series is 2-balanced.

### 16.4(iii) Identities

$$16.4.11 \quad {}_3F_2\left(\begin{matrix} a, b, c \\ d, e \end{matrix}; 1\right) = \frac{\Gamma(e)\Gamma(d+e-a-b-c)}{\Gamma(e-a)\Gamma(d+e-b-c)} {}_3F_2\left(\begin{matrix} a, d-b, d-c \\ d, d+e-b-c \end{matrix}; 1\right),$$

when  $\Re(d+e-a-b-c) > 0$  and  $\Re(e-a) > 0$ . The function  ${}_3F_2(a, b, c; d, e; 1)$  is analytic in the parameters  $a, b, c, d, e$  when its series expansion converges and the bottom parameters are not negative integers or zero. (16.4.11) provides a partial analytic continuation to the region when the only restrictions on the parameters are  $\Re(e-a) > 0$ , and  $d, e$ , and  $d+e-b-c \neq 0, -1, \dots$ . A detailed treatment of analytic continuation in (16.4.11) and asymptotic approximations as the variables  $a, b, c, d, e$  approach infinity is given by Aomoto (1987).

There are two types of three-term identities for  ${}_3F_2$ 's. The first are recurrence relations that extend those for  ${}_2F_1$ 's; see §15.5(ii). Examples are (16.3.7) with  $z = 1$ . Also,

$$16.4.12 \quad (a-d)(b-d)(c-d) \left( {}_3F_2\left(\begin{matrix} a, b, c \\ d+1, e \end{matrix}; 1\right) - {}_3F_2\left(\begin{matrix} a, b, c \\ d, e \end{matrix}; 1\right) \right) + abc {}_3F_2\left(\begin{matrix} a, b, c \\ d, e \end{matrix}; 1\right) \\ = d(d-1)(a+b+c-d-e+1) \left( {}_3F_2\left(\begin{matrix} a, b, c \\ d, e \end{matrix}; 1\right) - {}_3F_2\left(\begin{matrix} a, b, c \\ d-1, e \end{matrix}; 1\right) \right),$$

and

$$16.4.13 \quad {}_3F_2\left(\begin{matrix} a, b, c \\ d, e \end{matrix}; 1\right) = \frac{c(e-a)}{de} {}_3F_2\left(\begin{matrix} a, b+1, c+1 \\ d+1, e+1 \end{matrix}; 1\right) + \frac{d-c}{d} {}_3F_2\left(\begin{matrix} a, b+1, c \\ d+1, e \end{matrix}; 1\right).$$

Methods of deriving such identities are given by Bailey (1964), Rainville (1960), Raynal (1979), and Wilson (1978). Lists are given by Raynal (1979) and Wilson (1978). See Raynal (1979) for a statement in terms of  $3j$  symbols (Chapter 34). Also see Wilf and Zeilberger (1992a,b) for information on the Wilf–Zeilberger algorithm which can be used to find such relations.

The other three-term relations are extensions of Kummer's relations for  ${}_2F_1$ 's given in §15.10(ii). See Bailey (1964, pp. 19–22).

Balanced  ${}_4F_3(1)$  series have transformation formulas and three-term relations. The basic transformation is given by

$$16.4.14 \quad {}_4F_3\left(\begin{matrix} -n, a, b, c \\ d, e, f \end{matrix}; 1\right) = \frac{(e-a)_n(f-a)_n}{(e)_n(f)_n} {}_4F_3\left(\begin{matrix} -n, a, d-b, d-c \\ d, a-e-n+1, a-f-n+1 \end{matrix}; 1\right),$$

when  $a+b+c-n+1 = d+e+f$ . These series contain  $6j$  symbols as special cases when the parameters are integers; compare §34.4.

The characterizing properties (18.22.2), (18.22.10), (18.22.19), (18.22.20), and (18.26.14) of the Hahn and Wilson class polynomials are examples of the contiguous relations mentioned in the previous three paragraphs.

Contiguous balanced series have parameters shifted by an integer but still balanced. One example of such a three-term relation is the recurrence relation (18.26.16) for Racah polynomials. See Raynal (1979), Wilson (1978), and Bailey (1964).

A different type of transformation is that of Whipple:

$$16.4.15 \quad {}_7F_6\left(\begin{matrix} a, \frac{1}{2}a+1, b, c, d, e, f \\ \frac{1}{2}a, a-b+1, a-c+1, a-d+1, a-e+1, a-f+1 \end{matrix}; 1\right) \\ = \frac{\Gamma(a-d+1)\Gamma(a-e+1)\Gamma(a-f+1)\Gamma(a-d-e-f+1)}{\Gamma(a+1)\Gamma(a-d-e+1)\Gamma(a-d-f+1)\Gamma(a-e-f+1)} {}_4F_3\left(\begin{matrix} a-b-c+1, d, e, f \\ a-b+1, a-c+1, d+e+f-a \end{matrix}; 1\right),$$

when the series on the right terminates and the series on the left converges. When the series on the right does not terminate, a second term appears. See Bailey (1964, §4.4(4)).

Transformations for both balanced  ${}_4F_3(1)$  and very well-poised  ${}_7F_6(1)$  are included in Bailey (1964, pp. 56–63). A similar theory is available for very well-poised  ${}_9F_8(1)$ 's which are 2-balanced. See Bailey (1964, §§4.3(7) and 7.6(1)) for the transformation formulas and Wilson (1978) for contiguous relations.

Relations between three solutions of three-term recurrence relations are given by Masson (1991). See also Lewanowicz (1985) (with corrections in Lewanowicz (1987)) for further examples of recurrence relations.

### 16.4(iv) Continued Fractions

For continued fractions for ratios of  ${}_3F_2$  functions with argument unity, see Cuyt *et al.* (2008, pp. 315–317).



### 16.4(v) Bilateral Series

Denote, formally, the bilateral hypergeometric function

$$16.4.16 \quad {}_pH_q \left( \begin{matrix} a_1, \dots, a_p \\ b_1, \dots, b_q \end{matrix}; z \right) = \sum_{k=-\infty}^{\infty} \frac{(a_1)_k \cdots (a_p)_k}{(b_1)_k \cdots (b_q)_k} z^k.$$

Then

$$16.4.17 \quad {}_2H_2 \left( \begin{matrix} a, b \\ c, d \end{matrix}; 1 \right) = \frac{\Gamma(c) \Gamma(d) \Gamma(1-a) \Gamma(1-b) \Gamma(c+d-a-b-1)}{\Gamma(c-a) \Gamma(d-a) \Gamma(c-b) \Gamma(d-b)}, \quad \Re(c+d-a-b) > 1.$$

This is *Dougall's bilateral sum*; see Andrews *et al.* (1999, §2.8).

### 16.5 Integral Representations and Integrals

When  $z \neq 0$  and  $a_k \neq 0, -1, -2, \dots, k = 1, 2, \dots, p$ ,

$$16.5.1 \quad \left( \prod_{k=1}^p \Gamma(a_k) \right) / \left( \prod_{k=1}^q \Gamma(b_k) \right) {}_pF_q \left( \begin{matrix} a_1, \dots, a_p \\ b_1, \dots, b_q \end{matrix}; z \right) = \frac{1}{2\pi i} \int_L \left( \prod_{k=1}^p \Gamma(a_k + s) \right) / \left( \prod_{k=1}^q \Gamma(b_k + s) \right) \Gamma(-s) (-z)^s ds,$$

where the contour of integration separates the poles of  $\Gamma(a_k + s)$ ,  $k = 1, \dots, p$ , from those of  $\Gamma(-s)$ .

Suppose first that  $L$  is a contour that starts at infinity on a line parallel to the positive real axis, encircles the nonnegative integers in the negative sense, and ends at infinity on another line parallel to the positive real axis. Then the integral converges when  $p < q + 1$  provided that  $z \neq 0$ , or when  $p = q + 1$  provided that  $0 < |z| < 1$ , and provides an integral representation of the left-hand side with these conditions.

Secondly, suppose that  $L$  is a contour from  $-i\infty$  to  $i\infty$ . Then the integral converges when  $q < p + 1$  and  $|\text{ph}(-z)| < (p + 1 - q)\pi/2$ . In the case  $p = q$  the left-hand side of (16.5.1) is an entire function, and the right-hand side supplies an integral representation valid when  $|\text{ph}(-z)| < \pi/2$ . In the case  $p = q + 1$  the right-hand side of (16.5.1) supplies the analytic continuation of the left-hand side from the open unit disk to the sector  $|\text{ph}(1 - z)| < \pi$ ; compare §16.2(iii). Lastly, when  $p > q + 1$  the right-hand side of (16.5.1) can be regarded as the definition of the (customarily undefined) left-hand side. In this event, the formal power-series expansion of the left-hand side (obtained from (16.2.1)) is the asymptotic expansion of the right-hand side as  $z \rightarrow 0$  in the sector  $|\text{ph}(-z)| \leq (p + 1 - q - \delta)\pi/2$ , where  $\delta$  is an arbitrary small positive constant.

Next, when  $p \leq q$ ,

$$16.5.2 \quad {}_{p+1}F_{q+1} \left( \begin{matrix} a_0, \dots, a_p \\ b_0, \dots, b_q \end{matrix}; z \right) = \frac{\Gamma(b_0)}{\Gamma(a_0) \Gamma(b_0 - a_0)} \int_0^1 t^{a_0-1} (1-t)^{b_0-a_0-1} {}_pF_q \left( \begin{matrix} a_1, \dots, a_p \\ b_1, \dots, b_q \end{matrix}; zt \right) dt, \quad \Re b_0 > \Re a_0 > 0,$$

$$16.5.3 \quad {}_{p+1}F_q \left( \begin{matrix} a_0, \dots, a_p \\ b_1, \dots, b_q \end{matrix}; z \right) = \frac{1}{\Gamma(a_0)} \int_0^\infty e^{-t} t^{a_0-1} {}_pF_q \left( \begin{matrix} a_1, \dots, a_p \\ b_1, \dots, b_q \end{matrix}; zt \right) dt, \quad \Re z < 1, \Re a_0 > 0,$$

$$16.5.4 \quad {}_pF_{q+1} \left( \begin{matrix} a_1, \dots, a_p \\ b_0, \dots, b_q \end{matrix}; z \right) = \frac{\Gamma(b_0)}{2\pi i} \int_{c-i\infty}^{c+i\infty} e^{t-b_0} {}_pF_q \left( \begin{matrix} a_1, \dots, a_p \\ b_1, \dots, b_q \end{matrix}; \frac{z}{t} \right) dt, \quad c > 0, \Re b_0 > 0.$$

In (16.5.2)–(16.5.4) all many-valued functions in the integrands assume their principal values, and all integration paths are straight lines.

(16.5.2) also holds when  $p = q + 1$ , provided that  $|\text{ph}(1 - z)| < \pi$ . In (16.5.3) the restriction  $\Re z < 1$  can be removed when  $p < q$ . (16.5.4) also holds when  $p = q + 1$ , provided that  $\max(0, \Re z) < c$ . Lastly, the restrictions on the parameters can be eased by replacing the integration paths with loop contours; see Luke (1969a, §3.6).

Laplace transforms and inverse Laplace transforms of generalized hypergeometric functions are given in Prudnikov *et al.* (1992a, §3.38) and Prudnikov *et al.* (1992b, §3.36). For further integral representations and integrals see Apelblat (1983, §16), Erdélyi *et al.* (1953a, §4.6), Erdélyi *et al.* (1954a, §§6.9 and 7.5), Luke (1969a, §3.6), and Prudnikov *et al.* (1990, §§2.22, 4.2.4, and 4.3.1).

### 16.6 Transformations of Variable

#### Quadratic

$$16.6.1 \quad {}_3F_2 \left( \begin{matrix} a, b, c \\ a-b+1, a-c+1 \end{matrix}; z \right) = (1-z)^{-a} {}_3F_2 \left( \begin{matrix} a-b-c+1, \frac{1}{2}a, \frac{1}{2}(a+1) \\ a-b+1, a-c+1 \end{matrix}; \frac{-4z}{(1-z)^2} \right).$$

**Cubic**

$$16.6.2 \quad {}_3F_2\left(\begin{matrix} a, 2b - a - 1, 2 - 2b + a \\ b, a - b + \frac{3}{2} \end{matrix}; \frac{z}{4}\right) = (1 - z)^{-a} {}_3F_2\left(\begin{matrix} \frac{1}{3}a, \frac{1}{3}a + \frac{1}{3}, \frac{1}{3}a + \frac{2}{3} \\ b, a - b + \frac{3}{2} \end{matrix}; \frac{-27z}{4(1 - z)^3}\right).$$

For Kummer-type transformations of  ${}_2F_2$  functions see Miller (2003) and Paris (2005a), and for further transformations see Erdélyi *et al.* (1953a, §4.5).

**16.7 Relations to Other Functions**

For orthogonal polynomials see Chapter 18. For  $3j$ ,  $6j$ ,  $9j$  symbols see Chapter 34. Further representations of special functions in terms of  ${}_pF_q$  functions are given in Luke (1969a, §§6.2–6.3), and an extensive list of  ${}_{q+1}F_q$  functions with rational numbers as parameters is given in Krupnikov and Kölbig (1997).

**16.8 Differential Equations****16.8(i) Classification of Singularities**

An *ordinary point* of the differential equation

$$16.8.1 \quad \frac{d^n w}{dz^n} + f_{n-1}(z) \frac{d^{n-1} w}{dz^{n-1}} + f_{n-2}(z) \frac{d^{n-2} w}{dz^{n-2}} + \cdots + f_1(z) \frac{dw}{dz} + f_0(z) w = 0$$

is a value  $z_0$  of  $z$  at which all the coefficients  $f_j(z)$ ,  $j = 0, 1, \dots, n - 1$ , are analytic. If  $z_0$  is not an ordinary point but  $(z - z_0)^{n-j} f_j(z)$ ,  $j = 0, 1, \dots, n - 1$ , are analytic at  $z = z_0$ , then  $z_0$  is a *regular singularity*. All other singularities are *irregular*. Compare §2.7(i) in the case  $n = 2$ . Similar definitions apply in the case  $z_0 = \infty$ : we transform  $\infty$  into the origin by replacing  $z$  in (16.8.1) by  $1/z$ ; again compare §2.7(i).

For further information see Hille (1976, pp. 360–370).

**16.8(ii) The Generalized Hypergeometric Differential Equation**

With the notation

$$16.8.2 \quad D = \frac{d}{dz}, \quad \vartheta = z \frac{d}{dz},$$

the function  $w = {}_pF_q(\mathbf{a}; \mathbf{b}; z)$  satisfies the differential equation

$$16.8.3 \quad (\vartheta(\vartheta + b_1 - 1) \cdots (\vartheta + b_q - 1) - z(\vartheta + a_1) \cdots (\vartheta + a_p)) w = 0.$$

Equivalently,

$$16.8.4 \quad z^q D^{q+1} w + \sum_{j=1}^q z^{j-1} (\alpha_j z + \beta_j) D^j w + \alpha_0 w = 0, \quad p \leq q,$$

or

$$16.8.5 \quad z^q (1 - z) D^{q+1} w + \sum_{j=1}^q z^{j-1} (\alpha_j z + \beta_j) D^j w + \alpha_0 w = 0, \quad p = q + 1,$$

where  $\alpha_j$  and  $\beta_j$  are constants. Equation (16.8.4) has a regular singularity at  $z = 0$ , and an irregular singularity at  $z = \infty$ , whereas (16.8.5) has regular singularities at  $z = 0, 1$ , and  $\infty$ . In each case there are no other singularities. Equation (16.8.3) is of order  $\max(p, q + 1)$ . In Letessier *et al.* (1994) examples are discussed in which the generalized hypergeometric function satisfies a differential equation that is of order 1 or even 2 less than might be expected.

When no  $b_j$  is an integer, and no two  $b_j$  differ by an integer, a fundamental set of solutions of (16.8.3) is given by

$$16.8.6 \quad w_0(z) = {}_pF_q\left(\begin{matrix} a_1, \dots, a_p \\ b_1, \dots, b_q \end{matrix}; z\right), \quad w_j(z) = z^{1-b_j} {}_pF_q\left(\begin{matrix} 1 + a_1 - b_j, \dots, 1 + a_p - b_j \\ 2 - b_j, 1 + b_1 - b_j, \dots * \dots, 1 + b_q - b_j \end{matrix}; z\right), \quad j = 1, \dots, q,$$

where  $*$  indicates that the entry  $1 + b_j - b_j$  is omitted. For other values of the  $b_j$ , series solutions in powers of  $z$  (possibly involving also  $\ln z$ ) can be constructed via a limiting process; compare §2.7(i) in the case of second-order differential equations. For details see Smith (1939a,b), and Nørlund (1955).

When  $p = q + 1$ , and no two  $a_j$  differ by an integer, another fundamental set of solutions of (16.8.3) is given by

$$16.8.7 \quad \tilde{w}_j(z) = (-z)^{-a_j} {}_{q+1}F_q\left(\begin{matrix} a_j, 1 - b_1 + a_j, \dots, 1 - b_q + a_j \\ 1 - a_1 + a_j, \dots * \dots, 1 - a_{q+1} + a_j \end{matrix}; \frac{1}{z}\right), \quad j = 1, \dots, q + 1,$$

where \* indicates that the entry  $1 - a_j + a_j$  is omitted. We have the connection formula

$$16.8.8 \quad {}_{q+1}F_q \left( \begin{matrix} a_1, \dots, a_{q+1} \\ b_1, \dots, b_q \end{matrix}; z \right) = \sum_{j=1}^{q+1} \left( \prod_{\substack{k=1 \\ k \neq j}}^{q+1} \frac{\Gamma(a_k - a_j)}{\Gamma(a_k)} \right) \left/ \prod_{k=1}^q \frac{\Gamma(b_k - a_j)}{\Gamma(b_k)} \right. \tilde{w}_j(z), \quad |\text{ph}(-z)| \leq \pi.$$

More generally if  $z_0 \in \mathbb{C}$  is an arbitrary constant,  $|z - z_0| > \max(|z_0|, |z_0 - 1|)$ , and  $|\text{ph}(z_0 - z)| < \pi$ , then

$$16.8.9 \quad \begin{aligned} & \left( \prod_{k=1}^{q+1} \Gamma(a_k) \right) \left/ \prod_{k=1}^q \Gamma(b_k) \right. {}_{q+1}F_q \left( \begin{matrix} a_1, \dots, a_{q+1} \\ b_1, \dots, b_q \end{matrix}; z \right) \\ &= \sum_{j=1}^{q+1} (z_0 - z)^{-a_j} \sum_{n=0}^{\infty} \frac{\Gamma(a_j + n)}{n!} \left( \prod_{\substack{k=1 \\ k \neq j}}^{q+1} \Gamma(a_k - a_j - n) \right) \left/ \prod_{k=1}^q \Gamma(b_k - a_j - n) \right. \\ & \times {}_{q+1}F_q \left( \begin{matrix} a_1 - a_j - n, \dots, a_{q+1} - a_j - n \\ b_1 - a_j - n, \dots, b_q - a_j - n \end{matrix}; z_0 \right) (z - z_0)^{-n}. \end{aligned}$$

(Note that the generalized hypergeometric functions on the right-hand side are polynomials in  $z_0$ .)

When  $p = q + 1$  and some of the  $a_j$  differ by an integer a limiting process can again be applied. For details see Nørlund (1955). In this reference it is also explained that in general when  $q > 1$  no simple representations in terms of generalized hypergeometric functions are available for the fundamental solutions near  $z = 1$ . Analytical continuation formulas for  ${}_{q+1}F_q(\mathbf{a}; \mathbf{b}; z)$  near  $z = 1$  are given in Bühring (1987b) for the case  $q = 2$ , and in Bühring (1992) for the general case.

### 16.8(iii) Confluence of Singularities

If  $p \leq q$ , then

$$16.8.10 \quad \lim_{|\alpha| \rightarrow \infty} {}_{p+1}F_q \left( \begin{matrix} a_1, \dots, a_p, \alpha \\ b_1, \dots, b_q \end{matrix}; \frac{z}{\alpha} \right) = {}_pF_q \left( \begin{matrix} a_1, \dots, a_p \\ b_1, \dots, b_q \end{matrix}; z \right).$$

Thus in the case  $p = q$  the regular singularities of the function on the left-hand side at  $\alpha$  and  $\infty$  coalesce into an irregular singularity at  $\infty$ .

Next, if  $p \leq q + 1$  and  $|\text{ph} \beta| \leq \pi - \delta (< \pi)$ , then

$$16.8.11 \quad \lim_{|\beta| \rightarrow \infty} {}_pF_{q+1} \left( \begin{matrix} a_1, \dots, a_p \\ b_1, \dots, b_q, \beta \end{matrix}; \beta z \right) = {}_pF_q \left( \begin{matrix} a_1, \dots, a_p \\ b_1, \dots, b_q \end{matrix}; z \right),$$

provided that in the case  $p = q + 1$  we have  $|z| < 1$  when  $|\text{ph} \beta| \leq \frac{1}{2}\pi$ , and  $|z| < |\sin(\text{ph} \beta)|$  when  $\frac{1}{2}\pi \leq |\text{ph} \beta| \leq \pi - \delta (< \pi)$ .

### 16.9 Zeros

Assume that  $p = q$  and none of the  $a_j$  is a nonpositive integer. Then  ${}_pF_p(\mathbf{a}; \mathbf{b}; z)$  has at most finitely many zeros if and only if the  $a_j$  can be re-indexed for  $j = 1, \dots, p$  in such a way that  $a_j - b_j$  is a nonnegative integer.

Next, assume that  $p = q$  and that the  $a_j$  and the quotients  $(\mathbf{a})_j / (\mathbf{b})_j$  are all real. Then  ${}_pF_p(\mathbf{a}; \mathbf{b}; z)$  has at most finitely many real zeros.

These results are proved in Ki and Kim (2000). For further information on zeros see Hille (1929).

### 16.10 Expansions in Series of ${}_pF_q$ Functions

The following expansion, with appropriate conditions and together with similar results, is given in Fields and Wimp (1961):

$$16.10.1 \quad \begin{aligned} & {}_{p+r}F_{q+s} \left( \begin{matrix} a_1, \dots, a_p, c_1, \dots, c_r \\ b_1, \dots, b_q, d_1, \dots, d_s \end{matrix}; z\zeta \right) \\ &= \sum_{k=0}^{\infty} \frac{(\mathbf{a})_k (\alpha)_k (\beta)_k (-z)^k}{(\mathbf{b})_k (\gamma + k)_k k!} {}_{p+2}F_{q+1} \left( \begin{matrix} \alpha + k, \beta + k, a_1 + k, \dots, a_p + k \\ \gamma + 2k + 1, b_1 + k, \dots, b_q + k \end{matrix}; z \right) {}_{r+2}F_{s+2} \left( \begin{matrix} -k, \gamma + k, c_1, \dots, c_r \\ \alpha, \beta, d_1, \dots, d_s \end{matrix}; \zeta \right). \end{aligned}$$

Here  $\alpha, \beta$ , and  $\gamma$  are free real or complex parameters.

The next expansion is given in Nørlund (1955, equation (1.21)):

$$16.10.2 \quad {}_{p+1}F_p \left( \begin{matrix} a_1, \dots, a_{p+1} \\ b_1, \dots, b_p \end{matrix}; z\zeta \right) = (1-z)^{-a_1} \sum_{k=0}^{\infty} \frac{(a_1)_k}{k!} {}_{p+1}F_p \left( \begin{matrix} -k, a_2, \dots, a_{p+1} \\ b_1, \dots, b_p \end{matrix}; \zeta \right) \left( \frac{z}{z-1} \right)^k.$$

When  $|\zeta - 1| < 1$  the series on the right-hand side converges in the half-plane  $\Re z < \frac{1}{2}$ .

Expansions of the form  $\sum_{n=1}^{\infty} (\pm 1)^n {}_pF_{p+1}(\mathbf{a}; \mathbf{b}; -n^2 z^2)$  are discussed in Miller (1997), and further series of generalized hypergeometric functions are given in Luke (1969b, Chapter 9), Luke (1975, §§5.10.2 and 5.11), and Prudnikov *et al.* (1990, §§5.3, 6.8–6.9).

## 16.11 Asymptotic Expansions

### 16.11(i) Formal Series

For subsequent use we define two formal infinite series,  $E_{p,q}(z)$  and  $H_{p,q}(z)$ , as follows:

$$16.11.1 \quad E_{p,q}(z) = (2\pi)^{(p-q)/2} \kappa^{-\nu-(1/2)} e^{\kappa z^{1/\kappa}} \sum_{k=0}^{\infty} c_k \left( \kappa z^{1/\kappa} \right)^{\nu-k}, \quad p < q+1,$$

$$16.11.2 \quad H_{p,q}(z) = \sum_{m=1}^p \sum_{k=0}^{\infty} \frac{(-1)^k}{k!} \Gamma(a_m + k) \left( \prod_{\substack{\ell=1 \\ \ell \neq m}}^p \Gamma(a_\ell - a_m - k) \right) / \left( \prod_{\ell=1}^q \Gamma(b_\ell - a_m - k) \right) z^{-a_m - k}.$$

In (16.11.1)

$$16.11.3 \quad \kappa = q - p + 1, \quad \nu = a_1 + \dots + a_p - b_1 - \dots - b_q + \frac{1}{2}(q - p),$$

and

$$16.11.4 \quad c_0 = 1, \quad c_k = -\frac{1}{k\kappa^\kappa} \sum_{m=0}^{k-1} c_m e_{k,m}, \quad k \geq 1,$$

where

$$16.11.5 \quad e_{k,m} = \sum_{j=1}^{q+1} (1 - \nu - \kappa b_j + m)_{\kappa+k-m} \left( \prod_{\ell=1}^p (a_\ell - b_j) / \prod_{\substack{\ell=1 \\ \ell \neq j}}^{q+1} (b_\ell - b_j) \right),$$

and  $b_{q+1} = 1$ .

It may be observed that  $H_{p,q}(z)$  represents the sum of the residues of the poles of the integrand in (16.5.1) at  $s = -a_j, -a_j - 1, \dots, j = 1, \dots, p$ , provided that these poles are all simple, that is, no two of the  $a_j$  differ by an integer. (If this condition is violated, then the definition of  $H_{p,q}(z)$  has to be modified so that the residues are those associated with the multiple poles. In consequence, logarithmic terms may appear. See (15.8.8) for an example.)

### 16.11(ii) Expansions for Large Variable

In this subsection we assume that none of  $a_1, a_2, \dots, a_p$  is a nonpositive integer.

#### Case $p = q + 1$

The formal series (16.11.2) for  $H_{q+1,q}(z)$  converges if  $|z| > 1$ , and

$$16.11.6 \quad \left( \prod_{\ell=1}^{q+1} \Gamma(a_\ell) / \prod_{\ell=1}^q \Gamma(b_\ell) \right) {}_{q+1}F_q \left( \begin{matrix} a_1, \dots, a_{q+1} \\ b_1, \dots, b_q \end{matrix}; z \right) = H_{q+1,q}(-z), \quad |\text{ph}(-z)| \leq \pi;$$

compare (16.8.8).

#### Case $p = q$

As  $z \rightarrow \infty$  in  $|\text{ph} z| \leq \pi$ ,

$$16.11.7 \quad \left( \prod_{\ell=1}^q \Gamma(a_\ell) / \prod_{\ell=1}^q \Gamma(b_\ell) \right) {}_qF_q \left( \begin{matrix} a_1, \dots, a_q \\ b_1, \dots, b_q \end{matrix}; z \right) \sim H_{q,q}(ze^{\mp\pi i}) + E_{q,q}(z),$$

where upper or lower signs are chosen according as  $z$  lies in the upper or lower half-plane. (Either sign may be used when  $\text{ph} z = 0$  since the first term on the right-hand side becomes exponentially small compared with the second term.)

For the special case  $a_1 = 1, p = q = 2$  explicit representations for the right-hand side of (16.11.7) in terms of generalized hypergeometric functions are given in Kim (1972).

**Case  $p = q - 1$** As  $z \rightarrow \infty$  in  $|\text{ph } z| \leq \pi$ ,

$$16.11.8 \quad \left( \prod_{\ell=1}^{q-1} \Gamma(a_\ell) / \prod_{\ell=1}^q \Gamma(b_\ell) \right) {}_{q-1}F_q \left( \begin{matrix} a_1, \dots, a_{q-1} \\ b_1, \dots, b_q \end{matrix}; -z \right) \sim H_{q-1,q}(z) + E_{q-1,q}(ze^{-\pi i}) + E_{q-1,q}(ze^{\pi i}).$$

**Case  $p \leq q - 2$** As  $z \rightarrow \infty$  in  $|\text{ph } z| \leq \pi$ ,

$$16.11.9 \quad \left( \prod_{\ell=1}^p \Gamma(a_\ell) / \prod_{\ell=1}^q \Gamma(b_\ell) \right) {}_pF_q \left( \begin{matrix} a_1, \dots, a_p \\ b_1, \dots, b_q \end{matrix}; -z \right) \sim E_{p,q}(ze^{-\pi i}) + E_{p,q}(ze^{\pi i}).$$

**16.11(iii) Expansions for Large Parameters**If  $z$  is fixed and  $|\text{ph}(1-z)| < \pi$ , then for each nonnegative integer  $m$ **16.11.10**

$${}_{p+1}F_p \left( \begin{matrix} a_1 + r, \dots, a_{k-1} + r, a_k, \dots, a_{p+1} \\ b_1 + r, \dots, b_k + r, b_{k+1}, \dots, b_p \end{matrix}; z \right) = \sum_{n=0}^{m-1} \frac{(a_1 + r)_n \cdots (a_{k-1} + r)_n (a_k)_n \cdots (a_{p+1})_n z^n}{(b_1 + r)_n \cdots (b_k + r)_n (b_{k+1})_n \cdots (b_p)_n n!} + O\left(\frac{1}{r^m}\right),$$

as  $r \rightarrow +\infty$ . Here  $k$  can have any integer value from 1 to  $p$ . Also if  $p < q$ , then

$$16.11.11 \quad {}_pF_q \left( \begin{matrix} a_1 + r, \dots, a_p + r \\ b_1 + r, \dots, b_q + r \end{matrix}; z \right) = \sum_{n=0}^{m-1} \frac{(a_1 + r)_n \cdots (a_p + r)_n z^n}{(b_1 + r)_n \cdots (b_q + r)_n n!} + O\left(\frac{1}{r^{(q-p)m}}\right),$$

again as  $r \rightarrow +\infty$ . For these and other results see Knottnerus (1960). See also Luke (1969a, §7.3).Asymptotic expansions for the polynomials  ${}_{p+2}F_q(-r, r + a_0, \mathbf{a}; \mathbf{b}; z)$  as  $r \rightarrow \infty$  through integer values are given in Fields and Luke (1963a,b) and Fields (1965).**16.12 Products**

$$16.12.1 \quad {}_0F_1(-; a; z) {}_0F_1(-; b; z) = {}_2F_3 \left( \begin{matrix} \frac{1}{2}(a+b), \frac{1}{2}(a+b-1) \\ a, b, a+b-1 \end{matrix}; 4z \right).$$

$$16.12.2 \quad \left( {}_2F_1 \left( \begin{matrix} a, b \\ a+b+\frac{1}{2} \end{matrix}; z \right) \right)^2 = {}_3F_2 \left( \begin{matrix} 2a, 2b, a+b \\ a+b+\frac{1}{2}, 2a+2b \end{matrix}; z \right).$$

More generally,

$$16.12.3 \quad \left( {}_2F_1 \left( \begin{matrix} a, b \\ c \end{matrix}; z \right) \right)^2 = \sum_{k=0}^{\infty} \frac{(2a)_k (2b)_k (c - \frac{1}{2})_k}{(c)_k (2c-1)_k k!} {}_4F_3 \left( \begin{matrix} -\frac{1}{2}k, \frac{1}{2}(1-k), a+b-c+\frac{1}{2}, \frac{1}{2} \\ a+\frac{1}{2}, b+\frac{1}{2}, \frac{3}{2}-k-c \end{matrix}; 1 \right) z^k, \quad |z| < 1.$$

For further identities see Goursat (1883) and Erdélyi *et al.* (1953a, §4.3).**Two-Variable Hypergeometric Functions****16.13 Appell Functions**The following four functions of two real or complex variables  $x$  and  $y$  cannot be expressed as a product of two  ${}_2F_1$  functions, in general, but they satisfy partial differential equations that resemble the hypergeometric differential

equation (15.10.1):

$$16.13.1 \quad F_1(\alpha; \beta, \beta'; \gamma; x, y) = \sum_{m,n=0}^{\infty} \frac{(\alpha)_{m+n}(\beta)_m(\beta')_n}{(\gamma)_{m+n}m!n!} x^m y^n, \quad \max(|x|, |y|) < 1,$$

$$16.13.2 \quad F_2(\alpha; \beta, \beta'; \gamma, \gamma'; x, y) = \sum_{m,n=0}^{\infty} \frac{(\alpha)_{m+n}(\beta)_m(\beta')_n}{(\gamma)_m(\gamma')_n m!n!} x^m y^n, \quad |x| + |y| < 1,$$

$$16.13.3 \quad F_3(\alpha, \alpha'; \beta, \beta'; \gamma; x, y) = \sum_{m,n=0}^{\infty} \frac{(\alpha)_m(\alpha')_n(\beta)_m(\beta')_n}{(\gamma)_{m+n}m!n!} x^m y^n, \quad \max(|x|, |y|) < 1,$$

$$16.13.4 \quad F_4(\alpha; \beta; \gamma, \gamma'; x, y) = \sum_{m,n=0}^{\infty} \frac{(\alpha)_{m+n}(\beta)_{m+n}}{(\gamma)_m(\gamma')_n m!n!} x^m y^n, \quad \sqrt{|x|} + \sqrt{|y|} < 1.$$

Here and elsewhere it is assumed that neither of the bottom parameters  $\gamma$  and  $\gamma'$  is a nonpositive integer.

## 16.14 Partial Differential Equations

### 16.14(i) Appell Functions

$$16.14.1 \quad x(1-x) \frac{\partial^2 F_1}{\partial x^2} + y(1-x) \frac{\partial^2 F_1}{\partial x \partial y} + (\gamma - (\alpha + \beta + 1)x) \frac{\partial F_1}{\partial x} - \beta y \frac{\partial F_1}{\partial y} - \alpha \beta F_1 = 0,$$

$$y(1-y) \frac{\partial^2 F_1}{\partial y^2} + x(1-y) \frac{\partial^2 F_1}{\partial x \partial y} + (\gamma - (\alpha + \beta' + 1)y) \frac{\partial F_1}{\partial y} - \beta' x \frac{\partial F_1}{\partial x} - \alpha \beta' F_1 = 0,$$

$$16.14.2 \quad x(1-x) \frac{\partial^2 F_2}{\partial x^2} - xy \frac{\partial^2 F_2}{\partial x \partial y} + (\gamma - (\alpha + \beta + 1)x) \frac{\partial F_2}{\partial x} - \beta y \frac{\partial F_2}{\partial y} - \alpha \beta F_2 = 0,$$

$$y(1-y) \frac{\partial^2 F_2}{\partial y^2} - xy \frac{\partial^2 F_2}{\partial x \partial y} + (\gamma' - (\alpha + \beta' + 1)y) \frac{\partial F_2}{\partial y} - \beta' x \frac{\partial F_2}{\partial x} - \alpha \beta' F_2 = 0,$$

$$16.14.3 \quad x(1-x) \frac{\partial^2 F_3}{\partial x^2} + y \frac{\partial^2 F_3}{\partial x \partial y} + (\gamma - (\alpha + \beta + 1)x) \frac{\partial F_3}{\partial x} - \alpha \beta F_3 = 0,$$

$$y(1-y) \frac{\partial^2 F_3}{\partial y^2} + x \frac{\partial^2 F_3}{\partial x \partial y} + (\gamma - (\alpha' + \beta' + 1)y) \frac{\partial F_3}{\partial y} - \alpha' \beta' F_3 = 0,$$

$$16.14.4 \quad x(1-x) \frac{\partial^2 F_4}{\partial x^2} - 2xy \frac{\partial^2 F_4}{\partial x \partial y} - y^2 \frac{\partial^2 F_4}{\partial y^2} + (\gamma - (\alpha + \beta + 1)x) \frac{\partial F_4}{\partial x} - (\alpha + \beta + 1)y \frac{\partial F_4}{\partial y} - \alpha \beta F_4 = 0,$$

$$y(1-y) \frac{\partial^2 F_4}{\partial y^2} - 2xy \frac{\partial^2 F_4}{\partial x \partial y} - x^2 \frac{\partial^2 F_4}{\partial x^2} + (\gamma' - (\alpha + \beta + 1)y) \frac{\partial F_4}{\partial y} - (\alpha + \beta + 1)x \frac{\partial F_4}{\partial x} - \alpha \beta F_4 = 0.$$

### 16.14(ii) Other Functions

In addition to the four Appell functions there are 24 other sums of double series that cannot be expressed as a product of two  ${}_2F_1$  functions, and which satisfy pairs of linear partial differential equations of the second order. Two examples are provided by

$$16.14.5 \quad G_2(\alpha, \alpha'; \beta, \beta'; x, y) = \sum_{m,n=0}^{\infty} \frac{\Gamma(\alpha + m)\Gamma(\alpha' + n)\Gamma(\beta + n - m)\Gamma(\beta' + m - n)}{\Gamma(\alpha)\Gamma(\alpha')\Gamma(\beta)\Gamma(\beta')} \frac{x^m y^n}{m!n!}, \quad |x| < 1, |y| < 1,$$

$$16.14.6 \quad G_3(\alpha, \alpha'; x, y) = \sum_{m,n=0}^{\infty} \frac{\Gamma(\alpha + 2n - m)\Gamma(\alpha' + 2m - n)}{\Gamma(\alpha)\Gamma(\alpha')} \frac{x^m y^n}{m!n!}, \quad |x| + |y| < \frac{1}{4}.$$

(The region of convergence  $|x| + |y| < \frac{1}{4}$  is not quite maximal.) See Erdélyi *et al.* (1953a, §§5.7.1–5.7.2) for further information.

### 16.15 Integral Representations and Integrals

$$16.15.1 \quad F_1(\alpha; \beta, \beta'; \gamma; x, y) = \frac{\Gamma(\gamma)}{\Gamma(\alpha)\Gamma(\gamma-\alpha)} \int_0^1 \frac{u^{\alpha-1}(1-u)^{\gamma-\alpha-1}}{(1-ux)^\beta(1-uy)^{\beta'}} du, \quad \Re\alpha > 0, \Re(\gamma-\alpha) > 0,$$

$$16.15.2 \quad F_2(\alpha; \beta, \beta'; \gamma, \gamma'; x, y) = \frac{\Gamma(\gamma)\Gamma(\gamma')}{\Gamma(\beta)\Gamma(\beta')\Gamma(\gamma-\beta)\Gamma(\gamma'-\beta')} \int_0^1 \int_0^1 \frac{u^{\beta-1}v^{\beta'-1}(1-u)^{\gamma-\beta-1}(1-v)^{\gamma'-\beta'-1}}{(1-ux-vy)^\alpha} du dv, \\ \Re\gamma > \Re\beta > 0, \Re\gamma' > \Re\beta' > 0,$$

$$16.15.3 \quad F_3(\alpha, \alpha'; \beta, \beta'; \gamma; x, y) = \frac{\Gamma(\gamma)}{\Gamma(\beta)\Gamma(\beta')\Gamma(\gamma-\beta-\beta')} \iint_{\Delta} \frac{u^{\beta-1}v^{\beta'-1}(1-u-v)^{\gamma-\beta-\beta'-1}}{(1-ux)^\alpha(1-vy)^{\alpha'}} du dv, \\ \Re(\gamma-\beta-\beta') > 0, \Re\beta > 0, \Re\beta' > 0,$$

where  $\Delta$  is the triangle defined by  $u \geq 0, v \geq 0, u + v \leq 1$ .

$$16.15.4 \quad F_4(\alpha; \beta; \gamma, \gamma'; x(1-y), y(1-x)) \\ = \frac{\Gamma(\gamma)\Gamma(\gamma')}{\Gamma(\alpha)\Gamma(\beta)\Gamma(\gamma-\alpha)\Gamma(\gamma'-\beta)} \int_0^1 \int_0^1 \frac{u^{\alpha-1}v^{\beta-1}(1-u)^{\gamma-\alpha-1}(1-v)^{\gamma'-\beta-1}}{(1-ux)^{\gamma+\gamma'-\alpha-1}(1-vy)^{\gamma+\gamma'-\beta-1}(1-ux-vy)^{\alpha+\beta-\gamma-\gamma'+1}} du dv, \\ \Re\gamma > \Re\alpha > 0, \Re\gamma' > \Re\beta > 0.$$

For these and other formulas, including double Mellin–Barnes integrals, see Erdélyi *et al.* (1953a, §5.8). These representations can be used to derive analytic continuations of the Appell functions, including convergent series expansions for large  $x$ , large  $y$ , or both. For inverse Laplace transforms of Appell functions see Prudnikov *et al.* (1992b, §3.40).

### 16.16 Transformations of Variables

#### 16.16(i) Reduction Formulas

$$16.16.1 \quad F_1(\alpha; \beta, \beta'; \beta + \beta'; x, y) = (1-y)^{-\alpha} {}_2F_1\left(\begin{matrix} \alpha, \beta \\ \beta + \beta' \end{matrix}; \frac{x-y}{1-y}\right),$$

$$16.16.2 \quad F_2(\alpha; \beta, \beta'; \gamma, \beta'; x, y) = (1-y)^{-\alpha} {}_2F_1\left(\begin{matrix} \alpha, \beta \\ \gamma \end{matrix}; \frac{x}{1-y}\right),$$

$$16.16.3 \quad F_2(\alpha; \beta, \beta'; \gamma, \alpha; x, y) = (1-y)^{-\beta'} F_1\left(\beta; \alpha - \beta', \beta'; \gamma; x, \frac{x}{1-y}\right),$$

$$16.16.4 \quad F_3(\alpha, \gamma - \alpha; \beta, \beta'; \gamma; x, y) = (1-y)^{-\beta'} F_1\left(\alpha; \beta, \beta'; \gamma; x, \frac{y}{y-1}\right),$$

$$16.16.5 \quad F_3(\alpha, \gamma - \alpha; \beta, \gamma - \beta; \gamma; x, y) = (1-y)^{\alpha+\beta-\gamma} {}_2F_1\left(\begin{matrix} \alpha, \beta \\ \gamma \end{matrix}; x + y - xy\right),$$

$$16.16.6 \quad F_4(\alpha; \beta; \gamma, \alpha + \beta - \gamma + 1; x(1-y), y(1-x)) = {}_2F_1\left(\begin{matrix} \alpha, \beta \\ \gamma \end{matrix}; x\right) {}_2F_1\left(\begin{matrix} \alpha, \beta \\ \alpha + \beta - \gamma + 1 \end{matrix}; y\right).$$

See Erdélyi *et al.* (1953a, §5.10) for these and further reduction formulas. An extension of (16.16.6) is given by

$$16.16.7 \quad F_4(\alpha; \beta; \gamma, \gamma'; x(1-y), y(1-x)) \\ = \sum_{k=0}^{\infty} \frac{(\alpha)_k(\beta)_k(\alpha + \beta - \gamma - \gamma' + 1)_k x^k y^k}{(\gamma)_k(\gamma')_k k!} {}_2F_1\left(\begin{matrix} \alpha + k, \beta + k \\ \gamma + k \end{matrix}; x\right) {}_2F_1\left(\begin{matrix} \alpha + k, \beta + k \\ \gamma' + k \end{matrix}; y\right);$$

see Burchnall and Chaundy (1940, 1941).

#### 16.16(ii) Other Transformations

$$16.16.8 \quad F_1(\alpha; \beta, \beta'; \gamma; x, y) = (1-x)^{-\beta}(1-y)^{-\beta'} F_1\left(\gamma - \alpha; \beta, \beta'; \gamma; \frac{x}{x-1}, \frac{y}{y-1}\right) \\ = (1-x)^{-\alpha} F_1\left(\alpha; \gamma - \beta - \beta', \beta'; \gamma; \frac{x}{x-1}, \frac{y-x}{1-x}\right),$$

16.16.9 
$$F_2(\alpha; \beta, \beta'; \gamma, \gamma'; x, y) = (1-x)^{-\alpha} F_2\left(\alpha; \gamma - \beta, \beta'; \gamma, \gamma'; \frac{x}{x-1}, \frac{y}{1-x}\right),$$

16.16.10 
$$F_4(\alpha; \beta; \gamma, \gamma'; x, y) = \frac{\Gamma(\gamma')\Gamma(\beta - \alpha)}{\Gamma(\gamma' - \alpha)\Gamma(\beta)} (-y)^{-\alpha} F_4\left(\alpha; \alpha - \gamma' + 1; \gamma, \alpha - \beta + 1; \frac{x}{y}, \frac{1}{y}\right) + \frac{\Gamma(\gamma')\Gamma(\alpha - \beta)}{\Gamma(\gamma' - \beta)\Gamma(\alpha)} (-y)^{-\beta} F_4\left(\beta; \beta - \gamma' + 1; \gamma, \beta - \alpha + 1; \frac{x}{y}, \frac{1}{y}\right).$$

For quadratic transformations of Appell functions see Carlson (1976).

## Meijer $G$ -Function

### 16.17 Definition

Again assume  $a_1, a_2, \dots, a_p$  and  $b_1, b_2, \dots, b_q$  are real or complex parameters. Assume also that  $m$  and  $n$  are integers such that  $0 \leq m \leq q$  and  $0 \leq n \leq p$ , and none of  $a_k - b_j$  is a positive integer when  $1 \leq k \leq n$  and  $1 \leq j \leq m$ . Then the Meijer  $G$ -function is defined via the Mellin–Barnes integral representation:

16.17.1 
$$G_{p,q}^{m,n}(z; \mathbf{a}; \mathbf{b}) = G_{p,q}^{m,n}\left(z; \begin{matrix} a_1, \dots, a_p \\ b_1, \dots, b_q \end{matrix}\right) = \frac{1}{2\pi i} \int_L \left( \prod_{\ell=1}^m \Gamma(b_\ell - s) \prod_{\ell=1}^n \Gamma(1 - a_\ell + s) \right) / \left( \prod_{\ell=m}^{q-1} \Gamma(1 - b_{\ell+1} + s) \prod_{\ell=n}^{p-1} \Gamma(a_{\ell+1} - s) \right) z^s ds,$$

where the integration path  $L$  separates the poles of the factors  $\Gamma(b_\ell - s)$  from those of the factors  $\Gamma(1 - a_\ell + s)$ . There are three possible choices for  $L$ , illustrated in Figure 16.17.1 in the case  $m = 1, n = 2$ :

- (i)  $L$  goes from  $-\infty$  to  $i\infty$ . The integral converges if  $p + q < 2(m + n)$  and  $|\text{ph } z| < (m + n - \frac{1}{2}(p + q))\pi$ .
- (ii)  $L$  is a loop that starts at infinity on a line parallel to the positive real axis, encircles the poles of the  $\Gamma(b_\ell - s)$  once in the negative sense and returns to infinity on another line parallel to the positive real axis. The integral converges for all  $z (\neq 0)$  if  $p < q$ , and for  $0 < |z| < 1$  if  $p = q \geq 1$ .
- (iii)  $L$  is a loop that starts at infinity on a line parallel to the negative real axis, encircles the poles of the  $\Gamma(1 - a_\ell + s)$  once in the positive sense and returns to infinity on another line parallel to the negative real axis. The integral converges for all  $z$  if  $p > q$ , and for  $|z| > 1$  if  $p = q \geq 1$ .

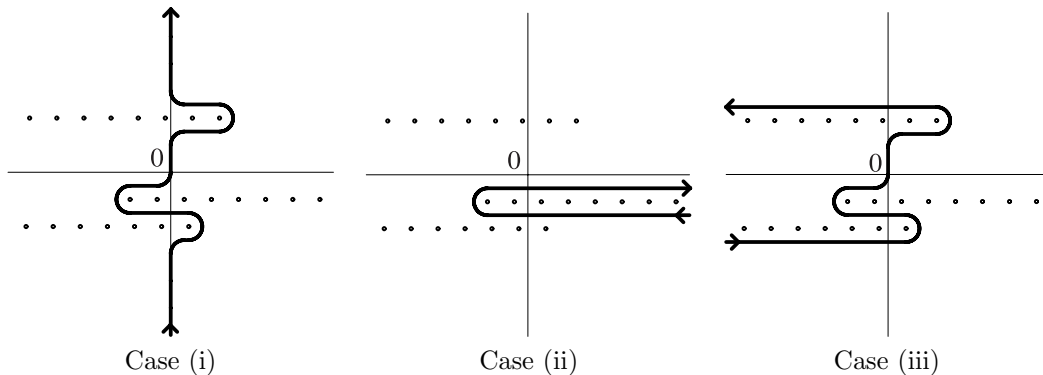


Figure 16.17.1:  $s$ -plane. Path  $L$  for the integral representation (16.17.1) of the Meijer  $G$ -function.

When more than one of Cases (i), (ii), and (iii) is applicable the same value is obtained for the Meijer  $G$ -function.

Assume  $p \leq q$ , no two of the bottom parameters  $b_j, j = 1, \dots, m$ , differ by an integer, and  $a_j - b_k$  is not a positive integer when  $j = 1, 2, \dots, n$  and  $k = 1, 2, \dots, m$ . Then

16.17.2 
$$G_{p,q}^{m,n}\left(z; \begin{matrix} a_1, \dots, a_p \\ b_1, \dots, b_q \end{matrix}\right) = \sum_{k=1}^m A_{p,q,k}^{m,n}(z) {}_pF_{q-1}\left(\begin{matrix} 1 + b_k - a_1, \dots, 1 + b_k - a_p \\ 1 + b_k - b_1, \dots, 1 + b_k - b_q \end{matrix}; (-1)^{p-m-n} z\right),$$



where \* indicates that the entry  $1 + b_k - b_k$  is omitted. Also,

$$16.17.3 \quad A_{p,q,k}^{m,n}(z) = \prod_{\substack{\ell=1 \\ \ell \neq k}}^m \Gamma(b_\ell - b_k) \prod_{\ell=1}^n \Gamma(1 + b_k - a_\ell) z^{b_k} / \left( \prod_{\ell=m}^{q-1} \Gamma(1 + b_k - b_{\ell+1}) \prod_{\ell=n}^{p-1} \Gamma(a_{\ell+1} - b_k) \right).$$

## 16.18 Special Cases

The  ${}_1F_1$  and  ${}_2F_1$  functions introduced in Chapters 13 and 15, as well as the more general  ${}_pF_q$  functions introduced in the present chapter, are all special cases of the Meijer  $G$ -function. This is a consequence of the following relations:

$$16.18.1 \quad {}_pF_q \left( \begin{matrix} a_1, \dots, a_p \\ b_1, \dots, b_q \end{matrix}; z \right) = \left( \prod_{k=1}^q \Gamma(b_k) / \prod_{k=1}^p \Gamma(a_k) \right) G_{p,q+1}^{1,p} \left( -z; \begin{matrix} 1 - a_1, \dots, 1 - a_p \\ 0, 1 - b_1, \dots, 1 - b_q \end{matrix} \right) \\ = \left( \prod_{k=1}^q \Gamma(b_k) / \prod_{k=1}^p \Gamma(a_k) \right) G_{q+1,p}^{p,1} \left( -\frac{1}{z}; \begin{matrix} 1, b_1, \dots, b_q \\ a_1, \dots, a_p \end{matrix} \right).$$

As a corollary, special cases of the  ${}_1F_1$  and  ${}_2F_1$  functions, including Airy functions, Bessel functions, parabolic cylinder functions, Ferrers functions, associated Legendre functions, and many orthogonal polynomials, are all special cases of the Meijer  $G$ -function. Representations of special functions in terms of the Meijer  $G$ -function are given in Erdélyi *et al.* (1953a, §5.6), Luke (1969a, §§6.4–6.5), and Mathai (1993, §3.10).

## 16.19 Identities

$$16.19.1 \quad G_{p,q}^{m,n} \left( \frac{1}{z}; \begin{matrix} a_1, \dots, a_p \\ b_1, \dots, b_q \end{matrix} \right) = G_{q,p}^{m,n} \left( z; \begin{matrix} 1 - b_1, \dots, 1 - b_q \\ 1 - a_1, \dots, 1 - a_p \end{matrix} \right),$$

$$16.19.2 \quad z^\mu G_{p,q}^{m,n} \left( z; \begin{matrix} a_1, \dots, a_p \\ b_1, \dots, b_q \end{matrix} \right) = G_{p,q}^{m,n} \left( z; \begin{matrix} a_1 + \mu, \dots, a_p + \mu \\ b_1 + \mu, \dots, b_q + \mu \end{matrix} \right),$$

$$16.19.3 \quad G_{p+1,q+1}^{m,n+1} \left( z; \begin{matrix} a_0, \dots, a_p \\ b_1, \dots, b_q, a_0 \end{matrix} \right) = G_{p,q}^{m,n} \left( z; \begin{matrix} a_1, \dots, a_p \\ b_1, \dots, b_q \end{matrix} \right),$$

$$16.19.4 \quad G_{p,q}^{m,n} \left( z; \begin{matrix} a_1, \dots, a_p \\ b_1, \dots, b_q \end{matrix} \right) = \frac{2^{p+1+b_1+\dots+b_q-m-n-a_1-\dots-a_p}}{\pi^{m+n-\frac{1}{2}(p+q)}} G_{2p,2q}^{2m,2n} \left( 2^{2p-2q} z^2; \begin{matrix} \frac{1}{2}a_1, \frac{1}{2}a_1 + \frac{1}{2}, \dots, \frac{1}{2}a_p, \frac{1}{2}a_p + \frac{1}{2} \\ \frac{1}{2}b_1, \frac{1}{2}b_1 + \frac{1}{2}, \dots, \frac{1}{2}b_q, \frac{1}{2}b_q + \frac{1}{2} \end{matrix} \right),$$

$$16.19.5 \quad \vartheta G_{p,q}^{m,n} \left( z; \begin{matrix} a_1, \dots, a_p \\ b_1, \dots, b_q \end{matrix} \right) = G_{p,q}^{m,n} \left( z; \begin{matrix} a_1 - 1, a_2, \dots, a_p \\ b_1, \dots, b_q \end{matrix} \right) + (a_1 - 1) G_{p,q}^{m,n} \left( z; \begin{matrix} a_1, \dots, a_p \\ b_1, \dots, b_q \end{matrix} \right),$$

$$16.19.6 \quad \int_0^1 t^{-a_0} (1-t)^{a_0-b_{q+1}-1} G_{p,q}^{m,n} \left( zt; \begin{matrix} a_1, \dots, a_p \\ b_1, \dots, b_q \end{matrix} \right) dt = \Gamma(a_0 - b_{q+1}) G_{p+1,q+1}^{m,n+1} \left( z; \begin{matrix} a_0, \dots, a_p \\ b_1, \dots, b_{q+1} \end{matrix} \right),$$

where again  $\vartheta = z d/dz$ . For conditions for (16.19.6) see Luke (1969a, Chapter 5). This reference and Mathai (1993, §§2.2 and 2.4) also supply additional identities.

## 16.20 Integrals and Series

Integrals of the Meijer  $G$ -function are given in Apelblat (1983, §19), Erdélyi *et al.* (1953a, §5.5.2), Erdélyi *et al.* (1954a, §§6.9 and 7.5), Luke (1969a, §3.6), Luke (1975, §5.6), Mathai (1993, §3.10), and Prudnikov *et al.* (1990, §2.24). Extensive lists of Laplace transforms and inverse Laplace transforms of the Meijer  $G$ -function are given in Prudnikov *et al.* (1992a, §3.40) and Prudnikov *et al.* (1992b, §3.38).

Series of the Meijer  $G$ -function are given in Erdélyi *et al.* (1953a, §5.5.1), Luke (1975, §5.8), and Prudnikov *et al.* (1990, §6.11).

## 16.21 Differential Equation

$w = G_{p,q}^{m,n}(z; \mathbf{a}; \mathbf{b})$  satisfies the differential equation

$$16.21.1 \quad ((-1)^{p-m-n} z(\vartheta - a_1 + 1) \cdots (\vartheta - a_p + 1) - (\vartheta - b_1) \cdots (\vartheta - b_q)) w = 0,$$

where again  $\vartheta = z d/dz$ . This equation is of order  $\max(p, q)$ . In consequence of (16.19.1) we may assume, without loss of generality, that  $p \leq q$ . With the classification of §16.8(i), when  $p < q$  the only singularities of (16.21.1) are a regular singularity at  $z = 0$  and an irregular singularity at  $z = \infty$ . When  $p = q$  the only singularities of (16.21.1) are regular singularities at  $z = 0$ ,  $(-1)^{p-m-n}$ , and  $\infty$ .

A fundamental set of solutions of (16.21.1) is given by

$$16.21.2 \quad G_{p,q}^{1,p} \left( z e^{(p-m-n-1)\pi i}, \begin{matrix} a_1, \dots, a_p \\ b_j, b_1, \dots, b_{j-1}, b_{j+1}, \dots, b_q \end{matrix} \right), \quad j = 1, \dots, q.$$

For other fundamental sets see Erdélyi *et al.* (1953a, §5.4) and Marichev (1984).

## 16.22 Asymptotic Expansions

Asymptotic expansions of  $G_{p,q}^{m,n}(z; \mathbf{a}; \mathbf{b})$  for large  $z$  are given in Luke (1969a, §§5.7 and 5.10) and Luke (1975, §5.9). For asymptotic expansions of Meijer  $G$ -functions with large parameters see Fields (1973, 1983).

## Applications

### 16.23 Mathematical Applications

#### 16.23(i) Differential Equations

A variety of problems in classical mechanics and mathematical physics lead to Picard–Fuchs equations. These equations are frequently solvable in terms of generalized hypergeometric functions, and the monodromy of generalized hypergeometric functions plays an important role in describing properties of the solutions. See, for example, Berglund *et al.* (1994).

#### 16.23(ii) Random Graphs

A substantial transition occurs in a random graph of  $n$  vertices when the number of edges becomes approximately  $\frac{1}{2}n$ . In Janson *et al.* (1993) limiting distributions are discussed for the sparse connected components of these graphs, and the asymptotics of three  ${}_2F_2$  functions are applied to compute the expected value of the excess.

#### 16.23(iii) Conformal Mapping

The Bieberbach conjecture states that if  $\sum_{n=0}^{\infty} a_n z^n$  is a conformal map of the unit disk to any complex domain, then  $|a_n| \leq n|a_1|$ . In the proof of this conjecture de Branges (1985) uses the inequality

$$16.23.1 \quad {}_3F_2 \left( \begin{matrix} -n, n + \alpha + 2, \frac{1}{2}(\alpha + 1) \\ \alpha + 1, \frac{1}{2}(\alpha + 3) \end{matrix}; x \right) > 0,$$

when  $0 \leq x < 1$ ,  $\alpha > -2$ , and  $n = 0, 1, 2, \dots$ . The proof of this inequality is given in Askey and Gasper (1976). See also Kazarinoff (1988).

#### 16.23(iv) Combinatorics and Number Theory

Many combinatorial identities, especially ones involving binomial and related coefficients, are special cases of hypergeometric identities. In Petkovšek *et al.* (1996) tools are given for automated proofs of these identities.

## 16.24 Physical Applications

### 16.24(i) Random Walks

Generalized hypergeometric functions and Appell functions appear in the evaluation of the so-called Watson integrals which characterize the simplest possible lattice walks. They are also potentially useful for the solution of more complicated restricted lattice walk problems, and the 3D Ising model; see Barber and Ninham (1970, pp. 147–148).

### 16.24(ii) Loop Integrals in Feynman Diagrams

Appell functions are used for the evaluation of one-loop integrals in Feynman diagrams. See Cabral-Rosetti and Sanchis-Lozano (2000).

For an extension to two-loop integrals see Moch *et al.* (2002).

### 16.24(iii) $3j$ , $6j$ , and $9j$ Symbols

The  $3j$  symbols, or Clebsch–Gordan coefficients, play an important role in the decomposition of reducible representations of the rotation group into irreducible representations. They can be expressed as  ${}_3F_2$  functions with unit argument. The coefficients of transformations between different coupling schemes of three angular momenta are related to the Wigner  $6j$  symbols. These are balanced  ${}_4F_3$  functions with unit argument. Lastly, special cases of the  $9j$  symbols are  ${}_5F_4$  functions with unit argument. For further information see Chapter 34 and Varshalovich *et al.* (1988, §§8.2.5, 8.8, and 9.2.3).

## Computation

### 16.25 Methods of Computation

Methods for computing the functions of the present chapter include power series, asymptotic expansions, integral representations, differential equations, and recurrence relations. They are similar to those described for confluent hypergeometric functions, and hypergeometric functions in §§13.29 and 15.19. There is, however, an added feature in the numerical solution of differential equations and difference equations (recurrence relations). This occurs when the wanted solution is intermediate in asymptotic growth compared with other solutions. In these cases integration, or recurrence, in either a forward or a backward direction is unstable. Instead a boundary-value problem needs to be formulated and solved. See §§3.6(vii), 3.7(iii), Olde Daalhuis and Olver (1998), Lozier (1980), and Wimp (1984, Chapters 7, 8).

### 16.26 Approximations

For discussions of the approximation of generalized hypergeometric functions and the Meijer  $G$ -function in terms of polynomials, rational functions, and Chebyshev polynomials see Luke (1975, §§5.12 - 5.13) and Luke (1977b, Chapters 1 and 9).

### 16.27 Software

See <http://dlmf.nist.gov/16.27>.

## References

### General References

The main references used in writing this chapter are Erdélyi *et al.* (1953a), Luke (1969a, 1975). For additional bibliographic reading see Andrews *et al.* (1999) and Slater (1966).

### Sources

The following list gives the references or other indications of proofs that were used in constructing the various sections of this chapter. These sources supplement the references that are quoted in the text.

§16.2 Luke (1975, Chapter 5), Slater (1966, Chapter 2). The statement that follows (16.2.5) follows from the uniform convergence of (16.2.5) when  $p \leq q$ , and also when  $p = q + 1$  provided that  $|z| < 1$ . For other values of  $z$ , apply the straightforward generalization (to higher-order differential equations) of Theorem 3.2 in Olver (1997b, Chapter 5).

§16.3 Luke (1975, §5.2.2), Rainville (1960, §48). For (16.3.5) see Fleury and Turbiner (1994).

§16.4 Andrews *et al.* (1999, Chapters 2 and 3), Slater (1966, Chapters 2 and 6). For (16.4.13) see Donovan *et al.* (1999).

§16.5 Luke (1969a, §3.6). To justify the last sentence in the third paragraph, translate the integration contour  $L$  in (16.5.1) to the right, then apply the residue theorem (§1.10(iv)) making use of the estimate (5.11.9) for the gamma function; compare §2.4(ii).

§16.6 For (16.6.1) see Whipple (1927). For (16.6.2) see Bailey (1929).

§16.8 Luke (1969a, §§3.5 and 5.1). For (16.8.9) see Bühring (1988).

§16.11 Paris and Kaminski (2001, §2.3), Wright (1940a, p. 391), Meijer (1946, p. 1172), Luke (1969a, Chapter 7).

§16.12 Erdélyi *et al.* (1953a, §4.3). For (16.12.1) see Bailey (1928). For (16.12.2) see Clausen (1828). For (16.12.3) see Chaundy (1969, Chapter 12, Problem 12).

§16.13 Erdélyi *et al.* (1953a, §5.7).

§16.14 Erdélyi *et al.* (1953a, §5.9).

§16.16 Erdélyi *et al.* (1953a, §5.11).

§16.17 Luke (1969a, Chapter 5).

§16.18 Luke (1969a, Chapter 5).

§16.19 These results are straightforward consequences of the definition (16.17.1).

§16.21 Luke (1969a, Chapter 5).

## Chapter 17

# $q$ -Hypergeometric and Related Functions

G. E. Andrews<sup>1</sup>

<b>Notation</b>	<b>420</b>	17.12 Bailey Pairs . . . . .	430
17.1 Special Notation . . . . .	420	17.13 Integrals . . . . .	431
<b>Properties</b>	<b>420</b>	17.14 Constant Term Identities . . . . .	431
17.2 Calculus . . . . .	420	17.15 Generalizations . . . . .	432
17.3 $q$ -Elementary and $q$ -Special Functions . . . . .	422	<b>Applications</b>	<b>432</b>
17.4 Basic Hypergeometric Functions . . . . .	423	17.16 Mathematical Applications . . . . .	432
17.5 ${}_0\phi_0, {}_1\phi_0, {}_1\phi_1$ Functions . . . . .	423	17.17 Physical Applications . . . . .	432
17.6 ${}_2\phi_1$ Function . . . . .	424	<b>Computation</b>	<b>432</b>
17.7 Special Cases of Higher ${}_r\phi_s$ Functions . . . . .	426	17.18 Methods of Computation . . . . .	432
17.8 Special Cases of ${}_r\psi_r$ Functions . . . . .	427	17.19 Software . . . . .	432
17.9 Transformations of Higher ${}_r\phi_r$ Functions . . . . .	428	<b>References</b>	<b>432</b>
17.10 Transformations of ${}_r\psi_r$ Functions . . . . .	429		
17.11 Transformations of $q$ -Appell Functions . . . . .	430		

<sup>1</sup>Department of Mathematics, Pennsylvania State University, University Park, Pennsylvania.  
Copyright © 2009 National Institute of Standards and Technology. All rights reserved.

## Notation

### 17.1 Special Notation

(For other notation see pp. xiv and 873.)

$k, j, m, n, r, s$	nonnegative integers.
$z$	complex variable.
$x$	real variable.
$q (\in \mathbb{C})$	base: unless stated otherwise $ q  < 1$ .
$(a; q)_n$	$q$ -shifted factorial: $(1 - a)(1 - aq) \cdots (1 - aq^{n-1})$ .

The main functions treated in this chapter are the basic hypergeometric (or  $q$ -hypergeometric) function  ${}_r\phi_s(a_1, a_2, \dots, a_r; b_1, b_2, \dots, b_s; q, z)$ , the bilateral basic hypergeometric (or bilateral  $q$ -hypergeometric) function  ${}_r\psi_s(a_1, a_2, \dots, a_r; b_1, b_2, \dots, b_s; q, z)$ , and the  $q$ -analogs of the Appell functions  $\Phi^{(1)}(a; b, b'; c; x, y)$ ,  $\Phi^{(2)}(a; b, b'; c, c'; x, y)$ ,  $\Phi^{(3)}(a, a'; b, b'; c; x, y)$ , and  $\Phi^{(4)}(a; b; c, c'; x, y)$ .

Another function notation used is the “idem” function:

$$\begin{aligned} & f(\chi_1; \chi_2, \dots, \chi_n) + \text{idem}(\chi_1; \chi_2, \dots, \chi_n) \\ &= \sum_{j=1}^n f(\chi_j; \chi_1, \chi_2, \dots, \chi_{j-1}, \chi_{j+1}, \dots, \chi_n). \end{aligned}$$

These notations agree with Gasper and Rahman (2004) (except for the  $q$ -Appell functions which are not considered in this reference). A slightly different notation is that in Bailey (1935) and Slater (1966); see §17.4(i). Fine (1988) uses  $F(a, b; t : q)$  for a particular specialization of a  ${}_2\phi_1$  function.

## Properties

### 17.2 Calculus

#### 17.2(i) $q$ -Calculus

For  $n = 0, 1, 2, \dots$ ,

$$17.2.1 \quad (a; q)_n = (1 - a)(1 - aq) \cdots (1 - aq^{n-1}),$$

$$17.2.2 \quad (a; q)_{-n} = \frac{1}{(aq^{-n}; q)_n} = \frac{(-q/a)^n q^{\binom{n}{2}}}{(q/a; q)_n}.$$

For  $\nu \in \mathbb{C}$

$$17.2.3 \quad (a; q)_\nu = \prod_{j=0}^{\infty} \left( \frac{1 - aq^j}{1 - aq^{\nu+j}} \right),$$

when this product converges.

$$17.2.4 \quad (a; q)_\infty = \prod_{j=0}^{\infty} (1 - aq^j),$$

$$17.2.5 \quad (a_1, a_2, \dots, a_r; q)_n = \prod_{j=1}^r (a_j; q)_n,$$

$$17.2.6 \quad (a_1, a_2, \dots, a_r; q)_\infty = \prod_{j=1}^r (a_j; q)_\infty.$$

$$17.2.7 \quad (a; q^{-1})_n = (a^{-1}; q)_n (-a)^n q^{-\binom{n}{2}},$$

$$17.2.8 \quad \frac{(a; q^{-1})_n}{(b; q^{-1})_n} = \frac{(a^{-1}; q)_n}{(b^{-1}; q)_n} \left( \frac{a}{b} \right)^n,$$

$$17.2.9 \quad (a; q)_n = (q^{1-n}/a; q)_n (-a)^n q^{\binom{n}{2}},$$

$$17.2.10 \quad \frac{(a; q)_n}{(b; q)_n} = \frac{(q^{1-n}/a; q)_n}{(q^{1-n}/b; q)_n} \left( \frac{a}{b} \right)^n,$$

$$17.2.11 \quad (aq^{-n}; q)_n = (q/a; q)_n \left( -\frac{a}{q} \right)^n q^{-\binom{n}{2}},$$

$$17.2.12 \quad \frac{(aq^{-n}; q)_n}{(bq^{-n}; q)_n} = \frac{(q/a; q)_n}{(q/b; q)_n} \left( \frac{a}{b} \right)^n.$$

$$17.2.13 \quad (a; q)_{n-k} = \frac{(a; q)_n}{(q^{1-n}/a; q)_k} \left( -\frac{q}{a} \right)^k q^{\binom{k}{2} - nk},$$

$$17.2.14 \quad \frac{(a; q)_{n-k}}{(b; q)_{n-k}} = \frac{(a; q)_n}{(b; q)_n} \frac{(q^{1-n}/b; q)_k}{(q^{1-n}/a; q)_k} \left( \frac{b}{a} \right)^k,$$

$$17.2.15 \quad (aq^{-n}; q)_k = \frac{(a; q)_k (q/a; q)_n}{(q^{1-k}/a; q)_n} q^{-nk},$$

$$17.2.16 \quad (aq^{-n}; q)_{n-k} = \frac{(q/a; q)_n}{(q/a; q)_k} \left( -\frac{a}{q} \right)^{n-k} q^{\binom{k}{2} - \binom{n}{2}},$$

$$17.2.17 \quad (aq^n; q)_k = \frac{(a; q)_k (aq^k; q)_n}{(a; q)_n},$$

$$17.2.18 \quad (aq^k; q)_{n-k} = \frac{(a; q)_n}{(a; q)_k}.$$

$$17.2.19 \quad (a; q)_{2n} = (a, aq; q^2)_n,$$

more generally,

$$17.2.20 \quad (a; q)_{kn} = (a, aq, \dots, aq^{k-1}; q^k)_n.$$

$$17.2.21 \quad (a^2; q^2)_n = (a; q)_n (-a; q)_n,$$

$$17.2.22 \quad \frac{(qa^{\frac{1}{2}}, -aq^{\frac{1}{2}}; q)_n}{(a^{\frac{1}{2}}, -a^{\frac{1}{2}}; q)_n} = \frac{(aq^2; q^2)_n}{(a; q^2)_n} = \frac{1 - aq^{2n}}{1 - a},$$

more generally,

$$17.2.23 \quad \frac{(aq^{\frac{1}{k}}, q\omega_k a^{\frac{1}{k}}, \dots, q\omega_k^{k-1} a^{\frac{1}{k}}; q)_n}{(a^{\frac{1}{k}}, \omega_k a^{\frac{1}{k}}, \dots, \omega_k^{k-1} a^{\frac{1}{k}}; q)_n} = \frac{(aq^k; q^k)_n}{(a; q^k)_n} = \frac{1 - aq^{kn}}{1 - a},$$

where  $\omega_k = e^{2\pi i/k}$ .

**17.2.24**

$$\lim_{\tau \rightarrow 0} (a/\tau; q)_n \tau^n = \lim_{\sigma \rightarrow \infty} (a\sigma; q)_n \sigma^{-n} = (-a)^n q^{\binom{n}{2}},$$

**17.2.25**  $\lim_{\tau \rightarrow 0} \frac{(a/\tau; q)_n}{(b/\tau; q)_n} = \lim_{\sigma \rightarrow \infty} \frac{(a\sigma; q)_n}{(b\sigma; q)_n} = \left(\frac{a}{b}\right)^n,$

**17.2.26**  $\lim_{\tau \rightarrow 0} \frac{(a/\tau; q)_n (b/\tau; q)_n}{(c/\tau^2; q)_n} = (-1)^n \left(\frac{ab}{c}\right)^n q^{\binom{n}{2}}.$

**17.2(ii) Binomial Coefficients**

**17.2.27** 
$$\begin{aligned} \begin{bmatrix} n \\ m \end{bmatrix}_q &= \frac{(q; q)_n}{(q; q)_m (q; q)_{n-m}} \\ &= \frac{(q^{-n}; q)_m (-1)^m q^{nm - \binom{m}{2}}}{(q; q)_m}, \end{aligned}$$

**17.2.28**  $\lim_{q \rightarrow 1} \begin{bmatrix} n \\ m \end{bmatrix}_q = \binom{n}{m} = \frac{n!}{m!(n-m)!},$

**17.2.29** 
$$\begin{bmatrix} m+n \\ m \end{bmatrix}_q = \frac{(q^{n+1}; q)_m}{(q; q)_m},$$

**17.2.30** 
$$\begin{bmatrix} -n \\ m \end{bmatrix}_q = \begin{bmatrix} m+n-1 \\ m \end{bmatrix}_q (-1)^m q^{-mn - \binom{m}{2}},$$

**17.2.31** 
$$\begin{bmatrix} n \\ m \end{bmatrix}_q = \begin{bmatrix} n-1 \\ m-1 \end{bmatrix}_q + q^m \begin{bmatrix} n-1 \\ m \end{bmatrix}_q,$$

**17.2.32** 
$$\begin{bmatrix} n \\ m \end{bmatrix}_q = \begin{bmatrix} n-1 \\ m \end{bmatrix}_q + q^{n-m} \begin{bmatrix} n-1 \\ m-1 \end{bmatrix}_q,$$

**17.2.33**

$$\lim_{n \rightarrow \infty} \begin{bmatrix} n \\ m \end{bmatrix}_q = \frac{1}{(q; q)_m} = \frac{1}{(1-q)(1-q^2) \cdots (1-q^m)},$$

**17.2.34**  $\lim_{n \rightarrow \infty} \begin{bmatrix} rn+u \\ sn+t \end{bmatrix}_q = \frac{1}{(q; q)_\infty} = \prod_{j=1}^{\infty} \frac{1}{(1-q^j)},$

provided that  $r > s$ .

---

**17.2.42** 
$$f^{[n]}(z) = \mathcal{D}_q^n f(z) = \begin{cases} z^{-n} (1-q)^{-n} \sum_{j=0}^n q^{-nj + \binom{j+1}{2}} (-1)^j \begin{bmatrix} n \\ j \end{bmatrix}_q f(zq^j), & z \neq 0, \\ \frac{f^{(n)}(0) (q; q)_n}{n! (1-q)^n}, & z = 0. \end{cases}$$

When  $q \rightarrow 1$  the  $q$ -derivatives converge to the corresponding ordinary derivatives.

**Product Rule**

**17.2.43**  $\mathcal{D}_q(f(z)g(z)) = g(z)f^{[1]}(z) + f(zq)g^{[1]}(z).$

**17.2(iii) Binomial Theorem**

**17.2.35**

$$\begin{aligned} \sum_{j=0}^n \begin{bmatrix} n \\ j \end{bmatrix}_q (-z)^j q^{\binom{j}{2}} &= (z; q)_n \\ &= (1-z)(1-zq) \cdots (1-zq^{n-1}). \end{aligned}$$

In the limit as  $q \rightarrow 1$ , (17.2.35) reduces to the standard binomial theorem

**17.2.36** 
$$\sum_{j=0}^n \binom{n}{j} (-z)^j = (1-z)^n.$$

Also,

**17.2.37** 
$$\sum_{n=0}^{\infty} \frac{(a; q)_n}{(q; q)_n} z^n = \frac{(az; q)_\infty}{(z; q)_\infty},$$

provided that  $|z| < 1$ . When  $a = q^{m+1}$ , where  $m$  is a nonnegative integer, (17.2.37) reduces to the  $q$ -binomial series

**17.2.38** 
$$\sum_{n=0}^{\infty} \begin{bmatrix} n+m \\ n \end{bmatrix}_q z^n = \frac{1}{(z; q)_{m+1}}.$$

**17.2.39** 
$$\sum_{j=0}^n \begin{bmatrix} n \\ j \end{bmatrix}_{q^2} q^j = (-q; q)_n,$$

**17.2.40** 
$$\sum_{j=0}^{2n} (-1)^j \begin{bmatrix} 2n \\ j \end{bmatrix}_q = (q; q^2)_n.$$

When  $n \rightarrow \infty$  in (17.2.35), and when  $m \rightarrow \infty$  in (17.2.38), the results become convergent infinite series and infinite products (see (17.5.1) and (17.5.4)).

**17.2(iv) Derivatives**

The  $q$ -derivatives of  $f(z)$  are defined by

**17.2.41** 
$$\mathcal{D}_q f(z) = \begin{cases} \frac{f(z) - f(zq)}{(1-q)z}, & z \neq 0, \\ f'(0), & z = 0, \end{cases}$$

and

**Leibniz Rule**

**17.2.44** 
$$\mathcal{D}_q^n (f(z)g(z)) = \sum_{j=0}^n \begin{bmatrix} n \\ j \end{bmatrix}_q f^{[n-j]}(zq^j) g^{[j]}(z).$$

$q$ -differential equations are considered in §17.6(iv).

**17.2(v) Integrals**

If  $f(x)$  is continuous at  $x = 0$ , then

$$17.2.45 \quad \int_0^1 f(x) d_q x = (1 - q) \sum_{j=0}^{\infty} f(q^j) q^j,$$

and more generally,

$$17.2.46 \quad \int_0^a f(x) d_q x = a(1 - q) \sum_{j=0}^{\infty} f(aq^j) q^j.$$

If  $f(x)$  is continuous on  $[0, a]$ , then

$$17.2.47 \quad \lim_{q \rightarrow 1^-} \int_0^a f(x) d_q x = \int_0^a f(x) dx.$$

**Infinite Range**

$$17.2.48 \quad \int_0^{\infty} f(x) d_q x = \lim_{n \rightarrow \infty} \int_0^{q^{-n}} f(x) d_q x = (1 - q) \sum_{j=-\infty}^{\infty} f(q^j) q^j,$$

provided that  $\sum_{j=-\infty}^{\infty} f(q^j) q^j$  converges.

**17.2(vi) Rogers–Ramanujan Identities**

$$17.2.49 \quad 1 + \sum_{n=1}^{\infty} \frac{q^{n^2}}{(1 - q)(1 - q^2) \cdots (1 - q^n)} = \prod_{n=0}^{\infty} \frac{1}{(1 - q^{5n+1})(1 - q^{5n+4})},$$

$$17.2.50 \quad 1 + \sum_{n=1}^{\infty} \frac{q^{n^2+n}}{(1 - q)(1 - q^2) \cdots (1 - q^n)} = \prod_{n=0}^{\infty} \frac{1}{(1 - q^{5n+2})(1 - q^{5n+3})}.$$

These identities are the first in a large collection of similar results. See §17.14.

**17.3 *q*-Elementary and *q*-Special Functions**

**17.3(i) Elementary Functions**

***q*-Exponential Functions**

$$17.3.1 \quad e_q(x) = \sum_{n=0}^{\infty} \frac{(1 - q)^n x^n}{(q; q)_n} = \frac{1}{((1 - q)x; q)_{\infty}},$$

$$17.3.2 \quad E_q(x) = \sum_{n=0}^{\infty} \frac{(1 - q)^n q^{\binom{n}{2}} x^n}{(q; q)_n} = (- (1 - q)x; q)_{\infty}.$$

***q*-Sine Functions**

$$17.3.3 \quad \sin_q(x) = \frac{1}{2i} (e_q(ix) - e_q(-ix)) = \sum_{n=0}^{\infty} \frac{(1 - q)^{2n+1} (-1)^n x^{2n+1}}{(q; q)_{2n+1}},$$

$$17.3.4 \quad \text{Sin}_q(x) = \frac{1}{2i} (E_q(ix) - E_q(-ix)) = \sum_{n=0}^{\infty} \frac{(1 - q)^{2n+1} q^{n(2n+1)} (-1)^n x^{2n+1}}{(q; q)_{2n+1}}.$$

***q*-Cosine Functions**

$$17.3.5 \quad \cos_q(x) = \frac{1}{2} (e_q(ix) + e_q(-ix)) = \sum_{n=0}^{\infty} \frac{(1 - q)^{2n} (-1)^n x^{2n}}{(q; q)_{2n}},$$

$$17.3.6 \quad \text{Cos}_q(x) = \frac{1}{2} (E_q(ix) + E_q(-ix)) = \sum_{n=0}^{\infty} \frac{(1 - q)^{2n} q^{n(2n-1)} (-1)^n x^{2n}}{(q; q)_{2n}}.$$

See also Suslov (2003).

**17.3(ii) Gamma and Beta Functions**

See §5.18.

**17.3(iii) Bernoulli Polynomials; Euler and Stirling Numbers**

***q*-Bernoulli Polynomials**

$$17.3.7 \quad \beta_n(x, q) = (1 - q)^{1-n} \sum_{r=0}^n (-1)^r \binom{n}{r} \frac{r + 1}{(1 - q^{r+1})} q^{rx}.$$

***q*-Euler Numbers**

$$17.3.8 \quad A_{m,s}(q) = q^{\binom{s-m}{2} + \binom{s}{2}} \sum_{j=0}^s (-1)^j q^{\binom{j}{2}} \begin{bmatrix} m + 1 \\ j \end{bmatrix}_q \frac{(1 - q^{s-j})^m}{(1 - q)^m}.$$

***q*-Stirling Numbers**

$$17.3.9 \quad a_{m,s}(q) = \frac{q^{-\binom{s}{2}} (1 - q)^s}{(q; q)_s} \sum_{j=0}^s (-1)^j q^{\binom{j}{2}} \begin{bmatrix} s \\ j \end{bmatrix}_q \frac{(1 - q^{s-j})^m}{(1 - q)^m}.$$

These were introduced in Carlitz (1954b, 1958). The  $\beta_n(x, q)$  are, in fact, rational functions of  $q$ , and not necessarily polynomials. The  $A_{m,s}(q)$  are always polynomials in  $q$ , and the  $a_{m,s}(q)$  are polynomials in  $q$  for  $0 \leq s \leq m$ .

**17.3(iv) Theta Functions**

See §§17.8 and 20.5.

**17.3(v) Orthogonal Polynomials**

See §§18.27–18.29.

### 17.4 Basic Hypergeometric Functions

#### 17.4(i) ${}_r\phi_s$ Functions

17.4.1

$$\begin{aligned} & {}_{r+1}\phi_s \left( \begin{matrix} a_0, a_1, a_2, \dots, a_r \\ b_1, b_2, \dots, b_s \end{matrix}; q, z \right) \\ &= {}_{r+1}\phi_s(a_0, a_1, \dots, a_r; b_1, b_2, \dots, b_s; q, z) \\ &= \sum_{n=0}^{\infty} \frac{(a_0; q)_n (a_1; q)_n \cdots (a_r; q)_n}{(q; q)_n (b_1; q)_n \cdots (b_s; q)_n} \left( (-1)^n q^{\binom{n}{2}} \right)^{s-r} z^n. \end{aligned}$$

Here and elsewhere it is assumed that the  $b_j$  do not take any of the values  $q^{-n}$ . The infinite series converges for all  $z$  when  $s > r$ , and for  $|z| < 1$  when  $s = r$ .

$$\begin{aligned} & \lim_{q \rightarrow 1^-} {}_{r+1}\phi_r \left( \begin{matrix} q^{a_0}, q^{a_1}, \dots, q^{a_r} \\ q^{b_1}, \dots, q^{b_r} \end{matrix}; q, z \right) \\ &= {}_{r+1}F_r \left( \begin{matrix} a_0, a_1, \dots, a_r \\ b_1, \dots, b_r \end{matrix}; z \right). \end{aligned}$$

For the function on the right-hand side see §16.2(i).

This notation is from Gasper and Rahman (2004). It is slightly at variance with the notation in Bailey (1935) and Slater (1966). In these references the factor  $\left( (-1)^n q^{\binom{n}{2}} \right)^{s-r}$  is not included in the sum. In practice this discrepancy does not usually cause serious problems because the case most often considered is  $r = s$ .

#### 17.4(ii) ${}_r\psi_s$ Functions

17.4.3

$$\begin{aligned} & {}_r\psi_s \left( \begin{matrix} a_1, a_2, \dots, a_r \\ b_1, b_2, \dots, b_s \end{matrix}; q, z \right) \\ &= {}_r\psi_s(a_1, a_2, \dots, a_r; b_1, b_2, \dots, b_s; q, z) \\ &= \sum_{n=-\infty}^{\infty} \frac{(a_1, a_2, \dots, a_r; q)_n (-1)^{(s-r)n} q^{(s-r)\binom{n}{2}} z^n}{(b_1, b_2, \dots, b_s; q)_n} \\ &= \sum_{n=0}^{\infty} \frac{(a_1, a_2, \dots, a_r; q)_n (-1)^{(s-r)n} q^{(s-r)\binom{n}{2}} z^n}{(b_1, b_2, \dots, b_s; q)_n} \\ &\quad + \sum_{n=1}^{\infty} \frac{(q/b_1, q/b_2, \dots, q/b_s; q)_n \left( \frac{b_1 b_2 \cdots b_s}{a_1 a_2 \cdots a_r z} \right)^n}{(q/a_1, q/a_2, \dots, q/a_r; q)_n}. \end{aligned}$$

Here and elsewhere the  $b_j$  must not take any of the values  $q^{-n}$ , and the  $a_j$  must not take any of the values  $q^{n+1}$ . The infinite series converge when  $s \geq r$  provided that  $|(b_1 \cdots b_s)/(a_1 \cdots a_r z)| < 1$  and also, in the case  $s = r$ ,  $|z| < 1$ .

$$\begin{aligned} & \lim_{q \rightarrow 1^-} {}_r\psi_r \left( \begin{matrix} q^{a_1}, q^{a_2}, \dots, q^{a_r} \\ q^{b_1}, q^{b_2}, \dots, q^{b_r} \end{matrix}; q, z \right) \\ &= {}_rH_r \left( \begin{matrix} a_1, a_2, \dots, a_r \\ b_1, b_2, \dots, b_r \end{matrix}; z \right). \end{aligned}$$

For the function  ${}_rH_r$  see §16.4(v).

#### 17.4(iii) Appell Functions

The following definitions apply when  $|x| < 1$  and  $|y| < 1$ :

$$\begin{aligned} & \Phi^{(1)}(a; b, b'; c; x, y) \\ &= \sum_{m, n \geq 0} \frac{(a; q)_{m+n} (b; q)_m (b'; q)_n x^m y^n}{(q; q)_m (q; q)_n (c; q)_{m+n}}, \end{aligned}$$

$$\begin{aligned} & \Phi^{(2)}(a; b, b'; c, c'; x, y) \\ &= \sum_{m, n \geq 0} \frac{(a; q)_{m+n} (b; q)_m (b'; q)_n x^m y^n}{(q; q)_m (q; q)_n (c; q)_m (c'; q)_n}, \end{aligned}$$

$$\begin{aligned} & \Phi^{(3)}(a, a'; b, b'; c; x, y) \\ &= \sum_{m, n \geq 0} \frac{(a, b; q)_m (a', b'; q)_n x^m y^n}{(q; q)_m (q; q)_n (c; q)_{m+n}}, \end{aligned}$$

$$\Phi^{(4)}(a; b, c, c'; x, y) = \sum_{m, n \geq 0} \frac{(a, b; q)_{m+n} x^m y^n}{(q, c; q)_m (q, c'; q)_n}.$$

#### 17.4(iv) Classification

The series (17.4.1) is said to be *balanced* or *Saalschützian* when it terminates,  $r = s$ ,  $z = q$ , and

$$qa_0 a_1 \cdots a_s = b_1 b_2 \cdots b_s.$$

The series (17.4.1) is said to be *k-balanced* when  $r = s$  and

$$q^k a_0 a_1 \cdots a_s = b_1 b_2 \cdots b_s.$$

The series (17.4.1) is said to be *well-poised* when  $r = s$  and

$$a_0 q = a_1 b_1 = a_2 b_2 = \cdots = a_s b_s.$$

The series (17.4.1) is said to be *very-well-poised* when  $r = s$ , (17.4.11) is satisfied, and

$$b_1 = -b_2 = \sqrt{a_0}.$$

The series (17.4.1) is said to be *nearly-poised* when  $r = s$  and

$$a_0 q = a_1 b_1 = a_2 b_2 = \cdots = a_{s-1} b_{s-1}.$$

### 17.5 ${}_0\phi_0, {}_1\phi_0, {}_1\phi_1$ Functions

#### Euler's Second Sum

17.5.1

$${}_0\phi_0(-; -; q, z) = \sum_{n=0}^{\infty} \frac{(-1)^n q^{\binom{n}{2}} z^n}{(q; q)_n} = (z; q)_{\infty}, \quad |z| < 1;$$

compare (17.3.2).

#### $q$ -Binomial Series

$${}_1\phi_0(a; -; q, z) = \frac{(az; q)_{\infty}}{(z; q)_{\infty}}, \quad |z| < 1;$$

compare (17.2.37).



**q-Binomial Theorem**

$$17.5.3 \quad {}_1\phi_0(q^{-n}; -; q, z) = (zq^{-n}; q)_n.$$

This is (17.2.35) reformulated.

**Euler's First Sum**

$$17.5.4 \quad {}_1\phi_0(0; -; q, z) = \sum_{n=0}^{\infty} \frac{z^n}{(q; q)_n} = \frac{1}{(z; q)_{\infty}}, \quad |z| < 1;$$

compare (17.3.1).

**Cauchy's Sum**

$$17.5.5 \quad {}_1\phi_1\left(\frac{a}{c}; q, c/a\right) = \frac{(c/a; q)_{\infty}}{(c; q)_{\infty}}, \quad |c| < |a|.$$

**17.6  ${}_2\phi_1$  Function****17.6(i) Special Values****q-Gauss Sum**

$$17.6.1 \quad {}_2\phi_1\left(\begin{matrix} a, b \\ c \end{matrix}; q, c/(ab)\right) = \frac{(c/a, c/b; q)_{\infty}}{(c, c/(ab); q)_{\infty}}.$$

**First q-Chu–Vandermonde Sum**

$$17.6.2 \quad {}_2\phi_1\left(\begin{matrix} a, q^{-n} \\ c \end{matrix}; q, cq^n/a\right) = \frac{(c/a; q)_n}{(c; q)_n}.$$

**Second q-Chu–Vandermonde Sum**

This reverses the order of summation in (17.6.2):

$$17.6.3 \quad {}_2\phi_1\left(\begin{matrix} a, q^{-n} \\ c \end{matrix}; q, q\right) = \frac{a^n (c/a; q)_n}{(c; q)_n}.$$

**Andrews–Askey Sum****17.6.4**

$$\begin{aligned} & {}_2\phi_1\left(\begin{matrix} b^2, b^2/c \\ c \end{matrix}; q^2, cq/b^2\right) \\ &= \frac{1}{2} \frac{(b^2, q; q^2)_{\infty}}{(c, cq/b^2; q^2)_{\infty}} \left( \frac{(c/b; q)_{\infty}}{(b; q)_{\infty}} + \frac{(-c/b; q)_{\infty}}{(-b; q)_{\infty}} \right), \\ & \quad |cq| < |b^2|. \end{aligned}$$

**Bailey–Daum q-Kummer Sum****17.6.5**

$${}_2\phi_1\left(\begin{matrix} a, b \\ aq/b \end{matrix}; q, -q/b\right) = \frac{(-q; q)_{\infty} (aq, aq^2/b^2; q^2)_{\infty}}{(-q/b, aq/b; q)_{\infty}}, \quad |b| > |q|.$$

**17.6(ii)  ${}_2\phi_1$  Transformations****Heine's First Transformation**

$$17.6.6 \quad {}_2\phi_1\left(\begin{matrix} a, b \\ c \end{matrix}; q, z\right) = \frac{(b, az; q)_{\infty}}{(c, z; q)_{\infty}} {}_2\phi_1\left(\begin{matrix} c/b, z \\ az \end{matrix}; q, b\right), \quad |z| < 1, |b| < 1.$$

**Heine's Second Transformation****17.6.7**

$${}_2\phi_1\left(\begin{matrix} a, b \\ c \end{matrix}; q, z\right) = \frac{(c/b, bz; q)_{\infty}}{(c, z; q)_{\infty}} {}_2\phi_1\left(\begin{matrix} abz/c, b \\ bz \end{matrix}; q, c/b\right), \quad |z| < 1, |c| < |b|.$$

**Heine's Third Transformation**

$$\begin{aligned} & {}_2\phi_1\left(\begin{matrix} a, b \\ c \end{matrix}; q, z\right) \\ 17.6.8 \quad &= \frac{(abz/c; q)_{\infty}}{(z; q)_{\infty}} {}_2\phi_1\left(\begin{matrix} c/a, c/b \\ c \end{matrix}; q, abz/c\right), \quad |z| < 1, |abz| < |c|. \end{aligned}$$

**Fine's First Transformation**

$$17.6.9 \quad {}_2\phi_1\left(\begin{matrix} q, aq \\ bq \end{matrix}; q, z\right) = -\frac{(1-b)(aq/b)}{(1-(aq/b))} \sum_{n=0}^{\infty} \frac{(aq, azq/b; q)_n q^n}{(azq^2/b; q)_n} + \frac{(aq, azq/b; q)_{\infty}}{(aq/b; q)_{\infty}} {}_2\phi_1\left(\begin{matrix} q, 0 \\ bq \end{matrix}; q, z\right), \quad |z| < 1.$$

**Fine's Second Transformation**

$$17.6.10 \quad (1-z) {}_2\phi_1\left(\begin{matrix} q, aq \\ bq \end{matrix}; q, z\right) = \sum_{n=0}^{\infty} \frac{(b/a; q)_n (-az)^n q^{(n^2+n)/2}}{(bq, zq; q)_n}, \quad |z| < 1.$$

**Fine's Third Transformation**

$$17.6.11 \quad \frac{1-z}{1-b} {}_2\phi_1\left(\begin{matrix} q, aq \\ bq \end{matrix}; q, z\right) = \sum_{n=0}^{\infty} \frac{(aq; q)_n (azq/b; q)_{2n} b^n}{(zq, aq/b; q)_n} - aq \sum_{n=0}^{\infty} \frac{(aq; q)_n (azq/b; q)_{2n+1} (bq)^n}{(zq; q)_n (aq/b; q)_{n+1}}, \quad |z| < 1, |b| < 1.$$

**Rogers–Fine Identity**

$$17.6.12 \quad (1-z) {}_2\phi_1\left(\begin{matrix} q, aq \\ bq \end{matrix}; q, z\right) = \sum_{n=0}^{\infty} \frac{(aq, azq/b; q)_n}{(bq, zq; q)_n} (1-azq^{2n+1})(bz)^n q^{n^2}, \quad |z| < 1.$$

**Nonterminating Form of the  $q$ -Vandermonde Sum**

$$17.6.13 \quad {}_2\phi_1(a, b; c; q, q) + \frac{(q/c, a, b; q)_\infty}{(c/q, aq/c, bq/c; q)_\infty} {}_2\phi_1(aq/c, bq/c; q^2/c; q, q) = \frac{(q/c, abq/c; q)_\infty}{(aq/c, bq/c; q)_\infty},$$

$$17.6.14 \quad \sum_{n=0}^{\infty} \frac{(a; q)_n (b; q^2)_n z^n}{(q; q)_n (azb; q^2)_n} = \frac{(az, bz; q^2)_\infty}{(z, azb; q^2)_\infty} {}_2\phi_1\left(\frac{a, b}{bz}; q^2, zq\right).$$

**Three-Term  ${}_2\phi_1$  Transformations**

$$17.6.15 \quad {}_2\phi_1\left(\frac{a, b}{c}; q, z\right) = \frac{(abz/c, q/c; q)_\infty}{(az/c, q/a; q)_\infty} {}_2\phi_1\left(\frac{c/a, cq/(abz)}{cq/(az)}; q, bq/c\right) \\ - \frac{(b, q/c, c/a, az/q, q^2/(az); q)_\infty}{(c/q, bq/c, q/a, az/c, cq/(az); q)_\infty} {}_2\phi_1\left(\frac{aq/c, bq/c}{q^2/c}; q, z\right), \quad |z| < 1, |bq| < |c|.$$

$$17.6.16 \quad {}_2\phi_1\left(\frac{a, b}{c}; q, z\right) = \frac{(b, c/a, az, q/(az); q)_\infty}{(c, b/a, z, q/z; q)_\infty} {}_2\phi_1\left(\frac{a, aq/c}{aq/b}; q, cq/(abz)\right) \\ + \frac{(a, c/b, bz, q/(bz); q)_\infty}{(c, a/b, z, q/z; q)_\infty} {}_2\phi_1\left(\frac{b, bq/c}{bq/a}; q, cq/(abz)\right), \quad |z| < 1, |abz| < |cq|.$$

**17.6(iii) Contiguous Relations****Heine's Contiguous Relations**

$$17.6.17 \quad {}_2\phi_1\left(\frac{a, b}{c/q}; q, z\right) - {}_2\phi_1\left(\frac{a, b}{c}; q, z\right) = cz \frac{(1-a)(1-b)}{(q-c)(1-c)} {}_2\phi_1\left(\frac{aq, bq}{cq}; q, z\right),$$

$$17.6.18 \quad {}_2\phi_1\left(\frac{aq, b}{c}; q, z\right) - {}_2\phi_1\left(\frac{a, b}{c}; q, z\right) = az \frac{1-b}{1-c} {}_2\phi_1\left(\frac{aq, bq}{cq}; q, z\right),$$

$$17.6.19 \quad {}_2\phi_1\left(\frac{aq, b}{cq}; q, z\right) - {}_2\phi_1\left(\frac{a, b}{c}; q, z\right) = az \frac{(1-b)(1-(c/a))}{(1-c)(1-cq)} {}_2\phi_1\left(\frac{aq, bq}{cq^2}; q, z\right),$$

$$17.6.20 \quad {}_2\phi_1\left(\frac{aq, b/q}{c}; q, z\right) - {}_2\phi_1\left(\frac{a, b}{c}; q, z\right) = az \frac{(1-b/(aq))}{1-c} {}_2\phi_1\left(\frac{aq, b}{cq}; q, z\right),$$

$$17.6.21 \quad b(1-a) {}_2\phi_1\left(\frac{aq, b}{c}; q, z\right) - a(1-b) {}_2\phi_1\left(\frac{a, bq}{c}; q, z\right) = (b-a) {}_2\phi_1\left(\frac{a, b}{c}; q, z\right),$$

$$17.6.22 \quad a\left(1 - \frac{b}{c}\right) {}_2\phi_1\left(\frac{a, b/q}{c}; q, z\right) - b\left(1 - \frac{a}{c}\right) {}_2\phi_1\left(\frac{a/q, b}{c}; q, z\right) = (a-b) \left(1 - \frac{abz}{cq}\right) {}_2\phi_1\left(\frac{a, b}{c}; q, z\right),$$

$$17.6.23 \quad q\left(1 - \frac{a}{c}\right) {}_2\phi_1\left(\frac{a/q, b}{c}; q, z\right) + (1-a) \left(1 - \frac{abz}{c}\right) {}_2\phi_1\left(\frac{aq, b}{c}; q, z\right) = \left(1 + q - a - \frac{aq}{c} + \frac{a^2z}{c} - \frac{abz}{c}\right) {}_2\phi_1\left(\frac{a, b}{c}; q, z\right),$$

$$17.6.24 \quad (1-c)(q-c)(abz-c) {}_2\phi_1\left(\frac{a, b}{c/q}; q, z\right) + z(c-a)(c-b) {}_2\phi_1\left(\frac{a, b}{cq}; q, z\right) \\ = (c-1)(c(q-c) + z(ca+cb-ab-abq)) {}_2\phi_1\left(\frac{a, b}{c}; q, z\right).$$

**17.6(iv) Differential Equations****Iterations of  $\mathcal{D}$** 

$$17.6.25 \quad \mathcal{D}_q^n {}_2\phi_1\left(\frac{a, b}{c}; q, zd\right) = \frac{(a, b; q)_n d^n}{(c; q)_n (1-q)^n} {}_2\phi_1\left(\frac{aq^n, bq^n}{cq^n}; q, dz\right),$$

$$17.6.26 \quad \mathcal{D}_q^n \left( \frac{(z; q)_\infty}{(abz/c; q)_\infty} {}_2\phi_1\left(\frac{a, b}{c}; q, z\right) \right) = \frac{(c/a, c/b; q)_n}{(c; q)_n (1-q)^n} \left(\frac{ab}{c}\right)^n \frac{(zq^n; q)_\infty}{(abz/c; q)_\infty} {}_2\phi_1\left(\frac{a, b}{cq^n}; q, zq^n\right).$$

***q*-Differential Equation**

$$17.6.27 \quad z(c - abqz) \mathcal{D}_q^2 {}_2\phi_1 \left( \begin{matrix} a, b \\ c \end{matrix}; q, z \right) + \left( \frac{1-c}{1-q} + \frac{(1-a)(1-b) - (1-abq)z}{1-q} \right) \mathcal{D}_q {}_2\phi_1 \left( \begin{matrix} a, b \\ c \end{matrix}; q, z \right) - \frac{(1-a)(1-b)}{(1-q)^2} {}_2\phi_1 \left( \begin{matrix} a, b \\ c \end{matrix}; q, z \right) = 0.$$

(17.6.27) reduces to the hypergeometric equation (15.10.1) with the substitutions  $a \rightarrow q^a, b \rightarrow q^b, c \rightarrow q^c$ , followed by  $\lim_{q \rightarrow 1^-}$ .

**17.6(v) Integral Representations**

$$17.6.28 \quad {}_2\phi_1 \left( \begin{matrix} q^\alpha, q^\beta \\ q^\gamma \end{matrix}; q, z \right) = \frac{\Gamma_q(\gamma)}{\Gamma_q(\beta)\Gamma_q(\gamma-\beta)} \int_0^1 \frac{t^{\beta-1} (tq; q)_{\gamma-\beta-1}}{(xt; q)_\alpha} d_q t.$$

$$17.6.29 \quad {}_2\phi_1 \left( \begin{matrix} a, b \\ c \end{matrix}; q, z \right) = \left( \frac{-1}{2\pi i} \right) \frac{(a, b; q)_\infty}{(q, c; q)_\infty} \int_{-i\infty}^{i\infty} \frac{(q^{1+\zeta}, cq^\zeta; q)_\infty}{(aq^\zeta, bq^\zeta; q)_\infty} \frac{\pi(-z)^\zeta}{\sin(\pi\zeta)} d\zeta,$$

where  $|z| < 1, |\text{ph}(-z)| < \pi$ , and the contour of integration separates the poles of  $(q^{1+\zeta}, cq^\zeta; q)_\infty / \sin(\pi\zeta)$  from those of  $1/(aq^\zeta, bq^\zeta; q)_\infty$ , and the infimum of the distances of the poles from the contour is positive.

**17.6(vi) Continued Fractions**

For continued-fraction representations of the  ${}_2\phi_1$  function, see Cuyt *et al.* (2008, pp. 395–399).

**17.7 Special Cases of Higher  ${}_r\phi_s$  Functions**

**17.7(i)  ${}_2\phi_2$  Functions**

***q*-Analog of Bailey's  ${}_2F_1(-1)$  Sum**

$$17.7.1 \quad {}_2\phi_2 \left( \begin{matrix} a, q/a \\ -q, b \end{matrix}; q, -b \right) = \frac{(ab, bq/a; q^2)_\infty}{(b; q)_\infty}, \quad |b| < 1.$$

***q*-Analog of Gauss's  ${}_2F_1(-1)$  Sum**

$$17.7.2 \quad {}_2\phi_2 \left( \begin{matrix} a^2, b^2 \\ abq^{\frac{1}{2}}, -abq^{\frac{1}{2}} \end{matrix}; q, -q \right) = \frac{(a^2q, b^2q; q^2)_\infty}{(q, a^2b^2q; q^2)_\infty}.$$

**Sum Related to (17.6.4)**

$$17.7.3 \quad {}_2\phi_2 \left( \begin{matrix} c^2/b^2, b^2 \\ c, cq \end{matrix}; q^2, q \right) = \frac{1}{2} \frac{(b^2, q; q^2)_\infty}{(c, cq; q^2)_\infty} \left( \frac{(c/b; q)_\infty}{(b; q)_\infty} + \frac{(-c/b; q)_\infty}{(-b; q)_\infty} \right).$$

**17.7(ii)  ${}_3\phi_2$  Functions**

***q*-Pfaff–Saalschütz Sum**

$$17.7.4 \quad {}_3\phi_2 \left( \begin{matrix} a, b, q^{-n} \\ c, abq^{1-n}/c \end{matrix}; q, q \right) = \frac{(c/a, c/b; q)_n}{(c, c/(ab); q)_n}.$$

**Nonterminating Form of the *q*-Saalschütz Sum**

$$17.7.5 \quad {}_3\phi_2 \left( \begin{matrix} a, b, c \\ e, f \end{matrix}; q, q \right) + \frac{(q/e, a, b, c, qf/e; q)_\infty}{(e/q, aq/e, bq/e, cq/e, f; q)_\infty} \times {}_3\phi_2 \left( \begin{matrix} aq/e, bq/e, cq/e \\ q^2/e, qf/e \end{matrix}; q, q \right) = \frac{(q/e, f/a, f/b, f/c; q)_\infty}{(aq/e, bq/e, cq/e, f; q)_\infty},$$

where  $ef = abcq$ .

**F. H. Jackson's Terminating *q*-Analog of Dixon's Sum**

$$17.7.6 \quad {}_3\phi_2 \left( \begin{matrix} q^{-2n}, b, c \\ q^{1-2n}/b, q^{1-2n}/c \end{matrix}; q, \frac{q^{2-n}}{bc} \right) = \frac{(b, c; q)_n (q, bc; q)_{2n}}{(q, bc; q)_n (b, c; q)_{2n}}.$$

**Continued Fractions**

For continued-fraction representations of a ratio of  ${}_3\phi_2$  functions, see Cuyt *et al.* (2008, pp. 399–400).

**17.7(iii) Other  ${}_r\phi_s$  Functions**

***q*-Analog of Dixon's  ${}_3F_2(1)$  Sum**

$$17.7.7 \quad {}_4\phi_3 \left( \begin{matrix} a, -qa^{\frac{1}{2}}, b, c \\ -a^{\frac{1}{2}}, aq/b, aq/c \end{matrix}; q, \frac{qa^{\frac{1}{2}}}{bc} \right) = \frac{(aq, qa^{\frac{1}{2}}/b, qa^{\frac{1}{2}}/c, aq/(bc); q)_\infty}{(aq/b, aq/c, qa^{\frac{1}{2}}, qa^{\frac{1}{2}}/(bc); q)_\infty}.$$

**Gasper–Rahman *q*-Analog of Watson's  ${}_3F_2$  Sum**

$$17.7.8 \quad {}_8\phi_7 \left( \begin{matrix} \lambda, q\lambda^{\frac{1}{2}}, -q\lambda^{\frac{1}{2}}, a, b, c, -c, \lambda q/c^2 \\ \lambda^{\frac{1}{2}}, -\lambda^{\frac{1}{2}}, \lambda q/a, \lambda q/b, \lambda q/c, -\lambda q/c, c^2; q, -\frac{\lambda q}{ab} \end{matrix} \right) = \frac{(\lambda q, c^2/\lambda; q)_\infty (aq, bq, c^2q/a, c^2q/b; q^2)_\infty}{(\lambda q/a, \lambda q/b; q)_\infty (q, abq, c^2q, c^2q/(ab); q^2)_\infty},$$

where  $\lambda = -c(ab/q)^{\frac{1}{2}}$ .

**Andrews' Terminating  $q$ -Analog of (17.7.8)**

$$17.7.9 \quad \begin{aligned} & {}_4\phi_3 \left( \begin{matrix} q^{-n}, aq^n, c, -c \\ (aq)^{\frac{1}{2}}, -(aq)^{\frac{1}{2}}, c^2 \end{matrix}; q, q \right) \\ &= \begin{cases} 0, & n \text{ odd,} \\ \frac{c^n (q, aq/c^2; q^2)_{n/2}}{(aq, c^2q; q^2)_{n/2}}, & n \text{ even.} \end{cases} \end{aligned}$$

**Gasper–Rahman  $q$ -Analog of Whipple's  ${}_3F_2$  Sum**

$$17.7.10 \quad \begin{aligned} & {}_8\phi_7 \left( \begin{matrix} -c, q(-c)^{\frac{1}{2}}, -q(-c)^{\frac{1}{2}}, a, q/a, c, -d, -q/d \\ (-c)^{\frac{1}{2}}, -(-c)^{\frac{1}{2}}, -cq/a, -ac, -q, cq/d, cd \end{matrix}; q, c \right) \\ &= \frac{(-c, -cq; q)_{\infty} (acd, acq/d, cdq/a, cq^2/(ad); q^2)_{\infty}}{(cd, cq/d, -ac, -cq/a; q)_{\infty}}. \end{aligned}$$

**Andrews' Terminating  $q$ -Analog**

$$17.7.11 \quad \begin{aligned} & {}_4\phi_3 \left( \begin{matrix} q^{-n}, q^{n+1}, c, -c \\ e, c^2q/e, -q \end{matrix}; q, q \right) \\ &= \frac{(eq^{-n}, eq^{n+1}, c^2q^{1-n}/e, c^2q^{n+2}/e; q^2)_{\infty}}{(e, c^2q/e; q)_{\infty}}. \end{aligned}$$

**First  $q$ -Analog of Bailey's  ${}_4F_3(1)$  Sum**

$$17.7.12 \quad {}_4\phi_3 \left( \begin{matrix} a, aq, b^2q^{2n}, q^{-2n} \\ b, bq, a^2q^2 \end{matrix}; q^2, q^2 \right) = \frac{a^n (-q, b/a; q)_n}{(-aq, b; q)_n}.$$

**Second  $q$ -Analog of Bailey's  ${}_4F_3(1)$  Sum**

$$17.7.13 \quad \begin{aligned} & {}_4\phi_3 \left( \begin{matrix} a, aq, b^2q^{2n-2}, q^{-2n} \\ b, bq, a^2 \end{matrix}; q^2, q^2 \right) \\ &= \frac{a^n (-q, b/a; q)_n (1 - bq^{n-1})}{(-a, b; q)_n (1 - bq^{2n-1})}. \end{aligned}$$

**F. H. Jackson's  $q$ -Analog of Dougall's  ${}_7F_6(1)$  Sum**

$$17.7.14 \quad \begin{aligned} & {}_8\phi_7 \left( \begin{matrix} a, qa^{\frac{1}{2}}, -qa^{\frac{1}{2}}, b, c, d, e, q^{-n} \\ a^{\frac{1}{2}}, -a^{\frac{1}{2}}, aq/b, aq/c, aq/d, aq/e, aq^{n+1} \end{matrix}; q, q \right) \\ &= \frac{(aq, aq/(bc), aq/(bd), aq/(cd); q)_n}{(aq/b, aq/c, aq/d, aq/(bcd); q)_n}, \end{aligned}$$

where  $a^2q = bcdeq^{-n}$ .

**Limiting Cases of (17.7.14)**

$$17.7.15 \quad \begin{aligned} & {}_6\phi_5 \left( \begin{matrix} a, qa^{\frac{1}{2}}, -qa^{\frac{1}{2}}, b, c, d \\ a^{\frac{1}{2}}, -a^{\frac{1}{2}}, aq/b, aq/c, aq/d \end{matrix}; q, \frac{aq}{bcd} \right) \\ &= \frac{(aq, aq/(bc), aq/(bd), aq/(cd); q)_{\infty}}{(aq/b, aq/c, aq/d, aq/(bcd); q)_{\infty}}, \end{aligned}$$

and when  $d = q^{-n}$ ,

$$17.7.16 \quad \begin{aligned} & {}_6\phi_5 \left( \begin{matrix} a, qa^{\frac{1}{2}}, -qa^{\frac{1}{2}}, b, c, q^{-n} \\ a^{\frac{1}{2}}, -a^{\frac{1}{2}}, aq/b, aq/c, aq^{n+1} \end{matrix}; q, \frac{aq^{n+1}}{bc} \right) \\ &= \frac{(aq, aq/(bc); q)_n}{(aq/b, aq/c; q)_n}. \end{aligned}$$

See <http://dlmf.nist.gov/17.7.iii> for additional results.

**17.8 Special Cases of  ${}_r\psi_r$  Functions**

**Jacobi's Triple Product**

$$17.8.1 \quad \sum_{n=-\infty}^{\infty} (-z)^n q^{n(n-1)/2} = (q, z, q/z; q)_{\infty};$$

compare (20.5.9).

**Ramanujan's  ${}_1\psi_1$  Summation**

$$17.8.2 \quad {}_1\psi_1 \left( \begin{matrix} a \\ b \end{matrix}; q, z \right) = \frac{(q, b/a, az, q/(az); q)_{\infty}}{(b, q/a, z, b/(az); q)_{\infty}}.$$

**Quintuple Product Identity**

$$17.8.3 \quad \begin{aligned} & \sum_{n=-\infty}^{\infty} (-1)^n q^{n(3n-1)/2} z^{3n} (1 + zq^n) \\ &= (q, -z, -q/z; q)_{\infty} (qz^2, q/z^2; q^2)_{\infty}. \end{aligned}$$

**Bailey's Bilateral Summations**

$$17.8.4 \quad {}_2\psi_2(b, c; aq/b, aq/c; q, -aq/(bc)) = \frac{(aq/(bc); q)_{\infty} (aq^2/b^2, aq^2/c^2, q^2, aq, q/a; q^2)_{\infty}}{(aq/b, aq/c, q/b, q/c, -aq/(bc); q)_{\infty}},$$

$$17.8.5 \quad {}_3\psi_3 \left( \begin{matrix} b, c, d \\ q/b, q/c, q/d \end{matrix}; q, \frac{q}{bcd} \right) = \frac{(q, q/(bc), q/(bd), q/(cd); q)_{\infty}}{(q/b, q/c, q/d, q/(bcd); q)_{\infty}},$$

$$17.8.6 \quad {}_4\psi_4 \left( \begin{matrix} -qa^{\frac{1}{2}}, b, c, d \\ -a^{\frac{1}{2}}, aq/b, aq/c, aq/d \end{matrix}; q, \frac{qa^{\frac{3}{2}}}{bcd} \right) = \frac{(aq, aq/(bc), aq/(bd), aq/(cd), qa^{\frac{1}{2}}/b, qa^{\frac{1}{2}}/c, qa^{\frac{1}{2}}/d, q, q/a; q)_{\infty}}{(aq/b, aq/c, aq/d, q/b, q/c, q/d, qa^{\frac{1}{2}}, qa^{-\frac{1}{2}}, qa^{\frac{3}{2}}/(bcd); q)_{\infty}},$$

17.8.7

$${}_6\psi_6 \left( \begin{matrix} qa^{\frac{1}{2}}, -qa^{\frac{1}{2}}, b, c, d, e \\ a^{\frac{1}{2}}, -a^{\frac{1}{2}}, aq/b, aq/c, aq/d, aq/e \end{matrix}; q, \frac{qa^2}{bcde} \right) = \frac{(aq, aq/(bc), aq/(bd), aq/(be), aq/(cd), aq/(ce), aq/(de), q, q/a; q)_{\infty}}{(aq/b, aq/c, aq/d, aq/e, q/b, q/c, q/d, q/e, qa^2/(bcde); q)_{\infty}}.$$

## 17.9 Transformations of Higher ${}_r\phi_r$ Functions

17.9(i)  ${}_2\phi_1 \rightarrow {}_2\phi_2$ ,  ${}_3\phi_1$ , or  ${}_3\phi_2$

F. H. Jackson's Transformations

$$17.9.1 \quad {}_2\phi_1 \left( \begin{matrix} a, b \\ c \end{matrix}; q, z \right) = \frac{(za; q)_{\infty}}{(z; q)_{\infty}} {}_2\phi_2 \left( \begin{matrix} a, c/b \\ c, az \end{matrix}; q, bz \right),$$

$$17.9.2 \quad {}_2\phi_1 \left( \begin{matrix} q^{-n}, b \\ c \end{matrix}; q, z \right) = \frac{(c/b; q)_n b^n}{(c; q)_n} {}_3\phi_1 \left( \begin{matrix} q^{-n}, b, q/c \\ bq^{1-n}/c \end{matrix}; q, z/c \right),$$

$$17.9.3 \quad {}_2\phi_1 \left( \begin{matrix} a, b \\ c \end{matrix}; q, z \right) = \frac{(abz/c; q)_{\infty}}{(bz/c; q)_{\infty}} {}_3\phi_2 \left( \begin{matrix} a, c/b, 0 \\ c, cq/bz \end{matrix}; q, q \right),$$

$$17.9.4 \quad {}_2\phi_1 \left( \begin{matrix} q^{-n}, b \\ c \end{matrix}; q, z \right) = \frac{(c/b; q)_n}{(c; q)_n} \left( \frac{bz}{q} \right)^n {}_3\phi_2 \left( \begin{matrix} q^{-n}, q/z, q^{1-n}/c \\ bq^{1-n}/c, 0 \end{matrix}; q, q \right),$$

$$17.9.5 \quad {}_2\phi_1 \left( \begin{matrix} q^{-n}, b \\ c \end{matrix}; q, z \right) = \frac{(c/b; q)_n}{(c; q)_n} {}_3\phi_2 \left( \begin{matrix} q^{-n}, b, bzq^{-n}/c \\ bq^{1-n}/c, 0 \end{matrix}; q, q \right).$$

17.9(ii)  ${}_3\phi_2 \rightarrow {}_3\phi_2$

Transformations of  ${}_3\phi_2$ -Series

$$17.9.6 \quad {}_3\phi_2 \left( \begin{matrix} a, b, c \\ d, e \end{matrix}; q, de/(abc) \right) = \frac{(e/a, de/(bc); q)_{\infty}}{(e, de/(abc); q)_{\infty}} {}_3\phi_2 \left( \begin{matrix} a, d/b, d/c \\ d, de/(bc) \end{matrix}; q, e/a \right),$$

$$17.9.7 \quad {}_3\phi_2 \left( \begin{matrix} a, b, c \\ d, e \end{matrix}; q, de/(abc) \right) = \frac{(b, de/(ab), de/(bc); q)_{\infty}}{(d, e, de/(abc); q)_{\infty}} {}_3\phi_2 \left( \begin{matrix} d/b, e/b, de/(abc) \\ de/(ab), de/(bc) \end{matrix}; q, b \right),$$

$$17.9.8 \quad {}_3\phi_2 \left( \begin{matrix} q^{-n}, b, c \\ d, e \end{matrix}; q, q \right) = \frac{(de/(bc); q)_n}{(e; q)_n} \left( \frac{bc}{d} \right)^n {}_3\phi_2 \left( \begin{matrix} q^{-n}, d/b, d/c \\ d, de/(bc) \end{matrix}; q, q \right),$$

$$17.9.9 \quad {}_3\phi_2 \left( \begin{matrix} q^{-n}, b, c \\ d, e \end{matrix}; q, q \right) = \frac{(e/c; q)_n c^n}{(e; q)_n} {}_3\phi_2 \left( \begin{matrix} q^{-n}, c, d/b \\ d, cq^{1-n}/e \end{matrix}; q, \frac{bq}{e} \right),$$

$$17.9.10 \quad {}_3\phi_2 \left( \begin{matrix} q^{-n}, b, c \\ d, e \end{matrix}; q, \frac{deq^n}{bc} \right) = \frac{(e/c; q)_n}{(e; q)_n} {}_3\phi_2 \left( \begin{matrix} q^{-n}, c, d/b \\ d, cq^{1-n}/e \end{matrix}; q, q \right).$$

q-Sheppard Identity

$$17.9.11 \quad {}_3\phi_2 \left( \begin{matrix} q^{-n}, b, c \\ d, e \end{matrix}; q, q \right) = \frac{(e/c, d/c; q)_n c^n}{(e, d; q)_n} {}_3\phi_2 \left( \begin{matrix} q^{-n}, c, cbq^{1-n}/(de) \\ cq^{1-n}/e, cq^{1-n}/d \end{matrix}; q, q \right),$$

For further results see <http://dlmf.nist.gov/17.9.ii>.

17.9(iii) Further  ${}_r\phi_s$  Functions

Sears' Balanced  ${}_4\phi_3$  Transformations

With  $def = abcq^{1-n}$

$$17.9.14 \quad {}_4\phi_3 \left( \begin{matrix} q^{-n}, a, b, c \\ d, e, f \end{matrix}; q, q \right) = \frac{(e/a, f/a; q)_n a^n}{(e, f; q)_n} {}_4\phi_3 \left( \begin{matrix} q^{-n}, a, d/b, d/c \\ d, aq^{1-n}/e, aq^{1-n}/f \end{matrix}; q, q \right) \\ = \frac{(a, ef/(ab), ef/(ac); q)_n}{(e, f, ef/(abc); q)_n} {}_4\phi_3 \left( \begin{matrix} q^{-n}, e/a, f/a, ef/(abc) \\ ef/(ab), ef/(ac), q^{1-n}/a \end{matrix}; q, q \right).$$

**Watson's  $q$ -Analog of Whipple's Theorem**

With  $n$  a nonnegative integer

$$17.9.15 \quad \frac{(aq, aq/(de); q)_n}{(aq/d, aq/e; q)_n} {}_4\phi_3 \left( \begin{matrix} aq/(bc), d, e, q^{-n} \\ aq/b, aq/c, deq^{-n}/a \end{matrix}; q, q \right) = {}_8\phi_7 \left( \begin{matrix} a, qa^{\frac{1}{2}}, -qa^{\frac{1}{2}}, b, c, d, e, q^{-n} \\ a^{\frac{1}{2}}, -a^{\frac{1}{2}}, aq/b, aq/c, aq/d, aq/e, aq^{n+1} \end{matrix}; q, \frac{a^2 q^{2+n}}{bcde} \right).$$

**Bailey's Transformation of Very-Well-Poised  ${}_8\phi_7$** 

$$17.9.16 \quad \begin{aligned} & {}_8\phi_7 \left( \begin{matrix} a, qa^{\frac{1}{2}}, -qa^{\frac{1}{2}}, b, c, d, e, f \\ a^{\frac{1}{2}}, -a^{\frac{1}{2}}, aq/b, aq/c, aq/d, aq/e, aq/f \end{matrix}; q, \frac{a^2 q^2}{bcdef} \right) \\ &= \frac{(aq, aq/(de), aq/(df), aq/(ef); q)_\infty}{(aq/d, aq/e, aq/f, aq/(def); q)_\infty} {}_4\phi_3 \left( \begin{matrix} aq/(bc), d, e, f \\ aq/b, aq/c, def/a \end{matrix}; q, q \right) \\ &+ \frac{(aq, aq/(bc), d, e, f, a^2 q^2/(bcdef), a^2 q^2/(cdef); q)_\infty}{(aq/b, aq/c, aq/d, aq/e, aq/f, a^2 q^2/(bcdef), def/(aq); q)_\infty} {}_4\phi_3 \left( \begin{matrix} aq/(de), aq/(df), aq/(ef), a^2 q^2/(bcdef) \\ a^2 q^2/(bcdef), a^2 q^2/(cdef), aq^2/(def) \end{matrix}; q, q \right). \end{aligned}$$

For additional results see <http://dlmf.nist.gov/17.9.iii> and Gasper and Rahman (2004, Appendix III and Chapter 2).

**17.9(iv) Bibasic Series****Mixed-Base Heine-Type Transformations**

$$17.9.19 \quad \sum_{n=0}^{\infty} \frac{(a; q^2)_n (b; q)_n}{(q^2; q^2)_n (c; q)_n} z^n = \frac{(b; q)_\infty (az; q^2)_\infty}{(c; q)_\infty (z; q^2)_\infty} \sum_{n=0}^{\infty} \frac{(c/b; q)_{2n} (z; q^2)_n b^{2n}}{(q; q)_{2n} (az; q^2)_n} \\ + \frac{(b; q)_\infty (azq; q^2)_\infty}{(c; q)_\infty (zq; q^2)_\infty} \sum_{n=0}^{\infty} \frac{(c/b; q)_{2n+1} (zq; q^2)_n b^{2n+1}}{(q; q)_{2n+1} (azq; q^2)_n}.$$

$$17.9.20 \quad \sum_{n=0}^{\infty} \frac{(a; q^k)_n (b; q)_{kn} z^n}{(q^k; q^k)_n (c; q)_{kn}} = \frac{(b; q)_\infty (az; q^k)_\infty}{(c; q)_\infty (z; q^k)_\infty} \sum_{n=0}^{\infty} \frac{(c/b; q)_n (z; q^k)_n b^n}{(q; q)_n (az; q^k)_n}, \quad k = 1, 2, 3, \dots$$

**17.10 Transformations of  ${}_r\psi_r$  Functions****Bailey's  ${}_2\psi_2$  Transformations**

$$17.10.1 \quad {}_2\psi_2 \left( \begin{matrix} a, b \\ c, d \end{matrix}; q, z \right) = \frac{(az, d/a, c/b, dq/(abz); q)_\infty}{(z, d, q/b, cd/(abz); q)_\infty} {}_2\psi_2 \left( \begin{matrix} a, abz/d \\ az, c \end{matrix}; q, \frac{d}{a} \right),$$

$$17.10.2 \quad {}_2\psi_2 \left( \begin{matrix} a, b \\ c, d \end{matrix}; q, z \right) = \frac{(az, bz, cq/(abz), dq/(abz); q)_\infty}{(q/a, q/b, c, d; q)_\infty} {}_2\psi_2 \left( \begin{matrix} abz/c, abz/d \\ az, bz \end{matrix}; q, \frac{cd}{abz} \right).$$

**Other Transformations**

$$17.10.3 \quad \begin{aligned} & {}_8\psi_8 \left( \begin{matrix} qa^{\frac{1}{2}}, -qa^{\frac{1}{2}}, c, d, e, f, aq^{-n}, q^{-n} \\ a^{\frac{1}{2}}, -a^{\frac{1}{2}}, aq/c, aq/d, aq/e, aq/f, q^{n+1}, aq^{n+1} \end{matrix}; q, \frac{a^2 q^{2n+2}}{cdef} \right) \\ &= \frac{(aq, q/a, aq/(cd), aq/(ef); q)_n}{(q/c, q/d, aq/e, aq/f; q)_n} {}_4\psi_4 \left( \begin{matrix} e, f, aq^{n+1}/(cd), q^{-n} \\ aq/c, aq/d, q^{n+1}, ef/(aq^n) \end{matrix}; q, q \right), \end{aligned}$$

$$17.10.4 \quad {}_2\psi_2 \left( \begin{matrix} e, f \\ aq/c, aq/d \end{matrix}; q, \frac{aq}{ef} \right) = \frac{(q/c, q/d, aq/e, aq/f; q)_\infty}{(aq, q/a, aq/(cd), aq/(ef); q)_\infty} \sum_{n=-\infty}^{\infty} \frac{(1 - aq^{2n}) (c, d, e, f; q)_n}{(1 - a) (aq/c, aq/d, aq/e, aq/f; q)_n} \left( \frac{qa^3}{cdef} \right)^n q^{n^2}.$$

$$17.10.5 \quad \begin{aligned} & \frac{(aq/b, aq/c, aq/d, aq/e, q/(ab), q/(ac), q/(ad), q/(ae); q)_\infty}{(fa, ga, f/a, g/a, qa^2, q/a^2; q)_\infty} {}_8\psi_8 \left( \begin{matrix} qa, -qa, ba, ca, da, ea, fa, ga \\ a, -a, aq/b, aq/c, aq/d, aq/e, aq/f, aq/g \end{matrix}; q, \frac{q^2}{bcdefg} \right) \\ &= \frac{(q, q/(bf), q/(cf), q/(df), q/(ef), qf/b, qf/c, qf/d, qf/e; q)_\infty}{(fa, q/(fa), aq/f, f/a, g/f, fg, qf^2; q)_\infty} \\ &\times {}_8\phi_7 \left( \begin{matrix} f^2, qf, -qf, fb, fc, fd, fe, fg \\ f, -f, fq/b, fq/c, fq/d, fq/e, fq/g \end{matrix}; q, \frac{q^2}{bcdefg} \right) + \text{idem}(f; g). \end{aligned}$$

$$\begin{aligned}
 & \frac{(aq/b, aq/c, aq/d, aq/e, aq/f, q/(ab), q/(ac), q/(ad), q/(ae), q/(af); q)_\infty}{(ag, ah, ak, g/a, h/a, k/a, qa^2, q/a^2; q)_\infty} \\
 17.10.6 \quad & \times {}_{10}\psi_{10} \left( \begin{matrix} qa, -qa, ba, ca, da, ea, fa, ga, ha, ka \\ a, -a, aq/b, aq/c, aq/d, aq/e, aq/f, aq/g, aq/h, aq/k \end{matrix}; q, \frac{q^2}{bcdefghk} \right) \\
 & = \frac{(q, q/(bg), q/(cg), q/(dg), q/(eg), q/(fg), qg/b, qg/c, qg/d, qg/e, qg/f; q)_\infty}{(gh, gk, h/g, ag, q/(ag), g/a, aq/g, qg^2; q)_\infty} \\
 & \times {}_{10}\phi_9 \left( \begin{matrix} g^2, qg, -qg, gb, gc, gd, ge, gf, gh, gk \\ g, -g, qg/b, qg/c, qg/d, qg/e, qg/f, qg/h, qg/k \end{matrix}; q, \frac{q^2}{bcdefghk} \right) + \text{idem}(g; h, k).
 \end{aligned}$$

**17.11 Transformations of *q*-Appell Functions**

$$\begin{aligned}
 17.11.1 \quad & \Phi^{(1)}(a; b, b'; c; x, y) = \frac{(a, bx, b'y; q)_\infty}{(c, x, y; q)_\infty} {}_3\phi_2 \left( \begin{matrix} c/a, x, y \\ bx, b'y \end{matrix}; q, a \right), \\
 17.11.2 \quad & \Phi^{(2)}(a; b, b'; c, c'; x, y) = \frac{(b, ax; q)_\infty}{(c, x; q)_\infty} \sum_{n,r \geq 0} \frac{(a, b'; q)_n (c/b, x; q)_r b^r y^n}{(q, c'; q)_n (q)_r (ax; q)_{n+r}}, \\
 17.11.3 \quad & \Phi^{(3)}(a, a'; b, b'; c; x, y) = \frac{(a, bx; q)_\infty}{(c, x; q)_\infty} \sum_{n,r \geq 0} \frac{(a', b'; q)_n (x; q)_r (c/a; q)_{n+r} a^r y^n}{(q, c/a; q)_n (q, bx; q)_r}.
 \end{aligned}$$

Of (17.11.1)–(17.11.3) only (17.11.1) has a natural generalization: the following sum reduces to (17.11.1) when  $n = 2$ .

$$\begin{aligned}
 17.11.4 \quad & \sum_{m_1, \dots, m_n \geq 0} \frac{(a; q)_{m_1+m_2+\dots+m_n} (b_1; q)_{m_1} (b_2; q)_{m_2} \dots (b_n; q)_{m_n} x_1^{m_1} x_2^{m_2} \dots x_n^{m_n}}{(q; q)_{m_1} (q; q)_{m_2} \dots (q; q)_{m_n} (c; q)_{m_1+m_2+\dots+m_n}} \\
 & = \frac{(a, b_1x_1, b_2x_2, \dots, b_nx_n; q)_\infty}{(c, x_1, x_2, \dots, x_n; q)_\infty} {}_{n+1}\phi_n \left( \begin{matrix} c/a, x_1, x_2, \dots, x_n \\ b_1x_1, b_2x_2, \dots, b_nx_n \end{matrix}; q, a \right).
 \end{aligned}$$

**17.12 Bailey Pairs**

**Bailey Transform**

$$17.12.1 \quad \sum_{n=0}^\infty \alpha_n \gamma_n = \sum_{n=0}^\infty \beta_n \delta_n,$$

where

$$17.12.2 \quad \beta_n = \sum_{j=0}^n \alpha_j u_{n-j} v_{n+j}, \quad \gamma_n = \sum_{j=n}^\infty \delta_j u_{j-n} v_{j+n}.$$

**Bailey Pairs**

A sequence of pairs of rational functions of several variables  $(\alpha_n, \beta_n)$ ,  $n = 0, 1, 2, \dots$ , is called a *Bailey pair* provided that for each  $n \geq 0$

$$17.12.3 \quad \beta_n = \sum_{j=0}^n \frac{\alpha_j}{(q; q)_{n-j} (aq; q)_{n+j}}.$$

**Weak Bailey Lemma**

If  $(\alpha_n, \beta_n)$  is a Bailey pair, then

$$17.12.4 \quad \sum_{n=0}^\infty q^{n^2} a^n \beta_n = \frac{1}{(aq; q)_\infty} \sum_{n=0}^\infty q^{n^2} a^n \alpha_n.$$

**Strong Bailey Lemma**

If  $(\alpha_n, \beta_n)$  is a Bailey pair, then so is  $(\alpha'_n, \beta'_n)$ , where

**17.12.5**

$$\begin{aligned}
 & \left( \frac{aq}{\rho_1}, \frac{aq}{\rho_2}; q \right)_n \alpha'_n = (\rho_1, \rho_2; q)_n \left( \frac{aq}{\rho_1 \rho_2} \right)^n \alpha_n \\
 & \left( \frac{aq}{\rho_1}, \frac{aq}{\rho_2}; q \right)_n \beta'_n \\
 & = \sum_{j=0}^n (\rho_1, \rho_2; q)_j \left( \frac{aq}{\rho_1 \rho_2} \right)_{n-j} \left( \frac{aq}{\rho_1 \rho_2} \right)^j \frac{\beta_j}{(q; q)_{n-j}}
 \end{aligned}$$

When (17.12.5) is iterated the resulting infinite sequence of Bailey pairs is called a *Bailey Chain*.

The Bailey pair that implies the Rogers–Ramanujan identities §17.2(vi) is:

$$\begin{aligned}
 17.12.6 \quad & \alpha_n = \frac{(a; q)_n (1 - aq^{2n}) (-1)^n q^{n(3n-1)/2} a^n}{(q; q)_n (1 - a)}, \\
 & \beta_n = \frac{1}{(q; q)_n}.
 \end{aligned}$$

The Bailey pair and Bailey chain concepts have been extended considerably. See Andrews (2000, 2001), Andrews and Berkovich (1998), Andrews *et al.* (1999),

Milne and Lilly (1992), Spiridonov (2002), and Warnaar (1998).

### 17.13 Integrals

In this section, for the function  $\Gamma_q$  see §5.18(ii).

17.13.1

$$\int_{-c}^d \frac{(-qx/c; q)_\infty (qx/d; q)_\infty}{(-ax/c; q)_\infty (bx/d; q)_\infty} d_q x$$

$$= \frac{(1-q)(q; q)_\infty (ab; q)_\infty cd(-c/d; q)_\infty (-d/c; q)_\infty}{(a; q)_\infty (b; q)_\infty (c+d)(-bc/d; q)_\infty (-ad/c; q)_\infty},$$

or, when  $0 < q < 1$ ,

17.13.2

$$\int_{-c}^d \frac{(-qx/c; q)_\infty (qx/d; q)_\infty}{(-xq^\alpha/c; q)_\infty (xq^\beta/d; q)_\infty} d_q x$$

$$= \frac{\Gamma_q(\alpha)\Gamma_q(\beta)}{\Gamma_q(\alpha+\beta)} \frac{cd}{c+d} \frac{(-c/d; q)_\infty (-d/c; q)_\infty}{(-q^\beta c/d; q)_\infty (-q^\alpha d/c; q)_\infty}.$$

### Ramanujan's Integrals

17.13.3

$$\int_0^\infty t^{\alpha-1} \frac{(-tq^{\alpha+\beta}; q)_\infty}{(-t; q)_\infty} d_q t = \frac{\Gamma(\alpha)\Gamma(1-\alpha)\Gamma_q(\beta)}{\Gamma_q(1-\alpha)\Gamma_q(\alpha+\beta)},$$

17.13.4

$$\int_0^\infty t^{\alpha-1} \frac{(-ctq^{\alpha+\beta}; q)_\infty}{(-ct; q)_\infty} d_q t$$

$$= \frac{\Gamma_q(\alpha)\Gamma_q(\beta)(-cq^\alpha; q)_\infty (-q^{1-\alpha}/c; q)_\infty}{\Gamma_q(\alpha+\beta)(-c; q)_\infty (-q/c; q)_\infty}.$$

Askey (1980) conjectured extensions of the foregoing integrals that are closely related to Macdonald (1982). These conjectures are proved independently in Hab-sieger (1988) and Kadell (1988).

## 17.14 Constant Term Identities

### Zeilberger–Bressoud Theorem (Andrews' $q$ -Dyson Conjecture)

$$17.14.1 \quad \frac{(q; q)_{a_1+a_2+\dots+a_n}}{(q; q)_{a_1} (q; q)_{a_2} \dots (q; q)_{a_n}} = \text{coeff. of } x_1^0 x_2^0 \dots x_n^0 \text{ in } \prod_{1 \leq j < k \leq n} \binom{x_j}{x_k} \binom{qx_k}{x_j}.$$

### Rogers–Ramanujan Constant Term Identities

In the following,  $G(q)$  and  $H(q)$  denote the left-hand sides of (17.2.49) and (17.2.50), respectively.

$$17.14.2 \quad \sum_{n=0}^\infty \frac{q^{n(n+1)}}{(q^2; q^2)_n (-q; q^2)_{n+1}} = \text{coeff. of } z^0 \text{ in } \frac{(-zq; q^2)_\infty (-z^{-1}q; q^2)_\infty (q^2; q^2)_\infty}{(z^{-1}q^2; q^2)_\infty (-q; q^2)_\infty (z^{-1}q; q^2)_\infty}$$

$$= \frac{1}{(-q; q^2)_\infty} \text{coeff. of } z^0 \text{ in } \frac{(-zq; q^2)_\infty (-z^{-1}q; q^2)_\infty (q^2; q^2)_\infty}{(z^{-1}q; q)_\infty} = \frac{H(q)}{(-q; q^2)_\infty},$$

$$17.14.3 \quad \sum_{n=0}^\infty \frac{q^{n(n+1)}}{(q^2; q^2)_n (-q; q^2)_{n+1}} = \text{coeff. of } z^0 \text{ in } \frac{(-zq; q^2)_\infty (-z^{-1}q; q^2)_\infty (q^2; q^2)_\infty}{(z^{-1}; q^2)_\infty (-q; q^2)_\infty (z^{-1}q; q^2)_\infty}$$

$$= \frac{1}{(-q; q^2)_\infty} \text{coeff. of } z^0 \text{ in } \frac{(-zq; q^2)_\infty (-z^{-1}q; q^2)_\infty (q^2; q^2)_\infty}{(z^{-1}; q)_\infty} = \frac{G(q)}{(-q; q^2)_\infty},$$

$$17.14.4 \quad \sum_{n=0}^\infty \frac{q^{n^2}}{(q^2; q^2)_n (q; q^2)_n} = \text{coeff. of } z^0 \text{ in } \frac{(-zq; q^2)_\infty (-z^{-1}q; q^2)_\infty (q^2; q^2)_\infty}{(-z^{-1}; q^2)_\infty (q; q^2)_\infty (z^{-1}; q^2)_\infty}$$

$$= \frac{1}{(q; q^2)_\infty} \text{coeff. of } z^0 \text{ in } \frac{(-zq; q^2)_\infty (-z^{-1}q; q^2)_\infty (q^2; q^2)_\infty}{(z^{-2}; q^4)_\infty} = \frac{G(q^4)}{(q; q^2)_\infty},$$

$$17.14.5 \quad \sum_{n=0}^\infty \frac{q^{n^2+2n}}{(q^2; q^2)_n (q; q^2)_{n+1}} = \text{coeff. of } z^0 \text{ in } \frac{(-zq; q^2)_\infty (-z^{-1}q; q^2)_\infty (q^2; q^2)_\infty}{(-q^2 z^{-1}; q^2)_\infty (q; q^2)_\infty (z^{-1}q^2; q^2)_\infty}$$

$$= \frac{1}{(q; q^2)_\infty} \text{coeff. of } z^0 \text{ in } \frac{(-zq; q^2)_\infty (-z^{-1}q; q^2)_\infty (q^2; q^2)_\infty}{(q^4 z^{-2}; q^4)_\infty} = \frac{H(q^4)}{(q; q^2)_\infty}.$$



Macdonald (1982) includes extensive conjectures on generalizations of (17.14.1) to root systems. These conjectures were proved in Cherednik (1995), Habsieger (1986), and Kadell (1994); see also Macdonald (1998). For additional results of the type (17.14.2)–(17.14.5) see Andrews (1986, Chapter 4).

## 17.15 Generalizations

For higher-dimensional basic hypergeometric functions, see Milne (1985b,c,d,a, 1988, 1994, 1997) and Gustafson (1987).

## Applications

### 17.16 Mathematical Applications

Many special cases of  $q$ -series arise in the theory of partitions, a topic treated in §§27.14(i) and 26.9. In Lie algebras Lepowsky and Milne (1978) and Lepowsky and Wilson (1982) laid foundations for extensive interaction with  $q$ -series. These and other applications are described in the surveys Andrews (1974, 1986). More recent applications are given in Gasper and Rahman (2004, Chapter 8) and Fine (1988, Chapters 1 and 2).

### 17.17 Physical Applications

In exactly solved models in statistical mechanics (Baxter (1981, 1982)) the methods and identities of §17.12 play a substantial role. See Berkovich and McCoy (1998) and Bethuel (1998) for recent surveys.

Quantum groups also apply  $q$ -series extensively. Quantum groups are really not groups at all but certain Hopf algebras. They were given this name because they play a role in quantum physics analogous to the role of Lie groups and special functions in classical mechanics. See Kassel (1995).

A substantial literature on  $q$ -deformed quantum-mechanical Schrödinger equations has developed recently. It involves  $q$ -generalizations of exponentials and Laguerre polynomials, and has been applied to the problems of the harmonic oscillator and Coulomb potentials. See Micu and Papp (2005), where many earlier references are cited.

## Computation

### 17.18 Methods of Computation

The two main methods for computing basic hypergeometric functions are: (1) numerical summation of the defining series given in §§17.4(i) and 17.4(ii); (2) modular transformations. Method (1) is applicable within the circles of convergence of the defining series, although it is often cumbersome owing to slowness of convergence and/or severe cancellation. Method (2) is very powerful when applicable (Andrews (1976, Chapter 5)); however, it is applicable only rarely. Lehner (1941) uses Method (2) in connection with the Rogers–Ramanujan identities.

Method (1) can sometimes be improved by application of convergence acceleration procedures; see §3.9. Shanks (1955) applies such methods in several  $q$ -series problems; see Andrews *et al.* (1986).

### 17.19 Software

See <http://dlmf.nist.gov/17.19>.

## References

### General References

The main reference used in writing this chapter is Gasper and Rahman (2004). For additional bibliographic reading see Andrews (1974, 1976, 1986), Andrews *et al.* (1999), Bailey (1935), Fine (1988), Kac and Cheung (2002), and Slater (1966).

### Sources

The following list gives the references or other indications of proofs that were used in constructing the various sections of this chapter. These sources supplement the references that are quoted in the text.

§17.2 Andrews (1976, pp. 17, 36, 37, 49 and §7.3). (17.2.43) is derived from (17.2.41); (17.2.42) and (17.2.44) follow by induction.

§17.5 Andrews (1976, pp. 17, 19, 36), Gasper and Rahman (2004, pp. 25–26).

§17.6 Gasper and Rahman (2004, pp. 13–15, 18, 23, 26–28, 115, 356, 363–364). For (17.6.9)–(17.6.12) see Fine (1988, pp. 12–15), and for (17.6.14) see Andrews (1966a).

- §17.7 Gasper and Rahman (2004, pp. 17, 19, 28–29, 42–44, 58, 61–62, 81–83, 355–356), Andrews (1996). For (17.7.3) combine Gasper and Rahman (2004, p. 359, Equation (III.4)) with (17.6.4).
- §17.8 Gasper and Rahman (2004, pp. 15–16, 52, 140–141, 146–147, 149–150, 153).
- §17.9 Gasper and Rahman (2004, pp. 43, 50, 63–64, 70–73, 359, 361), Andrews (1966b). For (17.9.11) apply (17.9.10) to (17.9.9) and interchange the roles of  $d$  and  $e$ .
- §17.10 Gasper and Rahman (2004, pp. 147–150, 364–366).
- §17.11 Andrews (1972).
- §17.12 Andrews (1984).
- §17.13 Gasper and Rahman (2004, p. 52), Berndt (1991, p. 29), Askey (1980).
- §17.14 Zeilberger and Bressoud (1985), Andrews (1986, p. 34).



## Chapter 18

# Orthogonal Polynomials

T. H. Koornwinder<sup>1</sup>, R. Wong<sup>2</sup>, R. Koekoek<sup>3</sup> and R. F. Swarttouw<sup>4</sup>

<b>Notation</b>	<b>436</b>	18.22 Hahn Class: Recurrence Relations and Differences . . . . .	464
18.1 Notation . . . . .	436	18.23 Hahn Class: Generating Functions . . . . .	466
<b>General Orthogonal Polynomials</b>	<b>437</b>	18.24 Hahn Class: Asymptotic Approximations . . . . .	466
18.2 General Orthogonal Polynomials . . . . .	437	18.25 Wilson Class: Definitions . . . . .	467
<b>Classical Orthogonal Polynomials</b>	<b>438</b>	18.26 Wilson Class: Continued . . . . .	468
18.3 Definitions . . . . .	438	<b>Other Orthogonal Polynomials</b>	<b>470</b>
18.4 Graphics . . . . .	440	18.27 $q$ -Hahn Class . . . . .	470
18.5 Explicit Representations . . . . .	442	18.28 Askey–Wilson Class . . . . .	472
18.6 Symmetry, Special Values, and Limits to Monomials . . . . .	443	18.29 Asymptotic Approximations for $q$ -Hahn and Askey–Wilson Classes . . . . .	474
18.7 Interrelations and Limit Relations . . . . .	444	18.30 Associated OP's . . . . .	474
18.8 Differential Equations . . . . .	445	18.31 Bernstein–Szegő Polynomials . . . . .	474
18.9 Recurrence Relations and Derivatives . . . . .	446	18.32 OP's with Respect to Freud Weights . . . . .	475
18.10 Integral Representations . . . . .	447	18.33 Polynomials Orthogonal on the Unit Circle . . . . .	475
18.11 Relations to Other Functions . . . . .	448	18.34 Bessel Polynomials . . . . .	476
18.12 Generating Functions . . . . .	449	18.35 Pollaczek Polynomials . . . . .	476
18.13 Continued Fractions . . . . .	450	18.36 Miscellaneous Polynomials . . . . .	477
18.14 Inequalities . . . . .	450	18.37 Classical OP's in Two or More Variables . . . . .	477
18.15 Asymptotic Approximations . . . . .	451	<b>Applications</b>	<b>478</b>
18.16 Zeros . . . . .	454	18.38 Mathematical Applications . . . . .	478
18.17 Integrals . . . . .	455	18.39 Physical Applications . . . . .	479
18.18 Sums . . . . .	459	<b>Computation</b>	<b>479</b>
<b>Askey Scheme</b>	<b>462</b>	18.40 Methods of Computation . . . . .	479
18.19 Hahn Class: Definitions . . . . .	462	18.41 Tables . . . . .	480
18.20 Hahn Class: Explicit Representations . . . . .	462	18.42 Software . . . . .	480
18.21 Hahn Class: Interrelations . . . . .	463	<b>References</b>	<b>480</b>

<sup>1</sup>University of Amsterdam, Korteweg–de Vries Institute, Amsterdam, The Netherlands.

<sup>2</sup>City University of Hong Kong, Liu Bie Ju Centre for Mathematical Sciences, Kowloon, Hong Kong.

<sup>3</sup>Delft University of Technology, Delft Institute of Applied Mathematics, Delft, The Netherlands.

<sup>4</sup>Vrije Universiteit Amsterdam, Department of Mathematics, Amsterdam, The Netherlands.

Copyright © 2009 National Institute of Standards and Technology. All rights reserved.

## Notation

### 18.1 Notation

#### 18.1(i) Special Notation

(For other notation see pp. xiv and 873.)

$x, y$	real variables.
$z (= x + iy)$	complex variable.
$q$	real variable such that $0 < q < 1$ , unless stated otherwise.
$\ell, m$	nonnegative integers.
$n$	nonnegative integer, except in §18.30.
$N$	positive integer.
$\delta(x - a)$	Dirac delta (§1.17).
$\delta$	arbitrary small positive constant.
$p_n(x)$	polynomial in $x$ of degree $n$ .
$p_{-1}(x)$	0.
$w(x)$	weight function ( $\geq 0$ ) on an open interval $(a, b)$ .
$w_x$	weights ( $> 0$ ) at points $x \in X$ of a finite or countably infinite subset of $\mathbb{R}$ .
OP's	orthogonal polynomials.

#### $x$ -Differences

Forward differences:

$$\begin{aligned}\Delta_x(f(x)) &= f(x+1) - f(x), \\ \Delta_x^{n+1}(f(x)) &= \Delta_x(\Delta_x^n(f(x))).\end{aligned}$$

Backward differences:

$$\begin{aligned}\nabla_x(f(x)) &= f(x) - f(x-1), \\ \nabla_x^{n+1}(f(x)) &= \nabla_x(\nabla_x^n(f(x))).\end{aligned}$$

Central differences in imaginary direction:

$$\begin{aligned}\delta_x(f(x)) &= (f(x + \frac{1}{2}i) - f(x - \frac{1}{2}i)) / i, \\ \delta_x^{n+1}(f(x)) &= \delta_x(\delta_x^n(f(x))).\end{aligned}$$

#### $q$ -Pochhammer Symbol

$$\begin{aligned}(z; q)_0 &= 1, \quad (z; q)_n = (1 - z)(1 - zq) \cdots (1 - zq^{n-1}), \\ (z_1, \dots, z_k; q)_n &= (z_1; q)_n \cdots (z_k; q)_n.\end{aligned}$$

#### Infinite $q$ -Product

$$\begin{aligned}(z; q)_\infty &= \prod_{j=0}^{\infty} (1 - zq^j), \\ (z_1, \dots, z_k; q)_\infty &= (z_1; q)_\infty \cdots (z_k; q)_\infty.\end{aligned}$$

#### 18.1(ii) Main Functions

The main functions treated in this chapter are:

#### Classical OP's

Jacobi:  $P_n^{(\alpha, \beta)}(x)$ .

Ultraspherical (or Gegenbauer):  $C_n^{(\lambda)}(x)$ .

Chebyshev of first, second, third, and fourth kinds:  $T_n(x), U_n(x), V_n(x), W_n(x)$ .

Shifted Chebyshev of first and second kinds:  $T_n^*(x), U_n^*(x)$ .

Legendre:  $P_n(x)$ .

Shifted Legendre:  $P_n^*(x)$ .

Laguerre:  $L_n^{(\alpha)}(x)$  and  $L_n(x) = L_n^{(0)}(x)$ . ( $L_n^{(\alpha)}(x)$  with  $\alpha \neq 0$  is also called Generalized Laguerre.)

Hermite:  $H_n(x), He_n(x)$ .

#### Hahn Class OP's

Hahn:  $Q_n(x; \alpha, \beta, N)$ .

Krawtchouk:  $K_n(x; p, N)$ .

Meixner:  $M_n(x; \beta, c)$ .

Charlier:  $C_n(x, a)$ .

Continuous Hahn:  $p_n(x; a, b, \bar{a}, \bar{b})$ .

Meixner–Pollaczek:  $F_n^{(\lambda)}(x; \phi)$ .

#### Wilson Class OP's

Wilson:  $W_n(x; a, b, c, d)$ .

Racah:  $R_n(x; \alpha, \beta, \gamma, \delta)$ .

Continuous Dual Hahn:  $S_n(x; a, b, c)$ .

Dual Hahn:  $R_n(x; \gamma, \delta, N)$ .

#### $q$ -Hahn Class OP's

$q$ -Hahn:  $Q_n(x; \alpha, \beta, N; q)$ .

Big  $q$ -Jacobi:  $P_n(x; a, b, c; q)$ .

Little  $q$ -Jacobi:  $p_n(x; a, b; q)$ .

$q$ -Laguerre:  $L_n^{(\alpha)}(x; q)$ .

Stieltjes–Wigert:  $S_n(x; q)$ .

Discrete  $q$ -Hermite I:  $h_n(x; q)$ .

Discrete  $q$ -Hermite II:  $\tilde{h}_n(x; q)$ .

#### Askey–Wilson Class OP's

Askey–Wilson:  $p_n(x; a, b, c, d | q)$ .

Al-Salam–Chihara:  $Q_n(x; a, b | q)$ .

Continuous  $q$ -Ultraspherical:  $C_n(x; \beta | q)$ .

Continuous  $q$ -Hermite:  $H_n(x | q)$ .

Continuous  $q^{-1}$ -Hermite:  $h_n(x | q)$ .

$q$ -Racah:  $R_n(x; \alpha, \beta, \gamma, \delta | q)$ .

**Other OP's**

Bessel:  $y_n(x; a)$ .

Pollaczek:  $P_n^{(\lambda)}(x; a, b)$ .

**Classical OP's in Two Variables**

Disk:  $R_{m,n}^{(\alpha)}$ .

Triangle:  $P_{m,n}^{\alpha,\beta,\gamma}(x, y)$ .

**18.1(iii) Other Notations**

In Szegö (1975, §4.7) the ultraspherical polynomials  $C_n^{(\lambda)}(x)$  are denoted by  $P_n^{(\lambda)}(x)$ . The ultraspherical polynomials will not be considered for  $\lambda = 0$ . They are defined in the literature by  $C_0^{(0)}(x) = 1$  and

$$18.1.1 \quad C_n^{(0)}(x) = \frac{2}{n} T_n(x) = \frac{2(n-1)!}{\left(\frac{1}{2}\right)_n} P_n^{(-\frac{1}{2}, -\frac{1}{2})}(x), \quad n = 1, 2, 3, \dots$$

Nor do we consider the shifted Jacobi polynomials:

$$18.1.2 \quad G_n(p, q, x) = \frac{n!}{(n+p)_n} P_n^{(p-q, q-1)}(2x-1),$$

or the dilated Chebyshev polynomials of the first and second kinds:

$$18.1.3 \quad C_n(x) = 2T_n\left(\frac{1}{2}x\right), \quad S_n(x) = U_n\left(\frac{1}{2}x\right).$$

In Koekoek and Swarttouw (1998)  $\delta_x$  denotes the operator  $i\delta_x$ .

General Orthogonal Polynomials

**18.2 General Orthogonal Polynomials**

**18.2(i) Definition**

**Orthogonality on Intervals**

Let  $(a, b)$  be a finite or infinite open interval in  $\mathbb{R}$ . A system (or set) of polynomials  $\{p_n(x)\}$ ,  $n = 0, 1, 2, \dots$ , is said to be *orthogonal on  $(a, b)$  with respect to the weight function  $w(x) (\geq 0)$  if*

$$18.2.1 \quad \int_a^b p_n(x)p_m(x)w(x) dx = 0, \quad n \neq m.$$

Here  $w(x)$  is continuous or piecewise continuous or integrable, and such that  $0 < \int_a^b x^{2n}w(x) dx < \infty$  for all  $n$ .

It is assumed throughout this chapter that for each polynomial  $p_n(x)$  that is orthogonal on an open interval  $(a, b)$  the variable  $x$  is confined to the closure of  $(a, b)$  unless indicated otherwise. (However, under appropriate conditions almost all equations given in the chapter can be continued analytically to various complex values of the variables.)

**Orthogonality on Finite Point Sets**

Let  $X$  be a finite set of distinct points on  $\mathbb{R}$ , or a countable infinite set of distinct points on  $\mathbb{R}$ , and  $w_x, x \in X$ , be a set of positive constants. Then a system of polynomials  $\{p_n(x)\}$ ,  $n = 0, 1, 2, \dots$ , is said to be *orthogonal on  $X$  with respect to the weights  $w_x$  if*

$$18.2.2 \quad \sum_{x \in X} p_n(x)p_m(x)w_x = 0, \quad n \neq m,$$

when  $X$  is infinite, or

$$18.2.3 \quad \sum_{x \in X} p_n(x)p_m(x)w_x = 0, \quad n, m = 0, 1, \dots, N; n \neq m,$$

when  $X$  is a finite set of  $N + 1$  distinct points. In the former case we also require

$$18.2.4 \quad \sum_{x \in X} x^{2n}w_x < \infty, \quad n = 0, 1, \dots,$$

whereas in the latter case the system  $\{p_n(x)\}$  is finite:  $n = 0, 1, \dots, N$ .

More generally than (18.2.1)–(18.2.3),  $w(x) dx$  may be replaced in (18.2.1) by a positive measure  $d\alpha(x)$ , where  $\alpha(x)$  is a bounded nondecreasing function on the closure of  $(a, b)$  with an infinite number of points of increase, and such that  $0 < \int_a^b x^{2n} d\alpha(x) < \infty$  for all  $n$ . See McDonald and Weiss (1999, Chapters 3, 4) and Szegö (1975, §1.4).

**18.2(ii)  $x$ -Difference Operators**

If the orthogonality discrete set  $X$  is  $\{0, 1, \dots, N\}$  or  $\{0, 1, 2, \dots\}$ , then the role of the differentiation operator  $d/dx$  in the case of classical OP's (§18.3) is played by  $\Delta_x$ , the forward-difference operator, or by  $\nabla_x$ , the backward-difference operator; compare §18.1(i). This happens, for example, with the Hahn class OP's (§18.20(i)).

If the orthogonality interval is  $(-\infty, \infty)$  or  $(0, \infty)$ , then the role of  $d/dx$  can be played by  $\delta_x$ , the central-difference operator in the imaginary direction (§18.1(ii)). This happens, for example, with the continuous Hahn polynomials and Meixner–Pollaczek polynomials (§18.20(i)).

**18.2(iii) Normalization**

The orthogonality relations (18.2.1)–(18.2.3) each determine the polynomials  $p_n(x)$  uniquely up to constant factors, which may be fixed by suitable normalization.

If we define

$$18.2.5 \quad h_n = \int_a^b (p_n(x))^2 w(x) dx \text{ or } \sum_{x \in X} (p_n(x))^2 w_x,$$

**18.2.6**

$$\tilde{h}_n = \int_a^b x (p_n(x))^2 w(x) dx \text{ or } \sum_{x \in X} x (p_n(x))^2 w_x,$$

and

$$18.2.7 \quad p_n(x) = k_n x^n + \tilde{k}_n x^{n-1} + \tilde{\tilde{k}}_n x^{n-2} + \dots,$$

then two special normalizations are: (i) *orthonormal OP's*:  $h_n = 1, k_n > 0$ ; (ii) *monic OP's*:  $k_n = 1$ .

**18.2(iv) Recurrence Relations**

As in §18.1(i) we assume that  $p_{-1}(x) \equiv 0$ .

**First Form****18.2.8**

$$p_{n+1}(x) = (A_n x + B_n)p_n(x) - C_n p_{n-1}(x), \quad n \geq 0.$$

Here  $A_n, B_n$  ( $n \geq 0$ ), and  $C_n$  ( $n \geq 1$ ) are real constants, and  $A_{n-1}A_n C_n > 0$  for  $n \geq 1$ . Then

**18.2.9**

$$A_n = \frac{k_{n+1}}{k_n}, \quad B_n = \left( \frac{\tilde{k}_{n+1}}{k_{n+1}} - \frac{\tilde{k}_n}{k_n} \right) A_n = -\frac{\tilde{h}_n}{h_n} A_n,$$

$$C_n = \frac{A_n \tilde{k}_n + B_n \tilde{k}_n - \tilde{\tilde{k}}_{n+1}}{k_{n-1}} = \frac{A_n}{A_{n-1}} \frac{h_n}{h_{n-1}}.$$

**Second Form****18.2.10**

$$x p_n(x) = a_n p_{n+1}(x) + b_n p_n(x) + c_n p_{n-1}(x), \quad n \geq 0.$$

Here  $a_n, b_n$  ( $n \geq 0$ ),  $c_n$  ( $n \geq 1$ ) are real constants, and  $a_{n-1}c_n > 0$  ( $n \geq 1$ ). Then

$$a_n = \frac{k_n}{k_{n+1}}, \quad b_n = \frac{\tilde{k}_n}{k_n} - \frac{\tilde{k}_{n+1}}{k_{n+1}} = \frac{\tilde{h}_n}{h_n},$$

**18.2.11**

$$c_n = \frac{\tilde{\tilde{k}}_n - a_n \tilde{\tilde{k}}_{n+1} - b_n \tilde{k}_n}{k_{n-1}} = a_{n-1} \frac{h_n}{h_{n-1}}.$$

If the OP's are orthonormal, then  $c_n = a_{n-1}$  ( $n \geq 1$ ).

If the OP's are monic, then  $a_n = 1$  ( $n \geq 0$ ).

Conversely, if a system of polynomials  $\{p_n(x)\}$  satisfies (18.2.10) with  $a_{n-1}c_n > 0$  ( $n \geq 1$ ), then  $\{p_n(x)\}$

is orthogonal with respect to some positive measure on  $\mathbb{R}$  (Favard's theorem). The measure is not necessarily of the form  $w(x) dx$  nor is it necessarily unique.

**18.2(v) Christoffel–Darboux Formula****18.2.12**

$$\sum_{\ell=0}^n \frac{p_\ell(x)p_\ell(y)}{h_\ell} = \frac{k_n}{h_n k_{n+1}} \frac{p_{n+1}(x)p_n(y) - p_n(x)p_{n+1}(y)}{x - y},$$

$x \neq y.$

**Confluent Form****18.2.13**

$$\sum_{\ell=0}^n \frac{(p_\ell(x))^2}{h_\ell} = \frac{k_n}{h_n k_{n+1}} (p'_{n+1}(x)p_n(x) - p'_n(x)p_{n+1}(x)).$$

**18.2(vi) Zeros**

All  $n$  zeros of an OP  $p_n(x)$  are simple, and they are located in the interval of orthogonality  $(a, b)$ . The zeros of  $p_n(x)$  and  $p_{n+1}(x)$  separate each other, and if  $m < n$  then between any two zeros of  $p_m(x)$  there is at least one zero of  $p_n(x)$ .

For illustrations of these properties see Figures 18.4.1–18.4.7.

**Classical Orthogonal Polynomials****18.3 Definitions**

Table 18.3.1 provides the definitions of Jacobi, Laguerre, and Hermite polynomials via orthogonality and normalization (§§18.2(i) and 18.2(iii)). This table also includes the following special cases of Jacobi polynomials: ultraspherical, Chebyshev, and Legendre.

Table 18.3.1: Orthogonality properties for classical OP's: intervals, weight functions, normalizations, leading coefficients, and parameter constraints. In the second row  $\mathcal{A}$  denotes  $2^{\alpha+\beta+1}\Gamma(n+\alpha+1)\Gamma(n+\beta+1)/((2n+\alpha+\beta+1)\Gamma(n+\alpha+\beta+1)n!)$ . For further implications of the parameter constraints see the *Note* in §18.5(iii).

Name	$p_n(x)$	$(a, b)$	$w(x)$	$h_n$	$k_n$	$\tilde{k}_n/k_n$	Constraints
Jacobi	$P_n^{(\alpha,\beta)}(x)$	$(-1, 1)$	$(1-x)^\alpha(1+x)^\beta$	$\mathcal{A}$	$\frac{(n+\alpha+\beta+1)_n}{2^n n!}$	$\frac{n(\alpha-\beta)}{2n+\alpha+\beta}$	$\alpha, \beta > -1$
Ultraspherical (Gegenbauer)	$C_n^{(\lambda)}(x)$	$(-1, 1)$	$(1-x^2)^{\lambda-\frac{1}{2}}$	$\frac{2^{1-2\lambda}\pi\Gamma(n+2\lambda)}{(n+\lambda)(\Gamma(\lambda))^2 n!}$	$\frac{2^n(\lambda)_n}{n!}$	0	$\lambda > -\frac{1}{2}, \lambda \neq 0$
Chebyshev of first kind	$T_n(x)$	$(-1, 1)$	$(1-x^2)^{-\frac{1}{2}}$	$\begin{cases} \frac{1}{2}\pi, & n > 0 \\ \pi, & n = 0 \end{cases}$	$\begin{cases} 2^{n-1}, & n > 0 \\ 1, & n = 0 \end{cases}$	0	
Chebyshev of second kind	$U_n(x)$	$(-1, 1)$	$(1-x^2)^{\frac{1}{2}}$	$\frac{1}{2}\pi$	$2^n$	0	
Chebyshev of third kind	$V_n(x)$	$(-1, 1)$	$(1-x)^{\frac{1}{2}}(1+x)^{-\frac{1}{2}}$	$\pi$	$2^n$	$\frac{1}{2}$	
Chebyshev of fourth kind	$W_n(x)$	$(-1, 1)$	$(1-x)^{-\frac{1}{2}}(1+x)^{\frac{1}{2}}$	$\pi$	$2^n$	$-\frac{1}{2}$	
Shifted Chebyshev of first kind	$T_n^*(x)$	$(0, 1)$	$(x-x^2)^{-\frac{1}{2}}$	$\begin{cases} \frac{1}{2}\pi, & n > 0 \\ \pi, & n = 0 \end{cases}$	$\begin{cases} 2^{2n-1}, & n > 0 \\ 1, & n = 0 \end{cases}$	$-\frac{1}{2}n$	
Shifted Chebyshev of second kind	$U_n^*(x)$	$(0, 1)$	$(x-x^2)^{\frac{1}{2}}$	$\frac{1}{8}\pi$	$2^{2n}$	$-\frac{1}{2}n$	
Legendre	$P_n(x)$	$(-1, 1)$	1	$2/(2n+1)$	$2^n \left(\frac{1}{2}\right)_n / n!$	0	
Shifted Legendre	$P_n^*(x)$	$(0, 1)$	1	$1/(2n+1)$	$2^{2n} \left(\frac{1}{2}\right)_n / n!$	$-\frac{1}{2}n$	
Laguerre	$L_n^{(\alpha)}(x)$	$(0, \infty)$	$e^{-x}x^\alpha$	$\Gamma(n+\alpha+1)/n!$	$(-1)^n/n!$	$-n(n+\alpha)$	$\alpha > -1$
Hermite	$H_n(x)$	$(-\infty, \infty)$	$e^{-x^2}$	$\pi^{\frac{1}{2}}2^n n!$	$2^n$	0	
Hermite	$He_n(x)$	$(-\infty, \infty)$	$e^{-\frac{1}{2}x^2}$	$(2\pi)^{\frac{1}{2}}n!$	1	0	



For exact values of the coefficients of the Jacobi polynomials  $P_n^{(\alpha,\beta)}(x)$ , the ultraspherical polynomials  $C_n^{(\lambda)}(x)$ , the Chebyshev polynomials  $T_n(x)$  and  $U_n(x)$ , the Legendre polynomials  $P_n(x)$ , the Laguerre polynomials  $L_n(x)$ , and the Hermite polynomials  $H_n(x)$ , see Abramowitz and Stegun (1964, pp. 793–801). The Jacobi polynomials are in powers of  $x - 1$  for  $n = 0, 1, \dots, 6$ . The ultraspherical polynomials are in powers of  $x$  for  $n = 0, 1, \dots, 6$ . The other polynomials are in powers of  $x$  for  $n = 0, 1, \dots, 12$ . See also §18.5(iv).

**Chebyshev**

In this chapter, formulas for the Chebyshev polynomials of the second, third, and fourth kinds will not be given as extensively as those of the first kind. However, most of these formulas can be obtained by specialization of formulas for Jacobi polynomials, via (18.7.4)–(18.7.6).

In addition to the orthogonal property given by Table 18.3.1, the Chebyshev polynomials  $T_n(x)$ ,  $n = 0, 1, \dots, N$ , are orthogonal on the discrete point set comprising the zeros  $x_{N+1,n}$ ,  $n = 1, 2, \dots, N+1$ , of  $T_{N+1}(x)$ :

$$18.3.1 \quad \sum_{n=1}^{N+1} T_j(x_{N+1,n}) T_k(x_{N+1,n}) = 0, \quad 0 \leq j \leq N, 0 \leq k \leq N, j \neq k,$$

where

$$18.3.2 \quad x_{N+1,n} = \cos\left(\left(n - \frac{1}{2}\right)\pi / (N + 1)\right).$$

When  $j = k \neq 0$  the sum in (18.3.1) is  $\frac{1}{2}(N + 1)$ . When  $j = k = 0$  the sum in (18.3.1) is  $N + 1$ .

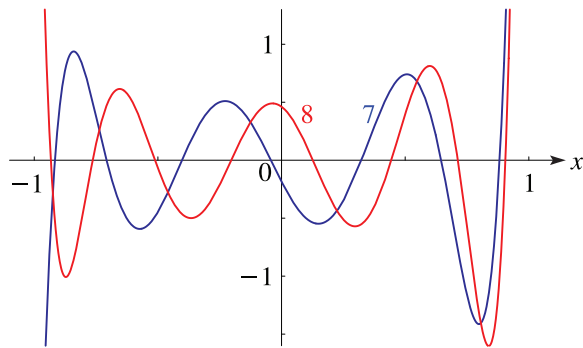


Figure 18.4.2: Jacobi polynomials  $P_n^{(1.25,0.75)}(x)$ ,  $n = 7, 8$ . This illustrates inequalities for extrema of a Jacobi polynomial; see (18.14.16). See also Askey (1990).

For proofs of these results and for similar properties of the Chebyshev polynomials of the second, third, and fourth kinds see Mason and Handscomb (2003, §4.6).

For another version of the discrete orthogonality property of the polynomials  $T_n(x)$  see (3.11.9).

**Legendre**

Legendre polynomials are special cases of Legendre functions, Ferrers functions, and associated Legendre functions (§14.7(i)). In consequence, additional properties are included in Chapter 14.

**18.4 Graphics**

**18.4(i) Graphs**

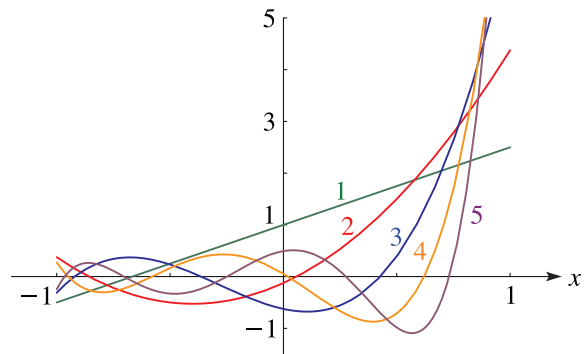


Figure 18.4.1: Jacobi polynomials  $P_n^{(1.5,-0.5)}(x)$ ,  $n = 1, 2, 3, 4, 5$ .

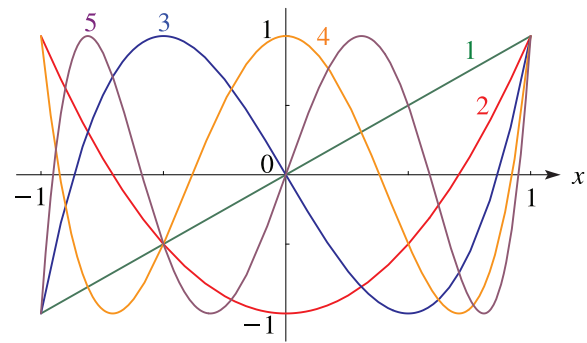


Figure 18.4.3: Chebyshev polynomials  $T_n(x)$ ,  $n = 1, 2, 3, 4, 5$ .

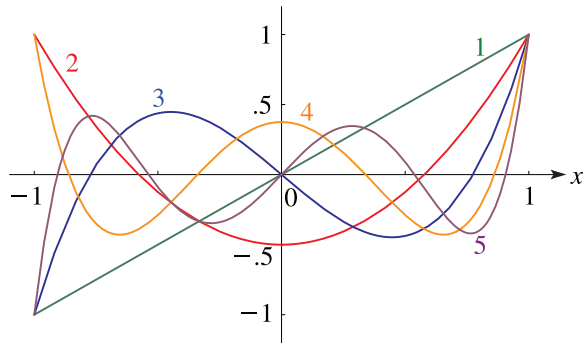


Figure 18.4.4: Legendre polynomials  $P_n(x)$ ,  $n = 1, 2, 3, 4, 5$ .

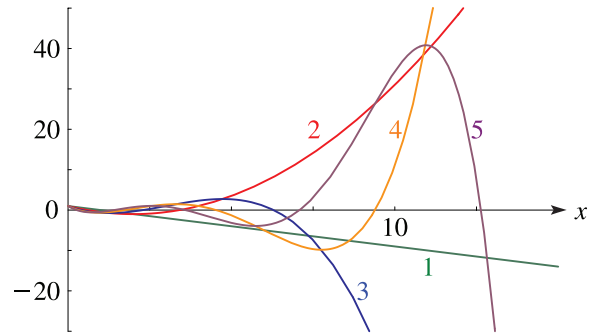


Figure 18.4.5: Laguerre polynomials  $L_n(x)$ ,  $n = 1, 2, 3, 4, 5$ .

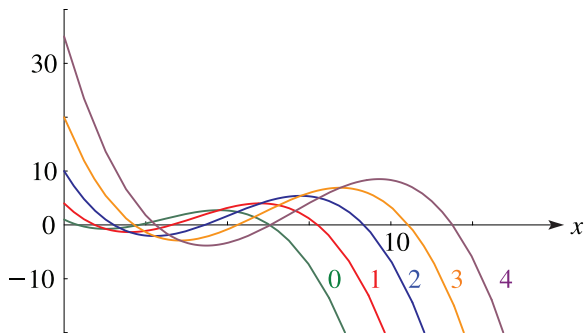


Figure 18.4.6: Laguerre polynomials  $L_3^{(\alpha)}(x)$ ,  $\alpha = 0, 1, 2, 3, 4$ .

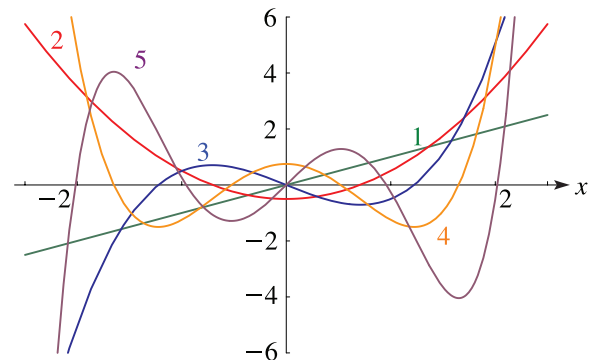


Figure 18.4.7: Monic Hermite polynomials  $h_n(x) = 2^{-n} H_n(x)$ ,  $n = 1, 2, 3, 4, 5$ .

18.4(ii) Surfaces

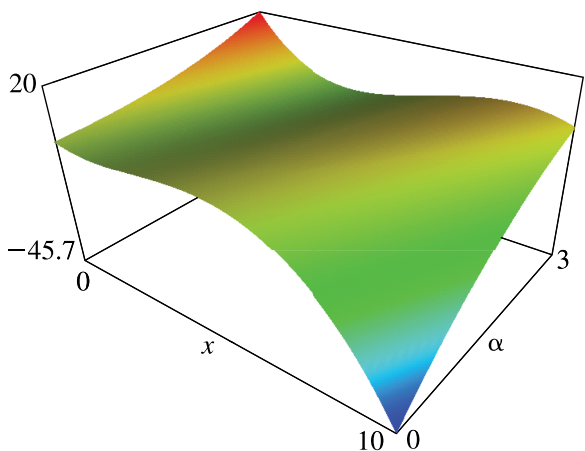


Figure 18.4.8: Laguerre polynomials  $L_3^{(\alpha)}(x)$ ,  $0 \leq \alpha \leq 3$ ,  $0 \leq x \leq 10$ .

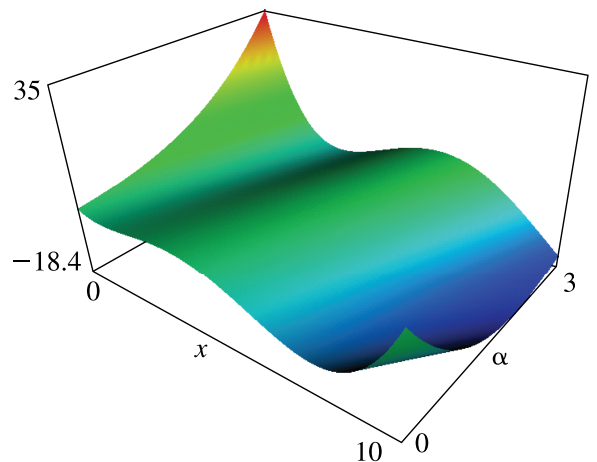


Figure 18.4.9: Laguerre polynomials  $L_4^{(\alpha)}(x)$ ,  $0 \leq \alpha \leq 3$ ,  $0 \leq x \leq 10$ .

### 18.5 Explicit Representations

#### 18.5(i) Trigonometric Functions

**Chebyshev**

With  $x = \cos \theta$ ,

18.5.1  $T_n(x) = \cos(n\theta),$

18.5.2  $U_n(x) = (\sin(n+1)\theta)/\sin \theta,$

18.5.3  $V_n(x) = (\sin(n + \frac{1}{2})\theta)/\sin(\frac{1}{2}\theta),$

18.5.4  $W_n(x) = (\cos(n + \frac{1}{2})\theta)/\cos(\frac{1}{2}\theta).$

#### 18.5(ii) Rodrigues Formulas

18.5.5 
$$p_n(x) = \frac{1}{\kappa_n w(x)} \frac{d^n}{dx^n} (w(x)(F(x))^n).$$

In this equation  $w(x)$  is as in Table 18.3.1, and  $F(x)$ ,  $\kappa_n$  are as in Table 18.5.1.

Table 18.5.1: Classical OP's: Rodrigues formulas (18.5.5).

$p_n(x)$	$F(x)$	$\kappa_n$
$P_n^{(\alpha,\beta)}(x)$	$1-x^2$	$(-2)^n n!$
$C_n^{(\lambda)}(x)$	$1-x^2$	$\frac{(-2)^n (\lambda + \frac{1}{2})_n n!}{(2\lambda)_n}$
$T_n(x)$	$1-x^2$	$(-2)^n (\frac{1}{2})_n$
$U_n(x)$	$1-x^2$	$\frac{(-2)^n (\frac{3}{2})_n}{n+1}$
$V_n(x)$	$1-x^2$	$\frac{(-2)^n (\frac{3}{2})_n}{2n+1}$
$W_n(x)$	$1-x^2$	$(-2)^n (\frac{1}{2})_n$
$P_n(x)$	$1-x^2$	$(-2)^n n!$
$L_n^{(\alpha)}(x)$	$x$	$n!$
$H_n(x)$	$1$	$(-1)^n$
$He_n(x)$	$1$	$(-1)^n$

Related formula:

18.5.6

$$L_n^{(\alpha)}\left(\frac{1}{x}\right) = \frac{(-1)^n}{n!} x^{n+\alpha+1} e^{1/x} \frac{d^n}{dx^n} \left(x^{-\alpha-1} e^{-1/x}\right).$$

#### 18.5(iii) Finite Power Series, the Hypergeometric Function, and Generalized Hypergeometric Functions

For the definitions of  ${}_2F_1$ ,  ${}_1F_1$ , and  ${}_2F_0$  see §16.2.

**Jacobi**

18.5.7

$$\begin{aligned} P_n^{(\alpha,\beta)}(x) &= \sum_{\ell=0}^n \frac{(n+\alpha+\beta+1)_\ell (\alpha+\ell+1)_{n-\ell}}{\ell! (n-\ell)!} \left(\frac{x-1}{2}\right)^\ell \\ &= \frac{(\alpha+1)_n}{n!} {}_2F_1\left(\begin{matrix} -n, n+\alpha+\beta+1 \\ \alpha+1 \end{matrix}; \frac{1-x}{2}\right), \end{aligned}$$

18.5.8

$$\begin{aligned} P_n^{(\alpha,\beta)}(x) &= 2^{-n} \sum_{\ell=0}^n \binom{n+\alpha}{\ell} \binom{n+\beta}{n-\ell} (x-1)^{n-\ell} (x+1)^\ell \\ &= \frac{(\alpha+1)_n}{n!} \left(\frac{x+1}{2}\right)^n {}_2F_1\left(\begin{matrix} -n, -n-\beta \\ \alpha+1 \end{matrix}; \frac{x-1}{x+1}\right), \end{aligned}$$

and two similar formulas by symmetry; compare the second row in Table 18.6.1.

**Ultraspherical**

18.5.9 
$$C_n^{(\lambda)}(x) = \frac{(2\lambda)_n}{n!} {}_2F_1\left(\begin{matrix} -n, n+2\lambda \\ \lambda + \frac{1}{2} \end{matrix}; \frac{1-x}{2}\right),$$

18.5.10

$$\begin{aligned} C_n^{(\lambda)}(x) &= \sum_{\ell=0}^{\lfloor n/2 \rfloor} \frac{(-1)^\ell (\lambda)_{n-\ell}}{\ell! (n-2\ell)!} (2x)^{n-2\ell} \\ &= (2x)^n \frac{(\lambda)_n}{n!} {}_2F_1\left(\begin{matrix} -\frac{1}{2}n, -\frac{1}{2}n + \frac{1}{2} \\ 1-\lambda-n \end{matrix}; \frac{1}{x^2}\right), \end{aligned}$$

$$C_n^{(\lambda)}(\cos \theta) = \sum_{\ell=0}^n \frac{(\lambda)_\ell (\lambda)_{n-\ell}}{\ell! (n-\ell)!} \cos((n-2\ell)\theta)$$

18.5.11

$$= e^{in\theta} \frac{(\lambda)_n}{n!} {}_2F_1\left(\begin{matrix} -n, \lambda \\ 1-\lambda-n \end{matrix}; e^{-2i\theta}\right).$$

**Laguerre**

$$\begin{aligned}
 18.5.12 \quad L_n^{(\alpha)}(x) &= \sum_{\ell=0}^n \frac{(\alpha + \ell + 1)_{n-\ell}}{(n-\ell)! \ell!} (-x)^\ell \\
 &= \frac{(\alpha + 1)_n}{n!} {}_1F_1\left(\begin{matrix} -n \\ \alpha + 1 \end{matrix}; x\right).
 \end{aligned}$$

**Hermite**

$$\begin{aligned}
 18.5.13 \quad H_n(x) &= n! \sum_{\ell=0}^{\lfloor n/2 \rfloor} \frac{(-1)^\ell (2x)^{n-2\ell}}{\ell! (n-2\ell)!} \\
 &= (2x)^n {}_2F_0\left(\begin{matrix} -\frac{1}{2}n, -\frac{1}{2}n + \frac{1}{2} \\ - \end{matrix}; -\frac{1}{x^2}\right).
 \end{aligned}$$

For corresponding formulas for Chebyshev, Legendre, and the Hermite  $He_n$  polynomials apply (18.7.3)–(18.7.6), (18.7.9), and (18.7.11).

*Note.* The first of each of equations (18.5.7) and (18.5.8) can be regarded as definitions of  $P_n^{(\alpha,\beta)}(x)$  when the conditions  $\alpha > -1$  and  $\beta > -1$  are not satisfied. However, in these circumstances the orthogonality property (18.2.1) disappears. For this reason, and also in the interest of simplicity, in the case of the Jacobi polynomials  $P_n^{(\alpha,\beta)}(x)$  we assume throughout this chapter that  $\alpha > -1$  and  $\beta > -1$ , *unless stated otherwise*. Similarly in the cases of the ultraspherical polynomials  $C_n^{(\lambda)}(x)$  and the Laguerre polynomials  $L_n^{(\alpha)}(x)$  we assume that  $\lambda > -\frac{1}{2}$ ,  $\lambda \neq 0$ , and  $\alpha > -1$ , *unless stated otherwise*.

**18.5(iv) Numerical Coefficients**

**Chebyshev**

$$\begin{aligned}
 18.5.14 \quad T_0(x) &= 1, \quad T_1(x) = x, \quad T_2(x) = 2x^2 - 1, \\
 T_3(x) &= 4x^3 - 3x, \quad T_4(x) = 8x^4 - 8x^2 + 1, \\
 T_5(x) &= 16x^5 - 20x^3 + 5x, \\
 T_6(x) &= 32x^6 - 48x^4 + 18x^2 - 1.
 \end{aligned}$$

$$\begin{aligned}
 18.5.15 \quad U_0(x) &= 1, \quad U_1(x) = 2x, \quad U_2(x) = 4x^2 - 1, \\
 U_3(x) &= 8x^3 - 4x, \quad U_4(x) = 16x^4 - 12x^2 + 1, \\
 U_5(x) &= 32x^5 - 32x^3 + 6x, \\
 U_6(x) &= 64x^6 - 80x^4 + 24x^2 - 1.
 \end{aligned}$$

**Legendre**

$$\begin{aligned}
 18.5.16 \quad P_0(x) &= 1, \quad P_1(x) = x, \quad P_2(x) = \frac{3}{2}x^2 - \frac{1}{2}, \\
 P_3(x) &= \frac{5}{2}x^3 - \frac{3}{2}x, \quad P_4(x) = \frac{35}{8}x^4 - \frac{15}{4}x^2 + \frac{3}{8}, \\
 P_5(x) &= \frac{63}{8}x^5 - \frac{35}{4}x^3 + \frac{15}{8}x, \\
 P_6(x) &= \frac{231}{16}x^6 - \frac{315}{16}x^4 + \frac{105}{16}x^2 - \frac{5}{16}.
 \end{aligned}$$

**Laguerre**

$$\begin{aligned}
 18.5.17 \quad L_0(x) &= 1, \quad L_1(x) = -x + 1, \quad L_2(x) = \frac{1}{2}x^2 - 2x + 1, \\
 L_3(x) &= -\frac{1}{6}x^3 + \frac{3}{2}x^2 - 3x + 1, \\
 L_4(x) &= \frac{1}{24}x^4 - \frac{2}{3}x^3 + 3x^2 - 4x + 1, \\
 L_5(x) &= -\frac{1}{120}x^5 + \frac{5}{24}x^4 - \frac{5}{3}x^3 + 5x^2 - 5x + 1, \\
 L_6(x) &= \frac{1}{720}x^6 - \frac{1}{20}x^5 + \frac{5}{8}x^4 - \frac{10}{3}x^3 + \frac{15}{2}x^2 - 6x + 1.
 \end{aligned}$$

**Hermite**

$$\begin{aligned}
 18.5.18 \quad H_0(x) &= 1, \quad H_1(x) = 2x, \quad H_2(x) = 4x^2 - 2, \\
 H_3(x) &= 8x^3 - 12x, \quad H_4(x) = 16x^4 - 48x^2 + 12, \\
 H_5(x) &= 32x^5 - 160x^3 + 120x, \\
 H_6(x) &= 64x^6 - 480x^4 + 720x^2 - 120. \\
 18.5.19 \quad He_0(x) &= 1, \quad He_1(x) = x, \quad He_2(x) = x^2 - 1, \\
 He_3(x) &= x^3 - 3x, \quad He_4(x) = x^4 - 6x^2 + 3, \\
 He_5(x) &= x^5 - 10x^3 + 15x, \\
 He_6(x) &= x^6 - 15x^4 + 45x^2 - 15.
 \end{aligned}$$

For the corresponding polynomials of degrees 7 through 12 see Abramowitz and Stegun (1964, Tables 22.3, 22.5, 22.9, 22.10, 22.12).

**18.6 Symmetry, Special Values, and Limits to Monomials**

**18.6(i) Symmetry and Special Values**

For Jacobi, ultraspherical, Chebyshev, Legendre, and Hermite polynomials, see Table 18.6.1.

**Laguerre**

$$18.6.1 \quad L_n^{(\alpha)}(0) = \frac{(\alpha + 1)_n}{n!}.$$

Table 18.6.1: Classical OP's: symmetry and special values.

$p_n(x)$	$p_n(-x)$	$p_n(1)$	$p_{2n}(0)$	$p'_{2n+1}(0)$
$P_n^{(\alpha,\beta)}(x)$	$(-1)^n P_n^{(\beta,\alpha)}(x)$	$(\alpha + 1)_n/n!$		
$P_n^{(\alpha,\alpha)}(x)$	$(-1)^n P_n^{(\alpha,\alpha)}(x)$	$(\alpha + 1)_n/n!$	$(-\frac{1}{4})^n (n + \alpha + 1)_n/n!$	$(-\frac{1}{4})^n (n + \alpha + 1)_{n+1}/n!$
$C_n^{(\lambda)}(x)$	$(-1)^n C_n^{(\lambda)}(x)$	$(2\lambda)_n/n!$	$(-1)^n (\lambda)_n/n!$	$2(-1)^n (\lambda)_{n+1}/n!$
$T_n(x)$	$(-1)^n T_n(x)$	1	$(-1)^n$	$(-1)^n (2n + 1)$
$U_n(x)$	$(-1)^n U_n(x)$	$n + 1$	$(-1)^n$	$(-1)^n (2n + 2)$
$V_n(x)$	$(-1)^n W_n(x)$	$2n + 1$	$(-1)^n$	$(-1)^n (2n + 2)$
$W_n(x)$	$(-1)^n V_n(x)$	1	$(-1)^n$	$(-1)^n (2n + 2)$
$P_n(x)$	$(-1)^n P_n(x)$	1	$(-1)^n (\frac{1}{2})_n/n!$	$2(-1)^n (\frac{1}{2})_{n+1}/n!$
$H_n(x)$	$(-1)^n H_n(x)$		$(-1)^n (n + 1)_n$	$2(-1)^n (n + 1)_{n+1}$
$He_n(x)$	$(-1)^n He_n(x)$		$(-\frac{1}{2})^n (n + 1)_n$	$(-\frac{1}{2})^n (n + 1)_{n+1}$

**18.6(ii) Limits to Monomials**

18.6.2 
$$\lim_{\alpha \rightarrow \infty} \frac{P_n^{(\alpha,\beta)}(x)}{P_n^{(\alpha,\beta)}(1)} = \left(\frac{1+x}{2}\right)^n,$$

18.6.3 
$$\lim_{\beta \rightarrow \infty} \frac{P_n^{(\alpha,\beta)}(x)}{P_n^{(\alpha,\beta)}(-1)} = \left(\frac{1-x}{2}\right)^n,$$

18.6.4 
$$\lim_{\lambda \rightarrow \infty} \frac{C_n^{(\lambda)}(x)}{C_n^{(\lambda)}(1)} = x^n,$$

18.6.5 
$$\lim_{\alpha \rightarrow \infty} \frac{L_n^{(\alpha)}(\alpha x)}{L_n^{(\alpha)}(0)} = (1-x)^n.$$

**18.7 Interrelations and Limit Relations**

**18.7(i) Linear Transformations**

**Ultraspherical and Jacobi**

18.7.1 
$$C_n^{(\lambda)}(x) = \frac{(2\lambda)_n}{(\lambda + \frac{1}{2})_n} P_n^{(\lambda - \frac{1}{2}, \lambda - \frac{1}{2})}(x),$$

18.7.2 
$$P_n^{(\alpha,\alpha)}(x) = \frac{(\alpha + 1)_n}{(2\alpha + 1)_n} C_n^{(\alpha + \frac{1}{2})}(x).$$

**Chebyshev, Ultraspherical, and Jacobi**

18.7.3 
$$T_n(x) = P_n^{(-\frac{1}{2}, -\frac{1}{2})}(x) / P_n^{(-\frac{1}{2}, -\frac{1}{2})}(1),$$

18.7.4 
$$U_n(x) = C_n^{(1)}(x) = (n + 1) P_n^{(\frac{1}{2}, \frac{1}{2})}(x) / P_n^{(\frac{1}{2}, \frac{1}{2})}(1),$$

18.7.5 
$$V_n(x) = (2n + 1) P_n^{(\frac{1}{2}, -\frac{1}{2})}(x) / P_n^{(\frac{1}{2}, -\frac{1}{2})}(1),$$

18.7.6 
$$W_n(x) = P_n^{(-\frac{1}{2}, \frac{1}{2})}(x) / P_n^{(-\frac{1}{2}, \frac{1}{2})}(1).$$

18.7.7 
$$T_n^*(x) = T_n(2x - 1),$$

18.7.8 
$$U_n^*(x) = U_n(2x - 1).$$

See also (18.9.9)–(18.9.12).

**Legendre, Ultraspherical, and Jacobi**

18.7.9 
$$P_n(x) = C_n^{(\frac{1}{2})}(x) = P_n^{(0,0)}(x).$$

18.7.10 
$$P_n^*(x) = P_n(2x - 1).$$

**Hermite**

18.7.11 
$$He_n(x) = 2^{-\frac{1}{2}n} H_n\left(2^{-\frac{1}{2}}x\right),$$

18.7.12 
$$H_n(x) = 2^{\frac{1}{2}n} He_n\left(2^{\frac{1}{2}}x\right).$$

**18.7(ii) Quadratic Transformations**

18.7.13  $\frac{P_{2n}^{(\alpha,\alpha)}(x)}{P_{2n}^{(\alpha,\alpha)}(1)} = \frac{P_n^{(\alpha,-\frac{1}{2})}(2x^2-1)}{P_n^{(\alpha,-\frac{1}{2})}(1)},$

18.7.14  $\frac{P_{2n+1}^{(\alpha,\alpha)}(x)}{P_{2n+1}^{(\alpha,\alpha)}(1)} = \frac{x P_n^{(\alpha,\frac{1}{2})}(2x^2-1)}{P_n^{(\alpha,\frac{1}{2})}(1)}.$

18.7.15  $C_{2n}^{(\lambda)}(x) = \frac{(\lambda)_n}{(\frac{1}{2})_n} P_n^{(\lambda-\frac{1}{2},-\frac{1}{2})}(2x^2-1),$

18.7.16  $C_{2n+1}^{(\lambda)}(x) = \frac{(\lambda)_{n+1}}{(\frac{1}{2})_{n+1}} x P_n^{(\lambda-\frac{1}{2},\frac{1}{2})}(2x^2-1).$

18.7.17  $U_{2n}(x) = V_n(2x^2-1),$

18.7.18  $T_{2n+1}(x) = x W_n(2x^2-1).$

18.7.19  $H_{2n}(x) = (-1)^n 2^{2n} n! L_n^{(-\frac{1}{2})}(x^2),$

18.7.20  $H_{2n+1}(x) = (-1)^n 2^{2n+1} n! x L_n^{(\frac{1}{2})}(x^2).$

**18.7(iii) Limit Relations**

Jacobi  $\rightarrow$  Laguerre

18.7.21  $\lim_{\beta \rightarrow \infty} P_n^{(\alpha,\beta)}(1 - (2x/\beta)) = L_n^{(\alpha)}(x).$

18.7.22  $\lim_{\alpha \rightarrow \infty} P_n^{(\alpha,\beta)}((2x/\alpha) - 1) = (-1)^n L_n^{(\beta)}(x).$

Jacobi  $\rightarrow$  Hermite

18.7.23  $\lim_{\alpha \rightarrow \infty} \alpha^{-\frac{1}{2}n} P_n^{(\alpha,\alpha)}(\alpha^{-\frac{1}{2}}x) = \frac{H_n(x)}{2^n n!}.$

Ultraspherical  $\rightarrow$  Hermite

18.7.24  $\lim_{\lambda \rightarrow \infty} \lambda^{-\frac{1}{2}n} C_n^{(\lambda)}(\lambda^{-\frac{1}{2}}x) = \frac{H_n(x)}{n!}.$

18.7.25  $\lim_{\lambda \rightarrow 0} \frac{1}{\lambda} C_n^{(\lambda)}(x) = \frac{2}{n} T_n(x), \quad n \geq 1.$

Laguerre  $\rightarrow$  Hermite

18.7.26

$$\lim_{\alpha \rightarrow \infty} \left(\frac{2}{\alpha}\right)^{\frac{1}{2}n} L_n^{(\alpha)}\left((2\alpha)^{\frac{1}{2}}x + \alpha\right) = \frac{(-1)^n}{n!} H_n(x).$$

See Figure 18.21.1 for the Askey schematic representation of most of these limits.

**18.8 Differential Equations**

See Table 18.8.1 and also Table 22.6 of Abramowitz and Stegun (1964).

Table 18.8.1: Classical OP's: differential equations  $A(x)f''(x) + B(x)f'(x) + C(x)f(x) + \lambda_n f(x) = 0.$

$f(x)$	$A(x)$	$B(x)$	$C(x)$	$\lambda_n$
$P_n^{(\alpha,\beta)}(x)$	$1 - x^2$	$\beta - \alpha - (\alpha + \beta + 2)x$	0	$n(n + \alpha + \beta + 1)$
$(\sin \frac{1}{2}x)^{\alpha+\frac{1}{2}} (\cos \frac{1}{2}x)^{\beta+\frac{1}{2}}$ $\times P_n^{(\alpha,\beta)}(\cos x)$	1	0	$\frac{\frac{1}{4} - \alpha^2}{4 \sin^2 \frac{1}{2}x} + \frac{\frac{1}{4} - \beta^2}{4 \cos^2 \frac{1}{2}x}$	$(n + \frac{1}{2}(\alpha + \beta + 1))^2$
$(\sin x)^{\alpha+\frac{1}{2}} P_n^{(\alpha,\alpha)}(\cos x)$	1	0	$(\frac{1}{4} - \alpha^2)/\sin^2 x$	$(n + \alpha + \frac{1}{2})^2$
$C_n^{(\lambda)}(x)$	$1 - x^2$	$-(2\lambda + 1)x$	0	$n(n + 2\lambda)$
$T_n(x)$	$1 - x^2$	$-x$	0	$n^2$
$U_n(x)$	$1 - x^2$	$-3x$	0	$n(n + 2)$
$P_n(x)$	$1 - x^2$	$-2x$	0	$n(n + 1)$
$L_n^{(\alpha)}(x)$	$x$	$\alpha + 1 - x$	0	$n$
$e^{-\frac{1}{2}x^2} x^{\alpha+\frac{1}{2}} L_n^{(\alpha)}(x^2)$	1	0	$-x^2 + (\frac{1}{4} - \alpha^2)x^{-2}$	$4n + 2\alpha + 2$
$H_n(x)$	1	$-2x$	0	$2n$
$e^{-\frac{1}{2}x^2} H_n(x)$	1	0	$-x^2$	$2n + 1$
$He_n(x)$	1	$-x$	0	$n$

### 18.9 Recurrence Relations and Derivatives

#### 18.9(i) Recurrence Relations

**18.9.1**  $p_{n+1}(x) = (A_n x + B_n)p_n(x) - C_n p_{n-1}(x)$ .

For  $p_n(x) = P_n^{(\alpha, \beta)}(x)$ ,

$$A_n = \frac{(2n + \alpha + \beta + 1)(2n + \alpha + \beta + 2)}{2(n + 1)(n + \alpha + \beta + 1)},$$

$$B_n = \frac{(\alpha^2 - \beta^2)(2n + \alpha + \beta + 1)}{2(n + 1)(n + \alpha + \beta + 1)(2n + \alpha + \beta)},$$

$$C_n = \frac{(n + \alpha)(n + \beta)(2n + \alpha + \beta + 2)}{(n + 1)(n + \alpha + \beta + 1)(2n + \alpha + \beta)}.$$

For the other classical OP's see Table 18.9.1; compare also §18.2(iv).

Table 18.9.1: Classical OP's: recurrence relations (18.9.1).

$p_n(x)$	$A_n$	$B_n$	$C_n$
$C_n^{(\lambda)}(x)$	$\frac{2n+\lambda}{n+1}$	0	$\frac{n+2\lambda-1}{n+1}$
$T_n(x)$	$2 - \delta_{n,0}$	0	1
$U_n(x)$	2	0	1
$T_n^*(x)$	$4 - 2\delta_{n,0}$	$-2 + \delta_{n,0}$	1
$U_n^*(x)$	4	-2	1
$P_n(x)$	$\frac{2n+1}{n+1}$	0	$\frac{n}{n+1}$
$P_n^*(x)$	$\frac{4n+2}{n+1}$	$-\frac{2n+1}{n+1}$	$\frac{n}{n+1}$
$L_n^{(\alpha)}(x)$	$-\frac{1}{n+1}$	$\frac{2n+\alpha+1}{n+1}$	$\frac{n+\alpha}{n+1}$
$H_n(x)$	2	0	$2n$
$He_n(x)$	1	0	$n$

#### 18.9(ii) Contiguous Relations in the Parameters and the Degree

##### Jacobi

**18.9.3**  $P_n^{(\alpha, \beta-1)}(x) - P_n^{(\alpha-1, \beta)}(x) = P_{n-1}^{(\alpha, \beta)}(x)$ ,

**18.9.4**  $(1-x)P_n^{(\alpha+1, \beta)}(x) + (1+x)P_n^{(\alpha, \beta+1)}(x) = 2P_n^{(\alpha, \beta)}(x)$ .

**18.9.5**  $(2n + \alpha + \beta + 1)P_n^{(\alpha, \beta)}(x) = (n + \alpha + \beta + 1)P_n^{(\alpha, \beta+1)}(x) + (n + \alpha)P_{n-1}^{(\alpha, \beta+1)}(x)$ ,

**18.9.6**  $(n + \frac{1}{2}\alpha + \frac{1}{2}\beta + 1)(1+x)P_n^{(\alpha, \beta+1)}(x) = (n+1)P_{n+1}^{(\alpha, \beta)}(x) + (n+\beta+1)P_n^{(\alpha, \beta)}(x)$ ,

and a similar pair to (18.9.5) and (18.9.6) by symmetry; compare the second row in Table 18.6.1.

##### Ultraspherical

**18.9.7**  $(n + \lambda)C_n^{(\lambda)}(x) = \lambda(C_n^{(\lambda+1)}(x) - C_{n-2}^{(\lambda+1)}(x))$ ,  
 $4\lambda(n + \lambda + 1)(1 - x^2)C_n^{(\lambda+1)}(x)$

**18.9.8**  $= -(n + 1)(n + 2)C_{n+2}^{(\lambda)}(x) + (n + 2\lambda)(n + 2\lambda + 1)C_n^{(\lambda)}(x)$ .

##### Chebyshev

**18.9.9**  $T_n(x) = \frac{1}{2}(U_n(x) - U_{n-2}(x))$ ,

**18.9.10**  $(1 - x^2)U_n(x) = -\frac{1}{2}(T_{n+2}(x) - T_n(x))$ .

**18.9.11**  $W_n(x) + W_{n-1}(x) = 2T_n(x)$ ,

**18.9.12**  $T_{n+1}(x) + T_n(x) = (1 + x)W_n(x)$ .

##### Laguerre

**18.9.13**  $L_n^{(\alpha)}(x) = L_n^{(\alpha+1)}(x) - L_{n-1}^{(\alpha+1)}(x)$ ,

**18.9.14**  $xL_n^{(\alpha+1)}(x) = -(n + 1)L_{n+1}^{(\alpha)}(x) + (n + \alpha + 1)L_n^{(\alpha)}(x)$ .

#### 18.9(iii) Derivatives

##### Jacobi

**18.9.15**  $\frac{d}{dx}P_n^{(\alpha, \beta)}(x) = \frac{1}{2}(n + \alpha + \beta + 1)P_{n-1}^{(\alpha+1, \beta+1)}(x)$ ,

**18.9.16**  $\frac{d}{dx}((1-x)^\alpha(1+x)^\beta P_n^{(\alpha, \beta)}(x)) = -2(n + 1)(1-x)^{\alpha-1}(1+x)^{\beta-1}P_{n+1}^{(\alpha-1, \beta-1)}(x)$ .

$(2n + \alpha + \beta)(1 - x^2)\frac{d}{dx}P_n^{(\alpha, \beta)}(x)$   
**18.9.17**  $= n(\alpha - \beta - (2n + \alpha + \beta)x)P_n^{(\alpha, \beta)}(x) + 2(n + \alpha)(n + \beta)P_{n-1}^{(\alpha, \beta)}(x)$ ,

**18.9.18**  $(2n + \alpha + \beta + 2)(1 - x^2)\frac{d}{dx}P_n^{(\alpha, \beta)}(x) = (n + \alpha + \beta + 1)(\alpha - \beta + (2n + \alpha + \beta + 2)x)P_n^{(\alpha, \beta)}(x) - 2(n + 1)(n + \alpha + \beta + 1)P_{n+1}^{(\alpha, \beta)}(x)$ .

##### Ultraspherical

**18.9.19**  $\frac{d}{dx}C_n^{(\lambda)}(x) = 2\lambda C_{n-1}^{(\lambda+1)}(x)$ ,

**18.9.20**  $\frac{d}{dx}((1-x^2)^{\lambda-\frac{1}{2}}C_n^{(\lambda)}(x)) = -\frac{(n+1)(n+2\lambda-1)}{2(\lambda-1)}(1-x^2)^{\lambda-\frac{3}{2}}C_{n+1}^{(\lambda-1)}(x)$ .

**Chebyshev**

$$18.9.21 \quad \frac{d}{dx} T_n(x) = n U_{n-1}(x),$$

$$18.9.22 \quad \frac{d}{dx} \left( (1-x^2)^{\frac{1}{2}} U_n(x) \right) = -(n+1)(1-x^2)^{-\frac{1}{2}} T_{n+1}(x).$$

**Laguerre**

$$18.9.23 \quad \frac{d}{dx} L_n^{(\alpha)}(x) = -L_{n-1}^{(\alpha+1)}(x),$$

$$18.9.24 \quad \frac{d}{dx} \left( e^{-x} x^\alpha L_n^{(\alpha)}(x) \right) = (n+1) e^{-x} x^{\alpha-1} L_{n+1}^{(\alpha-1)}(x).$$

**Hermite**

$$18.9.25 \quad \frac{d}{dx} H_n(x) = 2n H_{n-1}(x),$$

$$18.9.26 \quad \frac{d}{dx} \left( e^{-x^2} H_n(x) \right) = -e^{-x^2} H_{n+1}(x).$$

$$18.9.27 \quad \frac{d}{dx} He_n(x) = n He_{n-1}(x),$$

$$18.9.28 \quad \frac{d}{dx} \left( e^{-\frac{1}{2}x^2} He_n(x) \right) = -e^{-\frac{1}{2}x^2} He_{n+1}(x).$$

**18.10 Integral Representations****18.10(i) Dirichlet-Mehler-Type Integral Representations****Ultraspherical**

$$18.10.1 \quad \frac{P_n^{(\alpha,\alpha)}(\cos \theta)}{P_n^{(\alpha,\alpha)}(1)} = \frac{C_n^{(\alpha+\frac{1}{2})}(\cos \theta)}{C_n^{(\alpha+\frac{1}{2})}(1)} = \frac{2^{\alpha+\frac{1}{2}} \Gamma(\alpha+1)}{\pi^{\frac{1}{2}} \Gamma(\alpha+\frac{1}{2})} (\sin \theta)^{-2\alpha} \int_0^\theta \frac{\cos((n+\alpha+\frac{1}{2})\phi)}{(\cos \phi - \cos \theta)^{-\alpha+\frac{1}{2}}} d\phi, \quad 0 < \theta < \pi, \alpha > -\frac{1}{2}.$$

**Legendre**

$$18.10.2 \quad P_n(\cos \theta) = \frac{2^{\frac{1}{2}}}{\pi} \int_0^\theta \frac{\cos((n+\frac{1}{2})\phi)}{(\cos \phi - \cos \theta)^{\frac{1}{2}}} d\phi, \quad 0 < \theta < \pi.$$

Generalizations of (18.10.1) are given in Gasper (1975, (6),(8)) and Koornwinder (1975b, (5.7),(5.8)).

**18.10(ii) Laplace-Type Integral Representations****Jacobi**

$$18.10.3 \quad \frac{P_n^{(\alpha,\beta)}(\cos \theta)}{P_n^{(\alpha,\beta)}(1)} = \frac{2 \Gamma(\alpha+1)}{\pi^{\frac{1}{2}} \Gamma(\alpha-\beta) \Gamma(\beta+\frac{1}{2})} \times \int_0^1 \int_0^\pi \left( (\cos \frac{1}{2}\theta)^2 - r^2 (\sin \frac{1}{2}\theta)^2 + ir \sin \theta \cos \phi \right)^n (1-r^2)^{\alpha-\beta-1} r^{2\beta+1} (\sin \phi)^{2\beta} d\phi dr, \quad \alpha > \beta > -\frac{1}{2}.$$

**Ultraspherical**

$$18.10.4 \quad \frac{P_n^{(\alpha,\alpha)}(\cos \theta)}{P_n^{(\alpha,\alpha)}(1)} = \frac{C_n^{(\alpha+\frac{1}{2})}(\cos \theta)}{C_n^{(\alpha+\frac{1}{2})}(1)} = \frac{\Gamma(\alpha+1)}{\pi^{\frac{1}{2}} \Gamma(\alpha+\frac{1}{2})} \int_0^\pi (\cos \theta + i \sin \theta \cos \phi)^n (\sin \phi)^{2\alpha} d\phi, \quad \alpha > -\frac{1}{2}.$$

**Legendre**

$$18.10.5 \quad P_n(\cos \theta) = \frac{1}{\pi} \int_0^\pi (\cos \theta + i \sin \theta \cos \phi)^n d\phi.$$

**Laguerre**

$$18.10.6 \quad L_n^{(\alpha)}(x^2) = \frac{2(-1)^n}{\pi^{\frac{1}{2}} \Gamma(\alpha+\frac{1}{2}) n!} \int_0^\infty \int_0^\pi (x^2 - r^2 + 2ixr \cos \phi)^n e^{-r^2} r^{2\alpha+1} (\sin \phi)^{2\alpha} d\phi dr, \quad \alpha > -\frac{1}{2}.$$

**Hermite**

$$18.10.7 \quad H_n(x) = \frac{2^n}{\pi^{\frac{1}{2}}} \int_{-\infty}^\infty (x+it)^n e^{-t^2} dt.$$



**18.10(iii) Contour Integral Representations**

Table 18.10.1 gives contour integral representations of the form

**18.10.8** 
$$p_n(x) = \frac{g_0(x)}{2\pi i} \int_C (g_1(z, x))^n g_2(z, x)(z - c)^{-1} dz$$

for the Jacobi, Laguerre, and Hermite polynomials. Here  $C$  is a simple closed contour encircling  $z = c$  once in the positive sense.

Table 18.10.1: Classical OP's: contour integral representations (18.10.8).

$p_n(x)$	$g_0(x)$	$g_1(z, x)$	$g_2(z, x)$	$c$	Conditions
$P_n^{(\alpha, \beta)}(x)$	$(1 - x)^{-\alpha}(1 + x)^{-\beta}$	$\frac{z^2 - 1}{2(z - x)}$	$(1 - z)^\alpha(1 + z)^\beta$	$x$	$\pm 1$ outside $C$ .
$C_n^{(\lambda)}(x)$	1	$z^{-1}$	$(1 - 2xz + z^2)^{-\lambda}$	0	$e^{\pm i\theta}$ outside $C$ (where $x = \cos \theta$ ).
$T_n(x)$	1	$z^{-1}$	$\frac{1 - xz}{1 - 2xz + z^2}$	0	
$U_n(x)$	1	$z^{-1}$	$(1 - 2xz + z^2)^{-1}$	0	
$P_n(x)$	1	$z^{-1}$	$(1 - 2xz + z^2)^{-\frac{1}{2}}$	0	
$P_n(x)$	1	$\frac{z^2 - 1}{2(z - x)}$	1	$x$	
$L_n^{(\alpha)}(x)$	$e^x x^{-\alpha}$	$z(z - x)^{-1}$	$z^\alpha e^{-z}$	$x$	0 outside $C$ .
$H_n(x)/n!$	1	$z^{-1}$	$e^{2xz - z^2}$	0	
$He_n(x)/n!$	1	$z^{-1}$	$e^{xz - \frac{1}{2}z^2}$	0	

**18.10(iv) Other Integral Representations**

**Laguerre**

**18.10.9** 
$$L_n^{(\alpha)}(x) = \frac{e^x x^{-\frac{1}{2}\alpha}}{n!} \int_0^\infty e^{-t} t^{n+\frac{1}{2}\alpha} J_\alpha(2\sqrt{xt}) dt,$$
  
 $\alpha > -1.$

For the Bessel function  $J_\nu(z)$  see §10.2(ii).

**Hermite**

**18.10.10**

$$H_n(x) = \frac{(-2i)^n e^{x^2}}{\pi^{\frac{1}{2}}} \int_{-\infty}^\infty e^{-t^2} t^n e^{2ixt} dt$$

$$= \frac{2^{n+1}}{\pi^{\frac{1}{2}}} e^{x^2} \int_0^\infty e^{-t^2} t^n \cos(2xt - \frac{1}{2}n\pi) dt.$$

See also §18.17.

**18.11 Relations to Other Functions**

**18.11(i) Explicit Formulas**

See §§18.5(i) and 18.5(iii) for relations to trigonometric functions, the hypergeometric function, and generalized hypergeometric functions.

**Ultraspherical**

**18.11.1**

$$P_n^m(x) = \left(\frac{1}{2}\right)_m (-2)^m (1 - x^2)^{\frac{1}{2}m} C_{n-m}^{(m+\frac{1}{2})}(x)$$

$$= (n+1)_m (-2)^{-m} (1 - x^2)^{\frac{1}{2}m} P_{n-m}^{(m,m)}(x),$$

$$0 \leq m \leq n.$$

For the Ferrers function  $P_n^m(x)$ , see §14.3(i).

Compare also (14.3.21) and (14.3.22).

**Laguerre**

**18.11.2**

$$L_n^{(\alpha)}(x) = \frac{(\alpha+1)_n}{n!} M(-n, \alpha+1, x)$$

$$= \frac{(-1)^n}{n!} U(-n, \alpha+1, x)$$

$$= \frac{(\alpha+1)_n}{n!} z^{-\frac{1}{2}(\alpha+1)} e^{\frac{1}{2}z} M_{n+\frac{1}{2}(\alpha+1), \frac{1}{2}\alpha}(z)$$

$$= \frac{(-1)^n}{n!} z^{-\frac{1}{2}(\alpha+1)} e^{\frac{1}{2}z} W_{n+\frac{1}{2}(\alpha+1), \frac{1}{2}\alpha}(z).$$

For the confluent hypergeometric functions  $M(a, b, z)$  and  $U(a, b, z)$ , see §13.2(i), and for the Whittaker functions  $M_{\kappa, \mu}(z)$  and  $W_{\kappa, \mu}(z)$  see §13.14(i).

**Hermite**

$$\begin{aligned}
 18.11.3 \quad H_n(x) &= 2^n U\left(-\frac{1}{2}n, \frac{1}{2}, x^2\right) \\
 &= 2^n x U\left(-\frac{1}{2}n + \frac{1}{2}, \frac{3}{2}, x^2\right) \\
 &= 2^{\frac{1}{2}n} e^{\frac{1}{2}x^2} U\left(-n - \frac{1}{2}, 2^{\frac{1}{2}}x\right).
 \end{aligned}$$

$$\begin{aligned}
 18.11.4 \quad He_n(x) &= 2^{\frac{1}{2}n} U\left(-\frac{1}{2}n, \frac{1}{2}, \frac{1}{2}x^2\right) \\
 &= 2^{\frac{1}{2}(n-1)} x U\left(-\frac{1}{2}n + \frac{1}{2}, \frac{3}{2}, \frac{1}{2}x^2\right) \\
 &= e^{\frac{1}{4}x^2} U\left(-n - \frac{1}{2}, x\right).
 \end{aligned}$$

For the parabolic cylinder function  $U(a, z)$ , see §12.2.

**18.11(ii) Formulas of Mehler–Heine Type**

**Jacobi**

$$\begin{aligned}
 18.11.5 \quad \lim_{n \rightarrow \infty} \frac{1}{n^\alpha} P_n^{(\alpha, \beta)}\left(1 - \frac{z^2}{2n^2}\right) &= \lim_{n \rightarrow \infty} \frac{1}{n^\alpha} P_n^{(\alpha, \beta)}\left(\cos \frac{z}{n}\right) \\
 &= \frac{2^\alpha}{z^\alpha} J_\alpha(z).
 \end{aligned}$$

**Laguerre**

$$18.11.6 \quad \lim_{n \rightarrow \infty} \frac{1}{n^\alpha} L_n^{(\alpha)}\left(\frac{z}{n}\right) = \frac{1}{z^{\frac{1}{2}\alpha}} J_\alpha\left(2z^{\frac{1}{2}}\right).$$

**Hermite**

$$18.11.7 \quad \lim_{n \rightarrow \infty} \frac{(-1)^n n^{\frac{1}{2}}}{2^{2n} n!} H_{2n}\left(\frac{z}{2n^{\frac{1}{2}}}\right) = \frac{1}{\pi^{\frac{1}{2}}} \cos z,$$

$$18.11.8 \quad \lim_{n \rightarrow \infty} \frac{(-1)^n}{2^{2n} n!} H_{2n+1}\left(\frac{z}{2n^{\frac{1}{2}}}\right) = \frac{2}{\pi^{\frac{1}{2}}} \sin z.$$

For the Bessel function  $J_\nu(z)$ , see §10.2(ii). The limits (18.11.5)–(18.11.8) hold uniformly for  $z$  in any bounded subset of  $\mathbb{C}$ .

**18.12 Generating Functions**

With the notation of §§10.2(ii), 10.25(ii), and 15.2,

**Jacobi**

$$\begin{aligned}
 18.12.1 \quad &\frac{2^{\alpha+\beta}}{R(1+R-z)^\alpha(1+R+z)^\beta} \\
 &= \sum_{n=0}^{\infty} P_n^{(\alpha, \beta)}(x) z^n, \quad R = \sqrt{1-2xz+z^2}, \quad |z| < 1.
 \end{aligned}$$

$$\begin{aligned}
 18.12.2 \quad &\left(\frac{1}{2}(1-x)z\right)^{-\frac{1}{2}\alpha} J_\alpha\left(\sqrt{2(1-x)z}\right) \\
 &\times \left(\frac{1}{2}(1+x)z\right)^{-\frac{1}{2}\beta} I_\beta\left(\sqrt{2(1+x)z}\right) \\
 &= \sum_{n=0}^{\infty} \frac{P_n^{(\alpha, \beta)}(x)}{\Gamma(n+\alpha+1)\Gamma(n+\beta+1)} z^n.
 \end{aligned}$$

**18.12.3**

$$\begin{aligned}
 &(1+z)^{-\alpha-\beta-1} \\
 &\times {}_2F_1\left(\frac{1}{2}(\alpha+\beta+1), \frac{1}{2}(\alpha+\beta+2); \frac{2(x+1)z}{(1+z)^2}\right) \\
 &= \sum_{n=0}^{\infty} \frac{(\alpha+\beta+1)_n}{(\beta+1)_n} P_n^{(\alpha, \beta)}(x) z^n, \quad |z| < 1,
 \end{aligned}$$

and a similar formula by symmetry; compare the second row in Table 18.6.1. For the hypergeometric function  ${}_2F_1$  see §§15.1, 15.2(i).

**Ultraspherical**

**18.12.4**

$$\begin{aligned}
 (1-2xz+z^2)^{-\lambda} &= \sum_{n=0}^{\infty} C_n^{(\lambda)}(x) z^n \\
 &= \sum_{n=0}^{\infty} \frac{(2\lambda)_n}{(\lambda+\frac{1}{2})_n} P_n^{(\lambda-\frac{1}{2}, \lambda-\frac{1}{2})}(x) z^n, \quad |z| < 1.
 \end{aligned}$$

**18.12.5**

$$\frac{1-xz}{(1-2xz+z^2)^{\lambda+1}} = \sum_{n=0}^{\infty} \frac{n+2\lambda}{2\lambda} C_n^{(\lambda)}(x) z^n, \quad |z| < 1.$$

$$\Gamma\left(\lambda+\frac{1}{2}\right) e^{z \cos \theta} \left(\frac{1}{2}z \sin \theta\right)^{\frac{1}{2}-\lambda} J_{\lambda-\frac{1}{2}}(z \sin \theta)$$

$$\begin{aligned}
 18.12.6 \quad &= \sum_{n=0}^{\infty} \frac{C_n^{(\lambda)}(\cos \theta)}{(2\lambda)_n} z^n, \quad 0 \leq \theta \leq \pi.
 \end{aligned}$$

**Chebyshev**

$$18.12.7 \quad \frac{1-z^2}{1-2xz+z^2} = 1 + 2 \sum_{n=1}^{\infty} T_n(x) z^n, \quad |z| < 1.$$

$$18.12.8 \quad \frac{1-xz}{1-2xz+z^2} = \sum_{n=0}^{\infty} T_n(x) z^n, \quad |z| < 1.$$

$$18.12.9 \quad -\ln(1-2xz+z^2) = 2 \sum_{n=1}^{\infty} \frac{T_n(x)}{n} z^n, \quad |z| < 1.$$

$$18.12.10 \quad \frac{1}{1-2xz+z^2} = \sum_{n=0}^{\infty} U_n(x) z^n, \quad |z| < 1.$$

**Legendre**

$$18.12.11 \quad \frac{1}{\sqrt{1-2xz+z^2}} = \sum_{n=0}^{\infty} P_n(x) z^n, \quad |z| < 1.$$

$$18.12.12 \quad e^{xz} J_0\left(z\sqrt{1-x^2}\right) = \sum_{n=0}^{\infty} \frac{P_n(x)}{n!} z^n.$$

**Laguerre**

**18.12.13**

$$(1-z)^{-\alpha-1} \exp\left(\frac{xz}{z-1}\right) = \sum_{n=0}^{\infty} L_n^{(\alpha)}(x) z^n, \quad |z| < 1.$$

**18.12.14**

$$\Gamma(\alpha+1)(xz)^{-\frac{1}{2}\alpha} e^z J_\alpha(2\sqrt{xz}) = \sum_{n=0}^{\infty} \frac{L_n^{(\alpha)}(x)}{(\alpha+1)_n} z^n.$$

**Hermite**

18.12.15 
$$e^{2xz-z^2} = \sum_{n=0}^{\infty} \frac{H_n(x)}{n!} z^n,$$

18.12.16 
$$e^{xz-\frac{1}{2}z^2} = \sum_{n=0}^{\infty} \frac{He_n(x)}{n!} z^n.$$

**18.13 Continued Fractions**

We use the terminology of §1.12(ii).

**Chebyshev**

$T_n(x)$  is the denominator of the  $n$ th approximant to:

18.13.1 
$$\frac{-1}{x+} \frac{-1}{2x+} \frac{-1}{2x+} \dots,$$

and  $U_n(x)$  is the denominator of the  $n$ th approximant to:

18.13.2 
$$\frac{-1}{2x+} \frac{-1}{2x+} \frac{-1}{2x+} \dots.$$

**Legendre**

$P_n(x)$  is the denominator of the  $n$ th approximant to:

18.13.3 
$$\frac{a_1}{x+} \frac{-\frac{1}{2}}{\frac{3}{2}x+} \frac{-\frac{2}{3}}{\frac{5}{3}x+} \frac{-\frac{3}{4}}{\frac{7}{4}x+} \dots,$$

where  $a_1$  is an arbitrary nonzero constant.

**Laguerre**

$L_n(x)$  is the denominator of the  $n$ th approximant to:

18.13.4 
$$\frac{a_1}{1-x+} \frac{-\frac{1}{2}}{\frac{1}{2}(3-x)+} \frac{-\frac{2}{3}}{\frac{1}{3}(5-x)+} \frac{-\frac{3}{4}}{\frac{1}{4}(7-x)+} \dots,$$

where  $a_1$  is again an arbitrary nonzero constant.

**Hermite**

$H_n(x)$  is the denominator of the  $n$ th approximant to:

18.13.5 
$$\frac{1}{2x+} \frac{-2}{2x+} \frac{-4}{2x+} \frac{-6}{2x+} \dots.$$

See also Cuyt *et al.* (2008, pp. 91–99).

**18.14 Inequalities**

**18.14(i) Upper Bounds**

**Jacobi**

18.14.1 
$$|P_n^{(\alpha,\beta)}(x)| \leq P_n^{(\alpha,\beta)}(1) = \frac{(\alpha+1)_n}{n!},$$

$$-1 \leq x \leq 1, \alpha \geq \beta > -1, \alpha \geq -\frac{1}{2},$$

18.14.2 
$$|P_n^{(\alpha,\beta)}(x)| \leq |P_n^{(\alpha,\beta)}(-1)| = \frac{(\beta+1)_n}{n!},$$

$$-1 \leq x \leq 1, \beta \geq \alpha > -1, \beta \geq -\frac{1}{2}.$$

18.14.3 
$$\left(\frac{1}{2}(1-x)\right)^{\frac{1}{2}\alpha+\frac{1}{4}} \left(\frac{1}{2}(1+x)\right)^{\frac{1}{2}\beta+\frac{1}{4}} |P_n^{(\alpha,\beta)}(x)|$$

$$\leq \frac{\Gamma(\max(\alpha,\beta) + n + 1)}{\pi^{\frac{1}{2}} n! \left(n + \frac{1}{2}(\alpha + \beta + 1)\right)^{\max(\alpha,\beta) + \frac{1}{2}}},$$

$$-1 \leq x \leq 1, -\frac{1}{2} \leq \alpha \leq \frac{1}{2}, -\frac{1}{2} \leq \beta \leq \frac{1}{2}.$$

**Ultraspherical**

**18.14.4**

$$|C_n^{(\lambda)}(x)| \leq C_n^{(\lambda)}(1) = \frac{(2\lambda)_n}{n!}, \quad -1 \leq x \leq 1, \lambda > 0.$$

**18.14.5**

$$|C_{2m}^{(\lambda)}(x)| \leq |C_{2m}^{(\lambda)}(0)| = \left| \frac{(\lambda)_m}{m!} \right|,$$

$$-1 \leq x \leq 1, -\frac{1}{2} < \lambda < 0,$$

**18.14.6**

$$|C_{2m+1}^{(\lambda)}(x)| < \frac{-2(\lambda)_{m+1}}{((2m+1)(2\lambda+2m+1))^{\frac{1}{2}} m!},$$

$$-1 \leq x \leq 1, -\frac{1}{2} < \lambda < 0.$$

**18.14.7**

$$(n+\lambda)^{1-\lambda} (1-x^2)^{\frac{1}{2}\lambda} |C_n^{(\lambda)}(x)| < \frac{2^{1-\lambda}}{\Gamma(\lambda)},$$

$$-1 \leq x \leq 1, 0 < \lambda < 1.$$

**Laguerre**

**18.14.8**

$$e^{-\frac{1}{2}x} |L_n^{(\alpha)}(x)| \leq L_n^{(\alpha)}(0) = \frac{(\alpha+1)_n}{n!},$$

$$0 \leq x < \infty, \alpha \geq 0.$$

**Hermite**

**18.14.9**

$$\frac{1}{(2^n n!)^{\frac{1}{2}}} e^{-\frac{1}{2}x^2} |H_n(x)| \leq 1, \quad -\infty < x < \infty.$$

For further inequalities see Abramowitz and Stegun (1964, §22.14).

**18.14(ii) Turan-Type Inequalities**

**Legendre**

18.14.10 
$$(P_n(x))^2 \geq P_{n-1}(x) P_{n+1}(x), \quad -1 \leq x \leq 1.$$

**Jacobi**

Let  $R_n(x) = P_n^{(\alpha,\beta)}(x) / P_n^{(\alpha,\beta)}(1)$ . Then

**18.14.11**

$$(R_n(x))^2 \geq R_{n-1}(x) R_{n+1}(x), \quad -1 \leq x \leq 1, \beta \geq \alpha > -1.$$

**Laguerre**

**18.14.12**

$$(L_n^{(\alpha)}(x))^2 \geq L_{n-1}^{(\alpha)}(x) L_{n+1}^{(\alpha)}(x), \quad 0 \leq x < \infty, \alpha \geq 0.$$

**Hermite**

18.14.13 
$$(H_n(x))^2 \geq H_{n-1}(x) H_{n+1}(x), \quad -\infty < x < \infty.$$

**18.14(iii) Local Maxima and Minima**

**Jacobi**

Let the maxima  $x_{n,m}$ ,  $m = 0, 1, \dots, n$ , of  $|P_n^{(\alpha,\beta)}(x)|$  in  $[-1, 1]$  be arranged so that

18.14.14 
$$-1 = x_{n,0} < x_{n,1} < \dots < x_{n,n-1} < x_{n,n} = 1.$$

When  $(\alpha + \frac{1}{2})(\beta + \frac{1}{2}) > 0$  choose  $m$  so that

18.14.15 
$$x_{n,m} \leq (\beta - \alpha) / (\alpha + \beta + 1) \leq x_{n,m+1}.$$

Then

$$18.14.16 \quad |P_n^{(\alpha,\beta)}(x_{n,0})| > |P_n^{(\alpha,\beta)}(x_{n,1})| > \cdots > |P_n^{(\alpha,\beta)}(x_{n,m})|, \\ |P_n^{(\alpha,\beta)}(x_{n,n})| > |P_n^{(\alpha,\beta)}(x_{n,n-1})| > \cdots > |P_n^{(\alpha,\beta)}(x_{n,m+1})|, \quad \alpha > -\frac{1}{2}, \beta > -\frac{1}{2}.$$

$$18.14.17 \quad |P_n^{(\alpha,\beta)}(x_{n,0})| < |P_n^{(\alpha,\beta)}(x_{n,1})| < \cdots < |P_n^{(\alpha,\beta)}(x_{n,m})|, \\ |P_n^{(\alpha,\beta)}(x_{n,n})| < |P_n^{(\alpha,\beta)}(x_{n,n-1})| < \cdots < |P_n^{(\alpha,\beta)}(x_{n,m+1})|, \quad -1 < \alpha < -\frac{1}{2}, -1 < \beta < -\frac{1}{2}.$$

Also,

$$18.14.18 \quad |P_n^{(\alpha,\beta)}(x_{n,0})| < |P_n^{(\alpha,\beta)}(x_{n,1})| < \cdots < |P_n^{(\alpha,\beta)}(x_{n,n})|, \\ \alpha \geq -\frac{1}{2}, -1 < \beta \leq -\frac{1}{2},$$

$$18.14.19 \quad |P_n^{(\alpha,\beta)}(x_{n,0})| > |P_n^{(\alpha,\beta)}(x_{n,1})| > \cdots > |P_n^{(\alpha,\beta)}(x_{n,n})|, \\ \beta \geq -\frac{1}{2}, -1 < \alpha \leq -\frac{1}{2},$$

except that when  $\alpha = \beta = -\frac{1}{2}$  (Chebyshev case)  $|P_n^{(\alpha,\beta)}(x_{n,m})|$  is constant.

**Szegő–Szász Inequality**

$$18.14.20 \quad \left| \frac{P_n^{(\alpha,\beta)}(x_{n,n-m})}{P_n^{(\alpha,\beta)}(1)} \right| > \left| \frac{P_{n+1}^{(\alpha,\beta)}(x_{n+1,n-m+1})}{P_{n+1}^{(\alpha,\beta)}(1)} \right|, \\ \alpha = \beta > -\frac{1}{2}, m = 1, 2, \dots, n.$$

For extensions of (18.14.20) see Askey (1990) and Wong and Zhang (1994a,b).

**Laguerre**

Let the maxima  $x_{n,m}$ ,  $m = 0, 1, \dots, n - 1$ , of  $|L_n^{(\alpha)}(x)|$  in  $[0, \infty)$  be arranged so that

$$18.14.21 \quad 0 = x_{n,0} < x_{n,1} < \cdots < x_{n,n-1} < x_{n,n} = \infty.$$

When  $\alpha > -\frac{1}{2}$  choose  $m$  so that

$$18.14.22 \quad x_{n,m} \leq \alpha + \frac{1}{2} \leq x_{n,m+1}.$$

Then

$$18.14.23 \quad |L_n^{(\alpha)}(x_{n,0})| > |L_n^{(\alpha)}(x_{n,1})| > \cdots > |L_n^{(\alpha)}(x_{n,m})|, \\ |L_n^{(\alpha)}(x_{n,n-1})| > |L_n^{(\alpha)}(x_{n,n-2})| > \cdots > |L_n^{(\alpha)}(x_{n,m+1})|.$$

Also, when  $\alpha \leq -\frac{1}{2}$

$$18.14.24 \quad |L_n^{(\alpha)}(x_{n,0})| < |L_n^{(\alpha)}(x_{n,1})| < \cdots < |L_n^{(\alpha)}(x_{n,n-1})|.$$

**Hermite**

The successive maxima of  $|H_n(x)|$  form a decreasing sequence for  $x \leq 0$ , and an increasing sequence for  $x \geq 0$ .

**18.15 Asymptotic Approximations**

**18.15(i) Jacobi**

With the exception of the penultimate paragraph, we assume throughout this subsection that  $\alpha$ ,  $\beta$ , and  $M$

( $= 0, 1, 2, \dots$ ) are all fixed.

**18.15.1**

$$\left( \sin \frac{1}{2}\theta \right)^{\alpha+\frac{1}{2}} \left( \cos \frac{1}{2}\theta \right)^{\beta+\frac{1}{2}} P_n^{(\alpha,\beta)}(\cos \theta) \\ = \pi^{-1} 2^{2n+\alpha+\beta+1} B(n+\alpha+1, n+\beta+1) \\ \times \left( \sum_{m=0}^{M-1} \frac{f_m(\theta)}{2^m (2n+\alpha+\beta+2)_m} + O(n^{-M}) \right),$$

as  $n \rightarrow \infty$ , uniformly with respect to  $\theta \in [\delta, \pi - \delta]$ . Here, and elsewhere in §18.15,  $\delta$  is an arbitrary small positive constant. Also,  $B(a, b)$  is the beta function (§5.12) and

$$18.15.2 \quad f_m(\theta) = \sum_{\ell=0}^m \frac{C_{m,\ell}(\alpha,\beta)}{\ell!(m-\ell)!} \frac{\cos \theta_{n,m,\ell}}{\left( \sin \frac{1}{2}\theta \right)^\ell \left( \cos \frac{1}{2}\theta \right)^{m-\ell}},$$

where

**18.15.3**

$$C_{m,\ell}(\alpha,\beta) = \left( \frac{1}{2} + \alpha \right)_\ell \left( \frac{1}{2} - \alpha \right)_\ell \left( \frac{1}{2} + \beta \right)_{m-\ell} \left( \frac{1}{2} - \beta \right)_{m-\ell},$$

and

$$18.15.4 \quad \theta_{n,m,\ell} = \frac{1}{2}(2n + \alpha + \beta + m + 1)\theta - \frac{1}{2}(\alpha + \ell + \frac{1}{2})\pi.$$

When  $\alpha, \beta \in (-\frac{1}{2}, \frac{1}{2})$ , the error term in (18.15.1) is less than twice the first neglected term in absolute value. See Hahn (1980), where corresponding results are given when  $x$  is replaced by a complex variable  $z$  that is bounded away from the orthogonality interval  $[-1, 1]$ .

Next, let

$$18.15.5 \quad \rho = n + \frac{1}{2}(\alpha + \beta + 1).$$

Then as  $n \rightarrow \infty$ ,

$$\left( \sin \frac{1}{2}\theta \right)^{\alpha+\frac{1}{2}} \left( \cos \frac{1}{2}\theta \right)^{\beta+\frac{1}{2}} P_n^{(\alpha,\beta)}(\cos \theta) \\ = \frac{\Gamma(n+\alpha+1)}{2^{\frac{1}{2}} \rho^\alpha n!} \left( \theta^{\frac{1}{2}} J_\alpha(\rho\theta) \sum_{m=0}^M \frac{A_m(\theta)}{\rho^{2m}} \right. \\ 18.15.6 \quad \left. + \theta^{\frac{3}{2}} J_{\alpha+1}(\rho\theta) \sum_{m=0}^{M-1} \frac{B_m(\theta)}{\rho^{2m+1}} + \varepsilon_M(\rho, \theta) \right),$$

where  $J_\nu(z)$  is the Bessel function (§10.2(ii)), and

**18.15.7**

$$\varepsilon_M(\rho, \theta) = \begin{cases} \theta O(\rho^{-2M-(3/2)}), & c\rho^{-1} \leq \theta \leq \pi - \delta, \\ \theta^{\alpha+(5/2)} O(\rho^{-2M+\alpha}), & 0 \leq \theta \leq c\rho^{-1}, \end{cases}$$

with  $c$  denoting an arbitrary positive constant. Also,

$$A_0(\theta) = 1, \quad \theta B_0(\theta) = \frac{1}{4}g(\theta), \\ 18.15.8 \quad A_1(\theta) = \frac{1}{8}g'(\theta) - \frac{1+2\alpha}{8} \frac{g(\theta)}{\theta} - \frac{1}{32}(g(\theta))^2,$$

where

**18.15.9**

$$g(\theta) = \left(\frac{1}{4} - \alpha^2\right) \left(\cot\left(\frac{1}{2}\theta\right) - \left(\frac{1}{2}\theta\right)^{-1}\right) - \left(\frac{1}{4} - \beta^2\right) \tan\left(\frac{1}{2}\theta\right).$$

For higher coefficients see [Baratella and Gatteschi \(1988\)](#), and for another estimate of the error term see [Wong and Zhao \(2003\)](#).

For large  $\beta$ , fixed  $\alpha$ , and  $0 \leq n/\beta \leq c$ , [Dunster \(1999\)](#) gives asymptotic expansions of  $P_n^{(\alpha,\beta)}(z)$  that are uniform in unbounded complex  $z$ -domains containing  $z = \pm 1$ . These expansions are in terms of Whittaker functions (§13.14). This reference also supplies asymptotic expansions of  $P_n^{(\alpha,\beta)}(z)$  for large  $n$ , fixed  $\alpha$ , and  $0 \leq \beta/n \leq c$ . The latter expansions are in terms of Bessel functions, and are uniform in complex  $z$ -domains not containing neighborhoods of 1. For a complementary result, see [Wong and Zhao \(2004\)](#). By using the symmetry property given in the second row of [Table 18.6.1](#), the roles of  $\alpha$  and  $\beta$  can be interchanged.

For an asymptotic expansion of  $P_n^{(\alpha,\beta)}(z)$  as  $n \rightarrow \infty$  that holds uniformly for complex  $z$  bounded away from  $[-1, 1]$ , see [Elliott \(1971\)](#). The first term of this expansion also appears in [Szegő \(1975, Theorem 8.21.7\)](#).

**18.15(ii) Ultraspherical**

For fixed  $\lambda \in (0, 1)$  and fixed  $M = 0, 1, 2, \dots$ ,

**18.15.10**

$$C_n^{(\lambda)}(\cos \theta) = \frac{2^{2\lambda} \Gamma(\lambda + \frac{1}{2})}{\pi^{\frac{1}{2}} \Gamma(\lambda + 1)} \frac{(2\lambda)_n}{(\lambda + 1)_n} \times \left( \sum_{m=0}^{M-1} \frac{(\lambda)_m (1-\lambda)_m}{m! (n+\lambda+1)_m} \frac{\cos \theta_{n,m}}{(2 \sin \theta)^{m+\lambda}} + O\left(\frac{1}{n^M}\right) \right),$$

as  $n \rightarrow \infty$  uniformly with respect to  $\theta \in [\delta, \pi - \delta]$ , where

**18.15.11**  $\theta_{n,m} = (n + m + \lambda)\theta - \frac{1}{2}(m + \lambda)\pi.$

For a bound on the error term in [\(18.15.10\)](#) see [Szegő \(1975, Theorem 8.21.11\)](#).

Asymptotic expansions for  $C_n^{(\lambda)}(\cos \theta)$  can be obtained from the results given in §18.15(i) by setting  $\alpha = \beta = \lambda - \frac{1}{2}$  and referring to [\(18.7.1\)](#). See also [Szegő \(1933\)](#) and [Szegő \(1975, Eq. \(8.21.14\)\)](#).

**18.15(iii) Legendre**

For fixed  $M = 0, 1, 2, \dots$ ,

**18.15.12**

$$P_n(\cos \theta) = \left(\frac{2}{\sin \theta}\right)^{\frac{1}{2}} \sum_{m=0}^{M-1} \binom{-\frac{1}{2}}{m} \binom{m - \frac{1}{2}}{n} \frac{\cos \alpha_{n,m}}{(2 \sin \theta)^m} + O\left(\frac{1}{n^{M+\frac{1}{2}}}\right),$$

as  $n \rightarrow \infty$ , uniformly with respect to  $\theta \in [\delta, \pi - \delta]$ , where

**18.15.13**  $\alpha_{n,m} = (n - m + \frac{1}{2})\theta + (n - \frac{1}{2}m - \frac{1}{4})\pi.$

Also, when  $\frac{1}{6}\pi < \theta < \frac{5}{6}\pi$ , the right-hand side of [\(18.15.12\)](#) with  $M = \infty$  converges; paradoxically, however, the sum is  $2P_n(\cos \theta)$  and not  $P_n(\cos \theta)$  as stated erroneously in [Szegő \(1975, §8.4\(3\)\)](#).

For these results and further information see [Olver \(1997b, pp. 311–313\)](#). For another form of the asymptotic expansion, complete with error bound, see [Szegő \(1975, Theorem 8.21.5\)](#).

For asymptotic expansions of  $P_n(\cos \theta)$  and  $P_n(\cosh \xi)$  that are uniformly valid when  $0 \leq \theta \leq \pi - \delta$  and  $0 \leq \xi < \infty$  see §14.15(iii) with  $\mu = 0$  and  $\nu = n$ . These expansions are in terms of Bessel functions and modified Bessel functions, respectively.

**18.15(iv) Laguerre**

**In Terms of Elementary Functions**

For fixed  $M = 0, 1, 2, \dots$ , and fixed  $\alpha$ ,

**18.15.14**  $L_n^{(\alpha)}(x) = \frac{n^{\frac{1}{2}\alpha - \frac{1}{4}} e^{\frac{1}{2}x}}{\pi^{\frac{1}{2}} x^{\frac{1}{2}\alpha + \frac{1}{4}}} \left( \cos \theta_n^{(\alpha)}(x) \left( \sum_{m=0}^{M-1} \frac{a_m(x)}{n^{\frac{1}{2}m}} + O\left(\frac{1}{n^{\frac{1}{2}M}}\right) \right) + \sin \theta_n^{(\alpha)}(x) \left( \sum_{m=1}^{M-1} \frac{b_m(x)}{n^{\frac{1}{2}m}} + O\left(\frac{1}{n^{\frac{1}{2}M}}\right) \right) \right),$

as  $n \rightarrow \infty$ , uniformly on compact  $x$ -intervals in  $(0, \infty)$ , where

**18.15.15**

$$\theta_n^{(\alpha)}(x) = 2(nx)^{\frac{1}{2}} - \left(\frac{1}{2}\alpha + \frac{1}{4}\right)\pi.$$

The leading coefficients are given by

**18.15.16**

$$a_0(x) = 1, \quad a_1(x) = 0, \quad b_1(x) = \frac{1}{48x^{\frac{1}{2}}} (4x^2 - 12\alpha^2 - 24\alpha x - 24x + 3).$$

**In Terms of Bessel Functions**

Define

**18.15.17**

$$\nu = 4n + 2\alpha + 2,$$

**18.15.18** 
$$\xi = \frac{1}{2} \left( \sqrt{x - x^2} + \arcsin(\sqrt{x}) \right), \quad 0 \leq x \leq 1.$$

Then for fixed  $M = 0, 1, 2, \dots$ , and fixed  $\alpha$ ,

**18.15.19**

$$L_n^{(\alpha)}(\nu x) = \frac{e^{\frac{1}{2}\nu x}}{2^\alpha x^{\frac{1}{2}\alpha + \frac{1}{4}}(1-x)^{\frac{1}{4}}} \left( \xi^{\frac{1}{2}} J_\alpha(\nu\xi) \sum_{m=0}^{M-1} \frac{A_m(\xi)}{\nu^{2m}} + \xi^{-\frac{1}{2}} J_{\alpha+1}(\nu\xi) \sum_{m=0}^{M-1} \frac{B_m(\xi)}{\nu^{2m+1}} + \xi^{\frac{1}{2}} \operatorname{env} J_\alpha(\nu\xi) O\left(\frac{1}{\nu^{2M-1}}\right) \right),$$

as  $n \rightarrow \infty$  uniformly for  $0 \leq x \leq 1 - \delta$ . Here  $J_\nu(z)$  denotes the Bessel function (§10.2(ii)),  $\operatorname{env} J_\nu(z)$  denotes its envelope (§2.8(iv)), and  $\delta$  is again an arbitrary small positive constant. The leading coefficients are given by  $A_0(\xi) = 1$  and

**18.15.20** 
$$B_0(\xi) = -\frac{1}{2} \left( \frac{1 - 4\alpha^2}{8} + \xi \left( \frac{1-x}{x} \right)^{\frac{1}{2}} \left( \frac{4\alpha^2 - 1}{8} + \frac{1}{4} \frac{x}{1-x} + \frac{5}{24} \left( \frac{x}{1-x} \right)^2 \right) \right).$$

**In Terms of Airy Functions**

Again define  $\nu$  as in (18.15.17); also,

**18.15.21** 
$$\zeta = -\left(\frac{3}{4} \left( \arccos(\sqrt{x}) - \sqrt{x - x^2} \right)\right)^{\frac{2}{3}}, \quad 0 \leq x \leq 1,$$
  

$$\zeta = \left(\frac{3}{4} \left( \sqrt{x^2 - x} - \operatorname{arccosh}(\sqrt{x}) \right)\right)^{\frac{2}{3}}, \quad x \geq 1.$$

Then for fixed  $M = 0, 1, 2, \dots$ , and fixed  $\alpha$ ,

**18.15.22** 
$$L_n^{(\alpha)}(\nu x) \sim (-1)^n \frac{e^{\frac{1}{2}\nu x}}{2^{\alpha - \frac{1}{2}} x^{\frac{1}{2}\alpha + \frac{1}{4}}} \times \left( \frac{\zeta}{x-1} \right)^{\frac{1}{4}} \left( \frac{\operatorname{Ai}(\nu^{\frac{2}{3}}\zeta)}{\nu^{\frac{1}{3}}} \sum_{m=0}^{M-1} \frac{E_m(\zeta)}{\nu^{2m}} + \frac{\operatorname{Ai}'(\nu^{\frac{2}{3}}\zeta)}{\nu^{\frac{5}{3}}} \sum_{m=0}^{M-1} \frac{F_m(\zeta)}{\nu^{2m}} + \operatorname{env} \operatorname{Ai}(\nu^{\frac{2}{3}}\zeta) O\left(\frac{1}{\nu^{2M - \frac{2}{3}}}\right) \right),$$

as  $n \rightarrow \infty$  uniformly for  $\delta \leq x < \infty$ . Here  $\operatorname{Ai}$  denotes the Airy function (§9.2),  $\operatorname{Ai}'$  denotes its derivative, and  $\operatorname{env} \operatorname{Ai}$  denotes its envelope (§2.8(iii)). The leading coefficients are given by  $E_0(\zeta) = 1$  and

**18.15.23** 
$$F_0(\zeta) = -\frac{5}{48\zeta^2} + \left( \frac{x-1}{x\zeta} \right)^{\frac{1}{2}} \left( \frac{1}{2}\alpha^2 - \frac{1}{8} - \frac{1}{4} \frac{x}{x-1} + \frac{5}{24} \left( \frac{x}{x-1} \right)^2 \right), \quad 0 \leq x < \infty.$$

**18.15(v) Hermite**

Define

**18.15.24** 
$$\mu = 2n + 1,$$

**18.15.25** 
$$\lambda_n = \begin{cases} \Gamma(n+1)/\Gamma(\frac{1}{2}n+1), & n \text{ even,} \\ \Gamma(n+2)/\left(\mu^{\frac{1}{2}} \Gamma(\frac{1}{2}n + \frac{3}{2})\right), & n \text{ odd,} \end{cases}$$

and

**18.15.26** 
$$\omega_{n,m}(x) = \mu^{\frac{1}{2}}x - \frac{1}{2}(m+n)\pi.$$

Then for fixed  $M = 0, 1, 2, \dots$ ,

**18.15.27** 
$$H_n(x) = \lambda_n e^{\frac{1}{2}x^2} \left( \sum_{m=0}^{M-1} \frac{u_m(x) \cos \omega_{n,m}(x)}{\mu^{\frac{1}{2}m}} + O\left(\frac{1}{\mu^{\frac{1}{2}M}}\right) \right),$$

as  $n \rightarrow \infty$ , uniformly on compact  $x$ -intervals on  $\mathbb{R}$ . The coefficients  $u_m(x)$  are polynomials in  $x$ , and  $u_0(x) = 1$ ,

$$u_1(x) = \frac{1}{6}x^3.$$

For more powerful asymptotic expansions as  $n \rightarrow \infty$  in terms of elementary functions that apply uniformly when  $1 + \delta \leq t < \infty$ ,  $-1 + \delta \leq t \leq 1 - \delta$ , or  $-\infty < t \leq -1 - \delta$ , where  $t = x/\sqrt{2n+1}$  and  $\delta$  is again an arbitrary small positive constant, see §§12.10(i)–12.10(iv) and 12.10(vi). And for asymptotic expansions as  $n \rightarrow \infty$  in terms of Airy functions that apply uniformly when  $-1 + \delta \leq t < \infty$  or  $-\infty < t \leq 1 - \delta$ , see §§12.10(vii) and 12.10(viii). With  $\mu = \sqrt{2n+1}$  the expansions in Chapter 12 are for the parabolic cylinder function  $U(-\frac{1}{2}\mu^2, \mu t\sqrt{2})$ , which is related to the Hermite polynomials via

**18.15.28** 
$$H_n(x) = 2^{\frac{1}{4}(\mu^2-1)} e^{\frac{1}{2}\mu^2 t^2} U\left(-\frac{1}{2}\mu^2, \mu t\sqrt{2}\right);$$

compare (18.11.3).

For an error bound for the first term in the Airy-function expansions see Olver (1997b, p. 403).

**18.15(vi) Other Approximations**

The asymptotic behavior of the classical OP's as  $x \rightarrow \pm\infty$  with the degree and parameters fixed is evident from their explicit polynomial forms; see, for example, (18.2.7) and the last two columns of Table 18.3.1.

For asymptotic approximations of Jacobi, ultraspherical, and Laguerre polynomials in terms of Hermite polynomials, see López and Temme (1999a). These approximations apply when the parameters are large, namely  $\alpha$  and  $\beta$  (subject to restrictions) in the case of Jacobi polynomials,  $\lambda$  in the case of ultraspherical polynomials, and  $|\alpha| + |x|$  in the case of Laguerre polynomials. See also Dunster (1999).

**18.16 Zeros**

**18.16(i) Distribution**

See §18.2(vi).

**18.16(ii) Jacobi**

Let  $\theta_{n,m}$ ,  $m = 1, 2, \dots, n$ , denote the zeros of  $P_n^{(\alpha,\beta)}(\cos \theta)$  with

**18.16.1**  $0 < \theta_{n,1} < \theta_{n,2} < \dots < \theta_{n,n} < \pi.$

Then  $\theta_{n,m}$  is strictly increasing in  $\alpha$  and strictly decreasing in  $\beta$ ; furthermore, if  $\alpha = \beta$ , then  $\theta_{n,m}$  is strictly increasing in  $\alpha$ .

**Inequalities**

**18.16.2**  $\frac{(m - \frac{1}{2})\pi}{n + \frac{1}{2}} \leq \theta_{n,m} \leq \frac{m\pi}{n + \frac{1}{2}}, \quad \alpha, \beta \in [-\frac{1}{2}, \frac{1}{2}],$

**18.16.3**  $\frac{(m - \frac{1}{2})\pi}{n} \leq \theta_{n,m} \leq \frac{m\pi}{n + 1},$   
 $\alpha = \beta, \alpha \in [-\frac{1}{2}, \frac{1}{2}], m = 1, 2, \dots, [\frac{1}{2}n].$

Also, with  $\rho$  defined as in (18.15.5)

**18.16.4**  $\frac{(m + \frac{1}{2}(\alpha + \beta - 1))\pi}{\rho} < \theta_{n,m} < \frac{m\pi}{\rho}, \quad \alpha, \beta \in [-\frac{1}{2}, \frac{1}{2}],$

except when  $\alpha^2 = \beta^2 = \frac{1}{4}$ .

**18.16.5**  $\theta_{n,m} > \frac{(m + \frac{1}{2}\alpha - \frac{1}{4})\pi}{n + \alpha + \frac{1}{2}},$   
 $\alpha = \beta, \alpha \in (-\frac{1}{2}, \frac{1}{2}), m = 1, 2, \dots, [\frac{1}{2}n].$

Let  $j_{\alpha,m}$  be the  $m$ th positive zero of the Bessel function  $J_\alpha(x)$  (§10.21(i)). Then

**18.16.6**  $\theta_{n,m} \leq \frac{j_{\alpha,m}}{(\rho^2 + \frac{1}{12}(1 - \alpha^2 - 3\beta^2))^{\frac{1}{2}}}, \quad \alpha, \beta \in [-\frac{1}{2}, \frac{1}{2}],$

**18.16.7**  $\theta_{n,m} \geq \frac{j_{\alpha,m}}{(\rho^2 + \frac{1}{4} - \frac{1}{2}(\alpha^2 + \beta^2) - \pi^{-2}(1 - 4\alpha^2))^{\frac{1}{2}}},$   
 $\alpha, \beta \in [-\frac{1}{2}, \frac{1}{2}], m = 1, 2, \dots, [\frac{1}{2}n].$

**Asymptotic Behavior**

Let  $\phi_m = j_{\alpha,m}/\rho$ . Then as  $n \rightarrow \infty$ , with  $\alpha (> -\frac{1}{2})$  and  $\beta (\geq -1 - \alpha)$  fixed,

**18.16.8**

$$\theta_{n,m} = \phi_m + \left( (\alpha^2 - \frac{1}{4}) \frac{1 - \phi_m \cot \phi_m}{2\phi_m} - \frac{1}{4}(\alpha^2 - \beta^2) \tan(\frac{1}{2}\phi_m) \right) \frac{1}{\rho^2} + \phi_m^2 O\left(\frac{1}{\rho^3}\right),$$

uniformly for  $m = 1, 2, \dots, [cn]$ , where  $c$  is an arbitrary constant such that  $0 < c < 1$ .

**18.16(iii) Ultraspherical and Legendre**

For ultraspherical and Legendre polynomials, set  $\alpha = \beta$  and  $\alpha = \beta = 0$ , respectively, in the results given in §18.16(ii).

**18.16(iv) Laguerre**

The zeros of  $L_n^{(\alpha)}(x)$  are denoted by  $x_{n,m}$ ,  $m = 1, 2, \dots, n$ , with

**18.16.9**  $0 < x_{n,1} < x_{n,2} < \dots < x_{n,n}.$

Also,  $\nu$  is again defined by (18.15.17).

**Inequalities**

For  $n = 1, 2, \dots, m$ , and with  $j_{\alpha,m}$  as in §18.16(ii),

**18.16.10**  $x_{n,m} > j_{\alpha,m}^2/\nu,$

**18.16.11**  $x_{n,m} < (4m + 2\alpha + 2) \left( 2m + \alpha + 1 + ((2m + \alpha + 1)^2 + \frac{1}{4} - \alpha^2)^{\frac{1}{2}} \right) / \nu.$

The constant  $j_{\alpha,m}^2$  in (18.16.10) is the best possible since the ratio of the two sides of this inequality tends to 1 as  $n \rightarrow \infty$ .

For the smallest and largest zeros we have

**18.16.12**  $x_{n,1} > 2n + \alpha - 2 - (1 + 4(n - 1)(n + \alpha - 1))^{\frac{1}{2}},$

**18.16.13**  $x_{n,n} < 2n + \alpha - 2 + (1 + 4(n - 1)(n + \alpha - 1))^{\frac{1}{2}}.$

**Asymptotic Behavior**

As  $n \rightarrow \infty$ , with  $\alpha$  and  $m$  fixed,

**18.16.14**

$$x_{n,n-m+1} = \nu + 2^{\frac{2}{3}} a_m \nu^{\frac{1}{3}} + \frac{1}{5} 2^{\frac{4}{3}} a_m^2 \nu^{-\frac{1}{3}} + O(n^{-1}),$$

where  $a_m$  is the  $m$ th negative zero of  $\text{Ai}(x)$  (§9.9(i)). For three additional terms in this expansion see Gatteschi (2002). Also,

**18.16.15**  $x_{n,m} < \nu + 2^{\frac{2}{3}} a_m \nu^{\frac{1}{3}} + 2^{-\frac{2}{3}} a_m^2 \nu^{-\frac{1}{3}},$

when  $\alpha \notin (-\frac{1}{2}, \frac{1}{2})$ .

**18.16(v) Hermite**

All zeros of  $H_n(x)$  lie in the open interval  $(-\sqrt{2n+1}, \sqrt{2n+1})$ . In view of the reflection formula, given in Table 18.6.1, we may consider just the positive zeros  $x_{n,m}$ ,  $m = 1, 2, \dots, \lfloor \frac{1}{2}n \rfloor$ . Arrange them in decreasing order:

**18.16.16**  $(2n+1)^{\frac{1}{2}} > x_{n,1} > x_{n,2} > \dots > x_{n, \lfloor n/2 \rfloor} > 0$ .  
Then

**18.16.17**  $x_{n,m} = (2n+1)^{\frac{1}{2}} + 2^{-\frac{1}{3}}(2n+1)^{-\frac{1}{6}} a_m + \epsilon_{n,m}$ , where  $a_m$  is the  $m$ th negative zero of  $\text{Ai}(x)$  (§9.9(i)),  $\epsilon_{n,m} < 0$ , and as  $n \rightarrow \infty$  with  $m$  fixed

**18.16.18**  $\epsilon_{n,m} = O(n^{-\frac{5}{6}})$ .

For an asymptotic expansion of  $x_{n,m}$  as  $n \rightarrow \infty$  that applies uniformly for  $m = 1, 2, \dots, \lfloor \frac{1}{2}n \rfloor$ , see Olver (1959, §14(i)). In the notation of this reference  $x_{n,m} = u_{a,m}$ ,  $\mu = \sqrt{2n+1}$ , and  $\alpha = \mu^{-\frac{4}{3}} a_m$ . For an error bound for the first approximation yielded by this expansion see Olver (1997b, p. 408).

Lastly, in view of (18.7.19) and (18.7.20), results for the zeros of  $L_n^{(\pm\frac{1}{2})}(x)$  lead immediately to results for the zeros of  $H_n(x)$ .

**18.16(vi) Additional References**

For further information on the zeros of the classical orthogonal polynomials, see Szegő (1975, Chapter VI),

Erdélyi *et al.* (1953b, §§10.16 and 10.17), Gatteschi (1987, 2002), López and Temme (1999a), and Temme (1990a).

**18.17 Integrals****18.17(i) Indefinite Integrals****Jacobi****18.17.1**

$$2n \int_0^x (1-y)^\alpha (1+y)^\beta P_n^{(\alpha,\beta)}(y) dy = P_{n-1}^{(\alpha+1,\beta+1)}(0) - (1-x)^{\alpha+1} (1+x)^{\beta+1} P_{n-1}^{(\alpha+1,\beta+1)}(x).$$

**Laguerre****18.17.2**

$$\int_0^x L_m(y) L_n(x-y) dy = \int_0^x L_{m+n}(y) dy = L_{m+n}(x) - L_{m+n+1}(x).$$

**Hermite**

$$18.17.3 \quad \int_0^x H_n(y) dy = \frac{1}{2(n+1)} (H_{n+1}(x) - H_{n+1}(0)),$$

$$18.17.4 \quad \int_0^x e^{-y^2} H_n(y) dy = H_{n-1}(0) - e^{-x^2} H_{n-1}(x).$$

**18.17(ii) Integral Representations for Products****Ultraspherical**

$$18.17.5 \quad \frac{C_n^{(\lambda)}(\cos \theta_1) C_n^{(\lambda)}(\cos \theta_2)}{C_n^{(\lambda)}(1) C_n^{(\lambda)}(1)} = \frac{\Gamma(\lambda + \frac{1}{2})}{\pi^{\frac{1}{2}} \Gamma(\lambda)} \int_0^\pi \frac{C_n^{(\lambda)}(\cos \theta_1 \cos \theta_2 + \sin \theta_1 \sin \theta_2 \cos \phi)}{C_n^{(\lambda)}(1)} (\sin \phi)^{2\lambda-1} d\phi, \quad \lambda > 0.$$

**Legendre**

$$18.17.6 \quad P_n(\cos \theta_1) P_n(\cos \theta_2) = \frac{1}{\pi} \int_0^\pi P_n(\cos \theta_1 \cos \theta_2 + \sin \theta_1 \sin \theta_2 \cos \phi) d\phi.$$

For formulas for Jacobi and Laguerre polynomials analogous to (18.17.5) and (18.17.6), see Koornwinder (1974, 1977).

**18.17(iii) Nicholson-Type Integrals****Legendre**

$$18.17.7 \quad (P_n(x))^2 + 4\pi^{-2} (Q_n(x))^2 = 4\pi^{-2} \int_1^\infty Q_n(x^2 + (1-x^2)t) (t^2 - 1)^{-\frac{1}{2}} dt, \quad -1 < x < 1.$$

For the Ferrers function  $Q_n(x)$  and Legendre function  $Q_n(x)$  see §§14.3(i) and 14.3(ii), with  $\mu = 0$  and  $\nu = n$ .

**Hermite**

$$18.17.8 \quad (H_n(x))^2 + 2^n (n!)^2 e^{x^2} \left( V\left(-n - \frac{1}{2}, 2^{\frac{1}{2}} x\right) \right)^2 = \frac{2^{n+\frac{3}{2}} n! e^{x^2}}{\pi} \int_0^\infty \frac{e^{-(2n+1)t+x^2 \tanh t}}{(\sinh 2t)^{\frac{1}{2}}} dt.$$

For the parabolic cylinder function  $V(a, z)$  see §12.2. For similar formulas for ultraspherical polynomials see Durand (1975), and for Jacobi and Laguerre polynomials see Durand (1978).



**18.17(iv) Fractional Integrals****Jacobi**

$$18.17.9 \quad \frac{(1-x)^{\alpha+\mu} P_n^{(\alpha+\mu, \beta-\mu)}(x)}{\Gamma(\alpha+\mu+n+1)} = \int_x^1 \frac{(1-y)^\alpha P_n^{(\alpha, \beta)}(y)}{\Gamma(\alpha+n+1)} \frac{(y-x)^{\mu-1}}{\Gamma(\mu)} dy, \quad \mu > 0, -1 < x < 1,$$

$$18.17.10 \quad \frac{x^{\beta+\mu}(x+1)^n}{\Gamma(\beta+\mu+n+1)} P_n^{(\alpha, \beta+\mu)}\left(\frac{x-1}{x+1}\right) = \int_0^x \frac{y^\beta(y+1)^n}{\Gamma(\beta+n+1)} P_n^{(\alpha, \beta)}\left(\frac{y-1}{y+1}\right) \frac{(x-y)^{\mu-1}}{\Gamma(\mu)} dy, \quad \mu > 0, x > 0,$$

$$18.17.11 \quad \frac{\Gamma(n+\alpha+\beta-\mu+1)}{x^{n+\alpha+\beta-\mu+1}} P_n^{(\alpha, \beta-\mu)}(1-2x^{-1}) = \int_x^\infty \frac{\Gamma(n+\alpha+\beta+1)}{y^{n+\alpha+\beta+1}} P_n^{(\alpha, \beta)}(1-2y^{-1}) \frac{(y-x)^{\mu-1}}{\Gamma(\mu)} dy, \\ \alpha + \beta + 1 > \mu > 0, x > 1,$$

and three formulas similar to (18.17.9)–(18.17.11) by symmetry; compare the second row in Table 18.6.1.

**Ultraspherical**

$$18.17.12 \quad \frac{\Gamma(\lambda-\mu) C_n^{(\lambda-\mu)}(x^{-\frac{1}{2}})}{x^{\lambda-\mu+\frac{1}{2}n}} = \int_x^\infty \frac{\Gamma(\lambda) C_n^{(\lambda)}(y^{-\frac{1}{2}})}{y^{\lambda+\frac{1}{2}n}} \frac{(y-x)^{\mu-1}}{\Gamma(\mu)} dy, \quad \lambda > \mu > 0, x > 0,$$

$$18.17.13 \quad \frac{x^{\frac{1}{2}n}(x-1)^{\lambda+\mu-\frac{1}{2}} C_n^{(\lambda+\mu)}(x^{-\frac{1}{2}})}{\Gamma(\lambda+\mu+\frac{1}{2}) C_n^{(\lambda+\mu)}(1)} = \int_1^x \frac{y^{\frac{1}{2}n}(y-1)^{\lambda-\frac{1}{2}} C_n^{(\lambda)}(y^{-\frac{1}{2}})}{\Gamma(\lambda+\frac{1}{2}) C_n^{(\lambda)}(1)} \frac{(x-y)^{\mu-1}}{\Gamma(\mu)} dy, \quad \mu > 0, x > 1.$$

**Laguerre**

$$18.17.14 \quad \frac{x^{\alpha+\mu} L_n^{(\alpha+\mu)}(x)}{\Gamma(\alpha+\mu+n+1)} = \int_0^x \frac{y^\alpha L_n^{(\alpha)}(y)}{\Gamma(\alpha+n+1)} \frac{(x-y)^{\mu-1}}{\Gamma(\mu)} dy, \quad \mu > 0, x > 0.$$

$$18.17.15 \quad e^{-x} L_n^{(\alpha)}(x) = \int_x^\infty e^{-y} L_n^{(\alpha+\mu)}(y) \frac{(y-x)^{\mu-1}}{\Gamma(\mu)} dy, \quad \mu > 0.$$

**18.17(v) Fourier Transforms**

Throughout this subsection we assume  $y > 0$ ; sometimes however, this restriction can be eased by analytic continuation.

**Jacobi**

$$18.17.16 \quad \int_{-1}^1 (1-x)^\alpha (1+x)^\beta P_n^{(\alpha, \beta)}(x) e^{ixy} dx \\ = \frac{(iy)^n e^{iy}}{n!} 2^{n+\alpha+\beta+1} B(n+\alpha+1, n+\beta+1) {}_1F_1(n+\alpha+1; 2n+\alpha+\beta+2; -2iy).$$

For the beta function  $B(a, b)$  see §5.12, and for the confluent hypergeometric function  ${}_1F_1$  see (16.2.1) and Chapter 13.

**Ultraspherical**

$$18.17.17 \quad \int_0^1 (1-x^2)^{\lambda-\frac{1}{2}} C_{2n}^{(\lambda)}(x) \cos(xy) dx = \frac{(-1)^n \pi \Gamma(2n+2\lambda) J_{\lambda+2n}(y)}{(2n)! \Gamma(\lambda) (2y)^\lambda},$$

$$18.17.18 \quad \int_0^1 (1-x^2)^{\lambda-\frac{1}{2}} C_{2n+1}^{(\lambda)}(x) \sin(xy) dx = \frac{(-1)^n \pi \Gamma(2n+2\lambda+1) J_{2n+\lambda+1}(y)}{(2n+1)! \Gamma(\lambda) (2y)^\lambda}.$$

For the Bessel function  $J_\nu$  see §10.2(ii).

**Legendre**

$$18.17.19 \quad \int_{-1}^1 P_n(x) e^{ixy} dx = i^n \sqrt{\frac{2\pi}{y}} J_{n+\frac{1}{2}}(y),$$

$$18.17.20 \quad \int_0^1 P_n(1-2x^2) \cos(xy) dx = (-1)^n \frac{1}{2} \pi J_{n+\frac{1}{2}}\left(\frac{1}{2}y\right) J_{-n-\frac{1}{2}}\left(\frac{1}{2}y\right),$$

$$18.17.21 \quad \int_0^1 P_n(1-2x^2) \sin(xy) dx = \frac{1}{2} \pi \left( J_{n+\frac{1}{2}}\left(\frac{1}{2}y\right) \right)^2.$$

**Hermite**

$$18.17.22 \quad \frac{1}{2\sqrt{\pi}} \int_{-\infty}^{\infty} e^{-\frac{1}{4}x^2} He_n(x) e^{\frac{1}{2}ixy} dx = i^n e^{-\frac{1}{4}y^2} He_n(y),$$

$$18.17.23 \quad \int_0^{\infty} e^{-\frac{1}{2}x^2} He_{2n}(x) \cos(xy) dx = (-1)^n \sqrt{\frac{1}{2}\pi} y^{2n} e^{-\frac{1}{2}y^2},$$

$$18.17.24 \quad \int_0^{\infty} e^{-x^2} He_{2n}(2x) \cos(xy) dx = (-1)^n \frac{1}{2} \sqrt{\pi} e^{-\frac{1}{4}y^2} He_{2n}(y).$$

$$18.17.25 \quad \int_0^{\infty} e^{-\frac{1}{2}x^2} He_n(x) He_{n+2m}(x) \cos(xy) dx = (-1)^m \sqrt{\frac{1}{2}\pi} n! y^{2m} e^{-\frac{1}{2}y^2} L_n^{(2m)}(y^2),$$

$$18.17.26 \quad \int_0^{\infty} e^{-\frac{1}{2}x^2} He_n(x) He_{n+2m+1}(x) \sin(xy) dx = (-1)^m \sqrt{\frac{1}{2}\pi} n! y^{2m+1} e^{-\frac{1}{2}y^2} L_n^{(2m+1)}(y^2).$$

$$18.17.27 \quad \int_0^{\infty} e^{-\frac{1}{2}x^2} He_{2n+1}(x) \sin(xy) dx = (-1)^n \sqrt{\frac{1}{2}\pi} y^{2n+1} e^{-\frac{1}{2}y^2},$$

$$18.17.28 \quad \int_0^{\infty} e^{-x^2} He_{2n+1}(2x) \sin(xy) dx = (-1)^n \frac{1}{2} \sqrt{\pi} e^{-\frac{1}{4}y^2} He_{2n+1}(y).$$

**Laguerre**

$$18.17.29 \quad \int_0^{\infty} x^{2m} e^{-\frac{1}{2}x^2} L_n^{(2m)}(x^2) \cos(xy) dx = (-1)^m \sqrt{\frac{1}{2}\pi} \frac{1}{n!} e^{-\frac{1}{2}y^2} He_n(y) He_{n+2m}(y).$$

$$18.17.30 \quad \int_0^{\infty} x^{2n} e^{-\frac{1}{2}x^2} L_n^{(n-\frac{1}{2})}(\frac{1}{2}x^2) \cos(xy) dx = \sqrt{\frac{1}{2}\pi} y^{2n} e^{-\frac{1}{2}y^2} L_n^{(n-\frac{1}{2})}(\frac{1}{2}y^2).$$

$$18.17.31 \quad \int_0^{\infty} e^{-ax} x^{\nu-2n} L_{2n-1}^{(\nu-2n)}(ax) \cos(xy) dx = i \frac{(-1)^n \Gamma(\nu)}{2(2n-1)!} y^{2n-1} ((a+iy)^{-\nu} - (a-iy)^{-\nu}), \quad \nu > 2n-1, a > 0,$$

$$18.17.32 \quad \int_0^{\infty} e^{-ax} x^{\nu-1-2n} L_{2n}^{(\nu-1-2n)}(ax) \cos(xy) dx = \frac{(-1)^n \Gamma(\nu)}{2(2n)!} y^{2n} ((a+iy)^{-\nu} + (a-iy)^{-\nu}), \quad \nu > 2n, a > 0.$$

**18.17(vi) Laplace Transforms****Jacobi**

$$18.17.33 \quad \int_{-1}^1 e^{-(x+1)z} P_n^{(\alpha,\beta)}(x) (1-x)^\alpha (1+x)^\beta dx \\ = \frac{(-1)^n 2^{\alpha+\beta+n+1} \Gamma(\alpha+n+1) \Gamma(\beta+n+1)}{\Gamma(\alpha+\beta+2n+2) n!} z^n {}_1F_1\left(\begin{matrix} \beta+n+1 \\ \alpha+\beta+2n+2 \end{matrix}; -2z\right), \quad z \in \mathbb{C}.$$

For the confluent hypergeometric function  ${}_1F_1$  see (16.2.1) and Chapter 13.

**Laguerre**

$$18.17.34 \quad \int_0^{\infty} e^{-xz} L_n^{(\alpha)}(x) e^{-x} x^\alpha dx = \frac{\Gamma(\alpha+n+1) z^n}{n! (\alpha+1)^{\alpha+n+1}}, \quad \Re z > -1.$$

**Hermite**

$$18.17.35 \quad \int_{-\infty}^{\infty} e^{-xz} H_n(x) e^{-x^2} dx = \pi^{\frac{1}{2}} (-z)^n e^{\frac{1}{4}z^2}, \quad z \in \mathbb{C}.$$

**18.17(vii) Mellin Transforms****Jacobi**

$$18.17.36 \quad \int_{-1}^1 (1-x)^{z-1} (1+x)^\beta P_n^{(\alpha,\beta)}(x) dx = \frac{2^{\beta+z} \Gamma(z) \Gamma(1+\beta+n) (1+\alpha-z)_n}{n! \Gamma(1+\beta+z+n)}, \quad \Re z > 0.$$

**Ultraspherical**

$$18.17.37 \quad \int_0^1 (1-x^2)^{\lambda-\frac{1}{2}} C_n^{(\lambda)}(x) x^{z-1} dx = \frac{\pi 2^{1-2\lambda-z} \Gamma(n+2\lambda) \Gamma(z)}{n! \Gamma(\lambda) \Gamma(\frac{1}{2} + \frac{1}{2}n + \lambda + \frac{1}{2}z) \Gamma(\frac{1}{2} + \frac{1}{2}z - \frac{1}{2}n)}, \quad \Re z > 0.$$

**Legendre**

$$18.17.38 \quad \int_0^1 P_{2n}(x) x^{z-1} dx = \frac{(-1)^n (\frac{1}{2} - \frac{1}{2}z)_n}{2(\frac{1}{2}z)_{n+1}}, \quad \Re z > 0,$$

$$18.17.39 \quad \int_0^1 P_{2n+1}(x) x^{z-1} dx = \frac{(-1)^n (1 - \frac{1}{2}z)_n}{2(\frac{1}{2} + \frac{1}{2}z)_{n+1}}, \quad \Re z > -1.$$

**Laguerre**

$$18.17.40 \quad \int_0^\infty e^{-ax} L_n^{(\alpha)}(bx) x^{z-1} dx = \frac{\Gamma(z+n)}{n!} (a-b)^n a^{-n-z} {}_2F_1\left(\begin{matrix} -n, 1+\alpha-z \\ 1-n-z \end{matrix}; \frac{a}{a-b}\right), \quad \Re a > 0, \Re z > 0.$$

For the hypergeometric function  ${}_2F_1$  see §§15.1 and 15.2(i).

**Hermite**

$$18.17.41 \quad \int_0^\infty e^{-ax} He_n(x) x^{z-1} dx = \Gamma(z+n) a^{-n-2} {}_2F_2\left(\begin{matrix} -\frac{1}{2}n, -\frac{1}{2}n + \frac{1}{2} \\ -\frac{1}{2}z - \frac{1}{2}n, -\frac{1}{2}z - \frac{1}{2}n + \frac{1}{2} \end{matrix}; -\frac{1}{2}a^2\right),$$

$\Re a > 0$ . Also,  $\Re z > 0$ ,  $n$  even;  $\Re z > -1$ ,  $n$  odd.

For the generalized hypergeometric function  ${}_2F_2$  see (16.2.1).

**18.17(viii) Other Integrals****Chebyshev**

$$18.17.42 \quad \int_{-1}^1 T_n(y) \frac{(1-y^2)^{-\frac{1}{2}}}{y-x} dy = \pi U_{n-1}(x),$$

$$18.17.43 \quad \int_{-1}^1 U_{n-1}(y) \frac{(1-y^2)^{\frac{1}{2}}}{y-x} dy = -\pi T_n(x).$$

These integrals are Cauchy principal values (§1.4(v)).

**Legendre**

$$18.17.44 \quad \int_{-1}^1 \frac{P_n(x) - P_n(t)}{|x-t|} dt = 2\left(1 + \frac{1}{2} + \cdots + \frac{1}{n}\right) P_n(x), \quad -1 \leq x \leq 1.$$

The case  $x = 1$  is a limit case of an integral for Jacobi polynomials; see Askey and Razban (1972).

$$18.17.45 \quad (n + \frac{1}{2})(1+x)^{\frac{1}{2}} \int_{-1}^x (x-t)^{-\frac{1}{2}} P_n(t) dt = T_n(x) + T_{n+1}(x),$$

$$18.17.46 \quad (n + \frac{1}{2})(1-x)^{\frac{1}{2}} \int_x^1 (t-x)^{-\frac{1}{2}} P_n(t) dt = T_n(x) - T_{n+1}(x).$$

**Laguerre**

$$18.17.47 \quad \int_0^x t^\alpha \frac{L_m^{(\alpha)}(t)}{L_m^{(\alpha)}(0)} (x-t)^\beta \frac{L_n^{(\beta)}(x-t)}{L_n^{(\beta)}(0)} dt = \frac{\Gamma(\alpha+1) \Gamma(\beta+1)}{\Gamma(\alpha+\beta+2)} x^{\alpha+\beta+1} \frac{L_{m+n}^{(\alpha+\beta+1)}(x)}{L_{m+n}^{(\alpha+\beta+1)}(0)}.$$

**Hermite**

$$18.17.48 \quad \int_{-\infty}^{\infty} H_m(y) e^{-y^2} H_n(x-y) e^{-(x-y)^2} dy = \pi^{\frac{1}{2}} 2^{-\frac{1}{2}(m+n+1)} H_{m+n}\left(2^{-\frac{1}{2}}x\right) e^{-\frac{1}{2}x^2}.$$

$$18.17.49 \quad \int_{-\infty}^{\infty} H_\ell(x) H_m(x) H_n(x) e^{-x^2} dx = \frac{2^{\frac{1}{2}(\ell+m+n)} \ell! m! n! \sqrt{\pi}}{(\frac{1}{2}\ell + \frac{1}{2}m - \frac{1}{2}n)! (\frac{1}{2}m + \frac{1}{2}n - \frac{1}{2}\ell)! (\frac{1}{2}n + \frac{1}{2}\ell - \frac{1}{2}m)!},$$

provided that  $\ell + m + n$  is even and the sum of any two of  $\ell, m, n$  is not less than the third; otherwise the integral is zero.

**18.17(ix) Compendia**

For further integrals, see Apelblat (1983, pp. 189–204), Erdélyi *et al.* (1954a, pp. 38–39, 94–95, 170–176, 259–261, 324), Erdélyi *et al.* (1954b, pp. 42–44, 271–294), Gradshteyn and Ryzhik (2000, pp. 788–806), Gröbner and Hofreiter (1950, pp. 23–30), Marichev (1983, pp. 216–247), Oberhettinger (1972, pp. 64–67), Oberhettinger (1974, pp. 83–92), Oberhettinger (1990, pp. 44–47 and 152–154), Oberhettinger and Badii (1973, pp. 103–112), Prudnikov *et al.* (1986b, pp. 420–617), Prudnikov *et al.* (1992a, pp. 419–476), and Prudnikov *et al.* (1992b, pp. 280–308).

**18.18 Sums**

**18.18(i) Series Expansions of Arbitrary Functions**

**Jacobi**

Let  $f(z)$  be analytic within an ellipse  $E$  with foci  $z = \pm 1$ , and

$$18.18.1 \quad a_n = \frac{n!(2n + \alpha + \beta + 1)\Gamma(n + \alpha + \beta + 1)}{2^{\alpha+\beta+1}\Gamma(n + \alpha + 1)\Gamma(n + \beta + 1)} \times \int_{-1}^1 f(x) P_n^{(\alpha,\beta)}(x)(1-x)^\alpha(1+x)^\beta dx.$$

Then

$$18.18.2 \quad f(z) = \sum_{n=0}^{\infty} a_n P_n^{(\alpha,\beta)}(z),$$

when  $z$  lies in the interior of  $E$ . Moreover, the series (18.18.2) converges uniformly on any compact domain within  $E$ .

Alternatively, assume  $f(x)$  is real and continuous and  $f'(x)$  is piecewise continuous on  $(-1, 1)$ . Assume also the integrals  $\int_{-1}^1 (f(x))^2(1-x)^\alpha(1+x)^\beta dx$  and  $\int_{-1}^1 (f'(x))^2(1-x)^{\alpha+1}(1+x)^{\beta+1} dx$  converge. Then (18.18.2), with  $z$  replaced by  $x$ , applies when  $-1 < x < 1$ ; moreover, the convergence is uniform on any compact interval within  $(-1, 1)$ .

**Ultraspherical**

$$18.18.8 \quad C_n^{(\lambda)}(\cos \theta_1 \cos \theta_2 + \sin \theta_1 \sin \theta_2 \cos \phi) = \sum_{\ell=0}^n 2^{2\ell} (n - \ell)! \frac{2\lambda + 2\ell - 1}{2\lambda - 1} \frac{((\lambda)_\ell)^2}{(2\lambda)_{n+\ell}} (\sin \theta_1)^\ell C_{n-\ell}^{(\lambda+\ell)}(\cos \theta_1) (\sin \theta_2)^\ell C_{n-\ell}^{(\lambda+\ell)}(\cos \theta_2) C_\ell^{(\lambda-\frac{1}{2})}(\cos \phi),$$

$$\lambda > 0, \lambda \neq \frac{1}{2}.$$

For the case  $\lambda = \frac{1}{2}$  use (18.18.9); compare (18.7.9).

**Legendre**

$$18.18.9 \quad P_n(\cos \theta_1 \cos \theta_2 + \sin \theta_1 \sin \theta_2 \cos \phi) = P_n(\cos \theta_1) P_n(\cos \theta_2) + 2 \sum_{\ell=1}^n \frac{(n - \ell)! (n + \ell)!}{2^{2\ell} (n!)^2} (\sin \theta_1)^\ell P_{n-\ell}^{(\ell,\ell)}(\cos \theta_1) (\sin \theta_2)^\ell P_{n-\ell}^{(\ell,\ell)}(\cos \theta_2) \cos(\ell\phi).$$

**Chebyshev**

See §3.11(ii), or set  $\alpha = \beta = \pm \frac{1}{2}$  in the above results for Jacobi and refer to (18.7.3)–(18.7.6).

**Legendre**

This is the case  $\alpha = \beta = 0$  of Jacobi. Equation (18.18.1) becomes

$$18.18.3 \quad a_n = (n + \frac{1}{2}) \int_{-1}^1 f(x) P_n(x) dx.$$

**Laguerre**

Assume  $f(x)$  is real and continuous and  $f'(x)$  is piecewise continuous on  $(0, \infty)$ . Assume also  $\int_0^\infty (f(x))^2 e^{-x} x^\alpha dx$  converges. Then

$$18.18.4 \quad f(x) = \sum_{n=0}^{\infty} b_n L_n^{(\alpha)}(x), \quad 0 < x < \infty,$$

where

$$18.18.5 \quad b_n = \frac{n!}{\Gamma(n + \alpha + 1)} \int_0^\infty f(x) L_n^{(\alpha)}(x) e^{-x} x^\alpha dx.$$

The convergence of the series (18.18.4) is uniform on any compact interval in  $(0, \infty)$ .

**Hermite**

Assume  $f(x)$  is real and continuous and  $f'(x)$  is piecewise continuous on  $(-\infty, \infty)$ . Assume also  $\int_{-\infty}^\infty (f(x))^2 e^{-x^2} dx$  converges. Then

$$18.18.6 \quad f(x) = \sum_{n=0}^{\infty} d_n H_n(x), \quad -\infty < x < \infty,$$

where

$$18.18.7 \quad d_n = \frac{1}{\sqrt{\pi} 2^n n!} \int_{-\infty}^\infty f(x) H_n(x) e^{-x^2} dx.$$

The convergence of the series (18.18.6) is uniform on any compact interval in  $(-\infty, \infty)$ .

**18.18(ii) Addition Theorems**

For (18.18.8), (18.18.9), and the corresponding formula for Jacobi polynomials see Koornwinder (1975a). See also (14.30.9).

**Laguerre**

18.18.10 
$$L_n^{(\alpha_1+\dots+\alpha_r+r-1)}(x_1+\dots+x_r) = \sum_{m_1+\dots+m_r=n} L_{m_1}^{(\alpha_1)}(x_1)\dots L_{m_r}^{(\alpha_r)}(x_r).$$

**Hermite**

18.18.11 
$$\frac{(a_1^2+\dots+a_r^2)^{\frac{1}{2}n}}{n!} H_n\left(\frac{a_1x_1+\dots+a_rx_r}{(a_1^2+\dots+a_r^2)^{\frac{1}{2}}}\right) = \sum_{m_1+\dots+m_r=n} \frac{a_1^{m_1}\dots a_r^{m_r}}{m_1!\dots m_r!} H_{m_1}(x_1)\dots H_{m_r}(x_r).$$

**18.18(iii) Multiplication Theorems**

**Laguerre**

18.18.12 
$$\frac{L_n^{(\alpha)}(\lambda x)}{L_n^{(\alpha)}(0)} = \sum_{\ell=0}^n \binom{n}{\ell} \lambda^\ell (1-\lambda)^{n-\ell} \frac{L_\ell^{(\alpha)}(x)}{L_\ell^{(\alpha)}(0)}.$$

**Hermite**

18.18.13 
$$H_n(\lambda x) = \lambda^n \sum_{\ell=0}^{\lfloor n/2 \rfloor} \frac{(-n)_{2\ell}}{\ell!} (1-\lambda^{-2})^\ell H_{n-2\ell}(x).$$

**18.18(iv) Connection Formulas**

**Jacobi**

18.18.14 
$$P_n^{(\gamma,\beta)}(x) = \frac{(\beta+1)_n}{(\alpha+\beta+2)_n} \sum_{\ell=0}^n \frac{\alpha+\beta+2\ell+1}{\alpha+\beta+1} \frac{(\alpha+\beta+1)_\ell (n+\beta+\gamma+1)_\ell}{(\beta+1)_\ell (n+\alpha+\beta+2)_\ell} \frac{(\gamma-\alpha)_{n-\ell}}{(n-\ell)!} P_\ell^{(\alpha,\beta)}(x),$$

18.18.15 
$$\left(\frac{1+x}{2}\right)^n = \frac{(\beta+1)_n}{(\alpha+\beta+2)_n} \sum_{\ell=0}^n \frac{\alpha+\beta+2\ell+1}{\alpha+\beta+1} \frac{(\alpha+\beta+1)_\ell (n-\ell+1)_\ell}{(\beta+1)_\ell (n+\alpha+\beta+2)_\ell} P_\ell^{(\alpha,\beta)}(x),$$

and a similar pair of equations by symmetry; compare the second row in Table 18.6.1.

**Ultraspherical**

18.18.16 
$$C_n^{(\mu)}(x) = \sum_{\ell=0}^{\lfloor n/2 \rfloor} \frac{\lambda+n-2\ell}{\lambda} \frac{(\mu)_{n-\ell}}{(\lambda+1)_{n-\ell}} \frac{(\mu-\lambda)_\ell}{\ell!} C_{n-2\ell}^{(\lambda)}(x),$$

18.18.17 
$$(2x)^n = n! \sum_{\ell=0}^{\lfloor n/2 \rfloor} \frac{\lambda+n-2\ell}{\lambda} \frac{1}{(\lambda+1)_{n-\ell} \ell!} C_{n-2\ell}^{(\lambda)}(x).$$

**Laguerre**

18.18.18 
$$L_n^{(\beta)}(x) = \sum_{\ell=0}^n \frac{(\beta-\alpha)_{n-\ell}}{(n-\ell)!} L_\ell^{(\alpha)}(x),$$

18.18.19 
$$x^n = (\alpha+1)_n \sum_{\ell=0}^n \frac{(-n)_\ell}{(\alpha+1)_\ell} L_\ell^{(\alpha)}(x).$$

**Hermite**

18.18.20 
$$(2x)^n = \sum_{\ell=0}^{\lfloor n/2 \rfloor} \frac{(-n)_{2\ell}}{\ell!} H_{n-2\ell}(x).$$

**18.18(v) Linearization Formulas**

**Chebyshev**

18.18.21 
$$T_m(x)T_n(x) = \frac{1}{2}(T_{m+n}(x) + T_{m-n}(x)).$$

**Ultraspherical**

**18.18.22**

$$C_m^{(\lambda)}(x)C_n^{(\lambda)}(x) = \sum_{\ell=0}^{\min(m,n)} \frac{(m+n+\lambda-2\ell)(m+n-2\ell)!}{(m+n+\lambda-\ell)\ell!(m-\ell)!(n-\ell)!} \times \frac{(\lambda)_\ell(\lambda)_{m-\ell}(\lambda)_{n-\ell}(2\lambda)_{m+n-\ell}}{(\lambda)_{m+n-\ell}(2\lambda)_{m+n-2\ell}} C_{m+n-2\ell}^{(\lambda)}(x).$$

**Hermite****18.18.23**

$$H_m(x) H_n(x) = \sum_{\ell=0}^{\min(m,n)} \binom{m}{\ell} \binom{n}{\ell} 2^\ell \ell! H_{m+n-2\ell}(x).$$

The coefficients in the expansions (18.18.22) and (18.18.23) are positive, provided that in the former case  $\lambda > 0$ .

**18.18(vi) Bateman-Type Sums****Jacobi**

With

$$18.18.24 \quad b_{n,\ell} = \binom{n}{\ell} \frac{(n + \alpha + \beta + 1)_\ell (-\beta - n)_{n-\ell}}{2^\ell (\alpha + 1)_n},$$

**18.18.25**

$$\frac{P_n^{(\alpha,\beta)}(x) P_n^{(\alpha,\beta)}(y)}{P_n^{(\alpha,\beta)}(1) P_n^{(\alpha,\beta)}(1)} = \sum_{\ell=0}^n b_{n,\ell} (x+y)^\ell \times \frac{P_\ell^{(\alpha,\beta)}((1+xy)/(x+y))}{P_\ell^{(\alpha,\beta)}(1)},$$

$$18.18.26 \quad \frac{P_n^{(\alpha,\beta)}(x)}{P_n^{(\alpha,\beta)}(1)} = \sum_{\ell=0}^n b_{n,\ell} (x+1)^\ell.$$

**18.18(vii) Poisson Kernels****Laguerre**

$$18.18.27 \quad \sum_{n=0}^{\infty} \frac{n! L_n^{(\alpha)}(x) L_n^{(\alpha)}(y)}{(\alpha + 1)_n} z^n = \frac{\Gamma(\alpha + 1)(xyz)^{-\frac{1}{2}\alpha}}{1 - z} \times \exp\left(\frac{-(x+y)z}{1-z}\right) I_\alpha\left(\frac{2(xyz)^{\frac{1}{2}}}{1-z}\right),$$

$|z| < 1$ .

For the modified Bessel function  $I_\nu(z)$  see §10.25(ii).

**Hermite**

$$18.18.28 \quad \sum_{n=0}^{\infty} \frac{H_n(x) H_n(y)}{2^n n!} z^n = (1 - z^2)^{-\frac{1}{2}} \exp\left(\frac{2xyz - (x^2 + y^2)z^2}{1 - z^2}\right),$$

$|z| < 1$ .

These Poisson kernels are positive, provided that  $x, y$  are real,  $0 \leq z < 1$ , and in the case of (18.18.27)  $x, y \geq 0$ .

**18.18(viii) Other Sums**

In this subsection the variables  $x$  and  $y$  are not confined to the closures of the intervals of orthogonality; compare §18.2(i).

**Ultraspherical**

$$18.18.29 \quad \sum_{\ell=0}^n C_\ell^{(\lambda)}(x) C_{n-\ell}^{(\mu)}(x) = C_n^{(\lambda+\mu)}(x).$$

$$18.18.30 \quad \sum_{\ell=0}^n \frac{\ell + 2\lambda}{2\lambda} C_\ell^{(\lambda)}(x) x^{n-\ell} = C_n^{(\lambda+1)}(x).$$

**Chebyshev**

$$18.18.31 \quad \sum_{\ell=0}^n T_\ell(x) x^{n-\ell} = U_n(x).$$

$$18.18.32 \quad 2 \sum_{\ell=0}^n T_{2\ell}(x) = 1 + U_{2n}(x),$$

$$18.18.33 \quad 2 \sum_{\ell=0}^n T_{2\ell+1}(x) = U_{2n+1}(x).$$

$$18.18.34 \quad 2(1 - x^2) \sum_{\ell=0}^n U_{2\ell}(x) = 1 - T_{2n+2}(x),$$

$$18.18.35 \quad 2(1 - x^2) \sum_{\ell=0}^n U_{2\ell+1}(x) = x - T_{2n+3}(x).$$

**Legendre and Chebyshev**

$$18.18.36 \quad \sum_{\ell=0}^n P_\ell(x) P_{n-\ell}(x) = U_n(x).$$

**Laguerre**

$$18.18.37 \quad \sum_{\ell=0}^n L_\ell^{(\alpha)}(x) = L_n^{(\alpha+1)}(x),$$

$$18.18.38 \quad \sum_{\ell=0}^n L_\ell^{(\alpha)}(x) L_{n-\ell}^{(\beta)}(y) = L_n^{(\alpha+\beta+1)}(x+y).$$

**Hermite and Laguerre**

$$18.18.39 \quad \sum_{\ell=0}^n \binom{n}{\ell} H_\ell\left(2^{\frac{1}{2}}x\right) H_{n-\ell}\left(2^{\frac{1}{2}}y\right) = 2^{\frac{1}{2}n} H_n(x+y),$$

$$18.18.40 \quad \sum_{\ell=0}^n \binom{n}{\ell} H_{2\ell}(x) H_{2n-2\ell}(y) = (-1)^n 2^{2n} n! L_n(x^2 + y^2).$$

**18.18(ix) Compendia**

For further sums see Hansen (1975, pp. 292-330), Gradshteyn and Ryzhik (2000, pp. 978-993), and Prudnikov *et al.* (1986b, pp. 637-644 and 700-718).

## Askey Scheme

### 18.19 Hahn Class: Definitions

#### Hahn, Krawtchouk, Meixner, and Charlier

Tables 18.19.1 and 18.19.2 provide definitions via orthogonality and normalization (§§18.2(i), 18.2(iii)) for the Hahn polynomials  $Q_n(x; \alpha, \beta, N)$ , Krawtchouk polynomials  $K_n(x; p, N)$ , Meixner polynomials  $M_n(x; \beta, c)$ , and Charlier polynomials  $C_n(x, a)$ .

Table 18.19.1: Orthogonality properties for Hahn, Krawtchouk, Meixner, and Charlier OP's: discrete sets, weight functions, normalizations, and parameter constraints.

$p_n(x)$	$X$	$w_x$	$h_n$
$Q_n(x; \alpha, \beta, N),$ $n = 0, 1, \dots, N$	$\{0, 1, \dots, N\}$	$\frac{(\alpha + 1)_x (\beta + 1)_{N-x}}{x!(N-x)!},$ $\alpha, \beta > -1$ or $\alpha, \beta < -N$	$\frac{(-1)^n (n + \alpha + \beta + 1)_{N+1} (\beta + 1)_n n!}{(2n + \alpha + \beta + 1)(\alpha + 1)_n (-N)_n N!}$ If $\alpha, \beta < -N$ , then $(-1)^N w_x > 0$ and $(-1)^N h_n > 0$ .
$K_n(x; p, N),$ $n = 0, 1, \dots, N$	$\{0, 1, \dots, N\}$	$\binom{N}{x} p^x (1-p)^{N-x},$ $0 < p < 1$	$\left(\frac{1-p}{p}\right)^n \bigg/ \binom{N}{n}$
$M_n(x; \beta, c)$	$\{0, 1, 2, \dots\}$	$\frac{(\beta)_x c^x / x!}{\beta > 0, 0 < c < 1}$	$\frac{c^{-n} n!}{(\beta)_n (1-c)^\beta}$
$C_n(x, a)$	$\{0, 1, 2, \dots\}$	$a^x / x!, a > 0$	$a^{-n} e^a n!$

Table 18.19.2: Hahn, Krawtchouk, Meixner, and Charlier OP's: leading coefficients.

$p_n(x)$	$k_n$
$Q_n(x; \alpha, \beta, N)$	$\frac{(n + \alpha + \beta + 1)_n}{(\alpha + 1)_n (-N)_n}$
$K_n(x; p, N)$	$p^{-n} / (-N)_n$
$M_n(x; \beta, c)$	$(1 - c^{-1})^n / (\beta)_n$
$C_n(x, a)$	$(-a)^{-n}$

#### Continuous Hahn

These polynomials are orthogonal on  $(-\infty, \infty)$ , and with  $\Re a > 0, \Re b > 0$  are defined as follows.

**18.19.1**  $p_n(x) = p_n(x; a, b, \bar{a}, \bar{b}),$

**18.19.2**  $w(z; a, b, \bar{a}, \bar{b}) = \Gamma(a + iz) \Gamma(b + iz) \Gamma(\bar{a} - iz) \Gamma(\bar{b} - iz),$

**18.19.3**  $w(x) = w(x; a, b, \bar{a}, \bar{b}) = |\Gamma(a + ix) \Gamma(b + ix)|^2,$

**18.19.4**  $h_n = \frac{2\pi \Gamma(n + a + \bar{a}) \Gamma(n + b + \bar{b}) |\Gamma(n + a + \bar{b})|^2}{(2n + 2\Re(a + b) - 1) \Gamma(n + 2\Re(a + b) - 1) n!},$

**18.19.5**  $k_n = \frac{(n + 2\Re(a + b) - 1)_n}{n!}.$

#### Meixner–Pollaczek

These polynomials are orthogonal on  $(-\infty, \infty)$ , and are defined as follows.

**18.19.6**  $p_n(x) = P_n^{(\lambda)}(x; \phi),$

**18.19.7**  $w^{(\lambda)}(z; \phi) = \Gamma(\lambda + iz) \Gamma(\lambda - iz) e^{(2\phi - \pi)z},$

**18.19.8**  $w(x) = w^{(\lambda)}(x; \phi) = |\Gamma(\lambda + ix)|^2 e^{(2\phi - \pi)x},$   
 $\lambda > 0, 0 < \phi < \pi,$

**18.19.9**  $h_n = \frac{2\pi \Gamma(n + 2\lambda)}{(2 \sin \phi)^{2\lambda} n!}, \quad k_n = \frac{(2 \sin \phi)^n}{n!}.$

### 18.20 Hahn Class: Explicit Representations

#### 18.20(i) Rodrigues Formulas

For comments on the use of the forward-difference operator  $\Delta_x$ , the backward-difference operator  $\nabla_x$ , and the central-difference operator  $\delta_x$ , see §18.2(ii).

**Hahn, Krawtchouk, Meixner, and Charlier**

**18.20.1**

$$p_n(x) = \frac{1}{\kappa_n w_x} \nabla_x^n \left( w_x \prod_{\ell=0}^{n-1} F(x + \ell) \right), \quad x \in X.$$

In (18.20.1)  $X$  and  $w_x$  are as in Table 18.19.1. For the Hahn polynomials  $p_n(x) = Q_n(x; \alpha, \beta, N)$  and

**18.20.2**

$$F(x) = (x + \alpha + 1)(x - N), \quad \kappa_n = (-N)_n (\alpha + 1)_n.$$

For the Krawtchouk, Meixner, and Charlier polynomials,  $F(x)$  and  $\kappa_n$  are as in Table 18.20.1.

Table 18.20.1: Krawtchouk, Meixner, and Charlier OP's: Rodrigues formulas (18.20.1).

$p_n(x)$	$F(x)$	$\kappa_n$
$K_n(x; p, N)$	$x - N$	$(-N)_n$
$M_n(x; \beta, c)$	$x + \beta$	$(\beta)_n$
$C_n(x, a)$	1	1

**Continuous Hahn**

**18.20.3** 
$$w(x; a, b, \bar{a}, \bar{b}) p_n(x; a, b, \bar{a}, \bar{b}) = \frac{1}{n!} \delta_x^n \left( w(x; a + \frac{1}{2}n, b + \frac{1}{2}n, \bar{a} + \frac{1}{2}n, \bar{b} + \frac{1}{2}n) \right).$$

**Meixner–Pollaczek**

**18.20.4** 
$$w^{(\lambda)}(x; \phi) P_n^{(\lambda)}(x; \phi) = \frac{1}{n!} \delta_x^n \left( w^{(\lambda + \frac{1}{2}n)}(x; \phi) \right).$$

**18.20(ii) Hypergeometric Function and Generalized Hypergeometric Functions**

For the definition of hypergeometric and generalized hypergeometric functions see §16.2.

**18.20.5**

$$Q_n(x; \alpha, \beta, N) = {}_3F_2 \left( \begin{matrix} -n, n + \alpha + \beta + 1, -x \\ \alpha + 1, -N \end{matrix}; 1 \right), \quad n = 0, 1, \dots, N.$$

**18.20.6** 
$$K_n(x; p, N) = {}_2F_1 \left( \begin{matrix} -n, -x \\ -N \end{matrix}; p^{-1} \right), \quad n = 0, 1, \dots, N.$$

**18.20.7** 
$$M_n(x; \beta, c) = {}_2F_1 \left( \begin{matrix} -n, -x \\ \beta \end{matrix}; 1 - c^{-1} \right).$$

**18.20.8** 
$$C_n(x, a) = {}_2F_0 \left( \begin{matrix} -n, -x \\ - \end{matrix}; -a^{-1} \right).$$

**18.20.9** 
$$p_n(x; a, b, \bar{a}, \bar{b}) = \frac{i^n (a + \bar{a})_n (a + \bar{b})_n}{n!} \times {}_3F_2 \left( \begin{matrix} -n, n + 2\Re(a + b) - 1, a + ix \\ a + \bar{a}, a + \bar{b} \end{matrix}; 1 \right).$$

(For symmetry properties of  $p_n(x; a, b, \bar{a}, \bar{b})$  with respect to  $a, b, \bar{a}, \bar{b}$  see Andrews *et al.* (1999, Corollary 3.3.4).)

**18.20.10**

$$P_n^{(\lambda)}(x; \phi) = \frac{(2\lambda)_n}{n!} e^{in\phi} {}_2F_1 \left( \begin{matrix} -n, \lambda + ix \\ 2\lambda \end{matrix}; 1 - e^{-2i\phi} \right).$$

**18.21 Hahn Class: Interrelations**

**18.21(i) Dualities**

**Duality of Hahn and Dual Hahn**

**18.21.1** 
$$Q_n(x; \alpha, \beta, N) = R_x(n(n + \alpha + \beta + 1); \alpha, \beta, N), \quad n, x = 0, 1, \dots, N.$$

For the dual Hahn polynomial  $R_n(x; \gamma, \delta, N)$  see §18.25.

**Self-Dualities**

$$K_n(x; p, N) = K_x(n; p, N), \quad n, x = 0, 1, \dots, N.$$

**18.21.2** 
$$M_n(x; \beta, c) = M_x(n; \beta, c), \quad n, x = 0, 1, 2, \dots$$

$$C_n(x, a) = C_x(n, a), \quad n, x = 0, 1, 2, \dots$$

**18.21(ii) Limit Relations and Special Cases**

**Hahn → Krawtchouk**

**18.21.3** 
$$\lim_{t \rightarrow \infty} Q_n(x; pt, (1 - p)t, N) = K_n(x; p, N).$$

**Hahn → Meixner**

**18.21.4** 
$$\lim_{N \rightarrow \infty} Q_n(x; b - 1, N(c^{-1} - 1), N) = M_n(x; b, c).$$

**Hahn → Jacobi**

**18.21.5** 
$$\lim_{N \rightarrow \infty} Q_n(Nx; \alpha, \beta, N) = \frac{P_n^{(\alpha, \beta)}(1 - 2x)}{P_n^{(\alpha, \beta)}(1)}.$$

**Krawtchouk → Charlier**

**18.21.6** 
$$\lim_{N \rightarrow \infty} K_n(x; N^{-1}a, N) = C_n(x, a).$$

**Meixner → Charlier**

**18.21.7** 
$$\lim_{\beta \rightarrow \infty} M_n(x; \beta, a(a + \beta)^{-1}) = C_n(x, a).$$

**Meixner → Laguerre**

**18.21.8** 
$$\lim_{c \rightarrow 1} M_n((1 - c)^{-1}x; \alpha + 1, c) = \frac{L_n^{(\alpha)}(x)}{L_n^{(\alpha)}(0)}.$$

**Charlier → Hermite**

**18.21.9** 
$$\lim_{a \rightarrow \infty} (2a)^{\frac{1}{2}n} C_n((2a)^{\frac{1}{2}}x + a, a) = (-1)^n H_n(x).$$

**Continuous Hahn → Meixner–Pollaczek**

**18.21.10** 
$$\lim_{t \rightarrow \infty} t^{-n} p_n(x - t; \lambda + it, -t \tan \phi, \lambda - it, -t \tan \phi) = \frac{(-1)^n}{(\cos \phi)^n} P_n^{(\lambda)}(x; \phi).$$

**18.21.11**

$$p_n(x; a, a + \frac{1}{2}, a, a + \frac{1}{2}) = 2^{-2n} (4a + n)_n P_n^{(2a)}(2x; \frac{1}{2}\pi).$$



**Meixner–Pollaczek → Laguerre**

**18.21.12**  $\lim_{\phi \rightarrow 0} P_n^{(\frac{1}{2}\alpha + \frac{1}{2})}(-2\phi)^{-1}x; \phi = L_n^{(\alpha)}(x).$

A graphical representation of limits in §§18.7(iii), 18.21(ii), and 18.26(ii) is provided by the *Askey scheme* depicted in Figure 18.21.1.

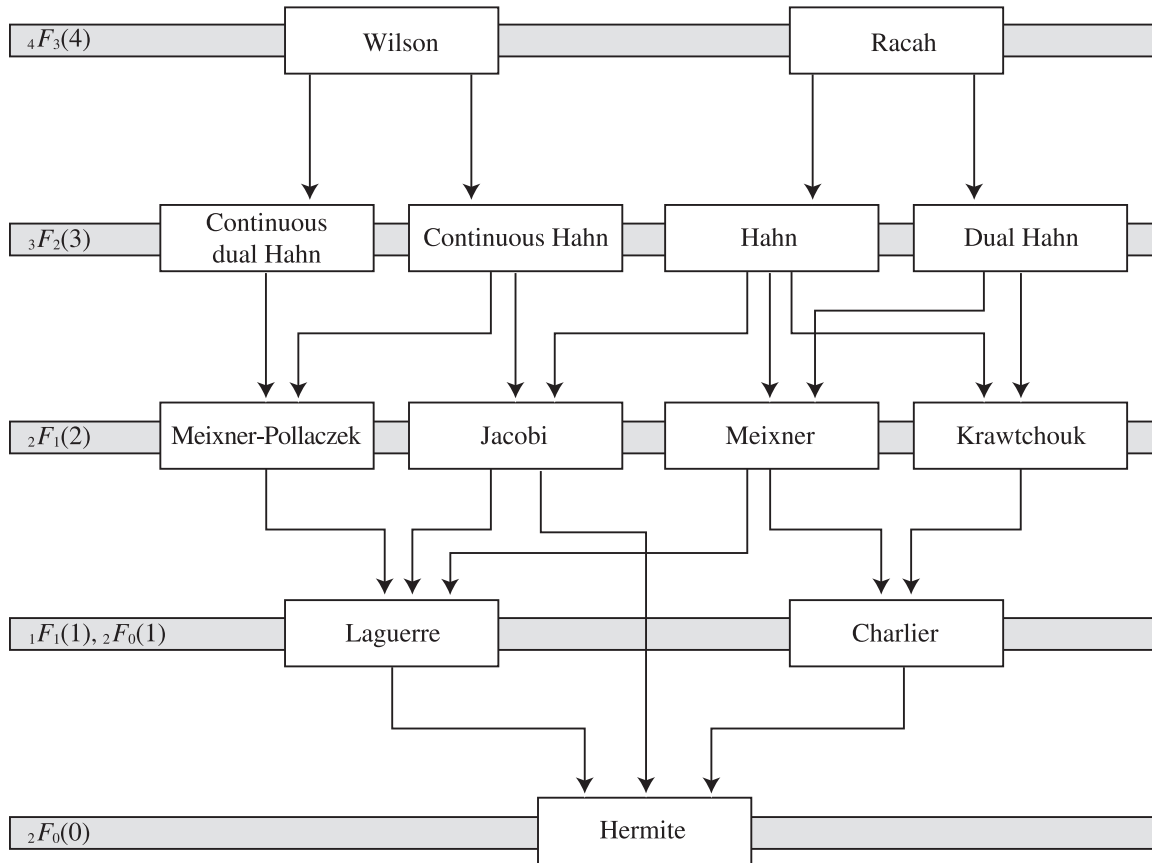


Figure 18.21.1: Askey scheme. The number of free real parameters is zero for Hermite polynomials. It increases by one for each row ascended in the scheme, culminating with four free real parameters for the Wilson and Racah polynomials. (This is with the convention that the real and imaginary parts of the parameters are counted separately in the case of the continuous Hahn polynomials.)

**18.22 Hahn Class: Recurrence Relations and Differences**

**18.22(i) Recurrence Relations in  $n$**

**Hahn**

With

**18.22.1**  $p_n(x) = Q_n(x; \alpha, \beta, N),$

**18.22.2**  $-xp_n(x) = A_n p_{n+1}(x) - (A_n + C_n)p_n(x) + C_n p_{n-1}(x),$

where

**18.22.3**  $A_n = \frac{(n + \alpha + \beta + 1)(n + \alpha + 1)(N - n)}{(2n + \alpha + \beta + 1)(2n + \alpha + \beta + 2)},$   
 $C_n = \frac{n(n + \alpha + \beta + N + 1)(n + \beta)}{(2n + \alpha + \beta)(2n + \alpha + \beta + 1)}.$

**Krawtchouk, Meixner, and Charlier**

These polynomials satisfy (18.22.2) with  $p_n(x)$ ,  $A_n$ , and  $C_n$  as in Table 18.22.1.

Table 18.22.1: Recurrence relations (18.22.2) for Krawtchouk, Meixner, and Charlier polynomials.

$p_n(x)$	$A_n$	$C_n$
$K_n(x; p, N)$	$p(N - n)$	$n(1 - p)$
$M_n(x; \beta, c)$	$\frac{c(n + \beta)}{1 - c}$	$\frac{n}{1 - c}$
$C_n(x, a)$	$a$	$n$

**Continuous Hahn**

With

18.22.4  $q_n(x) = p_n(x; a, b, \bar{a}, \bar{b}) / p_n(ia; a, b, \bar{a}, \bar{b})$ ,

18.22.5  $(a + ix)q_n(x) = \tilde{A}_n q_{n+1}(x) - (\tilde{A}_n + \tilde{C}_n)q_n(x) + \tilde{C}_n q_{n-1}(x)$ ,

where

18.22.6

$$\tilde{A}_n = -\frac{(n + 2\Re(a + b) - 1)(n + a + \bar{a})(n + a + \bar{b})}{(2n + 2\Re(a + b) - 1)(2n + 2\Re(a + b))}$$

$$\tilde{C}_n = \frac{n(n + b + \bar{a} - 1)(n + b + \bar{b} - 1)}{(2n + 2\Re(a + b) - 2)(2n + 2\Re(a + b) - 1)}$$

**Meixner–Pollaczek**

With

18.22.7  $p_n(x) = P_n^{(\lambda)}(x; \phi)$ ,

18.22.8  $(n + 1)p_{n+1}(x) = 2(x \sin \phi + (n + \lambda) \cos \phi) p_n(x) - (n + 2\lambda - 1)p_{n-1}(x)$ .

**18.22(ii) Difference Equations in  $x$**

**Hahn**

With

18.22.9  $p_n(x) = Q_n(x; \alpha, \beta, N)$ ,

18.22.10  $A(x)p_n(x + 1) - (A(x) + C(x))p_n(x) + C(x)p_n(x - 1) - n(n + \alpha + \beta + 1)p_n(x) = 0$ ,

where

18.22.11  $A(x) = (x + \alpha + 1)(x - N)$ ,  
 $C(x) = x(x - \beta - N - 1)$ .

**Krawtchouk, Meixner, and Charlier**

18.22.12  $A(x)p_n(x + 1) - (A(x) + C(x))p_n(x) + C(x)p_n(x - 1) + \lambda_n p_n(x) = 0$ .

For  $A(x)$ ,  $C(x)$ , and  $\lambda_n$  in (18.22.12) see Table 18.22.2.

Table 18.22.2: Difference equations (18.22.12) for Krawtchouk, Meixner, and Charlier polynomials.

$p_n(x)$	$A(x)$	$C(x)$	$\lambda_n$
$K_n(x; p, N)$	$p(x - N)$	$(p - 1)x$	$-n$
$M_n(x; \beta, c)$	$c(x + \beta)$	$x$	$n(1 - c)$
$C_n(x, a)$	$a$	$x$	$n$

**Continuous Hahn**

With

18.22.13  $p_n(x) = p_n(x; a, b, \bar{a}, \bar{b})$ ,

18.22.14  $A(x)p_n(x + i) - (A(x) + C(x))p_n(x) + C(x)p_n(x - i) + n(n + 2\Re(a + b) - 1)p_n(x) = 0$ ,

where

18.22.15

$$A(x) = (x + i\bar{a})(x + i\bar{b}), \quad C(x) = (x - ia)(x - ib).$$

**Meixner–Pollaczek**

With

18.22.16  $p_n(x) = P_n^{(\lambda)}(x; \phi)$ ,

18.22.17  $A(x)p_n(x + i) - (A(x) + C(x))p_n(x) + C(x)p_n(x - i) + 2n \sin \phi p_n(x) = 0$ ,

where

18.22.18  $A(x) = e^{i\phi}(x + i\lambda)$ ,  $C(x) = e^{-i\phi}(x - i\lambda)$ .

**18.22(iii)  $x$ -Differences**

**Hahn**

18.22.19

$$\Delta_x Q_n(x; \alpha, \beta, N) = -\frac{n(n + \alpha + \beta + 1)}{(\alpha + 1)N} Q_{n-1}(x; \alpha + 1, \beta + 1, N - 1)$$

18.22.20

$$\nabla_x \left( \frac{(\alpha + 1)_x (\beta + 1)_{N-x}}{x! (N - x)!} Q_n(x; \alpha, \beta, N) \right) = \frac{N + 1}{\beta} \frac{(\alpha)_x (\beta)_{N+1-x}}{x! (N + 1 - x)!} \times Q_{n+1}(x; \alpha - 1, \beta - 1, N + 1)$$

**Krawtchouk**

18.22.21  $\Delta_x K_n(x; p, N) = -\frac{n}{pN} K_{n-1}(x; p, N - 1)$ ,

18.22.22  $\nabla_x \left( \binom{N}{x} p^x (1 - p)^{N-x} K_n(x; p, N) \right) = \binom{N + 1}{x} p^x (1 - p)^{N-x} K_{n+1}(x; p, N + 1)$ .

**Meixner**

18.22.23  $\Delta_x M_n(x; \beta, c) = -\frac{n(1 - c)}{\beta c} M_{n-1}(x; \beta + 1, c)$ ,

18.22.24  $\nabla_x \left( \frac{(\beta)_x c^x}{x!} M_n(x; \beta, c) \right) = \frac{(\beta - 1)_x c^x}{x!} M_{n+1}(x; \beta - 1, c)$ .

**Charlier**

18.22.25  $\Delta_x C_n(x, a) = -\frac{n}{a} C_{n-1}(x, a)$ ,

18.22.26  $\nabla_x \left( \frac{a^x}{x!} C_n(x, a) \right) = \frac{a^x}{x!} C_{n+1}(x, a)$ .

**Continuous Hahn**

18.22.27 
$$\delta_x (p_n(x; a, b, \bar{a}, \bar{b})) = (n + 2\Re(a + b) - 1) p_{n-1}(x; a + \frac{1}{2}, b + \frac{1}{2}, \bar{a} + \frac{1}{2}, \bar{b} + \frac{1}{2}),$$

18.22.28 
$$\delta_x (w(x; a + \frac{1}{2}, b + \frac{1}{2}, \bar{a} + \frac{1}{2}, \bar{b} + \frac{1}{2})p_n(x; a + \frac{1}{2}, b + \frac{1}{2}, \bar{a} + \frac{1}{2}, \bar{b} + \frac{1}{2})) = -(n + 1)w(x; a, b, \bar{a}, \bar{b})p_{n+1}(x; a, b, \bar{a}, \bar{b}).$$

**Meixner–Pollaczek**

18.22.29 
$$\delta_x (P_n^{(\lambda)}(x; \phi)) = 2 \sin \phi P_{n-1}^{(\lambda+\frac{1}{2})}(x; \phi),$$

18.22.30 
$$\begin{aligned} \delta_x (w^{(\lambda+\frac{1}{2})}(x; \phi) P_n^{(\lambda+\frac{1}{2})}(x; \phi)) \\ = -(n + 1)w^{(\lambda)}(x; \phi) P_{n+1}^{(\lambda)}(x; \phi). \end{aligned}$$

**18.23 Hahn Class: Generating Functions**

For the definition of generalized hypergeometric functions see §16.2.

**Hahn**

18.23.1

$$\begin{aligned} {}_1F_1 \left( \begin{matrix} -x \\ \alpha + 1 \end{matrix}; -z \right) {}_1F_1 \left( \begin{matrix} x - N \\ \beta + 1 \end{matrix}; z \right) \\ = \sum_{n=0}^N \frac{(-N)_n}{(\beta + 1)_n n!} Q_n(x; \alpha, \beta, N) z^n, \quad x = 0, 1, \dots, N. \end{aligned}$$

18.23.2 
$$\begin{aligned} {}_2F_0 \left( \begin{matrix} -x, -x + \beta + N + 1 \\ - \end{matrix}; -z \right) \\ \times {}_2F_0 \left( \begin{matrix} x - N, x + \alpha + 1 \\ - \end{matrix}; z \right) \\ = \sum_{n=0}^N \frac{(-N)_n (\alpha + 1)_n}{n!} Q_n(x; \alpha, \beta, N) z^n, \\ x = 0, 1, \dots, N. \end{aligned}$$

**Krawtchouk**

18.23.3

$$\left( 1 - \frac{1-p}{p} z \right)^x (1+z)^{N-x} = \sum_{n=0}^N \binom{N}{n} K_n(x; p, N) z^n, \quad x = 0, 1, \dots, N.$$

**Meixner**

18.23.4 
$$\left( 1 - \frac{z}{c} \right)^x (1-z)^{-x-\beta} = \sum_{n=0}^{\infty} \frac{(\beta)_n}{n!} M_n(x; \beta, c) z^n, \quad x = 0, 1, 2, \dots, |z| < 1.$$

**Charlier**

18.23.5 
$$e^z \left( 1 - \frac{z}{a} \right)^x = \sum_{n=0}^{\infty} \frac{C_n(x, a)}{n!} z^n, \quad x = 0, 1, 2, \dots$$

**Continuous Hahn**

18.23.6 
$$\begin{aligned} {}_1F_1 \left( \begin{matrix} a + ix \\ 2\Re a \end{matrix}; -iz \right) {}_1F_1 \left( \begin{matrix} \bar{b} - ix \\ 2\Re b \end{matrix}; iz \right) \\ = \sum_{n=0}^{\infty} \frac{p_n(x; a, b, \bar{a}, \bar{b})}{(2\Re a)_n (2\Re b)_n} z^n. \end{aligned}$$

**Meixner–Pollaczek**

18.23.7 
$$\begin{aligned} (1 - e^{i\phi} z)^{-\lambda+ix} (1 - e^{-i\phi} z)^{-\lambda-ix} \\ = \sum_{n=0}^{\infty} P_n^{(\lambda)}(x; \phi) z^n, \quad |z| < 1. \end{aligned}$$

**18.24 Hahn Class: Asymptotic Approximations**

**Krawtchouk**

With  $x = \lambda N$  and  $\nu = n/N$ , Li and Wong (2000) gives an asymptotic expansion for  $K_n(x; p, N)$  as  $n \rightarrow \infty$ , that holds uniformly for  $\lambda$  and  $\nu$  in compact subintervals of  $(0, 1)$ . This expansion is in terms of the parabolic cylinder function and its derivative.

With  $\mu = N/n$  and  $x$  fixed, Qiu and Wong (2004) gives an asymptotic expansion for  $K_n(x; p, N)$  as  $n \rightarrow \infty$ , that holds uniformly for  $\mu \in [1, \infty)$ . This expansion is in terms of confluent hypergeometric functions. Asymptotic approximations are also provided for the zeros of  $K_n(x; p, N)$  in various cases depending on the values of  $p$  and  $\mu$ .

**Meixner**

For two asymptotic expansions of  $M_n(nx; \beta, c)$  as  $n \rightarrow \infty$ , with  $\beta$  and  $c$  fixed, see Jin and Wong (1998). The first expansion holds uniformly for  $\delta \leq x \leq 1 + \delta$ , and the second for  $1 - \delta \leq x \leq 1 + \delta^{-1}$ ,  $\delta$  being an arbitrary small positive constant. Both expansions are in terms of parabolic cylinder functions.

For asymptotic approximations for the zeros of  $M_n(nx; \beta, c)$  in terms of zeros of  $\text{Ai}(x)$  (§9.9(i)), see Jin and Wong (1999).

**Charlier**

Dunster (2001b) provides various asymptotic expansions for  $C_n(x, a)$  as  $n \rightarrow \infty$ , in terms of elementary functions or in terms of Bessel functions. Taken together, these expansions are uniformly valid for  $-\infty < x < \infty$  and for  $a$  in unbounded intervals—each of which contains  $[0, (1 - \delta)n]$ , where  $\delta$  again denotes an arbitrary

small positive constant. See also Bo and Wong (1994) and Goh (1998).

**Meixner–Pollaczek**

For an asymptotic expansion of  $P_n^{(\lambda)}(nx; \phi)$  as  $n \rightarrow \infty$ , with  $\phi$  fixed, see Li and Wong (2001). This expansion is uniformly valid in any compact  $x$ -interval on the real line and is in terms of parabolic cylinder functions. Corresponding approximations are included for the zeros of  $P_n^{(\lambda)}(nx; \phi)$ .

**Approximations in Terms of Laguerre Polynomials**

For asymptotic approximations to  $P_n^{(\lambda)}(x; \phi)$  as  $|x + i\lambda| \rightarrow \infty$ , with  $n$  fixed, see Temme and López (2001). These approximations are in terms of Laguerre polynomials and hold uniformly for  $\text{ph}(x + i\lambda) \in [0, \pi]$ . Compare also (18.21.12). Similar approximations are included for Jacobi, Krawtchouk, and Meixner polynomials.

**18.25 Wilson Class: Definitions**

**18.25(i) Preliminaries**

For the Wilson class OP's  $p_n(x)$  with  $x = \lambda(y)$ : if the  $y$ -orthogonality set is  $\{0, 1, \dots, N\}$ , then the role of the differentiation operator  $d/dx$  in the Jacobi, Laguerre, and Hermite cases is played by the operator  $\Delta_y$  followed by division by  $\Delta_y(\lambda(y))$ , or by the operator  $\nabla_y$  followed by division by  $\nabla_y(\lambda(y))$ . Alternatively if the  $y$ -orthogonality interval is  $(0, \infty)$ , then the role of  $d/dx$  is played by the operator  $\delta_y$  followed by division by  $\delta_y(\lambda(y))$ .

Table 18.25.1 lists the transformations of variable, orthogonality ranges, and parameter constraints that are needed in §18.2(i) for the Wilson polynomials  $W_n(x; a, b, c, d)$ , continuous dual Hahn polynomials  $S_n(x; a, b, c)$ , Racah polynomials  $R_n(x; \alpha, \beta, \gamma, \delta)$ , and dual Hahn polynomials  $R_n(x; \gamma, \delta, N)$ .

Table 18.25.1: Wilson class OP's: transformations of variable, orthogonality ranges, and parameter constraints.

$p_n(x)$	$x = \lambda(y)$	Orthogonality range for $y$	Constraints
$W_n(x; a, b, c, d)$	$y^2$	$(0, \infty)$	$\Re(a, b, c, d) > 0$ ; nonreal parameters in conjugate pairs
$S_n(x; a, b, c)$	$y^2$	$(0, \infty)$	$\Re(a, b, c) > 0$ ; nonreal parameters in conjugate pairs
$R_n(x; \alpha, \beta, \gamma, \delta)$	$y(y + \gamma + \delta + 1)$	$\{0, 1, \dots, N\}$	$\alpha + 1$ or $\beta + \delta + 1$ or $\gamma + 1 = -N$ ; for further constraints see (18.25.1)
$R_n(x; \gamma, \delta, N)$	$y(y + \gamma + \delta + 1)$	$\{0, 1, \dots, N\}$	$\gamma, \delta > -1$ or $< -N$

**Further Constraints for Racah Polynomials**

If  $\alpha + 1 = -N$ , then the weights will be positive iff one of the following eight sets of inequalities holds:

- $-\delta - 1 < \beta < \gamma + 1 < -N + 1.$
- $N - 1 < -\delta - 1 < \beta < \gamma + 1.$
- $\gamma, \delta > -1, \quad \beta > N + \gamma.$
- 18.25.1**  $\gamma, \delta > -1, \quad \beta < -N - \delta.$
- $N - 1 < N + \gamma < \beta < -N - \delta.$
- $N + \gamma < \beta < -N - \delta < -N - 1.$
- $\gamma, \delta < -N, \quad \beta > -1 - \delta.$
- $\gamma, \delta < -N, \quad \beta < \gamma + 1.$

The first four sets imply  $\gamma + \delta > -2$ , and the last four imply  $\gamma + \delta < -2N$ .

**18.25(ii) Weights and Normalizations: Continuous Cases**

**18.25.2** 
$$\int_0^\infty p_n(x)p_m(x)w(x) dx = h_n\delta_{n,m}.$$

**Wilson**

**18.25.3** 
$$p_n(x) = W_n(x; a_1, a_2, a_3, a_4),$$

**18.25.4** 
$$w(y^2) = \frac{1}{2y} \left| \frac{\prod_j \Gamma(a_j + iy)}{\Gamma(2iy)} \right|^2,$$

**18.25.5** 
$$h_n = \frac{n! 2\pi \prod_{j < \ell} \Gamma(n + a_j + a_\ell)}{(2n - 1 + \sum_j a_j) \Gamma(n - 1 + \sum_j a_j)}.$$

**Continuous Dual Hahn**

18.25.6  $p_n(x) = S_n(x; a_1, a_2, a_3),$   
 18.25.7  $w(y^2) = \frac{1}{2y} \left| \frac{\prod_j \Gamma(a_j + iy)}{\Gamma(2iy)} \right|^2,$   
 18.25.8  $h_n = n! 2\pi \prod_{j < \ell} \Gamma(n + a_j + a_\ell).$

**18.25(iii) Weights and Normalizations: Discrete Cases**

18.25.9  $\sum_{y=0}^N p_n(y(y+\gamma+\delta+1))p_m(y(y+\gamma+\delta+1))$   
 $\times \frac{\gamma + \delta + 1 + 2y}{\gamma + \delta + 1 + y} \omega_y = h_n \delta_{n,m}.$

**Racah**

18.25.10  $p_n(x) = R_n(x; \alpha, \beta, \gamma, \delta), \quad \alpha + 1 = -N,$   
 18.25.11  $\omega_y = \frac{(\alpha + 1)_y (\beta + \delta + 1)_y (\gamma + 1)_y (\gamma + \delta + 2)_y}{(-\alpha + \gamma + \delta + 1)_y (-\beta + \gamma + 1)_y (\delta + 1)_y y!},$   
 18.25.12  $h_n = \frac{(-\beta)_N (\gamma + \delta + 2)_N}{(-\beta + \gamma + 1)_N (\delta + 1)_N} \frac{(n + \alpha + \beta + 1)_n n!}{(\alpha + \beta + 2)_{2n}}$   
 $\times \frac{(\alpha + \beta - \gamma + 1)_n (\alpha - \delta + 1)_n (\beta + 1)_n}{(\alpha + 1)_n (\beta + \delta + 1)_n (\gamma + 1)_n}.$

**Dual Hahn**

18.25.13  $p_n(x) = R_n(x; \gamma, \delta, N),$   
 18.25.14  $\omega_y = \frac{(-1)^y (-N)_y (\gamma + 1)_y (\gamma + \delta + 1)_2}{(N + \gamma + \delta + 2)_y (\delta + 1)_y y!},$   
 18.25.15  $h_n = \frac{n! (N - n)! (\gamma + \delta + 2)_N}{N! (\gamma + 1)_n (\delta + 1)_{N-n}}.$

**18.25(iv) Leading Coefficients**

Table 18.25.2 provides the leading coefficients  $k_n$  (§18.2(iii)) for the Wilson, continuous dual Hahn, Racah, and dual Hahn polynomials.

Table 18.25.2: Wilson class OP's: leading coefficients.

$p_n(x)$	$k_n$
$W_n(x; a, b, c, d)$	$(-1)^n (n + a + b + c + d - 1)_n$
$S_n(x; a, b, c)$	$(-1)^n$
$R_n(x; \alpha, \beta, \gamma, \delta)$	$\frac{(n + \alpha + \beta + 1)_n}{(\alpha + 1)_n (\beta + \delta + 1)_n (\gamma + 1)_n}$
$R_n(x; \gamma, \delta, N)$	$\frac{1}{(\gamma + 1)_n (-N)_n}$

**18.26 Wilson Class: Continued**

**18.26(i) Representations as Generalized Hypergeometric Functions**

For the definition of generalized hypergeometric functions see §16.2.

18.26.1  $W_n(y^2; a, b, c, d) = (a + b)_n (a + c)_n (a + d)_n {}_4F_3 \left( \begin{matrix} -n, n + a + b + c + d - 1, a + iy, a - iy \\ a + b, a + c, a + d \end{matrix}; 1 \right).$

18.26.2  $\frac{S_n(y^2; a, b, c)}{(a + b)_n (a + c)_n} = {}_3F_2 \left( \begin{matrix} -n, a + iy, a - iy \\ a + b, a + c \end{matrix}; 1 \right).$

18.26.3  $R_n(y(y + \gamma + \delta + 1); \alpha, \beta, \gamma, \delta) = {}_4F_3 \left( \begin{matrix} -n, n + \alpha + \beta + 1, -y, y + \gamma + \delta + 1 \\ \alpha + 1, \beta + \delta + 1, \gamma + 1 \end{matrix}; 1 \right),$   
 $\alpha + 1 \text{ or } \beta + \delta + 1 \text{ or } \gamma + 1 = -N; n = 0, 1, \dots, N.$

18.26.4  $R_n(y(y + \gamma + \delta + 1); \gamma, \delta, N) = {}_3F_2 \left( \begin{matrix} -n, -y, y + \gamma + \delta + 1 \\ \gamma + 1, -N \end{matrix}; 1 \right), \quad n = 0, 1, \dots, N.$

**18.26(ii) Limit Relations**

**Wilson → Continuous Dual Hahn**

18.26.5  $\lim_{d \rightarrow \infty} \frac{W_n(x; a, b, c, d)}{(a + d)_n} = S_n(x; a, b, c).$

**Wilson → Continuous Hahn**

$$18.26.6 \quad \lim_{t \rightarrow \infty} \frac{W_n((x+t)^2; a-it, b-it, \bar{a}+it, \bar{b}+it)}{(-2t)^n n!} = p_n(x; a, b, \bar{a}, \bar{b}).$$

**Wilson → Jacobi**

$$18.26.7 \quad \lim_{t \rightarrow \infty} \frac{W_n(\frac{1}{2}(1-x)t^2; \frac{1}{2}\alpha + \frac{1}{2}, \frac{1}{2}\alpha + \frac{1}{2}, \frac{1}{2}\beta + \frac{1}{2} + it, \frac{1}{2}\beta + \frac{1}{2} - it)}{t^{2n} n!} = P_n^{(\alpha, \beta)}(x).$$

**Continuous Dual Hahn → Meixner–Pollaczek**

$$18.26.8 \quad \lim_{t \rightarrow \infty} S_n((x-t)^2; \lambda + it, \lambda - it, t \cot \phi) / t^n = n! (\csc \phi)^n P_n^{(\lambda)}(x; \phi).$$

**Racah → Dual Hahn**

$$18.26.9 \quad \lim_{\beta \rightarrow \infty} R_n(x; -N-1, \beta, \gamma, \delta) = R_n(x; \gamma, \delta, N).$$

**Racah → Hahn**

$$18.26.10 \quad \lim_{\delta \rightarrow \infty} R_n(x(x+\gamma+\delta+1); \alpha, \beta, -N-1, \delta) = Q_n(x; \alpha, \beta, N).$$

**Dual Hahn → Krawtchouk**

$$18.26.11 \quad \lim_{t \rightarrow \infty} R_n(x(x+t+1); pt, (1-p)t, N) = K_n(x; p, N).$$

**Dual Hahn → Meixner**

With

$$18.26.12 \quad r(x; \beta, c, N) = x(x + \beta + c^{-1}(1-c)N),$$

$$18.26.13 \quad \lim_{N \rightarrow \infty} R_n(r(x; \beta, c, N); \beta-1, c^{-1}(1-c)N, N) = M_n(x; \beta, c).$$

See also Figure 18.21.1.

**18.26(iii) Difference Relations**

For comments on the use of the forward-difference operator  $\Delta_x$ , the backward-difference operator  $\nabla_x$ , and the central-difference operator  $\delta_x$ , see §18.2(ii).

For each family only the  $y$ -difference that lowers  $n$  is given. See Koekoek and Swarttouw (1998, Chapter 1) for further formulas.

$$18.26.14 \quad \delta_y (W_n(y^2; a, b, c, d)) / \delta_y(y^2) = -n(n+a+b+c+d-1) W_{n-1}(y^2; a + \frac{1}{2}, b + \frac{1}{2}, c + \frac{1}{2}, d + \frac{1}{2}).$$

$$18.26.15 \quad \delta_y (S_n(y^2; a, b, c)) / \delta_y(y^2) = -n S_{n-1}(y^2; a + \frac{1}{2}, b + \frac{1}{2}, c + \frac{1}{2}).$$

18.26.16

$$\frac{\Delta_y (R_n(y(y+\gamma+\delta+1); \alpha, \beta, \gamma, \delta))}{\Delta_y (y(y+\gamma+\delta+1))} = \frac{n(n+\alpha+\beta+1)}{(\alpha+1)(\beta+\delta+1)(\gamma+1)} R_{n-1}(y(y+\gamma+\delta+2); \alpha+1, \beta+1, \gamma+1, \delta).$$

18.26.17

$$\frac{\Delta_y (R_n(y(y+\gamma+\delta+1); \gamma, \delta, N))}{\Delta_y (y(y+\gamma+\delta+1))} = -\frac{n}{(\gamma+1)N} R_{n-1}(y(y+\gamma+\delta+2); \gamma+1, \delta, N-1).$$

**18.26(iv) Generating Functions**

For the hypergeometric function  ${}_2F_1$  see §§15.1 and 15.2(i).

**Wilson**

$$18.26.18 \quad {}_2F_1 \left( \begin{matrix} a+iy, d+iy \\ a+d \end{matrix}; z \right) {}_2F_1 \left( \begin{matrix} b-iy, c-iy \\ b+c \end{matrix}; z \right) = \sum_{n=0}^{\infty} \frac{W_n(y^2; a, b, c, d)}{(a+d)_n (b+c)_n n!} z^n, \quad |z| < 1.$$

**Continuous Dual Hahn**

**18.26.19** 
$$(1 - z)^{-c+iy} {}_2F_1\left(\begin{matrix} a + iy, b + iy \\ a + b \end{matrix}; z\right) = \sum_{n=0}^{\infty} \frac{S_n(y^2; a, b, c)}{(a + b)_n n!} z^n, \quad |z| < 1.$$

**Racah**

**18.26.20** 
$${}_2F_1\left(\begin{matrix} -y, -y + \beta - \gamma \\ \beta + \delta + 1 \end{matrix}; z\right) {}_2F_1\left(\begin{matrix} y - N, y + \gamma + 1 \\ -\delta - N \end{matrix}; z\right) = \sum_{n=0}^N \frac{(-N)_n (\gamma + 1)_n}{(-\delta - N)_n n!} R_n(y(y + \gamma + \delta + 1); -N - 1, \beta, \gamma, \delta) z^n.$$

**Dual Hahn**

**18.26.21** 
$$(1 - z)^y {}_2F_1\left(\begin{matrix} y - N, y + \gamma + 1 \\ -\delta - N \end{matrix}; z\right) = \sum_{n=0}^N \frac{(\gamma + 1)_n (-N)_n}{(-\delta - N)_n n!} R_n(y(y + \gamma + \delta + 1); \gamma, \delta, N) z^n.$$

**18.26(v) Asymptotic Approximations**

For asymptotic expansions of Wilson polynomials of large degree see Wilson (1991), and for asymptotic approximations to their largest zeros see Chen and Ismail (1998).

All these systems of OP's have orthogonality properties of the form

**18.27.2** 
$$\sum_{x \in X} p_n(x) p_m(x) |x| v_x = h_n \delta_{n,m},$$

where  $X$  is given by  $X = \{aq^y\}_{y \in I_+}$  or  $X = \{aq^y\}_{y \in I_+} \cup \{-bq^y\}_{y \in I_-}$ . Here  $a, b$  are fixed positive real numbers, and  $I_+$  and  $I_-$  are sequences of successive integers, finite or unbounded in one direction, or unbounded in both directions. If  $I_+$  and  $I_-$  are both nonempty, then they are both unbounded to the right. Some of the systems of OP's that occur in the classification do not have a unique orthogonality property. Thus in addition to a relation of the form (18.27.2), such systems may also satisfy orthogonality relations with respect to a continuous weight function on some interval.

Here only a few families are mentioned. They are defined by their  $q$ -hypergeometric representations, followed by their orthogonality properties. For other formulas, including  $q$ -difference equations, recurrence relations, duality formulas, special cases, and limit relations, see Koekoek and Swarttouw (1998, Chapter 3). See also Gasper and Rahman (2004, pp. 195–199, 228–230) and Ismail (2005, Chapters 13, 18, 21).

**Other Orthogonal Polynomials**

**18.27  $q$ -Hahn Class**

**18.27(i) Introduction**

The  $q$ -hypergeometric OP's comprise the  $q$ -Hahn class OP's and the Askey–Wilson class OP's (§18.28). For the notation of  $q$ -hypergeometric functions see §§17.2 and 17.4(i).

The  $q$ -Hahn class OP's comprise systems of OP's  $\{p_n(x)\}$ ,  $n = 0, 1, \dots, N$ , or  $n = 0, 1, 2, \dots$ , that are eigenfunctions of a second-order  $q$ -difference operator. Thus

**18.27.1** 
$$A(x)p_n(qx) + B(x)p_n(x) + C(x)p_n(q^{-1}x) = \lambda_n p_n(x),$$

where  $A(x)$ ,  $B(x)$ , and  $C(x)$  are independent of  $n$ , and where the  $\lambda_n$  are the eigenvalues. In the  $q$ -Hahn class OP's the role of the operator  $d/dx$  in the Jacobi, Laguerre, and Hermite cases is played by the  $q$ -derivative  $\mathcal{D}_q$ , as defined in (17.2.41). A (nonexhaustive) classification of such systems of OP's was made by Hahn (1949). There are 18 families of OP's of  $q$ -Hahn class. These families depend on further parameters, in addition to  $q$ . The generic (top level) cases are the  $q$ -Hahn polynomials and the big  $q$ -Jacobi polynomials, each of which depends on three further parameters.

**18.27(ii)  $q$ -Hahn Polynomials**

**18.27.3** 
$$Q_n(x) = Q_n(x; \alpha, \beta, N; q) = {}_3\phi_2\left(\begin{matrix} q^{-n}, \alpha\beta q^{n+1}, x \\ \alpha q, q^{-N} \end{matrix}; q, q\right), \quad n = 0, 1, \dots, N.$$

**18.27.4** 
$$\sum_{y=0}^N Q_n(q^{-y}) Q_m(q^{-y}) \frac{(\alpha q, q^{-N}; q)_y (\alpha\beta q)^{-y}}{(q, \beta^{-1} q^{-N}; q)_y} = h_n \delta_{n,m}, \quad n, m = 0, 1, \dots, N.$$

For  $h_n$  see Koekoek and Swarttouw (1998, Eq. (3.6.2)).

**18.27(iii) Big  $q$ -Jacobi Polynomials**

18.27.5 
$$P_n(x; a, b, c; q) = {}_3\phi_2 \left( \begin{matrix} q^{-n}, abq^{n+1}, x \\ aq, cq \end{matrix}; q, q \right),$$
 and

18.27.6 
$$\begin{aligned} & P_n^{(\alpha, \beta)}(x; c, d; q) \\ &= \frac{c^n q^{-(\alpha+1)n} (q^{\alpha+1}, -q^{\alpha+1}c^{-1}d; q)_n}{(q, -q; q)_n} \\ & \times P_n(q^{\alpha+1}c^{-1}dx; q^\alpha, q^\beta, -q^\alpha c^{-1}d; q). \end{aligned}$$

The orthogonality relations are given by (18.27.2), with

18.27.7 
$$p_n(x) = P_n(x; a, b, c; q),$$

18.27.8 
$$X = \{aq^{\ell+1}\}_{\ell=0,1,2,\dots} \cup \{cq^{\ell+1}\}_{\ell=0,1,2,\dots},$$

18.27.9 
$$\begin{aligned} v_x &= \frac{(a^{-1}x, c^{-1}x; q)_\infty}{(x, bc^{-1}x; q)_\infty}, \\ & 0 < a < q^{-1}, 0 < b < q^{-1}, c < 0, \end{aligned}$$
 and

18.27.10 
$$p_n(x) = P_n^{(\alpha, \beta)}(x; c, d; q)$$

18.27.11 
$$X = \{cq^\ell\}_{\ell=0,1,2,\dots} \cup \{-dq^\ell\}_{\ell=0,1,2,\dots},$$

18.27.12 
$$v_x = \frac{(qx/c, -qx/d; q)_\infty}{(q^{\alpha+1}x/c, -q^{\beta+1}x/d; q)_\infty}, \quad \alpha, \beta > -1, c, d > 0.$$

For  $h_n$  see Koekoek and Swarttouw (1998, Eq. (3.5.2)).

**18.27(iv) Little  $q$ -Jacobi Polynomials**

18.27.13 
$$p_n(x) = p_n(x; a, b; q) = {}_2\phi_1 \left( \begin{matrix} q^{-n}, abq^{n+1} \\ aq \end{matrix}; q, qx \right).$$

18.27.14 
$$\begin{aligned} & \sum_{y=0}^{\infty} p_n(q^y)p_m(q^y) \frac{(bq; q)_y (aq)^y}{(q; q)_y} \\ &= h_n \delta_{n,m}, \quad 0 < a < q^{-1}, b < q^{-1}. \end{aligned}$$

For  $h_n$  see Koekoek and Swarttouw (1998, Eq. (3.12.2)).

**18.27(v)  $q$ -Laguerre Polynomials**

18.27.15 
$$L_n^{(\alpha)}(x; q) = \frac{(q^{\alpha+1}; q)_n}{(q; q)_n} {}_1\phi_1 \left( \begin{matrix} q^{-n} \\ q^{\alpha+1} \end{matrix}; q, -xq^{n+\alpha+1} \right).$$

The measure is not uniquely determined:

18.27.16 
$$\begin{aligned} & \int_0^\infty L_n^{(\alpha)}(x; q) L_m^{(\alpha)}(x; q) \frac{x^\alpha}{(-x; q)_\infty} dx \\ &= \frac{(q^{\alpha+1}; q)_n}{(q; q)_n} q^n h_0^{(1)} \delta_{n,m}, \quad \alpha > -1, \end{aligned}$$

where  $h_0^{(1)}$  is given in Koekoek and Swarttouw (1998, Eq. (3.21.2)), and

18.27.17 
$$\begin{aligned} & \sum_{y=-\infty}^{\infty} L_n^{(\alpha)}(cq^y; q) L_m^{(\alpha)}(cq^y; q) \frac{q^{y(\alpha+1)}}{(-cq^y; q)_\infty} \\ &= \frac{(q^{\alpha+1}; q)_n}{(q; q)_n} q^n h_0^{(2)} \delta_{n,m}, \quad \alpha > -1, c > 0, \end{aligned}$$

where  $h_0^{(2)}$  is given in Koekoek and Swarttouw (1998, Eq. (3.21.3)).

**18.27(vi) Stieltjes–Wigert Polynomials**

18.27.18 
$$\begin{aligned} S_n(x; q) &= \sum_{\ell=0}^n \frac{q^{\ell^2}(-x)^\ell}{(q; q)_\ell (q; q)_{n-\ell}} \\ &= \frac{1}{(q; q)_n} {}_1\phi_1 \left( \begin{matrix} q^{-n} \\ 0 \end{matrix}; q, -q^{n+1}x \right). \end{aligned}$$

(Sometimes in the literature  $x$  is replaced by  $q^{\frac{1}{2}}x$ .)

The measure is not uniquely determined:

18.27.19 
$$\int_0^\infty \frac{S_n(x; q) S_m(x; q)}{(-x, -qx^{-1}; q)_\infty} dx = \frac{\ln(q^{-1})}{q^n} \frac{(q; q)_\infty}{(q; q)_n} \delta_{n,m},$$

and

18.27.20 
$$\begin{aligned} & \int_0^\infty S_n(q^{\frac{1}{2}}x; q) S_m(q^{\frac{1}{2}}x; q) \exp\left(-\frac{(\ln x)^2}{2\ln(q^{-1})}\right) dx \\ &= \frac{\sqrt{2\pi q^{-1} \ln(q^{-1})}}{q^n (q; q)_n} \delta_{n,m}. \end{aligned}$$

**18.27(vii) Discrete  $q$ -Hermite I and II Polynomials**

**Discrete  $q$ -Hermite I**

18.27.21 
$$\begin{aligned} h_n(x; q) &= (q; q)_n \sum_{\ell=0}^{\lfloor n/2 \rfloor} \frac{(-1)^\ell q^{\ell(\ell-1)} x^{n-2\ell}}{(q^2; q^2)_\ell (q; q)_{n-2\ell}} \\ &= x^n {}_2\phi_0 \left( \begin{matrix} q^{-n}, q^{-n+1} \\ - \end{matrix}; q^2, x^{-2}q^{2n-1} \right). \end{aligned}$$

18.27.22

$$\begin{aligned} & \sum_{\ell=0}^{\infty} (h_n(q^\ell; q) h_m(q^\ell; q) + h_n(-q^\ell; q) h_m(-q^\ell; q)) \\ & \times (q^{\ell+1}, -q^{\ell+1}; q)_\infty q^\ell \\ &= (q; q)_n (q, -1, -q; q)_\infty q^{n(n-1)/2} \delta_{n,m}. \end{aligned}$$



**Discrete  $q$ -Hermite II**

18.27.23

$$\begin{aligned} \tilde{h}_n(x; q) &= (q; q)_n \sum_{\ell=0}^{\lfloor n/2 \rfloor} \frac{(-1)^\ell q^{-2n\ell} q^{\ell(2\ell+1)} x^{n-2\ell}}{(q^2; q^2)_\ell (q; q)_{n-2\ell}} \\ &= x^n {}_2\phi_1 \left( \begin{matrix} q^{-n}, q^{-n+1} \\ 0 \end{matrix}; q^2, -x^{-2}q^2 \right). \end{aligned}$$

18.27.24

$$\begin{aligned} &\sum_{\ell=-\infty}^{\infty} \left( \tilde{h}_n(cq^\ell; q) \tilde{h}_m(cq^\ell; q) \right. \\ &\quad \left. + \tilde{h}_n(-cq^\ell; q) \tilde{h}_m(-cq^\ell; q) \right) \frac{q^\ell}{(-c^2q^{2\ell}; q^2)_\infty} \\ &= 2 \frac{(q^2, -c^2q, -c^{-2}q; q^2)_\infty}{(q, -c^2, -c^{-2}q^2; q^2)_\infty} \frac{(q; q)_n}{q^{n^2}} \delta_{n,m}, \end{aligned}$$

$c > 0.$

(For discrete  $q$ -Hermite II polynomials the measure is not uniquely determined.)

**18.28 Askey–Wilson Class**

**18.28(i) Introduction**

The Askey–Wilson class OP’s comprise the four-parameter families of Askey–Wilson polynomials and of  $q$ -Racah polynomials, and cases of these families obtained by specialization of parameters. The Askey–Wilson polynomials form a system of OP’s  $\{p_n(x)\}$ ,  $n = 0, 1, 2, \dots$ , that are orthogonal with respect to a weight function on a bounded interval, possibly supplemented with discrete weights on a finite set. The  $q$ -Racah polynomials form a system of OP’s  $\{p_n(x)\}$ ,  $n = 0, 1, 2, \dots, N$ , that are orthogonal with respect to a weight function on a sequence  $\{q^{-y} + cq^{y+1}\}$ ,  $y = 0, 1, \dots, N$ , with  $c$  a constant. Both the Askey–Wilson polynomials and the  $q$ -Racah polynomials can best be described as functions of  $z$  (resp.  $y$ ) such that  $P_n(z) = p_n(\frac{1}{2}(z + z^{-1}))$  in the Askey–Wilson case, and  $P_n(y) = p_n(q^{-y} + cq^{y+1})$  in the  $q$ -Racah case, and both are eigenfunctions of a second-order  $q$ -difference operator similar to (18.27.1).

In the remainder of this section the Askey–Wilson class OP’s are defined by their  $q$ -hypergeometric representations, followed by their orthogonal properties. For further properties see Koekoek and Swarttouw (1998, Chapter 3). See also Gasper and Rahman (2004,

pp. 180–199) and Ismail (2005, Chapter 15). For the notation of  $q$ -hypergeometric functions see §§17.2 and 17.4(i).

**18.28(ii) Askey–Wilson Polynomials**

18.28.1

$$\begin{aligned} p_n(\cos \theta) &= p_n(\cos \theta; a, b, c, d | q) \\ &= a^{-n} \sum_{\ell=0}^n q^\ell (abq^\ell, acq^\ell, adq^\ell; q)_{n-\ell} \\ &\quad \times \frac{(q^{-n}, abcdq^{n-1}; q)_\ell}{(q; q)_\ell} \prod_{j=0}^{\ell-1} (1 - 2aq^j \cos \theta + a^2q^{2j}) \\ &= a^{-n} (ab, ac, ad; q)_n \\ &\quad \times {}_4\phi_3 \left( \begin{matrix} q^{-n}, abcdq^{n-1}, ae^{i\theta}, ae^{-i\theta} \\ ab, ac, ad \end{matrix}; q, q \right). \end{aligned}$$

Assume  $a, b, c, d$  are all real, or two of them are real and two form a conjugate pair, or none of them are real but they form two conjugate pairs. Furthermore,  $|ab|, |ac|, |ad|, |bc|, |bd|, |cd| < 1$ . Then

18.28.2

$$\int_{-1}^1 p_n(x)p_m(x)w(x) dx = h_n \delta_{n,m}, \quad |a|, |b|, |c|, |d| \leq 1,$$

where

$$18.28.3 \quad 2\pi \sin \theta w(\cos \theta) = \left| \frac{(e^{2i\theta}; q)_\infty}{(ae^{i\theta}, be^{i\theta}, ce^{i\theta}, de^{i\theta}; q)_\infty} \right|^2,$$

$$18.28.4 \quad h_0 = \frac{(abcd; q)_\infty}{(q, ab, ac, ad, bc, bd, cd; q)_\infty},$$

18.28.5

$$h_n = h_0 \frac{(1 - abcdq^{n-1})(q, ab, ac, ad, bc, bd, cd; q)_n}{(1 - abcdq^{2n-1})(abcd; q)_n}, \quad n = 1, 2, \dots$$

More generally, without the constraints in (18.28.2),

18.28.6

$$\int_{-1}^1 p_n(x)p_m(x)w(x) dx + \sum_{\ell} p_n(x_\ell)p_m(x_\ell)\omega_\ell = h_n \delta_{n,m},$$

with  $w(x)$  and  $h_n$  as above. Also,  $x_\ell$  are the points  $\frac{1}{2}(\alpha q^\ell + \alpha^{-1}q^{-\ell})$  with  $\alpha$  any of the  $a, b, c, d$  whose absolute value exceeds 1, and the sum is over the  $\ell = 0, 1, 2, \dots$  with  $|\alpha q^\ell| > 1$ . See Koekoek and Swarttouw (1998, Eq. (3.1.3)) for the value of  $\omega_\ell$  when  $\alpha = a$ .

**18.28(iii) Al-Salam–Chihara Polynomials**

**18.28.7**

$$\begin{aligned} Q_n(\cos \theta; a, b | q) &= p_n(\cos \theta; a, b, 0, 0 | q) \\ &= a^{-n} \sum_{\ell=0}^n q^\ell \frac{(abq^\ell; q)_{n-\ell} (q^{-n}; q)_\ell}{(q; q)_\ell} \\ &\quad \times \prod_{j=0}^{\ell-1} (1 - 2aq^j \cos \theta + a^2q^{2j}) \\ &= \frac{(ab; q)_n}{a^n} {}_3\phi_2 \left( \begin{matrix} q^{-n}, ae^{i\theta}, ae^{-i\theta} \\ ab, 0 \end{matrix}; q, q \right) \\ &= (be^{-i\theta}; q)_n e^{in\theta} {}_2\phi_1 \left( \begin{matrix} q^{-n}, ae^{i\theta} \\ b^{-1}q^{1-n}e^{i\theta} \end{matrix}; q, b^{-1}qe^{-i\theta} \right). \\ &\quad \frac{1}{2\pi} \int_0^\pi Q_n(\cos \theta; a, b | q) Q_m(\cos \theta; a, b | q) \end{aligned}$$

**18.28.8**  $\times \left| \frac{(e^{2i\theta}; q)_\infty}{(ae^{i\theta}, be^{i\theta}; q)_\infty} \right|^2 d\theta = \frac{\delta_{n,m}}{(q^{n+1}, abq^n; q)_\infty}$ ,  
 $a, b \in \mathbb{R}$  or  $a = \bar{b}$ ;  $|ab| < 1$ ;  $|a|, |b| \leq 1$ .

More generally, without the constraints  $|a|, |b| \leq 1$  discrete terms need to be added to the right-hand side of (18.28.8); see Koekoek and Swarttouw (1998, Eq. (3.8.3)).

**18.28(iv)  $q^{-1}$ -Al-Salam–Chihara Polynomials**

**18.28.9**

$$\begin{aligned} Q_n\left(\frac{1}{2}(aq^{-y} + a^{-1}q^y); a, b | q^{-1}\right) &= (-1)^n b^n q^{-\frac{1}{2}n(n-1)} \\ &\quad \times ((ab)^{-1}; q)_n {}_3\phi_1 \left( \begin{matrix} q^{-n}, q^{-y}, a^{-2}q^y \\ (ab)^{-1} \end{matrix}; q, q^n ab^{-1} \right). \end{aligned}$$

**18.28.10**

$$\begin{aligned} &\sum_{y=0}^\infty \frac{(1 - q^{2y}a^{-2})(a^{-2}, (ab)^{-1}; q)_y}{(1 - a^{-2})(q, bqa^{-1}; q)_y} (ba^{-1})^y q^{y^2} \\ &\quad \times Q_n\left(\frac{1}{2}(aq^{-y} + a^{-1}q^y); a, b | q^{-1}\right) \\ &\quad \times Q_m\left(\frac{1}{2}(aq^{-y} + a^{-1}q^y); a, b | q^{-1}\right) \\ &= \frac{(qa^{-2}; q)_\infty}{(ba^{-1}q; q)_\infty} (q, (ab)^{-1}; q)_n (ab)^n q^{-n^2} \delta_{n,m}. \end{aligned}$$

Eq. (18.28.10) is valid when either

**18.28.11**  $0 < q < 1, a, b \in \mathbb{R}, ab > 1, a^{-1}b < q^{-1}$ ,

or

**18.28.12**

$0 < q < 1, a/i, b/i \in \mathbb{R}, (\Im a)(\Im b) > 0, a^{-1}b < q^{-1}$ .

If, in addition to (18.28.11) or (18.28.12), we have  $a^{-1}b \leq q$ , then the measure in (18.28.10) is uniquely determined. Also, if  $q < a^{-1}b < q^{-1}$ , then (18.28.10)

holds with  $a, b$  interchanged. For further nondegenerate cases see Chihara and Ismail (1993) and Christiansen and Ismail (2006).

**18.28(v) Continuous  $q$ -Ultraspherical Polynomials**

**18.28.13**

$$\begin{aligned} C_n(\cos \theta; \beta | q) &= \sum_{\ell=0}^n \frac{(\beta; q)_\ell (\beta; q)_{n-\ell}}{(q; q)_\ell (q; q)_{n-\ell}} e^{i(n-2\ell)\theta} \\ &= \frac{(\beta; q)_n}{(q; q)_n} e^{in\theta} {}_2\phi_1 \left( \begin{matrix} q^{-n}, \beta \\ \beta^{-1}q^{1-n} \end{matrix}; q, \beta^{-1}qe^{-2i\theta} \right). \end{aligned}$$

**18.28.14**

$$\begin{aligned} C_n(\cos \theta; \beta | q) &= \frac{(\beta^2; q)_n}{(q; q)_n \beta^{\frac{1}{2}n}} {}_4\phi_3 \left( \begin{matrix} q^{-n}, \beta^2q^n, \beta^{\frac{1}{2}}e^{i\theta}, \beta^{\frac{1}{2}}e^{-i\theta} \\ \beta q^{\frac{1}{2}}, -\beta, -\beta q^{\frac{1}{2}} \end{matrix}; q, q \right). \end{aligned}$$

**18.28.15**

$$\begin{aligned} &\frac{1}{2\pi} \int_0^\pi C_n(\cos \theta; \beta | q) C_m(\cos \theta; \beta | q) \left| \frac{(e^{2i\theta}; q)_\infty}{(\beta e^{2i\theta}; q)_\infty} \right|^2 d\theta \\ &= \frac{(\beta, \beta q; q)_\infty}{(\beta^2, q; q)_\infty} \frac{(1 - \beta)(\beta^2; q)_n}{(1 - \beta q^n)(q; q)_n} \delta_{n,m}, \quad -1 < \beta < 1. \end{aligned}$$

These polynomials are also called *Rogers polynomials*.

**18.28(vi) Continuous  $q$ -Hermite Polynomials**

$$\begin{aligned} H_n(\cos \theta | q) &= \sum_{\ell=0}^n \frac{(q; q)_n e^{i(n-2\ell)\theta}}{(q; q)_\ell (q; q)_{n-\ell}} \\ &= e^{in\theta} {}_2\phi_0 \left( \begin{matrix} q^{-n}, 0 \\ - \end{matrix}; q, q^n e^{-2i\theta} \right). \end{aligned}$$

**18.28.17**

$$\begin{aligned} &\frac{1}{2\pi} \int_0^\pi H_n(\cos \theta | q) H_m(\cos \theta | q) |(e^{2i\theta}; q)_\infty|^2 d\theta \\ &= \frac{\delta_{n,m}}{(q^{n+1}; q)_\infty}. \end{aligned}$$

**18.28(vii) Continuous  $q^{-1}$ -Hermite Polynomials**

$$\begin{aligned} h_n(\sinh t | q) &= \sum_{\ell=0}^n q^{\frac{1}{2}\ell(\ell+1)} \frac{(q^{-n}; q)_\ell}{(q; q)_\ell} e^{(n-2\ell)t} \\ &= e^{nt} {}_1\phi_1 \left( \begin{matrix} q^{-n} \\ 0 \end{matrix}; q, -qe^{-2t} \right) \\ &= i^{-n} H_n(i \sinh t | q^{-1}). \end{aligned}$$

For continuous  $q^{-1}$ -Hermite polynomials the orthogonality measure is not unique. See Askey (1989) and Ismail and Masson (1994) for examples.

**18.28(viii)  $q$ -Racah Polynomials**

With  $x = q^{-y} + \gamma\delta q^{y+1}$ ,

**18.28.19**

$$R_n(x) = R_n(x; \alpha, \beta, \gamma, \delta | q) = \sum_{\ell=0}^n \frac{q^\ell (q^{-n}, \alpha\beta q^{n+1}; q)_\ell}{(\alpha q, \beta\delta q, \gamma q, q; q)_\ell} \prod_{j=0}^{\ell-1} (1 - q^j x + \gamma\delta q^{2j+1}) = {}_4\phi_3 \left( \begin{matrix} q^{-n}, \alpha\beta q^{n+1}, q^{-y}, \gamma\delta q^{y+1} \\ \alpha q, \beta\delta q, \gamma q \end{matrix} ; q, q \right),$$

$\alpha q, \beta\delta q, \text{ or } \gamma q = q^{-N}; n = 0, 1, \dots, N.$

**18.28.20** 
$$\sum_{y=0}^N R_n(q^{-y} + \gamma\delta q^{y+1}) R_m(q^{-y} + \gamma\delta q^{y+1}) \omega_y = h_n \delta_{n,m}, \quad n, m = 0, 1, \dots, N.$$

For  $\omega_y$  and  $h_n$  see Koekoek and Swarttouw (1998, Eq. (3.2.2)).

**18.29 Asymptotic Approximations for  $q$ -Hahn and Askey–Wilson Classes**

Ismail (1986) gives asymptotic expansions as  $n \rightarrow \infty$ , with  $x$  and other parameters fixed, for continuous  $q$ -ultraspherical, big and little  $q$ -Jacobi, and Askey–Wilson polynomials. These asymptotic expansions are in fact convergent expansions. For Askey–Wilson  $p_n(\cos \theta; a, b, c, d | q)$  the leading term is given by

**18.29.1** 
$$(bc, bd, cd; q)_n (Q_n(e^{i\theta}; a, b, c, d | q) + Q_n(e^{-i\theta}; a, b, c, d | q)),$$

where with  $z = e^{\pm i\theta}$ ,

**18.29.2**

$$Q_n(z; a, b, c, d | q) \sim \frac{z^n (az^{-1}, bz^{-1}, cz^{-1}, dz^{-1}; q)_\infty}{(z^{-2}, bc, bd, cd; q)_\infty},$$

$n \rightarrow \infty; z, a, b, c, d, q \text{ fixed.}$

For a uniform asymptotic expansion of the Stieltjes–Wigert polynomials, see Wang and Wong (2006).

For asymptotic approximations to the largest zeros of the  $q$ -Laguerre and continuous  $q^{-1}$ -Hermite polynomials see Chen and Ismail (1998).

**18.30 Associated OP's**

In the recurrence relation (18.2.8) assume that the coefficients  $A_n, B_n$ , and  $C_{n+1}$  are defined when  $n$  is a continuous nonnegative real variable, and let  $c$  be an arbitrary positive constant. Assume also

**18.30.1** 
$$A_n A_{n+1} C_{n+1} > 0, \quad n \geq 0.$$

Then the associated orthogonal polynomials  $p_n(x; c)$  are defined by

**18.30.2** 
$$p_{-1}(x; c) = 0, \quad p_0(x; c) = 1,$$

and

**18.30.3** 
$$p_{n+1}(x; c) = (A_{n+c}x + B_{n+c})p_n(x; c) - C_{n+c}p_{n-1}(x; c), \quad n = 0, 1, \dots$$

Assume also that Eq. (18.30.3) continues to hold, except that when  $n = 0, B_c$  is replaced by an arbitrary real constant. Then the polynomials  $p_n(x, c)$  generated in this manner are called *corecursive associated OP's*.

**Associated Jacobi Polynomials**

These are defined by

**18.30.4** 
$$P_n^{(\alpha, \beta)}(x; c) = p_n(x; c), \quad n = 0, 1, \dots,$$

where  $p_n(x; c)$  is given by (18.30.2) and (18.30.3), with  $A_n, B_n$ , and  $C_n$  as in (18.9.2). Explicitly,

**18.30.5**

$$\frac{(-1)^n (\alpha + \beta + c + 1)_n n! P_n^{(\alpha, \beta)}(x; c)}{(\alpha + \beta + 2c + 1)_n (\beta + c + 1)_n} = \sum_{\ell=0}^n \frac{(-n)_\ell (n + \alpha + \beta + 2c + 1)_\ell}{(c + 1)_\ell (\beta + c + 1)_\ell} \left(\frac{1}{2}x + \frac{1}{2}\right)^\ell \times {}_4F_3 \left( \begin{matrix} \ell - n, n + \ell + \alpha + \beta + 2c + 1, \beta + c, c \\ \beta + \ell + c + 1, \ell + c + 1, \alpha + \beta + 2c \end{matrix} ; 1 \right),$$

where the generalized hypergeometric function  ${}_4F_3$  is defined by (16.2.1).

For corresponding corecursive associated Jacobi polynomials see Letessier (1995).

**Associated Legendre Polynomials**

These are defined by

**18.30.6** 
$$P_n(x; c) = P_n^{(0,0)}(x; c), \quad n = 0, 1, \dots$$

Explicitly,

**18.30.7** 
$$P_n(x; c) = \sum_{\ell=0}^n \frac{c}{\ell + c} P_\ell(x) P_{n-\ell}(x).$$

(These polynomials are not to be confused with associated Legendre functions §14.3(ii).)

For further results on associated Legendre polynomials see Chihara (1978, Chapter VI, §12); on associated Jacobi polynomials, see Wimp (1987) and Ismail and Masson (1991). For associated Pollaczek polynomials (compare §18.35) see Erdélyi *et al.* (1953b, §10.21). For associated Askey–Wilson polynomials see Rahman (2001).

**18.31 Bernstein–Szegő Polynomials**

Let  $\rho(x)$  be a polynomial of degree  $\ell$  and positive when  $-1 \leq x \leq 1$ . The *Bernstein–Szegő polynomials*  $\{p_n(x)\}$ ,  $n = 0, 1, \dots$ , are orthogonal on  $(-1, 1)$  with respect to three types of weight function:  $(1 - x^2)^{-\frac{1}{2}}(\rho(x))^{-1}$ ,  $(1 - x^2)^{\frac{1}{2}}(\rho(x))^{-1}$ ,  $(1 - x)^{\frac{1}{2}}(1 + x)^{-\frac{1}{2}}(\rho(x))^{-1}$ . In consequence,  $p_n(\cos \theta)$  can be given explicitly in terms of  $\rho(\cos \theta)$  and sines and cosines, provided that  $\ell < 2n$  in the first case,  $\ell < 2n + 2$  in the second case, and  $\ell < 2n + 1$  in the third case. See Szegő (1975, §2.6).

### 18.32 OP's with Respect to Freud Weights

A *Freud weight* is a weight function of the form

$$18.32.1 \quad w(x) = \exp(-Q(x)), \quad -\infty < x < \infty,$$

where  $Q(x)$  is real, even, nonnegative, and continuously differentiable. Of special interest are the cases  $Q(x) = x^{2m}$ ,  $m = 1, 2, \dots$ . No explicit expressions for the corresponding OP's are available. However, for asymptotic approximations in terms of elementary functions for the OP's, and also for their largest zeros, see Levin and Lubinsky (2001) and Nevai (1986). For a uniform asymptotic expansion in terms of Airy functions (§9.2) for the OP's in the case  $Q(x) = x^4$  see Bo and Wong (1999).

### 18.33 Polynomials Orthogonal on the Unit Circle

#### 18.33(i) Definition

A system of polynomials  $\{\phi_n(z)\}$ ,  $n = 0, 1, \dots$ , where  $\phi_n(z)$  is of proper degree  $n$ , is *orthonormal on the unit circle with respect to the weight function*  $w(z) (\geq 0)$  if

$$18.33.1 \quad \frac{1}{2\pi i} \int_{|z|=1} \phi_n(z) \overline{\phi_m(z)} w(z) \frac{dz}{z} = \delta_{n,m},$$

where the bar signifies complex conjugate. See Simon (2005a,b) for general theory.

#### 18.33(ii) Recurrence Relations

Denote

$$18.33.2 \quad \phi_n(z) = \kappa_n z^n + \sum_{\ell=1}^n \kappa_{n,n-\ell} z^{n-\ell},$$

where  $\kappa_n (> 0)$ , and  $\kappa_{n,n-\ell} (\in \mathbb{C})$  are constants. Also denote

$$18.33.3 \quad \phi_n^*(z) = \kappa_n z^n + \sum_{\ell=1}^n \bar{\kappa}_{n,n-\ell} z^{n-\ell},$$

where the bar again signifies complex conjugate. Then

$$18.33.4 \quad \kappa_n z \phi_n(z) = \kappa_{n+1} \phi_{n+1}(z) - \phi_{n+1}(0) \phi_{n+1}^*(z),$$

$$18.33.5 \quad \kappa_n \phi_{n+1}(z) = \kappa_{n+1} z \phi_n(z) + \phi_{n+1}(0) \phi_n^*(z),$$

$$18.33.6 \quad \begin{aligned} \kappa_n \phi_n(0) \phi_{n+1}(z) + \kappa_{n-1} \phi_{n+1}(0) z \phi_{n-1}(z) \\ = (\kappa_n \phi_{n+1}(0) + \kappa_{n+1} \phi_n(0) z) \phi_n(z). \end{aligned}$$

#### 18.33(iii) Connection with OP's on the Line

Assume that  $w(e^{i\phi}) = w(e^{-i\phi})$ . Set

$$18.33.7 \quad \begin{aligned} w_1(x) &= (1-x^2)^{-\frac{1}{2}} w\left(x + i(1-x^2)^{\frac{1}{2}}\right), \\ w_2(x) &= (1-x^2)^{\frac{1}{2}} w\left(x + i(1-x^2)^{\frac{1}{2}}\right). \end{aligned}$$

Let  $\{p_n(x)\}$  and  $\{q_n(x)\}$ ,  $n = 0, 1, \dots$ , be OP's with weight functions  $w_1(x)$  and  $w_2(x)$ , respectively, on  $(-1, 1)$ . Then

$$18.33.8 \quad \begin{aligned} p_n\left(\frac{1}{2}(z+z^{-1})\right) \\ = (\text{const.}) \times (z^{-n} \phi_{2n}(z) + z^n \phi_{2n}(z^{-1})) \\ = (\text{const.}) \times (z^{-n+1} \phi_{2n-1}(z) + z^{n-1} \phi_{2n-1}(z^{-1})), \end{aligned}$$

$$18.33.9 \quad \begin{aligned} q_n\left(\frac{1}{2}(z+z^{-1})\right) \\ = (\text{const.}) \times \frac{z^{-n-1} \phi_{2n+2}(z) - z^{n+1} \phi_{2n+2}(z^{-1})}{z - z^{-1}} \\ = (\text{const.}) \times \frac{z^{-n} \phi_{2n+1}(z) - z^n \phi_{2n+1}(z^{-1})}{z - z^{-1}}. \end{aligned}$$

Conversely,

$$18.33.10 \quad \begin{aligned} z^{-n} \phi_{2n}(z) \\ = A_n p_n\left(\frac{1}{2}(z+z^{-1})\right) + B_n (z-z^{-1}) q_{n-1}\left(\frac{1}{2}(z+z^{-1})\right), \end{aligned}$$

$$18.33.11 \quad \begin{aligned} z^{-n+1} \phi_{2n-1}(z) \\ = C_n p_n\left(\frac{1}{2}(z+z^{-1})\right) + D_n (z-z^{-1}) q_{n-1}\left(\frac{1}{2}(z+z^{-1})\right), \end{aligned}$$

where  $A_n, B_n, C_n$ , and  $D_n$  are independent of  $z$ .

#### 18.33(iv) Special Cases

**Trivial**

$$18.33.12 \quad \phi_n(z) = z^n, \quad w(z) = 1.$$

**Szegő-Askey**

$$18.33.13 \quad \begin{aligned} \phi_n(z) \\ = \sum_{\ell=0}^n \frac{(\lambda+1)_\ell (\lambda)_\ell}{\ell! (n-\ell)!} z^\ell = \frac{(\lambda)_n}{n!} {}_2F_1\left(\begin{matrix} -n, \lambda+1 \\ -\lambda-n+1 \end{matrix}; z\right), \end{aligned}$$

with

$$\begin{aligned} w(z) &= \left(1 - \frac{1}{2}(z+z^{-1})\right)^\lambda, \\ 18.33.14 \quad w_1(x) &= (1-x)^{\lambda-\frac{1}{2}} (1+x)^{-\frac{1}{2}}, \\ w_2(x) &= (1-x)^{\lambda+\frac{1}{2}} (1+x)^{\frac{1}{2}}, \quad \lambda > -\frac{1}{2}. \end{aligned}$$

For the hypergeometric function  ${}_2F_1$  see §§15.1 and 15.2(i).

**Askey**

$$18.33.15 \quad \begin{aligned} \phi_n(z) &= \sum_{\ell=0}^n \frac{(aq^2; q^2)_\ell (a; q^2)_{n-\ell}}{(q^2; q^2)_\ell (q^2; q^2)_{n-\ell}} (q^{-1}z)^\ell \\ &= \frac{(a; q^2)_n}{(q^2; q^2)_n} {}_2\phi_1\left(\begin{matrix} aq^2, q^{-2n} \\ a^{-1}q^{2-2n} \end{matrix}; q^2, \frac{qz}{a}\right), \end{aligned}$$

with

$$18.33.16 \quad w(z) = \left| (qz; q^2)_\infty / (aqz; q^2)_\infty \right|^2, \quad a^2 q^2 < 1.$$

For the notation, including the basic hypergeometric function  ${}_2\phi_1$ , see §§17.2 and 17.4(i).

When  $a = 0$  the Askey case is also known as the *Rogers-Szegő case*.

### 18.33(v) Biorthogonal Polynomials on the Unit Circle

See Baxter (1961) for general theory. See Askey (1982) and Pastro (1985) for special cases extending (18.33.13)–(18.33.14) and (18.33.15)–(18.33.16), respectively. See Gasper (1981) and Hendriksen and van Rossum (1986) for relations with Laurent polynomials orthogonal on the unit circle. See Al-Salam and Ismail (1994) for special biorthogonal rational functions on the unit circle.

## 18.34 Bessel Polynomials

### 18.34(i) Definitions and Recurrence Relation

For the confluent hypergeometric function  ${}_1F_1$  and the generalized hypergeometric function  ${}_2F_0$  see §16.2(ii) and §16.2(iv).

#### 18.34.1

$$y_n(x; a) = {}_2F_0\left(\begin{matrix} -n, n+a-1 \\ - \end{matrix}; -\frac{x}{2}\right) \\ = (n+a-1)_n \left(\frac{x}{2}\right)^n {}_1F_1\left(\begin{matrix} -n \\ -2n-a+2 \end{matrix}; \frac{2}{x}\right).$$

Other notations in use are given by

$$18.34.2 \quad y_n(x) = y_n(x; 2), \quad \theta_n(x) = x^n y_n(x^{-1}),$$

and

#### 18.34.3

$$y_n(x; a, b) = y_n(2x/b; a), \quad \theta_n(x; a, b) = x^n y_n(x^{-1}; a, b).$$

Often only the polynomials (18.34.2) are called *Bessel polynomials*, while the polynomials (18.34.1) and (18.34.3) are called *generalized Bessel polynomials*. See also §10.49(ii).

#### 18.34.4

$$y_{n+1}(x; a) = (A_n x + B_n) y_n(x; a) - C_n y_{n-1}(x; a),$$

where

$$A_n = \frac{(2n+a)(2n+a-1)}{2(n+a-1)},$$

$$18.34.5 \quad B_n = \frac{(a-2)(2n+a-1)}{(n+a-1)(2n+a-2)},$$

$$C_n = \frac{-n(2n+a)}{(n+a-1)(2n+a-2)}.$$

### 18.34(ii) Orthogonality

Because the coefficients  $C_n$  in (18.34.4) are not all positive, the polynomials  $y_n(x; a)$  cannot be orthogonal on the line with respect to a positive weight function. There is orthogonality on the unit circle, however:

#### 18.34.6

$$\frac{1}{2\pi i} \int_{|z|=1} z^{a-2} y_n(z; a) y_m(z; a) e^{-2/z} dz \\ = \frac{(-1)^{n+a-1} n! 2^{a-1}}{(n+a-2)!(2n+a-1)} \delta_{n,m}, \quad a = 1, 2, \dots,$$

the integration path being taken in the positive rotational sense.

Orthogonality can also be expressed in terms of *moment functionals*; see Durán (1993), Evans *et al.* (1993), and Maroni (1995).

### 18.34(iii) Other Properties

#### 18.34.7

$$x^2 y_n''(x; a) + (ax+2) y_n'(x; a) - n(n+a-1) y_n(x; a) = 0,$$

where primes denote derivatives with respect to  $x$ .

$$18.34.8 \quad \lim_{\alpha \rightarrow \infty} \frac{P_n^{(\alpha, a-\alpha-2)}(1+\alpha x)}{P_n^{(\alpha, a-\alpha-2)}(1)} = y_n(x; a).$$

For uniform asymptotic expansions of  $y_n(x; a)$  as  $n \rightarrow \infty$  in terms of Airy functions (§9.2) see Wong and Zhang (1997) and Dunster (2001c). For uniform asymptotic expansions in terms of Hermite polynomials see López and Temme (1999b).

For further information on Bessel polynomials see §10.49(ii).

## 18.35 Pollaczek Polynomials

### 18.35(i) Definition and Hypergeometric Representation

$$18.35.1 \quad P_{-1}^{(\lambda)}(x; a, b) = 0, \quad P_0^{(\lambda)}(x; a, b) = 1,$$

and

#### 18.35.2

$$(n+1) P_{n+1}^{(\lambda)}(x; a, b) = 2((n+\lambda+a)x+b) P_n^{(\lambda)}(x; a, b) \\ - (n+2\lambda-1) P_{n-1}^{(\lambda)}(x; a, b), \\ n = 0, 1, \dots$$

Next, let

$$18.35.3 \quad \tau_{a,b}(\theta) = \frac{a \cos \theta + b}{\sin \theta}, \quad 0 < \theta < \pi.$$

Then

#### 18.35.4

$$P_n^{(\lambda)}(\cos \theta; a, b) \\ = \frac{(\lambda - i\tau_{a,b}(\theta))_n}{n!} e^{in\theta} \\ \times {}_2F_1\left(\begin{matrix} -n, \lambda + i\tau_{a,b}(\theta) \\ -n - \lambda + 1 + i\tau_{a,b}(\theta) \end{matrix}; e^{-2i\theta}\right) \\ = \sum_{\ell=0}^n \frac{(\lambda + i\tau_{a,b}(\theta))_\ell}{\ell!} \frac{(\lambda - i\tau_{a,b}(\theta))_{n-\ell}}{(n-\ell)!} e^{i(n-2\ell)\theta}.$$

For the hypergeometric function  ${}_2F_1$  see §§15.1, 15.2(i).

**18.35(ii) Orthogonality**

18.35.5

$$\int_{-1}^1 P_n^{(\lambda)}(x; a, b) P_m^{(\lambda)}(x; a, b) w^{(\lambda)}(x; a, b) dx = 0, \\ n \neq m,$$

where

18.35.6

$$w^{(\lambda)}(\cos \theta; a, b) = \pi^{-1} 2^{2\lambda-1} e^{(2\theta-\pi)\tau_{a,b}(\theta)} \\ \times (\sin \theta)^{2\lambda-1} |\Gamma(\lambda + i\tau_{a,b}(\theta))|^2, \\ a \geq b \geq -a, \lambda > -\frac{1}{2}, 0 < \theta < \pi.$$

**18.35(iii) Other Properties**

$$(1 - ze^{i\theta})^{-\lambda+i\tau_{a,b}(\theta)} (1 - ze^{-i\theta})^{-\lambda-i\tau_{a,b}(\theta)}$$

18.35.7

$$= \sum_{n=0}^{\infty} P_n^{(\lambda)}(\cos \theta; a, b) z^n, \quad |z| < 1, 0 < \theta < \pi.$$

18.35.8

$$P_n^{(\lambda)}(x; 0, 0) = C_n^{(\lambda)}(x),$$

18.35.9

$$P_n^{(\lambda)}(\cos \phi; 0, x \sin \phi) = P_n^{(\lambda)}(x; \phi).$$

For the polynomials  $C_n^{(\lambda)}(x)$  and  $P_n^{(\lambda)}(x; \phi)$  see §§18.3 and 18.19, respectively.

See Bo and Wong (1996) for an asymptotic expansion of  $P_n^{(\frac{1}{2})}(\cos(n^{-\frac{1}{2}}\theta); a, b)$  as  $n \rightarrow \infty$ , with  $a$  and  $b$  fixed. This expansion is in terms of the Airy function  $\text{Ai}(x)$  and its derivative (§9.2), and is uniform in any compact  $\theta$ -interval in  $(0, \infty)$ . Also included is an asymptotic approximation for the zeros of  $P_n^{(\frac{1}{2})}(\cos(n^{-\frac{1}{2}}\theta); a, b)$ .

**18.36 Miscellaneous Polynomials**

**18.36(i) Jacobi-Type Polynomials**

These are OP's on the interval  $(-1, 1)$  with respect to an orthogonality measure obtained by adding constant multiples of "Dirac delta weights" at  $-1$  and  $1$  to the weight function for the Jacobi polynomials. For further information see Koornwinder (1984a) and Kwon *et al.* (2006).

Similar OP's can also be constructed for the Laguerre polynomials; see Koornwinder (1984b, (4.8)).

**18.36(ii) Sobolev OP's**

Sobolev OP's are orthogonal with respect to an inner product involving derivatives. For an introductory survey to this subject, see Marcellán *et al.* (1993). Other relevant references include Iserles *et al.* (1991) and Koekoek *et al.* (1998).

**18.36(iii) Multiple OP's**

These are polynomials in one variable that are orthogonal with respect to a number of different measures. They are related to Hermite-Padé approximation and can be used for proofs of irrationality or transcendence of interesting numbers. For further information see Ismail (2005, Chapter 23).

**18.36(iv) Orthogonal Matrix Polynomials**

These are matrix-valued polynomials that are orthogonal with respect to a square matrix of measures on the real line. Classes of such polynomials have been found that generalize the classical OP's in the sense that they satisfy second-order matrix differential equations with coefficients independent of the degree. For further information see Durán and Grünbaum (2005).

**18.37 Classical OP's in Two or More Variables**

**18.37(i) Disk Polynomials**

Definition in Terms of Jacobi Polynomials

18.37.1

$$R_{m,n}^{(\alpha)}(re^{i\theta}) = e^{i(m-n)\theta} r^{|m-n|} \frac{P_{\min(m,n)}^{(\alpha, |m-n|)}(2r^2 - 1)}{P_{\min(m,n)}^{(\alpha, |m-n|)}(1)}, \\ r \geq 0, \theta \in \mathbb{R}, \alpha > -1.$$

Orthogonality

18.37.2

$$\iint_{x^2+y^2 < 1} R_{m,n}^{(\alpha)}(x+iy) R_{j,\ell}^{(\alpha)}(x-iy) (1-x^2-y^2)^\alpha dx dy \\ = 0, \quad m \neq j \text{ and/or } n \neq \ell.$$

Equivalent Definition

The following three conditions, taken together, determine  $R_{m,n}^{(\alpha)}(z)$  uniquely:

$$18.37.3 \quad R_{m,n}^{(\alpha)}(z) = \sum_{j=0}^{\min(m,n)} c_j z^{m-j} \bar{z}^{n-j},$$

where  $c_j$  are real or complex constants, with  $c_0 \neq 0$ ;

$$18.37.4 \quad \iint_{x^2+y^2 < 1} R_{m,n}^{(\alpha)}(x+iy)(x-iy)^{m-j}(x+iy)^{n-j} \\ \times (1-x^2-y^2)^\alpha dx dy = 0, \\ j = 1, 2, \dots, \min(m, n);$$

$$18.37.5 \quad R_{m,n}^{(\alpha)}(1) = 1.$$

**Explicit Representation****18.37.6**

$$R_{m,n}^{(\alpha)}(z) = \sum_{j=0}^{\min(m,n)} \frac{(-1)^j (\alpha+1)_{m+n-j} (-m)_j (-n)_j}{(\alpha+1)_m (\alpha+1)_n j!} \times z^{m-j} \bar{z}^{n-j}.$$

**18.37(ii) OP's on the Triangle****Definition in Terms of Jacobi Polynomials**

$$18.37.7 \quad P_{m,n}^{\alpha,\beta,\gamma}(x,y) = P_{m-n}^{\alpha,\beta+\gamma+2n+1}(2x-1) \times x^n P_n^{\beta,\gamma}(2x^{-1}y-1), \\ m \geq n \geq 0, \alpha, \beta, \gamma > -1.$$

**Orthogonality**

$$18.37.8 \quad \int\int_{0 < y < x < 1} P_{m,n}^{\alpha,\beta,\gamma}(x,y) P_{j,\ell}^{\alpha,\beta,\gamma}(x,y) \times (1-x)^\alpha (x-y)^\beta y^\gamma dx dy = 0, \\ m \neq j \text{ and/or } n \neq \ell.$$

See Dunkl and Xu (2001, §2.3.3) for analogs of (18.37.1) and (18.37.7) on a  $d$ -dimensional simplex.

**18.37(iii) OP's Associated with Root Systems**

Orthogonal polynomials associated with root systems are certain systems of trigonometric polynomials in several variables, symmetric under a certain finite group (Weyl group), and orthogonal on a torus. In one variable they are essentially ultraspherical, Jacobi, continuous  $q$ -ultraspherical, or Askey–Wilson polynomials. In several variables they occur, for  $q = 1$ , as *Jack polynomials* and also as *Jacobi polynomials associated with root systems*; see Macdonald (1995, Chapter VI, §10), Stanley (1989), Kuznetsov and Sahi (2006, Part 1), Heckman (1991). For general  $q$  they occur as *Macdonald polynomials for root system  $A_n$* , as *Macdonald polynomials for general root systems*, and as *Macdonald-Koornwinder polynomials*; see Macdonald (1995, Chapter VI), Macdonald (2000, 2003), Koornwinder (1992).

**Applications****18.38 Mathematical Applications****18.38(i) Classical OP's: Numerical Analysis****Approximation Theory**

The scaled Chebyshev polynomial  $2^{1-n} T_n(x)$ ,  $n \geq 1$ , enjoys the “minimax” property on the interval  $[-1, 1]$ , that is,  $|2^{1-n} T_n(x)|$  has the least maximum value

among all monic polynomials of degree  $n$ . In consequence, expansions of functions that are infinitely differentiable on  $[-1, 1]$  in series of Chebyshev polynomials usually converge extremely rapidly. For these results and applications in approximation theory see §3.11(ii) and Mason and Handscomb (2003, Chapter 3), Cheney (1982, p. 108), and Rivlin (1969, p. 31).

**Quadrature**

Classical OP's play a fundamental role in Gaussian quadrature. If the nodes in a quadrature formula with a positive weight function are chosen to be the zeros of the  $n$ th degree OP with the same weight function, and the interval of orthogonality is the same as the integration range, then the weights in the quadrature formula can be chosen in such a way that the formula is exact for all polynomials of degree not exceeding  $2n - 1$ . See §3.5(v).

**Differential Equations**

Linear ordinary differential equations can be solved directly in series of Chebyshev polynomials (or other OP's) by a method originated by Clenshaw (1957). This process has been generalized to spectral methods for solving partial differential equations. For further information see Mason and Handscomb (2003, Chapters 10 and 11), Gottlieb and Orszag (1977, pp. 7–19), and Guo (1998, pp. 120–151).

**18.38(ii) Classical OP's: Other Applications****Integrable Systems**

The Toda equation provides an important model of a completely integrable system. It has elegant structures, including  $N$ -soliton solutions, Lax pairs, and Bäcklund transformations. While the Toda equation is an important model of nonlinear systems, the special functions of mathematical physics are usually regarded as solutions to linear equations. However, by using Hirota's technique of bilinear formalism of soliton theory, Nakamura (1996) shows that a wide class of exact solutions of the Toda equation can be expressed in terms of various special functions, and in particular classical OP's. For instance,

$$18.38.1 \quad V_n(x) = 2n H_{n+1}(x) H_{n-1}(x) / (H_n(x))^2, \\ \text{with } H_n(x) \text{ as in §18.3, satisfies the Toda equation}$$

$$18.38.2 \quad (d^2/dx^2) \ln V_n(x) = V_{n+1}(x) + V_{n-1}(x) - 2V_n(x), \quad n = 1, 2, \dots$$

**Complex Function Theory**

The Askey–Gasper inequality

**18.38.3**

$$\sum_{m=0}^n P_m^{(\alpha,0)}(x) \geq 0, \quad -1 \leq x \leq 1, \alpha > -1, n = 0, 1, \dots,$$

was used in de Branges' proof of the long-standing Bieberbach conjecture concerning univalent functions on the unit disk in the complex plane. See de Branges (1985).

### Zonal Spherical Harmonics

Ultraspherical polynomials are zonal spherical harmonics. As such they have many applications. See, for example, Andrews *et al.* (1999, Chapter 9). See also §14.30.

### Random Matrix Theory

Hermite polynomials (and their Freud-weight analogs (§18.32)) play an important role in random matrix theory. See Fyodorov (2005) and Deift (1998, Chapter 5).

### Riemann–Hilbert Problems

See Deift (1998, Chapter 7) and Ismail (2005, Chapter 22).

### Radon Transform

See Deans (1983, Chapters 4, 7).

## 18.38(iii) Other OP's

### Group Representations

For group-theoretic interpretations of OP's see Vilenkin and Klimyk (1991, 1992, 1993).

### Coding Theory

For applications of Krawtchouk polynomials  $K_n(x; p, N)$  and  $q$ -Racah polynomials  $R_n(x; \alpha, \beta, \gamma, \delta | q)$  to coding theory see Bannai (1990, pp. 38–43), Leonard (1982), and Chihara (1987).

## 18.39 Physical Applications

### 18.39(i) Quantum Mechanics

Classical OP's appear when the time-dependent Schrödinger equation is solved by separation of variables. Consider, for example, the one-dimensional form of this equation for a particle of mass  $m$  with potential energy  $V(x)$ :

$$18.39.1 \quad \left( \frac{-\hbar^2}{2m} \frac{\partial^2}{\partial x^2} + V(x) \right) \psi(x, t) = i\hbar \frac{\partial}{\partial t} \psi(x, t),$$

where  $\hbar$  is the reduced Planck's constant. On substituting  $\psi(x, t) = \eta(x)\zeta(t)$ , we obtain two ordinary differential equations, each of which involve the same constant  $E$ . The equation for  $\eta(x)$  is

$$18.39.2 \quad \frac{d^2\eta}{dx^2} + \frac{2m}{\hbar^2} (E - V(x)) \eta = 0.$$

For a harmonic oscillator, the potential energy is given by

$$18.39.3 \quad V(x) = \frac{1}{2}m\omega^2 x^2,$$

where  $\omega$  is the angular frequency. For (18.39.2) to have a nontrivial bounded solution in the interval  $-\infty < x < \infty$ , the constant  $E$  (the total energy of the particle) must satisfy

$$18.39.4 \quad E = E_n = \left(n + \frac{1}{2}\right) \hbar\omega, \quad n = 0, 1, 2, \dots$$

The corresponding eigenfunctions are

$$18.39.5 \quad \eta_n(x) = \pi^{-\frac{1}{4}} 2^{-\frac{1}{2}n} (n! b)^{-\frac{1}{2}} H_n(x/b) e^{-x^2/2b^2},$$

where  $b = (\hbar/m\omega)^{1/2}$ , and  $H_n$  is the Hermite polynomial. For further details, see Seaborn (1991, p. 224) or Nikiforov and Uvarov (1988, pp. 71–72).

A second example is provided by the three-dimensional time-independent Schrödinger equation

$$18.39.6 \quad \nabla^2 \psi + \frac{2m}{\hbar^2} (E - V(\mathbf{x})) \psi = 0,$$

when this is solved by separation of variables in spherical coordinates (§1.5(ii)). The eigenfunctions of one of the separated ordinary differential equations are Legendre polynomials. See Seaborn (1991, pp. 69–75).

For a third example, one in which the eigenfunctions are Laguerre polynomials, see Seaborn (1991, pp. 87–93) and Nikiforov and Uvarov (1988, pp. 76–80 and 320–323).

### 18.39(ii) Other Applications

For applications of Legendre polynomials in fluid dynamics to study the flow around the outside of a puff of hot gas rising through the air, see Paterson (1983).

For applications and an extension of the Szegő–Szász inequality (18.14.20) for Legendre polynomials ( $\alpha = \beta = 0$ ) to obtain global bounds on the variation of the phase of an elastic scattering amplitude, see Cornille and Martin (1972, 1974).

For physical applications of  $q$ -Laguerre polynomials see §17.17.

For interpretations of zeros of classical OP's as equilibrium positions of charges in electrostatic problems (assuming logarithmic interaction), see Ismail (2000a,b).

## Computation

### 18.40 Methods of Computation

Orthogonal polynomials can be computed from their explicit polynomial form by Horner's scheme (§1.11(i)). Usually, however, other methods are more efficient, especially the numerical solution of difference equations (§3.6) and the application of uniform asymptotic expansions (when available) for OP's of large degree.



However, for applications in which the OP's appear only as terms in series expansions (compare §18.18(i)) the need to compute them can be avoided altogether by use instead of Clenshaw's algorithm (§3.11(ii)) and its straightforward generalization to OP's other than Chebyshev. For further information see Clenshaw (1955), Gautschi (2004, §§2.1, 8.1), and Mason and Handscomb (2003, §2.4).

## 18.41 Tables

### 18.41(i) Polynomials

For  $P_n(x)$  ( $= P_n(x)$ ) see §14.33.

Abramowitz and Stegun (1964, Tables 22.4, 22.6, 22.11, and 22.13) tabulates  $T_n(x)$ ,  $U_n(x)$ ,  $L_n(x)$ , and  $H_n(x)$  for  $n = 0(1)12$ . The ranges of  $x$  are 0.2(.2)1 for  $T_n(x)$  and  $U_n(x)$ , and 0.5, 1, 3, 5, 10 for  $L_n(x)$  and  $H_n(x)$ . The precision is 10D, except for  $H_n(x)$  which is 6-11S.

### 18.41(ii) Zeros

For  $P_n(x)$ ,  $L_n(x)$ , and  $H_n(x)$  see §3.5(v). See also Abramowitz and Stegun (1964, Tables 25.4, 25.9, and 25.10).

### 18.41(iii) Other Tables

For tables prior to 1961 see Fletcher *et al.* (1962) and Lebedev and Fedorova (1960).

## 18.42 Software

See <http://dlmf.nist.gov/18.42>.

## References

### General References

The main references for writing this chapter are Andrews *et al.* (1999), Askey and Wilson (1985), Chihara (1978), Koekoek and Swarttouw (1998), and Szegő (1975).

### Sources

The following list gives the references or other indications of proofs that were used in constructing the various sections of this chapter. These sources supplement the references that are quoted in the text.

§18.2 Andrews *et al.* (1999, Chapter 5), Szegő (1975, §§2.2(i), 3.2), Chihara (1978, Chapter 1, Theorem 3.3 and p. 21).

§18.3 In Table 18.3.1, for Row 2 see Szegő (1975, §2.4, Item 1, (4.3.3), and (4.21.6)): the entry in the last column follows from (18.5.7); for Row 3 see Szegő (1975, (4.7.1), (4.7.14), and (4.7.9)): the entry in the last column follows from the symmetry in the fourth row of Table 18.6.1; for Rows 4–7 see Andrews *et al.* (1999, §5.1 and Remark 2.5.3); for Row 10 specialize Row 2 to  $\alpha = \beta = 0$ ; for Row 12 see Szegő (1975, §2.4, Item 2, (5.1.1), and (5.1.8)): the entry in the last column follows from (18.5.12); for Row 13 see Szegő (1975, §2.4, Item 3, (5.5.1), and (5.5.6)): the entry in the last column follows from the symmetry in the tenth row of Table 18.6.1.

§18.4 These graphics were produced at NIST.

§18.5 To verify (18.5.1)–(18.5.4) substitute them in the fourth through seventh rows, respectively, of Table 18.3.1. Alternatively, combine Szegő (1975, (4.1.7), (4.1.8)) with (18.7.5), (18.7.6). In Table 18.5.1, for Rows 2, 3, 9, 10 see Szegő (1975, (4.3.1), (4.7.12), (5.1.5), (5.5.3)); Rows 4–7 follow from Row 2 combined with (18.5.1)–(18.5.4) and Table 18.6.1, second row; Row 8 is the case  $\alpha = \beta = 0$  of Row 2. For (18.5.6) see Truesdell (1948, §18, (5)). For (18.5.7) see Szegő (1975, (4.21.2)). For (18.5.8) see Szegő (1975, (4.3.2)). For (18.5.9) see Szegő (1975, (4.7.6)). For (18.5.10) see Szegő (1975, (4.7.31)). For (18.5.11) see Andrews *et al.* (1999, (6.4.11)). For (18.5.12) see Szegő (1975, (5.3.3)). For (18.5.13) see Szegő (1975, (5.5.4)). For (18.5.14)–(18.5.19) apply the recurrence relations (§18.9(i)), with initial values obtained from the values of  $k_n$  and  $\tilde{k}_n/k_n$  given in Table 18.3.1 with  $n = 0, 1$ .

§18.6 For (18.6.1) see Szegő (1975, (5.1.7)). For Table 18.6.1, Rows 2, 4, 10, see Szegő (1975, (4.1.3), (4.1.1), (4.7.4), (2.3.3), (4.7.3), (5.5.5)); the entries in the fourth and fifth columns of Rows 3 and 4 of Table 18.6.1 follow from (18.5.9) combined (for Row 3) with (18.7.2); the other entries of Row 3 of Table 18.6.1 are the case  $\alpha = \beta$  of Row 2; Rows 5–8 follow from (18.5.1)–(18.5.4); Row 9 is the case  $\alpha = 0$  of Row 3. (18.6.2) follows from (18.6.3) by the second row of Table 18.6.1. (18.6.3) follows from (18.5.7) together with the second row of Table 18.6.1. (18.6.4) follows from (18.5.10) together with the fourth row of Table 18.6.1. (18.6.5) follows from (18.5.12) together with (18.6.1).

- §18.7 For (18.7.1)–(18.7.6) and (18.7.13), (18.7.14) see Szegő (1975, (4.1.5), (4.1.7), (4.1.8), (4.7.1)). (18.7.7)–(18.7.12) follow from the definitions given by Table 18.3.1. (18.7.15) and (18.7.16) follow from (18.7.13) and (18.7.14), combined with (18.7.1). (18.7.17) follows from (18.7.4), (18.7.5), and (18.7.13). (18.7.18) follows from (18.7.3), (18.7.6), and (18.7.14). For (18.7.19) and (18.7.20) see Szegő (1975, (5.6.1)). For (18.7.21) see Szegő (1975, (5.3.4)). (18.7.22) follows from (18.7.21) and the symmetry in Row 2 of Table 18.6.1. (18.7.23) follows from (18.7.24) and (18.7.1). For (18.7.24) see Szegő (1975, (5.6.3)). For (18.7.25) see Szegő (1975, (4.7.8)). For (18.7.26) see Calogero (1978).
- §18.8 For Table 18.8.1, Rows 2, 3, 5, 9–10, 11–12, see Szegő (1975, (4.2.4), (4.24.2), (4.7.5), (5.1.2), (5.5.2)), respectively; Row 4 is the special case  $\alpha = \beta$  of Row 2; Rows 6, 7, 8 are the special cases  $\alpha = \beta = -\frac{1}{2}$ ,  $\alpha = \beta = \frac{1}{2}$ ,  $\alpha = \beta = 0$ , respectively, of Row 2.
- §18.9 For (18.9.1), (18.9.2) see Szegő (1975, (4.5.1)). For Table 18.9.1, Rows 2, 9, 10, see Szegő (1975, (4.7.17), (5.1.10), (5.5.8)), respectively; Rows 3 and 4 are rewritings of elementary trigonometric identities in view of (18.5.1), (18.5.2); Row 7 is the special case  $\alpha = \beta = 0$  of (18.9.2). For (18.9.3)–(18.9.5) see Rainville (1960, §138, (17), (16), (14)). For (18.9.6) see Szegő (1975, (4.5.4)). For (18.9.7) see Szegő (1975, (4.7.29)). For (18.9.8) substitute (18.7.15) or (18.7.16); the resulting formula is a special case of Rainville (1960, §138, (11)). (18.9.9)–(18.9.12) are rewritings of elementary trigonometric identities in view of (18.5.1)–(18.5.4). For (18.9.13), (18.9.14) see Szegő (1975, (5.1.13), (5.1.14)). For (18.9.15) see Szegő (1975, (4.21.7)). (18.9.16) is an immediate corollary of (18.5.5) and Table 18.5.1, Row 2. For (18.9.17) and (18.9.18) see Koornwinder (2006, §4). For (18.9.19) see Szegő (1975, (4.7.14)). (18.9.20) is an immediate corollary of (18.5.5) and Table 18.5.1, Row 3. (18.9.21) and (18.9.22) are rewritings of elementary trigonometric differentiation formulas. For (18.9.23) see Szegő (1975, (5.1.14)). (18.9.24) is an immediate corollary of (18.5.5) and Table 18.5.1, Row 9. For (18.9.25) see Szegő (1975, (5.5.10)). (18.9.26) is an immediate corollary of (18.5.5) and Table 18.5.1, Row 10.
- §18.10 For (18.10.1) combine (14.12.1) and (14.3.21). For (18.10.2) see Szegő (1975, (4.8.6)). For (18.10.3) see Askey (1975, (4.20)). For (18.10.4) see Andrews *et al.* (1999, Theorem 6.7.4). For (18.10.5) see Szegő (1975, (4.8.10)). (18.10.6) can be obtained as a limit case of (18.10.3) in view of (18.7.21). (18.10.7) can be obtained as a limit case of (18.10.4) in view of (18.7.23). Table 18.10.1 follows from the corresponding Rodrigues formulas (§18.5(ii)) or generating functions (§18.12); see Szegő (1975, (4.4.6), (4.82.1), (4.8.16), (4.8.1), (5.4.8)). For (18.10.9), (18.10.10) see Andrews *et al.* (1999, (6.2.15), (6.1.4)).
- §18.11 For (18.11.1) see Andrews *et al.* (1999, (9.6.7)). (18.11.2) is a rewriting of (18.5.12). For (18.11.3) see Temme (1990a, (3.1)). For (18.11.5) see Szegő (1975, Theorem 8.1.1). For (18.11.6) see Szegő (1975, Theorem 8.22.4). For (18.11.7) and (18.11.8) see Szegő (1975, Theorem 8.22.8).
- §18.12 For (18.12.1) see Andrews *et al.* (1999, (6.4.3)). For (18.12.2) see Bateman (1905, pp. 113–114) and Koornwinder (1974, p. 128). For (18.12.3) see Andrews *et al.* (1999, (6.4.7)). For (18.12.4) see Szegő (1975, (4.7.23)). (18.12.5) follows by combining (18.12.4) and its  $z$ -differentiated form. For (18.12.6) see Rainville (1960, §144, (7)). For (18.12.7) see Andrews *et al.* (1999, (5.1.16)). (18.12.8) is an immediate consequence of (18.12.7). For (18.12.9) see Szegő (1975, (4.7.25)). (18.12.10) is the special case  $\lambda = 1$  of (18.12.4) in view of (18.7.4). (18.12.11) is the special case  $\lambda = \frac{1}{2}$  of (18.12.4). (18.12.12) is the special case  $\lambda = \frac{1}{2}$  of (18.12.6). For (18.12.13) see Andrews *et al.* (1999, (6.2.4)). For (18.12.14) see Szegő (1975, (5.1.16)). For (18.12.15) see Andrews *et al.* (1999, (6.1.7)).
- §18.13 Lorentzen and Waadeland (1992, pp. 446–448).
- §18.14 For (18.14.1) and (18.14.2) see Szegő (1975, Theorem 7.32.1). For (18.14.3) see Chow *et al.* (1994). For (18.14.4), (18.14.5), and (18.14.6) see Szegő (1975, Theorem 7.33.1). For (18.14.7) see Lorch (1984). For (18.14.8) see Koornwinder (1977, Remark 4.1). For (18.14.9) see Szász (1951). For (18.14.10) see Szegő (1948). For (18.14.11) see Gasper (1972). For (18.14.12), (18.14.13) see Skovgaard (1954). For (18.14.14)–(18.14.19) see Szegő (1975, discussion following Theorem 7.32.1). For (18.14.20) see Szász (1950). For (18.14.21)–(18.14.24) see Szegő (1975, Theorem 7.6.1). For the last statement about the successive maxima of  $|H_n(x)|$  see Szegő (1975, Theorem 7.6.3).
- §18.15 Frenzen and Wong (1985, 1988), Szegő (1975, Theorems 8.21.11, 8.22.2, 8.22.6).

**§18.16** Szegő (1975, Theorems 6.21.1, 6.21.2, 6.21.3, 6.3.2). For (18.16.6), (18.16.7) see Gatteschi (1987). For (18.16.8) see Frenzen and Wong (1985). For (18.16.10) and (18.16.11) see Szegő (1975, Theorem 6.31.3). For (18.16.12) and (18.16.13) see Ismail and Li (1992). For (18.16.14) see Tricomi (1949). For (18.16.15) see Szegő (1975, Theorem 6.32). See also Gatteschi (2002). For (18.16.16)–(18.16.18) see Szegő (1975, Theorem 6.32) and Sun (1996).

**§18.17** For (18.17.1) see Erdélyi *et al.* (1953b, §10.8(38)). For the first equation in (18.17.2) apply the convolution property of the Laplace transform (§1.14(iii)) to (18.17.34) with  $\alpha = 0$ . For the second equation combine (18.9.23), (18.9.13), and (18.6.1). For (18.17.3) and (18.17.4) use (18.9.25) and (18.9.26). For (18.17.5) see Ismail (2005, (9.6.2)). (18.17.6) is the case  $\alpha = 0$  of (18.17.5). For (18.17.7), (18.17.8) see Durand (1975). For (18.17.9) and (18.17.10) see Andrews *et al.* (1999, Theorem 6.7.2). For (18.17.11)–(18.17.15) see Askey and Fitch (1969). For (18.17.16) use (18.5.5), integrate by parts  $n$  times, expand  $e^{-iy(1-x)}$  in a Maclaurin series, and integrate term by term. For (18.17.17) use (18.5.5), integrate repeatedly by parts, expand  $\cos(xy)$  in a Maclaurin series, and integrate term by term; the proofs of (18.17.18) and (18.17.19) are similar. For (18.17.20) expand  $\cos(xy)$  in a Maclaurin series, make the change of integration variable  $1 - 2x^2 = t$ , apply (18.5.5), integrate by parts  $n$  times, and use (10.8.3); the proof of (18.17.21) is similar. For (18.17.22) see Strichartz (1994, §7.6). For (18.17.23) use (18.12.16) and the fact that the Fourier transform of  $e^{-\frac{1}{2}x^2}$  is  $e^{-\frac{1}{2}y^2}$ ; the proofs of (18.17.24), (18.17.27), and (18.17.28) are similar, except that in the case of (18.17.24), (18.12.15) replaces (18.12.16). For (18.17.25) use (18.18.23); similarly for (18.17.26). For (18.17.29) take the inverse Fourier transform and apply (18.17.25). For (18.17.30) consider the Fourier transform of this function instead of the cosine transform, and replace  $L_n^{(n-\frac{1}{2})}(\frac{1}{2}x^2)$  by its explicit form (18.5.12); then integrate term by term and rearrange the consequential finite double sum into a single sum. For (18.17.31) use (18.5.5) and then integrate by parts; similarly for (18.17.32). For (18.17.33) expand the exponential in the integral as a power series in  $z$  and interchange integration and summation. The resulting integral can be evaluated by considering the term  $\ell = 0$  in (18.18.14). (18.17.33) may also be verified by applying Kummer's transfor-

mation (13.2.39) to (18.17.16). (18.17.34) follows by substituting (18.5.12) into the integrand and performing termwise integration. (18.17.35) follows by use of (18.5.5) and integration by parts. For (18.17.36) use (18.5.7) and apply (16.4.3). For (18.17.37) use (18.5.5) and integrate by parts  $n$  times. For (18.17.38) use the first equality in (18.5.10), with  $\lambda = \frac{1}{2}$  and  $n$  replaced by  $2n$ , integrate term by term, then apply (16.4.3); the proof of (18.17.39) is similar. For (18.17.40) use (18.5.12), integrate term by term, then apply (15.8.6). For (18.17.41) use (18.5.13) and integrate term by term. (18.17.42) and (18.17.43) follow from the case  $\alpha = \beta = \pm\frac{1}{2}$  of Szegő (1975, Theorem 4.61.2), where the hypergeometric function on the right-hand side is rewritten as in Erdélyi *et al.* (1953b, 19.8(19)). For (18.17.44) see Tuck (1964). (18.17.46) is obtained from (18.17.9) for  $\alpha = \beta = 0$ ,  $\mu = \frac{1}{2}$ , together with (18.7.5), (18.7.3), and the second row of Table 18.6.1. (18.17.45) is obtained from (18.17.46) by symmetry; compare Rows 5 and 9 of Table 18.6.1. (18.17.47) and (18.17.48) follow by use of (18.17.34) and (18.17.35). For (18.17.49) see Andrews *et al.* (1999, p. 328).

**§18.18** For (18.18.2) see Szegő (1975, Theorem 9.1.2 and the Remarks on p. 248). For (18.18.3)–(18.18.7) see Lebedev (1965, pp. 68–71 and 88–89) and Nikiforov and Uvarov (1988, pp. 21 and 59). For (18.18.8) see Carlson (1971). (18.18.9) is the case  $\alpha = 0$  of (18.18.8). (18.18.10) follows from (18.12.13). (18.18.11) follows from (18.12.15). (18.18.12) follows by computing  $\int_0^\infty L_n^{(\alpha)}(\lambda x) L_\ell^{(\alpha)}(x) e^{-x} x^\alpha dx$  with use of the Rodrigues formula (Table 18.5.1), integration by parts, and (18.5.12). (18.18.13) follows from (18.18.12) for  $\alpha = \pm\frac{1}{2}$  by (18.7.19), (18.7.20). For (18.18.14) see Andrews *et al.* (1999, Theorem 7.1.3). For (18.18.15) see Askey (1974). For (18.18.16) see Andrews *et al.* (1999, Theorem 7.1.4'). (18.18.17) follows from (18.18.16), (18.6.4), and the fourth row of Table 18.6.1. (18.18.18) follows from (18.12.13). (18.18.19) follows from (18.18.12) by dividing both sides by  $\lambda^n$  and letting  $\lambda \rightarrow \infty$ . (18.18.20) is the case  $\beta = \pm\frac{1}{2}$  of (18.18.19) in view of (18.7.19), (18.7.20). For (18.18.21)–(18.18.23) see Andrews *et al.* (1999, (5.1.6), Theorems 6.8.2 and 6.8.1 and Remarks 6.8.2 and 6.8.1). For (18.18.25), (18.18.26) see Koornwinder (1974). For (18.18.27), (18.18.28) see Andrews *et al.* (1999, (6.2.25), (6.1.13)). For the positivity of the Poisson kernels see Askey (1975, p. 16). (18.18.29) follows from (18.12.4).

- (18.18.30) follows from (18.12.4) and (18.12.5). (18.18.31) is the limiting case of (18.18.30) as  $\lambda \rightarrow 0$ . Each of the formulas (18.18.32)–(18.18.35) is equivalent to a difference formula together with a trivial  $n = 0$  case, and each difference formula can be rewritten via (18.5.1), (18.5.2) as a well-known trigonometric identity. (18.18.36) is the special case  $\lambda = \mu = \frac{1}{2}$  of (18.18.29). For (18.18.37) see Szegő (1975, (5.1.13)). (18.18.38) follows from (18.12.13), and is the special case  $r = 2$  of (18.18.10). For (18.18.39) see Szegő (1975, (5.5.11)). (18.18.40) is the special case  $\alpha = -\frac{1}{2}$  of (18.18.38) in view of (18.7.19).
- §18.19 For Table 18.19.1 see Ismail (2005, (6.2.4), (6.2.35), (6.1.4), (6.1.21)). For Table 18.19.2, Rows 2, 4, see Ismail (2005, (6.2.7), (6.1.7)); Row 3 follows from (18.20.6); Row 5 follows from (18.20.8). For (18.19.1)–(18.19.4) see Askey (1985, (4), (5)). (18.19.5) follows from (18.20.9). For (18.19.6)–(18.19.9) see Ismail (2005, (5.9.8), (5.9.9)). The formula for  $k_n$  in (18.19.9) follows from (18.20.10).
- §18.20 For (18.20.2) see Karlin and McGregor (1961, (1.8)). For Table 18.20.1, Rows 2, 3, see Ismail (2005, (6.2.42), (6.1.17)); for Row 4 see Chihara (1978, Chapter V, (3.2)). (18.20.3) follows by iteration of (18.22.28). (18.20.4) follows by iteration of (18.22.30). For (18.20.5)–(18.20.8) and (18.20.10) see Ismail (2005, (6.2.3), (6.2.34), (6.1.3), (6.1.20), (5.9.5)). For (18.20.9) see Askey (1985).
- §18.21 For (18.21.3), (18.21.5), (18.21.7), (18.21.8) see Ismail (2005, §6.2, unnumbered formula after (6.2.34), also (6.2.17), (6.1.19), (6.1.18)). For (18.21.1) see Karlin and McGregor (1961, (1.19)). The three identities in (18.21.2) follow from (18.20.6), (18.20.7), (18.20.8). (18.21.4) follows from (18.20.5) and (18.20.7). (18.21.6) follows from (18.20.6) and (18.20.8). (18.21.9) follows from (18.22.2), Row 4 in Table 18.22.1, (18.9.1), and Row 10 in Table 18.9.1. (18.21.10) follows from (18.20.9) and (18.20.10). For (18.21.11) see Koornwinder (1989, (2.6)). (18.21.12) follows from (18.20.10) and (18.5.12). For Figure 18.21.1 see Askey and Wilson (1985, p. 46), together with correction in Askey (1985).
- §18.22 For (18.22.1)–(18.22.3) see Ismail (2005, (6.2.8) and (6.2.9)). For Table 18.22.1 see Ismail (2005, (6.2.36), (6.1.5), and (6.1.25)). (18.22.4)–(18.22.6) is a limiting case of Andrews *et al.* (1999, (3.8.2)), in view of (18.26.6). For (18.22.7)–(18.22.8) see Ismail (2005, (5.9.1)). For (18.22.9)–(18.22.11) see Ismail (2005, (6.2.16)). For Table 18.22.2, Rows 2 and 3, see Ismail (2005, (6.2.38), (6.1.15)); Row 4 follows from Table 18.22.1, Row 4, and the third identity in (18.21.2). (18.22.13)–(18.22.15) is a limiting case of Koekoek and Swarttouw (1998, (1.1.6)) in view of (18.26.6). Koekoek and Swarttouw (1998, (1.1.6)) is a limiting case of Askey and Wilson (1985, (5.7)) in view of Koekoek and Swarttouw (1998, (5.1.1)). (18.22.16)–(18.22.17) follow from (18.22.14) in view of (18.21.10). For (18.22.19)–(18.22.25) see Ismail (2005, (6.2.5), (6.2.13), (6.2.39), (6.2.40), (6.1.13), §6.1, unnumbered formula following (6.1.15), also (6.1.23)). (18.22.26) follows from (18.22.24) and (18.21.7). (18.22.27) follows from (18.20.9). (18.22.28) follows from (18.22.14) and (18.22.27). (18.22.29) follows from (18.20.10). (18.22.30) follows from (18.22.28) in view of (18.21.10).
- §18.23 For (18.23.3)–(18.23.5), (18.23.7) see Ismail (2005, (6.2.43), (6.1.8), (6.1.22), (5.9.3)). (18.23.1) and (18.23.2) follow by expanding the factors on the left as power series in  $z$ , and substituting (18.20.5) on the right. (18.23.6) is a limiting case of (18.26.18) via (18.26.6).
- §18.25 For Table 18.25.1, Rows 2, 3, 4, see Wilson (1980); for Row 5 see Ismail (2005, (6.2.20)). (18.25.1) follows from (18.25.11). For (18.25.3)–(18.25.5) see Wilson (1980) and Andrews *et al.* (1999, (3.8.3)). For (18.25.6)–(18.25.8) see Wilson (1980). For (18.25.10)–(18.25.12) see Wilson (1980). For (18.25.13)–(18.25.15) see Ismail (2005, (6.2.20)). Table 18.25.2 follows from §18.26(i).
- §18.26 For (18.26.1) see Andrews *et al.* (1999, Definition 3.8.1). For (18.26.2) and (18.26.3) see Wilson (1980). For (18.26.4) see Ismail (2005, (6.2.19)). For (18.26.5) and (18.26.7) see Wilson (1980). (18.26.6) follows from (18.26.1) and (18.20.9). (18.26.8) follows from (18.26.2) and (18.20.10). (18.26.9) follows from (18.26.3) and (18.26.4). (18.26.10) follows from (18.26.3) and (18.20.5). For (18.26.11) see Karlin and McGregor (1961, (1.21)). (18.26.12), (18.26.13) follow from (18.26.4) and (18.20.7). (18.26.14)–(18.26.17) follow from §18.26(i). For (18.26.18) see Ismail *et al.* (1990, (6.1)). (18.26.19) follows by expanding both factors on the left as power series in  $z$ , and substituting (18.26.2) on the right. (18.26.20) follows from (18.26.18), (18.26.1), (18.26.3). For (18.26.21) see Ismail (2005, (6.2.31)).
- §18.27 For (18.27.3), (18.27.4) see Gasper and Rahman (2004, (7.2.21), (7.2.22)) and Ismail (2005,

(18.5.1), (18.5.2)). For (18.27.8)–(18.27.11) see Gasper and Rahman (2004, (7.3.10), (7.3.12)) and Ismail (2005, (18.4.7), (18.4.14)). For (18.27.14) see Gasper and Rahman (2004, (7.3.1), (7.3.3)). For (18.27.16), (18.27.17) see Ismail (2005, (21.8.2), (21.8.4)) and Moak (1981, Theorem 2). For (18.27.18)–(18.27.20) see Ismail (2005, (21.8.3), (21.8.46)). For (18.27.21)–(18.27.24) see Al-Salam and Carlitz (1965).

**§18.28** For (18.28.1)–(18.28.6) see Askey and Wilson (1985), Gasper and Rahman (2004, (7.5.2), (7.5.15), (7.5.21)), Ismail (2005, (15.2.4), (15.2.5)). For (18.28.7), (18.28.8) see Ismail (2005, (15.1.5), (15.1.6), (15.1.11)). For (18.28.9)–(18.28.12) see Askey and Ismail (1984, Chapter 3). For (18.28.13)–(18.28.15) see Gasper and Rahman (2004, (7.4.2), (7.4.14)–(7.4.16)) and Ismail (2005, (13.2.3)–(13.2.5), (13.2.11)). For (18.28.16)–(18.28.18) see Ismail (2005, (13.1.7), (13.1.11),

(21.2.1), (21.2.5)). For (18.28.19), (18.28.20) see Gasper and Rahman (2004, (7.2.11)) and Ismail (2005, (15.6.1), (15.6.7)).

**§18.30** For (18.30.5) see Wimp (1987, Theorem 1). (18.30.7) is mentioned in Chihara (1978, Chapter VI, (12.6)), and proved in Barrucand and Dickinson (1968).

**§18.33** For (18.33.1), (18.33.4), (18.33.8), and (18.33.9) see Szegő (1975, (11.1.8), (11.4.6), (11.4.7), (11.5.2)). (18.33.6) follows from (18.33.4), (18.33.5). (18.33.10), (18.33.11) follow from (18.33.8), (18.33.9). For (18.33.13)–(18.33.16) see Askey (1982) and Pastro (1985).

**§18.34** Ismail (2005, Chapter 4).

**§18.35** Ismail (2005, Chapter 5).

**§18.37** Dunkl and Xu (2001, §2.4.3), Koornwinder (1975c).

## Chapter 19

# Elliptic Integrals

B. C. Carlson<sup>1</sup>

<b>Notation</b>	<b>486</b>	19.21 Connection Formulas . . . . .	503
19.1 Special Notation . . . . .	486	19.22 Quadratic Transformations . . . . .	504
<b>Legendre's Integrals</b>	<b>486</b>	19.23 Integral Representations . . . . .	506
19.2 Definitions . . . . .	486	19.24 Inequalities . . . . .	506
19.3 Graphics . . . . .	488	19.25 Relations to Other Functions . . . . .	507
19.4 Derivatives and Differential Equations . .	490	19.26 Addition Theorems . . . . .	509
19.5 Maclaurin and Related Expansions . . . .	490	19.27 Asymptotic Approximations and Expansions	510
19.6 Special Cases . . . . .	491	19.28 Integrals of Elliptic Integrals . . . . .	511
19.7 Connection Formulas . . . . .	491	19.29 Reduction of General Elliptic Integrals . .	512
19.8 Quadratic Transformations . . . . .	492	<b>Applications</b>	<b>514</b>
19.9 Inequalities . . . . .	494	19.30 Lengths of Plane Curves . . . . .	514
19.10 Relations to Other Functions . . . . .	494	19.31 Probability Distributions . . . . .	515
19.11 Addition Theorems . . . . .	495	19.32 Conformal Map onto a Rectangle . . . . .	515
19.12 Asymptotic Approximations . . . . .	495	19.33 Triaxial Ellipsoids . . . . .	515
19.13 Integrals of Elliptic Integrals . . . . .	496	19.34 Mutual Inductance of Coaxial Circles . . .	516
19.14 Reduction of General Elliptic Integrals . .	496	19.35 Other Applications . . . . .	516
<b>Symmetric Integrals</b>	<b>497</b>	<b>Computation</b>	<b>517</b>
19.15 Advantages of Symmetry . . . . .	497	19.36 Methods of Computation . . . . .	517
19.16 Definitions . . . . .	497	19.37 Tables . . . . .	518
19.17 Graphics . . . . .	499	19.38 Approximations . . . . .	519
19.18 Derivatives and Differential Equations . .	500	19.39 Software . . . . .	519
19.19 Taylor and Related Series . . . . .	501	<b>References</b>	<b>519</b>
19.20 Special Cases . . . . .	502		

<sup>1</sup>Mathematics Department and Ames Laboratory (U.S. Department of Energy), Iowa State University, Ames, Iowa.

**Acknowledgments:** The parts of this chapter that deal with Legendre's integrals are based in part on Abramowitz and Stegun (1964, Chapter 17) by L. M. Milne-Thomson. I am greatly indebted to R. C. Winther for indispensable technical support and to F. W. J. Olver for long-sustained encouragement of a new approach to elliptic integrals. I thank E. Neuman for improvements to §§19.9 and 19.24(i).

**Copyright** © 2009 National Institute of Standards and Technology. All rights reserved.

## Notation

### 19.1 Special Notation

(For other notation see pp. xiv and 873.)

- $l, m, n$  nonnegative integers.
- $\phi$  real or complex argument (or amplitude).
- $k$  real or complex modulus.
- $k'$  complementary real or complex modulus,  
 $k^2 + k'^2 = 1$ .
- $\alpha^2$  real or complex parameter.
- $B(a, b)$  beta function (§5.12).

All square roots have their principal values. All derivatives are denoted by differentials, not by primes.

The first set of main functions treated in this chapter are Legendre's complete integrals

$$19.1.1 \quad K(k), \quad E(k), \quad \Pi(\alpha^2, k),$$

of the first, second, and third kinds, respectively, and Legendre's incomplete integrals

$$19.1.2 \quad F(\phi, k), \quad E(\phi, k), \quad \Pi(\phi, \alpha^2, k),$$

of the first, second, and third kinds, respectively. This notation follows Byrd and Friedman (1971, 110). We use also the function  $D(\phi, k)$ , introduced by Jahnke *et al.* (1966, p. 43). The functions (19.1.1) and (19.1.2) are used in Erdélyi *et al.* (1953b, Chapter 13), except that  $\Pi(\alpha^2, k)$  and  $\Pi(\phi, \alpha^2, k)$  are denoted by  $\Pi_1(\nu, k)$  and  $\Pi(\phi, \nu, k)$ , respectively, where  $\nu = -\alpha^2$ .

In Abramowitz and Stegun (1964, Chapter 17) the functions (19.1.1) and (19.1.2) are denoted, in order, by  $K(\alpha)$ ,  $E(\alpha)$ ,  $\Pi(n \setminus \alpha)$ ,  $F(\phi \setminus \alpha)$ ,  $E(\phi \setminus \alpha)$ , and  $\Pi(n; \phi \setminus \alpha)$ , where  $\alpha = \arcsin k$  and  $n$  is the  $\alpha^2$  (not related to  $k$ ) in (19.1.1) and (19.1.2). Also, frequently in this reference  $\alpha$  is replaced by  $m$  and  $\setminus \alpha$  by  $|m$ , where  $m = k^2$ . However, it should be noted that in Chapter 8 of Abramowitz and Stegun (1964) the notation used for elliptic integrals differs from Chapter 17 and is consistent with that used in the present chapter and the rest of the NIST Handbook and DLMF.

The second set of main functions treated in this chapter is

$$19.1.3 \quad R_C(x, y), \quad R_F(x, y, z), \quad R_G(x, y, z), \\ R_J(x, y, z, p), \quad R_D(x, y, z), \\ R_{-a}(b_1, b_2, \dots, b_n; z_1, z_2, \dots, z_n).$$

$R_F(x, y, z)$ ,  $R_G(x, y, z)$ , and  $R_J(x, y, z, p)$  are the symmetric (in  $x, y$ , and  $z$ ) integrals of the first, second, and third kinds; they are complete if exactly one of  $x, y$ , and  $z$  is identically 0.

$R_{-a}(b_1, b_2, \dots, b_n; z_1, z_2, \dots, z_n)$  is a multivariate hypergeometric function that includes all the functions in (19.1.3).

A third set of functions, introduced by Bulirsch (1965a,b, 1969a), is

$$19.1.4 \quad \text{el1}(x, k_c), \quad \text{el2}(x, k_c, a, b), \\ \text{el3}(x, k_c, p), \quad \text{cel}(k_c, p, a, b).$$

The first three functions are incomplete integrals of the first, second, and third kinds, and the cel function includes complete integrals of all three kinds.

## Legendre's Integrals

### 19.2 Definitions

#### 19.2(i) General Elliptic Integrals

Let  $s^2(t)$  be a cubic or quartic polynomial in  $t$  with simple zeros, and let  $r(s, t)$  be a rational function of  $s$  and  $t$  containing at least one odd power of  $s$ . Then

$$19.2.1 \quad \int r(s, t) dt$$

is called an *elliptic integral*. Because  $s^2$  is a polynomial, we have

$$19.2.2 \quad r(s, t) = \frac{(p_1 + p_2 s)(p_3 - p_4 s)s}{(p_3 + p_4 s)(p_3 - p_4 s)s} = \frac{\rho}{s} + \sigma,$$

where  $p_j$  is a polynomial in  $t$  while  $\rho$  and  $\sigma$  are rational functions of  $t$ . Thus the *elliptic part* of (19.2.1) is

$$19.2.3 \quad \int \frac{\rho(t)}{s(t)} dt.$$

#### 19.2(ii) Legendre's Integrals

Assume  $1 - \sin^2 \phi \in \mathbb{C} \setminus (-\infty, 0]$  and  $1 - k^2 \sin^2 \phi \in \mathbb{C} \setminus (-\infty, 0]$ , except that one of them may be 0, and  $1 - \alpha^2 \sin^2 \phi \in \mathbb{C} \setminus \{0\}$ . Then

$$19.2.4 \quad F(\phi, k) = \int_0^\phi \frac{d\theta}{\sqrt{1 - k^2 \sin^2 \theta}} \\ = \int_0^{\sin \phi} \frac{dt}{\sqrt{1 - t^2} \sqrt{1 - k^2 t^2}},$$

$$19.2.5 \quad E(\phi, k) = \int_0^\phi \sqrt{1 - k^2 \sin^2 \theta} d\theta \\ = \int_0^{\sin \phi} \frac{\sqrt{1 - k^2 t^2}}{\sqrt{1 - t^2}} dt.$$

$$19.2.6 \quad D(\phi, k) = \int_0^\phi \frac{\sin^2 \theta d\theta}{\sqrt{1 - k^2 \sin^2 \theta}} \\ = \int_0^{\sin \phi} \frac{t^2 dt}{\sqrt{1 - t^2} \sqrt{1 - k^2 t^2}} \\ = (F(\phi, k) - E(\phi, k))/k^2.$$

19.2.7

$$\begin{aligned} \Pi(\phi, \alpha^2, k) &= \int_0^\phi \frac{d\theta}{\sqrt{1 - k^2 \sin^2 \theta} \sqrt{1 - \alpha^2 \sin^2 \theta}} \\ &= \int_0^{\sin \phi} \frac{dt}{\sqrt{1 - t^2} \sqrt{1 - k^2 t^2} \sqrt{1 - \alpha^2 t^2}}. \end{aligned}$$

The paths of integration are the line segments connecting the limits of integration. The integral for  $E(\phi, k)$  is well defined if  $k^2 = \sin^2 \phi = 1$ , and the Cauchy principal value (§1.4(v)) of  $\Pi(\phi, \alpha^2, k)$  is taken if  $1 - \alpha^2 \sin^2 \phi$  vanishes at an interior point of the integration path. Also, if  $k^2$  and  $\alpha^2$  are real, then  $\Pi(\phi, \alpha^2, k)$  is called a *circular* or *hyperbolic case* according as  $\alpha^2(\alpha^2 - k^2)(\alpha^2 - 1)$  is negative or positive. The circular and hyperbolic cases alternate in the four intervals of the real line separated by the points  $\alpha^2 = 0, k^2, 1$ .

The cases with  $\phi = \pi/2$  are the *complete integrals*:

$$K(k) = F(\pi/2, k), \quad E(k) = E(\pi/2, k),$$

19.2.8  $D(k) = D(\pi/2, k) = (K(k) - E(k))/k^2,$

$$\Pi(\alpha^2, k) = \Pi(\pi/2, \alpha^2, k),$$

19.2.9  $K'(k) = K(k'), \quad E'(k) = E(k'), \quad k' = \sqrt{1 - k^2}.$

If  $m$  is an integer, then

$$F(m\pi \pm \phi, k) = 2mK(k) \pm F(\phi, k),$$

19.2.10  $E(m\pi \pm \phi, k) = 2mE(k) \pm E(\phi, k),$

$$D(m\pi \pm \phi, k) = 2mD(k) \pm D(\phi, k).$$

19.2(iii) **Bulirsch's Integrals**

Bulirsch's integrals are linear combinations of Legendre's integrals that are chosen to facilitate computational application of Bartky's transformation (Bartky (1938)). Two are defined by

19.2.11 
$$\begin{aligned} &\text{cel}(k_c, p, a, b) \\ &= \int_0^{\pi/2} \frac{a \cos^2 \theta + b \sin^2 \theta}{\cos^2 \theta + p \sin^2 \theta} \frac{d\theta}{\sqrt{\cos^2 \theta + k_c^2 \sin^2 \theta}}, \end{aligned}$$

19.2.12 
$$\begin{aligned} &\text{el2}(x, k_c, a, b) \\ &= \int_0^{\arctan x} \frac{a + b \tan^2 \theta}{\sqrt{(1 + \tan^2 \theta)(1 + k_c^2 \tan^2 \theta)}} d\theta. \end{aligned}$$

Here  $a, b, p$  are real parameters, and  $k_c$  and  $x$  are real or complex variables, with  $p \neq 0, k_c \neq 0$ . If  $-\infty < p < 0$ , then the integral in (19.2.11) is a Cauchy principal value.

With

19.2.13  $k_c = k', \quad p = 1 - \alpha^2, \quad x = \tan \phi,$

special cases include

19.2.14

$$K(k) = \text{cel}(k_c, 1, 1, 1),$$

$$E(k) = \text{cel}(k_c, 1, 1, k_c^2), \quad D(k) = \text{cel}(k_c, 1, 0, 1),$$

$$(E(k) - k'^2 K(k))/k^2 = \text{cel}(k_c, 1, 1, 0),$$

$$\Pi(\alpha^2, k) = \text{cel}(k_c, p, 1, 1),$$

and

$$F(\phi, k) = \text{el1}(x, k_c) = \text{el2}(x, k_c, 1, 1),$$

19.2.15  $E(\phi, k) = \text{el2}(x, k_c, 1, k_c^2),$

$$D(\phi, k) = \text{el2}(x, k_c, 0, 1).$$

The integrals are *complete* if  $x = \infty$ . If  $1 < k \leq 1/\sin \phi$ , then  $k_c$  is pure imaginary.

Lastly, corresponding to Legendre's incomplete integral of the third kind we have

19.2.16

$$\begin{aligned} &\text{el3}(x, k_c, p) \\ &= \int_0^{\arctan x} \frac{d\theta}{(\cos^2 \theta + p \sin^2 \theta) \sqrt{\cos^2 \theta + k_c^2 \sin^2 \theta}} \\ &= \Pi(\arctan x, 1 - p, k), \quad x^2 \neq -1/p. \end{aligned}$$

19.2(iv)  **$R_C(x, y)$**

Let  $x \in \mathbb{C} \setminus (-\infty, 0)$  and  $y \in \mathbb{C} \setminus \{0\}$ . We define

19.2.17 
$$R_C(x, y) = \frac{1}{2} \int_0^\infty \frac{dt}{\sqrt{t + x} \sqrt{t + y}},$$

where the Cauchy principal value is taken if  $y < 0$ . Formulas involving  $\Pi(\phi, \alpha^2, k)$  that are customarily different for circular cases, ordinary hyperbolic cases, and (hyperbolic) Cauchy principal values, are united in a single formula by using  $R_C(x, y)$ .

In (19.2.18)–(19.2.22) the inverse trigonometric and hyperbolic functions assume their principal values (§§4.23(ii) and 4.37(ii)). When  $x$  and  $y$  are positive,  $R_C(x, y)$  is an inverse circular function if  $x < y$  and an inverse hyperbolic function (or logarithm) if  $x > y$ :

19.2.18 
$$\begin{aligned} R_C(x, y) &= \frac{1}{\sqrt{y-x}} \arctan \sqrt{\frac{y-x}{x}} \\ &= \frac{1}{\sqrt{y-x}} \arccos \sqrt{x/y}, \quad 0 \leq x < y, \end{aligned}$$

19.2.19 
$$\begin{aligned} R_C(x, y) &= \frac{1}{\sqrt{x-y}} \operatorname{arctanh} \sqrt{\frac{x-y}{x}} \\ &= \frac{1}{\sqrt{x-y}} \ln \frac{\sqrt{x} + \sqrt{x-y}}{\sqrt{y}}, \quad 0 < y < x. \end{aligned}$$

The Cauchy principal value is hyperbolic:

19.2.20

$$\begin{aligned} R_C(x, y) &= \sqrt{\frac{x}{x-y}} R_C(x-y, -y) \\ &= \frac{1}{\sqrt{x-y}} \operatorname{arctanh} \sqrt{\frac{x}{x-y}} \\ &= \frac{1}{\sqrt{x-y}} \ln \frac{\sqrt{x} + \sqrt{x-y}}{\sqrt{-y}}, \quad y < 0 \leq x. \end{aligned}$$



If the line segment with endpoints  $x$  and  $y$  lies in  $\mathbb{C} \setminus (-\infty, 0]$ , then

$$19.2.21 \quad R_C(x, y) = \int_0^1 (v^2 x + (1 - v^2)y)^{-1/2} dv,$$

19.2.22

$$R_C(x, y) = \frac{2}{\pi} \int_0^{\pi/2} R_C(y, x \cos^2 \theta + y \sin^2 \theta) d\theta.$$

### 19.3 Graphics

#### 19.3(i) Real Variables

See Figures 19.3.1–19.3.6 for complete and incomplete Legendre’s elliptic integrals.

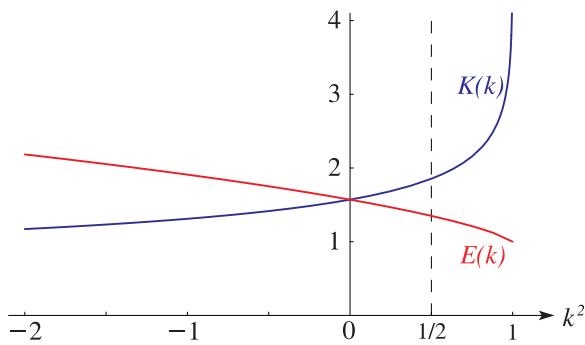


Figure 19.3.1:  $K(k)$  and  $E(k)$  as functions of  $k^2$  for  $-2 \leq k^2 \leq 1$ . Graphs of  $K'(k)$  and  $E'(k)$  are the mirror images in the vertical line  $k^2 = \frac{1}{2}$ .

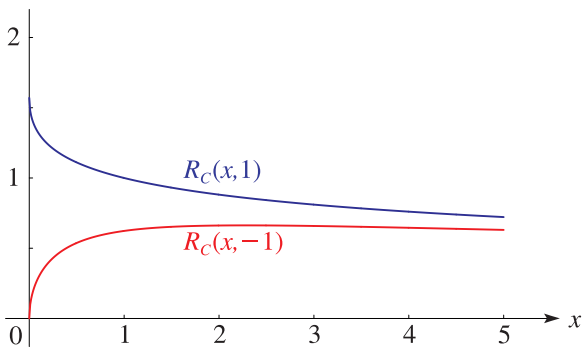


Figure 19.3.2:  $R_C(x, 1)$  and the Cauchy principal value of  $R_C(x, -1)$  for  $0 \leq x \leq 5$ . Both functions are asymptotic to  $\ln(4x)/\sqrt{4x}$  as  $x \rightarrow \infty$ ; see (19.2.19) and (19.2.20). Note that  $R_C(x, \pm y) = y^{-1/2} R_C(x/y, \pm 1)$ ,  $y > 0$ .

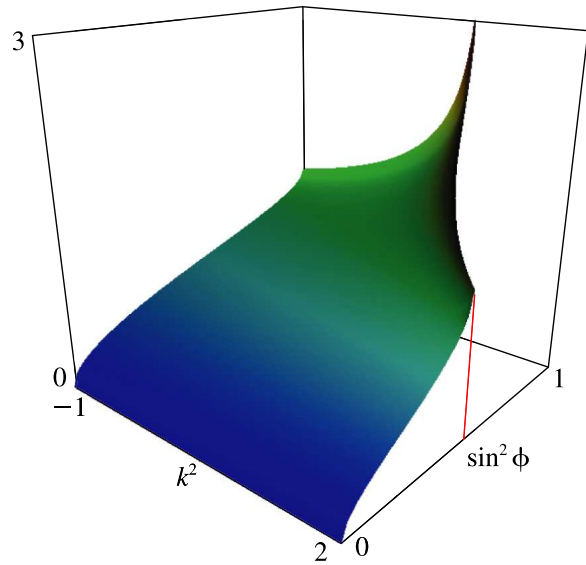


Figure 19.3.3:  $F(\phi, k)$  as a function of  $k^2$  and  $\sin^2 \phi$  for  $-1 \leq k^2 \leq 2$ ,  $0 \leq \sin^2 \phi \leq 1$ . If  $\sin^2 \phi = 1$  ( $\geq k^2$ ), then the function reduces to  $K(k)$ , becoming infinite when  $k^2 = 1$ . If  $\sin^2 \phi = 1/k^2$  ( $< 1$ ), then it has the value  $K(1/k)/k$ : put  $c = k^2$  in (19.25.5) and use (19.25.1).

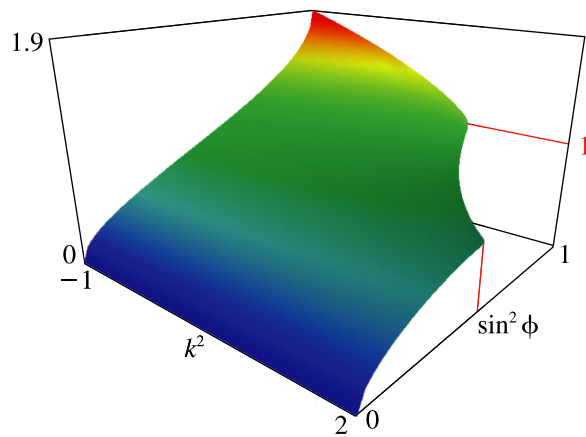


Figure 19.3.4:  $E(\phi, k)$  as a function of  $k^2$  and  $\sin^2 \phi$  for  $-1 \leq k^2 \leq 2$ ,  $0 \leq \sin^2 \phi \leq 1$ . If  $\sin^2 \phi = 1$  ( $\geq k^2$ ), then the function reduces to  $E(k)$ , with value 1 at  $k^2 = 1$ . If  $\sin^2 \phi = 1/k^2$  ( $< 1$ ), then it has the value  $k E(1/k) + (k'^2/k) K(1/k)$ , with limit 1 as  $k^2 \rightarrow 1+$ : put  $c = k^2$  in (19.25.7) and use (19.25.1).

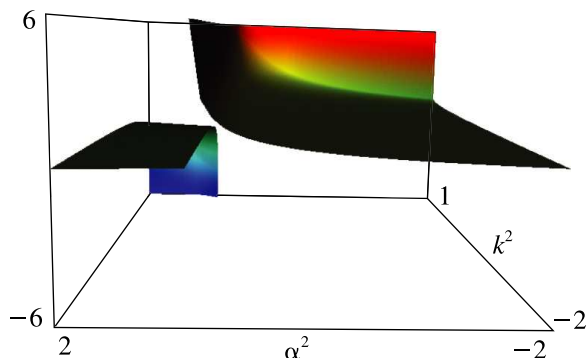


Figure 19.3.5:  $\Pi(\alpha^2, k)$  as a function of  $k^2$  and  $\alpha^2$  for  $-2 \leq k^2 < 1$ ,  $-2 \leq \alpha^2 \leq 2$ . Cauchy principal values are shown when  $\alpha^2 > 1$ . The function is unbounded as  $\alpha^2 \rightarrow 1^-$ , and also (with the same sign as  $1 - \alpha^2$ ) as  $k^2 \rightarrow 1^-$ . As  $\alpha^2 \rightarrow 1^+$  it has the limit  $K(k) - (E(k)/k'^2)$ . If  $\alpha^2 = 0$ , then it reduces to  $K(k)$ . If  $k^2 = 0$ , then it has the value  $\frac{1}{2}\pi/\sqrt{1 - \alpha^2}$  when  $\alpha^2 < 1$ , and 0 when  $\alpha^2 > 1$ . See §19.6(i).

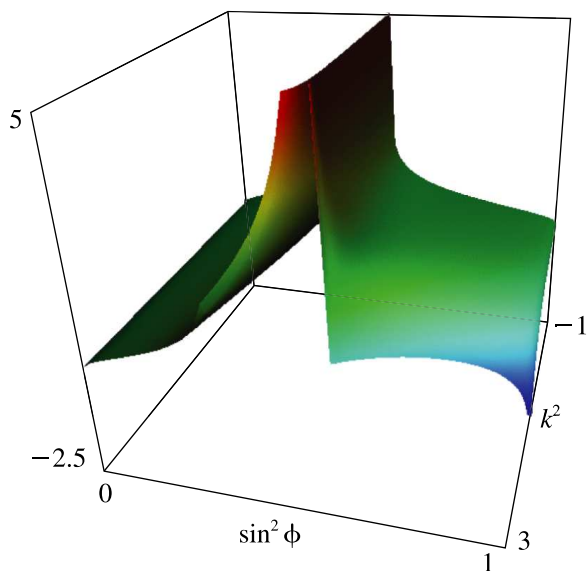


Figure 19.3.6:  $\Pi(\phi, 2, k)$  as a function of  $k^2$  and  $\sin^2 \phi$  for  $-1 \leq k^2 \leq 3$ ,  $0 \leq \sin^2 \phi < 1$ . Cauchy principal values are shown when  $\sin^2 \phi > \frac{1}{2}$ . The function tends to  $+\infty$  as  $\sin^2 \phi \rightarrow \frac{1}{2}$ , except in the last case below. If  $\sin^2 \phi = 1$  ( $> k^2$ ), then the function reduces to  $\Pi(2, k)$  with Cauchy principal value  $K(k) - \Pi(\frac{1}{2}k^2, k)$ , which tends to  $-\infty$  as  $k^2 \rightarrow 1^-$ . See (19.6.5) and (19.6.6). If  $\sin^2 \phi = 1/k^2$  ( $< 1$ ), then by (19.7.4) it reduces to  $\Pi(2/k^2, 1/k)/k$ ,  $k^2 \neq 2$ , with Cauchy principal value  $(K(1/k) - \Pi(\frac{1}{2}, 1/k))/k$ ,  $1 < k^2 < 2$ , by (19.6.5). Its value tends to  $-\infty$  as  $k^2 \rightarrow 1^+$  by (19.6.6), and to the negative of the second lemniscate constant (see (19.20.22)) as  $k^2 (= \csc^2 \phi) \rightarrow 2^-$ .

### 19.3(ii) Complex Variables

In Figures 19.3.7 and 19.3.8 for complete Legendre's elliptic integrals with complex arguments, height corresponds to the absolute value of the function and color to the phase. See also p. xiv.

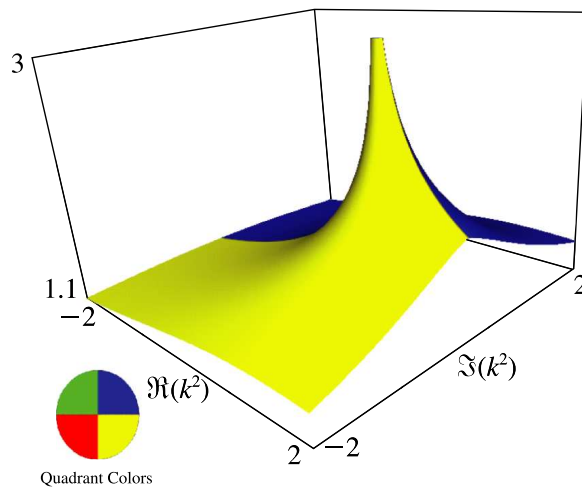


Figure 19.3.7:  $K(k)$  as a function of complex  $k^2$  for  $-2 \leq \Re(k^2) \leq 2$ ,  $-2 \leq \Im(k^2) \leq 2$ . There is a branch cut where  $1 < k^2 < \infty$ .

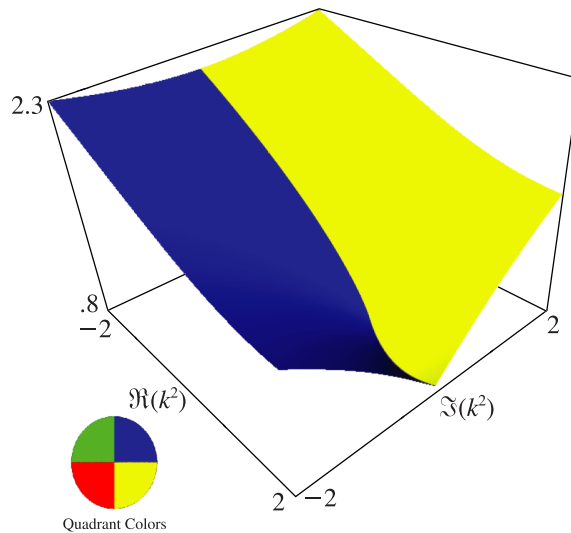


Figure 19.3.8:  $E(k)$  as a function of complex  $k^2$  for  $-2 \leq \Re(k^2) \leq 2$ ,  $-2 \leq \Im(k^2) \leq 2$ . There is a branch cut where  $1 < k^2 < \infty$ .

For further graphics, see <http://dlmf.nist.gov/19.3.ii>.

### 19.4 Derivatives and Differential Equations

#### 19.4(i) Derivatives

$$19.4.1 \quad \frac{dK(k)}{dk} = \frac{E(k) - k'^2 K(k)}{kk'^2},$$

$$\frac{d(E(k) - k'^2 K(k))}{dk} = k K(k),$$

$$19.4.2 \quad \frac{dE(k)}{dk} = \frac{E(k) - K(k)}{k}, \quad \frac{d(E(k) - K(k))}{dk} = -\frac{k E(k)}{k'^2},$$

$$19.4.3 \quad \frac{d^2 E(k)}{dk^2} = -\frac{1}{k} \frac{dK(k)}{dk} = \frac{k'^2 K(k) - E(k)}{k^2 k'^2},$$

$$19.4.4 \quad \frac{\partial \Pi(\alpha^2, k)}{\partial k} = \frac{k}{k'^2(k^2 - \alpha^2)} (E(k) - k'^2 \Pi(\alpha^2, k)).$$

$$19.4.5 \quad \frac{\partial F(\phi, k)}{\partial k} = \frac{E(\phi, k) - k'^2 F(\phi, k)}{kk'^2} - \frac{k \sin \phi \cos \phi}{k'^2 \sqrt{1 - k^2 \sin^2 \phi}},$$

$$19.4.6 \quad \frac{\partial E(\phi, k)}{\partial k} = \frac{E(\phi, k) - F(\phi, k)}{k},$$

$$19.4.7 \quad \frac{\partial \Pi(\phi, \alpha^2, k)}{\partial k} = \frac{k}{k'^2(k^2 - \alpha^2)} \left( E(\phi, k) - k'^2 \Pi(\phi, \alpha^2, k) - \frac{k^2 \sin \phi \cos \phi}{\sqrt{1 - k^2 \sin^2 \phi}} \right).$$

#### 19.4(ii) Differential Equations

Let  $D_k = \partial/\partial k$ . Then

$$19.4.8 \quad (kk'^2 D_k^2 + (1 - 3k^2)D_k - k) F(\phi, k) = \frac{-k \sin \phi \cos \phi}{(1 - k^2 \sin^2 \phi)^{3/2}},$$

$$19.4.9 \quad (kk'^2 D_k^2 + k'^2 D_k + k) E(\phi, k) = \frac{k \sin \phi \cos \phi}{\sqrt{1 - k^2 \sin^2 \phi}}.$$

If  $\phi = \pi/2$ , then these two equations become hypergeometric differential equations (15.10.1) for  $K(k)$  and  $E(k)$ . An analogous differential equation of third order for  $\Pi(\phi, \alpha^2, k)$  is given in Byrd and Friedman (1971, 118.03).

### 19.5 Maclaurin and Related Expansions

If  $|k| < 1$  and  $|\alpha| < 1$ , then

$$19.5.1 \quad K(k) = \frac{\pi}{2} \sum_{m=0}^{\infty} \frac{(\frac{1}{2})_m (\frac{1}{2})_m}{m! m!} k^{2m} = \frac{\pi}{2} {}_2F_1\left(\frac{1}{2}, \frac{1}{2}; 1; k^2\right),$$

where  ${}_2F_1$  is the Gauss hypergeometric function (§§15.1 and 15.2(i)).

$$19.5.2 \quad E(k) = \frac{\pi}{2} \sum_{m=0}^{\infty} \frac{(-\frac{1}{2})_m (\frac{1}{2})_m}{m! m!} k^{2m} = \frac{\pi}{2} {}_2F_1\left(-\frac{1}{2}, \frac{1}{2}; 1; k^2\right),$$

#### 19.5.3

$$D(k) = \frac{\pi}{4} \sum_{m=0}^{\infty} \frac{(\frac{3}{2})_m (\frac{1}{2})_m}{(m+1)! m!} k^{2m} = \frac{\pi}{4} {}_2F_1\left(\frac{3}{2}, \frac{1}{2}; 2; k^2\right),$$

$$19.5.4 \quad \Pi(\alpha^2, k) = \frac{\pi}{2} \sum_{n=0}^{\infty} \frac{(\frac{1}{2})_n}{n!} \sum_{m=0}^n \frac{(\frac{1}{2})_m}{m!} k^{2m} \alpha^{2n-2m}$$

$$= \frac{\pi}{2} F_1\left(\frac{1}{2}; \frac{1}{2}, 1; 1; k^2, \alpha^2\right),$$

where  $F_1(\alpha; \beta, \beta'; \gamma; x, y)$  is an Appell function (§16.13).

For Jacobi's nome  $q$ :

$$19.5.5 \quad q = \exp(-\pi K'(k)/K(k)) = r + 8r^2 + 84r^3 + 992r^4 + \dots,$$

$$r = \frac{1}{16} k^2, \quad 0 \leq k \leq 1.$$

Also,

$$19.5.6 \quad q = \lambda + 2\lambda^5 + 15\lambda^9 + 150\lambda^{13} + 1707\lambda^{17} + \dots, \quad 0 \leq k \leq 1,$$

where

$$19.5.7 \quad \lambda = (1 - \sqrt{k'})/(2(1 + \sqrt{k'})).$$

Coefficients of terms up to  $\lambda^{49}$  are given in Lee (1990), along with tables of fractional errors in  $K(k)$  and  $E(k)$ ,  $0.1 \leq k^2 \leq 0.9999$ , obtained by using 12 different truncations of (19.5.6) in (19.5.8) and (19.5.9).

$$19.5.8 \quad K(k) = \frac{\pi}{2} \left( 1 + 2 \sum_{n=1}^{\infty} q^{n^2} \right)^2, \quad |q| < 1,$$

#### 19.5.9

$$E(k) = K(k) + \frac{2\pi^2}{K(k)} \frac{\sum_{n=1}^{\infty} (-1)^n n^2 q^{n^2}}{1 + 2 \sum_{n=1}^{\infty} (-1)^n q^{n^2}}, \quad |q| < 1.$$

An infinite series for  $\ln K(k)$  is equivalent to the infinite product

$$19.5.10 \quad K(k) = \frac{\pi}{2} \prod_{m=1}^{\infty} (1 + k_m),$$

where  $k_0 = k$  and

$$19.5.11 \quad k_{m+1} = \frac{1 - \sqrt{1 - k_m^2}}{1 + \sqrt{1 - k_m^2}}, \quad m = 0, 1, \dots$$

Series expansions of  $F(\phi, k)$  and  $E(\phi, k)$  are surveyed and improved in Van de Vel (1969), and the case of  $F(\phi, k)$  is summarized in Gautschi (1975, §1.3.2). For series expansions of  $\Pi(\phi, \alpha^2, k)$  when  $|\alpha^2| < 1$  see Erdélyi *et al.* (1953b, §13.6(9)). See also Karp *et al.* (2007).

### 19.6 Special Cases

#### 19.6(i) Complete Elliptic Integrals

**19.6.1**  $K(0) = E(0) = K'(1) = E'(1) = \frac{1}{2}\pi,$   
 $K(1) = K'(0) = \infty, \quad E(1) = E'(0) = 1.$

**19.6.2**  $\Pi(k^2, k) = E(k)/k'^2, \quad k^2 < 1,$   
 $\Pi(-k, k) = \frac{1}{4}\pi(1+k)^{-1} + \frac{1}{2}K(k), \quad 0 \leq k^2 < 1.$

**19.6.3**  $\Pi(\alpha^2, 0) = \pi/(2\sqrt{1-\alpha^2}), \quad \Pi(0, k) = K(k),$   
 $-\infty < \alpha^2 < 1.$

**19.6.4**  $\Pi(\alpha^2, k) \rightarrow +\infty, \quad \alpha^2 \rightarrow 1-,$   
 $\Pi(\alpha^2, k) \rightarrow \infty \operatorname{sign}(1-\alpha^2), \quad k^2 \rightarrow 1-.$

If  $1 < \alpha^2 < \infty$ , then the Cauchy principal value satisfies

**19.6.5**  $\Pi(\alpha^2, k) = K(k) - \Pi(k^2/\alpha^2, k),$

and

$\Pi(\alpha^2, 0) = 0,$

**19.6.6**  $\Pi(\alpha^2, k) \rightarrow K(k) - (E(k)/k'^2), \quad \alpha^2 \rightarrow 1+,$   
 $\Pi(\alpha^2, k) \rightarrow -\infty, \quad k^2 \rightarrow 1-.$

Exact values of  $K(k)$  and  $E(k)$  for various special values of  $k$  are given in Byrd and Friedman (1971, 111.10 and 111.11) and Cooper *et al.* (2006).

#### 19.6(ii) $F(\phi, k)$

**19.6.7**  $F(0, k) = 0, \quad F(\phi, 0) = \phi, \quad F(\frac{1}{2}\pi, 1) = \infty,$   
 $F(\frac{1}{2}\pi, k) = K(k), \quad \lim_{\phi \rightarrow 0} F(\phi, k)/\phi = 1.$

**19.6.8**  $F(\phi, 1) = (\sin \phi) R_C(1, \cos^2 \phi) = \operatorname{gd}^{-1}(\phi).$

For the inverse Gudermannian function  $\operatorname{gd}^{-1}(\phi)$  see §4.23(viii). Compare also (19.10.2).

#### 19.6(iii) $E(\phi, k)$

**19.6.9**  $E(0, k) = 0, \quad E(\phi, 0) = \phi, \quad E(\frac{1}{2}\pi, 1) = 1,$   
 $E(\phi, 1) = \sin \phi, \quad E(\frac{1}{2}\pi, k) = E(k).$

**19.6.10**  $\lim_{\phi \rightarrow 0} E(\phi, k)/\phi = 1.$

#### 19.6(iv) $\Pi(\phi, \alpha^2, k)$

Circular and hyperbolic cases, including Cauchy principal values, are unified by using  $R_C(x, y)$ . Let  $c = \operatorname{csc}^2 \phi \neq \alpha^2$  and  $\Delta = \sqrt{1 - k^2 \sin^2 \phi}$ . Then

**19.6.11**  $\Pi(0, \alpha^2, k) = 0, \quad \Pi(\phi, 0, 0) = \phi, \quad \Pi(\phi, 1, 0) = \tan \phi.$

**19.6.12**  $\Pi(\phi, \alpha^2, 0) = R_C(c - 1, c - \alpha^2),$   
 $\Pi(\phi, \alpha^2, 1) = \frac{1}{1 - \alpha^2} (R_C(c, c - 1) - \alpha^2 R_C(c, c - \alpha^2)),$   
 $\Pi(\phi, 1, 1) = \frac{1}{2}(R_C(c, c - 1) + \sqrt{c}(c - 1)^{-1}).$

**19.6.13**  $\Pi(\phi, 0, k) = F(\phi, k),$   
 $\Pi(\phi, k^2, k) = \frac{1}{k'^2} \left( E(\phi, k) - \frac{k^2}{\Delta} \sin \phi \cos \phi \right),$   
 $\Pi(\phi, 1, k) = F(\phi, k) - \frac{1}{k'^2} (E(\phi, k) - \Delta \tan \phi).$

**19.6.14**  $\Pi(\frac{1}{2}\pi, \alpha^2, k) = \Pi(\alpha^2, k), \quad \lim_{\phi \rightarrow 0} \Pi(\phi, \alpha^2, k)/\phi = 1.$

For the Cauchy principal value of  $\Pi(\phi, \alpha^2, k)$  when  $\alpha^2 > c$ , see §19.7(iii).

#### 19.6(v) $R_C(x, y)$

**19.6.15**  $R_C(x, x) = x^{-1/2}, \quad R_C(\lambda x, \lambda y) = \lambda^{-1/2} R_C(x, y),$   
 $R_C(x, y) \rightarrow +\infty, \quad y \rightarrow 0+ \text{ or } y \rightarrow 0-, \quad x > 0,$   
 $R_C(0, y) = \frac{1}{2}\pi y^{-1/2}, \quad |\operatorname{ph} y| < \pi,$   
 $R_C(0, y) = 0, \quad y < 0.$

### 19.7 Connection Formulas

#### 19.7(i) Complete Integrals of the First and Second Kinds

##### Legendre's Relation

**19.7.1**  $E(k) K'(k) + E'(k) K(k) - K(k) K'(k) = \frac{1}{2}\pi.$   
 Also,

**19.7.2**  $K(ik/k') = k' K(k), \quad K(k'/ik) = k K(k'),$   
 $E(ik/k') = (1/k') E(k), \quad E(k'/ik) = (1/k) E(k').$

**19.7.3**  $K(1/k) = k(K(k) \mp i K(k')),$   
 $K(1/k') = k'(K(k') \pm i K(k)),$   
 $E(1/k) = (1/k) (E(k) \pm i E(k') - k'^2 K(k) \mp ik^2 K(k')),$   
 $E(1/k') = (1/k') (E(k') \mp i E(k) - k^2 K(k') \pm ik'^2 K(k)),$

where upper signs apply if  $\Im k^2 > 0$  and lower signs if  $\Im k^2 < 0$ . This dichotomy of signs (missing in several references) is due to Fettis (1970).

**19.7(ii) Change of Modulus and Amplitude**

**Reciprocal-Modulus Transformation**

$$\begin{aligned}
 &F(\phi, k_1) = k F(\beta, k), \\
 19.7.4 \quad &E(\phi, k_1) = (E(\beta, k) - k'^2 F(\beta, k))/k, \\
 &\Pi(\phi, \alpha^2, k_1) = k \Pi(\beta, k^2 \alpha^2, k), \\
 &k_1 = 1/k, \sin \beta = k_1 \sin \phi \leq 1.
 \end{aligned}$$

**Imaginary-Modulus Transformation**

$$\begin{aligned}
 19.7.5 \quad &F(\phi, ik) = \kappa' F(\theta, \kappa), \\
 &E(\phi, ik) = (1/\kappa') \left( E(\theta, \kappa) - \kappa^2 (\sin \theta \cos \theta) \right. \\
 &\quad \left. \times (1 - \kappa^2 \sin^2 \theta)^{-1/2} \right), \\
 &\Pi(\phi, \alpha^2, ik) = (\kappa'/\alpha_1^2) \left( \kappa^2 F(\theta, \kappa) + \kappa'^2 \alpha^2 \Pi(\theta, \alpha_1^2, \kappa) \right),
 \end{aligned}$$

where

$$\begin{aligned}
 19.7.6 \quad &\kappa = \frac{k}{\sqrt{1+k^2}}, \quad \kappa' = \frac{1}{\sqrt{1+k^2}}, \\
 &\sin \theta = \frac{\sqrt{1+k^2} \sin \phi}{\sqrt{1+k^2 \sin^2 \phi}}, \quad \alpha_1^2 = \frac{\alpha^2 + k^2}{1+k^2}.
 \end{aligned}$$

**Imaginary-Argument Transformation**

With  $\sinh \phi = \tan \psi$ ,

$$\begin{aligned}
 &F(i\phi, k) = i F(\psi, k'), \\
 &E(i\phi, k) = i \left( F(\psi, k') - E(\psi, k') \right. \\
 19.7.7 \quad &\quad \left. + (\tan \psi) \sqrt{1 - k'^2 \sin^2 \psi} \right), \\
 &\Pi(i\phi, \alpha^2, k) = i \left( F(\psi, k') \right. \\
 &\quad \left. - \alpha^2 \Pi(\psi, 1 - \alpha^2, k') \right) / (1 - \alpha^2).
 \end{aligned}$$

For two further transformations of this type see Erdélyi *et al.* (1953b, p. 316).

**19.7(iii) Change of Parameter of  $\Pi(\phi, \alpha^2, k)$**

There are three relations connecting  $\Pi(\phi, \alpha^2, k)$  and  $\Pi(\phi, \omega^2, k)$ , where  $\omega^2$  is a rational function of  $\alpha^2$ . If  $k^2$  and  $\alpha^2$  are real, then both integrals are circular cases or both are hyperbolic cases (see §19.2(ii)).

The first of the three relations maps each circular region onto itself and each hyperbolic region onto the other; in particular, it gives the Cauchy principal value

of  $\Pi(\phi, \alpha^2, k)$  when  $\alpha^2 > \csc^2 \phi$  (see (19.6.5) for the complete case). Let  $c = \csc^2 \phi \neq \alpha^2$ . Then

$$\begin{aligned}
 19.7.8 \quad &\Pi(\phi, \alpha^2, k) + \Pi(\phi, \omega^2, k) \\
 &= F(\phi, k) + \sqrt{c} R_C((c-1)(c-k^2), (c-\alpha^2)(c-\omega^2)), \\
 &\quad \alpha^2 \omega^2 = k^2.
 \end{aligned}$$

Since  $k^2 \leq c$  we have  $\alpha^2 \omega^2 \leq c$ ; hence  $\alpha^2 > c$  implies  $\omega^2 < 1 \leq c$ .

The second relation maps each hyperbolic region onto itself and each circular region onto the other:

$$\begin{aligned}
 19.7.9 \quad &(k^2 - \alpha^2) \Pi(\phi, \alpha^2, k) + (k^2 - \omega^2) \Pi(\phi, \omega^2, k) \\
 &= k^2 F(\phi, k) \\
 &\quad - \alpha^2 \omega^2 \sqrt{c-1} R_C(c(c-k^2), (c-\alpha^2)(c-\omega^2)), \\
 &\quad (1-\alpha^2)(1-\omega^2) = 1-k^2.
 \end{aligned}$$

The third relation (missing from the literature of Legendre's integrals) maps each circular region onto the other and each hyperbolic region onto the other:

$$\begin{aligned}
 19.7.10 \quad &(1-\alpha^2) \Pi(\phi, \alpha^2, k) + (1-\omega^2) \Pi(\phi, \omega^2, k) \\
 &= F(\phi, k) + (1-\alpha^2-\omega^2) \sqrt{c-k^2} \\
 &\quad \times R_C(c(c-1), (c-\alpha^2)(c-\omega^2)), \\
 &\quad (k^2-\alpha^2)(k^2-\omega^2) = k^2(k^2-1).
 \end{aligned}$$

**19.8 Quadratic Transformations**

**19.8(i) Gauss's Arithmetic-Geometric Mean (AGM)**

When  $a_0$  and  $g_0$  are positive numbers, define

$$\begin{aligned}
 19.8.1 \quad &a_{n+1} = \frac{a_n + g_n}{2}, \quad g_{n+1} = \sqrt{a_n g_n}, \quad n = 0, 1, 2, \dots
 \end{aligned}$$

As  $n \rightarrow \infty$ ,  $a_n$  and  $g_n$  converge to a common limit  $M(a_0, g_0)$  called the AGM (*Arithmetic-Geometric Mean*) of  $a_0$  and  $g_0$ . By symmetry in  $a_0$  and  $g_0$  we may assume  $a_0 \geq g_0$  and define

$$19.8.2 \quad c_n = \sqrt{a_n^2 - g_n^2}.$$

Then

$$19.8.3 \quad c_{n+1} = \frac{a_n - g_n}{2} = \frac{c_n^2}{4a_{n+1}},$$

showing that the convergence of  $c_n$  to 0 and of  $a_n$  and  $g_n$  to  $M(a_0, g_0)$  is quadratic in each case.

The AGM has the integral representations

$$\begin{aligned}
 19.8.4 \quad &\frac{1}{M(a_0, g_0)} = \frac{2}{\pi} \int_0^{\pi/2} \frac{d\theta}{\sqrt{a_0^2 \cos^2 \theta + g_0^2 \sin^2 \theta}} \\
 &= \frac{1}{\pi} \int_0^\infty \frac{dt}{\sqrt{t(t+a_0^2)(t+g_0^2)}}.
 \end{aligned}$$

The first of these shows that

$$19.8.5 \quad K(k) = \frac{\pi}{2M(1, k')}, \quad -\infty < k^2 < 1.$$

The AGM appears in

$$\begin{aligned}
 E(k) &= \frac{\pi}{2M(1, k')} \left( a_0^2 - \sum_{n=0}^{\infty} 2^{n-1} c_n^2 \right) \\
 19.8.6 \quad &= K(k) \left( a_1^2 - \sum_{n=2}^{\infty} 2^{n-1} c_n^2 \right), \\
 &\quad -\infty < k^2 < 1, a_0 = 1, g_0 = k',
 \end{aligned}$$

and in

$$19.8.7 \quad \Pi(\alpha^2, k) = \frac{\pi}{4M(1, k')} \left( 2 + \frac{\alpha^2}{1 - \alpha^2} \sum_{n=0}^{\infty} Q_n \right),$$

$$-\infty < k^2 < 1, -\infty < \alpha^2 < 1,$$

where  $a_0 = 1, g_0 = k', p_0^2 = 1 - \alpha^2, Q_0 = 1,$  and

$$19.8.8 \quad p_{n+1} = \frac{p_n^2 + a_n g_n}{2p_n}, \quad \varepsilon_n = \frac{p_n^2 - a_n g_n}{p_n^2 + a_n g_n},$$

$$Q_{n+1} = \frac{1}{2} Q_n \varepsilon_n, \quad n = 0, 1, \dots$$

Again,  $p_n$  and  $\varepsilon_n$  converge quadratically to  $M(a_0, g_0)$  and 0, respectively, and  $Q_n$  converges to 0 faster than quadratically. If  $\alpha^2 > 1,$  then the Cauchy principal value is

$$19.8.9 \quad \Pi(\alpha^2, k) = \frac{\pi}{4M(1, k')} \frac{k^2}{k^2 - \alpha^2} \sum_{n=0}^{\infty} Q_n,$$

$$-\infty < k^2 < 1, 1 < \alpha^2 < \infty,$$

where (19.8.8) still applies, but with

$$19.8.10 \quad p_0^2 = 1 - (k^2/\alpha^2).$$

### 19.8(ii) Landen Transformations

#### Descending Landen Transformation

Let

$$k_1 = \frac{1 - k'}{1 + k'},$$

$$19.8.11 \quad \phi_1 = \phi + \arctan(k' \tan \phi)$$

$$= \arcsin \left( (1 + k') \frac{\sin \phi \cos \phi}{\sqrt{1 - k^2 \sin^2 \phi}} \right).$$

(Note that  $0 < k < 1$  and  $0 < \phi < \pi/2$  imply  $k_1 < k$  and  $\phi < \phi_1 < 2\phi,$  and also that  $\phi = \pi/2$  implies  $\phi_1 = \pi.$ ) Then

$$19.8.12 \quad K(k) = (1 + k_1) K(k_1),$$

$$E(k) = (1 + k') E(k_1) - k' K(k).$$

$$19.8.13 \quad F(\phi, k) = \frac{1}{2}(1 + k_1) F(\phi_1, k_1),$$

$$E(\phi, k) = \frac{1}{2}(1 + k') E(\phi_1, k_1) - k' F(\phi, k)$$

$$+ \frac{1}{2}(1 - k') \sin \phi_1.$$

#### 19.8.14

$$2(k^2 - \alpha^2) \Pi(\phi, \alpha^2, k) = \frac{\omega^2 - \alpha^2}{1 + k'} \Pi(\phi_1, \alpha_1^2, k_1)$$

$$+ k^2 F(\phi, k)$$

$$- (1 + k') \alpha_1^2 R_C(c_1, c_1 - \alpha_1^2),$$

where

$$19.8.15 \quad \omega^2 = \frac{k^2 - \alpha^2}{1 - \alpha^2}, \quad \alpha_1^2 = \frac{\alpha^2 \omega^2}{(1 + k')^2}, \quad c_1 = \csc^2 \phi_1.$$

#### Ascending Landen Transformation

Let

$$19.8.16 \quad k_2 = 2\sqrt{k}/(1 + k),$$

$$2\phi_2 = \phi + \arcsin(k \sin \phi).$$

(Note that  $0 < k < 1$  and  $0 < \phi \leq \pi/2$  imply  $k < k_2 < 1$  and  $\phi_2 < \phi.$ ) Then

#### 19.8.17

$$F(\phi, k) = \frac{2}{1 + k} F(\phi_2, k_2),$$

$$E(\phi, k) = (1 + k) E(\phi_2, k_2) + (1 - k) F(\phi_2, k_2) - k \sin \phi.$$

### 19.8(iii) Gauss Transformation

We consider only the descending Gauss transformation because its (ascending) inverse moves  $F(\phi, k)$  closer to the singularity at  $k = \sin \phi = 1.$  Let

$$k_1 = (1 - k')/(1 + k'),$$

$$19.8.18 \quad \sin \psi_1 = \frac{(1 + k') \sin \phi}{1 + \Delta}, \quad \Delta = \sqrt{1 - k^2 \sin^2 \phi}.$$

(Note that  $0 < k < 1$  and  $0 < \phi < \pi/2$  imply  $k_1 < k$  and  $\psi_1 < \phi,$  and also that  $\phi = \pi/2$  implies  $\psi_1 = \pi/2,$  thus preserving completeness.) Then

#### 19.8.19

$$F(\phi, k) = (1 + k_1) F(\psi_1, k_1),$$

$$E(\phi, k) = (1 + k') E(\psi_1, k_1) - k' F(\phi, k) + (1 - \Delta) \cot \phi,$$

#### 19.8.20

$$\rho \Pi(\phi, \alpha^2, k) = \frac{4}{1 + k'} \Pi(\psi_1, \alpha_1^2, k_1)$$

$$+ (\rho - 1) F(\phi, k) - R_C(c - 1, c - \alpha^2),$$

where

$$19.8.21 \quad \rho = \sqrt{1 - (k^2/\alpha^2)},$$

$$\alpha_1^2 = \alpha^2(1 + \rho)^2/(1 + k')^2, \quad c = \csc^2 \phi.$$

If  $0 < \alpha^2 < k^2,$  then  $\rho$  is pure imaginary.

### 19.9 Inequalities

#### 19.9(i) Complete Integrals

Throughout this subsection  $0 < k < 1$ , except in (19.9.4).

$$19.9.1 \quad \ln 4 \leq K(k) + \ln k' \leq \pi/2, \quad 1 \leq E(k) \leq \pi/2.$$

$$1 \leq (2/\pi)\sqrt{1-\alpha^2}\Pi(\alpha^2, k) \leq 1/k', \quad \alpha^2 < 1.$$

$$19.9.2 \quad 1 + \frac{k'^2}{8} < \frac{K(k)}{\ln(4/k')} < 1 + \frac{k'^2}{4},$$

$$19.9.3 \quad 9 + \frac{k^2 k'^2}{8} < \frac{(8+k^2)K(k)}{\ln(4/k')} < 9.096.$$

The left-hand inequalities in (19.9.2) and (19.9.3) are equivalent, but the right-hand inequality of (19.9.3) is sharper than that of (19.9.2) when  $0 < k^2 \leq 0.922$ .

$$19.9.4 \quad \left(\frac{1+k'^{3/2}}{2}\right)^{2/3} \leq \frac{2}{\pi} E(k) \leq \left(\frac{1+k'^2}{2}\right)^{1/2}$$

for  $0 \leq k \leq 1$ . The lower bound in (19.9.4) is sharper than  $2/\pi$  when  $0 \leq k^2 \leq 0.9960$ .

$$19.9.5 \quad \ln \frac{(1+\sqrt{k'})^2}{k} < \frac{\pi K'(k)}{2K(k)} < \ln \frac{2(1+k')}{k}.$$

For a sharper, but more complicated, version of (19.9.5) see Anderson *et al.* (1990).

Other inequalities are:

$$19.9.6 \quad (1 - \frac{3}{4}k^2)^{-1/2} < \frac{4}{\pi k^2}(K(k) - E(k)) < (k')^{-3/4},$$

$$19.9.7 \quad (1 - \frac{1}{4}k^2)^{-1/2} < \frac{4}{\pi k^2}(E(k) - k'^2 K(k)) < \min((k')^{-1/4}, 4/\pi),$$

$$19.9.8 \quad k' < \frac{E(k)}{K(k)} < \left(\frac{1+k'}{2}\right)^2.$$

Further inequalities for  $K(k)$  and  $E(k)$  can be found in Alzer and Qiu (2004), Anderson *et al.* (1992a,b, 1997), and Qiu and Vamanamurthy (1996).

The perimeter  $L(a, b)$  of an ellipse with semiaxes  $a, b$  is given by

$$19.9.9 \quad L(a, b) = 4a E(k), \quad k^2 = 1 - (b^2/a^2), \quad a > b.$$

Almkvist and Berndt (1988) list thirteen approximations to  $L(a, b)$  that have been proposed by various authors. The earliest is due to Kepler and the most accurate to Ramanujan. Ramanujan's approximation and its leading error term yield the following approximation to  $L(a, b)/(\pi(a+b))$ :

$$19.9.10 \quad 1 + \frac{3\lambda^2}{10 + \sqrt{4-3\lambda^2}} + \frac{3\lambda^{10}}{2^{17}}, \quad \lambda = \frac{a-b}{a+b}.$$

Even for the extremely eccentric ellipse with  $a = 99$  and  $b = 1$ , this is correct within 0.023%. Barnard *et al.* (2000) shows that nine of the thirteen approximations, including Ramanujan's, are from below and four are from above. See also Barnard *et al.* (2001).

#### 19.9(ii) Incomplete Integrals

Throughout this subsection we assume that  $0 < k < 1$ ,  $0 \leq \phi \leq \pi/2$ , and  $\Delta = \sqrt{1 - k^2 \sin^2 \phi} > 0$ .

Simple inequalities for incomplete integrals follow directly from the defining integrals (§19.2(ii)) together with (19.6.12):

$$19.9.11 \quad \phi \leq F(\phi, k) \leq \min(\phi/\Delta, \text{gd}^{-1}(\phi)),$$

where  $\text{gd}^{-1}(\phi)$  is given by (4.23.41) and (4.23.42). Also,

$$19.9.12 \quad \max(\sin \phi, \phi\Delta) \leq E(\phi, k) \leq \phi,$$

$$19.9.13 \quad \Pi(\phi, \alpha^2, 0) \leq \Pi(\phi, \alpha^2, k) \leq \min(\Pi(\phi, \alpha^2, 0)/\Delta, \Pi(\phi, \alpha^2, 1)).$$

Sharper inequalities for  $F(\phi, k)$  are:

$$19.9.14 \quad \frac{3}{1 + \Delta + \cos \phi} < \frac{F(\phi, k)}{\sin \phi} < \frac{1}{(\Delta \cos \phi)^{1/3}},$$

$$19.9.15 \quad 1 < F(\phi, k) / \left( (\sin \phi) \ln \left( \frac{4}{\Delta + \cos \phi} \right) \right) < \frac{4}{2 + (1 + k^2) \sin^2 \phi}.$$

$$19.9.16 \quad F(\phi, k) = \frac{2}{\pi} K(k') \ln \left( \frac{4}{\Delta + \cos \phi} \right) - \theta \Delta^2, \quad (\sin \phi)/8 < \theta < (\ln 2)/(k^2 \sin \phi).$$

(19.9.15) is useful when  $k^2$  and  $\sin^2 \phi$  are both close to 1, since the bounds are then nearly equal; otherwise (19.9.14) is preferable.

Inequalities for both  $F(\phi, k)$  and  $E(\phi, k)$  involving inverse circular or inverse hyperbolic functions are given in Carlson (1961b, §4). For example,

$$19.9.17 \quad L \leq F(\phi, k) \leq \sqrt{UL} \leq \frac{1}{2}(U + L) \leq U,$$

where

$$19.9.18 \quad L = (1/\sigma) \operatorname{arctanh}(\sigma \sin \phi), \quad \sigma = \sqrt{(1+k^2)/2}, \\ U = \frac{1}{2} \operatorname{arctanh}(\sin \phi) + \frac{1}{2} k^{-1} \operatorname{arctanh}(k \sin \phi).$$

Other inequalities for  $F(\phi, k)$  can be obtained from inequalities for  $R_F(x, y, z)$  given in Carlson (1966, (2.15)) and Carlson (1970) via (19.25.5).

### 19.10 Relations to Other Functions

#### 19.10(i) Theta and Elliptic Functions

For relations of Legendre's integrals to theta functions, Jacobian functions, and Weierstrass functions, see §§20.9(i), 22.15(ii), and 23.6(iv), respectively. See also Erdélyi *et al.* (1953b, Chapter 13).

**19.10(ii) Elementary Functions**

If  $y > 0$  is assumed (without loss of generality), then

$$\begin{aligned} \ln(x/y) &= (x - y) R_C(\frac{1}{4}(x + y)^2, xy), \\ \arctan(x/y) &= x R_C(y^2, y^2 + x^2), \\ \text{19.10.1} \quad \operatorname{arctanh}(x/y) &= x R_C(y^2, y^2 - x^2), \\ \arcsin(x/y) &= x R_C(y^2 - x^2, y^2), \\ \operatorname{arcsinh}(x/y) &= x R_C(y^2 + x^2, y^2), \\ \arccos(x/y) &= (y^2 - x^2)^{1/2} R_C(x^2, y^2), \\ \operatorname{arccosh}(x/y) &= (x^2 - y^2)^{1/2} R_C(x^2, y^2). \end{aligned}$$

In each case when  $y = 1$ , the quantity multiplying  $R_C$  supplies the asymptotic behavior of the left-hand side as the left-hand side tends to 0.

For relations to the Gudermannian function  $\operatorname{gd}(x)$  and its inverse  $\operatorname{gd}^{-1}(x)$  (§4.23(viii)), see (19.6.8) and

**19.10.2**  $(\sinh \phi) R_C(1, \cosh^2 \phi) = \operatorname{gd}(\phi).$

**19.11 Addition Theorems**

**19.11(i) General Formulas**

**19.11.1**  $F(\theta, k) + F(\phi, k) = F(\psi, k),$   
**19.11.2**  $E(\theta, k) + E(\phi, k) = E(\psi, k) + k^2 \sin \theta \sin \phi \sin \psi.$

Here

**19.11.3** 
$$\sin \psi = \frac{(\sin \theta \cos \phi) \Delta(\phi) + (\sin \phi \cos \theta) \Delta(\theta)}{1 - k^2 \sin^2 \theta \sin^2 \phi},$$
  

$$\Delta(\theta) = \sqrt{1 - k^2 \sin^2 \theta}.$$

Also,

**19.11.4** 
$$\cos \psi = \frac{\cos \theta \cos \phi - (\sin \theta \sin \phi) \Delta(\theta) \Delta(\phi)}{1 - k^2 \sin^2 \theta \sin^2 \phi},$$
  

$$\tan(\frac{1}{2} \psi) = \frac{(\sin \theta) \Delta(\phi) + (\sin \phi) \Delta(\theta)}{\cos \theta + \cos \phi}.$$

Lastly,

**19.11.5** 
$$\Pi(\theta, \alpha^2, k) + \Pi(\phi, \alpha^2, k) = \Pi(\psi, \alpha^2, k) - \alpha^2 R_C(\gamma - \delta, \gamma),$$

where

**19.11.6** 
$$\gamma = ((\csc^2 \theta) - \alpha^2)((\csc^2 \phi) - \alpha^2)((\csc^2 \psi) - \alpha^2),$$
  

$$\delta = \alpha^2(1 - \alpha^2)(\alpha^2 - k^2).$$

**19.11(ii) Case  $\psi = \pi/2$**

**19.11.7**  $F(\phi, k) = K(k) - F(\theta, k),$

**19.11.8**  $E(\phi, k) = E(k) - E(\theta, k) + k^2 \sin \theta \sin \phi,$

where

**19.11.9**  $\tan \theta = 1/(k' \tan \phi).$

**19.11.10**

$\Pi(\phi, \alpha^2, k) = \Pi(\alpha^2, k) - \Pi(\theta, \alpha^2, k) - \alpha^2 R_C(\gamma - \delta, \gamma),$

where

**19.11.11** 
$$\gamma = (1 - \alpha^2)((\csc^2 \theta) - \alpha^2)((\csc^2 \phi) - \alpha^2),$$
  

$$\delta = \alpha^2(1 - \alpha^2)(\alpha^2 - k^2).$$

**19.11(iii) Duplication Formulas**

If  $\phi = \theta$  in §19.11(i) and  $\Delta(\theta)$  is again defined by (19.11.3), then

**19.11.12**  $F(\psi, k) = 2F(\theta, k),$

**19.11.13**  $E(\psi, k) = 2E(\theta, k) - k^2 \sin^2 \theta \sin \psi,$

**19.11.14**  $\sin \psi = (\sin 2\theta) \Delta(\theta) / (1 - k^2 \sin^4 \theta),$

$$\cos \psi = (\cos(2\theta) + k^2 \sin^4 \theta) / (1 - k^2 \sin^4 \theta),$$

$$\tan(\frac{1}{2} \psi) = (\tan \theta) \Delta(\theta),$$

$$\sin \theta = (\sin \psi) / \sqrt{(1 + \cos \psi)(1 + \Delta(\psi))},$$

**19.11.15**

$$\cos \theta = \sqrt{\frac{(\cos \psi) + \Delta(\psi)}{1 + \Delta(\psi)}},$$

$$\tan \theta = \tan(\frac{1}{2} \psi) \sqrt{\frac{1 + \cos \psi}{(\cos \psi) + \Delta(\psi)}},$$

**19.11.16**  $\Pi(\psi, \alpha^2, k) = 2\Pi(\theta, \alpha^2, k) + \alpha^2 R_C(\gamma - \delta, \gamma),$

**19.11.17** 
$$\gamma = ((\csc^2 \theta) - \alpha^2)^2((\csc^2 \psi) - \alpha^2),$$

$$\delta = \alpha^2(1 - \alpha^2)(\alpha^2 - k^2).$$

**19.12 Asymptotic Approximations**

With  $\psi(x)$  denoting the digamma function (§5.2(i)) in this subsection, the asymptotic behavior of  $K(k)$  and  $E(k)$  near the singularity at  $k = 1$  is given by the following convergent series:

**19.12.1**

$$K(k) = \sum_{m=0}^{\infty} \frac{(\frac{1}{2})_m (\frac{1}{2})_m}{m! m!} k'^{2m} \left( \ln \left( \frac{1}{k'} \right) + d(m) \right),$$

$$0 < |k'| < 1,$$



19.12.2

$$E(k) = 1 + \frac{1}{2} \sum_{m=0}^{\infty} \frac{\left(\frac{1}{2}\right)_m \left(\frac{3}{2}\right)_m}{(2)_m m!} k'^{2m+2} \times \left( \ln \left( \frac{1}{k'} \right) + d(m) - \frac{1}{(2m+1)(2m+2)} \right),$$

$|k'| < 1,$

where

19.12.3

$$d(m) = \psi(1+m) - \psi\left(\frac{1}{2} + m\right),$$

$$d(m+1) = d(m) - \frac{2}{(2m+1)(2m+2)}, \quad m = 0, 1, \dots$$

For the asymptotic behavior of  $F(\phi, k)$  and  $E(\phi, k)$  as  $\phi \rightarrow \frac{1}{2}\pi^-$  and  $k \rightarrow 1^-$  see Kaplan (1948, §2), Van de Vel (1969), and Karp and Sitnik (2007).

As  $k^2 \rightarrow 1^-$

19.12.4

$$(1 - \alpha^2) \Pi(\alpha^2, k)$$

$$= \left( \ln \frac{4}{k'} \right) \left( 1 + O(k'^2) \right) - \alpha^2 R_C(1, 1 - \alpha^2),$$

$-\infty < \alpha^2 < 1,$

19.12.5

$$(1 - \alpha^2) \Pi(\alpha^2, k)$$

$$= \left( \ln \left( \frac{4}{k'} \right) - R_C(1, 1 - \alpha^{-2}) \right) \left( 1 + O(k'^2) \right),$$

$1 < \alpha^2 < \infty.$

Asymptotic approximations for  $\Pi(\phi, \alpha^2, k)$ , with different variables, are given in Karp *et al.* (2007). They are useful primarily when  $(1 - k)/(1 - \sin \phi)$  is either small or large compared with 1.

If  $x \geq 0$  and  $y > 0$ , then

19.12.6

$$R_C(x, y) = \frac{\pi}{2\sqrt{y}} - \frac{\sqrt{x}}{y} \left( 1 + O\left(\sqrt{\frac{x}{y}}\right) \right), \quad x/y \rightarrow 0,$$

$$R_C(x, y) = \frac{1}{2\sqrt{x}} \left( \left( 1 + \frac{y}{2x} \right) \ln \left( \frac{4x}{y} \right) - \frac{y}{2x} \right)$$

19.12.7

$$\times (1 + O(y^2/x^2)), \quad y/x \rightarrow 0.$$

### 19.13 Integrals of Elliptic Integrals

#### 19.13(i) Integration with Respect to the Modulus

For definite and indefinite integrals of complete elliptic integrals see Byrd and Friedman (1971, pp. 610–612, 615), Prudnikov *et al.* (1990, §§1.11, 2.16), Glasser (1976), Bushell (1987), and Cvijović and Klinowski (1999).

For definite and indefinite integrals of incomplete elliptic integrals see Byrd and Friedman (1971, pp. 613, 616), Prudnikov *et al.* (1990, §§1.10.2, 2.15.2), and Cvijović and Klinowski (1994).

#### 19.13(ii) Integration with Respect to the Amplitude

Various integrals are listed by Byrd and Friedman (1971, p. 630) and Prudnikov *et al.* (1990, §§1.10.1, 2.15.1). Cvijović and Klinowski (1994) contains fractional integrals (with free parameters) for  $F(\phi, k)$  and  $E(\phi, k)$ , together with special cases.

#### 19.13(iii) Laplace Transforms

For direct and inverse Laplace transforms for the complete elliptic integrals  $K(k)$ ,  $E(k)$ , and  $D(k)$  see Prudnikov *et al.* (1992a, §3.31) and Prudnikov *et al.* (1992b, §§3.29 and 4.3.33), respectively.

### 19.14 Reduction of General Elliptic Integrals

#### 19.14(i) Examples

In (19.14.1)–(19.14.3) both the integrand and  $\cos \phi$  are assumed to be nonnegative. Cases in which  $\cos \phi < 0$  can be included by application of (19.2.10).

19.14.1

$$\int_1^x \frac{dt}{\sqrt{t^3 - 1}} = 3^{-1/4} F(\phi, k),$$

$$\cos \phi = \frac{\sqrt{3} + 1 - x}{\sqrt{3} - 1 + x}, \quad k^2 = \frac{2 - \sqrt{3}}{4}.$$

19.14.2

$$\int_x^1 \frac{dt}{\sqrt{1 - t^3}} = 3^{-1/4} F(\phi, k),$$

$$\cos \phi = \frac{\sqrt{3} - 1 + x}{\sqrt{3} + 1 - x}, \quad k^2 = \frac{2 + \sqrt{3}}{4}.$$

19.14.3

$$\int_0^x \frac{dt}{\sqrt{1 + t^4}} = \frac{\text{sign}(x)}{2} F(\phi, k),$$

$$\cos \phi = \frac{1 - x^2}{1 + x^2}, \quad k^2 = \frac{1}{2}.$$

19.14.4

$$\int_y^x \frac{dt}{\sqrt{(a_1 + b_1 t^2)(a_2 + b_2 t^2)}} = \frac{1}{\sqrt{\gamma - \alpha}} F(\phi, k),$$

$$k^2 = (\gamma - \beta)/(\gamma - \alpha).$$

In (19.14.4)  $0 \leq y < x$ , each quadratic polynomial is positive on the interval  $(y, x)$ , and  $\alpha, \beta, \gamma$  is a permutation of  $0, a_1 b_2, a_2 b_1$  (not all 0 by assumption) such that  $\alpha \leq \beta \leq \gamma$ . More generally in (19.14.4),

19.14.5 
$$\sin^2 \phi = \frac{\gamma - \alpha}{U^2 + \gamma},$$

where

19.14.6 
$$(x^2 - y^2)U = x\sqrt{(a_1 + b_1 y^2)(a_2 + b_2 y^2)} + y\sqrt{(a_1 + b_1 x^2)(a_2 + b_2 x^2)}.$$

There are four important special cases of (19.14.4)–(19.14.6), as follows. If  $y = 0$ , then

$$19.14.7 \quad \sin^2 \phi = \frac{(\gamma - \alpha)x^2}{a_1 a_2 + \gamma x^2}.$$

If  $x = \infty$ , then

$$19.14.8 \quad \sin^2 \phi = \frac{\gamma - \alpha}{b_1 b_2 y^2 + \gamma}.$$

If  $a_1 + b_1 y^2 = 0$ , then

$$19.14.9 \quad \sin^2 \phi = \frac{(\gamma - \alpha)(x^2 - y^2)}{\gamma(x^2 - y^2) - a_1(a_2 + b_2 x^2)}.$$

If  $a_1 + b_1 x^2 = 0$ , then

$$19.14.10 \quad \sin^2 \phi = \frac{(\gamma - \alpha)(y^2 - x^2)}{\gamma(y^2 - x^2) - a_1(a_2 + b_2 x^2)}.$$

(These four cases include 12 integrals in Abramowitz and Stegun (1964, p. 596).)

### 19.14(ii) General Case

Legendre (1825–1832) showed that every elliptic integral can be expressed in terms of the three integrals in (19.1.2) supplemented by algebraic, logarithmic, and trigonometric functions. The classical method of reducing (19.2.3) to Legendre’s integrals is described in many places, especially Erdélyi *et al.* (1953b, §13.5), Abramowitz and Stegun (1964, Chapter 17), and Labahn and Mutrie (1997, §3). The last reference gives a clear summary of the various steps involving linear fractional transformations, partial-fraction decomposition, and recurrence relations. It then improves the classical method by first applying Hermite reduction to (19.2.3) to arrive at integrands without multiple poles and uses implicit full partial-fraction decomposition and implicit root finding to minimize computing with algebraic extensions. The choice among 21 transformations for final reduction to Legendre’s normal form depends on inequalities involving the limits of integration and the zeros of the cubic or quartic polynomial. A similar remark applies to the transformations given in Erdélyi *et al.* (1953b, §13.5) and to the choice among explicit reductions in the extensive table of Byrd and Friedman (1971), in which one limit of integration is assumed to be a branch point of the integrand at which the integral converges. If no such branch point is accessible from the interval of integration (for example, if the integrand is  $(t(3-t)(4-t))^{-3/2}$  and the interval is  $[1, 2]$ ), then no method using this assumption succeeds.

## Symmetric Integrals

### 19.15 Advantages of Symmetry

Elliptic integrals are special cases of a particular multivariate hypergeometric function called Lauricella’s  $F_D$  (Carlson (1961b)). The function  $R_{-a}(b_1, b_2, \dots, b_n; z_1, z_2, \dots, z_n)$  (Carlson (1963)) reveals the full permutation symmetry that is partially hidden in  $F_D$ , and leads to symmetric standard integrals that simplify many aspects of theory, applications, and numerical computation.

Symmetry in  $x, y, z$  of  $R_F(x, y, z)$ ,  $R_G(x, y, z)$ , and  $R_J(x, y, z, p)$  replaces the five transformations (19.7.2), (19.7.4)–(19.7.7) of Legendre’s integrals; compare (19.25.17). Symmetry unifies the Landen transformations of §19.8(ii) with the Gauss transformations of §19.8(iii), as indicated following (19.22.22) and (19.36.9). (19.21.12) unifies the three transformations in §19.7(iii) that change the parameter of Legendre’s third integral.

Symmetry allows the expansion (19.19.7) in a series of elementary symmetric functions that gives high precision with relatively few terms and provides the most efficient method of computing the incomplete integral of the third kind (§19.36(i)).

Symmetry makes possible the reduction theorems of §19.29(i), permitting remarkable compression of tables of integrals while generalizing the interval of integration. (Compare (19.14.4)–(19.14.10) with (19.29.19), and see the last paragraph of §19.29(i) and the text following (19.29.15).) These reduction theorems, unknown in the Legendre theory, allow symbolic integration without imposing conditions on the parameters and the limits of integration (see §19.29(ii)).

For the many properties of ellipses and triaxial ellipsoids that can be represented by elliptic integrals, any symmetry in the semiaxes remains obvious when symmetric integrals are used (see (19.30.5) and §19.33). For example, the computation of depolarization factors for solid ellipsoids is simplified considerably; compare (19.33.7) with Cronmeyer (1991).

### 19.16 Definitions

#### 19.16(i) Symmetric Integrals

$$19.16.1 \quad R_F(x, y, z) = \frac{1}{2} \int_0^\infty \frac{dt}{s(t)},$$

$$19.16.2 \quad R_J(x, y, z, p) = \frac{3}{2} \int_0^\infty \frac{dt}{s(t)(t+p)},$$

19.16.3

$$R_G(x, y, z) = \frac{1}{4\pi} \int_0^{2\pi} \int_0^\pi (x \sin^2 \theta \cos^2 \phi + y \sin^2 \theta \sin^2 \phi + z \cos^2 \theta)^{\frac{1}{2}} \sin \theta \, d\theta \, d\phi,$$

where  $p (\neq 0)$  is a real or complex constant, and

19.16.4 
$$s(t) = \sqrt{t+x}\sqrt{t+y}\sqrt{t+z}.$$

In (19.16.1) and (19.16.2),  $x, y, z \in \mathbb{C} \setminus (-\infty, 0]$  except that one or more of  $x, y, z$  may be 0 when the corresponding integral converges. In (19.16.2) the Cauchy principal value is taken when  $p$  is real and negative. In (19.16.3)  $\Re x, \Re y, \Re z \geq 0$ . It should be noted that the integrals (19.16.1)–(19.16.3) have been normalized so that  $R_F(1, 1, 1) = R_J(1, 1, 1) = R_G(1, 1, 1) = 1$ .

A fourth integral that is symmetric in only two variables is defined by

19.16.5 
$$R_D(x, y, z) = R_J(x, y, z, z) = \frac{3}{2} \int_0^\infty \frac{dt}{s(t)(t+z)},$$

with the same conditions on  $x, y, z$  as for (19.16.1), but now  $z \neq 0$ .

Just as the elementary function  $R_C(x, y)$  (§19.2(iv)) is the degenerate case

19.16.6 
$$R_C(x, y) = R_F(x, y, y),$$

and  $R_D$  is a degenerate case of  $R_J$ , so is  $R_J$  a degenerate case of the *hyperelliptic integral*,

19.16.7 
$$\frac{3}{2} \int_0^\infty \frac{dt}{\prod_{j=1}^5 \sqrt{t+x_j}}.$$

19.16(ii)  $R_{-a}(\mathbf{b}; \mathbf{z})$

All elliptic integrals of the form (19.2.3) and many multiple integrals, including (19.16.3), are special cases of a multivariate hypergeometric function

19.16.8 
$$R_{-a}(\mathbf{b}; \mathbf{z}) = R_{-a}(b_1, \dots, b_n; z_1, \dots, z_n),$$

which is homogeneous and of *degree*  $-a$  in the  $z$ 's, and symmetric when the same permutation is applied to both sets of subscripts  $1, \dots, n$ . Thus  $R_{-a}(\mathbf{b}; \mathbf{z})$  is symmetric in the variables  $z_j$  and  $z_\ell$  if the parameters  $b_j$  and  $b_\ell$  are equal. The  $R$ -function is often used to make a unified statement of a property of several elliptic integrals. Before 1969  $R_{-a}(\mathbf{b}; \mathbf{z})$  was denoted by  $R(a; \mathbf{b}; \mathbf{z})$ .

19.16.9

$$\begin{aligned} R_{-a}(\mathbf{b}; \mathbf{z}) &= \frac{1}{B(a, a')} \int_0^\infty t^{a'-1} \prod_{j=1}^n (t+z_j)^{-b_j} dt \\ &= \frac{1}{B(a, a')} \int_0^\infty t^{a-1} \prod_{j=1}^n (1+tz_j)^{-b_j} dt, \\ & \quad a, a' > 0, z_j \in \mathbb{C} \setminus (-\infty, 0], \end{aligned}$$

where  $B(x, y)$  is the beta function (§5.12) and

19.16.10 
$$a' = -a + \sum_{j=1}^n b_j.$$

19.16.11 
$$\begin{aligned} R_{-a}(\mathbf{b}; \lambda \mathbf{z}) &= \lambda^{-a} R_{-a}(\mathbf{b}; \mathbf{z}), \\ R_{-a}(\mathbf{b}; x \mathbf{1}) &= x^{-a}, \quad \mathbf{1} = (1, \dots, 1). \end{aligned}$$

When  $n = 4$  a useful version of (19.16.9) is given by

19.16.12 
$$\begin{aligned} R_{-a}(b_1, \dots, b_4; c-1, c-k^2, c, c-\alpha^2) &= \frac{2(\sin^2 \phi)^{1-a'}}{B(a, a')} \int_0^\phi (\sin \theta)^{2a-1} (\sin^2 \phi - \sin^2 \theta)^{a'-1} \\ & \quad \times (\cos \theta)^{1-2b_1} (1-k^2 \sin^2 \theta)^{-b_2} (1-\alpha^2 \sin^2 \theta)^{-b_4} d\theta, \end{aligned}$$

where

19.16.13 
$$c = \csc^2 \phi; \quad a, a' > 0; \quad b_3 = a + a' - b_1 - b_2 - b_4.$$

For further information, especially representation of the  $R$ -function as a Dirichlet average, see Carlson (1977b).

19.16(iii) Elliptic Cases of  $R_{-a}(\mathbf{b}; \mathbf{z})$

$R_{-a}(\mathbf{b}; \mathbf{z})$  is an elliptic integral if the  $z$ 's are distinct and exactly four of the parameters  $a, a', b_1, \dots, b_n$  are half-odd-integers, the rest are integers, and none of  $a, a', a + a'$  is zero or a negative integer. The only cases that are integrals of the first kind are the four in which each of  $a$  and  $a'$  is either  $\frac{1}{2}$  or 1 and each  $b_j$  is  $\frac{1}{2}$ . The only cases that are integrals of the third kind are those in which at least one  $b_j$  is a positive integer. All other elliptic cases are integrals of the second kind.

19.16.14 
$$R_F(x, y, z) = R_{-\frac{1}{2}}\left(\frac{1}{2}, \frac{1}{2}, \frac{1}{2}; x, y, z\right),$$

19.16.15 
$$R_D(x, y, z) = R_{-\frac{3}{2}}\left(\frac{1}{2}, \frac{1}{2}, \frac{3}{2}; x, y, z\right),$$

19.16.16 
$$R_J(x, y, z, p) = R_{-\frac{3}{2}}\left(\frac{1}{2}, \frac{1}{2}, \frac{1}{2}, 1; x, y, z, p\right),$$

19.16.17 
$$R_G(x, y, z) = R_{\frac{1}{2}}\left(\frac{1}{2}, \frac{1}{2}, \frac{1}{2}; x, y, z\right),$$

19.16.18 
$$R_C(x, y) = R_{-\frac{1}{2}}\left(\frac{1}{2}, 1; x, y\right).$$

When one variable is 0 without destroying convergence, any one of (19.16.14)–(19.16.17) is said to be *complete* and can be written as an  $R$ -function with one less variable:

19.16.19 
$$\begin{aligned} &R_{-a}(b_1, \dots, b_n; 0, z_2, \dots, z_n) \\ &= \frac{B(a, a' - b_1)}{B(a, a')} R_{-a}(b_2, \dots, b_n; z_2, \dots, z_n), \\ & \quad a + a' > 0, a' > b_1. \end{aligned}$$

Thus

**19.16.20**  $R_F(0, y, z) = \frac{1}{2}\pi R_{-\frac{1}{2}}\left(\frac{1}{2}, \frac{1}{2}; y, z\right),$

**19.16.21**  $R_D(0, y, z) = \frac{3}{4}\pi R_{-\frac{3}{2}}\left(\frac{1}{2}, \frac{3}{2}; y, z\right),$

**19.16.22**  $R_J(0, y, z, p) = \frac{3}{4}\pi R_{-\frac{3}{2}}\left(\frac{1}{2}, \frac{1}{2}, 1; y, z, p\right),$

**19.16.23**  $R_G(0, y, z) = \frac{1}{4}\pi R_{\frac{1}{2}}\left(\frac{1}{2}, \frac{1}{2}; y, z\right)$   
 $= \frac{1}{4}\pi z R_{-\frac{1}{2}}\left(-\frac{1}{2}, \frac{3}{2}; y, z\right).$

The last  $R$ -function has  $a = a' = \frac{1}{2}$ .

Each of the four complete integrals (19.16.20)–(19.16.23) can be integrated to recover the incomplete integral:

**19.16.24**

$$R_{-a}(\mathbf{b}; \mathbf{z}) = \frac{z_1^{a'-b_1}}{\mathbb{B}(b_1, a' - b_1)} \int_0^\infty t^{b_1-1} (t + z_1)^{-a'} \times R_{-a}(\mathbf{b}; 0, t + z_2, \dots, t + z_n) dt,$$

$a' > b_1, a + a' > b_1 > 0.$

### 19.17 Graphics

See Figures 19.17.1–19.17.8 for symmetric elliptic integrals with real arguments.

Because the  $R$ -function is homogeneous, there is no loss of generality in giving one variable the value 1 or  $-1$  (as in Figure 19.3.2). For  $R_F, R_G,$  and  $R_J,$  which are symmetric in  $x, y, z,$  we may further assume that  $z$  is the largest of  $x, y, z$  if the variables are real, then choose  $z = 1,$  and consider only  $0 \leq x \leq 1$  and  $0 \leq y \leq 1.$  The cases  $x = 0$  or  $y = 0$  correspond to the complete integrals. The case  $y = 1$  corresponds to elementary functions.

To view  $R_F(0, y, 1)$  and  $2R_G(0, y, 1)$  for complex  $y,$  put  $y = 1 - k^2,$  use (19.25.1), and see Figures 19.3.7–19.3.8.

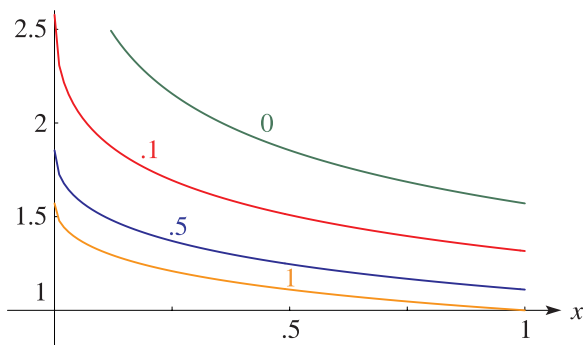


Figure 19.17.1:  $R_F(x, y, 1)$  for  $0 \leq x \leq 1, y = 0, 0.1, 0.5, 1.$   $y = 1$  corresponds to  $R_C(x, 1).$

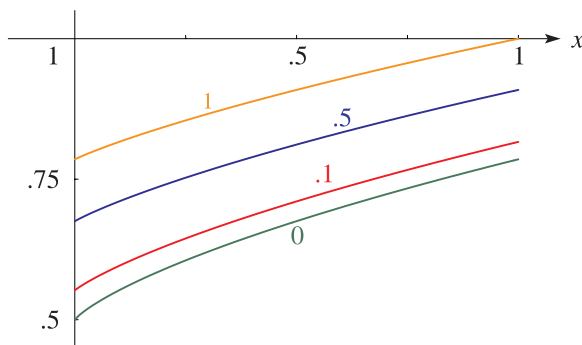


Figure 19.17.2:  $R_G(x, y, 1)$  for  $0 \leq x \leq 1, y = 0, 0.1, 0.5, 1.$   $y = 1$  corresponds to  $\frac{1}{2}(R_C(x, 1) + \sqrt{x}).$

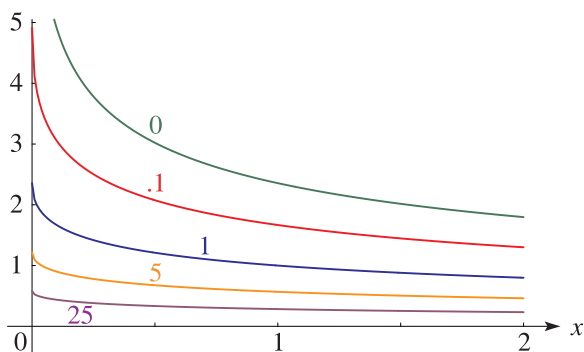


Figure 19.17.3:  $R_D(x, y, 1)$  for  $0 \leq x \leq 2, y = 0, 0.1, 1, 5, 25.$   $y = 1$  corresponds to  $\frac{3}{2}(R_C(x, 1) - \sqrt{x})/(1 - x), x \neq 1.$

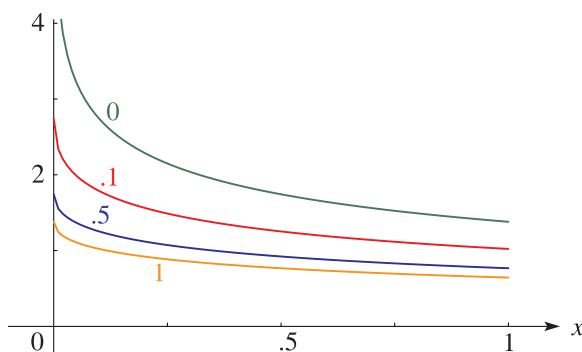


Figure 19.17.4:  $R_J(x, y, 1, 2)$  for  $0 \leq x \leq 1, y = 0, 0.1, 0.5, 1.$   $y = 1$  corresponds to  $3(R_C(x, 1) - R_C(x, 2)).$

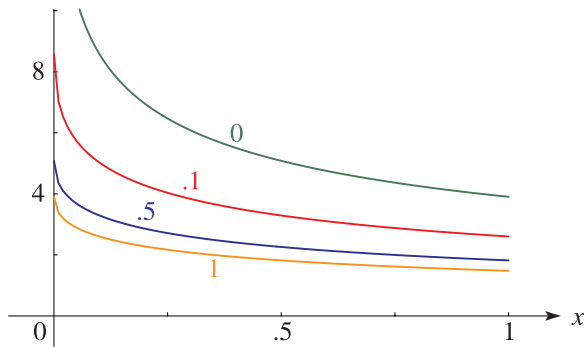


Figure 19.17.5:  $R_J(x, y, 1, 0.5)$  for  $0 \leq x \leq 1$ ,  $y = 0, 0.1, 0.5, 1$ .  $y = 1$  corresponds to  $6(R_C(x, 0.5) - R_C(x, 1))$ .

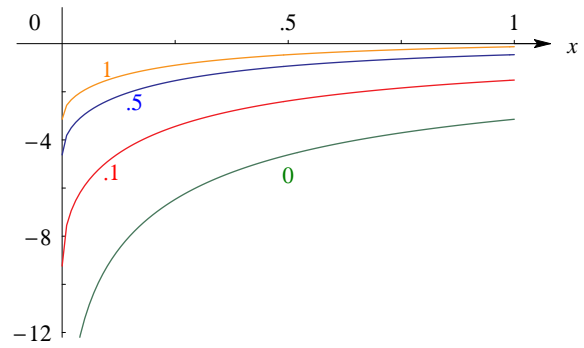


Figure 19.17.6: Cauchy principal value of  $R_J(x, y, 1, -0.5)$  for  $0 \leq x \leq 1$ ,  $y = 0, 0.1, 0.5, 1$ .  $y = 1$  corresponds to  $2(R_C(x, -0.5) - R_C(x, 1))$ .

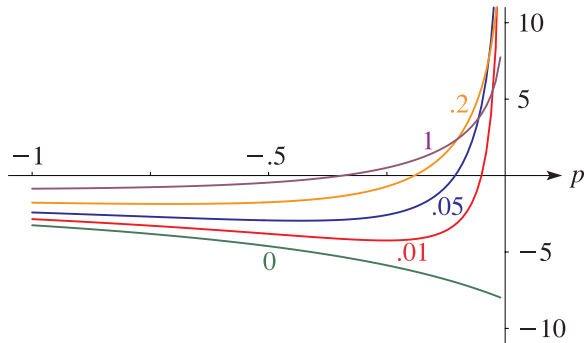


Figure 19.17.7: Cauchy principal value of  $R_J(0.5, y, 1, p)$  for  $y = 0, 0.01, 0.05, 0.2, 1$ ,  $-1 \leq p < 0$ .  $y = 1$  corresponds to  $3(R_C(0.5, p) - (\pi/\sqrt{8}))/ (1 - p)$ . As  $p \rightarrow 0$  the curve for  $y = 0$  has the finite limit  $-8.10386\dots$ ; see (19.20.10).

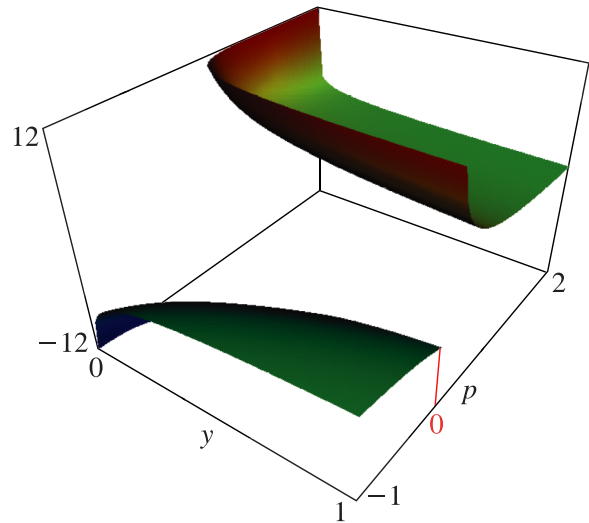


Figure 19.17.8:  $R_J(0, y, 1, p)$ ,  $0 \leq y \leq 1$ ,  $-1 \leq p \leq 2$ . Cauchy principal values are shown when  $p < 0$ . The function is asymptotic to  $\frac{3}{2}\pi/\sqrt{yp}$  as  $p \rightarrow 0+$ , and to  $(\frac{3}{2}/p)\ln(16/y)$  as  $y \rightarrow 0+$ . As  $p \rightarrow 0-$  it has the limit  $(-6/y)R_G(0, y, 1)$ . When  $p = 1$ , it reduces to  $R_D(0, y, 1)$ . If  $y = 1$ , then it has the value  $\frac{3}{2}\pi/(p + \sqrt{p})$  when  $p > 0$ , and  $\frac{3}{2}\pi/(p - 1)$  when  $p < 0$ . See (19.20.10), (19.20.11), and (19.20.8) for the cases  $p \rightarrow 0\pm$ ,  $y \rightarrow 0+$ , and  $y = 1$ , respectively.

## 19.18 Derivatives and Differential Equations

### 19.18(i) Derivatives

19.18.1 
$$\frac{\partial R_F(x, y, z)}{\partial z} = -\frac{1}{6} R_D(x, y, z),$$

19.18.2 
$$\frac{d}{dx} R_G(x + a, x + b, x + c) = \frac{1}{2} R_F(x + a, x + b, x + c).$$

Let  $\partial_j = \partial/\partial z_j$ , and  $\mathbf{e}_j$  be an  $n$ -tuple with 1 in the  $j$ th place and 0's elsewhere. Also define

19.18.3 
$$w_j = b_j \Big/ \sum_{j=1}^n b_j, \quad a' = -a + \sum_{j=1}^n b_j.$$

The next two equations apply to (19.16.14)–(19.16.18) and (19.16.20)–(19.16.23).

19.18.4 
$$\partial_j R_{-a}(\mathbf{b}; \mathbf{z}) = -aw_j R_{-a-1}(\mathbf{b} + \mathbf{e}_j; \mathbf{z}),$$

**19.18.5**  $(z_j \partial_j + b_j) R_{-a}(\mathbf{b}; \mathbf{z}) = w_j a' R_{-a}(\mathbf{b} + \mathbf{e}_j; \mathbf{z}).$

**19.18(ii) Differential Equations**

**19.18.6**  $\left(\frac{\partial}{\partial x} + \frac{\partial}{\partial y} + \frac{\partial}{\partial z}\right) R_F(x, y, z) = \frac{-1}{2\sqrt{xyz}},$

**19.18.7**  $\left(\frac{\partial}{\partial x} + \frac{\partial}{\partial y} + \frac{\partial}{\partial z}\right) R_G(x, y, z) = \frac{1}{2} R_F(x, y, z).$

**19.18.8**  $\sum_{j=1}^n \partial_j R_{-a}(\mathbf{b}; \mathbf{z}) = -a R_{-a-1}(\mathbf{b}; \mathbf{z}).$

**19.18.9**

$$\left(x \frac{\partial}{\partial x} + y \frac{\partial}{\partial y} + z \frac{\partial}{\partial z}\right) R_F(x, y, z) = -\frac{1}{2} R_F(x, y, z),$$

**19.18.10**

$$\left((x-y) \frac{\partial^2}{\partial x \partial y} + \frac{1}{2} \left(\frac{\partial}{\partial y} - \frac{\partial}{\partial x}\right)\right) R_F(x, y, z) = 0,$$

and two similar equations obtained by permuting  $x, y, z$  in (19.18.10).

More concisely, if  $v = R_{-a}(\mathbf{b}; \mathbf{z})$ , then each of (19.16.14)–(19.16.18) and (19.16.20)–(19.16.23) satisfies Euler’s homogeneity relation:

**19.18.11**  $\sum_{j=1}^n z_j \partial_j v = -av,$

and also a system of  $n(n-1)/2$  Euler–Poisson differential equations (of which only  $n-1$  are independent):

**19.18.12**  $(z_j \partial_j + b_j) \partial_l v = (z_l \partial_l + b_l) \partial_j v,$

or equivalently,

**19.18.13**  $((z_j - z_l) \partial_j \partial_l + b_j \partial_l - b_l \partial_j) v = 0.$

Here  $j, l = 1, 2, \dots, n$  and  $j \neq l$ . For group-theoretical aspects of this system see Carlson (1963, §VI). If  $n = 2$ , then elimination of  $\partial_2 v$  between (19.18.11) and (19.18.12), followed by the substitution  $(b_1, b_2, z_1, z_2) = (b, c - b, 1 - z, 1)$ , produces the Gauss hypergeometric equation (15.10.1).

---

**19.19.3**  $R_{-a}(\mathbf{b}; \mathbf{z}) = z_n^{-a} \sum_{N=0}^{\infty} \frac{(a)_N}{(c)_N} T_N(b_1, \dots, b_{n-1}; 1 - (z_1/z_n), \dots, 1 - (z_{n-1}/z_n)), \quad c = \sum_{j=1}^n b_j, \quad |1 - (z_j/z_n)| < 1.$

If  $n = 2$ , then (19.19.3) is a Gauss hypergeometric series (see (19.25.43) and (15.2.1)).

Define the elementary symmetric function  $E_s(\mathbf{z})$  by

**19.19.4**  $\prod_{j=1}^n (1 + tz_j) = \sum_{s=0}^n t^s E_s(\mathbf{z}),$

The next four differential equations apply to the complete case of  $R_F$  and  $R_G$  in the form  $R_{-a}(\frac{1}{2}, \frac{1}{2}; z_1, z_2)$  (see (19.16.20) and (19.16.23)).

The function  $w = R_{-a}(\frac{1}{2}, \frac{1}{2}; x + y, x - y)$  satisfies an Euler–Poisson–Darboux equation:

**19.18.14**  $\frac{\partial^2 w}{\partial x^2} = \frac{\partial^2 w}{\partial y^2} + \frac{1}{y} \frac{\partial w}{\partial y}.$

Also  $W = R_{-a}(\frac{1}{2}, \frac{1}{2}; t + r, t - r)$ , with  $r = \sqrt{x^2 + y^2}$ , satisfies a wave equation:

**19.18.15**  $\frac{\partial^2 W}{\partial t^2} = \frac{\partial^2 W}{\partial x^2} + \frac{\partial^2 W}{\partial y^2}.$

Similarly, the function  $u = R_{-a}(\frac{1}{2}, \frac{1}{2}; x + iy, x - iy)$  satisfies an equation of axially symmetric potential theory:

**19.18.16**  $\frac{\partial^2 u}{\partial x^2} + \frac{\partial^2 u}{\partial y^2} + \frac{1}{y} \frac{\partial u}{\partial y} = 0,$

and  $U = R_{-a}(\frac{1}{2}, \frac{1}{2}; z + i\rho, z - i\rho)$ , with  $\rho = \sqrt{x^2 + y^2}$ , satisfies Laplace’s equation:

**19.18.17**  $\frac{\partial^2 U}{\partial x^2} + \frac{\partial^2 U}{\partial y^2} + \frac{\partial^2 U}{\partial z^2} = 0.$

**19.19 Taylor and Related Series**

For  $N = 0, 1, 2, \dots$  define the homogeneous hypergeometric polynomial

**19.19.1**  $T_N(\mathbf{b}, \mathbf{z}) = \sum \frac{(b_1)_{m_1} \cdots (b_n)_{m_n}}{m_1! \cdots m_n!} z_1^{m_1} \cdots z_n^{m_n},$

where the summation extends over all nonnegative integers  $m_1, \dots, m_n$  whose sum is  $N$ . The following two multivariate hypergeometric series apply to each of the integrals (19.16.14)–(19.16.18) and (19.16.20)–(19.16.23):

**19.19.2**  $R_{-a}(\mathbf{b}; \mathbf{z}) = \sum_{N=0}^{\infty} \frac{(a)_N}{(c)_N} T_N(\mathbf{b}, \mathbf{1} - \mathbf{z}),$   
 $c = \sum_{j=1}^n b_j, \quad |1 - z_j| < 1,$

---

and define the  $n$ -tuple  $\frac{1}{2} = (\frac{1}{2}, \dots, \frac{1}{2})$ . Then

**19.19.5**

$$T_N(\frac{1}{2}, \mathbf{z}) = \sum (-1)^{M+N} \left(\frac{1}{2}\right)_M \frac{E_1^{m_1}(\mathbf{z}) \cdots E_n^{m_n}(\mathbf{z})}{m_1! \cdots m_n!},$$

where  $M = \sum_{j=1}^n m_j$  and the summation extends over all nonnegative integers  $m_1, \dots, m_n$  such that  $\sum_{j=1}^n j m_j = N$ .

This form of  $T_N$  can be applied to (19.16.14)–(19.16.18) and (19.16.20)–(19.16.23) if we use

**19.19.6**  $R_J(x, y, z, p) = R_{-\frac{3}{2}}(\frac{1}{2}, \frac{1}{2}, \frac{1}{2}, \frac{1}{2}; x, y, z, p, p)$  as well as (19.16.5) and (19.16.6). The number of terms in  $T_N$  can be greatly reduced by using variables  $\mathbf{Z} = \mathbf{1} - (\mathbf{z}/A)$  with  $A$  chosen to make  $E_1(\mathbf{Z}) = 0$ . Then  $T_N$  has at most one term if  $N \leq 5$  in the series for  $R_F$ . For  $R_J$  and  $R_D$ ,  $T_N$  has at most one term if  $N \leq 3$ , and two terms if  $N = 4$  or  $5$ .

**19.19.7**  $R_{-a}(\frac{1}{2}; \mathbf{z}) = A^{-a} \sum_{N=0}^{\infty} \frac{(a)_N}{(\frac{1}{2}n)_N} T_N(\frac{1}{2}, \mathbf{Z}),$

where

**19.19.8**  $A = \frac{1}{n} \sum_{j=1}^n z_j, \quad Z_j = 1 - (z_j/A),$   
 $E_1(\mathbf{Z}) = 0, \quad |Z_j| < 1.$

A special case is given in (19.36.1).

**19.20 Special Cases**

**19.20(i)  $R_F(x, y, z)$**

In this subsection, and also §§19.20(ii)–19.20(v), the variables of all  $R$ -functions satisfy the constraints specified in §19.16(i) unless other conditions are stated.

$R_F(x, x, x) = x^{-1/2},$   
 $R_F(\lambda x, \lambda y, \lambda z) = \lambda^{-1/2} R_F(x, y, z),$   
**19.20.1**  $R_F(x, y, y) = R_C(x, y),$   
 $R_F(0, y, y) = \frac{1}{2} \pi y^{-1/2},$   
 $R_F(0, 0, z) = \infty.$

The *first lemniscate constant* is given by

**19.20.2**  $\int_0^1 \frac{dt}{\sqrt{1-t^4}} = R_F(0, 1, 2) = \frac{(\Gamma(\frac{1}{4}))^2}{4(2\pi)^{1/2}}$   
 $= 1.31102\ 87771\ 46059\ 90523 \dots$

Todd (1975) refers to a proof by T. Schneider that this is a transcendental number. The *general lemniscatic case* is

**19.20.3**  $R_F(x, a, y) = R_{-\frac{1}{4}}(\frac{3}{4}, \frac{1}{2}; a^2, xy), \quad a = \frac{1}{2}(x + y).$

**19.20(ii)  $R_G(x, y, z)$**

$R_G(x, x, x) = x^{1/2},$   
 $R_G(\lambda x, \lambda y, \lambda z) = \lambda^{1/2} R_G(x, y, z),$   
**19.20.4**  $R_G(0, y, y) = \frac{1}{4} \pi y^{1/2},$   
 $R_G(0, 0, z) = \frac{1}{2} z^{1/2},$

**19.20.5**  $2R_G(x, y, y) = y R_C(x, y) + \sqrt{x}.$

**19.20(iii)  $R_J(x, y, z, p)$**

**19.20.6**

$R_J(x, x, x, x) = x^{-3/2},$   
 $R_J(\lambda x, \lambda y, \lambda z, \lambda p) = \lambda^{-3/2} R_J(x, y, z, p),$   
 $R_J(x, y, z, z) = R_D(x, y, z),$   
 $R_J(0, 0, z, p) = \infty,$   
 $R_J(x, x, x, p) = R_D(p, p, x) = \frac{3}{x-p} \left( R_C(x, p) - \frac{1}{\sqrt{x}} \right),$   
 $x \neq p, xp \neq 0.$

**19.20.7**

$R_J(x, y, z, p) \rightarrow +\infty, \quad p \rightarrow 0+ \text{ or } 0-; x, y, z > 0.$

**19.20.8**

$R_J(0, y, y, p) = \frac{3\pi}{2(y\sqrt{p} + p\sqrt{y})}, \quad p > 0,$   
 $R_J(0, y, y, -q) = \frac{-3\pi}{2\sqrt{y}(y+q)}, \quad q > 0,$   
 $R_J(x, y, y, p) = \frac{3}{p-y} (R_C(x, y) - R_C(x, p)), \quad p \neq y,$   
 $R_J(x, y, y, y) = R_D(x, y, y).$

**19.20.9**  $R_J(0, y, z, \pm\sqrt{yz}) = \pm \frac{3}{2\sqrt{yz}} R_F(0, y, z).$

**19.20.10**

$\lim_{p \rightarrow 0+} \sqrt{p} R_J(0, y, z, p) = \frac{3\pi}{2\sqrt{yz}},$   
 $\lim_{p \rightarrow 0-} R_J(0, y, z, p) = -R_D(0, y, z) - R_D(0, z, y)$   
 $= \frac{-6}{yz} R_G(0, y, z).$

**19.20.11**

$R_J(0, y, z, p) \sim \frac{3}{2p\sqrt{z}} \ln \left( \frac{16z}{y} \right), \quad y \rightarrow 0+; p (\neq 0) \text{ real.}$

**19.20.12**  $\lim_{p \rightarrow \pm\infty} p R_J(x, y, z, p) = 3R_F(x, y, z).$

**19.20.13**

$2(p-x) R_J(x, y, z, p) = 3R_F(x, y, z) - 3\sqrt{x} R_C(yz, p^2),$   
 $p = x \pm \sqrt{(y-x)(z-x)},$

where  $x, y, z$  may be permuted.

When the variables are real and distinct, the various cases of  $R_J(x, y, z, p)$  are called *circular (hyperbolic) cases* if  $(p-x)(p-y)(p-z)$  is positive (negative), because they typically occur in conjunction with inverse circular (hyperbolic) functions. Cases encountered in dynamical problems are usually circular; hyperbolic cases include Cauchy principal values. If  $x, y, z$  are permuted so that

$0 \leq x < y < z$ , then the Cauchy principal value of  $R_J$  is given by

$$\begin{aligned}
 & (q+z)R_J(x,y,z,-q) \\
 \mathbf{19.20.14} \quad & = (p-z)R_J(x,y,z,p) - 3R_F(x,y,z) \\
 & + 3\left(\frac{xyz}{xy+pq}\right)^{1/2} R_C(xy+pq,pq),
 \end{aligned}$$

valid when

$$\mathbf{19.20.15} \quad q > 0, \quad p = \frac{z(x+y+q)-xy}{z+q},$$

or

$$\mathbf{19.20.16} \quad p = wy + (1-w)z, \quad w = \frac{z-x}{z+q}, \quad 0 < w < 1.$$

Since  $x < y < p < z$ ,  $p$  is in a hyperbolic region. In the complete case ( $x = 0$ ) (19.20.14) reduces to

$$\begin{aligned}
 & (q+z)R_J(0,y,z,-q) \\
 \mathbf{19.20.17} \quad & = (p-z)R_J(0,y,z,p) - 3R_F(0,y,z), \\
 & p = z(y+q)/(z+q), \quad w = z/(z+q).
 \end{aligned}$$

### 19.20(iv) $R_D(x, y, z)$

$$R_D(x, x, x) = x^{-3/2},$$

$$\mathbf{19.20.18} \quad R_D(\lambda x, \lambda y, \lambda z) = \lambda^{-3/2} R_D(x, y, z),$$

$$R_D(0, y, y) = \frac{3}{4}\pi y^{-3/2},$$

$$R_D(0, 0, z) = \infty.$$

$$\mathbf{19.20.19} \quad R_D(x, y, z) \sim 3(xyz)^{-1/2}, \quad z/\sqrt{xy} \rightarrow 0.$$

$$\begin{aligned}
 \mathbf{19.20.20} \quad R_D(x, y, y) &= \frac{3}{2(y-x)} \left( R_C(x, y) - \frac{\sqrt{x}}{y} \right), \\
 &x \neq y, y \neq 0,
 \end{aligned}$$

### 19.20.21

$$R_D(x, x, z) = \frac{3}{z-x} \left( R_C(z, x) - \frac{1}{\sqrt{z}} \right), \quad x \neq z, xz \neq 0.$$

The *second lemniscate constant* is given by

$$\begin{aligned}
 \mathbf{19.20.22} \quad \int_0^1 \frac{t^2 dt}{\sqrt{1-t^4}} &= \frac{1}{3} R_D(0, 2, 1) = \frac{(\Gamma(\frac{3}{4}))^2}{(2\pi)^{1/2}} \\
 &= 0.59907\ 01173\ 67796\ 10371\dots
 \end{aligned}$$

Todd (1975) refers to a proof by T. Schneider that this is a transcendental number. Compare (19.20.2). The *general lemniscatic case* is

### 19.20.23

$$R_D(x, y, a) = R_{-\frac{3}{4}}\left(\frac{5}{4}, \frac{1}{2}; a^2, xy\right), \quad a = \frac{1}{2}x + \frac{1}{2}y.$$

### 19.20(v) $R_{-a}(\mathbf{b}; \mathbf{z})$

Define  $c = \sum_{j=1}^n b_j$ . Then

$$\begin{aligned}
 \mathbf{19.20.24} \quad R_0(\mathbf{b}; \mathbf{z}) &= 1, \quad R_N(\mathbf{b}; \mathbf{z}) = \frac{N!}{(c)_N} T_N(\mathbf{b}, \mathbf{z}), \\
 &N = 0, 1, 2, \dots,
 \end{aligned}$$

where  $T_N$  is defined by (19.19.1). Also,

$$\mathbf{19.20.25} \quad R_{-c}(\mathbf{b}; \mathbf{z}) = \prod_{j=1}^n z_j^{-b_j},$$

$$\mathbf{19.20.26} \quad R_{-a}(\mathbf{b}; \mathbf{z}) = \prod_{j=1}^n z_j^{-b_j} R_{-a'}(\mathbf{b}; \mathbf{z}^{-1}),$$

$$a + a' = c, \quad \mathbf{z}^{-1} = (z_1^{-1}, \dots, z_n^{-1}).$$

See also (19.16.11) and (19.16.19).

## 19.21 Connection Formulas

### 19.21(i) Complete Integrals

Legendre's relation (19.7.1) can be written

$$\begin{aligned}
 & R_F(0, z+1, z) R_D(0, z+1, 1) \\
 \mathbf{19.21.1} \quad & + R_D(0, z+1, z) R_F(0, z+1, 1) = 3\pi/(2z), \\
 & z \in \mathbb{C} \setminus (-\infty, 0].
 \end{aligned}$$

The case  $z = 1$  shows that the product of the two lemniscate constants, (19.20.2) and (19.20.22), is  $\pi/4$ .

$$\mathbf{19.21.2} \quad 3R_F(0, y, z) = z R_D(0, y, z) + y R_D(0, z, y).$$

### 19.21.3

$$\begin{aligned}
 6R_G(0, y, z) &= yz(R_D(0, y, z) + R_D(0, z, y)) \\
 &= 3z R_F(0, y, z) + z(y-z) R_D(0, y, z).
 \end{aligned}$$

The complete cases of  $R_F$  and  $R_G$  have connection formulas resulting from those for the Gauss hypergeometric function (Erdélyi *et al.* (1953a, §2.9)). Upper signs apply if  $0 < \text{ph } z < \pi$ , and lower signs if  $-\pi < \text{ph } z < 0$ :

$$\mathbf{19.21.4} \quad R_F(0, z-1, z) = R_F(0, 1-z, 1) \mp iR_F(0, z, 1),$$

### 19.21.5

$$\begin{aligned}
 2R_G(0, z-1, z) &= 2R_G(0, 1-z, 1) \pm i2R_G(0, z, 1) \\
 &+ (z-1)R_F(0, 1-z, 1) \\
 &\mp izR_F(0, z, 1).
 \end{aligned}$$

Let  $y, z$ , and  $p$  be positive and distinct, and permute  $y$  and  $z$  to ensure that  $y$  does not lie between  $z$  and  $p$ . The complete case of  $R_J$  can be expressed in terms of  $R_F$  and  $R_D$ :

### 19.21.6

$$\begin{aligned}
 (\sqrt{rp}/z) R_J(0, y, z, p) &= (r-1) R_F(0, y, z) R_D(p, rz, z) \\
 &+ R_D(0, y, z) R_F(p, rz, z), \\
 &r = (y-p)/(y-z) > 0.
 \end{aligned}$$

If  $0 < p < z$  and  $y = z+1$ , then as  $p \rightarrow 0$  (19.21.6) reduces to Legendre's relation (19.21.1).



**19.21(ii) Incomplete Integrals**

$R_D(x, y, z)$  is symmetric only in  $x$  and  $y$ , but either (nonzero)  $x$  or (nonzero)  $y$  can be moved to the third position by using

$$19.21.7 \quad (x - y) R_D(y, z, x) + (z - y) R_D(x, y, z) = 3R_F(x, y, z) - 3\sqrt{y/(xz)},$$

or the corresponding equation with  $x$  and  $y$  interchanged.

$$19.21.8 \quad R_D(y, z, x) + R_D(z, x, y) + R_D(x, y, z) = 3(xyz)^{-1/2},$$

$$19.21.9 \quad x R_D(y, z, x) + y R_D(z, x, y) + z R_D(x, y, z) = 3R_F(x, y, z).$$

**19.21.10**

$$2R_G(x, y, z) = z R_F(x, y, z) - \frac{1}{3}(x - z)(y - z) R_D(x, y, z) + \sqrt{xy/z}, \quad z \neq 0.$$

Because  $R_G$  is completely symmetric,  $x, y, z$  can be permuted on the right-hand side of (19.21.10) so that  $(x - z)(y - z) \leq 0$  if the variables are real, thereby avoiding cancellations when  $R_G$  is calculated from  $R_F$  and  $R_D$  (see §19.36(i)).

$$19.21.11 \quad 6R_G(x, y, z) = 3(x + y + z) R_F(x, y, z) - \sum x^2 R_D(y, z, x) = \sum x(y + z) R_D(y, z, x),$$

where both summations extend over the three cyclic permutations of  $x, y, z$ .

Connection formulas for  $R_{-a}(\mathbf{b}; \mathbf{z})$  are given in Carlson (1977b, pp. 99, 101, and 123–124).

**19.21(iii) Change of Parameter of  $R_J$**

Let  $x, y, z$  be real and nonnegative, with at most one of them 0. Change-of-parameter relations can be used to shift the parameter  $p$  of  $R_J$  from either circular region to the other, or from either hyperbolic region to the other (§19.20(iii)). The latter case allows evaluation of Cauchy principal values (see (19.20.14)).

$$19.21.12 \quad (p - x) R_J(x, y, z, p) + (q - x) R_J(x, y, z, q) = 3R_F(x, y, z) - 3R_C(\xi, \eta),$$

where

$$19.21.13 \quad (p - x)(q - x) = (y - x)(z - x), \quad \xi = yz/x, \quad \eta = pq/x, \quad \text{and } x, y, z \text{ may be permuted. Also,}$$

$$19.21.14 \quad \eta - \xi = p + q - y - z = \frac{(p - y)(p - z)}{p - x} = \frac{(q - y)(q - z)}{q - x} = \frac{(p - y)(q - y)}{x - y} = \frac{(p - z)(q - z)}{x - z}.$$

For each value of  $p$ , permutation of  $x, y, z$  produces three values of  $q$ , one of which lies in the same region as  $p$  and two lie in the other region of the same type. In (19.21.12), if  $x$  is the largest (smallest) of  $x, y$ , and  $z$ , then  $p$  and  $q$  lie in the same region if it is circular (hyperbolic); otherwise  $p$  and  $q$  lie in different regions, both circular or both hyperbolic. If  $x = 0$ , then  $\xi = \eta = \infty$  and  $R_C(\xi, \eta) = 0$ ; hence

**19.21.15**

$$p R_J(0, y, z, p) + q R_J(0, y, z, q) = 3R_F(0, y, z), \quad pq = yz.$$

**19.22 Quadratic Transformations**

**19.22(i) Complete Integrals**

Let  $\Re x > 0, \Re y > 0, a = (x + y)/2$ , and  $p \neq 0$ . Then

**19.22.1**

$$R_F(0, x^2, y^2) = R_F(0, xy, a^2),$$

**19.22.2**

$$2R_G(0, x^2, y^2) = 4R_G(0, xy, a^2) - xy R_F(0, xy, a^2),$$

**19.22.3**

$$2y^2 R_D(0, x^2, y^2) = \frac{1}{4}(y^2 - x^2) R_D(0, xy, a^2) + 3R_F(0, xy, a^2).$$

$$(p_{\pm}^2 - p_{\mp}^2) R_J(0, x^2, y^2, p^2)$$

**19.22.4**

$$= 2(p_{\pm}^2 - a^2) R_J(0, xy, a^2, p_{\pm}^2) - 3R_F(0, xy, a^2) + 3\pi/(2p),$$

where

$$19.22.5 \quad 2p_{\pm} = \sqrt{(p + x)(p + y)} \pm \sqrt{(p - x)(p - y)},$$

and hence

$$p_+ p_- = pa, \quad p_+^2 + p_-^2 = p^2 + xy,$$

**19.22.6**

$$p_+^2 - p_-^2 = \sqrt{(p^2 - x^2)(p^2 - y^2)}, \quad 4(p_{\pm}^2 - a^2) = (\sqrt{p^2 - x^2} \pm \sqrt{p^2 - y^2})^2.$$

**Bartky's Transformation**

$$2p^2 R_J(0, x^2, y^2, p^2) = v_+ v_- R_J(0, xy, a^2, v_{\pm}^2)$$

**19.22.7**

$$+ 3R_F(0, xy, a^2), \quad v_{\pm} = (p^2 \pm xy)/(2p).$$

If  $p = y$ , then (19.22.7) reduces to (19.22.3), but if  $p = x$  or  $p = y$ , then both sides of (19.22.4) are 0 by (19.20.9). If  $x < p < y$  or  $y < p < x$ , then  $p_+$  and  $p_-$  are complex conjugates.

**19.22(ii) Gauss’s Arithmetic-Geometric Mean (AGM)**

The AGM,  $M(a_0, g_0)$ , of two positive numbers  $a_0$  and  $g_0$  is defined in §19.8(i). Again, we assume that  $a_0 \geq g_0$  (except in (19.22.10)), and define  $c_n = \sqrt{a_n^2 - g_n^2}$ . Then

$$19.22.8 \quad \frac{2}{\pi} R_F(0, a_0^2, g_0^2) = \frac{1}{M(a_0, g_0)},$$

19.22.9

$$\begin{aligned} \frac{4}{\pi} R_G(0, a_0^2, g_0^2) &= \frac{1}{M(a_0, g_0)} \left( a_0^2 - \sum_{n=0}^{\infty} 2^{n-1} c_n^2 \right) \\ &= \frac{1}{M(a_0, g_0)} \left( a_1^2 - \sum_{n=2}^{\infty} 2^{n-1} c_n^2 \right), \end{aligned}$$

and

$$19.22.10 \quad R_D(0, g_0^2, a_0^2) = \frac{3\pi}{4M(a_0, g_0)a_0^2} \sum_{n=0}^{\infty} Q_n,$$

where

$$19.22.11 \quad Q_0 = 1, \quad Q_{n+1} = \frac{1}{2} Q_n \frac{a_n - g_n}{a_n + g_n}.$$

$Q_n$  has the same sign as  $a_0 - g_0$  for  $n \geq 1$ .

$$19.22.12 \quad R_J(0, g_0^2, a_0^2, p_0^2) = \frac{3\pi}{4M(a_0, g_0)p_0^2} \sum_{n=0}^{\infty} Q_n,$$

where  $p_0 > 0$  and

$$19.22.13 \quad \begin{aligned} p_{n+1} &= \frac{p_n^2 + a_n g_n}{2p_n}, \quad \varepsilon_n = \frac{p_n^2 - a_n g_n}{p_n^2 + a_n g_n}, \\ Q_0 &= 1, \quad Q_{n+1} = \frac{1}{2} Q_n \varepsilon_n. \end{aligned}$$

(If  $p_0 = a_0$ , then  $p_n = a_n$  and (19.22.13) reduces to (19.22.11).) As  $n \rightarrow \infty$ ,  $p_n$  and  $\varepsilon_n$  converge quadratically to  $M(a_0, g_0)$  and 0, respectively, and  $Q_n$  converges to 0 faster than quadratically. If the last variable of  $R_J$  is negative, then the Cauchy principal value is

$$19.22.14 \quad \begin{aligned} R_J(0, g_0^2, a_0^2, -q_0^2) &= \frac{-3\pi}{4M(a_0, g_0)(q_0^2 + a_0^2)} \\ &\times \left( 2 + \frac{a_0^2 - g_0^2}{q_0^2 + g_0^2} \sum_{n=0}^{\infty} Q_n \right), \end{aligned}$$

and (19.22.13) still applies, provided that

$$19.22.15 \quad p_0^2 = a_0^2(q_0^2 + g_0^2)/(q_0^2 + a_0^2).$$

**19.22(iii) Incomplete Integrals**

Let  $x, y$ , and  $z$  have positive real parts, assume  $p \neq 0$ , and retain (19.22.5) and (19.22.6). Define

$$19.22.16 \quad \begin{aligned} a &= (x + y)/2, \\ 2z_{\pm} &= \sqrt{(z + x)(z + y)} \pm \sqrt{(z - x)(z - y)}, \end{aligned}$$

so that

$$19.22.17 \quad \begin{aligned} z_+ z_- &= za, \quad z_+^2 + z_-^2 = z^2 + xy, \\ z_+^2 - z_-^2 &= \sqrt{(z^2 - x^2)(z^2 - y^2)}, \\ 4(z_{\pm}^2 - a^2) &= (\sqrt{z^2 - x^2} \pm \sqrt{z^2 - y^2})^2. \end{aligned}$$

Then

$$19.22.18 \quad R_F(x^2, y^2, z^2) = R_F(a^2, z_-^2, z_+^2),$$

19.22.19

$$\begin{aligned} (z_{\pm}^2 - z_{\mp}^2) R_D(x^2, y^2, z^2) &= 2(z_{\pm}^2 - a^2) R_D(a^2, z_{\mp}^2, z_{\pm}^2) \\ &\quad - 3R_F(x^2, y^2, z^2) + (3/z), \end{aligned}$$

19.22.20

$$\begin{aligned} (p_{\pm}^2 - p_{\mp}^2) R_J(x^2, y^2, z^2, p^2) &= 2(p_{\pm}^2 - a^2) R_J(a^2, z_{\mp}^2, z_{\pm}^2, p_{\pm}^2) \\ &\quad - 3R_F(x^2, y^2, z^2) + 3R_C(z^2, p^2), \end{aligned}$$

19.22.21

$$\begin{aligned} 2R_G(x^2, y^2, z^2) &= 4R_G(a^2, z_{\mp}^2, z_{\pm}^2) \\ &\quad - xy R_F(x^2, y^2, z^2) - z, \end{aligned}$$

19.22.22

$$R_C(x^2, y^2) = R_C(a^2, ay).$$

If  $x, y, z$  are real and positive, then (19.22.18)–(19.22.21) are ascending Landen transformations when  $x, y < z$  (implying  $a < z_- < z_+$ ), and descending Gauss transformations when  $z < x, y$  (implying  $z_+ < z_- < a$ ). Ascent and descent correspond respectively to increase and decrease of  $k$  in Legendre’s notation. Descending Gauss transformations include, as special cases, transformations of complete integrals into complete integrals; ascending Landen transformations do not.

If  $p = x$  or  $p = y$ , then (19.22.20) reduces to  $0 = 0$  by (19.20.13), and if  $z = x$  or  $z = y$  then (19.22.19) reduces to  $0 = 0$  by (19.20.20) and (19.22.22). If  $x < z < y$  or  $y < z < x$ , then  $z_+$  and  $z_-$  are complex conjugates. However, if  $x$  and  $y$  are complex conjugates and  $z$  and  $p$  are real, then the right-hand sides of all transformations in §§19.22(i) and 19.22(iii)—except (19.22.3) and (19.22.22)—are free of complex numbers and  $p_{\pm}^2 - p_{\mp}^2 = \pm|p^2 - x^2| \neq 0$ .

The transformations inverse to the ones just described are the descending Landen transformations and the ascending Gauss transformations. The equations inverse to (19.22.5) and (19.22.16) are given by

19.22.23

$$\begin{aligned} x + y &= 2a, \quad x - y = (2/a)\sqrt{(a^2 - z_+^2)(a^2 - z_-^2)}, \\ z &= z_+ z_- / a, \end{aligned}$$

and the corresponding equations with  $z, z_+$ , and  $z_-$  replaced by  $p, p_+$ , and  $p_-$ , respectively. These relations need to be used with caution because  $y$  is negative when  $0 < a < z_+ z_- (z_+^2 + z_-^2)^{-1/2}$ .

### 19.23 Integral Representations

In (19.23.1)–(19.23.3) we assume  $\Re y > 0$  and  $\Re z > 0$ .

**19.23.1**  $R_F(0, y, z) = \int_0^{\pi/2} (y \cos^2 \theta + z \sin^2 \theta)^{-1/2} d\theta,$

**19.23.2**  $R_G(0, y, z) = \frac{1}{2} \int_0^{\pi/2} (y \cos^2 \theta + z \sin^2 \theta)^{1/2} d\theta,$

**19.23.3**  $R_D(0, y, z) = 3 \int_0^{\pi/2} (y \cos^2 \theta + z \sin^2 \theta)^{-3/2} \sin^2 \theta d\theta.$

**19.23.4**  $R_F(0, y, z) = \frac{2}{\pi} \int_0^{\pi/2} R_C(y, z \cos^2 \theta) d\theta$   
 $= \frac{2}{\pi} \int_0^\infty R_C(y \cosh^2 t, z) dt.$

**19.23.5**

$$R_F(x, y, z) = \frac{2}{\pi} \int_0^{\pi/2} R_C(x, y \cos^2 \theta + z \sin^2 \theta) d\theta,$$

$\Re y > 0, \Re z > 0,$

**19.23.6**

$$4\pi R_F(x, y, z) = \int_0^{2\pi} \int_0^\pi \frac{\sin \theta d\theta d\phi}{(x \sin^2 \theta \cos^2 \phi + y \sin^2 \theta \sin^2 \phi + z \cos^2 \theta)^{1/2}},$$

where  $x, y,$  and  $z$  have positive real parts—except that at most one of them may be 0.

In (19.23.7)–(19.23.10) one or more of the variables may be 0 if the integral converges. In (19.23.8)  $n = 2,$  and in (19.23.9)  $n = 3.$  Also, in (19.23.8) and (19.23.10)  $B$  denotes the beta function (§5.12).

**19.23.7**  $R_G(x, y, z) = \frac{1}{4} \int_0^\infty \frac{1}{\sqrt{t+x}\sqrt{t+y}\sqrt{t+z}} \left( \frac{x}{t+x} + \frac{y}{t+y} + \frac{z}{t+z} \right) t dt, \quad x, y, z \in \mathbb{C} \setminus (-\infty, 0].$

**19.23.8**  $R_{-a}(\mathbf{b}; \mathbf{z}) = \frac{2}{B(b_1, b_2)} \int_0^{\pi/2} (z_1 \cos^2 \theta + z_2 \sin^2 \theta)^{-a} (\cos \theta)^{2b_1-1} (\sin \theta)^{2b_2-1} d\theta, \quad b_1, b_2 > 0; \Re z_1, \Re z_2 > 0.$

With  $l_1, l_2, l_3$  denoting any permutation of  $\sin \theta \cos \phi, \sin \theta \sin \phi, \cos \theta,$

**19.23.9**  $R_{-a}(\mathbf{b}; \mathbf{z}) = \frac{4\Gamma(b_1 + b_2 + b_3)}{\Gamma(b_1)\Gamma(b_2)\Gamma(b_3)} \int_0^{\pi/2} \int_0^{\pi/2} \left( \sum_{j=1}^3 z_j l_j^2 \right)^{-a} \prod_{j=1}^3 l_j^{2b_j-1} \sin \theta d\theta d\phi, \quad b_j > 0, \Re z_j > 0.$

**19.23.10**

$$R_{-a}(\mathbf{b}; \mathbf{z}) = \frac{1}{B(a, a')} \int_0^1 u^{a-1} (1-u)^{a'-1} \prod_{j=1}^n (1-uz_j)^{-b_j} du, \quad a, a' > 0; a + a' = \sum_{j=1}^n b_j; z_j \in \mathbb{C} \setminus (-\infty, 0].$$

For generalizations of (19.16.3) and (19.23.8) see Carlson (1964, (6.2), (6.12), and (6.1)).

### 19.24 Inequalities

#### 19.24(i) Complete Integrals

The condition  $y \leq z$  for (19.24.1) and (19.24.2) serves only to identify  $y$  as the smaller of the two nonzero variables of a symmetric function; it does not restrict validity.

**19.24.1**

$$\ln 4 \leq \sqrt{z} R_F(0, y, z) + \ln \sqrt{y/z} \leq \frac{1}{2}\pi, \quad 0 < y \leq z,$$

**19.24.2**  $\frac{1}{2} \leq z^{-1/2} R_G(0, y, z) \leq \frac{1}{4}\pi, \quad 0 \leq y \leq z,$

**19.24.3**

$$\left( \frac{y^{3/2} + z^{3/2}}{2} \right)^{2/3} \leq \frac{4}{\pi} R_G(0, y^2, z^2) \leq \left( \frac{y^2 + z^2}{2} \right)^{1/2},$$

$y > 0, z > 0.$

If  $y, z,$  and  $p$  are positive, then

**19.24.4**

$$\frac{2}{\sqrt{p}} (2yz + yp + zp)^{-1/2} \leq \frac{4}{3\pi} R_J(0, y, z, p) \leq (yzp^2)^{-3/8}.$$

Inequalities for  $R_D(0, y, z)$  are included as the case  $p = z.$

A series of successively sharper inequalities is obtained from the AGM process (§19.8(i)) with  $a_0 \geq g_0 > 0:$

**19.24.5**  $\frac{1}{a_n} \leq \frac{2}{\pi} R_F(0, a_0^2, g_0^2) \leq \frac{1}{g_n}, \quad n = 0, 1, 2, \dots,$

where

**19.24.6**  $a_{n+1} = (a_n + g_n)/2, \quad g_{n+1} = \sqrt{a_n g_n}.$

Other inequalities can be obtained by applying Carlson (1966, Theorems 2 and 3) to (19.16.20)–(19.16.23). Approximations and one-sided inequalities for  $R_G(0, y, z)$  follow from those given in §19.9(i) for the length  $L(a, b)$  of an ellipse with semiaxes  $a$  and  $b,$  since

**19.24.7**  $L(a, b) = 8R_G(0, a^2, b^2).$

For  $x > 0$ ,  $y > 0$ , and  $x \neq y$ , the complete cases of  $R_F$  and  $R_G$  satisfy

$$19.24.8 \quad \begin{aligned} R_F(x, y, 0) R_G(x, y, 0) &> \frac{1}{8} \pi^2, \\ R_F(x, y, 0) + 2R_G(x, y, 0) &> \pi. \end{aligned}$$

Also, with the notation of (19.24.6),

$$19.24.9 \quad \frac{1}{2} g_1^2 \leq \frac{R_G(a_0^2, g_0^2, 0)}{R_F(a_0^2, g_0^2, 0)} \leq \frac{1}{2} a_1^2,$$

with equality iff  $a_0 = g_0$ .

### 19.24(ii) Incomplete Integrals

Inequalities for  $R_{-a}(\mathbf{b}; \mathbf{z})$  in Carlson (1966, Theorems 2 and 3) can be applied to (19.16.14)–(19.16.17). All variables are positive, and equality occurs iff all variables are equal.

#### Examples

$$19.24.10 \quad \frac{3}{\sqrt{x} + \sqrt{y} + \sqrt{z}} \leq R_F(x, y, z) \leq \frac{1}{(xyz)^{1/6}},$$

$$19.24.11 \quad \left( \frac{5}{\sqrt{x} + \sqrt{y} + \sqrt{z} + 2\sqrt{p}} \right)^3 \leq R_J(x, y, z, p) \leq (xyzp^2)^{-3/10},$$

$$19.24.12 \quad \begin{aligned} \frac{1}{3}(\sqrt{x} + \sqrt{y} + \sqrt{z}) \\ \leq R_G(x, y, z) \leq \min \left( \sqrt{\frac{x+y+z}{3}}, \frac{x^2+y^2+z^2}{3\sqrt{xyz}} \right). \end{aligned}$$

Inequalities for  $R_C(x, y)$  and  $R_D(x, y, z)$  are included as special cases (see (19.16.6) and (19.16.5)).

Other inequalities for  $R_F(x, y, z)$  are given in Carlson (1970).

If  $a (\neq 0)$  is real, all components of  $\mathbf{b}$  and  $\mathbf{z}$  are positive, and the components of  $z$  are not all equal, then

$$19.24.13 \quad R_a(\mathbf{b}; \mathbf{z}) R_{-a}(\mathbf{b}; \mathbf{z}) > 1, \quad R_a(\mathbf{b}; \mathbf{z}) + R_{-a}(\mathbf{b}; \mathbf{z}) > 2;$$

see Neuman (2003, (2.13)). Special cases with  $a = \pm \frac{1}{2}$  are (19.24.8) (because of (19.16.20), (19.16.23)), and

$$19.24.14 \quad \begin{aligned} R_F(x, y, z) R_G(x, y, z) &> 1, \\ R_F(x, y, z) + R_G(x, y, z) &> 2. \end{aligned}$$

The same reference also gives upper and lower bounds for symmetric integrals in terms of their elementary degenerate cases. These bounds include a sharper but more complicated lower bound than that supplied in the next result:

$$19.24.15 \quad R_C(x, \frac{1}{2}(y+z)) \leq R_F(x, y, z) \leq R_C(x, \sqrt{yz}), \quad x \geq 0,$$

with equality iff  $y = z$ .

## 19.25 Relations to Other Functions

### 19.25(i) Legendre's Integrals as Symmetric Integrals

Let  $k'^2 = 1 - k^2$  and  $c = \csc^2 \phi$ . Then

#### 19.25.1

$$\begin{aligned} K(k) &= R_F(0, k'^2, 1), \quad E(k) = 2R_G(0, k'^2, 1), \\ E(k) &= \frac{1}{3}k'^2 \left( R_D(0, k'^2, 1) + R_D(0, 1, k'^2) \right), \\ K(k) - E(k) &= k^2 D(k) = \frac{1}{3}k^2 R_D(0, k'^2, 1), \\ E(k) - k'^2 K(k) &= \frac{1}{3}k^2 k'^2 R_D(0, 1, k'^2). \end{aligned}$$

$$19.25.2 \quad \Pi(\alpha^2, k) - K(k) = \frac{1}{3}\alpha^2 R_J(0, k'^2, 1, 1 - \alpha^2).$$

$$19.25.3 \quad \Pi(\alpha^2, k) = \frac{1}{2}\pi R_{-\frac{1}{2}}\left(\frac{1}{2}, -\frac{1}{2}, 1; k'^2, 1, 1 - \alpha^2\right),$$

with Cauchy principal value

#### 19.25.4

$$\Pi(\alpha^2, k) = -\frac{1}{3}(k^2/\alpha^2) R_J(0, 1 - k^2, 1, 1 - (k^2/\alpha^2)),$$

$-\infty < k^2 < 1 < \alpha^2$ .

$$19.25.5 \quad F(\phi, k) = R_F(c - 1, c - k^2, c),$$

$$19.25.6 \quad \frac{\partial F(\phi, k)}{\partial k} = \frac{1}{3}k R_D(c - 1, c, c - k^2).$$

$$E(\phi, k) = 2R_G(c - 1, c - k^2, c)$$

$$19.25.7 \quad \begin{aligned} &-(c - 1) R_F(c - 1, c - k^2, c) \\ &-\sqrt{(c - 1)(c - k^2)/c}, \end{aligned}$$

$$19.25.8 \quad E(\phi, k) = R_{-\frac{1}{2}}\left(\frac{1}{2}, -\frac{1}{2}, \frac{3}{2}; c - 1, c - k^2, c\right),$$

#### 19.25.9

$$\begin{aligned} E(\phi, k) \\ = R_F(c - 1, c - k^2, c) - \frac{1}{3}k^2 R_D(c - 1, c - k^2, c), \end{aligned}$$

$$E(\phi, k) = k'^2 R_F(c - 1, c - k^2, c)$$

$$19.25.10 \quad \begin{aligned} &+ \frac{1}{3}k^2 k'^2 R_D(c - 1, c, c - k^2) \\ &+ k^2 \sqrt{(c - 1)/(c(c - k^2))}, \quad c > k^2, \end{aligned}$$

$$19.25.11 \quad \begin{aligned} E(\phi, k) &= -\frac{1}{3}k'^2 R_D(c - k^2, c, c - 1) \\ &+ \sqrt{(c - k^2)/(c(c - 1))}, \quad \phi \neq \frac{1}{2}\pi. \end{aligned}$$

Equations (19.25.9)–(19.25.11) correspond to three (nonzero) choices for the last variable of  $R_D$ ; see (19.21.7). All terms on the right-hand sides are non-negative when  $k^2 \leq 0$ ,  $0 \leq k^2 \leq 1$ , or  $1 \leq k^2 \leq c$ , respectively.

$$19.25.12 \quad \frac{\partial E(\phi, k)}{\partial k} = -\frac{1}{3}k R_D(c - 1, c - k^2, c).$$

$$19.25.13 \quad D(\phi, k) = \frac{1}{3} R_D(c - 1, c - k^2, c).$$

#### 19.25.14

$$\Pi(\phi, \alpha^2, k) - F(\phi, k) = \frac{1}{3}\alpha^2 R_J(c - 1, c - k^2, c, c - \alpha^2),$$

#### 19.25.15

$$\Pi(\phi, \alpha^2, k) = R_{-\frac{1}{2}}\left(\frac{1}{2}, \frac{1}{2}, -\frac{1}{2}, 1; c - 1, c - k^2, c, c - \alpha^2\right).$$

If  $\alpha^2 > c$ , then the Cauchy principal value is

**19.25.16**

$$\begin{aligned} & \Pi(\phi, \alpha^2, k) \\ &= -\frac{1}{3}\omega^2 R_J(c-1, c-k^2, c, c-\omega^2) \\ &+ \sqrt{\frac{(c-1)(c-k^2)}{(\alpha^2-1)(1-\omega^2)}} \\ &\times R_C(c(\alpha^2-1)(1-\omega^2), (\alpha^2-c)(c-\omega^2)), \\ & \qquad \qquad \qquad \omega^2 = k^2/\alpha^2. \end{aligned}$$

The transformations in §19.7(ii) result from the symmetry and homogeneity of functions on the right-hand sides of (19.25.5), (19.25.7), and (19.25.14). For example, if we write (19.25.5) as

**19.25.17**  $F(\phi, k) = R_F(x, y, z),$

with

**19.25.18**  $(x, y, z) = (c-1, c-k^2, c),$

then the five nontrivial permutations of  $x, y, z$  that leave  $R_F$  invariant change  $k^2 (= (z-y)/(z-x))$  into  $1/k^2, k'^2, 1/k'^2, -k^2/k'^2, -k'^2/k^2$ , and  $\sin \phi (= \sqrt{(z-x)/z})$  into  $k \sin \phi, -i \tan \phi, -ik' \tan \phi, (k' \sin \phi)/\sqrt{1-k^2 \sin^2 \phi}, -ik \sin \phi/\sqrt{1-k^2 \sin^2 \phi}$ . Thus the five permutations induce five transformations of Legendre's integrals (and also of the Jacobian elliptic functions).

The three changes of parameter of  $\Pi(\phi, \alpha^2, k)$  in §19.7(iii) are unified in (19.21.12) by way of (19.25.14).

**19.25(ii) Bulirsch's Integrals as Symmetric Integrals**

Let  $r = 1/x^2$ . Then

**19.25.19**

$$\begin{aligned} \text{cel}(k_c, p, a, b) &= a R_F(0, k_c^2, 1) \\ &+ \frac{1}{3}(b-pa) R_J(0, k_c^2, 1, p), \end{aligned}$$

**19.25.20**

$$\text{ell}(x, k_c) = R_F(r, r+k_c^2, r+1),$$

**19.25.21**

$$\begin{aligned} \text{el2}(x, k_c, a, b) &= a \text{ell}(x, k_c) \\ &+ \frac{1}{3}(b-a) R_D(r, r+k_c^2, r+1), \end{aligned}$$

**19.25.22**

$$\begin{aligned} \text{el3}(x, k_c, p) &= \text{el1}(x, k_c) \\ &+ \frac{1}{3}(1-p) R_J(r, r+k_c^2, r+1, r+p). \end{aligned}$$

**19.25(iii) Symmetric Integrals as Legendre's Integrals**

Assume  $0 \leq x \leq y \leq z, x < z$ , and  $p > 0$ . Let

**19.25.23**

$$\begin{aligned} \phi &= \arccos \sqrt{x/z} = \arcsin \sqrt{(z-x)/z}, \\ k &= \sqrt{\frac{z-y}{z-x}}, \quad \alpha^2 = \frac{z-p}{z-x}, \end{aligned}$$

with  $\alpha \neq 0$ . Then

**19.25.24**  $(z-x)^{1/2} R_F(x, y, z) = F(\phi, k),$

**19.25.25**

$$(z-x)^{3/2} R_D(x, y, z) = (3/k^2)(F(\phi, k) - E(\phi, k)),$$

**19.25.26**

$$(z-x)^{3/2} R_J(x, y, z, p) = (3/\alpha^2)(\Pi(\phi, \alpha^2, k) - F(\phi, k)),$$

**19.25.27**

$$\begin{aligned} 2(z-x)^{-1/2} R_G(x, y, z) &= E(\phi, k) + (\cot \phi)^2 F(\phi, k) \\ &+ (\cot \phi) \sqrt{1-k^2 \sin^2 \phi}. \end{aligned}$$

**19.25(iv) Theta Functions**

For relations of symmetric integrals to theta functions, see §20.9(i).

**19.25(v) Jacobian Elliptic Functions**

For the notation see §§22.2, 22.15, and 22.16(i).

With  $0 \leq k^2 \leq 1$  and  $p, q, r$  any permutation of the letters  $c, d, n$ , define

**19.25.28**  $\Delta(p, q) = \text{ps}^2(u, k) - \text{qs}^2(u, k) = -\Delta(q, p),$   
which implies

**19.25.29**  $\Delta(n, d) = k^2, \quad \Delta(d, c) = k'^2, \quad \Delta(n, c) = 1.$

If  $\text{cs}^2(u, k) \geq 0$ , then

**19.25.30**  $\text{am}(u, k) = R_C(\text{cs}^2(u, k), \text{ns}^2(u, k)),$

**19.25.31**  $u = R_F(\text{ps}^2(u, k), \text{qs}^2(u, k), \text{rs}^2(u, k));$   
compare (19.25.35) and (20.9.3).

**19.25.32**

$$\text{arcps}(x, k) = R_F(x^2, x^2 + \Delta(q, p), x^2 + \Delta(r, p)),$$

**19.25.33**

$$\text{arccsp}(x, k) = x R_F(1, 1 + \Delta(q, p)x^2, 1 + \Delta(r, p)x^2),$$

**19.25.34**

$$\begin{aligned} \text{arcpq}(x, k) &= \sqrt{w} R_F(x^2, 1, 1 + \Delta(r, q)w), \\ w &= (1-x^2)/\Delta(q, p), \end{aligned}$$

where we assume  $0 \leq x^2 \leq 1$  if  $x = \text{sn}, \text{cn},$  or  $\text{cd}$ ;  $x^2 \geq 1$  if  $x = \text{ns}, \text{nc},$  or  $\text{dc}$ ;  $x$  real if  $x = \text{cs}$  or  $\text{sc}$ ;  $k' \leq x \leq 1$  if  $x = \text{dn}$ ;  $1 \leq x \leq 1/k'$  if  $x = \text{nd}$ ;  $x^2 \geq k'^2$  if  $x = \text{ds}$ ;  $0 \leq x^2 \leq 1/k'^2$  if  $x = \text{sd}$ .

For the use of  $R$ -functions with  $\Delta(p, q)$  in unifying other properties of Jacobian elliptic functions, see Carlson (2004, 2006a,b, 2008).

Inversions of 12 elliptic integrals of the first kind, producing the 12 Jacobian elliptic functions, are combined and simplified by using the properties of  $R_F(x, y, z)$ . See (19.29.19), Carlson (2005), and (22.15.11), and compare with Abramowitz and Stegun (1964, Eqs. (17.4.41)–(17.4.52)). For analogous integrals of the second kind, which are not invertible in terms of single-valued functions, see (19.29.20) and (19.29.21) and compare with Gradshteyn and Ryzhik (2000, §3.153,1–10 and §3.156,1–9).

**19.25(vi) Weierstrass Elliptic Functions**

For the notation see §23.2.

$$19.25.35 \quad z = R_F(\wp(z) - e_1, \wp(z) - e_2, \wp(z) - e_3),$$

provided that

$$19.25.36 \quad \wp(z) - e_j \in \mathbb{C} \setminus (-\infty, 0], \quad j = 1, 2, 3,$$

and the left-hand side does not vanish for more than one value of  $j$ . Also,

$$19.25.37 \quad \zeta(z) + z\wp(z) = 2R_G(\wp(z) - e_1, \wp(z) - e_2, \wp(z) - e_3).$$

In (19.25.38) and (19.25.39)  $j, k, \ell$  is any permutation of the numbers 1, 2, 3.

$$19.25.38 \quad \omega_j = R_F(0, e_j - e_k, e_j - e_\ell),$$

$$19.25.39 \quad \eta_j + \omega_j e_j = 2R_G(0, e_j - e_k, e_j - e_\ell).$$

Lastly,

$$19.25.40 \quad z = \sigma(z) R_F(\sigma_1^2(z), \sigma_2^2(z), \sigma_3^2(z)),$$

where

$$19.25.41 \quad \sigma_j(z) = \exp(-\eta_j z) \sigma(z + \omega_j) / \sigma(\omega_j), \quad j = 1, 2, 3.$$

**19.25(vii) Hypergeometric Function**

$$19.25.42 \quad {}_2F_1(a, b; c; z) = R_{-a}(b, c - b; 1 - z, 1),$$

$$19.25.43 \quad R_{-a}(b_1, b_2; z_1, z_2) = z_2^{-a} {}_2F_1(a, b_1; b_1 + b_2; 1 - (z_1/z_2)).$$

For these results and extensions to the Appell function  $F_1$  (§16.13) and Lauricella's function  $F_D$  see Carlson (1963). ( $F_1$  and  $F_D$  are equivalent to the  $R$ -function of 3 and  $n$  variables, respectively, but lack full symmetry.)

**19.26 Addition Theorems****19.26(i) General Formulas**

In this subsection, and also §§19.26(ii) and 19.26(iii), we assume that  $\lambda, x, y, z$  are positive, except that at most one of  $x, y, z$  can be 0.

$$19.26.1 \quad R_F(x + \lambda, y + \lambda, z + \lambda) + R_F(x + \mu, y + \mu, z + \mu) = R_F(x, y, z),$$

where  $\mu > 0$  and

$$19.26.2 \quad x + \mu = \lambda^{-2} \left( \sqrt{(x + \lambda)yz} + \sqrt{x(y + \lambda)(z + \lambda)} \right)^2,$$

with corresponding equations for  $y + \mu$  and  $z + \mu$  obtained by permuting  $x, y, z$ . Also,

$$19.26.3 \quad \sqrt{z} = \frac{\xi\zeta' + \eta'\zeta - \xi\eta'}{\sqrt{\xi\eta\zeta'} + \sqrt{\xi'\eta'\zeta}},$$

where

$$19.26.4 \quad \begin{aligned} (\xi, \eta, \zeta) &= (x + \lambda, y + \lambda, z + \lambda), \\ (\xi', \eta', \zeta') &= (x + \mu, y + \mu, z + \mu), \end{aligned}$$

with  $\sqrt{x}$  and  $\sqrt{y}$  obtained by permuting  $x, y$ , and  $z$ . (Note that  $\xi\zeta' + \eta'\zeta - \xi\eta' = \xi'\zeta + \eta\zeta' - \xi'\eta$ .) Equivalent forms of (19.26.2) are given by

$$19.26.5 \quad \begin{aligned} \mu &= \lambda^{-2} \left( \sqrt{xyz} + \sqrt{(x + \lambda)(y + \lambda)(z + \lambda)} \right)^2 \\ &\quad - \lambda - x - y - z, \end{aligned}$$

and

$$19.26.6 \quad (\lambda\mu - xy - xz - yz)^2 = 4xyz(\lambda + \mu + x + y + z).$$

Also,

$$19.26.7 \quad \begin{aligned} R_D(x + \lambda, y + \lambda, z + \lambda) + R_D(x + \mu, y + \mu, z + \mu) \\ = R_D(x, y, z) - \frac{3}{\sqrt{z(z + \lambda)(z + \mu)}}, \end{aligned}$$

$$19.26.8 \quad \begin{aligned} 2R_G(x + \lambda, y + \lambda, z + \lambda) + 2R_G(x + \mu, y + \mu, z + \mu) \\ = 2R_G(x, y, z) + \lambda R_F(x + \lambda, y + \lambda, z + \lambda) \\ + \mu R_F(x + \mu, y + \mu, z + \mu) + \sqrt{\lambda + \mu + x + y + z}. \end{aligned}$$

$$19.26.9 \quad \begin{aligned} R_J(x + \lambda, y + \lambda, z + \lambda, p + \lambda) \\ + R_J(x + \mu, y + \mu, z + \mu, p + \mu) \\ = R_J(x, y, z, p) - 3R_C(\gamma - \delta, \gamma), \end{aligned}$$

where

$$19.26.10 \quad \gamma = p(p + \lambda)(p + \mu), \quad \delta = (p - x)(p - y)(p - z).$$

Lastly,

$$19.26.11 \quad R_C(x + \lambda, y + \lambda) + R_C(x + \mu, y + \mu) = R_C(x, y),$$

where  $\lambda > 0, y > 0, x \geq 0$ , and

$$19.26.12 \quad \begin{aligned} x + \mu &= \lambda^{-2} (\sqrt{x + \lambda}y + \sqrt{x}(y + \lambda))^2, \\ y + \mu &= (y(y + \lambda)/\lambda^2) (\sqrt{x + \lambda} + \sqrt{x + \lambda})^2. \end{aligned}$$

Equivalent forms of (19.26.11) are given by

$$19.26.13 \quad \begin{aligned} R_C(\alpha^2, \alpha^2 - \theta) + R_C(\beta^2, \beta^2 - \theta) \\ = R_C(\sigma^2, \sigma^2 - \theta), \quad \sigma = (\alpha\beta + \theta)/(\alpha + \beta), \end{aligned}$$

where  $0 < \gamma^2 - \theta < \gamma^2$  for  $\gamma = \alpha, \beta, \sigma$ , except that  $\sigma^2 - \theta$  can be 0, and

$$19.26.14 \quad \begin{aligned} (p - y)R_C(x, p) + (q - y)R_C(x, q) \\ = (\eta - \xi)R_C(\xi, \eta), \quad x \geq 0, y \geq 0; p, q \in \mathbb{R} \setminus \{0\}, \end{aligned}$$

where

$$19.26.15 \quad \begin{aligned} (p - x)(q - x) &= (y - x)^2, \quad \xi = y^2/x, \\ \eta &= pq/x, \quad \eta - \xi = p + q - 2y. \end{aligned}$$

**19.26(ii) Case  $x = 0$** 

If  $x = 0$ , then  $\lambda\mu = yz$ . For example,

**19.26.16**

$$\begin{aligned} R_F(\lambda, y + \lambda, z + \lambda) \\ = R_F(0, y, z) - R_F(\mu, y + \mu, z + \mu), \quad \lambda\mu = yz. \end{aligned}$$

An equivalent version for  $R_C$  is

$$\begin{aligned} \mathbf{19.26.17} \quad \sqrt{\alpha} R_C(\beta, \alpha + \beta) + \sqrt{\beta} R_C(\alpha, \alpha + \beta) \\ = \pi/2, \quad \alpha, \beta \in \mathbb{C} \setminus (-\infty, 0), \quad \alpha + \beta > 0. \end{aligned}$$

**19.26(iii) Duplication Formulas**

$$\begin{aligned} \mathbf{19.26.18} \quad R_F(x, y, z) = 2R_F(x + \lambda, y + \lambda, z + \lambda) \\ = R_F\left(\frac{x + \lambda}{4}, \frac{y + \lambda}{4}, \frac{z + \lambda}{4}\right), \end{aligned}$$

where

$$\mathbf{19.26.19} \quad \lambda = \sqrt{x}\sqrt{y} + \sqrt{y}\sqrt{z} + \sqrt{z}\sqrt{x}.$$

**19.26.20**

$$R_D(x, y, z) = 2R_D(x + \lambda, y + \lambda, z + \lambda) + \frac{3}{\sqrt{z}(z + \lambda)}.$$

$$\mathbf{19.26.21} \quad 2R_G(x, y, z) = 4R_G(x + \lambda, y + \lambda, z + \lambda) \\ - \lambda R_F(x, y, z) - \sqrt{x} - \sqrt{y} - \sqrt{z}.$$

$$\mathbf{19.26.22} \quad R_J(x, y, z, p) = 2R_J(x + \lambda, y + \lambda, z + \lambda, p + \lambda) \\ + 3R_C(\alpha^2, \beta^2),$$

where

$$\begin{aligned} \mathbf{19.26.23} \quad \alpha = p(\sqrt{x} + \sqrt{y} + \sqrt{z}) + \sqrt{x}\sqrt{y}\sqrt{z}, \quad \beta = \sqrt{p}(p + \lambda), \\ \beta \pm \alpha = (\sqrt{p} \pm \sqrt{x})(\sqrt{p} \pm \sqrt{y})(\sqrt{p} \pm \sqrt{z}), \\ \beta^2 - \alpha^2 = (p - x)(p - y)(p - z), \end{aligned}$$

either upper or lower signs being taken throughout.

The equations inverse to  $z + \lambda = (\sqrt{z} + \sqrt{x})(\sqrt{z} + \sqrt{y})$  and the two other equations obtained by permuting  $x, y, z$  (see (19.26.19)) are

$$\mathbf{19.26.24} \quad z = (\xi\zeta + \eta\zeta - \xi\eta)^2 / (4\xi\eta\zeta), \\ (\xi, \eta, \zeta) = (x + \lambda, y + \lambda, z + \lambda),$$

and two similar equations obtained by exchanging  $z$  with  $x$  (and  $\zeta$  with  $\xi$ ), or  $z$  with  $y$  (and  $\zeta$  with  $\eta$ ).

Next,

$$\mathbf{19.26.25} \quad R_C(x, y) = 2R_C(x + \lambda, y + \lambda), \quad \lambda = y + 2\sqrt{x}\sqrt{y}.$$

Equivalent forms are given by (19.22.22). Also,

$$\mathbf{19.26.26} \quad R_C(x^2, y^2) = R_C(a^2, ay), \\ a = (x + y)/2, \quad \Re x \geq 0, \quad \Re y > 0,$$

and

$$\mathbf{19.26.27} \quad R_C(x^2, x^2 - \theta) = 2R_C(s^2, s^2 - \theta), \\ s = x + \sqrt{x^2 - \theta}, \quad \theta \neq x^2 \text{ or } s^2.$$

**19.27 Asymptotic Approximations and Expansions****19.27(i) Notation**

Throughout this section

**19.27.1**

$$\begin{aligned} a = \frac{1}{2}(x + y), \quad b = \frac{1}{2}(y + z), \quad c = \frac{1}{3}(x + y + z), \\ f = (xyz)^{1/3}, \quad g = (xy)^{1/2}, \quad h = (yz)^{1/2}. \end{aligned}$$

**19.27(ii)  $R_F(x, y, z)$** 

Assume  $x, y$ , and  $z$  are real and nonnegative and at most one of them is 0. Then

**19.27.2**

$$R_F(x, y, z) = \frac{1}{2\sqrt{z}} \left( \ln \frac{8z}{a + g} \right) \left( 1 + O\left(\frac{a}{z}\right) \right), \quad a/z \rightarrow 0.$$

**19.27.3**

$$R_F(x, y, z) = R_F(0, y, z) - \frac{1}{\sqrt{h}} \left( \sqrt{\frac{x}{h}} + O\left(\frac{x}{h}\right) \right), \quad x/h \rightarrow 0.$$

**19.27(iii)  $R_G(x, y, z)$** 

Assume  $x, y$ , and  $z$  are real and nonnegative and at most one of them is 0. Then

$$\mathbf{19.27.4} \quad R_G(x, y, z) = \frac{\sqrt{z}}{2} \left( 1 + O\left(\frac{a}{z} \ln \frac{z}{a}\right) \right), \quad a/z \rightarrow 0.$$

**19.27.5**

$$R_G(x, y, z) = R_G(0, y, z) + \sqrt{x} O\left(\sqrt{x/h}\right), \quad x/h \rightarrow 0.$$

$$R_G(0, y, z)$$

$$\mathbf{19.27.6} \quad = \frac{\sqrt{z}}{2} + \frac{y}{8\sqrt{z}} \left( \ln \left( \frac{16z}{y} \right) - 1 \right) \left( 1 + O\left(\frac{y}{z}\right) \right), \quad y/z \rightarrow 0.$$

**19.27(iv)  $R_D(x, y, z)$** 

Assume  $x$  and  $y$  are real and nonnegative, at most one of them is 0, and  $z > 0$ . Then

**19.27.7**

$$R_D(x, y, z) = \frac{3}{2z^{3/2}} \left( \ln \left( \frac{8z}{a + g} \right) - 2 \right) \left( 1 + O\left(\frac{a}{z}\right) \right), \quad a/z \rightarrow 0.$$

**19.27.8**

$$R_D(x, y, z) = \frac{3}{\sqrt{xyz}} - \frac{6}{xy} R_G(x, y, 0) \left( 1 + O\left(\frac{z}{g}\right) \right), \quad z/g \rightarrow 0.$$

**19.27.9**

$$R_D(x, y, z) = \frac{3}{\sqrt{xz}(\sqrt{y} + \sqrt{z})} \left( 1 + O\left(\frac{b}{x} \ln \frac{x}{b}\right) \right), \quad b/x \rightarrow 0.$$

**19.27.10**

$$R_D(x, y, z) = R_D(0, y, z) - \frac{3\sqrt{x}}{hz} \left( 1 + O\left(\sqrt{\frac{x}{h}}\right) \right),$$

$x/h \rightarrow 0.$

**19.27(v)  $R_J(x, y, z, p)$** 

Assume  $x, y,$  and  $z$  are real and nonnegative, at most one of them is 0, and  $p > 0.$  Then

**19.27.11**

$$R_J(x, y, z, p) = \frac{3}{p} R_F(x, y, z) - \frac{3\pi}{2p^{3/2}} \left( 1 + O\left(\sqrt{\frac{c}{p}}\right) \right),$$

$c/p \rightarrow 0.$

**19.27.12**

$$R_J(x, y, z, p) = \frac{3}{2\sqrt{xyz}} \left( \ln\left(\frac{4f}{p}\right) - 2 \right) \left( 1 + O\left(\frac{p}{f}\right) \right),$$

$p/f \rightarrow 0.$

**19.27.13**

$$R_J(x, y, z, p) = \frac{3}{2\sqrt{zp}} \left( \ln\left(\frac{8z}{a+g}\right) - 2R_C\left(1, \frac{p}{z}\right) \right. \\ \left. + O\left(\left(\frac{a}{z} + \frac{a}{p}\right) \ln\frac{p}{a}\right) \right),$$

$\max(x, y)/\min(z, p) \rightarrow 0.$

**19.27.14**

$$R_J(x, y, z, p) = \frac{3}{\sqrt{yz}} R_C(x, p) - \frac{6}{yz} R_G(0, y, z) \\ + O\left(\frac{\sqrt{x+2p}}{yz}\right),$$

$\max(x, p)/\min(y, z) \rightarrow 0.$

**19.27.15**

$$R_J(x, y, z, p) = R_J(0, y, z, p) \\ - \frac{3\sqrt{x}}{hp} \left( 1 + O\left(\left(\frac{b}{h} + \frac{h}{p}\right) \sqrt{\frac{x}{h}}\right) \right),$$

$x/\min(y, z, p) \rightarrow 0.$

**19.27.16**

$$R_J(x, y, z, p) = (3/\sqrt{x}) R_C((h+p)^2, 2(b+h)p) \\ + O\left(\frac{1}{x^{3/2}} \ln\frac{x}{b+h}\right),$$

$\max(y, z, p)/x \rightarrow 0.$

**19.27(vi) Asymptotic Expansions**

The approximations in §§19.27(i)–19.27(v) are furnished with upper and lower bounds by Carlson and Gustafson (1994), sometimes with two or three approximations of differing accuracies. Although they are obtained (with some exceptions) by approximating uniformly the integrand of each elliptic integral, some occur also as the leading terms of known asymptotic series with error bounds (Wong (1983, §4), Carlson and Gustafson (1985), López (2000, 2001)). These series converge but

not fast enough, given the complicated nature of their terms, to be very useful in practice.

A similar (but more general) situation prevails for  $R_{-a}(\mathbf{b}; \mathbf{z})$  when some of the variables  $z_1, \dots, z_n$  are smaller in magnitude than the rest; see Carlson (1985, (4.16)–(4.19) and (2.26)–(2.29)).

**19.28 Integrals of Elliptic Integrals**

In (19.28.1)–(19.28.3) we assume  $\Re\sigma > 0.$  Also,  $B$  again denotes the beta function (§5.12).

$$19.28.1 \quad \int_0^1 t^{\sigma-1} R_F(0, t, 1) dt = \frac{1}{2} (B(\sigma, \frac{1}{2}))^2,$$

$$19.28.2 \quad \int_0^1 t^{\sigma-1} R_G(0, t, 1) dt = \frac{\sigma}{4\sigma+2} (B(\sigma, \frac{1}{2}))^2,$$

**19.28.3**

$$\int_0^1 t^{\sigma-1} (1-t) R_D(0, t, 1) dt = \frac{3}{4\sigma+2} (B(\sigma, \frac{1}{2}))^2.$$

$$19.28.4 \quad \int_0^1 t^{\sigma-1} (1-t)^{c-1} R_{-a}(b_1, b_2; t, 1) dt \\ = \frac{\Gamma(c) \Gamma(\sigma) \Gamma(\sigma + b_2 - a)}{\Gamma(\sigma + c - a) \Gamma(\sigma + b_2)},$$

$c = b_1 + b_2 > 0, \Re\sigma > \max(0, a - b_2).$

In (19.28.5)–(19.28.9) we assume  $x, y, z,$  and  $p$  are real and positive.

$$19.28.5 \quad \int_z^\infty R_D(x, y, t) dt = 6R_F(x, y, z),$$

**19.28.6**

$$\int_0^1 R_D(x, y, v^2z + (1-v^2)p) dv = R_J(x, y, z, p).$$

$$19.28.7 \quad \int_0^\infty R_J(x, y, z, r^2) dr = \frac{3}{2}\pi R_F(xy, xz, yz),$$

**19.28.8**

$$\int_0^\infty R_J(tx, y, z, tp) dt = \frac{6}{\sqrt{p}} R_C(p, x) R_F(0, y, z).$$

**19.28.9**

$$\int_0^{\pi/2} R_F(\sin^2 \theta \cos^2(x+y), \sin^2 \theta \cos^2(x-y), 1) d\theta \\ = R_F(0, \cos^2 x, 1) R_F(0, \cos^2 y, 1),$$

**19.28.10**

$$\int_0^\infty R_F((ac+bd)^2, (ad+bc)^2, 4abcd \cosh^2 z) dz \\ = \frac{1}{2} R_F(0, a^2, b^2) R_F(0, c^2, d^2), \quad a, b, c, d > 0.$$

See also (19.16.24). To replace a single component of  $\mathbf{z}$  in  $R_{-a}(\mathbf{b}; \mathbf{z})$  by several different variables (as in (19.28.6)), see Carlson (1963, (7.9)).



### 19.29 Reduction of General Elliptic Integrals

#### 19.29(i) Reduction Theorems

These theorems reduce integrals over a real interval  $(y, x)$  of certain integrands containing the square root of a quartic or cubic polynomial to symmetric integrals over  $(0, \infty)$  containing the square root of a cubic polynomial (compare §19.16(i)). Let

**19.29.1** 
$$X_\alpha = \sqrt{a_\alpha + b_\alpha x}, \quad Y_\alpha = \sqrt{a_\alpha + b_\alpha y},$$

$$x > y, \quad 1 \leq \alpha \leq 5,$$

**19.29.2** 
$$d_{\alpha\beta} = a_\alpha b_\beta - a_\beta b_\alpha, \quad d_{\alpha\beta} \neq 0 \text{ if } \alpha \neq \beta,$$
 and assume that the line segment with endpoints  $a_\alpha + b_\alpha x$  and  $a_\alpha + b_\alpha y$  lies in  $\mathbb{C} \setminus (-\infty, 0)$  for  $1 \leq \alpha \leq 4$ . If

**19.29.3** 
$$s(t) = \prod_{\alpha=1}^4 \sqrt{a_\alpha + b_\alpha t}$$

and  $\alpha, \beta, \gamma, \delta$  is any permutation of the numbers 1, 2, 3, 4, then

**19.29.4** 
$$\int_y^x \frac{dt}{s(t)} = 2R_F(U_{12}^2, U_{13}^2, U_{23}^2),$$

where

**19.29.5** 
$$U_{\alpha\beta} = (X_\alpha X_\beta Y_\gamma Y_\delta + Y_\alpha Y_\beta X_\gamma X_\delta) / (x - y),$$

$$U_{\alpha\beta} = U_{\beta\alpha} = U_{\gamma\delta} = U_{\delta\gamma}, \quad U_{\alpha\beta}^2 - U_{\alpha\gamma}^2 = d_{\alpha\delta} d_{\beta\gamma}.$$

There are only three distinct  $U$ 's with subscripts  $\leq 4$ , and at most one of them can be 0 because the  $d$ 's are nonzero. Then

**19.29.6** 
$$U_{\alpha\beta} = \sqrt{b_\alpha} \sqrt{b_\beta} Y_\gamma Y_\delta + Y_\alpha Y_\beta \sqrt{b_\gamma} \sqrt{b_\delta}, \quad x = \infty,$$

$$U_{\alpha\beta} = X_\alpha X_\beta \sqrt{-b_\gamma} \sqrt{-b_\delta} + \sqrt{-b_\alpha} \sqrt{-b_\beta} X_\gamma X_\delta, \quad y = -\infty.$$

**19.29.7** 
$$\int_y^x \frac{a_\alpha + b_\alpha t}{a_\delta + b_\delta t} \frac{dt}{s(t)} = \frac{2}{3} d_{\alpha\beta} d_{\alpha\gamma} R_D(U_{\alpha\beta}^2, U_{\alpha\gamma}^2, U_{\alpha\delta}^2)$$

$$+ \frac{2X_\alpha Y_\alpha}{X_\delta Y_\delta U_{\alpha\delta}}, \quad U_{\alpha\delta} \neq 0.$$

**19.29.8** 
$$\int_y^x \frac{a_\alpha + b_\alpha t}{a_5 + b_5 t} \frac{dt}{s(t)}$$

$$= \frac{2}{3} \frac{d_{\alpha\beta} d_{\alpha\gamma} d_{\alpha\delta}}{d_{\alpha 5}} R_J(U_{12}^2, U_{13}^2, U_{23}^2, U_{\alpha 5}^2)$$

$$+ 2R_C(S_{\alpha 5}^2, Q_{\alpha 5}^2), \quad S_{\alpha 5}^2 \in \mathbb{C} \setminus (-\infty, 0),$$

where

**19.29.9** 
$$U_{\alpha 5}^2 = U_{\alpha\beta}^2 - \frac{d_{\alpha\gamma} d_{\alpha\delta} d_{\beta 5}}{d_{\alpha 5}} = U_{\beta\gamma}^2 - \frac{d_{\alpha\beta} d_{\alpha\gamma} d_{\delta 5}}{d_{\alpha 5}} \neq 0,$$

$$S_{\alpha 5} = \frac{1}{x - y} \left( \frac{X_\beta X_\gamma X_\delta}{X_\alpha} Y_5^2 + \frac{Y_\beta Y_\gamma Y_\delta}{Y_\alpha} X_5^2 \right),$$

$$Q_{\alpha 5} = \frac{X_5 Y_5}{X_\alpha Y_\alpha} U_{\alpha 5} \neq 0, \quad S_{\alpha 5}^2 - Q_{\alpha 5}^2 = \frac{d_{\beta 5} d_{\gamma 5} d_{\delta 5}}{d_{\alpha 5}}.$$

The Cauchy principal value is taken when  $U_{\alpha 5}^2$  or  $Q_{\alpha 5}^2$  is real and negative. Cubic cases of these formulas are obtained by setting one of the factors in (19.29.3) equal to 1.

The advantages of symmetric integrals for tables of integrals and symbolic integration are illustrated by (19.29.4) and its cubic case, which replace the  $8 + 8 + 12 = 28$  formulas in Gradshteyn and Ryzhik (2000, 3.147, 3.131, 3.152) after taking  $x^2$  as the variable of integration in 3.152. Moreover, the requirement that one limit of integration be a branch point of the integrand is eliminated without doubling the number of standard integrals in the result. (19.29.7) subsumes all 72 formulas in Gradshteyn and Ryzhik (2000, 3.168), and its cubic cases similarly replace the  $18 + 36 + 18 = 72$  formulas in Gradshteyn and Ryzhik (2000, 3.133, 3.142, and 3.141(1-18)). For example, 3.142(2) is included as

**19.29.10** 
$$\int_u^b \sqrt{\frac{a-t}{(b-t)(t-c)^3}} dt = -\frac{2}{3}(a-b)(b-u)^{3/2} R_D$$

$$+ \frac{2}{b-c} \sqrt{\frac{(a-u)(b-u)}{u-c}},$$

$$a > b > u > c,$$

where the arguments of the  $R_D$  function are, in order,  $(a-b)(u-c)$ ,  $(b-c)(a-u)$ ,  $(a-b)(b-c)$ .

#### 19.29(ii) Reduction to Basic Integrals

(19.2.3) can be written

**19.29.11** 
$$I(\mathbf{m}) = \int_y^x \prod_{\alpha=1}^h (a_\alpha + b_\alpha t)^{-1/2} \prod_{j=1}^n (a_j + b_j t)^{m_j} dt,$$

where  $x > y$ ,  $h = 3$  or  $4$ ,  $n \geq h$ , and  $m_j$  is an integer. Define

**19.29.12** 
$$\mathbf{m} = (m_1, \dots, m_n) = \sum_{j=1}^n m_j \mathbf{e}_j,$$

where  $\mathbf{e}_j$  is an  $n$ -tuple with 1 in the  $j$ th position and 0's elsewhere. Define also  $\mathbf{0} = (0, \dots, 0)$  and retain the notation and conditions associated with (19.29.1) and (19.29.2). The integrals in (19.29.4), (19.29.7), and (19.29.8) are  $I(\mathbf{0})$ ,  $I(\mathbf{e}_\alpha - \mathbf{e}_\delta)$ , and  $I(\mathbf{e}_\alpha - \mathbf{e}_5)$ , respectively.

The only cases of  $I(\mathbf{m})$  that are integrals of the *first kind* are the two ( $h = 3$  or  $4$ ) with  $\mathbf{m} = \mathbf{0}$ . The only cases that are integrals of the *third kind* are those in which at least one  $m_j$  with  $j > h$  is a negative integer and those in which  $h = 4$  and  $\sum_{j=1}^n m_j$  is a positive integer. All other cases are integrals of the *second kind*.

$I(\mathbf{m})$  can be reduced to a linear combination of *basic integrals* and algebraic functions. In the cubic case ( $h = 3$ ) the basic integrals are

**19.29.13** 
$$I(\mathbf{0}); \quad I(-\mathbf{e}_j), \quad 1 \leq j \leq n.$$

In the quartic case ( $h = 4$ ) the basic integrals are

$$19.29.14 \quad \begin{aligned} I(\mathbf{0}); \quad I(-\mathbf{e}_j), & \quad 1 \leq j \leq n; \\ I(\mathbf{e}_\alpha), & \quad 1 \leq \alpha \leq 4. \end{aligned}$$

Basic integrals of type  $I(-\mathbf{e}_j)$ ,  $1 \leq j \leq h$ , are not linearly independent, nor are those of type  $I(\mathbf{e}_j)$ ,  $1 \leq j \leq 4$ .

The reduction of  $I(\mathbf{m})$  is carried out by a relation derived from partial fractions and by use of two recurrence relations. These are given in Carlson (1999, (2.19), (3.5), (3.11)) and simplified in Carlson (2002, (1.10), (1.7), (1.8)) by means of modified definitions. Partial fractions provide a reduction to integrals in which  $\mathbf{m}$  has at most one nonzero component, and these are then reduced to basic integrals by the recurrence relations. A special case of Carlson (1999, (2.19)) is given by

$$19.29.15 \quad b_j I(\mathbf{e}_l - \mathbf{e}_j) = d_{lj} I(-\mathbf{e}_j) + b_l I(\mathbf{0}), \quad j, l = 1, 2, \dots, n,$$

which shows how to express the basic integral  $I(-\mathbf{e}_j)$  in terms of symmetric integrals by using (19.29.4) and either (19.29.7) or (19.29.8). The first choice gives a formula that includes the  $18+9+18 = 45$  formulas in Gradshteyn and Ryzhik (2000, 3.133, 3.156, 3.158), and the second choice includes the  $8+8+8+12 = 36$  formulas in Gradshteyn and Ryzhik (2000, 3.151, 3.149, 3.137, 3.157) (after setting  $x^2 = t$  in some cases).

If  $h = 3$ , then the recurrence relation (Carlson (1999, (3.5))) has the special case

$$19.29.16 \quad \begin{aligned} b_\beta b_\gamma I(\mathbf{e}_\alpha) = d_{\alpha\beta} d_{\alpha\gamma} I(-\mathbf{e}_\alpha) \\ + 2b_\alpha \left( \frac{s(x)}{a_\alpha + b_\alpha x} - \frac{s(y)}{a_\alpha + b_\alpha y} \right), \end{aligned}$$

where  $\alpha, \beta, \gamma$  is any permutation of the numbers 1, 2, 3, and

$$19.29.17 \quad s(t) = \prod_{\alpha=1}^3 \sqrt{a_\alpha + b_\alpha t}.$$

(This shows why  $I(\mathbf{e}_\alpha)$  is not needed as a basic integral in the cubic case.) In the quartic case this recurrence relation has an extra term in  $I(2\mathbf{e}_\alpha)$ , and hence  $I(\mathbf{e}_\alpha)$ ,  $1 \leq \alpha \leq 4$ , is a basic integral. It can be expressed in terms of symmetric integrals by setting  $a_5 = 1$  and  $b_5 = 0$  in (19.29.8).

The other recurrence relation is

$$19.29.18 \quad b_j^q I(q\mathbf{e}_l) = \sum_{r=0}^q \binom{q}{r} b_l^r d_{lj}^{q-r} I(r\mathbf{e}_j), \quad j, l = 1, 2, \dots, n;$$

see Carlson (1999, (3.11)). An example that uses (19.29.15)–(19.29.18) is given in §19.34.

For an implementation by James FitzSimons of the method for reducing  $I(\mathbf{m})$  to basic integrals and extensive tables of such reductions, see Carlson (1999) and Carlson and FitzSimons (2000).

Another method of reduction is given in Gray (2002). It depends primarily on multivariate recurrence relations that replace one integral by two or more.

### 19.29(iii) Examples

The first formula replaces (19.14.4)–(19.14.10). Define  $Q_j(t) = a_j + b_j t^2$ ,  $j = 1, 2$ , and assume both  $Q$ 's are positive for  $0 \leq y < t < x$ . Then

$$19.29.19 \quad \int_y^x \frac{dt}{\sqrt{Q_1(t)Q_2(t)}} = R_F(U^2 + a_1 b_2, U^2 + a_2 b_1, U^2),$$

$$19.29.20 \quad \int_y^x \frac{t^2 dt}{\sqrt{Q_1(t)Q_2(t)}} = \frac{1}{3} a_1 a_2 R_D(U^2 + a_1 b_2, U^2 + a_2 b_1, U^2) + (xy/U),$$

and

$$19.29.21 \quad \int_y^x \frac{dt}{t^2 \sqrt{Q_1(t)Q_2(t)}} = \frac{1}{3} b_1 b_2 R_D(U^2 + a_1 b_2, U^2 + a_2 b_1, U^2) + (xyU)^{-1},$$

where

$$19.29.22 \quad (x^2 - y^2)U = x\sqrt{Q_1(y)Q_2(y)} + y\sqrt{Q_1(x)Q_2(x)}.$$

If both square roots in (19.29.22) are 0, then the indeterminacy in the two preceding equations can be removed by using (19.27.8) to evaluate the integral as  $R_G(a_1 b_2, a_2 b_1, 0)$  multiplied either by  $-2/(b_1 b_2)$  or by  $-2/(a_1 a_2)$  in the cases of (19.29.20) or (19.29.21), respectively. If  $x = \infty$ , then  $U$  is found by taking the limit. For example,

$$19.29.23 \quad \int_y^\infty \frac{dt}{\sqrt{(t^2 + a^2)(t^2 - b^2)}} = R_F(y^2 + a^2, y^2 - b^2, y^2).$$

Next, for  $j = 1, 2$ , define  $Q_j(t) = f_j + g_j t + h_j t^2$ , and assume both  $Q$ 's are positive for  $y < t < x$ . If each has real zeros, then (19.29.4) may be simpler than

$$19.29.24 \quad \int_y^x \frac{dt}{\sqrt{Q_1(t)Q_2(t)}} = 4R_F(U, U + D_{12} + V, U + D_{12} - V),$$

where

$$19.29.25 \quad \begin{aligned} (x - y)^2 U &= S_1 S_2, \\ S_j &= \left( \sqrt{Q_j(x)} + \sqrt{Q_j(y)} \right)^2 - h_j (x - y)^2, \end{aligned}$$

$$D_{jl} = 2f_j h_l + 2h_j f_l - g_j g_l, \quad V = \sqrt{D_{12}^2 - D_{11} D_{22}}.$$

(The variables of  $R_F$  are real and nonnegative unless both  $Q$ 's have real zeros and those of  $Q_1$  interlace those of  $Q_2$ .) If  $Q_1(t) = (a_1 + b_1 t)(a_2 + b_2 t)$ , where both linear factors are positive for  $y < t < x$ , and

$Q_2(t) = f_2 + g_2t + h_2t^2$ , then (19.29.25) is modified so that

$$\begin{aligned}
 S_1 &= (X_1Y_2 + Y_1X_2)^2, \\
 19.29.26 \quad X_j &= \sqrt{a_j + b_jx}, \quad Y_j = \sqrt{a_j + b_jy}, \\
 D_{12} &= 2a_1a_2h_2 + 2b_1b_2f_2 - (a_1b_2 + a_2b_1)g_2, \\
 D_{11} &= -(a_1b_2 - a_2b_1)^2 = -d_{12}^2,
 \end{aligned}$$

with other quantities remaining as in (19.29.25). In the cubic case, in which  $a_2 = 1, b_2 = 0$ , (19.29.26) reduces further to

$$19.29.27 \quad S_1 = (X_1 + Y_1)^2, \quad D_{12} = 2a_1h_2 - b_1g_2, \quad D_{11} = -b_1^2.$$

For example, because  $t^3 - a^3 = (t - a)(t^2 + at + a^2)$ , we find that when  $0 \leq a \leq y < x$

$$\begin{aligned}
 19.29.28 \quad \int_y^x \frac{dt}{\sqrt{t^3 - a^3}} \\
 = 4R_F(U, U - 3a + 2\sqrt{3}a, U - 3a - 2\sqrt{3}a),
 \end{aligned}$$

where

$$\begin{aligned}
 19.29.29 \quad (x - y)^2U &= (\sqrt{x - a} + \sqrt{y - a})^2 ((\xi + \eta)^2 - (x - y)^2), \\
 \xi &= \sqrt{x^2 + ax + a^2}, \quad \eta = \sqrt{y^2 + ay + a^2}.
 \end{aligned}$$

Lastly, define  $Q(t^2) = f + gt^2 + ht^4$  and assume  $Q(t^2)$  is positive and monotonic for  $y < t < x$ . Then

$$\begin{aligned}
 19.29.30 \quad \int_y^x \frac{dt}{\sqrt{Q(t^2)}} \\
 = 2R_F(U, U - g + 2\sqrt{fh}, U - g - 2\sqrt{fh}),
 \end{aligned}$$

where

$$19.29.31 \quad (x - y)^2U = \left(\sqrt{Q(x^2)} + \sqrt{Q(y^2)}\right)^2 - h(x^2 - y^2)^2.$$

For example, if  $0 \leq y \leq x$  and  $a^4 \geq 0$ , then

$$19.29.32 \quad \int_y^x \frac{dt}{\sqrt{t^4 + a^4}} = 2R_F(U, U + 2a^2, U - 2a^2),$$

where

$$19.29.33 \quad (x - y)^2U = \left(\sqrt{x^4 + a^4} + \sqrt{y^4 + a^4}\right)^2 - (x^2 - y^2)^2.$$

## Applications

### 19.30 Lengths of Plane Curves

#### 19.30(i) Ellipse

The arclength  $s$  of the ellipse

$$19.30.1 \quad x = a \sin \phi, \quad y = b \cos \phi, \quad 0 \leq \phi \leq 2\pi,$$

with  $a > b$ , is given by

$$19.30.2 \quad s = a \int_0^\phi \sqrt{1 - k^2 \sin^2 \theta} d\theta.$$

When  $0 \leq \phi \leq \frac{1}{2}\pi$ ,

$$\begin{aligned}
 19.30.3 \quad s/a &= E(\phi, k) \\
 &= R_F(c - 1, c - k^2, c) - \frac{1}{3}k^2 R_D(c - 1, c - k^2, c),
 \end{aligned}$$

where

$$19.30.4 \quad k^2 = 1 - (b^2/a^2), \quad c = \csc^2 \phi.$$

Cancellation on the second right-hand side of (19.30.3) can be avoided by use of (19.25.10).

The length of the ellipse is

$$\begin{aligned}
 19.30.5 \quad L(a, b) &= 4a E(k) = 8a R_G(0, b^2/a^2, 1) \\
 &= 8R_G(0, a^2, b^2) = 8ab R_G(0, a^{-2}, b^{-2}),
 \end{aligned}$$

showing the symmetry in  $a$  and  $b$ . Approximations and inequalities for  $L(a, b)$  are given in §19.9(i).

Let  $a^2$  and  $b^2$  be replaced respectively by  $a^2 + \lambda$  and  $b^2 + \lambda$ , where  $\lambda \in (-b^2, \infty)$ , to produce a family of confocal ellipses. As  $\lambda$  increases, the eccentricity  $k$  decreases and the rate of change of arclength for a fixed value of  $\phi$  is given by

$$\begin{aligned}
 19.30.6 \quad \frac{\partial s}{\partial(1/k)} &= \sqrt{a^2 - b^2} F(\phi, k) \\
 &= \sqrt{a^2 - b^2} R_F(c - 1, c - k^2, c), \\
 k^2 &= (a^2 - b^2)/(a^2 + \lambda), \quad c = \csc^2 \phi.
 \end{aligned}$$

#### 19.30(ii) Hyperbola

The arclength  $s$  of the hyperbola

$$19.30.7 \quad x = a\sqrt{t + 1}, \quad y = b\sqrt{t}, \quad 0 \leq t < \infty,$$

is given by

$$19.30.8 \quad s = \frac{1}{2} \int_0^{y^2/b^2} \sqrt{\frac{(a^2 + b^2)t + b^2}{t(t + 1)}} dt.$$

From (19.29.7), with  $a_\delta = 1$  and  $b_\delta = 0$ ,

$$\begin{aligned}
 19.30.9 \quad s &= \frac{1}{2}I(\mathbf{e}_1) = -\frac{1}{3}a^2b^2 R_D(r, r + b^2 + a^2, r + b^2) \\
 &\quad + y \sqrt{\frac{r + b^2 + a^2}{r + b^2}}, \quad r = b^4/y^2.
 \end{aligned}$$

For  $s$  in terms of  $E(\phi, k)$ ,  $F(\phi, k)$ , and an algebraic term, see Byrd and Friedman (1971, p. 3). See Carlson (1977b, Ex. 9.4-1 and (9.4-4)) for arclengths of hyperbolas and ellipses in terms of  $R_{-a}$  that differ only in the sign of  $b^2$ .

### 19.30(iii) Bernoulli's Lemniscate

For  $0 \leq \theta \leq \frac{1}{4}\pi$ , the arclength  $s$  of Bernoulli's lemniscate

$$19.30.10 \quad r^2 = 2a^2 \cos(2\theta), \quad 0 \leq \theta \leq 2\pi,$$

is given by

$$19.30.11 \quad s = 2a^2 \int_0^r \frac{dt}{\sqrt{4a^4 - t^4}} = \sqrt{2a^2} R_F(q-1, q, q+1),$$

$$q = 2a^2/r^2 = \sec(2\theta),$$

or equivalently,

$$19.30.12 \quad s = a F\left(\phi, 1/\sqrt{2}\right),$$

$$\phi = \arcsin \sqrt{2/(q+1)} = \arccos(\tan \theta).$$

The perimeter length  $P$  of the lemniscate is given by

$$19.30.13 \quad P = 4\sqrt{2a^2} R_F(0, 1, 2) = \sqrt{2a^2} \times 5.24411\ 51\dots$$

$$= 4a K\left(1/\sqrt{2}\right) = a \times 7.41629\ 87\dots$$

For other plane curves with arclength representable by an elliptic integral see Greenhill (1892, p. 190) and Bowman (1953, pp. 32–33).

## 19.31 Probability Distributions

$R_G(x, y, z)$  and  $R_F(x, y, z)$  occur as the expectation values, relative to a normal probability distribution in  $\mathbb{R}^2$  or  $\mathbb{R}^3$ , of the square root or reciprocal square root of a quadratic form. More generally, let  $\mathbf{A}$  ( $= [a_{r,s}]$ ) and  $\mathbf{B}$  ( $= [b_{r,s}]$ ) be real positive-definite matrices with  $n$  rows and  $n$  columns, and let  $\lambda_1, \dots, \lambda_n$  be the eigenvalues of  $\mathbf{A}\mathbf{B}^{-1}$ . If  $\mathbf{x}$  is a column vector with elements  $x_1, x_2, \dots, x_n$  and transpose  $\mathbf{x}^T$ , then

$$19.31.1 \quad \mathbf{x}^T \mathbf{A} \mathbf{x} = \sum_{r=1}^n \sum_{s=1}^n a_{r,s} x_r x_s,$$

and

$$19.31.2 \quad \int_{\mathbb{R}^n} (\mathbf{x}^T \mathbf{A} \mathbf{x})^\mu \exp(-\mathbf{x}^T \mathbf{B} \mathbf{x}) dx_1 \cdots dx_n$$

$$= \frac{\pi^{n/2} \Gamma(\mu + \frac{1}{2}n)}{\sqrt{\det \mathbf{B}} \Gamma(\frac{1}{2}n)} R_\mu\left(\frac{1}{2}, \dots, \frac{1}{2}; \lambda_1, \dots, \lambda_n\right),$$

$$\mu > -\frac{1}{2}n.$$

§19.16(iii) shows that for  $n = 3$  the incomplete cases of  $R_F$  and  $R_G$  occur when  $\mu = -1/2$  and  $\mu = 1/2$ , respectively, while their complete cases occur when  $n = 2$ .

For (19.31.2) and generalizations see Carlson (1972b).

## 19.32 Conformal Map onto a Rectangle

The function

$$19.32.1 \quad z(p) = R_F(p - x_1, p - x_2, p - x_3),$$

with  $x_1, x_2, x_3$  real constants, has differential

$$19.32.2 \quad dz = -\frac{1}{2} \left( \prod_{j=1}^3 (p - x_j)^{-1/2} \right) dp,$$

$$\Im p > 0; 0 < \text{ph}(p - x_j) < \pi, j = 1, 2, 3.$$

If

$$19.32.3 \quad x_1 > x_2 > x_3,$$

then  $z(p)$  is a Schwartz–Christoffel mapping of the open upper-half  $p$ -plane onto the interior of the rectangle in the  $z$ -plane with vertices

$$z(\infty) = 0,$$

$$19.32.4 \quad z(x_1) = R_F(0, x_1 - x_2, x_1 - x_3) \quad (> 0),$$

$$z(x_2) = z(x_1) + z(x_3),$$

$$z(x_3) = R_F(x_3 - x_1, x_3 - x_2, 0)$$

$$= -i R_F(0, x_1 - x_3, x_2 - x_3).$$

As  $p$  proceeds along the entire real axis with the upper half-plane on the right,  $z$  describes the rectangle in the clockwise direction; hence  $z(x_3)$  is negative imaginary.

For further connections between elliptic integrals and conformal maps, see Bowman (1953, pp. 44–85).

## 19.33 Triaxial Ellipsoids

### 19.33(i) Surface Area

The surface area of an ellipsoid with semiaxes  $a, b, c$ , and volume  $V = 4\pi abc/3$  is given by

$$19.33.1 \quad S = 3V R_G(a^{-2}, b^{-2}, c^{-2}),$$

or equivalently,

$$19.33.2 \quad \frac{S}{2\pi} = c^2 + \frac{ab}{\sin \phi} (E(\phi, k) \sin^2 \phi + F(\phi, k) \cos^2 \phi),$$

$$a \geq b \geq c,$$

where

$$19.33.3 \quad \cos \phi = \frac{c}{a}, \quad k^2 = \frac{a^2(b^2 - c^2)}{b^2(a^2 - c^2)}.$$

Application of (19.16.23) transforms the last quantity in (19.30.5) into a two-dimensional analog of (19.33.1).

For additional geometrical properties of ellipsoids (and ellipses), see Carlson (1964, p. 417).

**19.33(ii) Potential of a Charged Conducting Ellipsoid**

If a conducting ellipsoid with semiaxes  $a, b, c$  bears an electric charge  $Q$ , then the equipotential surfaces in the exterior region are confocal ellipsoids:

$$19.33.4 \quad \frac{x^2}{a^2 + \lambda} + \frac{y^2}{b^2 + \lambda} + \frac{z^2}{c^2 + \lambda} = 1, \quad \lambda \geq 0.$$

The potential is

$$19.33.5 \quad V(\lambda) = Q R_F(a^2 + \lambda, b^2 + \lambda, c^2 + \lambda),$$

and the electric capacity  $C = Q/V(0)$  is given by

$$19.33.6 \quad 1/C = R_F(a^2, b^2, c^2).$$

A conducting elliptic disk is included as the case  $c = 0$ .

**19.33(iii) Depolarization Factors**

Let a homogeneous magnetic ellipsoid with semiaxes  $a, b, c$ , volume  $V = 4\pi abc/3$ , and susceptibility  $\chi$  be placed in a previously uniform magnetic field  $H$  parallel to the principal axis with semiaxis  $c$ . The external field and the induced magnetization together produce a uniform field inside the ellipsoid with strength  $H/(1+L_c\chi)$ , where  $L_c$  is the demagnetizing factor, given in cgs units by

$$19.33.7 \quad L_c = 2\pi abc \int_0^\infty \frac{d\lambda}{\sqrt{(a^2 + \lambda)(b^2 + \lambda)(c^2 + \lambda)^3}} \\ = V R_D(a^2, b^2, c^2).$$

The same result holds for a homogeneous dielectric ellipsoid in an electric field. By (19.21.8),

$$19.33.8 \quad L_a + L_b + L_c = 4\pi,$$

where  $L_a$  and  $L_b$  are obtained from  $L_c$  by permutation of  $a, b$ , and  $c$ . Expressions in terms of Legendre's integrals, numerical tables, and further references are given by Cronmeyer (1991).

**19.33(iv) Self-Energy of an Ellipsoidal Distribution**

Ellipsoidal distributions of charge or mass are used to model certain atomic nuclei and some elliptical galaxies. Let the density of charge or mass be

$$19.33.9 \quad \rho(x, y, z) = f \left( \sqrt{(x^2/\alpha^2) + (y^2/\beta^2) + (z^2/\gamma^2)} \right),$$

where  $\alpha, \beta, \gamma$  are dimensionless positive constants. The contours of constant density are a family of similar, rather than confocal, ellipsoids. In suitable units the self-energy of the distribution is given by

$$19.33.10 \quad U = \frac{1}{2} \int_{\mathbb{R}^6} \frac{\rho(x, y, z)\rho(x', y', z') dx dy dz dx' dy' dz'}{\sqrt{(x-x')^2 + (y-y')^2 + (z-z')^2}}.$$

Subject to mild conditions on  $f$  this becomes

$$19.33.11 \quad U = \frac{1}{2}(\alpha\beta\gamma)^2 R_F(\alpha^2, \beta^2, \gamma^2) \int_0^\infty (g(r))^2 dr,$$

where

$$19.33.12 \quad g(r) = 4\pi \int_r^\infty f(t)t dt.$$

**19.34 Mutual Inductance of Coaxial Circles**

The mutual inductance  $M$  of two coaxial circles of radius  $a$  and  $b$  with centers at a distance  $h$  apart is given in cgs units by

$$19.34.1 \quad \frac{c^2 M}{2\pi} = ab \int_0^{2\pi} (h^2 + a^2 + b^2 - 2ab \cos \theta)^{-1/2} \cos \theta d\theta \\ = 2ab \int_{-1}^1 \frac{t dt}{\sqrt{(1+t)(1-t)(a_3 - 2abt)}} = 2ab I(\mathbf{e}_5),$$

where  $c$  is the speed of light, and in (19.29.11),

$$19.34.2 \quad a_3 = h^2 + a^2 + b^2, \quad a_5 = 0, \quad b_5 = 1.$$

The method of §19.29(ii) uses (19.29.18), (19.29.16), and (19.29.15) to produce

$$19.34.3 \quad 2ab I(\mathbf{e}_5) = a_3 I(\mathbf{0}) - I(\mathbf{e}_3) = a_3 I(\mathbf{0}) - r_+^2 r_-^2 I(-\mathbf{e}_3) \\ = 2ab(I(\mathbf{0}) - r_-^2 I(\mathbf{e}_1 - \mathbf{e}_3)),$$

where  $a_1 + b_1 t = 1 + t$  and

$$19.34.4 \quad r_\pm^2 = a_3 \pm 2ab = h^2 + (a \pm b)^2$$

is the square of the maximum (upper signs) or minimum (lower signs) distance between the circles. Application of (19.29.4) and (19.29.7) with  $\alpha = 1, a_\beta + b_\beta t = 1 - t, \delta = 3$ , and  $a_\gamma + b_\gamma t = 1$  yields

$$19.34.5 \quad \frac{3c^2}{8\pi ab} M = 3R_F(0, r_+^2, r_-^2) - 2r_-^2 R_D(0, r_+^2, r_-^2),$$

or, by (19.21.3),

$$19.34.6 \quad \frac{c^2}{2\pi} M = (r_+^2 + r_-^2) R_F(0, r_+^2, r_-^2) - 4R_G(0, r_+^2, r_-^2).$$

A simpler form of the result is

$$19.34.7 \quad M = (2/c^2)(\pi a^2)(\pi b^2) R_{-\frac{3}{2}}\left(\frac{3}{2}, \frac{3}{2}; r_+^2, r_-^2\right).$$

References for other inductance problems solvable in terms of elliptic integrals are given in Grover (1946, pp. 8 and 283).

**19.35 Other Applications**

**19.35(i) Mathematical**

Generalizations of elliptic integrals appear in analysis of modular theorems of Ramanujan (Anderson *et al.* (2000)); analysis of Selberg integrals (Van Diejen and Spiridonov (2001)); use of Legendre's relation (19.7.1) to compute  $\pi$  to high precision (Borwein and Borwein (1987, p. 26)).

### 19.35(ii) Physical

Elliptic integrals appear in lattice models of critical phenomena (Guttman and Prellberg (1993)); theories of layered materials (Parkinson (1969)); fluid dynamics (Kida (1981)); string theory (Arutyunov and Staudacher (2004)); astrophysics (Dexter and Agol (2009)).

## Computation

### 19.36 Methods of Computation

#### 19.36(i) Duplication Method

Numerical differences between the variables of a symmetric integral can be reduced in magnitude by successive factors of 4 by repeated applications of the duplication theorem, as shown by (19.26.18). When the differences are moderately small, the iteration is stopped, the elementary symmetric functions of certain differences are calculated, and a polynomial consisting of a fixed number of terms of the sum in (19.19.7) is evaluated. For  $R_F$  the polynomial of degree 7, for example, is

$$\begin{aligned} 19.36.1 \quad & 1 - \frac{1}{10}E_2 + \frac{1}{14}E_3 + \frac{1}{24}E_2^2 - \frac{3}{44}E_2E_3 \\ & - \frac{5}{208}E_2^3 + \frac{3}{104}E_3^2 + \frac{1}{16}E_2^2E_3, \end{aligned}$$

where the elementary symmetric functions  $E_s$  are defined by (19.19.4). If (19.36.1) is used instead of its first five terms, then the factor  $(3r)^{-1/6}$  in Carlson (1995, (2.2)) is changed to  $(3r)^{-1/8}$ .

For a polynomial for both  $R_D$  and  $R_J$  see <http://dlmf.nist.gov/19.36.i>.

#### Example

Three applications of (19.26.18) yield

$$19.36.3 \quad R_F(1, 2, 4) = R_F(z_1, z_2, z_3),$$

where, in the notation of (19.19.7) with  $a = -\frac{1}{2}$  and  $n = 3$ ,

$$\begin{aligned} 19.36.4 \quad & z_1 = 2.10985\ 99098\ 8, \quad z_2 = 2.12548\ 49098\ 8, \\ & z_3 = 2.15673\ 49098\ 8, \quad A = 2.13069\ 32432\ 1, \\ & Z_1 = 0.00977\ 77253\ 5, \quad Z_2 = 0.00244\ 44313\ 4, \\ & Z_3 = -Z_1 - Z_2 = -0.01222\ 21566\ 9, \\ & E_2 = -1.25480\ 14 \times 10^{-4}, \quad E_3 = -2.9212 \times 10^{-7}. \end{aligned}$$

The first five terms of (19.36.1) suffice for

$$19.36.5 \quad R_F(1, 2, 4) = 0.68508\ 58166 \dots$$

All cases of  $R_F$ ,  $R_C$ ,  $R_J$ , and  $R_D$  are computed by essentially the same procedure (after transforming Cauchy principal values by means of (19.20.14) and (19.2.20)). Complex values of the variables are allowed,

with some restrictions in the case of  $R_J$  that are sufficient but not always necessary. The computation is slowest for complete cases. For details see Carlson (1995, 2002) and Carlson and FitzSimons (2000). In the Appendix of the last reference it is shown how to compute  $R_J$  without computing  $R_C$  more than once. Because of cancellations in (19.26.21) it is advisable to compute  $R_C$  from  $R_F$  and  $R_D$  by (19.21.10) or else to use §19.36(ii).

Legendre's integrals can be computed from symmetric integrals by using the relations in §19.25(i). Note the remark following (19.25.11). If (19.25.9) is used when  $0 \leq k^2 \leq 1$ , cancellations may lead to loss of significant figures when  $k^2$  is close to 1 and  $\phi > \pi/4$ , as shown by Reinsch and Raab (2000). The cancellations can be eliminated, however, by using (19.25.10).

Accurate values of  $F(\phi, k) - E(\phi, k)$  for  $k^2$  near 0 can be obtained from  $R_D$  by (19.2.6) and (19.25.13).

#### 19.36(ii) Quadratic Transformations

Complete cases of Legendre's integrals and symmetric integrals can be computed with quadratic convergence by the AGM method (including Bartky transformations), using the equations in §19.8(i) and §19.22(ii), respectively.

The incomplete integrals  $R_F(x, y, z)$  and  $R_G(x, y, z)$  can be computed by successive transformations in which two of the three variables converge quadratically to a common value and the integrals reduce to  $R_C$ , accompanied by two quadratically convergent series in the case of  $R_G$ ; compare Carlson (1965, §§5,6). (In Legendre's notation the modulus  $k$  approaches 0 or 1.) Let

$$\begin{aligned} & 2a_{n+1} = a_n + \sqrt{a_n^2 - c_n^2}, \\ 19.36.6 \quad & 2c_{n+1} = a_n - \sqrt{a_n^2 - c_n^2} = c_n^2/(2a_{n+1}), \\ & 2t_{n+1} = t_n + \sqrt{t_n^2 + \theta c_n^2}, \end{aligned}$$

where  $n = 0, 1, 2, \dots$ , and

$$19.36.7 \quad 0 < c_0 < a_0, \quad t_0 \geq 0, \quad t_0^2 + \theta a_0^2 \geq 0, \quad \theta = \pm 1.$$

Then (19.22.18) implies that

$$19.36.8 \quad R_F(t_n^2, t_n^2 + \theta c_n^2, t_n^2 + \theta a_n^2)$$

is independent of  $n$ . As  $n \rightarrow \infty$ ,  $c_n$ ,  $a_n$ , and  $t_n$  converge quadratically to limits 0,  $M$ , and  $T$ , respectively; hence

$$\begin{aligned} 19.36.9 \quad & R_F(t_0^2, t_0^2 + \theta c_0^2, t_0^2 + \theta a_0^2) = R_F(T^2, T^2, T^2 + \theta M^2) \\ & = R_C(T^2 + \theta M^2, T^2). \end{aligned}$$

If  $t_0 = a_0$  and  $\theta = -1$ , so that  $t_n = a_n$ , then this procedure reduces to the AGM method for the complete integral.

The step from  $n$  to  $n + 1$  is an ascending Landen transformation if  $\theta = 1$  (leading ultimately to a hyperbolic case of  $R_C$ ) or a descending Gauss transformation

if  $\theta = -1$  (leading to a circular case of  $R_C$ ). If  $x$ ,  $y$ , and  $z$  are permuted so that  $0 \leq x < y < z$ , then the computation of  $R_F(x, y, z)$  is fastest if we make  $c_0^2 \leq a_0^2/2$  by choosing  $\theta = 1$  when  $y < (x+z)/2$  or  $\theta = -1$  when  $y \geq (x+z)/2$ .

#### Example

We compute  $R_F(1, 2, 4)$  by setting  $\theta = 1$ ,  $t_0 = c_0 = 1$ , and  $a_0 = \sqrt{3}$ . Then

#### 19.36.10

$$c_3^2 = 6.65 \times 10^{-12}, \quad a_3^2 = 2.46209\ 30206\ 0 = M^2, \\ t_3^2 = 1.46971\ 53173\ 1 = T^2.$$

Hence

#### 19.36.11

$$R_F(1, 2, 4) = R_C(T^2 + M^2, T^2) = 0.68508\ 58166,$$

in agreement with (19.36.5). Here  $R_C$  is computed either by the duplication algorithm in Carlson (1995) or via (19.2.19).

For an error estimate and the corresponding procedure for  $R_G(x, y, z)$ , see <http://dlmf.nist.gov/19.36.ii>.

$F(\phi, k)$  can be evaluated by using (19.25.5).  $E(\phi, k)$  can be evaluated by using (19.25.7), and  $R_D$  by using (19.21.10), but cancellations may become significant. Thompson (1997, pp. 499, 504) uses descending Landen transformations for both  $F(\phi, k)$  and  $E(\phi, k)$ . A summary for  $F(\phi, k)$  is given in Gautschi (1975, §3). For computation of  $K(k)$  and  $E(k)$  with complex  $k$  see Fettis and Caslin (1969) and Morita (1978).

(19.22.20) reduces to  $0 = 0$  if  $p = x$  or  $p = y$ , and (19.22.19) reduces to  $0 = 0$  if  $z = x$  or  $z = y$ . Near these points there will be loss of significant figures in the computation of  $R_J$  or  $R_D$ .

Descending Gauss transformations of  $\Pi(\phi, \alpha^2, k)$  (see (19.8.20)) are used in Fettis (1965) to compute a large table (see §19.37(iii)). This method loses significant figures in  $\rho$  if  $\alpha^2$  and  $k^2$  are nearly equal unless they are given exact values—as they can be for tables. If  $\alpha^2 = k^2$ , then the method fails, but the function can be expressed by (19.6.13) in terms of  $E(\phi, k)$ , for which Neuman (1969) uses ascending Landen transformations.

Computation of Legendre's integrals of all three kinds by quadratic transformation is described by Cazenave (1969, pp. 128–159, 208–230).

Quadratic transformations can be applied to compute Bulirsch's integrals (§19.2(iii)). The function  $\text{cel}(k_c, p, a, b)$  is computed by successive Bartky transformations (Bulirsch and Stoer (1968), Bulirsch (1969b)). The function  $\text{el2}(x, k_c, a, b)$  is computed by descending Landen transformations if  $x$  is real, or by descending Gauss transformations if  $x$  is complex (Bulirsch (1965a)). Remedies for cancellation when  $x$  is real and near 0 are supplied in Midy (1975). See also Bulirsch (1969a) and Reinsch and Raab (2000).

Bulirsch (1969a,b) extend Bartky's transformation to  $\text{el3}(x, k_c, p)$  by expressing it in terms of the first incomplete integral, a complete integral of the third kind, and a more complicated integral to which Bartky's method can be applied. The cases  $k_c^2/2 \leq p < \infty$  and  $-\infty < p < k_c^2/2$  require different treatment for numerical purposes, and again precautions are needed to avoid cancellations.

### 19.36(iii) Via Theta Functions

Lee (1990) compares the use of theta functions for computation of  $K(k)$ ,  $E(k)$ , and  $K(k) - E(k)$ ,  $0 \leq k^2 \leq 1$ , with four other methods. Also, see Todd (1975) for a special case of  $K(k)$ . For computation of Legendre's integral of the third kind, see Abramowitz and Stegun (1964, §§17.7 and 17.8, Examples 15, 17, 19, and 20). For integrals of the second and third kinds see Lawden (1989, §§3.4–3.7).

### 19.36(iv) Other Methods

Numerical quadrature is slower than most methods for the standard integrals but can be useful for elliptic integrals that have complicated representations in terms of standard integrals. See §3.5.

For series expansions of Legendre's integrals see §19.5. Faster convergence of power series for  $K(k)$  and  $E(k)$  can be achieved by using (19.5.1) and (19.5.2) in the right-hand sides of (19.8.12). A three-part computational procedure for  $\Pi(\phi, \alpha^2, k)$  is described by Franke (1965) for  $\alpha^2 < 1$ .

When the values of complete integrals are known, addition theorems with  $\psi = \pi/2$  (§19.11(ii)) ease the computation of functions such as  $F(\phi, k)$  when  $\frac{1}{2}\pi - \phi$  is small and positive. Similarly, §19.26(ii) eases the computation of functions such as  $R_F(x, y, z)$  when  $x (> 0)$  is small compared with  $\min(y, z)$ . These special theorems are also useful for checking computer codes.

## 19.37 Tables

### 19.37(i) Introduction

Only tables published since 1960 are included. For earlier tables see Fletcher (1948), Lebedev and Fedorova (1960), and Fletcher *et al.* (1962).

### 19.37(ii) Legendre's Complete Integrals

#### Functions $K(k)$ and $E(k)$

Tabulated for  $k^2 = 0(.01)1$  to 6D by Byrd and Friedman (1971), to 15D for  $K(k)$  and 9D for  $E(k)$  by Abramowitz and Stegun (1964, Chapter 17), and to 10D by Fettis and Caslin (1964).

Tabulated for  $k = 0(.01)1$  to 10D by Fettis and Caslin (1964), and for  $k = 0(.02)1$  to 7D by Zhang and Jin (1996, p. 673).

Tabulated for  $\arcsin k = 0(1^\circ)90^\circ$  to 6D by Byrd and Friedman (1971) and to 15D by Abramowitz and Stegun (1964, Chapter 17).

**Functions  $K(k)$ ,  $K'(k)$ , and  $iK'(k)/K(k)$**

Tabulated with  $k = Re^{i\theta}$  for  $R = 0(.01)1$  and  $\theta = 0(1^\circ)90^\circ$  to 11D by Fettis and Caslin (1969).

**Function  $\exp(-\pi K'(k)/K(k)) (= q(k))$**

Tabulated for  $k^2 = 0(.01)1$  to 6D by Byrd and Friedman (1971) and to 15D by Abramowitz and Stegun (1964, Chapter 17).

Tabulated for  $\arcsin k = 0(1^\circ)90^\circ$  to 6D by Byrd and Friedman (1971) and to 15D by Abramowitz and Stegun (1964, Chapter 17).

Tabulated for  $k^2 = 0(.001)1$  to 8D by Belâkov *et al.* (1962).

### 19.37(iii) Legendre's Incomplete Integrals

**Functions  $F(\phi, k)$  and  $E(\phi, k)$**

Tabulated for  $\phi = 0(5^\circ)90^\circ$ ,  $k^2 = 0(.01)1$  to 10D by Fettis and Caslin (1964).

Tabulated for  $\phi = 0(1^\circ)90^\circ$ ,  $k^2 = 0(.01)1$  to 7S by Belâkov *et al.* (1962). ( $F(\phi, k)$  is presented as  $\Pi(\phi, 0, k)$ .)

Tabulated for  $\phi = 0(5^\circ)90^\circ$ ,  $k = 0(.01)1$  to 10D by Fettis and Caslin (1964).

Tabulated for  $\phi = 0(5^\circ)90^\circ$ ,  $\arcsin k = 0(1^\circ)90^\circ$  to 6D by Byrd and Friedman (1971), for  $\phi = 0(5^\circ)90^\circ$ ,  $\arcsin k = 0(2^\circ)90^\circ$  and  $5^\circ(10^\circ)85^\circ$  to 8D by Abramowitz and Stegun (1964, Chapter 17), and for  $\phi = 0(10^\circ)90^\circ$ ,  $\arcsin k = 0(5^\circ)90^\circ$  to 9D by Zhang and Jin (1996, pp. 674–675).

**Function  $\Pi(\phi, \alpha^2, k)$**

Tabulated (with different notation) for  $\phi = 0(15^\circ)90^\circ$ ,  $\alpha^2 = 0(.1)1$ ,  $\arcsin k = 0(15^\circ)90^\circ$  to 5D by Abramowitz and Stegun (1964, Chapter 17), and for  $\phi = 0(15^\circ)90^\circ$ ,  $\alpha^2 = 0(.1)1$ ,  $\arcsin k = 0(15^\circ)90^\circ$  to 7D by Zhang and Jin (1996, pp. 676–677).

Tabulated for  $\phi = 5^\circ(5^\circ)80^\circ(2.5^\circ)90^\circ$ ,  $\alpha^2 = -1(.1) - 0.1, 0.1(.1)1$ ,  $k^2 = 0(.05)0.9(.02)1$  to 10D by Fettis and Caslin (1964) (and warns of inaccuracies in Selfridge and Maxfield (1958) and Paxton and Rollin (1959)).

Tabulated for  $\phi = 0(1^\circ)90^\circ$ ,  $\alpha^2 = 0(.05)0.85, 0.88(.02)0.94(.01)0.98(.005)1$ ,  $k^2 = 0(.01)1$  to 7S by Belâkov *et al.* (1962).

### 19.37(iv) Symmetric Integrals

**Functions  $R_F(x^2, 1, y^2)$  and  $R_G(x^2, 1, y^2)$**

Tabulated for  $x = 0(.1)1$ ,  $y = 1(.2)6$  to 3D by Nellis and Carlson (1966).

**Function  $R_F(a^2, b^2, c^2)$  with  $abc = 1$**

Tabulated for  $\sigma = 0(.05)0.5(.1)1(.2)2(.5)5$ ,  $\cos(3\gamma) = -1(.2)1$  to 5D by Carlson (1961a). Here  $\sigma^2 = \frac{2}{3}((\ln a)^2 + (\ln b)^2 + (\ln c)^2)$ ,  $\cos(3\gamma) = (4/\sigma^3)(\ln a)(\ln b)(\ln c)$ , and  $a, b, c$  are semiaxes of an ellipsoid with the same volume as the unit sphere.

**Check Values**

For check values of symmetric integrals with real or complex variables to 14S see Carlson (1995).

## 19.38 Approximations

Minimax polynomial approximations (§3.11(i)) for  $K(k)$  and  $E(k)$  in terms of  $m = k^2$  with  $0 \leq m < 1$  can be found in Abramowitz and Stegun (1964, §17.3) with maximum absolute errors ranging from  $4 \times 10^{-5}$  to  $2 \times 10^{-8}$ . Approximations of the same type for  $K(k)$  and  $E(k)$  for  $0 < k \leq 1$  are given in Cody (1965a) with maximum absolute errors ranging from  $4 \times 10^{-5}$  to  $4 \times 10^{-18}$ . Cody (1965b) gives Chebyshev-series expansions (§3.11(ii)) with maximum precision 25D.

Approximations for Legendre's complete or incomplete integrals of all three kinds, derived by Padé approximation of the square root in the integrand, are given in Luke (1968, 1970). They are valid over parts of the complex  $k$  and  $\phi$  planes. The accuracy is controlled by the number of terms retained in the approximation; for real variables the number of significant figures appears to be roughly twice the number of terms retained, perhaps even for  $\phi$  near  $\pi/2$  with the improvements made in the 1970 reference.

## 19.39 Software

See <http://dlmf.nist.gov/19.39>.

## References

### General References

The main references used for writing this chapter are Erdélyi *et al.* (1953b), Byerly (1888), Cazenave (1969), and Byrd and Friedman (1971) for Legendre's integrals, and Carlson (1977b) for symmetric integrals. For additional bibliographic reading see Cayley (1895), Greenhill (1892), Legendre (1825–1832), Tricomi (1951), and Whittaker and Watson (1927).



## Sources

The following list gives the references or other indications of proofs that were used in constructing the various sections of this chapter. These sources supplement the references that are quoted in the text.

**§19.2** Bulirsch (1965a, 1969a,b), Bulirsch and Stoer (1968). To prove (19.2.20) evaluate the two parts of the Cauchy principal value (intervals  $(0, -y - \delta)$  and  $(-y + \delta, \infty)$ ) using Carlson (1977b, (8.2-2)), and reduce the first part to  $R_C$  by Carlson (1977b, (9.8-4)) with  $B = C$ . Apply (19.12.7) to both parts as  $\delta \rightarrow 0$  and combine the two logarithms. For (19.2.21) see (19.16.18) and put  $\cos \theta = v$  in (19.23.8). For (19.2.22) put  $z = x$  in (19.23.5) and interchange  $x$  and  $y$ .

**§19.3** The graphics were produced at NIST.

**§19.4** Cazenave (1969, p. 175). (19.4.1)–(19.4.7) follow by differentiation of the definitions in §19.2(ii). (19.4.8) agrees also with Edwards (1954, vol. 1, p. 402) and with expansion to first order in  $k$ . The term on the right side in Byrd and Friedman (1971, 118.01) has the wrong sign.

**§19.5** For (19.5.1)–(19.5.4) put  $\sin \phi = 1$  and  $t = \sqrt{x}$  in (19.2.4)–(19.2.7). Then compare with Erdélyi *et al.* (1953a, 2.1.3(10) and 2.1.1(2)) in the first three cases, and with Erdélyi *et al.* (1953a, 5.8.2(5) and 5.7.1(6)) in the fourth case. For (19.5.5) and (19.5.6) see Kneser (1927, (12) and p. 218); Byrd and Friedman (1971, 901.00) is incorrect. (19.5.8) and (19.5.9) follow from Borwein and Borwein (1987, (2.1.13) and (2.3.17), respectively). For (19.5.10) iterate (19.8.12).

**§19.6** For the first line of (19.6.2) put  $\alpha = k$  in the first line of (19.25.2) and use the last line of (19.25.1). For the second line of (19.6.2), and also for (19.6.5), use (19.7.8) and (19.6.15). For the first line of (19.6.6) use (19.6.5) and (19.6.2). For more detail as  $k^2 \rightarrow 1-$  see §19.12. For (19.6.7), (19.6.8) use (19.2.4), (19.16.6), and (19.25.5). For (19.6.9), (19.6.10) use (19.2.5). For (19.6.11)–(19.6.14) Byrd and Friedman (1971, 111.01 and 111.04, p. 10) also needs  $\alpha \sin \phi < 1$ . Start with (19.25.14). For the second equation of (19.6.12) use (19.20.8). For (19.6.13) use (19.16.5) with (19.25.10) and (19.25.11).

**§19.7** Three proofs of (19.7.1) are given in Duren (1991). To prove it from (19.21.1) put  $z + 1 = 1/k^2$ , use homogeneity, and apply the penultimate equation in (19.25.1) twice. For

(19.7.4)–(19.7.7) see the penultimate paragraph in §19.25(i). (19.7.8)–(19.7.10) follow from the change of parameter for the symmetric integral of the third kind; see §19.21(iii) and (19.25.14).

**§19.8** Cox (1984, 1985), Borwein and Borwein (1987, Chapter 1), Cazenave (1969, pp. 114–127). To prove the second equality in (19.8.4), put  $\tan \theta = \sqrt{t}/g_0$ . (19.8.7) is derived from (19.22.12) and (19.25.14), and (19.8.9) is derived from (19.6.5) and (19.8.7); see also Carlson (2002). For (19.8.16) and (19.8.17) replace  $(\phi, k)$  by  $(\phi_2, k_2)$ , and then  $(\phi_1, k_1)$  by  $(\phi, k)$  in (19.8.11) and (19.8.13). See also Hancock (1958, pp. 74–77) for proof of (19.8.13) and (19.8.17).

**§19.9** For (19.9.1) see Erdélyi *et al.* (1953b, §13.8(9),(11)), (19.9.13), (19.6.12), and (19.6.15). For (19.9.2) and (19.9.3) see Qiu and Vamanamurthy (1996). For (19.9.4) see Barnard *et al.* (2000, (6)); the first inequality was given earlier by Qiu and Shen (1997, Theorem 2). For (19.9.5) see Lehto and Virtanen (1973, p. 62). For (19.9.6) and (19.9.7) see (19.25.1) and (19.16.21) and then apply Carlson (1966, (2.15)), in which  $H < H'$  for  $0 < k \leq 1$  in both cases. In (19.9.7) the upper bound  $4/\pi$ , which is the smaller of the two when  $k^2 \geq 0.855\dots$ , is given by Anderson and Vamanamurthy (1985). For (19.9.8) see (19.25.1), Neuman (2003, (4.2)), and (19.24.9). For (19.9.9) see (19.30.5). For (19.9.14) see (19.24.10) and (19.25.5). For (19.9.15) and (19.9.16) see Carlson and Gustafson (1985, (1.2), (1.22)).

**§19.10** For (19.10.1) see (19.2.17). For (19.10.2) use (19.6.8).

**§19.11** Byerly (1888, pp. 243–245, 256–258), Edwards (1954, v. 2, pp. 511–513), Cazenave (1969, pp. 83–85). (19.11.5) can be derived from (19.26.9), (19.25.26), and (19.11.1).

**§19.12** For (19.12.1) and (19.12.2) see Cayley (1895, p. 54) and Cazenave (1969, pp. 165–169). For (19.12.4) and (19.12.5) use (19.25.2), (19.27.13), and (19.6.5). For (19.12.6) and (19.12.7) see Carlson and Gustafson (1994, (22),(24)).

**§19.14** For (19.14.1)–(19.14.3) see Cazenave (1969, pp. 286,276). For (19.14.4) use (19.29.19) and (19.25.24).

**§19.16** See Carlson (1977b, (6.8-6), Ex. 6.8-8, and (5.9-1)). To prove (19.16.12) put  $t = \csc^2 \theta - \csc^2 \phi$  in the first integral in (19.16.9). For (19.16.19) and (19.16.23) see Carlson (1977b, (5.9-19) and (8.3-4)). To derive (19.16.24) exchange subscripts 1

and  $n$  in Carlson (1963, (7.4)), put  $t = s/z_1$ , and use (19.16.19).

§19.17 The graphics were produced at NIST.

§19.18 (19.18.1) is derived from (19.16.1), (19.16.5), and (19.18.4). (19.18.2) follows from (19.18.8). For (19.18.4) and (19.18.5) put  $t = -a$  and  $c = a + a'$  in Carlson (1977b, (5.9-9),(5.9-10)). (19.18.6) comes from (19.18.8) and (19.20.25). For (19.18.8) and (19.18.11) see Carlson (1977b, (5.9-2)). For (19.18.12)–(19.18.17) see Carlson (1977b, §5.4).

§19.19 To prove (19.19.2) expand the product in (19.23.10) in powers of  $u$ . (19.19.3) is derived from (19.16.11) and (19.19.2). For (19.19.5) see Carlson (1979, (A.12)). For (19.19.6) compare (19.16.2) and (19.16.9).

§19.20 In (19.20.2) put  $t = 1/\sqrt{s+1}$ ; alternatively use (19.29.19). For the second equality replace  $t^4$  by  $t$  and apply (5.12.1). For (19.20.3) use Carlson (1977b, Ex. 6.9-5 and p. 309) and (19.25.42). For (19.20.4) use (19.20.5) and (19.16.3). For (19.20.5) put  $z = y$  in (19.21.10). For (19.20.6) substitute in (19.16.2) and (19.16.5). In (19.20.7) see (19.27.12) for  $p \rightarrow 0+$ ; for  $p \rightarrow 0-$  use (19.20.17) and (19.6.15). In (19.20.8) the third equation is proved by partial fractions, and also implies the first two equations by (19.6.15). For (19.20.9) put  $x = 0$  in (19.20.13). For (19.20.10) interchange  $x$  and  $z$  in (19.27.14) and use (19.6.15). For (19.20.11) use (19.27.13), (19.20.17), and (19.27.2). For (19.20.12) see (19.27.11) and (19.21.12). For (19.20.13) let  $q = p$  in (19.21.12). For (19.20.14) exchange  $x$  and  $z$  in (19.21.12) and use (19.2.20). For the third equation in (19.20.18) put  $t = y \tan^2 \theta$  in (19.16.5); for the fourth equation see (19.27.7). For (19.20.19) see (19.27.8). For (19.20.20) and (19.20.21) use (19.16.15), (19.16.9), and Carlson (1977b, Table 8.5-1). In (19.20.22) put  $t = 1/\sqrt{s+1}$ ; alternatively use (19.29.20). For the second equality replace  $t^4$  by  $t$  and apply (5.12.1). For (19.20.23) use Carlson (1977b, Ex. 6.9-5 and p. 309) and (19.25.42). For (19.20.24)–(19.20.26) see Carlson (1977b, (6.2-1),(6.8-15)).

§19.21 To prove (19.21.1) see the text following (19.21.6), use (19.20.10), and analytic continuation. For (19.21.2) put  $x = 0$  in (19.21.9). For (19.21.3) put  $x = 0$  in (19.21.11) and (19.21.10). (19.21.6) is equivalent to Zill and Carlson (1970, (7.15)). For (19.21.8) and (19.21.9) see Carlson (1977b, (5.9-5),(5.9-6)) and (19.20.25). To obtain

(19.21.7) eliminate  $R_D(z, x, y)$  between (19.21.8) and (19.21.9), which follow from Carlson (1977b, (5.9-5, (6.6-5), and (5.9-6))). For (19.21.10) see Carlson (1977b, Table 9.3-1). To prove (19.21.11) write  $xt/(t+x) = x - (x^2/(t+x))$  in (19.23.7) and similarly for  $y$  and  $z$ . Then use (19.21.9). For (19.21.12)–(19.21.15) see Zill and Carlson (1970, (4.6)).

§19.22 In (19.22.18), (19.22.21), and (19.22.20), put  $z = 0$  to obtain (19.22.1), (19.22.2), and (19.22.4), respectively. (19.22.3) is derivable from (19.22.2) and (19.21.3), or more directly by putting  $p = y$  in (19.22.7). For (19.22.7) see Carlson (1976, (4.14),(4.13)), where  $(\pi/4)R_L(y, z, p) = R_F(0, y, z) - (p/3)R_J(0, y, z, p)$ . For (19.22.8)–(19.22.15) iterate the results given in §19.22(i); see also (19.16.20), (19.16.23), and Carlson (2002, Section 2). For (19.22.18) see Carlson (1964, (5.13)). For (19.22.19) put  $p = z$  in (19.22.20). For (19.22.20) see Zill and Carlson (1970, (5.7)) and Carlson (1990, (8.5)). For (19.22.21) see Carlson (1964, (5.16)). For (19.22.22) put  $z = y$  in (19.22.18). In the ascending Landen case let  $k^2 = (z_+^2 - z_-^2)/(z_+^2 - a^2)$  and  $k_1^2 = (z^2 - y^2)/(z^2 - x^2)$  to get the second equation in (19.8.11). In the descending Gauss case let  $k_1^2 = (a^2 - z_-^2)/(a^2 - z_+^2)$  and  $k^2 = (z^2 - y^2)/(z^2 - x^2)$  to get the first equation in (19.8.11).

§19.23 For (19.23.8) and (19.23.9) see Carlson (1977b, Exercises 5.9-19, 5.9-20, and p. 306). By §19.16(iii), (19.23.8) implies (19.23.1)–(19.23.3), and (19.23.9) implies (19.23.6). Use (19.23.8) to integrate over  $\theta$  in (19.23.6) and then permute variables to prove (19.23.5). To prove (19.23.4) put  $z = 0$  in (19.23.5), relabel variables, and substitute  $\cos \theta = \operatorname{sech} t$ . For (19.23.7) and (19.23.10) see Carlson (1977b, (9.1-9) and (6.8-2), respectively).

§19.24 For (19.24.1)–(19.24.3) use (19.9.1) and (19.9.4). For (19.24.4) see (19.16.22) and Carlson (1966, (2.15)). For (19.24.3) see (19.30.5). (19.24.8) is a special case of (19.24.13). For (19.24.9) see Neuman (2003, (4.2)).

§19.25 (19.25.1), (19.25.2), and (19.25.3) are derived from the incomplete cases. For (19.25.4) put  $c = 1$  in (19.25.16). (19.25.5) and (19.25.7) come from Carlson (1977b, (9.3-2) and (9.3-3)). For (19.25.6) and (19.25.12) apply (19.18.4) to (19.25.5) and (19.25.8), respectively. (19.25.8) and (19.25.15) are special cases of (19.16.12). To get (19.25.9), (19.25.10), and (19.25.11), let  $(c-1, c-k^2, c) = (x, y, z)$  and eliminate  $R_G$  between (19.25.7) and

each of the three forms of (19.25.10) obtained by permuting  $x, y$  and  $z$ . For (19.25.13) combine (19.2.6) and (19.25.9). For (19.25.14) see Zill and Carlson (1970, (2.5)). For (19.25.16) substitute (19.25.14) in (19.7.8) and use (19.2.20). For (19.25.19)–(19.25.22) rewrite Bulirsch's integrals (§19.2(iii)) in terms of Legendre's integrals, then use §19.25(i) to convert them to  $R$ -functions. For (19.25.24)–(19.25.27) define  $c = \csc^2 \phi$ , write  $(x, y, z, p)/(z - x) = (c - 1, c - k^2, c, c - \alpha^2)$ , then use (19.25.5), (19.25.9), (19.25.14), and (19.25.7) to prove (19.25.24), (19.25.25), (19.25.26), and (19.25.27), respectively. To prove (19.25.29) use  $(\text{cs}, \text{ds}, \text{ns}) = (\text{cn}, \text{dn}, 1)/\text{sn}$  (suppressing variables  $(u, k)$ ). For (19.25.30) see Carlson (2006a, Comments following proof of Proposition 4.1). For (19.25.31) see Carlson (2004, (1.8)). In (19.25.32), (19.25.33), and (19.25.34), substitute  $x = \text{ps}(u, k)$ ,  $\text{sp}(u, k)$ , and  $\text{pq}(u, k)$ , respectively, to recover (19.25.31). To prove (19.25.35) use (23.6.36), with  $z = \wp(w)$  as prescribed in the text that follows (23.6.36), substitute  $u = t + \wp(w)$  and compare with (19.16.1). Then put  $z = \omega_j$  to obtain (19.25.38). For (19.25.37) and (19.25.39) see Carlson (1964, (3.10) and (3.2)). For (19.25.40) combine Erdélyi *et al.* (1953b, §§13.12(22), 13.13(22)) and (19.25.35).

**§19.26** Addition theorems (and therefore duplication theorems) for the symmetric integrals are proved by Zill and Carlson (1970, §8). For other proofs of (19.26.1) see Carlson (1977b, §9.7) and Carlson (1978, Theorem 3). To prove (19.26.13) use (19.2.9) to show that  $2\sqrt{\theta} R_C(\sigma^2, \sigma^2 - \theta) = \ln\left((\sigma + \sqrt{\theta})/(\sigma - \sqrt{\theta})\right)$ , then apply this to all three terms. To prove (19.26.14) put  $z = y$  in (19.21.12) and use (19.20.8). For (19.26.17) put  $\theta = -\alpha\beta$  in (19.26.13) and use homogeneity. For (19.26.18)–(19.26.27) put  $\mu = \lambda$  in the formulas of §19.26(i). For proofs of (19.26.18) not invoking the addition theorem, see Carlson (1977b, §9.6) and Carlson (1998, §2). Equations (19.26.25) and (19.26.20) are degenerate cases of (19.26.18) and (19.26.22), respectively.

**§19.27** Carlson and Gustafson (1994). For (19.27.2) see Carlson and Gustafson (1985).

**§19.28** To prove (19.28.1)–(19.28.3) from (19.28.4) use §19.16(iii). To prove (19.28.4) expand the  $R$ -function in powers of  $1 - t$  by (19.19.3), integrate term by term, and use Erdélyi *et al.* (1953a, 2.8(46)). (19.28.5) is equivalent to (19.18.1). In (19.28.6) let  $v = \sqrt{u}$  and use Carlson (1963,

(7.9)). In (19.28.7) substitute (19.16.2), change the order of integration, and use (19.29.4). Use Carlson (1963, (7.11)) and (19.16.20) to prove (19.28.8) and (19.28.10). In the first case Carlson (1977b, (5.9-21)) is needed; in the second case put  $(z_1, z_2, \zeta_1, \zeta_2) = (a^2, b^2, c^2, d^2)$ , use Carlson (1977b, (9.8-4)), and substitute  $t = (ab/cd)\exp(2z)$ . To prove (19.28.9) from (19.28.10), put  $a = \exp(ix) = 1/b$ ,  $c = \exp(iy) = 1/d$ ,  $\cosh z = 1/\sin \theta$ , and on the right-hand side use (19.22.1).

**§19.29** For (19.29.4) see Carlson (1998, (3.6)). For (19.29.7), a special case of (19.29.8), see also Carlson (1987, (4.14)). For (19.29.8) see Carlson (1999, (4.10)) and Carlson (1988, (5.6)). For (19.29.10) see Byrd and Friedman (1971, p. 76, Eq. (234.13), and p. 74) for notation. Then use Carlson (2006b, (3.2)) with  $(p, q, r) = (n, d, c)$  for reduction to  $R_D$ . For (19.29.19)–(19.29.33) take  $t^2$  as a new variable where appropriate. Then factor quadratic polynomials, use (19.29.4), and apply (19.22.18) to remove any complex quantities. For (19.29.20) use (19.29.7) with  $a_\alpha + b_\alpha t = t$  and  $a_\delta + b_\delta t = 1$ . For (19.29.21) use (19.29.7) with  $a_\alpha + b_\alpha t = 1$  and  $a_\delta + b_\delta t = t$ . With regard to (19.29.28) see Carlson (1977a, p. 238).

**§19.30** Carlson (1977b, §9.4 and Ex. 8.3-7, with solution on p. 312). For (19.30.5) see (19.25.1). For (19.30.6) use (19.4.6).

**§19.32** Carlson (1977b, pp. 234–235). For (19.32.2) use (19.18.6).

**§19.33** Carlson (1977b, pp. 271, 313, (9.4-10), and Ex. 9.4-3) and Carlson (1961a). For other proofs of (19.33.1) and (19.33.2) see Watson (1935b), Bowman (1953, pp. 31–32), and Carlson (1964, p. 417). For the first equality in (19.33.7) see Becker and Sauter (1964, p. 106).

**§19.34** For (19.34.1) see Becker and Sauter (1964, p. 194). For (19.34.7) see Carlson (1977b, Ex. 9.3-2 and p. 313); alternatively, substitute Carlson (1977b, (9.2-3) and (9.2-2)) in (19.34.6) and use Carlson (1977b, Table 9.3-2).

**§19.36** For the quadratic transformations see Carlson (1965, (3.1), (3.2), Sections 5, 6). To obtain (19.36.6) and (19.36.8) from (19.22.18), let  $(x^2, y^2, z^2) = (t_n^2, t_n^2 + \theta c_n^2, t_n^2 + \theta a_n^2)$  and  $(a^2, z_-^2, z_+^2) = (t_{n+1}^2, t_{n+1}^2 + \theta c_{n+1}^2, t_{n+1}^2 + \theta a_{n+1}^2)$ . Then use the expression for  $z_\pm^2 - a^2$  from (19.22.17) and the definition of  $a$  from (19.22.16).

## Chapter 20

# Theta Functions

W. P. Reinhardt<sup>1</sup> and P. L. Walker<sup>2</sup>

<b>Notation</b>	<b>524</b>	20.10 Integrals . . . . .	532
20.1 Special Notation . . . . .	524	20.11 Generalizations and Analogs . . . . .	532
<b>Properties</b>	<b>524</b>	<b>Applications</b>	<b>533</b>
20.2 Definitions and Periodic Properties . . . . .	524	20.12 Mathematical Applications . . . . .	533
20.3 Graphics . . . . .	525	20.13 Physical Applications . . . . .	533
20.4 Values at $z = 0$ . . . . .	529	<b>Computation</b>	<b>534</b>
20.5 Infinite Products and Related Results . . . . .	529	20.14 Methods of Computation . . . . .	534
20.6 Power Series . . . . .	530	20.15 Tables . . . . .	534
20.7 Identities . . . . .	530	20.16 Software . . . . .	534
20.8 Watson's Expansions . . . . .	531	<b>References</b>	<b>534</b>
20.9 Relations to Other Functions . . . . .	532		

<sup>1</sup>University of Washington, Seattle, Washington.

<sup>2</sup>American University of Sharjah, Sharjah, United Arab Emirates.

**Acknowledgments:** This chapter is based in part on Abramowitz and Stegun (1964, Chapter 16), by L. M. Milne-Thomson.  
**Copyright** © 2009 National Institute of Standards and Technology. All rights reserved.

## Notation

### 20.1 Special Notation

(For other notation see pp. xiv and 873.)

- $m, n$  integers.
- $z (\in \mathbb{C})$  the argument.
- $\tau (\in \mathbb{C})$  the lattice parameter,  $\Im\tau > 0$ .
- $q (\in \mathbb{C})$  the nome,  $q = e^{i\alpha\pi\tau}$ ,  $0 < |q| < 1$ . Since  $\tau$  is not a single-valued function of  $q$ , it is assumed that  $\tau$  is known, even when  $q$  is specified. Most applications concern the rectangular case  $\Re\tau = 0$ ,  $\Im\tau > 0$ , so that  $0 < q < 1$  and  $\tau$  and  $q$  are uniquely related.
- $q^\alpha$   $e^{i\alpha\pi\tau}$  for  $\alpha \in \mathbb{R}$  (resolving issues of choice of branch).
- $S_1/S_2$  set of all elements of  $S_1$ , modulo elements of  $S_2$ . Thus two elements of  $S_1/S_2$  are equivalent if they are both in  $S_1$  and their difference is in  $S_2$ . (For an example see §20.12(ii).)

The main functions treated in this chapter are the theta functions  $\theta_j(z|\tau) = \theta_j(z, q)$  where  $j = 1, 2, 3, 4$  and  $q = e^{i\pi\tau}$ . When  $\tau$  is fixed the notation is often abbreviated in the literature as  $\theta_j(z)$ , or even as simply  $\theta_j$ , it being then understood that the argument is the primary variable. Sometimes the theta functions are called the Jacobian or classical theta functions to distinguish them from generalizations; compare Chapter 21.

Primes on the  $\theta$  symbols indicate derivatives with respect to the argument of the  $\theta$  function.

#### Other Notations

Jacobi's original notation:  $\Theta(z|\tau)$ ,  $\Theta_1(z|\tau)$ ,  $\mathbf{H}(z|\tau)$ ,  $\mathbf{H}_1(z|\tau)$ , respectively, for  $\theta_4(u|\tau)$ ,  $\theta_3(u|\tau)$ ,  $\theta_1(u|\tau)$ ,  $\theta_2(u|\tau)$ , where  $u = z/\theta_3^2(0|\tau)$ . Here the symbol  $\mathbf{H}$  denotes capital eta. See, for example, Whittaker and Watson (1927, p. 479) and Copson (1935, pp. 405, 411).

Neville's notation:  $\theta_s(z|\tau)$ ,  $\theta_c(z|\tau)$ ,  $\theta_d(z|\tau)$ ,  $\theta_n(z|\tau)$ , respectively, for  $\theta_3^2(0|\tau)\theta_1(u|\tau)/\theta_1'(0|\tau)$ ,  $\theta_2(u|\tau)/\theta_2(0|\tau)$ ,  $\theta_3(u|\tau)/\theta_3(0|\tau)$ ,  $\theta_4(u|\tau)/\theta_4(0|\tau)$ , where again  $u = z/\theta_3^2(0|\tau)$ . This notation simplifies the relationship of the theta functions to Jacobian elliptic functions (§22.2); see Neville (1951).

McKean and Moll's notation:  $\vartheta_j(z|\tau) = \theta_j(\pi z|\tau)$ ,  $j = 1, 2, 3, 4$ . See McKean and Moll (1999, p. 125).

Additional notations that have been used in the literature are summarized in Whittaker and Watson (1927, p. 487).

## Properties

### 20.2 Definitions and Periodic Properties

#### 20.2(i) Fourier Series

$$\begin{aligned} \theta_1(z|\tau) &= \theta_1(z, q) \\ 20.2.1 \quad &= 2 \sum_{n=0}^{\infty} (-1)^n q^{(n+\frac{1}{2})^2} \sin((2n+1)z), \\ 20.2.2 \quad \theta_2(z|\tau) &= \theta_2(z, q) = 2 \sum_{n=0}^{\infty} q^{(n+\frac{1}{2})^2} \cos((2n+1)z), \\ 20.2.3 \quad \theta_3(z|\tau) &= \theta_3(z, q) = 1 + 2 \sum_{n=1}^{\infty} q^{n^2} \cos(2nz), \\ 20.2.4 \quad \theta_4(z|\tau) &= \theta_4(z, q) = 1 + 2 \sum_{n=1}^{\infty} (-1)^n q^{n^2} \cos(2nz). \end{aligned}$$

Corresponding expansions for  $\theta'_j(z|\tau)$ ,  $j = 1, 2, 3, 4$ , can be found by differentiating (20.2.1)–(20.2.4) with respect to  $z$ .

#### 20.2(ii) Periodicity and Quasi-Periodicity

For fixed  $\tau$ , each  $\theta_j(z|\tau)$  is an entire function of  $z$  with period  $2\pi$ ;  $\theta_1(z|\tau)$  is odd in  $z$  and the others are even. For fixed  $z$ , each of  $\theta_1(z|\tau)/\sin z$ ,  $\theta_2(z|\tau)/\cos z$ ,  $\theta_3(z|\tau)$ , and  $\theta_4(z|\tau)$  is an analytic function of  $\tau$  for  $\Im\tau > 0$ , with a natural boundary  $\Im\tau = 0$ , and correspondingly, an analytic function of  $q$  for  $|q| < 1$  with a natural boundary  $|q| = 1$ .

The four points  $(0, \pi, \pi + \tau\pi, \tau\pi)$  are the vertices of the *fundamental parallelogram* in the  $z$ -plane; see Figure 20.2.1. The points

$$20.2.5 \quad z_{m,n} = (m + n\tau)\pi, \quad m, n \in \mathbb{Z},$$

are the *lattice points*. The theta functions are quasi-periodic on the lattice:

$$20.2.6 \quad \theta_1(z + (m + n\tau)\pi|\tau) = (-1)^{m+n} q^{-n^2} e^{-2inz} \theta_1(z|\tau),$$

$$20.2.7 \quad \theta_2(z + (m + n\tau)\pi|\tau) = (-1)^m q^{-n^2} e^{-2inz} \theta_2(z|\tau),$$

$$20.2.8 \quad \theta_3(z + (m + n\tau)\pi|\tau) = q^{-n^2} e^{-2inz} \theta_3(z|\tau),$$

$$20.2.9 \quad \theta_4(z + (m + n\tau)\pi|\tau) = (-1)^n q^{-n^2} e^{-2inz} \theta_4(z|\tau).$$

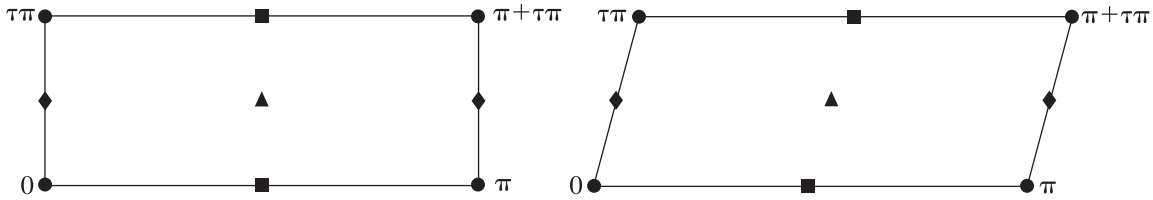


Figure 20.2.1:  $z$ -plane. Fundamental parallelogram. Left-hand diagram is the rectangular case ( $\tau$  purely imaginary); right-hand diagram is the general case.  $\bullet$  zeros of  $\theta_1(z|\tau)$ ,  $\blacksquare$  zeros of  $\theta_2(z|\tau)$ ,  $\blacktriangle$  zeros of  $\theta_3(z|\tau)$ ,  $\blacklozenge$  zeros of  $\theta_4(z|\tau)$ .

**20.2(iii) Translation of the Argument by Half-Periods**

With

20.2.10  $M \equiv M(z|\tau) = e^{iz + (i\pi\tau/4)},$   
 20.2.11  $\theta_1(z|\tau) = -\theta_2(z + \frac{1}{2}\pi|\tau) = -iM\theta_4(z + \frac{1}{2}\pi\tau|\tau)$   
 $= -iM\theta_3(z + \frac{1}{2}\pi + \frac{1}{2}\pi\tau|\tau),$   
 20.2.12  $\theta_2(z|\tau) = \theta_1(z + \frac{1}{2}\pi|\tau) = M\theta_3(z + \frac{1}{2}\pi\tau|\tau)$   
 $= M\theta_4(z + \frac{1}{2}\pi + \frac{1}{2}\pi\tau|\tau),$   
 20.2.13  $\theta_3(z|\tau) = \theta_4(z + \frac{1}{2}\pi|\tau) = M\theta_2(z + \frac{1}{2}\pi\tau|\tau)$   
 $= M\theta_1(z + \frac{1}{2}\pi + \frac{1}{2}\pi\tau|\tau),$   
 20.2.14  $\theta_4(z|\tau) = \theta_3(z + \frac{1}{2}\pi|\tau) = -iM\theta_1(z + \frac{1}{2}\pi\tau|\tau)$   
 $= iM\theta_2(z + \frac{1}{2}\pi + \frac{1}{2}\pi\tau|\tau).$

**20.2(iv)  $z$ -Zeros**

For  $m, n \in \mathbb{Z}$ , the  $z$ -zeros of  $\theta_j(z|\tau)$ ,  $j = 1, 2, 3, 4$ , are  $(m + n\tau)\pi$ ,  $(m + \frac{1}{2} + n\tau)\pi$ ,  $(m + \frac{1}{2} + (n + \frac{1}{2})\tau)\pi$ ,  $(m + (n + \frac{1}{2})\tau)\pi$  respectively.

**20.3 Graphics**

**20.3(i)  $\theta$ -Functions: Real Variable and Real Nome**

See Figures 20.3.1–20.3.13.

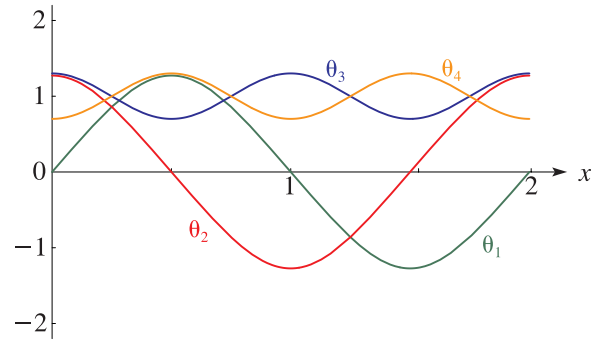


Figure 20.3.1:  $\theta_j(\pi x, 0.15)$ ,  $0 \leq x \leq 2$ ,  $j = 1, 2, 3, 4$ .

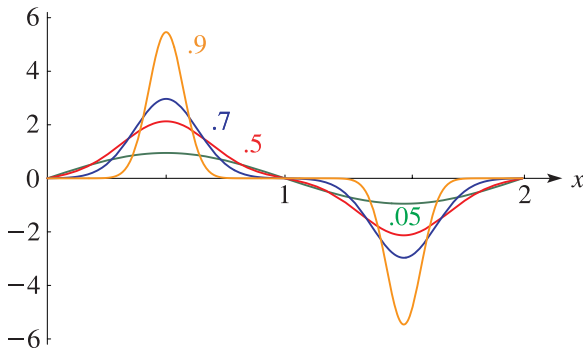


Figure 20.3.2:  $\theta_1(\pi x, q)$ ,  $0 \leq x \leq 2$ ,  $q = 0.05, 0.5, 0.7, 0.9$ . For  $q \leq q^{\text{Dedekind}}$ ,  $\theta_1(\pi x, q)$  is convex in  $x$  for  $0 < x < 1$ . Here  $q^{\text{Dedekind}} = e^{-\pi y_0} = 0.19$  approximately, where  $y = y_0$  corresponds to the maximum value of Dedekind's eta function  $\eta(iy)$  as depicted in Figure 23.16.1.

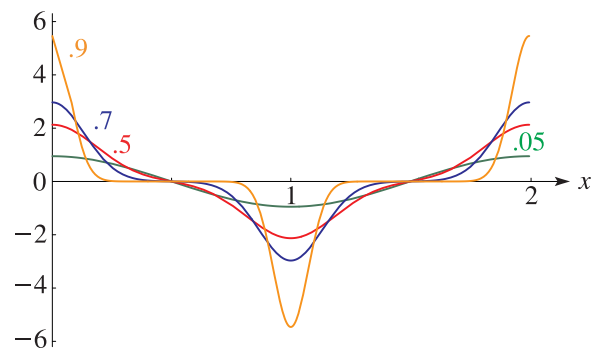


Figure 20.3.3:  $\theta_2(\pi x, q)$ ,  $0 \leq x \leq 2$ ,  $q = 0.05, 0.5, 0.7, 0.9$ .

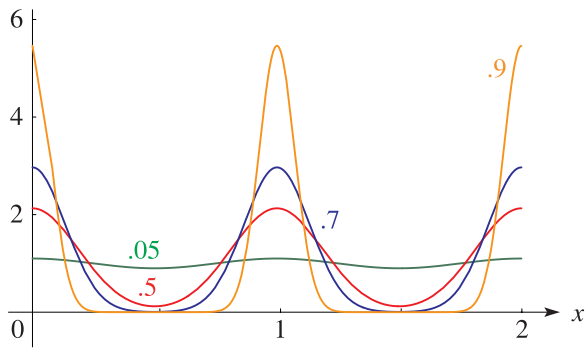


Figure 20.3.4:  $\theta_3(\pi x, q)$ ,  $0 \leq x \leq 2$ ,  $q = 0.05, 0.5, 0.7, 0.9$ .

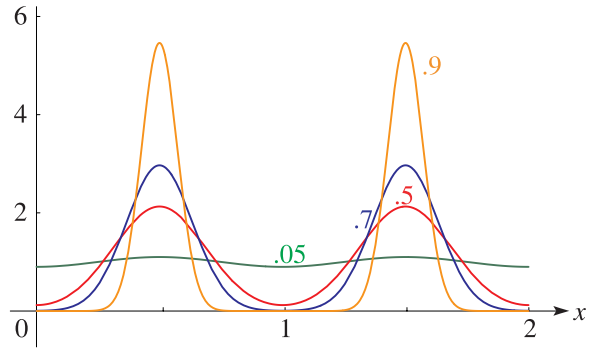


Figure 20.3.5:  $\theta_4(\pi x, q)$ ,  $0 \leq x \leq 2$ ,  $q = 0.05, 0.5, 0.7, 0.9$ .

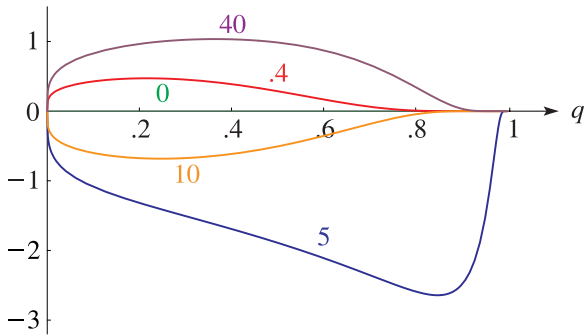


Figure 20.3.6:  $\theta_1(x, q)$ ,  $0 \leq q \leq 1$ ,  $x = 0, 0.4, 5, 10, 40$ .

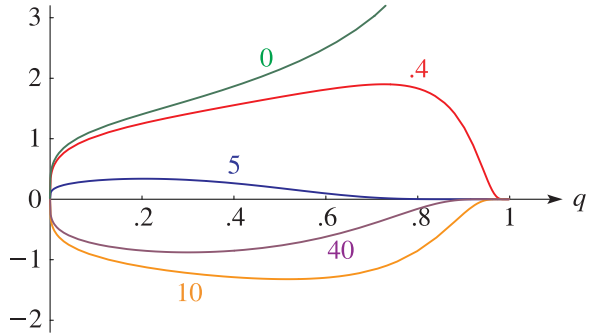


Figure 20.3.7:  $\theta_2(x, q)$ ,  $0 \leq q \leq 1$ ,  $x = 0, 0.4, 5, 10, 40$ .

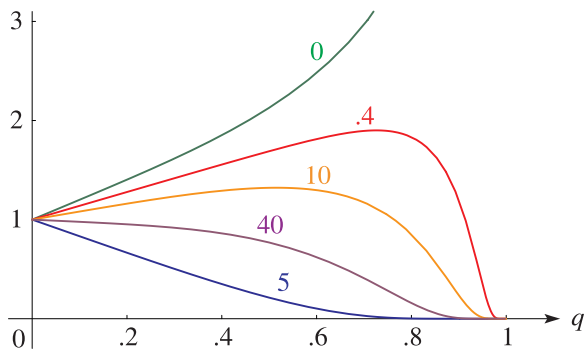


Figure 20.3.8:  $\theta_3(x, q)$ ,  $0 \leq q \leq 1$ ,  $x = 0, 0.4, 5, 10, 40$ .

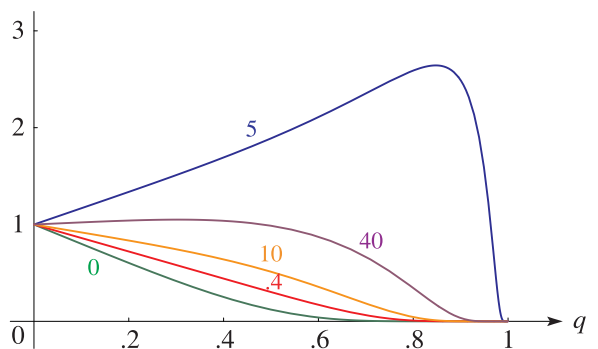


Figure 20.3.9:  $\theta_4(x, q)$ ,  $0 \leq q \leq 1$ ,  $x = 0, 0.4, 5, 10, 40$ .

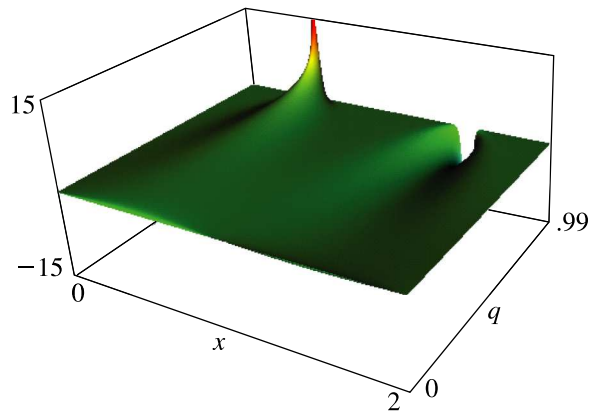


Figure 20.3.10:  $\theta_1(\pi x, q)$ ,  $0 \leq x \leq 2$ ,  $0 \leq q \leq 0.99$ .

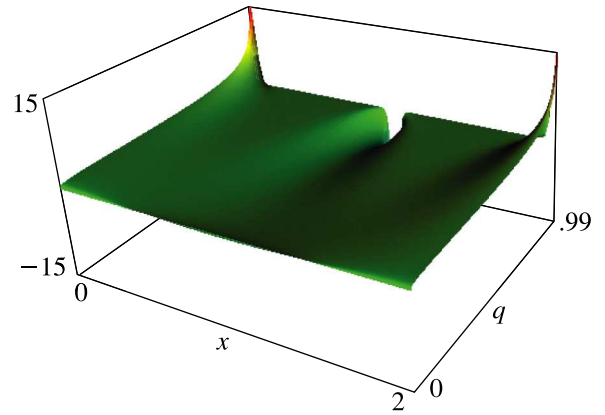


Figure 20.3.11:  $\theta_2(\pi x, q)$ ,  $0 \leq x \leq 2$ ,  $0 \leq q \leq 0.99$ .

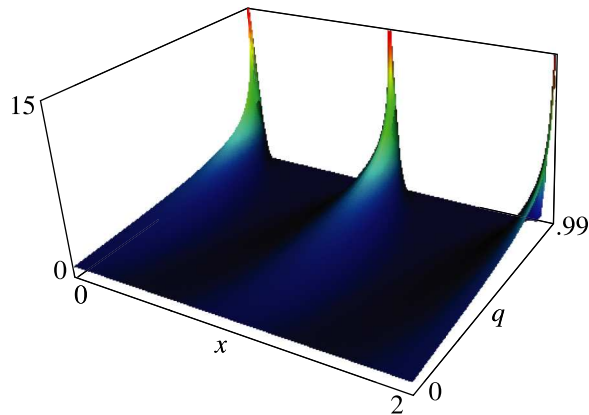


Figure 20.3.12:  $\theta_3(\pi x, q)$ ,  $0 \leq x \leq 2$ ,  $0 \leq q \leq 0.99$ .

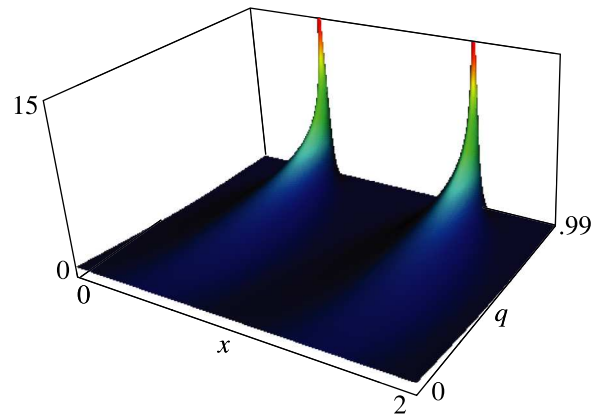


Figure 20.3.13:  $\theta_4(\pi x, q)$ ,  $0 \leq x \leq 2$ ,  $0 \leq q \leq 0.99$ .

**20.3(ii)  $\theta$ -Functions: Complex Variable and Real Nome**

See Figures 20.3.14–20.3.17. In these graphics, height corresponds to the absolute value of the function and color to the phase. See also p. xiv.

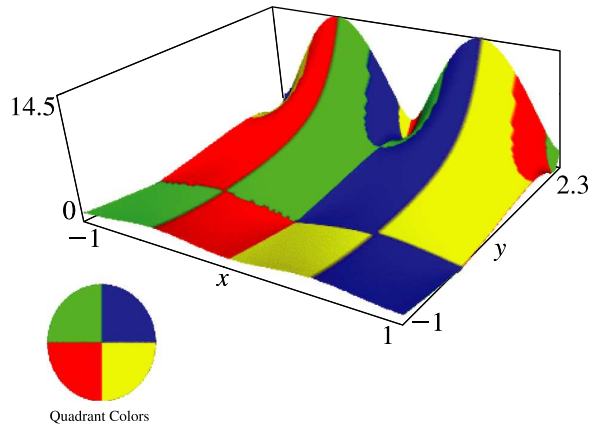


Figure 20.3.14:  $\theta_1(\pi x + iy, 0.12)$ ,  $-1 \leq x \leq 1$ ,  $-1 \leq y \leq 2.3$ .

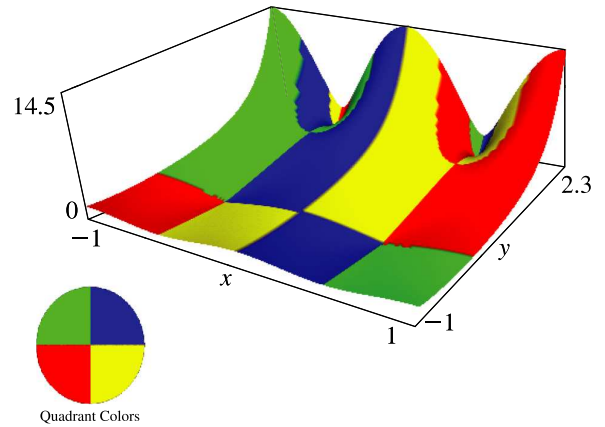


Figure 20.3.15:  $\theta_2(\pi x + iy, 0.12)$ ,  $-1 \leq x \leq 1$ ,  $-1 \leq y \leq 2.3$ .



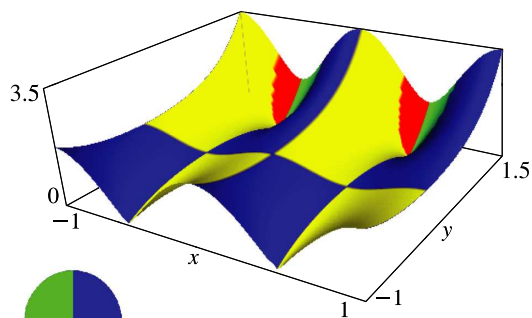


Figure 20.3.16:  $\theta_3(\pi x + iy, 0.12)$ ,  $-1 \leq x \leq 1$ ,  $-1 \leq y \leq 1.5$ .

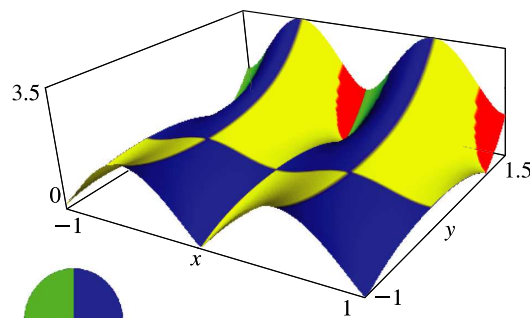


Figure 20.3.17:  $\theta_4(\pi x + iy, 0.12)$ ,  $-1 \leq x \leq 1$ ,  $-1 \leq y \leq 1.5$ .

**20.3(iii)  $\theta$ -Functions: Real Variable and Complex Lattice Parameter**

See Figures 20.3.18–20.3.21. In these graphics this subsection, height corresponds to the absolute value of the function and color to the phase. See also p. xiv.

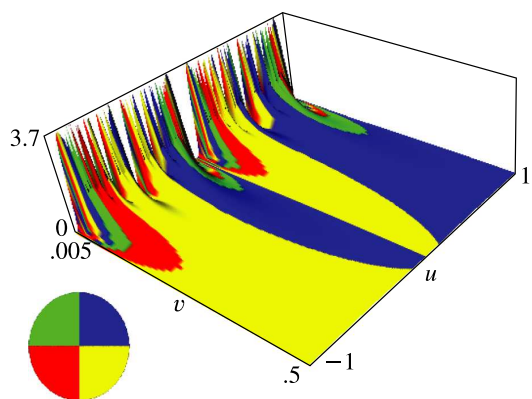


Figure 20.3.18:  $\theta_1(0.1|u + iv)$ ,  $-1 \leq u \leq 1$ ,  $0.005 \leq v \leq 0.5$ . The value 0.1 of  $z$  is chosen arbitrarily since  $\theta_1$  vanishes identically when  $z = 0$ .

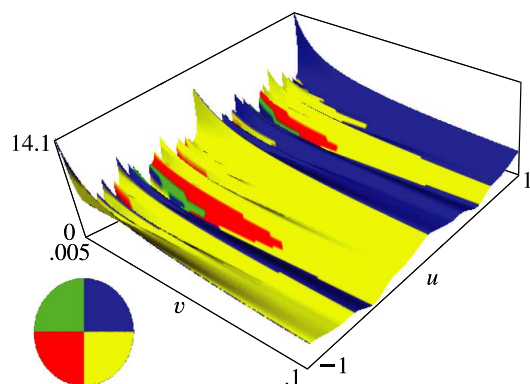


Figure 20.3.19:  $\theta_2(0|u + iv)$ ,  $-1 \leq u \leq 1$ ,  $0.005 \leq v \leq 0.1$ .

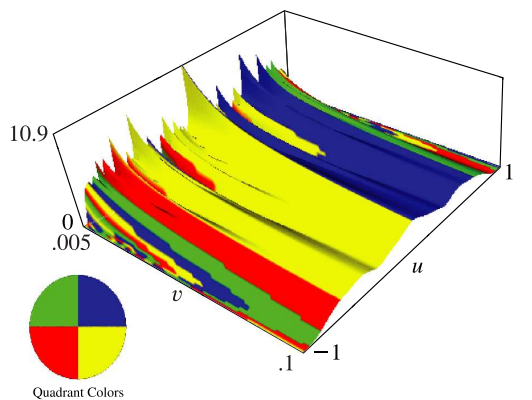


Figure 20.3.20:  $\theta_3(0|u + iv)$ ,  $-1 \leq u \leq 1$ ,  $0.005 \leq v \leq 0.1$ .

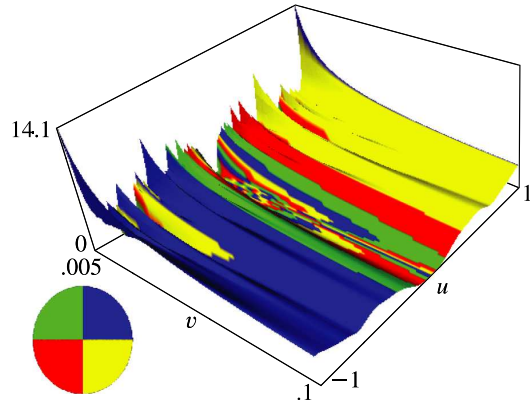


Figure 20.3.21:  $\theta_4(0|u + iv)$ ,  $-1 \leq u \leq 1$ ,  $0.005 \leq v \leq 0.1$ .

## 20.4 Values at $z = 0$

### 20.4(i) Functions and First Derivatives

20.4.1  $\theta_1(0, q) = \theta_2'(0, q) = \theta_3'(0, q) = \theta_4'(0, q) = 0,$

20.4.2  $\theta_1'(0, q) = 2q^{1/4} \prod_{n=1}^{\infty} (1 - q^{2n})^3,$

20.4.3  $\theta_2(0, q) = 2q^{1/4} \prod_{n=1}^{\infty} (1 - q^{2n}) (1 + q^{2n})^2,$

20.4.4  $\theta_3(0, q) = \prod_{n=1}^{\infty} (1 - q^{2n}) (1 + q^{2n-1})^2,$

20.4.5  $\theta_4(0, q) = \prod_{n=1}^{\infty} (1 - q^{2n}) (1 - q^{2n-1})^2.$

#### Jacobi's Identity

20.4.6  $\theta_1'(0, q) = \theta_2(0, q) \theta_3(0, q) \theta_4(0, q).$

### 20.4(ii) Higher Derivatives

20.4.7  $\theta_1''(0, q) = \theta_2'''(0, q) = \theta_3'''(0, q) = \theta_4'''(0, q) = 0.$

20.4.8  $\frac{\theta_1'''(0, q)}{\theta_1'(0, q)} = -1 + 24 \sum_{n=1}^{\infty} \frac{q^{2n}}{(1 - q^{2n})^2}.$

20.4.9  $\frac{\theta_2''(0, q)}{\theta_2(0, q)} = -1 - 8 \sum_{n=1}^{\infty} \frac{q^{2n}}{(1 + q^{2n})^2},$

20.4.10  $\frac{\theta_3''(0, q)}{\theta_3(0, q)} = -8 \sum_{n=1}^{\infty} \frac{q^{2n-1}}{(1 + q^{2n-1})^2},$

20.4.11  $\frac{\theta_4''(0, q)}{\theta_4(0, q)} = 8 \sum_{n=1}^{\infty} \frac{q^{2n-1}}{(1 - q^{2n-1})^2}.$

20.4.12  $\frac{\theta_1'''(0, q)}{\theta_1'(0, q)} = \frac{\theta_2''(0, q)}{\theta_2(0, q)} + \frac{\theta_3''(0, q)}{\theta_3(0, q)} + \frac{\theta_4''(0, q)}{\theta_4(0, q)}.$

## 20.5 Infinite Products and Related Results

### 20.5(i) Single Products

20.5.1  $\theta_1(z, q) = 2q^{1/4} \sin z \prod_{n=1}^{\infty} (1 - q^{2n}) (1 - 2q^{2n} \cos(2z) + q^{4n}),$

20.5.2  $\theta_2(z, q) = 2q^{1/4} \cos z \prod_{n=1}^{\infty} (1 - q^{2n}) (1 + 2q^{2n} \cos(2z) + q^{4n}),$

20.5.3  $\theta_3(z, q) = \prod_{n=1}^{\infty} (1 - q^{2n}) (1 + 2q^{2n-1} \cos(2z) + q^{4n-2}),$

### 20.5.4

$$\theta_4(z, q) = \prod_{n=1}^{\infty} (1 - q^{2n}) (1 - 2q^{2n-1} \cos(2z) + q^{4n-2}).$$

### 20.5.5

$$\theta_1(z|\tau) = \theta_1'(0|\tau) \sin z \prod_{n=1}^{\infty} \frac{\sin(n\pi\tau + z) \sin(n\pi\tau - z)}{\sin^2(n\pi\tau)},$$

### 20.5.6

$$\theta_2(z|\tau) = \theta_2(0|\tau) \cos z \prod_{n=1}^{\infty} \frac{\cos(n\pi\tau + z) \cos(n\pi\tau - z)}{\cos^2(n\pi\tau)},$$

### 20.5.7

$$\begin{aligned} \theta_3(z|\tau) &= \theta_3(0|\tau) \prod_{n=1}^{\infty} \frac{\cos((n - \frac{1}{2})\pi\tau + z) \cos((n - \frac{1}{2})\pi\tau - z)}{\cos^2((n - \frac{1}{2})\pi\tau)}, \\ &= \theta_3(0|\tau) \prod_{n=1}^{\infty} \frac{\cos((n - \frac{1}{2})\pi\tau + z) \cos((n - \frac{1}{2})\pi\tau - z)}{\cos^2((n - \frac{1}{2})\pi\tau)}, \end{aligned}$$

### 20.5.8

$$\begin{aligned} \theta_4(z|\tau) &= \theta_4(0|\tau) \prod_{n=1}^{\infty} \frac{\sin((n - \frac{1}{2})\pi\tau + z) \sin((n - \frac{1}{2})\pi\tau - z)}{\sin^2((n - \frac{1}{2})\pi\tau)}. \\ &= \theta_4(0|\tau) \prod_{n=1}^{\infty} \frac{\sin((n - \frac{1}{2})\pi\tau + z) \sin((n - \frac{1}{2})\pi\tau - z)}{\sin^2((n - \frac{1}{2})\pi\tau)}. \end{aligned}$$

#### Jacobi's Triple Product

### 20.5.9

$$\begin{aligned} \theta_3(\pi z|\tau) &= \sum_{n=-\infty}^{\infty} p^{2n} q^{n^2} \\ &= \prod_{n=1}^{\infty} (1 - q^{2n}) (1 + q^{2n-1} p^2) (1 + q^{2n-1} p^{-2}), \end{aligned}$$

where  $p = e^{i\pi z}$ ,  $q = e^{i\pi\tau}$ .

### 20.5(ii) Logarithmic Derivatives

When  $|\Im z| < \pi\Im\tau$ ,

### 20.5.10

$$\begin{aligned} \frac{\theta_1'(z, q)}{\theta_1(z, q)} - \cot z &= 4 \sin(2z) \sum_{n=1}^{\infty} \frac{q^{2n}}{1 - 2q^{2n} \cos(2z) + q^{4n}} \\ &= 4 \sum_{n=1}^{\infty} \frac{q^{2n}}{1 - q^{2n}} \sin(2nz), \end{aligned}$$

### 20.5.11

$$\begin{aligned} \frac{\theta_2'(z, q)}{\theta_2(z, q)} + \tan z &= -4 \sin(2z) \sum_{n=1}^{\infty} \frac{q^{2n}}{1 + 2q^{2n} \cos(2z) + q^{4n}} \\ &= 4 \sum_{n=1}^{\infty} (-1)^n \frac{q^{2n}}{1 - q^{2n}} \sin(2nz). \end{aligned}$$

The left-hand sides of (20.5.10) and (20.5.11) are replaced by their limiting values when  $\cot z$  or  $\tan z$  are undefined.

When  $|\Im z| < \frac{1}{2}\pi\Im\tau$ ,

### 20.5.12

$$\begin{aligned} \frac{\theta_3'(z, q)}{\theta_3(z, q)} &= -4 \sin(2z) \sum_{n=1}^{\infty} \frac{q^{2n-1}}{1 + 2q^{2n-1} \cos(2z) + q^{4n-2}} \\ &= 4 \sum_{n=1}^{\infty} (-1)^n \frac{q^n}{1 - q^{2n}} \sin(2nz), \end{aligned}$$

**20.5.13**

$$\frac{\theta'_4(z, q)}{\theta_4(z, q)} = 4 \sin(2z) \sum_{n=1}^{\infty} \frac{q^{2n-1}}{1 - 2q^{2n-1} \cos(2z) + q^{4n-2}}$$

$$= 4 \sum_{n=1}^{\infty} \frac{q^n}{1 - q^{2n}} \sin(2nz).$$

With the given conditions the infinite series in (20.5.10)–(20.5.13) converge absolutely and uniformly in compact sets in the  $z$ -plane.

**20.5(iii) Double Products**

**20.5.14**

$$\theta_1(z|\tau) = z \theta'_1(0|\tau) \lim_{N \rightarrow \infty} \prod_{n=-N}^N \lim_{M \rightarrow \infty} \prod_{\substack{m=-M \\ |m|+|n| \neq 0}}^M \left( 1 + \frac{z}{(m+n\tau)\pi} \right),$$

**20.5.15**

$$\theta_2(z|\tau) = \theta_2(0|\tau) \lim_{N \rightarrow \infty} \prod_{n=-N}^N \lim_{M \rightarrow \infty} \prod_{m=1-M}^M \left( 1 + \frac{z}{(m - \frac{1}{2} + n\tau)\pi} \right),$$

**20.5.16**

$$\theta_3(z|\tau) = \theta_3(0|\tau) \lim_{N \rightarrow \infty} \prod_{n=1-N}^N \lim_{M \rightarrow \infty} \prod_{m=1-M}^M \left( 1 + \frac{z}{(m - \frac{1}{2} + (n - \frac{1}{2})\tau)\pi} \right),$$

**20.5.17**

$$\theta_4(z|\tau) = \theta_4(0|\tau) \lim_{N \rightarrow \infty} \prod_{n=1-N}^N \lim_{M \rightarrow \infty} \prod_{m=-M}^M \left( 1 + \frac{z}{(m + (n - \frac{1}{2})\tau)\pi} \right).$$

These double products are not absolutely convergent; hence the order of the limits is important. The order shown is in accordance with the Eisenstein convention (Walker (1996, §0.3)).

**20.6 Power Series**

Assume

**20.6.1**  $|\pi z| < \min |z_{m,n}|$ , where  $z_{m,n}$  is given by (20.2.5) and the minimum is for  $m, n \in \mathbb{Z}$ , except  $m = n = 0$ . Then

**20.6.2**  $\theta_1(\pi z|\tau) = \pi z \theta'_1(0|\tau) \exp \left( - \sum_{j=1}^{\infty} \frac{1}{2j} \delta_{2j}(\tau) z^{2j} \right),$

**20.6.3**  $\theta_2(\pi z|\tau) = \theta_2(0|\tau) \exp \left( - \sum_{j=1}^{\infty} \frac{1}{2j} \alpha_{2j}(\tau) z^{2j} \right),$

**20.6.4**  $\theta_3(\pi z|\tau) = \theta_3(0|\tau) \exp \left( - \sum_{j=1}^{\infty} \frac{1}{2j} \beta_{2j}(\tau) z^{2j} \right),$

**20.6.5**  $\theta_4(\pi z|\tau) = \theta_4(0|\tau) \exp \left( - \sum_{j=1}^{\infty} \frac{1}{2j} \gamma_{2j}(\tau) z^{2j} \right).$

Here the coefficients are given by

**20.6.6**  $\delta_{2j}(\tau) = \sum_{n=-\infty}^{\infty} \sum_{\substack{m=-\infty \\ |m|+|n| \neq 0}}^{\infty} (m+n\tau)^{-2j},$

**20.6.7**  $\alpha_{2j}(\tau) = \sum_{n=-\infty}^{\infty} \sum_{m=-\infty}^{\infty} (m - \frac{1}{2} + n\tau)^{-2j},$

**20.6.8**  $\beta_{2j}(\tau) = \sum_{n=-\infty}^{\infty} \sum_{m=-\infty}^{\infty} (m - \frac{1}{2} + (n - \frac{1}{2})\tau)^{-2j},$

**20.6.9**  $\gamma_{2j}(\tau) = \sum_{n=-\infty}^{\infty} \sum_{m=-\infty}^{\infty} (m + (n - \frac{1}{2})\tau)^{-2j},$

and satisfy

**20.6.10**  $\alpha_{2j}(\tau) = 2^{2j} \delta_{2j}(2\tau) - \delta_{2j}(\tau),$   
 $\beta_{2j}(\tau) = 2^{2j} \gamma_{2j}(2\tau) - \gamma_{2j}(\tau).$

In the double series the order of summation is important only when  $j = 1$ . For further information on  $\delta_{2j}$  see §23.9: since the double sums in (20.6.6) and (23.9.1) are the same, we have  $\delta_{2n} = c_n/(2n - 1)$  when  $n \geq 2$ .

**20.7 Identities**

**20.7(i) Sums of Squares**

**20.7.1**  $\theta_3^2(0, q) \theta_3^2(z, q) = \theta_4^2(0, q) \theta_4^2(z, q) + \theta_2^2(0, q) \theta_2^2(z, q),$

**20.7.2**  $\theta_3^2(0, q) \theta_4^2(z, q) = \theta_2^2(0, q) \theta_1^2(z, q) + \theta_4^2(0, q) \theta_3^2(z, q),$

**20.7.3**  $\theta_2^2(0, q) \theta_4^2(z, q) = \theta_3^2(0, q) \theta_1^2(z, q) + \theta_4^2(0, q) \theta_2^2(z, q),$

**20.7.4**  $\theta_2^2(0, q) \theta_3^2(z, q) = \theta_4^2(0, q) \theta_1^2(z, q) + \theta_3^2(0, q) \theta_2^2(z, q).$

Also

**20.7.5**  $\theta_3^4(0, q) = \theta_2^4(0, q) + \theta_4^4(0, q).$

**20.7(ii) Addition Formulas**

20.7.6  $\theta_4^2(0, q) \theta_1(w + z, q) \theta_1(w - z, q)$   
 $= \theta_3^2(w, q) \theta_2^2(z, q) - \theta_2^2(w, q) \theta_3^2(z, q),$

20.7.7  $\theta_4^2(0, q) \theta_2(w + z, q) \theta_2(w - z, q)$   
 $= \theta_4^2(w, q) \theta_2^2(z, q) - \theta_1^2(w, q) \theta_3^2(z, q),$

20.7.8  $\theta_4^2(0, q) \theta_3(w + z, q) \theta_3(w - z, q)$   
 $= \theta_4^2(w, q) \theta_3^2(z, q) - \theta_1^2(w, q) \theta_2^2(z, q),$

20.7.9  $\theta_4^2(0, q) \theta_4(w + z, q) \theta_4(w - z, q)$   
 $= \theta_3^2(w, q) \theta_3^2(z, q) - \theta_2^2(w, q) \theta_2^2(z, q).$

For these and similar formulas see Lawden (1989, §1.4) and Whittaker and Watson (1927, pp. 487–488).

**20.7(iii) Duplication Formula**

20.7.10  $\theta_1(2z, q) = 2 \frac{\theta_1(z, q) \theta_2(z, q) \theta_3(z, q) \theta_4(z, q)}{\theta_2(0, q) \theta_3(0, q) \theta_4(0, q)}.$

**20.7(iv) Transformations of Nome**

20.7.11  $\frac{\theta_1(z, q) \theta_2(z, q)}{\theta_1(2z, q^2)} = \frac{\theta_3(z, q) \theta_4(z, q)}{\theta_4(2z, q^2)} = \theta_4(0, q^2),$

20.7.12  $\frac{\theta_1(z, q^2) \theta_4(z, q^2)}{\theta_1(z, q)} = \frac{\theta_2(z, q^2) \theta_3(z, q^2)}{\theta_2(z, q)} = \frac{1}{2} \theta_2(0, q).$

20.7.21  $\theta_1(4z|4\tau) = B \theta_1(z|\tau) \theta_1(\frac{1}{4}\pi - z|\tau) \theta_1(\frac{1}{4}\pi + z|\tau) \theta_2(z|\tau),$

20.7.22  $\theta_2(4z|4\tau) = B \theta_2(\frac{1}{8}\pi - z|\tau) \theta_2(\frac{1}{8}\pi + z|\tau) \theta_2(\frac{3}{8}\pi - z|\tau) \theta_2(\frac{3}{8}\pi + z|\tau),$

20.7.23  $\theta_3(4z|4\tau) = B \theta_3(\frac{1}{8}\pi - z|\tau) \theta_3(\frac{1}{8}\pi + z|\tau) \theta_3(\frac{3}{8}\pi - z|\tau) \theta_3(\frac{3}{8}\pi + z|\tau),$

20.7.24  $\theta_4(4z|4\tau) = B \theta_4(z|\tau) \theta_4(\frac{1}{4}\pi - z|\tau) \theta_4(\frac{1}{4}\pi + z|\tau) \theta_3(z|\tau).$

**20.7(vii) Derivatives of Ratios of Theta Functions**

20.7.25  $\frac{d}{dz} \left( \frac{\theta_2(z|\tau)}{\theta_4(z|\tau)} \right) = - \frac{\theta_3^2(0|\tau) \theta_1(z|\tau) \theta_3(z|\tau)}{\theta_4^2(z|\tau)}.$

See Lawden (1989, pp. 19–20). This reference also gives ten additional identities involving permutations of the four theta functions.

**20.7(viii) Transformations of Lattice Parameter**

20.7.26  $\theta_1(z|\tau + 1) = e^{i\pi/4} \theta_1(z|\tau),$

20.7.27  $\theta_2(z|\tau + 1) = e^{i\pi/4} \theta_2(z|\tau),$

20.7.28  $\theta_3(z|\tau + 1) = \theta_4(z|\tau),$

20.7.29  $\theta_4(z|\tau + 1) = \theta_3(z|\tau).$

**20.7(v) Watson's Identities**

20.7.13

$\theta_1(z, q) \theta_1(w, q) = \theta_3(z + w, q^2) \theta_2(z - w, q^2)$   
 $- \theta_2(z + w, q^2) \theta_3(z - w, q^2),$

20.7.14

$\theta_3(z, q) \theta_3(w, q) = \theta_3(z + w, q^2) \theta_3(z - w, q^2)$   
 $+ \theta_2(z + w, q^2) \theta_2(z - w, q^2).$

**20.7(vi) Landen Transformations**

With

20.7.15  $A \equiv A(\tau) = 1/\theta_4(0|2\tau),$

20.7.16  $\theta_1(2z|2\tau) = A \theta_1(z|\tau) \theta_2(z|\tau),$

20.7.17  $\theta_2(2z|2\tau) = A \theta_1(\frac{1}{4}\pi - z|\tau) \theta_1(\frac{1}{4}\pi + z|\tau),$

20.7.18  $\theta_3(2z|2\tau) = A \theta_3(\frac{1}{4}\pi - z|\tau) \theta_3(\frac{1}{4}\pi + z|\tau),$

20.7.19  $\theta_4(2z|2\tau) = A \theta_3(z|\tau) \theta_4(z|\tau).$

Next, with

20.7.20  $B \equiv B(\tau) = 1/(\theta_3(0|\tau) \theta_4(0|\tau) \theta_3(\frac{1}{4}\pi|\tau)),$

In the following equations  $\tau' = -1/\tau$ , and all square roots assume their principal values.

20.7.30  $(-i\tau)^{1/2} \theta_1(z|\tau) = -i \exp(i\tau' z^2/\pi) \theta_1(z\tau'|\tau'),$

20.7.31  $(-i\tau)^{1/2} \theta_2(z|\tau) = \exp(i\tau' z^2/\pi) \theta_4(z\tau'|\tau'),$

20.7.32  $(-i\tau)^{1/2} \theta_3(z|\tau) = \exp(i\tau' z^2/\pi) \theta_3(z\tau'|\tau'),$

20.7.33  $(-i\tau)^{1/2} \theta_4(z|\tau) = \exp(i\tau' z^2/\pi) \theta_2(z\tau'|\tau').$

These are examples of modular transformations; see §23.15.

**20.8 Watson's Expansions**

20.8.1

$\frac{\theta_2(0, q) \theta_3(z, q) \theta_4(z, q)}{\theta_2(z, q)} = 2 \sum_{n=-\infty}^{\infty} \frac{(-1)^n q^{n^2} e^{i2nz}}{q^{-n} e^{-iz} + q^n e^{iz}}.$

See Watson (1935a). This reference and Bellman (1961, pp. 46–47) include other expansions of this type.

## 20.9 Relations to Other Functions

### 20.9(i) Elliptic Integrals

With  $k$  defined by

$$20.9.1 \quad k = \theta_2^2(0|\tau) / \theta_3^2(0|\tau)$$

and the notation of §19.2(ii), the complete Legendre integrals of the first kind may be expressed as theta functions:

$$20.9.2 \quad K(k) = \frac{1}{2}\pi \theta_3^2(0|\tau), \quad K'(k) = -i\tau K(k),$$

together with (22.2.1).

In the case of the symmetric integrals, with the notation of §19.16(i) we have

$$20.9.3 \quad R_F\left(\frac{\theta_2^2(z, q)}{\theta_2^2(0, q)}, \frac{\theta_3^2(z, q)}{\theta_3^2(0, q)}, \frac{\theta_4^2(z, q)}{\theta_4^2(0, q)}\right) = \frac{\theta_1'(0, q)}{\theta_1(z, q)} z,$$

$$20.9.4 \quad R_F(0, \theta_3^4(0, q), \theta_4^4(0, q)) = \frac{1}{2}\pi,$$

$$20.9.5 \quad \exp\left(-\frac{\pi R_F(0, k^2, 1)}{R_F(0, k'^2, 1)}\right) = q.$$

### 20.9(ii) Elliptic Functions and Modular Functions

See §§22.2 and 23.6(i) for the relations of Jacobian and Weierstrass elliptic functions to theta functions.

The relations (20.9.1) and (20.9.2) between  $k$  and  $\tau$  (or  $q$ ) are solutions of *Jacobi's inversion problem*; see Baker (1995) and Whittaker and Watson (1927, pp. 480–485).

As a function of  $\tau$ ,  $k^2$  is the *elliptic modular function*; see Walker (1996, Chapter 7) and (23.15.2), (23.15.6).

### 20.9(iii) Riemann Zeta Function

See Koblitz (1993, Ch. 2, §4) and Titchmarsh (1986b, pp. 21–22). See also §§20.10(i) and 25.2.

## 20.10 Integrals

### 20.10(i) Mellin Transforms with respect to the Lattice Parameter

Let  $s$  be a constant such that  $\Re s > 2$ . Then

$$20.10.1 \quad \int_0^\infty x^{s-1} \theta_2(0|ix^2) dx = 2^s (1 - 2^{-s}) \pi^{-s/2} \Gamma(\frac{1}{2}s) \zeta(s),$$

$$20.10.2 \quad \int_0^\infty x^{s-1} (\theta_3(0|ix^2) - 1) dx = \pi^{-s/2} \Gamma(\frac{1}{2}s) \zeta(s),$$

$$20.10.3 \quad \int_0^\infty x^{s-1} (1 - \theta_4(0|ix^2)) dx = (1 - 2^{1-s}) \pi^{-s/2} \Gamma(\frac{1}{2}s) \zeta(s).$$

Here  $\zeta(s)$  again denotes the Riemann zeta function (§25.2).

For further results see Oberhettinger (1974, pp. 157–159).

### 20.10(ii) Laplace Transforms with respect to the Lattice Parameter

Let  $s$ ,  $\ell$ , and  $\beta$  be constants such that  $\Re s > 0$ ,  $\ell > 0$ , and  $\sinh|\beta| \leq \ell$ . Then

$$\int_0^\infty e^{-st} \theta_1\left(\frac{\beta\pi}{2\ell} \middle| \frac{i\pi t}{\ell^2}\right) dt$$

$$20.10.4 \quad = \int_0^\infty e^{-st} \theta_2\left(\frac{(1+\beta)\pi}{2\ell} \middle| \frac{i\pi t}{\ell^2}\right) dt = -\frac{\ell}{\sqrt{s}} \sinh(\beta\sqrt{s}) \operatorname{sech}(\ell\sqrt{s}),$$

$$\int_0^\infty e^{-st} \theta_3\left(\frac{(1+\beta)\pi}{2\ell} \middle| \frac{i\pi t}{\ell^2}\right) dt$$

$$20.10.5 \quad = \int_0^\infty e^{-st} \theta_4\left(\frac{\beta\pi}{2\ell} \middle| \frac{i\pi t}{\ell^2}\right) dt = \frac{\ell}{\sqrt{s}} \cosh(\beta\sqrt{s}) \operatorname{csch}(\ell\sqrt{s}).$$

For corresponding results for argument derivatives of the theta functions see Erdélyi *et al.* (1954a, pp. 224–225) or Oberhettinger and Badii (1973, p. 193).

### 20.10(iii) Compendia

For further integrals of theta functions see Erdélyi *et al.* (1954a, pp. 61–62 and 339), Prudnikov *et al.* (1990, pp. 356–358), Prudnikov *et al.* (1992a, §3.41), and Gradshteyn and Ryzhik (2000, pp. 627–628).

## 20.11 Generalizations and Analogs

### 20.11(i) Gauss Sum

For relatively prime integers  $m, n$  with  $n > 0$  and  $mn$  even, the *Gauss sum*  $G(m, n)$  is defined by

$$20.11.1 \quad G(m, n) = \sum_{k=0}^{n-1} e^{-\pi i k^2 m/n},$$

see Lerch (1903). It is a discrete analog of theta functions. If both  $m, n$  are positive, then  $G(m, n)$  allows inversion of its arguments as a modular transformation (compare (23.15.3) and (23.15.4)):

$$20.11.2 \quad \frac{1}{\sqrt{n}} G(m, n) = \frac{1}{\sqrt{n}} \sum_{k=0}^{n-1} e^{-\pi i k^2 m/n} = \frac{e^{-\pi i/4}}{\sqrt{m}} \sum_{j=0}^{m-1} e^{\pi i j^2 n/m} = \frac{e^{-\pi i/4}}{\sqrt{m}} G(-n, m).$$

This is the discrete analog of the Poisson identity (§1.8(iv)).

### 20.11(ii) Ramanujan's Theta Function and $q$ -Series

Ramanujan's theta function  $f(a, b)$  is defined by

$$20.11.3 \quad f(a, b) = \sum_{n=-\infty}^{\infty} a^{n(n+1)/2} b^{n(n-1)/2},$$

where  $a, b \in \mathbb{C}$  and  $|ab| < 1$ . With the substitutions  $a = qe^{2iz}$ ,  $b = qe^{-2iz}$ , with  $q = e^{i\pi\tau}$ , we have

$$20.11.4 \quad f(a, b) = \theta_3(z|\tau).$$

In the case  $z = 0$  identities for theta functions become identities in the complex variable  $q$ , with  $|q| < 1$ , that involve rational functions, power series, and continued fractions; see Adiga *et al.* (1985), McKean and Moll (1999, pp. 156–158), and Andrews *et al.* (1988, §10.7).

### 20.11(iii) Ramanujan's Change of Base

As in §20.11(ii), the modulus  $k$  of elliptic integrals (§19.2(ii)), Jacobian elliptic functions (§22.2), and Weierstrass elliptic functions (§23.6(ii)) can be expanded in  $q$ -series via (20.9.1). However, in this case  $q$  is no longer regarded as an independent complex variable within the unit circle, because  $k$  is related to the variable  $\tau = \tau(k)$  of the theta functions via (20.9.2). This is Jacobi's inversion problem of §20.9(ii).

The first of equations (20.9.2) can also be written

$$20.11.5 \quad {}_2F_1\left(\frac{1}{2}, \frac{1}{2}; 1; k^2\right) = \theta_3^2(0|\tau);$$

see §19.5. Similar identities can be constructed for  ${}_2F_1\left(\frac{1}{3}, \frac{2}{3}; 1; k^2\right)$ ,  ${}_2F_1\left(\frac{1}{4}, \frac{3}{4}; 1; k^2\right)$ , and  ${}_2F_1\left(\frac{1}{6}, \frac{5}{6}; 1; k^2\right)$ . These results are called *Ramanujan's changes of base*. Each provides an extension of Jacobi's inversion problem. See Berndt *et al.* (1995) and Shen (1998). For applications to rapidly convergent expansions for  $\pi$  see Chudnovsky and Chudnovsky (1988), and for applications in the construction of *elliptic-hypergeometric series* see Rosengren (2004).

### 20.11(iv) Theta Functions with Characteristics

Multidimensional *theta functions with characteristics* are defined in §21.2(ii) and their properties are described in §§21.3(ii), 21.5(ii), and 21.6. For specialization to the one-dimensional theta functions treated in the present chapter, see Rauch and Lebowitz (1973) and §21.7(iii).

## Applications

### 20.12 Mathematical Applications

#### 20.12(i) Number Theory

For applications of  $\theta_3(0, q)$  to problems involving sums of squares of integers see §27.13(iv), and for extensions see Estermann (1959), Serre (1973, pp. 106–109), Koblitz (1993, pp. 176–177), and McKean and Moll (1999, pp. 142–143).

For applications of Jacobi's triple product (20.5.9) to Ramanujan's  $\tau(n)$  function and Euler's pentagonal numbers see Hardy and Wright (1979, pp. 132–160) and McKean and Moll (1999, pp. 143–145). For an application of a generalization in affine root systems see Macdonald (1972).

#### 20.12(ii) Uniformization and Embedding of Complex Tori

For the terminology and notation see McKean and Moll (1999, pp. 48–53).

The space of complex tori  $\mathbb{C}/(\mathbb{Z} + \tau\mathbb{Z})$  (that is, the set of complex numbers  $z$  in which two of these numbers  $z_1$  and  $z_2$  are regarded as equivalent if there exist integers  $m, n$  such that  $z_1 - z_2 = m + \tau n$ ) is mapped into the projective space  $P^3$  via the identification  $z \rightarrow (\theta_1(2z|\tau), \theta_2(2z|\tau), \theta_3(2z|\tau), \theta_4(2z|\tau))$ . Thus theta functions “uniformize” the complex torus. This ability to uniformize multiply-connected spaces (manifolds), or multi-sheeted functions of a complex variable (Riemann (1899), Rauch and Lebowitz (1973), Siegel (1988)) has led to applications in string theory (Green *et al.* (1988a,b), Krichever and Novikov (1989)), and also in statistical mechanics (Baxter (1982)).

### 20.13 Physical Applications

The functions  $\theta_j(z|\tau)$ ,  $j = 1, 2, 3, 4$ , provide periodic solutions of the partial differential equation

$$20.13.1 \quad \partial\theta(z|\tau)/\partial\tau = \kappa \partial^2\theta(z|\tau)/\partial z^2,$$

with  $\kappa = -i\pi/4$ .

For  $\tau = it$ , with  $\alpha, t, z$  real, (20.13.1) takes the form of a real-time  $t$  diffusion equation

$$20.13.2 \quad \partial\theta/\partial t = \alpha \partial^2\theta/\partial z^2,$$

with diffusion constant  $\alpha = \pi/4$ . Let  $z, \alpha, t \in \mathbb{R}$ . Then the nonperiodic Gaussian

$$20.13.3 \quad g(z, t) = \sqrt{\frac{\pi}{4\alpha t}} \exp\left(-\frac{z^2}{4\alpha t}\right)$$

is also a solution of (20.13.2), and it approaches a Dirac delta (§1.17) at  $t = 0$ . These two apparently different

solutions differ only in their normalization and boundary conditions. From (20.2.3), (20.2.4), (20.7.32), and (20.7.33),

$$20.13.4 \quad \sqrt{\frac{\pi}{4\alpha t}} \sum_{n=-\infty}^{\infty} e^{-(n\pi+z)^2/(4\alpha t)} = \theta_3(z|i4\alpha t/\pi),$$

and

$$20.13.5 \quad \sqrt{\frac{\pi}{4\alpha t}} \sum_{n=-\infty}^{\infty} (-1)^n e^{-(n\pi+z)^2/(4\alpha t)} = \theta_4(z|i4\alpha t/\pi).$$

Thus the classical theta functions are “periodized”, or “anti-periodized”, Gaussians; see Bellman (1961, pp. 18, 19). Theta-function solutions to the heat diffusion equation with simple boundary conditions are discussed in Lawden (1989, pp. 1–3), and with more general boundary conditions in Körner (1989, pp. 274–281).

In the singular limit  $\Im\tau \rightarrow 0+$ , the functions  $\theta_j(z|\tau)$ ,  $j = 1, 2, 3, 4$ , become integral kernels of Feynman path integrals (distribution-valued Green’s functions); see Schulman (1981, pp. 194–195). This allows analytic time propagation of quantum wave-packets in a box, or on a ring, as closed-form solutions of the time-dependent Schrödinger equation.

## Computation

### 20.14 Methods of Computation

The Fourier series of §20.2(i) usually converge rapidly because of the factors  $q^{(n+\frac{1}{2})^2}$  or  $q^{n^2}$ , and provide a convenient way of calculating values of  $\theta_j(z|\tau)$ . Similarly, their  $z$ -differentiated forms provide a convenient way of calculating the corresponding derivatives. For instance, the first three terms of (20.2.1) give the value of  $\theta_1(2-i|i)$  ( $= \theta_1(2-i, e^{-\pi})$ ) to 12 decimal places.

For values of  $|q|$  near 1 the transformations of §20.7(viii) can be used to replace  $\tau$  with a value that has a larger imaginary part and hence a smaller value of  $|q|$ . For instance, to find  $\theta_3(z, 0.9)$  we use (20.7.32) with  $q = 0.9 = e^{i\pi\tau}$ ,  $\tau = -i \ln(0.9)/\pi$ . Then  $\tau' = -1/\tau = -i\pi/\ln(0.9)$  and  $q' = e^{i\pi\tau'} = \exp(\pi^2/\ln(0.9)) = (2.07\dots) \times 10^{-41}$ . Hence the first term of the series (20.2.3) for  $\theta_3(z\tau'|\tau')$  suffices for most purposes. In theory, starting from any value of  $\tau$ , a finite number of applications of the transformations  $\tau \rightarrow \tau + 1$  and  $\tau \rightarrow -1/\tau$  will result in a value of  $\tau$  with  $\Im\tau \geq \sqrt{3}/2$ ; see §23.18. In practice a value with, say,  $\Im\tau \geq 1/2$ ,  $|q| \leq 0.2$ , is found quickly and is satisfactory for numerical evaluation.

### 20.15 Tables

Theta functions are tabulated in Jahnke and Emde (1945, p. 45). This reference gives  $\theta_j(x, q)$ ,  $j = 1, 2, 3, 4$ , and their logarithmic  $x$ -derivatives to 4D for  $x/\pi = 0(.1)1$ ,  $\alpha = 0(9^\circ)90^\circ$ , where  $\alpha$  is the modular angle given by

$$20.15.1 \quad \sin \alpha = \theta_2^2(0, q)/\theta_3^2(0, q) = k.$$

Spenceley and Spenceley (1947) tabulates  $\theta_1(x, q)/\theta_2(0, q)$ ,  $\theta_2(x, q)/\theta_2(0, q)$ ,  $\theta_3(x, q)/\theta_4(0, q)$ ,  $\theta_4(x, q)/\theta_4(0, q)$  to 12D for  $u = 0(1^\circ)90^\circ$ ,  $\alpha = 0(1^\circ)89^\circ$ , where  $u = 2x/(\pi\theta_3^2(0, q))$  and  $\alpha$  is defined by (20.15.1), together with the corresponding values of  $\theta_2(0, q)$  and  $\theta_4(0, q)$ .

Lawden (1989, pp. 270–279) tabulates  $\theta_j(x, q)$ ,  $j = 1, 2, 3, 4$ , to 5D for  $x = 0(1^\circ)90^\circ$ ,  $q = 0.1(.1)0.9$ , and also  $q$  to 5D for  $k^2 = 0(.01)1$ .

Tables of Neville’s theta functions  $\theta_s(x, q)$ ,  $\theta_c(x, q)$ ,  $\theta_d(x, q)$ ,  $\theta_n(x, q)$  (see §20.1) and their logarithmic  $x$ -derivatives are given in Abramowitz and Stegun (1964, pp. 582–585) to 9D for  $\varepsilon, \alpha = 0(5^\circ)90^\circ$ , where (in radian measure)  $\varepsilon = x/\theta_3^2(0, q) = \pi x/(2K(k))$ , and  $\alpha$  is defined by (20.15.1).

For other tables prior to 1961 see Fletcher *et al.* (1962, pp. 508–514) and Lebedev and Fedorova (1960, pp. 227–230).

### 20.16 Software

See <http://dlmf.nist.gov/20.16>.

## References

### General References

The main references used in writing this chapter are Whittaker and Watson (1927), Lawden (1989), and Walker (1996). For further bibliographic reading see McKean and Moll (1999).

### Sources

The following list gives the references or other indications of proofs that were used in constructing the various sections of this chapter. These sources supplement the references that are quoted in the text.

§20.2 Whittaker and Watson (1927, pp. 463–465) and Lawden (1989, Chapter 1).

§20.3 These graphics were produced at NIST.

§20.4 Lawden (1989, pp. 12–23), Walker (1996, pp. 90–92), and Whittaker and Watson (1927, pp. 470–473). (20.4.1)–(20.4.5) are special cases of (20.5.1)–(20.5.4).

- §20.5** Lawden (1989, pp. 12–23), Walker (1996, pp. 86–98), Whittaker and Watson (1927, pp. 469–473), and Bellman (1961, p. 44). Equations (20.5.14)–(20.5.17) follow from (20.5.5)–(20.5.8) by use of the infinite products for the sine and cosine (§4.22).
- §20.6** Walker (1996, §3.2) and §23.9. (20.6.2)–(20.6.5) may be derived by termwise expansion in (20.5.14)–(20.5.17). (20.6.10) may be derived from (20.6.6) and (20.6.8) by subtraction of terms with even  $j$ , in a similar manner to  $\sum_{n=1}^{\infty} (-1)^{n-1} n^{-j} = (1 - 2^{1-j}) \sum_{n=1}^{\infty} n^{-j}$ .
- §20.7** Lawden (1989, pp. 5–23), Whittaker and Watson (1927, pp. 466–477), McKean and Moll (1999, pp. 129–130), Watson (1935a), Bellman (1961, p. 61), and Serre (1973, p. 109). The first equalities in (20.7.11) and (20.7.12) follow by translation of  $z$  by  $\frac{1}{2}\pi$  as in (20.2.11)–(20.2.14). The second equalities follow from (20.5.5)–(20.5.8) and the identity  $\prod_{n=1}^{\infty} (1+q^n)(1-q^{2n-1}) = 1$  (Walker (1996, p. 90)).
- §20.9** Walker (1996, p. 156), Whittaker and Watson (1927, pp. 480–485), Serre (1973, p. 109), and McKean and Moll (1999, §§3.3, 3.9). For (20.9.3) combination of (20.4.6) and (23.6.5) – (23.6.7) yields  $\wp(z) - e_j = \left( \frac{v \theta'_1(0,q) \theta_{j+1}(v,q)}{z \theta_1(v,q) \theta_{j+1}(0,q)} \right)^2$ ,  $j = 1, 2, 3$ , where  $v = \pi z / (2\omega_1)$ . Then by application of (19.25.35) and use of the properties that  $R_F$  is homogenous and of degree  $-\frac{1}{2}$  in its three variables (§§19.16(ii), 19.16(iii)), we derive  $z = \frac{z \theta_1(v,q)}{v \theta'_1(0,q)} R_F \left( \frac{\theta_2^2(v,q)}{\theta_2^2(0,q)}, \frac{\theta_3^2(v,q)}{\theta_3^2(0,q)}, \frac{\theta_4^2(v,q)}{\theta_4^2(0,q)} \right)$ . This equation becomes (20.9.3) when the  $z$ 's are cancelled and  $v$  is renamed  $z$ . For (20.9.4), from (19.25.1) and Erdélyi *et al.* (1953b, 13.20(11)) we have  $K(k) = R_F \left( 0, \frac{\theta_4^4(0,q)}{\theta_3^4(0,q)}, 1 \right) = \theta_3^2(0,q) R_F(0, \theta_3^4(0,q), \theta_4^4(0,q))$ , where the second equality uses the homogeneity and symmetry of  $R_F$ . Comparison with (20.9.2) proves (20.9.4). For (20.9.5), by (19.25.1) the left side is  $\exp(-\pi K(k')/K(k))$ , which equals  $q$  by Erdélyi *et al.* (1953b, 13.19(4)).
- §20.10** Bellman (1961, pp. 20–24). For (20.10.1) and (20.10.3) use §20.7(viii) with appropriate changes of integration variable. For (20.10.2) use (20.2.3) with  $z = 0$ ,  $\tau = it$ , Bellman (1961, pp. 28–32), Koblitiz (1993, pp. 70–75), and/or Titchmarsh (1986b, §2.6).
- §20.11** Bellman (1961, pp. 38–39), Walker (1996, pp. 181–182), and McKean and Moll (1999, pp. 140–147 and 151–152).
- §20.13** Whittaker and Watson (1927, p. 470).





## Chapter 21

# Multidimensional Theta Functions

B. Deconinck<sup>1</sup>

<b>Notation</b>	<b>538</b>	<b>Applications</b>	<b>543</b>
21.1 Special Notation . . . . .	538	21.7 Riemann Surfaces . . . . .	543
<b>Properties</b>	<b>538</b>	21.8 Abelian Functions . . . . .	545
21.2 Definitions . . . . .	538	21.9 Integrable Equations . . . . .	545
21.3 Symmetry and Quasi-Periodicity . . . . .	539	<b>Computation</b>	<b>546</b>
21.4 Graphics . . . . .	539	21.10 Methods of Computation . . . . .	546
21.5 Modular Transformations . . . . .	541	21.11 Software . . . . .	546
21.6 Products . . . . .	542	<b>References</b>	<b>546</b>

<sup>1</sup>Department of Applied Mathematics, University of Washington, Seattle, Washington.  
Copyright © 2009 National Institute of Standards and Technology. All rights reserved.

## Notation

### 21.1 Special Notation

(For other notation see pp. xiv and 873.)

$g, h$	positive integers.
$\mathbb{Z}^g$	$\mathbb{Z} \times \mathbb{Z} \times \cdots \times \mathbb{Z}$ ( $g$ times).
$\mathbb{R}^g$	$\mathbb{R} \times \mathbb{R} \times \cdots \times \mathbb{R}$ ( $g$ times).
$\mathbb{Z}^{g \times h}$	set of all $g \times h$ matrices with integer elements.
$\Omega$	$g \times g$ complex, symmetric matrix with $\Im \Omega$ strictly positive definite, i.e., a Riemann matrix.
$\alpha, \beta$	$g$ -dimensional vectors, with all elements in $[0, 1)$ , unless stated otherwise.
$a_j$	$j$ th element of vector $\mathbf{a}$ .
$A_{jk}$	$(j, k)$ th element of matrix $\mathbf{A}$ .
$\mathbf{a} \cdot \mathbf{b}$	scalar product of the vectors $\mathbf{a}$ and $\mathbf{b}$ .
$\mathbf{a} \cdot \Omega \cdot \mathbf{b}$	$[\Omega \mathbf{a}] \cdot \mathbf{b} = [\Omega \mathbf{b}] \cdot \mathbf{a}$ .
$\mathbf{0}_g$	$g \times g$ zero matrix.
$\mathbf{I}_g$	$g \times g$ identity matrix.
$\mathbf{J}_{2g}$	$\begin{bmatrix} \mathbf{0}_g & \mathbf{I}_g \\ -\mathbf{I}_g & \mathbf{0}_g \end{bmatrix}$ .
$S^g$	set of $g$ -dimensional vectors with elements in $S$ .
$ S $	number of elements of the set $S$ .
$S_1 S_2$	set of all elements of the form “element of $S_1 \times$ element of $S_2$ ”.
$S_1/S_2$	set of all elements of $S_1$ , modulo elements of $S_2$ . Thus two elements of $S_1/S_2$ are equivalent if they are both in $S_1$ and their difference is in $S_2$ . (For an example see §20.12(ii).)
$a \circ b$	intersection index of $a$ and $b$ , two cycles lying on a closed surface. $a \circ b = 0$ if $a$ and $b$ do not intersect. Otherwise $a \circ b$ gets an additive contribution from every intersection point. This contribution is 1 if the basis of the tangent vectors of the $a$ and $b$ cycles (§21.7(i)) at the point of intersection is positively oriented; otherwise it is $-1$ .
$\oint_a \omega$	line integral of the differential $\omega$ over the cycle $a$ .

Lowercase boldface letters or numbers are  $g$ -dimensional real or complex vectors, either row or column depending on the context. Uppercase boldface let-

ters are  $g \times g$  real or complex matrices.

The main functions treated in this chapter are the Riemann theta functions  $\theta(\mathbf{z}|\Omega)$ , and the Riemann theta functions with characteristics  $\theta\left[\begin{smallmatrix} \alpha \\ \beta \end{smallmatrix}\right](\mathbf{z}|\Omega)$ .

The function  $\Theta(\phi|\mathbf{B}) = \theta(\phi/(2\pi i)|\mathbf{B}/(2\pi i))$  is also commonly used; see, for example, Belokolos *et al.* (1994, §2.5), Dubrovin (1981), and Fay (1973, Chapter 1).

## Properties

### 21.2 Definitions

#### 21.2(i) Riemann Theta Functions

$$21.2.1 \quad \theta(\mathbf{z}|\Omega) = \sum_{\mathbf{n} \in \mathbb{Z}^g} e^{2\pi i \left( \frac{1}{2} \mathbf{n} \cdot \Omega \cdot \mathbf{n} + \mathbf{n} \cdot \mathbf{z} \right)}.$$

This  $g$ -tuple Fourier series converges absolutely and uniformly on compact sets of the  $\mathbf{z}$  and  $\Omega$  spaces; hence  $\theta(\mathbf{z}|\Omega)$  is an analytic function of (each element of)  $\mathbf{z}$  and (each element of)  $\Omega$ .  $\theta(\mathbf{z}|\Omega)$  is also referred to as a theta function with  $g$  components, a  $g$ -dimensional theta function or as a genus  $g$  theta function.

For numerical purposes we use the *scaled Riemann theta function*  $\hat{\theta}(\mathbf{z}|\Omega)$ , defined by (Deconinck *et al.* (2004)),

$$21.2.2 \quad \hat{\theta}(\mathbf{z}|\Omega) = e^{-\pi[\Im \mathbf{z}] \cdot [\Im \Omega]^{-1} \cdot [\Im \mathbf{z}]} \theta(\mathbf{z}|\Omega).$$

$\hat{\theta}(\mathbf{z}|\Omega)$  is a bounded nonanalytic function of  $\mathbf{z}$ . Many applications involve quotients of Riemann theta functions: the exponential factor then disappears.

#### Example

##### 21.2.3

$$\begin{aligned} & \theta\left(z_1, z_2 \left| \begin{bmatrix} i & -\frac{1}{2} \\ -\frac{1}{2} & i \end{bmatrix} \right. \right) \\ &= \sum_{n_1=-\infty}^{\infty} \sum_{n_2=-\infty}^{\infty} e^{-\pi(n_1^2+n_2^2)} e^{-i\pi n_1 n_2} e^{2\pi i(n_1 z_1 + n_2 z_2)}. \end{aligned}$$

With  $z_1 = x_1 + iy_1$ ,  $z_2 = x_2 + iy_2$ ,

$$\hat{\theta}\left(x_1 + iy_1, x_2 + iy_2 \left| \begin{bmatrix} i & -\frac{1}{2} \\ -\frac{1}{2} & i \end{bmatrix} \right. \right)$$

$$21.2.4 \quad = \sum_{n_1=-\infty}^{\infty} \sum_{n_2=-\infty}^{\infty} e^{-\pi(n_1+y_1)^2 - \pi(n_2+y_2)^2} \times e^{\pi i(2n_1 x_1 + 2n_2 x_2 - n_1 n_2)}.$$

### 21.2(ii) Riemann Theta Functions with Characteristics

Let  $\alpha, \beta \in \mathbb{R}^g$ . Define

21.2.5

$$\theta \begin{bmatrix} \alpha \\ \beta \end{bmatrix} (\mathbf{z} | \Omega) = \sum_{\mathbf{n} \in \mathbb{Z}^g} e^{2\pi i (\frac{1}{2} [\mathbf{n} + \alpha] \cdot \Omega \cdot [\mathbf{n} + \alpha] + [\mathbf{n} + \alpha] \cdot [\mathbf{z} + \beta])}.$$

This function is referred to as a *Riemann theta function with characteristics*  $\begin{bmatrix} \alpha \\ \beta \end{bmatrix}$ . It is a translation of the Riemann theta function (21.2.1), multiplied by an exponential factor:

21.2.6

$$\theta \begin{bmatrix} \alpha \\ \beta \end{bmatrix} (\mathbf{z} | \Omega) = e^{2\pi i (\frac{1}{2} \alpha \cdot \Omega \cdot \alpha + \alpha \cdot [\mathbf{z} + \beta])} \theta(\mathbf{z} + \Omega \alpha + \beta | \Omega),$$

and

21.2.7 
$$\theta \begin{bmatrix} \mathbf{0} \\ \mathbf{0} \end{bmatrix} (\mathbf{z} | \Omega) = \theta(\mathbf{z} | \Omega).$$

Characteristics whose elements are either 0 or  $\frac{1}{2}$  are called *half-period characteristics*. For given  $\Omega$ , there are  $2^{2g}$   $g$ -dimensional Riemann theta functions with half-period characteristics.

### 21.2(iii) Relation to Classical Theta Functions

For  $g = 1$ , and with the notation of §20.2(i),

21.2.8 
$$\theta(z | \Omega) = \theta_3(\pi z | \Omega),$$

21.2.9 
$$\theta_1(\pi z | \Omega) = -\theta \begin{bmatrix} \frac{1}{2} \\ \frac{1}{2} \end{bmatrix} (z | \Omega),$$

21.2.10 
$$\theta_2(\pi z | \Omega) = \theta \begin{bmatrix} \frac{1}{2} \\ \mathbf{0} \end{bmatrix} (z | \Omega),$$

21.2.11 
$$\theta_3(\pi z | \Omega) = \theta \begin{bmatrix} \mathbf{0} \\ \mathbf{0} \end{bmatrix} (z | \Omega),$$

21.2.12 
$$\theta_4(\pi z | \Omega) = \theta \begin{bmatrix} \mathbf{0} \\ \frac{1}{2} \end{bmatrix} (z | \Omega).$$

## 21.4 Graphics

Figure 21.4.1 provides surfaces of the scaled Riemann theta function  $\hat{\theta}(\mathbf{z} | \Omega)$ , with

21.4.1 
$$\Omega = \begin{bmatrix} 1.69098\ 3006 + 0.95105\ 6516\ i & 1.5 + 0.36327\ 1264\ i \\ 1.5 + 0.36327\ 1264\ i & 1.30901\ 6994 + 0.95105\ 6516\ i \end{bmatrix}.$$

This Riemann matrix originates from the Riemann surface represented by the algebraic curve  $\mu^3 - \lambda^7 + 2\lambda^3\mu = 0$ ; compare §21.7(i).

## 21.3 Symmetry and Quasi-Periodicity

### 21.3(i) Riemann Theta Functions

21.3.1 
$$\theta(-\mathbf{z} | \Omega) = \theta(\mathbf{z} | \Omega),$$

21.3.2 
$$\theta(\mathbf{z} + \mathbf{m}_1 | \Omega) = \theta(\mathbf{z} | \Omega),$$

when  $\mathbf{m}_1 \in \mathbb{Z}^g$ . Thus  $\theta(\mathbf{z} | \Omega)$  is periodic, with period 1, in each element of  $\mathbf{z}$ . More generally,

21.3.3

$$\theta(\mathbf{z} + \mathbf{m}_1 + \Omega \mathbf{m}_2 | \Omega) = e^{-2\pi i (\frac{1}{2} \mathbf{m}_2 \cdot \Omega \cdot \mathbf{m}_2 + \mathbf{m}_2 \cdot \mathbf{z})} \theta(\mathbf{z} | \Omega),$$

with  $\mathbf{m}_1, \mathbf{m}_2 \in \mathbb{Z}^g$ . This is the *quasi-periodicity* property of the Riemann theta function. It determines the Riemann theta function up to a constant factor. The set of points  $\mathbf{m}_1 + \Omega \mathbf{m}_2$  form a  $g$ -dimensional lattice, the *period lattice* of the Riemann theta function.

### 21.3(ii) Riemann Theta Functions with Characteristics

Again, with  $\mathbf{m}_1, \mathbf{m}_2 \in \mathbb{Z}^g$

21.3.4 
$$\theta \begin{bmatrix} \alpha + \mathbf{m}_1 \\ \beta + \mathbf{m}_2 \end{bmatrix} (\mathbf{z} | \Omega) = e^{2\pi i \alpha \cdot \mathbf{m}_1} \theta \begin{bmatrix} \alpha \\ \beta \end{bmatrix} (\mathbf{z} | \Omega).$$

Because of this property, the elements of  $\alpha$  and  $\beta$  are usually restricted to  $[0, 1)$ , without loss of generality.

21.3.5 
$$\theta \begin{bmatrix} \alpha \\ \beta \end{bmatrix} (\mathbf{z} + \mathbf{m}_1 + \Omega \mathbf{m}_2 | \Omega) = e^{2\pi i (\alpha \cdot \mathbf{m}_1 - \beta \cdot \mathbf{m}_2 - \frac{1}{2} \mathbf{m}_2 \cdot \Omega \cdot \mathbf{m}_2 - \mathbf{m}_2 \cdot \mathbf{z})} \theta \begin{bmatrix} \alpha \\ \beta \end{bmatrix} (\mathbf{z} | \Omega).$$

For Riemann theta functions with half-period characteristics,

21.3.6 
$$\theta \begin{bmatrix} \alpha \\ \beta \end{bmatrix} (-\mathbf{z} | \Omega) = (-1)^{4\alpha \cdot \beta} \theta \begin{bmatrix} \alpha \\ \beta \end{bmatrix} (\mathbf{z} | \Omega).$$

See also §20.2(iii) for the case  $g = 1$  and classical theta functions.

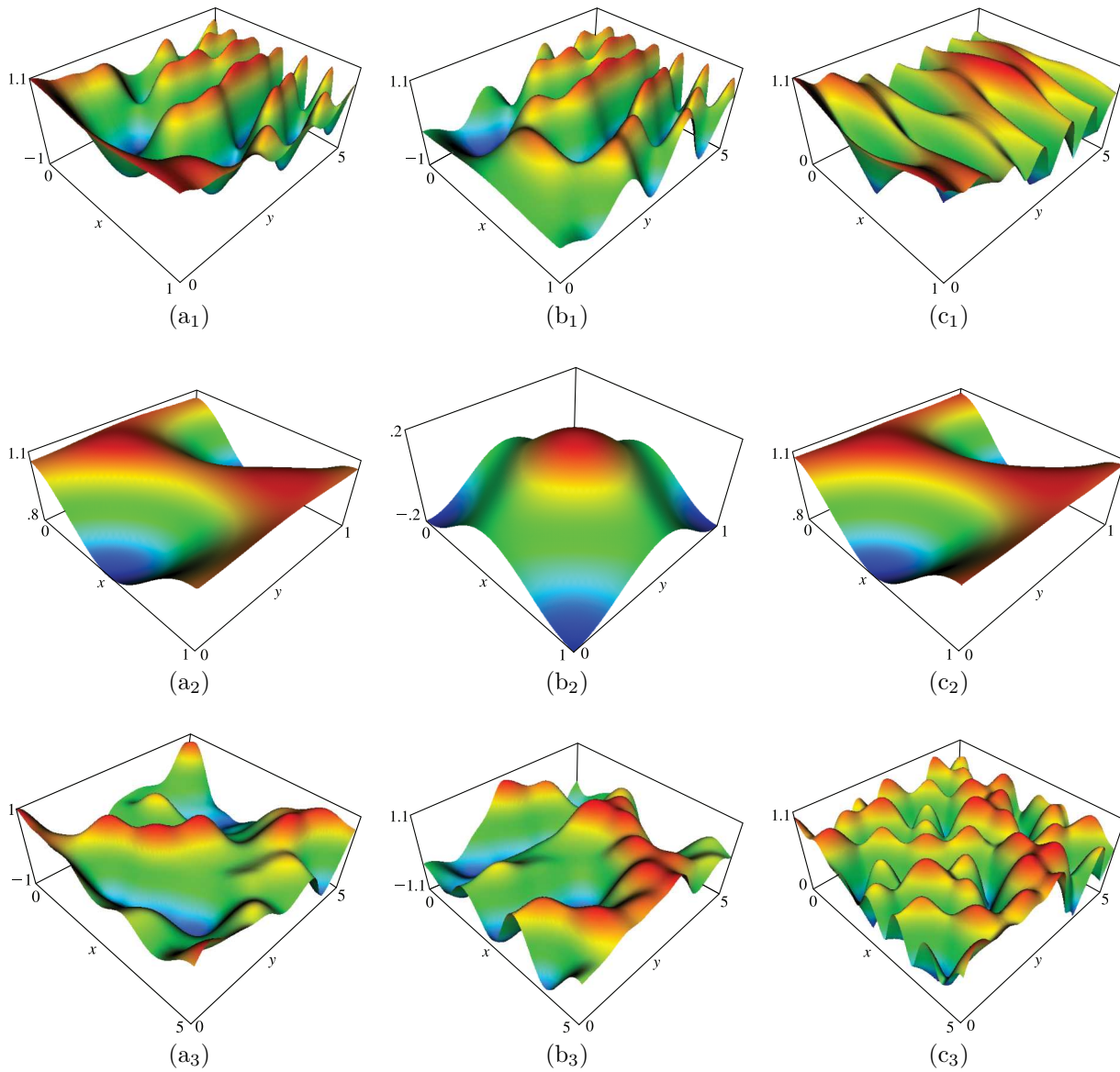


Figure 21.4.1:  $\hat{\theta}(\mathbf{z}|\Omega)$  parametrized by (21.4.1). The surface plots are of  $\hat{\theta}(x + iy, 0|\Omega)$ ,  $0 \leq x \leq 1$ ,  $0 \leq y \leq 5$  (suffix 1);  $\hat{\theta}(x, y|\Omega)$ ,  $0 \leq x \leq 1$ ,  $0 \leq y \leq 1$  (suffix 2);  $\hat{\theta}(ix, iy|\Omega)$ ,  $0 \leq x \leq 5$ ,  $0 \leq y \leq 5$  (suffix 3). Shown are the real part (a), the imaginary part (b), and the modulus (c).

For the scaled Riemann theta functions depicted in Figures 21.4.2–21.4.5

21.4.2

$$\Omega_1 = \begin{bmatrix} i & -\frac{1}{2} \\ -\frac{1}{2} & i \end{bmatrix},$$

and

21.4.3

$$\Omega_2 = \begin{bmatrix} -\frac{1}{2} + i & \frac{1}{2} - \frac{1}{2}i & -\frac{1}{2} - \frac{1}{2}i \\ \frac{1}{2} - \frac{1}{2}i & i & 0 \\ -\frac{1}{2} - \frac{1}{2}i & 0 & i \end{bmatrix}.$$

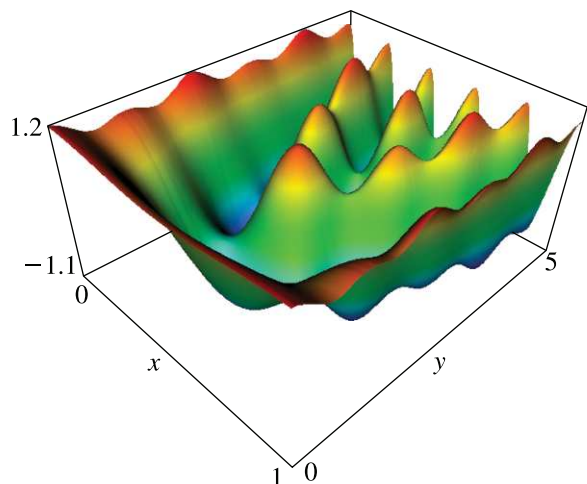


Figure 21.4.2:  $\Re\hat{\theta}(x + iy, 0|\Omega_1)$ ,  $0 \leq x \leq 1$ ,  $0 \leq y \leq 5$ . (The imaginary part looks very similar.)

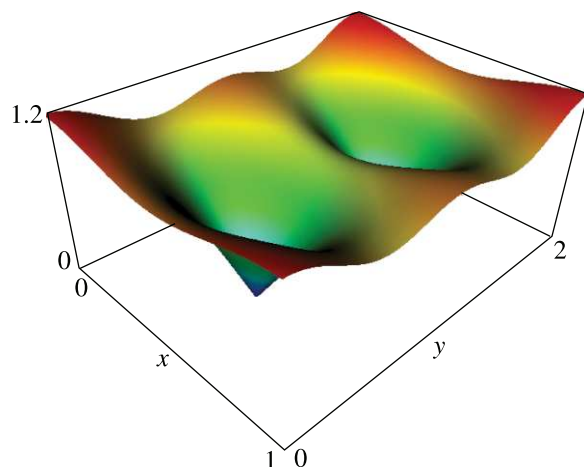


Figure 21.4.3:  $|\hat{\theta}(x + iy, 0|\Omega_1)|$ ,  $0 \leq x \leq 1$ ,  $0 \leq y \leq 2$ .

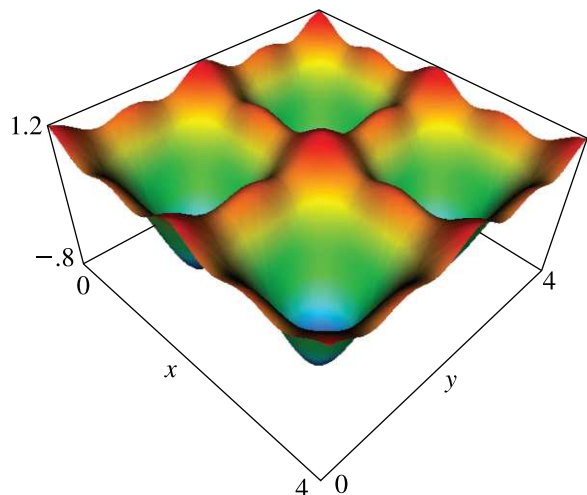


Figure 21.4.4: A real-valued scaled Riemann theta function:  $\hat{\theta}(ix, iy|\Omega_1)$ ,  $0 \leq x \leq 4$ ,  $0 \leq y \leq 4$ . In this case, the quasi-periods are commensurable, resulting in a doubly-periodic configuration.

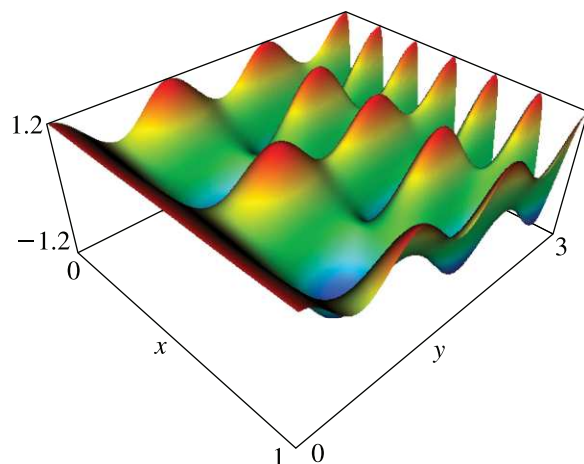


Figure 21.4.5: The real part of a genus 3 scaled Riemann theta function:  $\Re\hat{\theta}(x + iy, 0, 0|\Omega_2)$ ,  $0 \leq x \leq 1$ ,  $0 \leq y \leq 3$ . This Riemann matrix originates from the genus 3 Riemann surface represented by the algebraic curve  $\mu^3 + 2\mu - \lambda^4 = 0$ ; compare §21.7(i).

## 21.5 Modular Transformations

### 21.5(i) Riemann Theta Functions

Let  $\mathbf{A}$ ,  $\mathbf{B}$ ,  $\mathbf{C}$ , and  $\mathbf{D}$  be  $g \times g$  matrices with integer elements such that

$$21.5.1 \quad \Gamma = \begin{bmatrix} \mathbf{A} & \mathbf{B} \\ \mathbf{C} & \mathbf{D} \end{bmatrix}$$

is a *symplectic matrix*, that is,

$$21.5.2 \quad \Gamma \mathbf{J}_{2g} \Gamma^T = \mathbf{J}_{2g}.$$

Then

$$21.5.3 \quad \det \Gamma = 1,$$

and

$$21.5.4 \quad \begin{aligned} &\theta\left(\left[[\mathbf{C}\Omega + \mathbf{D}]^{-1}\right]^T \mathbf{z} \mid [\mathbf{A}\Omega + \mathbf{B}][\mathbf{C}\Omega + \mathbf{D}]^{-1}\right) \\ &= \xi(\Gamma) \sqrt{\det[\mathbf{C}\Omega + \mathbf{D}]} e^{\pi i \mathbf{z} \cdot [\mathbf{C}\Omega + \mathbf{D}]^{-1} \mathbf{C} \cdot \mathbf{z}} \theta(\mathbf{z}|\Omega). \end{aligned}$$

Here  $\xi(\Gamma)$  is an eighth root of unity, that is,  $(\xi(\Gamma))^8 = 1$ . For general  $\Gamma$ , it is difficult to decide which root needs to be used. The choice depends on  $\Gamma$ , but is independent

of  $\mathbf{z}$  and  $\Omega$ . Equation (21.5.4) is the *modular transformation* property for Riemann theta functions.

The modular transformations form a group under the composition of such transformations, the *modular group*, which is generated by simpler transformations, for which  $\xi(\Gamma)$  is determinate:

$$21.5.5 \quad \Gamma = \begin{bmatrix} \mathbf{A} & \mathbf{0}_g \\ \mathbf{0}_g & [\mathbf{A}^{-1}]^T \end{bmatrix} \Rightarrow \theta(\mathbf{Az} | \mathbf{A}\Omega \mathbf{A}^T) = \theta(\mathbf{z} | \Omega).$$

( $\mathbf{A}$  invertible with integer elements.)

$$21.5.6 \quad \Gamma = \begin{bmatrix} \mathbf{I}_g & \mathbf{B} \\ \mathbf{0}_g & \mathbf{I}_g \end{bmatrix} \Rightarrow \theta(\mathbf{z} | \Omega + \mathbf{B}) = \theta(\mathbf{z} | \Omega).$$

( $\mathbf{B}$  symmetric with integer elements and even diagonal elements.)

21.5.7

$$\Gamma = \begin{bmatrix} \mathbf{I}_g & \mathbf{B} \\ \mathbf{0}_g & \mathbf{I}_g \end{bmatrix} \Rightarrow \theta(\mathbf{z} | \Omega + \mathbf{B}) = \theta(\mathbf{z} + \frac{1}{2} \text{diag } \mathbf{B} | \Omega).$$

( $\mathbf{B}$  symmetric with integer elements.) See Heil (1995, p. 24).

21.5.8

$$\Gamma = \begin{bmatrix} \mathbf{0}_g & -\mathbf{I}_g \\ \mathbf{I}_g & \mathbf{0}_g \end{bmatrix}$$

$\Rightarrow \theta(\Omega^{-1}\mathbf{z} | -\Omega^{-1}) = \sqrt{\det[-i\Omega]} e^{\pi i \mathbf{z} \cdot \Omega^{-1} \cdot \mathbf{z}} \theta(\mathbf{z} | \Omega)$ , where the square root assumes its principal value.

### 21.5(ii) Riemann Theta Functions with Characteristics

$$21.5.9 \quad \theta \left[ \begin{array}{c} \mathbf{D}\alpha - \mathbf{C}\beta + \frac{1}{2} \text{diag}[\mathbf{C}\mathbf{D}^T] \\ -\mathbf{B}\alpha + \mathbf{A}\beta + \frac{1}{2} \text{diag}[\mathbf{A}\mathbf{B}^T] \end{array} \right] \left( \left[ [\mathbf{C}\Omega + \mathbf{D}]^{-1} \right]^T \mathbf{z} \mid [\mathbf{A}\Omega + \mathbf{B}] [\mathbf{C}\Omega + \mathbf{D}]^{-1} \right) \\ = \kappa(\alpha, \beta, \Gamma) \sqrt{\det[\mathbf{C}\Omega + \mathbf{D}]} e^{\pi i \mathbf{z} \cdot [\mathbf{C}\Omega + \mathbf{D}]^{-1} \mathbf{C} \cdot \mathbf{z}} \theta \left[ \begin{array}{c} \alpha \\ \beta \end{array} \right] (\mathbf{z} | \Omega),$$

where  $\kappa(\alpha, \beta, \Gamma)$  is a complex number that depends on  $\alpha$ ,  $\beta$ , and  $\Gamma$ . However,  $\kappa(\alpha, \beta, \Gamma)$  is independent of  $\mathbf{z}$  and  $\Omega$ . For explicit results in the case  $g = 1$ , see §20.7(viii).

## 21.6 Products

### 21.6(i) Riemann Identity

Let  $\mathbf{T} = [T_{jk}]$  be an arbitrary  $h \times h$  orthogonal matrix (that is,  $\mathbf{T}\mathbf{T}^T = \mathbf{I}$ ) with rational elements. Also, let  $\mathbf{Z}$  be an arbitrary  $g \times h$  matrix. Define

$$21.6.1 \quad \mathcal{K} = \mathbb{Z}^{g \times h} \mathbf{T} / (\mathbb{Z}^{g \times h} \mathbf{T} \cap \mathbb{Z}^{g \times h}),$$

that is,  $\mathcal{K}$  is the set of all  $g \times h$  matrices that are obtained by premultiplying  $\mathbf{T}$  by any  $g \times h$  matrix with integer elements; two such matrices in  $\mathcal{K}$  are considered *equivalent* if their difference is a matrix with integer elements. Also, let

$$21.6.2 \quad \mathcal{D} = |\mathbf{T}^T \mathbb{Z}^h / (\mathbf{T}^T \mathbb{Z}^h \cap \mathbb{Z}^h)|,$$

that is,  $\mathcal{D}$  is the number of elements in the set containing all  $h$ -dimensional vectors obtained by multiplying  $\mathbf{T}^T$  on the right by a vector with integer elements. Two such vectors are considered *equivalent* if their difference

is a vector with integer elements. Then

$$21.6.3 \quad \prod_{j=1}^h \theta \left( \sum_{k=1}^h T_{jk} \mathbf{z}_k \mid \Omega \right) \\ = \frac{1}{\mathcal{D}^g} \sum_{\mathbf{A} \in \mathcal{K}} \sum_{\mathbf{B} \in \mathcal{K}} e^{2\pi i \text{tr}[\frac{1}{2} \mathbf{A}^T \Omega \mathbf{A} + \mathbf{A}^T (\mathbf{Z} + \mathbf{B})]} \\ \times \prod_{j=1}^h \theta(\mathbf{z}_j + \Omega \mathbf{a}_j + \mathbf{b}_j | \Omega),$$

where  $\mathbf{z}_j$ ,  $\mathbf{a}_j$ ,  $\mathbf{b}_j$  denote respectively the  $j$ th columns of  $\mathbf{Z}$ ,  $\mathbf{A}$ ,  $\mathbf{B}$ . This is the *Riemann identity*. On using theta functions with characteristics, it becomes

21.6.4

$$\prod_{j=1}^h \theta \left[ \begin{array}{c} \sum_{k=1}^h T_{jk} \mathbf{c}_k \\ \sum_{k=1}^h T_{jk} \mathbf{d}_k \end{array} \right] \left( \sum_{k=1}^h T_{jk} \mathbf{z}_k \mid \Omega \right) \\ = \frac{1}{\mathcal{D}^g} \sum_{\mathbf{A} \in \mathcal{K}} \sum_{\mathbf{B} \in \mathcal{K}} e^{-2\pi i \sum_{j=1}^h \mathbf{b}_j \cdot \mathbf{c}_j} \prod_{j=1}^h \theta \left[ \begin{array}{c} \mathbf{a}_j + \mathbf{c}_j \\ \mathbf{b}_j + \mathbf{d}_j \end{array} \right] (\mathbf{z}_j | \Omega),$$

where  $\mathbf{c}_j$  and  $\mathbf{d}_j$  are arbitrary  $h$ -dimensional vectors. Many identities involving products of theta functions can be established using these formulas.

#### Example

Let  $h = 4$  and

$$21.6.5 \quad \mathbf{T} = \begin{bmatrix} 1 & 1 & 1 & 1 \\ 1 & 1 & -1 & -1 \\ 1 & -1 & 1 & -1 \\ 1 & -1 & -1 & 1 \end{bmatrix}.$$

Then

$$\begin{aligned}
 & \theta\left(\frac{\mathbf{x} + \mathbf{y} + \mathbf{u} + \mathbf{v}}{2} \middle| \Omega\right) \theta\left(\frac{\mathbf{x} + \mathbf{y} - \mathbf{u} - \mathbf{v}}{2} \middle| \Omega\right) \theta\left(\frac{\mathbf{x} - \mathbf{y} + \mathbf{u} - \mathbf{v}}{2} \middle| \Omega\right) \theta\left(\frac{\mathbf{x} - \mathbf{y} - \mathbf{u} + \mathbf{v}}{2} \middle| \Omega\right) \\
 21.6.6 \quad &= \frac{1}{2^g} \sum_{\alpha \in \frac{1}{2}\mathbb{Z}^g / \mathbb{Z}^g} \sum_{\beta \in \frac{1}{2}\mathbb{Z}^g / \mathbb{Z}^g} e^{2\pi i(2\alpha \cdot \Omega \cdot \alpha + \alpha \cdot [\mathbf{x} + \mathbf{y} + \mathbf{u} + \mathbf{v}])} \\
 & \quad \times \theta(\mathbf{x} + \Omega\alpha + \beta | \Omega) \theta(\mathbf{y} + \Omega\alpha + \beta | \Omega) \theta(\mathbf{u} + \Omega\alpha + \beta | \Omega) \theta(\mathbf{v} + \Omega\alpha + \beta | \Omega),
 \end{aligned}$$

and

$$\begin{aligned}
 21.6.7 \quad & \theta\left[\begin{matrix} \frac{1}{2}[\mathbf{c}_1 + \mathbf{c}_2 + \mathbf{c}_3 + \mathbf{c}_4] \\ \frac{1}{2}[\mathbf{d}_1 + \mathbf{d}_2 + \mathbf{d}_3 + \mathbf{d}_4] \end{matrix} \middle| \Omega\right] \theta\left[\begin{matrix} \frac{1}{2}[\mathbf{c}_1 + \mathbf{c}_2 - \mathbf{c}_3 - \mathbf{c}_4] \\ \frac{1}{2}[\mathbf{d}_1 + \mathbf{d}_2 - \mathbf{d}_3 - \mathbf{d}_4] \end{matrix} \middle| \Omega\right] \left(\frac{\mathbf{x} + \mathbf{y} - \mathbf{u} - \mathbf{v}}{2} \middle| \Omega\right) \\
 & \times \theta\left[\begin{matrix} \frac{1}{2}[\mathbf{c}_1 - \mathbf{c}_2 + \mathbf{c}_3 - \mathbf{c}_4] \\ \frac{1}{2}[\mathbf{d}_1 - \mathbf{d}_2 + \mathbf{d}_3 - \mathbf{d}_4] \end{matrix} \middle| \Omega\right] \theta\left[\begin{matrix} \frac{1}{2}[\mathbf{c}_1 - \mathbf{c}_2 - \mathbf{c}_3 + \mathbf{c}_4] \\ \frac{1}{2}[\mathbf{d}_1 - \mathbf{d}_2 - \mathbf{d}_3 + \mathbf{d}_4] \end{matrix} \middle| \Omega\right] \left(\frac{\mathbf{x} - \mathbf{y} - \mathbf{u} + \mathbf{v}}{2} \middle| \Omega\right) \\
 &= \frac{1}{2^g} \sum_{\alpha \in \frac{1}{2}\mathbb{Z}^g / \mathbb{Z}^g} \sum_{\beta \in \frac{1}{2}\mathbb{Z}^g / \mathbb{Z}^g} e^{-2\pi i\beta \cdot [\mathbf{c}_1 + \mathbf{c}_2 + \mathbf{c}_3 + \mathbf{c}_4]} \theta\left[\begin{matrix} \mathbf{c}_1 + \alpha \\ \mathbf{d}_1 + \beta \end{matrix} \middle| \Omega\right] (\mathbf{x} | \Omega) \theta\left[\begin{matrix} \mathbf{c}_2 + \alpha \\ \mathbf{d}_2 + \beta \end{matrix} \middle| \Omega\right] (\mathbf{y} | \Omega) \theta\left[\begin{matrix} \mathbf{c}_3 + \alpha \\ \mathbf{d}_3 + \beta \end{matrix} \middle| \Omega\right] (\mathbf{u} | \Omega) \theta\left[\begin{matrix} \mathbf{c}_4 + \alpha \\ \mathbf{d}_4 + \beta \end{matrix} \middle| \Omega\right] (\mathbf{v} | \Omega).
 \end{aligned}$$

### 21.6(ii) Addition Formulas

Let  $\alpha, \beta, \gamma, \delta \in \mathbb{R}^g$ . Then

$$\begin{aligned}
 & \theta\left[\begin{matrix} \alpha \\ \gamma \end{matrix} \middle| \Omega\right] (\mathbf{z}_1 | \Omega) \theta\left[\begin{matrix} \beta \\ \delta \end{matrix} \middle| \Omega\right] (\mathbf{z}_2 | \Omega) \\
 21.6.8 \quad &= \sum_{\nu \in \mathbb{Z}^g / (2\mathbb{Z}^g)} \theta\left[\begin{matrix} \frac{1}{2}[\alpha + \beta + \nu] \\ \gamma + \delta \end{matrix} \middle| \Omega\right] (\mathbf{z}_1 + \mathbf{z}_2 | 2\Omega) \\
 & \quad \times \theta\left[\begin{matrix} \frac{1}{2}[\alpha - \beta + \nu] \\ \gamma - \delta \end{matrix} \middle| \Omega\right] (\mathbf{z}_1 - \mathbf{z}_2 | 2\Omega).
 \end{aligned}$$

Thus  $\nu$  is a  $g$ -dimensional vector whose entries are either 0 or 1. For this result and a generalization see Koizumi (1976) and Belokolos *et al.* (1994, pp. 38–41). For addition formulas for classical theta functions see §20.7(ii).

## Applications

### 21.7 Riemann Surfaces

#### 21.7(i) Connection of Riemann Theta Functions to Riemann Surfaces

In almost all applications, a Riemann theta function is associated with a compact Riemann surface. Although there are other ways to represent Riemann surfaces (see e.g. Belokolos *et al.* (1994, §2.1)), they are obtainable from *plane algebraic curves* (Springer (1957), or Riemann (1851)). Consider the set of points in  $\mathbb{C}^2$  that satisfy the equation

$$21.7.1 \quad P(\lambda, \mu) = 0,$$

where  $P(\lambda, \mu)$  is a polynomial in  $\lambda$  and  $\mu$  that does not factor over  $\mathbb{C}^2$ . Equation (21.7.1) determines a

plane algebraic curve in  $\mathbb{C}^2$ , which is made compact by adding its points at infinity. To accomplish this we write (21.7.1) in terms of homogeneous coordinates:

$$21.7.2 \quad \tilde{P}(\tilde{\lambda}, \tilde{\mu}, \tilde{\eta}) = 0,$$

by setting  $\lambda = \tilde{\lambda}/\tilde{\eta}$ ,  $\mu = \tilde{\mu}/\tilde{\eta}$ , and then clearing fractions. This compact curve may have singular points, that is, points at which the gradient of  $\tilde{P}$  vanishes. Removing the singularities of this curve gives rise to a two-dimensional connected manifold with a complex-analytic structure, that is, a *Riemann surface*. All compact Riemann surfaces can be obtained this way.

Since a Riemann surface  $\Gamma$  is a two-dimensional manifold that is orientable (owing to its analytic structure), its only topological invariant is its *genus*  $g$  (the number of *handles* in the surface). On this surface, we choose  $2g$  *cycles* (that is, closed oriented curves, each with at most a finite number of singular points)  $a_j, b_j, j = 1, 2, \dots, g$ , such that their *intersection indices* satisfy

$$21.7.3 \quad a_j \circ a_k = 0, \quad b_j \circ b_k = 0, \quad a_j \circ b_k = \delta_{j,k}.$$

For example, Figure 21.7.1 depicts a genus 2 surface.

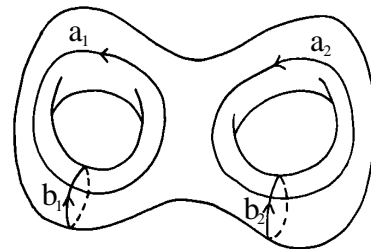


Figure 21.7.1: A basis of cycles for a genus 2 surface.

On a Riemann surface of genus  $g$ , there are  $g$  linearly independent *holomorphic differentials*  $\omega_j, j =$



1, 2, . . . , g. If a local coordinate z is chosen on the Riemann surface, then the local coordinate representation of these holomorphic differentials is given by

$$21.7.4 \quad \omega_j = f_j(z) dz, \quad j = 1, 2, \dots, g,$$

where  $f_j(z)$ ,  $j = 1, 2, \dots, g$  are analytic functions. Thus the differentials  $\omega_j$ ,  $j = 1, 2, \dots, g$  have no singularities on  $\Gamma$ . Note that for the purposes of integrating these holomorphic differentials, all cycles on the surface are a linear combination of the cycles  $a_j, b_j$ ,  $j = 1, 2, \dots, g$ . The  $\omega_j$  are normalized so that

$$21.7.5 \quad \oint_{a_k} \omega_j = \delta_{j,k}, \quad j, k = 1, 2, \dots, g.$$

Then the matrix defined by

$$21.7.6 \quad \Omega_{jk} = \oint_{b_k} \omega_j, \quad j, k = 1, 2, \dots, g,$$

is a Riemann matrix and it is used to define the corresponding Riemann theta function. *In this way, we associate a Riemann theta function with every compact Riemann surface  $\Gamma$ .*

Riemann theta functions originating from Riemann surfaces are special in the sense that a general  $g$ -dimensional Riemann theta function depends on  $g(g + 1)/2$  complex parameters. In contrast, a  $g$ -dimensional Riemann theta function arising from a compact Riemann surface of genus  $g$  ( $> 1$ ) depends on at most  $3g - 3$  complex parameters (one complex parameter for the case  $g = 1$ ). These special Riemann theta functions satisfy many special identities, two of which appear in

21.7.10

$$\begin{aligned} & \theta\left(\mathbf{z} + \int_{P_1}^{P_3} \boldsymbol{\omega} \middle| \boldsymbol{\Omega}\right) \theta\left(\mathbf{z} + \int_{P_2}^{P_4} \boldsymbol{\omega} \middle| \boldsymbol{\Omega}\right) E(P_3, P_2)E(P_1, P_4) + \theta\left(\mathbf{z} + \int_{P_2}^{P_3} \boldsymbol{\omega} \middle| \boldsymbol{\Omega}\right) \theta\left(\mathbf{z} + \int_{P_1}^{P_4} \boldsymbol{\omega} \middle| \boldsymbol{\Omega}\right) E(P_3, P_1)E(P_4, P_2) \\ & = \theta(\mathbf{z}|\boldsymbol{\Omega}) \theta\left(\mathbf{z} + \int_{P_1}^{P_3} \boldsymbol{\omega} + \int_{P_2}^{P_4} \boldsymbol{\omega} \middle| \boldsymbol{\Omega}\right) E(P_1, P_2)E(P_3, P_4), \end{aligned}$$

where again all integration paths are identical for all components. Generalizations of this identity are given in Fay (1973, Chapter 2). Fay derives (21.7.10) as a special case of a more general class of addition theorems for Riemann theta functions on Riemann surfaces.

21.7(iii) Frobenius' Identity

Let  $\Gamma$  be a hyperelliptic Riemann surface. These are Riemann surfaces that may be obtained from algebraic curves of the form

$$21.7.11 \quad \mu^2 = Q(\lambda),$$

where  $Q(\lambda)$  is a polynomial in  $\lambda$  of odd degree  $2g + 1$  ( $\geq 5$ ). The genus of this surface is  $g$ . The zeros  $\lambda_j$ ,

the following subsections. For more information, see Dubrovin (1981), Brieskorn and Knörrer (1986, §9.3), Belokolos *et al.* (1994, Chapter 2), and Mumford (1984, §2.2–2.3).

21.7(ii) Fay's Trisecant Identity

Let  $\boldsymbol{\alpha}, \boldsymbol{\beta}$  be such that

$$21.7.7 \quad \left(\frac{\partial}{\partial z_1} \theta\left[\begin{smallmatrix} \boldsymbol{\alpha} \\ \boldsymbol{\beta} \end{smallmatrix}\right](\mathbf{z}|\boldsymbol{\Omega})\Big|_{\mathbf{z}=\mathbf{0}}, \dots, \frac{\partial}{\partial z_g} \theta\left[\begin{smallmatrix} \boldsymbol{\alpha} \\ \boldsymbol{\beta} \end{smallmatrix}\right](\mathbf{z}|\boldsymbol{\Omega})\Big|_{\mathbf{z}=\mathbf{0}}\right) \neq \mathbf{0}.$$

Define the holomorphic differential

$$21.7.8 \quad \zeta = \sum_{j=1}^g \omega_j \frac{\partial}{\partial z_j} \theta\left[\begin{smallmatrix} \boldsymbol{\alpha} \\ \boldsymbol{\beta} \end{smallmatrix}\right](\mathbf{z}|\boldsymbol{\Omega})\Big|_{\mathbf{z}=\mathbf{0}}.$$

Then the prime form on the corresponding compact Riemann surface  $\Gamma$  is defined by

21.7.9

$$E(P_1, P_2) = \theta\left[\begin{smallmatrix} \boldsymbol{\alpha} \\ \boldsymbol{\beta} \end{smallmatrix}\right] \left(\int_{P_1}^{P_2} \boldsymbol{\omega} \middle| \boldsymbol{\Omega}\right) / \left(\sqrt{\zeta(P_1)}\sqrt{\zeta(P_2)}\right),$$

where  $P_1$  and  $P_2$  are points on  $\Gamma$ ,  $\boldsymbol{\omega} = (\omega_1, \omega_2, \dots, \omega_g)$ , and the path of integration on  $\Gamma$  from  $P_1$  to  $P_2$  is identical for all components. Here  $\sqrt{\zeta(P)}$  is such that  $\sqrt{\zeta(P)}^2 = \zeta(P)$ ,  $P \in \Gamma$ . Either branch of the square roots may be chosen, as long as the branch is consistent across  $\Gamma$ . For all  $\mathbf{z} \in \mathbb{C}^g$ , and all  $P_1, P_2, P_3, P_4$  on  $\Gamma$ , Fay's identity is given by

$j = 1, 2, \dots, 2g + 1$  of  $Q(\lambda)$  specify the finite branch points  $P_j$ , that is, points at which  $\mu_j = 0$ , on the Riemann surface. Denote the set of all branch points by  $B = \{P_1, P_2, \dots, P_{2g+1}, P_\infty\}$ . Consider a fixed subset  $U$  of  $B$ , such that the number of elements  $|U|$  in the set  $U$  is  $g + 1$ , and  $P_\infty \notin U$ . Next, define an isomorphism  $\boldsymbol{\eta}$  which maps every subset  $T$  of  $B$  with an even number of elements to a  $2g$ -dimensional vector  $\boldsymbol{\eta}(T)$  with elements either 0 or  $\frac{1}{2}$ . Define the operation

$$21.7.12 \quad T_1 \ominus T_2 = (T_1 \cup T_2) \setminus (T_1 \cap T_2).$$

Also,  $T^c = B \setminus T$ ,  $\boldsymbol{\eta}^1(T) = (\eta_1(T), \eta_2(T), \dots, \eta_g(T))$ , and  $\boldsymbol{\eta}^2(T) = (\eta_{g+1}(T), \eta_{g+2}(T), \dots, \eta_{2g}(T))$ . Then the

isomorphism is determined completely by:

21.7.13  $\eta(T) = \eta(T^c),$

21.7.14  $\eta(T_1 \ominus T_2) = \eta(T_1) + \eta(T_2),$

21.7.15  $4\eta^1(T) \cdot \eta^2(T) = \frac{1}{2} (|T \ominus U| - g - 1) \pmod{2},$

21.7.16  $4(\eta^1(T_1) \cdot \eta^2(T_2) - \eta^2(T_1) \cdot \eta^1(T_2)) = |T_1 \cap T_2| \pmod{2}.$

Furthermore, let  $\eta(P_\infty) = \mathbf{0}$  and  $\eta(P_j) = \eta(\{P_j, P_\infty\})$ . Then for all  $\mathbf{z}_j \in \mathbb{C}^g, j = 1, 2, 3, 4$ , such that  $\mathbf{z}_1 + \mathbf{z}_2 + \mathbf{z}_3 + \mathbf{z}_4 = 0$ , and for all  $\alpha_j, \beta_j \in \mathbb{R}^g$ , such that  $\alpha_1 + \alpha_2 + \alpha_3 + \alpha_4 = 0$  and  $\beta_1 + \beta_2 + \beta_3 + \beta_4 = 0$ , we have *Frobenius' identity*:

21.7.17 
$$\sum_{P_j \in U} \prod_{k=1}^4 \theta \left[ \begin{matrix} \alpha_k + \eta^1(P_j) \\ \beta_k + \eta^2(P_j) \end{matrix} \right] (\mathbf{z}_k | \Omega)$$

$$= \sum_{P_j \in U^c} \prod_{k=1}^4 \theta \left[ \begin{matrix} \alpha_k + \eta^1(P_j) \\ \beta_k + \eta^2(P_j) \end{matrix} \right] (\mathbf{z}_k | \Omega).$$

### 21.8 Abelian Functions

An Abelian function is a  $2g$ -fold periodic, meromorphic function of  $g$  complex variables. In consequence, Abelian functions are generalizations of elliptic functions (§23.2(iii)) to more than one complex variable. For every Abelian function, there is a positive integer  $n$ , such that the Abelian function can be expressed as a ratio of linear combinations of products with  $n$  factors of Riemann theta functions with characteristics that share a common period lattice. For further information see Igusa (1972, pp. 132–135) and Markushevich (1992).

### 21.9 Integrable Equations

Riemann theta functions arise in the study of *integrable differential equations* that have applications in many areas, including fluid mechanics (Ablowitz and Segur (1981, Chapter 4)), magnetic monopoles (Ercolani and Sinha (1989)), and string theory (Deligne *et al.* (1999, Part 3)). Typical examples of such equations are the Korteweg–de Vries equation

21.9.1  $4u_t = 6uu_x + u_{xxx},$

and the nonlinear Schrödinger equations

21.9.2  $iu_t = -\frac{1}{2}u_{xx} \pm |u|^2u.$

Here, and in what follows,  $x, y$ , and  $t$  suffixes indicate partial derivatives.

Particularly important for the use of Riemann theta functions is the Kadomtsev–Petviashvili (KP) equation, which describes the propagation of two-dimensional, long-wave length surface waves in shallow water (Ablowitz and Segur (1981, Chapter 4)):

21.9.3  $(-4u_t + 6uu_x + u_{xxx})_x + 3u_{yy} = 0.$

Here  $x$  and  $y$  are spatial variables,  $t$  is time, and  $u(x, y, t)$  is the elevation of the surface wave. All quantities are made dimensionless by a suitable scaling transformation. The KP equation has a class of quasi-periodic solutions described by Riemann theta functions, given by

21.9.4  $u(x, y, t) = c + 2 \frac{\partial^2}{\partial x^2} \ln(\theta(\mathbf{k}x + \mathbf{l}y + \omega t + \phi | \Omega)),$

where  $c$  is a complex constant and  $\mathbf{k}, \mathbf{l}, \omega$ , and  $\phi$  are  $g$ -dimensional complex vectors; see Krichever (1976). These parameters, including  $\Omega$ , are not free: they are determined by a compact, connected Riemann surface (Krichever (1976)), or alternatively by an appropriate initial condition  $u(x, y, 0)$  (Deconinck and Segur (1998)). These solutions have been compared successfully with physical experiments for  $g = 1, 2$  (Wiegel (1960), Hammack *et al.* (1989), and Hammack *et al.* (1995)). See Figures 21.9.1 and 21.9.2.

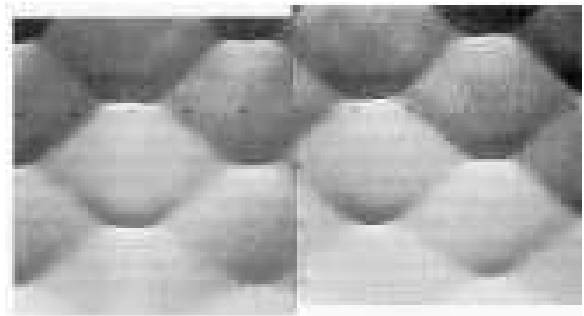


Figure 21.9.1: Two-dimensional periodic waves in a shallow water wave tank, taken from Hammack *et al.* (1995, p. 97) by permission of Cambridge University Press. The original caption reads “Mosaic of two overhead photographs, showing surface patterns of waves in shallow water.”

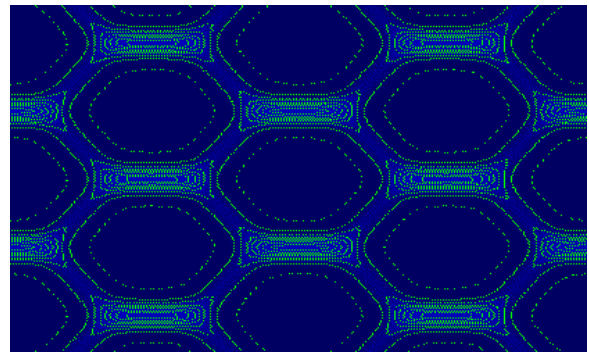


Figure 21.9.2: Contour plot of a two-phase solution of Equation (21.9.3). Such a solution is given in terms of a Riemann theta function with two phases; see Krichever (1976), Dubrovin (1981), and Hammack *et al.* (1995).

Furthermore, the solutions of the KP equation solve the *Schottky problem*: this is the question concerning conditions that a Riemann matrix needs to satisfy in order to be associated with a Riemann surface (Schottky (1903)). Following the work of Krichever (1976), Novikov conjectured that the Riemann theta function in (21.9.4) gives rise to a solution of the KP equation (21.9.3) if, and only if, the theta function originates from a Riemann surface; see Dubrovin (1981, §IV.4). The first part of this conjecture was established in Krichever (1976); the second part was proved in Shiota (1986).

## Computation

### 21.10 Methods of Computation

#### 21.10(i) General Riemann Theta Functions

Although the defining Fourier series (21.2.1) is uniformly convergent on compact sets, its evaluation is cumbersome when one or more of the eigenvalues of  $\Im(\Omega)$  is near zero. Furthermore, for fixed  $\Omega$  different terms of the Fourier series dominate for different values of  $\mathbf{z}$ .

To overcome these obstacles, we compute instead the scaled function  $\hat{\theta}(\mathbf{z}|\Omega)$  (§21.2(i)) from the expansion

##### 21.10.1

$$\hat{\theta}(\mathbf{z}|\Omega) = \sum_{\mathbf{n} \in S(\epsilon)} e^{\pi i[\mathbf{n} - [\mathbf{Y}^{-1}\mathbf{y}]] \cdot \mathbf{x} \cdot [\mathbf{n} - [\mathbf{Y}^{-1}\mathbf{y}]]} \\ \times e^{2\pi i[\mathbf{n} - [\mathbf{Y}^{-1}\mathbf{y}]] \cdot \mathbf{x}} e^{-\pi[\mathbf{n} + [\mathbf{Y}^{-1}\mathbf{y}]] \cdot \mathbf{Y} \cdot [\mathbf{n} + [\mathbf{Y}^{-1}\mathbf{y}]]},$$

where  $\epsilon$  is the tolerated maximum absolute error for  $\hat{\theta}(\mathbf{z}|\Omega)$ . Here  $\mathbf{X} = \Re(\Omega)$ ,  $\mathbf{Y} = \Im(\Omega)$ ,  $\mathbf{x} = \Re(\mathbf{z})$ ,  $\mathbf{y} = \Im(\mathbf{z})$ , and

$$21.10.2 \quad S(\epsilon) = \left\{ \mathbf{m} \in \mathbb{Z}^g \mid \pi \left[ \mathbf{m} + [\mathbf{Y}^{-1}\mathbf{y}] \right] \cdot \mathbf{Y} \cdot \left[ \mathbf{m} + [\mathbf{Y}^{-1}\mathbf{y}] \right] \leq R(\epsilon) \right\}.$$

Thus  $S(\epsilon)$  is the set of all integer vectors that are contained in an ellipsoid centered at the fractional part of  $\mathbf{Y}^{-1}\mathbf{y}$ , and whose size is determined by the allowed absolute error. The value of  $R(\epsilon)$  is determined as follows. Let  $r$  be the length of the shortest vector of the lattice  $\Lambda = \{\sqrt{\pi} \mathbf{T}\mathbf{m} \mid \mathbf{m} \in \mathbb{Z}^g\}$ , and  $\mathbf{T}^T \mathbf{T} = \mathbf{Y}$  be the Cholesky decomposition of  $\mathbf{Y}$  (Atkinson (1989, p. 254)). Then  $R(\epsilon)$  is the greater of  $\sqrt{g/2} + r$  and the smallest positive root of the equation

$$21.10.3 \quad \Gamma\left(\frac{1}{2}g, R^2\right)/(2gr^g) = \epsilon.$$

For the incomplete gamma function  $\Gamma(a, z)$ , see §8.2(i).

The construction (21.10.2) amounts to determining all integer vectors in a  $g$ -dimensional ellipsoid. For this

purpose it is convenient to have the ellipsoid as spherical as possible (Siegel (1973, pp. 144–159), Heil (1995)).

Usually, (21.10.1) can also be used for the efficient evaluation of  $\hat{\theta}(\mathbf{z}|\Omega)$  for fixed  $\Omega$  and varying  $\mathbf{z}$ , by addition of a few vectors to the set  $S(\epsilon)$ .

#### 21.10(ii) Riemann Theta Functions Associated with a Riemann Surface

In addition to evaluating the Fourier series, the main problem here is to compute a Riemann matrix originating from a Riemann surface. Various approaches are considered in the following references:

- Belokolos *et al.* (1994, Chapter 5) and references therein. Here the Riemann surface is represented by the action of a Schottky group on a region of the complex plane. The same representation is used in Gianni *et al.* (1998).
- Tretkoff and Tretkoff (1984). Here a Hurwitz system is chosen to represent the Riemann surface.
- Deconinck and van Hoeij (2001). Here a plane algebraic curve representation of the Riemann surface is used.

### 21.11 Software

See <http://dlmf.nist.gov/21.11>.

## References

### General References

The main references used in writing this chapter are Mumford (1983, 1984), Igusa (1972), and Belokolos *et al.* (1994). For additional bibliographic reading see Dubrovin (1981), Siegel (1971, 1973), and Fay (1973).

### Sources

The following list gives the references or other indications of proofs that were used in constructing the various sections of this chapter. These sources supplement the references that are quoted in the text.

§21.3 Mumford (1983, pp. 120–122).

§21.4 These graphics were computed by the author, using the algorithms described in Deconinck *et al.* (2004).

§21.5 Arnol'd (1997, p. 222), Mumford (1983, pp. 189–210), Igusa (1972, pp. 78–85).

§21.6 Mumford (1983, pp. 211–216), Dubrovin (1981, pp. 22–23).

§21.7 Mumford (1984, pp. 106–120 and 207–260).

§21.9 Dubrovin (1981), Belokolos *et al.* (1994).

§21.10 Deconinck *et al.* (2004).



## Chapter 22

# Jacobian Elliptic Functions

W. P. Reinhardt<sup>1</sup> and P. L. Walker<sup>2</sup>

<b>Notation</b>	<b>550</b>	22.13 Derivatives and Differential Equations . . .	560
22.1 Special Notation . . . . .	550	22.14 Integrals . . . . .	560
<b>Properties</b>	<b>550</b>	22.15 Inverse Functions . . . . .	561
22.2 Definitions . . . . .	550	22.16 Related Functions . . . . .	561
22.3 Graphics . . . . .	550	22.17 Moduli Outside the Interval $[0,1]$ . . . . .	563
22.4 Periods, Poles, and Zeros . . . . .	553	<b>Applications</b>	<b>563</b>
22.5 Special Values . . . . .	554	22.18 Mathematical Applications . . . . .	563
22.6 Elementary Identities . . . . .	556	22.19 Physical Applications . . . . .	564
22.7 Landen Transformations . . . . .	556	<b>Computation</b>	<b>566</b>
22.8 Addition Theorems . . . . .	557	22.20 Methods of Computation . . . . .	566
22.9 Cyclic Identities . . . . .	558	22.21 Tables . . . . .	567
22.10 Maclaurin Series . . . . .	558	22.22 Software . . . . .	567
22.11 Fourier and Hyperbolic Series . . . . .	559	<b>References</b>	<b>567</b>
22.12 Expansions in Other Trigonometric Series and Doubly-Infinite Partial Fractions: Eisenstein Series . . . . .	559		

<sup>1</sup>University of Washington, Seattle, Washington.

<sup>2</sup>American University of Sharjah, Sharjah, United Arab Emirates.

**Acknowledgments:** This chapter is based in part on Abramowitz and Stegun (1964, Chapters 16,18) by L. M. Milne-Thomson and T. H. Southard respectively.

**Copyright** © 2009 National Institute of Standards and Technology. All rights reserved.

## Notation

### 22.1 Special Notation

(For other notation see pp. [xiv](#) and [873](#).)

$x, y$	real variables.
$z$	complex variable.
$k$	modulus. Except in §§ <a href="#">22.3(iv)</a> , <a href="#">22.17</a> , and <a href="#">22.19</a> , $0 \leq k \leq 1$ .
$k'$	complementary modulus, $k^2 + k'^2 = 1$ . If $k \in [0, 1]$ , then $k' \in [0, 1]$ .
$K, K'$	$K(k)$ , $K'(k) = K(k')$ (complete elliptic integrals of the first kind (§ <a href="#">19.2(ii)</a> )).
$q$	nome. $0 \leq q < 1$ except in § <a href="#">22.17</a> ; see also § <a href="#">20.1</a> .
$\tau$	$iK'/K$ .

All derivatives are denoted by differentials, not primes.

The functions treated in this chapter are the three principal Jacobian elliptic functions  $\operatorname{sn}(z, k)$ ,  $\operatorname{cn}(z, k)$ ,  $\operatorname{dn}(z, k)$ ; the nine subsidiary Jacobian elliptic functions  $\operatorname{cd}(z, k)$ ,  $\operatorname{sd}(z, k)$ ,  $\operatorname{nd}(z, k)$ ,  $\operatorname{dc}(z, k)$ ,  $\operatorname{nc}(z, k)$ ,  $\operatorname{sc}(z, k)$ ,  $\operatorname{ns}(z, k)$ ,  $\operatorname{ds}(z, k)$ ,  $\operatorname{cs}(z, k)$ ; the amplitude function  $\operatorname{am}(x, k)$ ; Jacobi's epsilon and zeta functions  $\mathcal{E}(x, k)$  and  $\mathcal{Z}(x|k)$ .

The notation  $\operatorname{sn}(z, k)$ ,  $\operatorname{cn}(z, k)$ ,  $\operatorname{dn}(z, k)$  is due to Gudermann (1838), following Jacobi (1827); that for the subsidiary functions is due to Glaisher (1882). Other notations for  $\operatorname{sn}(z, k)$  are  $\operatorname{sn}(z|m)$  and  $\operatorname{sn}(z, m)$  with  $m = k^2$ ; see [Abramowitz and Stegun \(1964\)](#) and [Walker \(1996\)](#). Similarly for the other functions.

## Properties

### 22.2 Definitions

The nome  $q$  is given in terms of the modulus  $k$  by

$$22.2.1 \quad q = \exp(-\pi K'(k)/K(k)),$$

where  $K(k)$ ,  $K'(k)$  are defined in §[19.2\(ii\)](#). Inversely,

$$22.2.2 \quad k = \frac{\theta_2^2(0, q)}{\theta_3^2(0, q)}, \quad k' = \frac{\theta_4^2(0, q)}{\theta_3^2(0, q)}, \quad K(k) = \frac{\pi}{2} \theta_3^2(0, q),$$

where  $k' = \sqrt{1 - k^2}$  and the theta functions are defined in §[20.2\(i\)](#).

With

$$22.2.3 \quad \zeta = \frac{\pi z}{2K(k)},$$

$$22.2.4 \quad \operatorname{sn}(z, k) = \frac{\theta_3(0, q) \theta_1(\zeta, q)}{\theta_2(0, q) \theta_4(\zeta, q)} = \frac{1}{\operatorname{ns}(z, k)},$$

$$22.2.5 \quad \operatorname{cn}(z, k) = \frac{\theta_4(0, q) \theta_2(\zeta, q)}{\theta_2(0, q) \theta_4(\zeta, q)} = \frac{1}{\operatorname{nc}(z, k)},$$

$$22.2.6 \quad \operatorname{dn}(z, k) = \frac{\theta_4(0, q) \theta_3(\zeta, q)}{\theta_3(0, q) \theta_4(\zeta, q)} = \frac{1}{\operatorname{nd}(z, k)},$$

$$22.2.7 \quad \operatorname{sd}(z, k) = \frac{\theta_3^2(0, q) \theta_1(\zeta, q)}{\theta_2(0, q) \theta_4(0, q) \theta_3(\zeta, q)} = \frac{1}{\operatorname{ds}(z, k)},$$

$$22.2.8 \quad \operatorname{cd}(z, k) = \frac{\theta_3(0, q) \theta_2(\zeta, q)}{\theta_2(0, q) \theta_3(\zeta, q)} = \frac{1}{\operatorname{dc}(z, k)},$$

$$22.2.9 \quad \operatorname{sc}(z, k) = \frac{\theta_3(0, q) \theta_1(\zeta, q)}{\theta_4(0, q) \theta_2(\zeta, q)} = \frac{1}{\operatorname{cs}(z, k)}.$$

As a function of  $z$ , with fixed  $k$ , each of the 12 Jacobian elliptic functions is doubly periodic, having two periods whose ratio is not real. Each is meromorphic in  $z$  for fixed  $k$ , with simple poles and simple zeros, and each is meromorphic in  $k$  for fixed  $z$ . For  $k \in [0, 1]$ , all functions are real for  $z \in \mathbb{R}$ .

#### Glaisher's Notation

The Jacobian functions are related in the following way. Let  $p, q, r$  be any three of the letters  $s, c, d, n$ . Then

$$22.2.10 \quad \operatorname{pq}(z, k) = \frac{\operatorname{pr}(z, k)}{\operatorname{qr}(z, k)} = \frac{1}{\operatorname{qp}(z, k)},$$

with the convention that functions with the same two letters are replaced by unity; e.g.  $\operatorname{ss}(z, k) = 1$ .

The six functions containing the letter  $s$  in their two-letter name are odd in  $z$ ; the other six are even in  $z$ .

In terms of Neville's theta functions (§[20.1](#))

$$22.2.11 \quad \operatorname{pq}(z, k) = \theta_p(z|\tau)/\theta_q(z|\tau),$$

where

$$22.2.12 \quad \tau = iK'(k)/K(k),$$

and  $p, q$  are any pair of the letters  $s, c, d, n$ .

### 22.3 Graphics

#### 22.3(i) Real Variables: Line Graphs

See Figures [22.3.1–22.3.4](#) for line graphs of the functions  $\operatorname{sn}(x, k)$ ,  $\operatorname{cn}(x, k)$ ,  $\operatorname{dn}(x, k)$ , and  $\operatorname{nd}(x, k)$  for representative values of real  $x$  and real  $k$  illustrating the near trigonometric ( $k = 0$ ), and near hyperbolic ( $k = 1$ ) limits. For corresponding graphs for the other 8 Jacobian elliptic functions see <http://dlmf.nist.gov/22.3.i>.

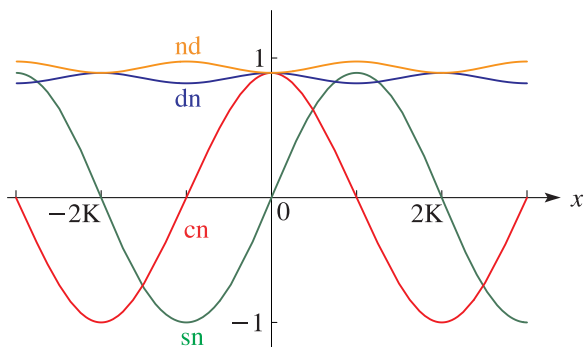


Figure 22.3.1:  $k = 0.4$ ,  $-3K \leq x \leq 3K$ ,  $K = 1.6399\dots$

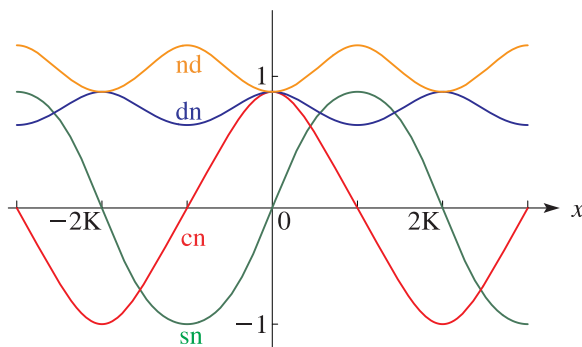


Figure 22.3.2:  $k = 0.7$ ,  $-3K \leq x \leq 3K$ ,  $K = 1.8456\dots$ . For  $\text{cn}(x, k)$  the curve for  $k = 1/\sqrt{2} = 0.70710\dots$  is a boundary between the curves that have an inflection point in the interval  $0 \leq x \leq 2K(k)$ , and its translates, and those that do not; see Walker (1996, p. 146).

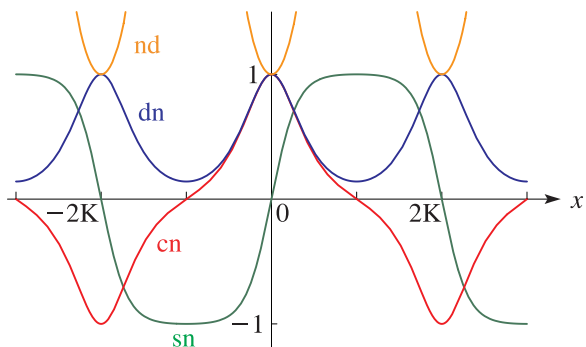


Figure 22.3.3:  $k = 0.99$ ,  $-3K \leq x \leq 3K$ ,  $K = 3.3566\dots$

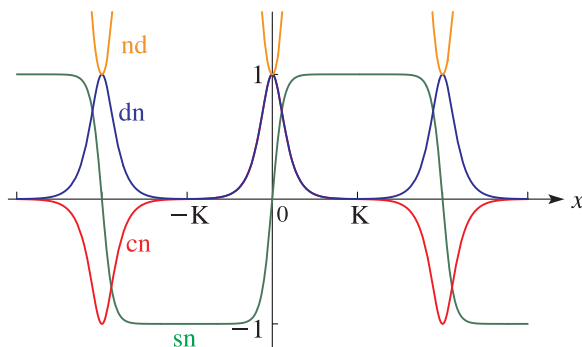


Figure 22.3.4:  $k = 0.999999$ ,  $-3K \leq x \leq 3K$ ,  $K = 7.9474\dots$

### 22.3(ii) Real Variables: Surfaces

See Figure 22.3.13 for  $\text{sn}(x, k)$  as a function of real arguments  $x$  and  $k$ . The period diverges logarithmically as  $k \rightarrow 1^-$ ; see §19.12. For the corresponding surfaces for  $\text{cn}(x, k)$  and  $\text{dn}(x, k)$  see <http://dlmf.nist.gov/22.3.ii>.

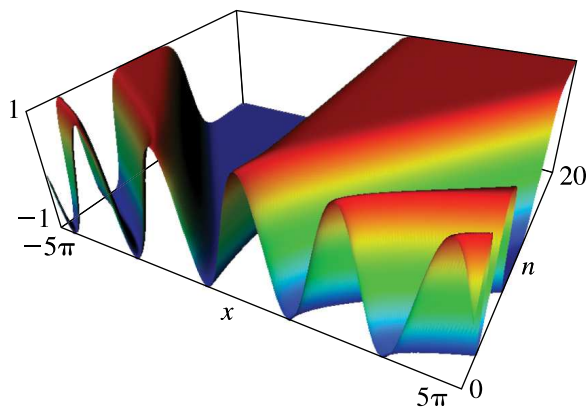


Figure 22.3.13:  $\text{sn}(x, k)$  for  $k = 1 - e^{-n}$ ,  $n = 0$  to  $20$ ,  $-5\pi \leq x \leq 5\pi$ .



22.3(iii) Complex  $z$ ; Real  $k$

In Figure 22.3.16 height corresponds to the absolute value of the function and color to the phase. See p. xiv.

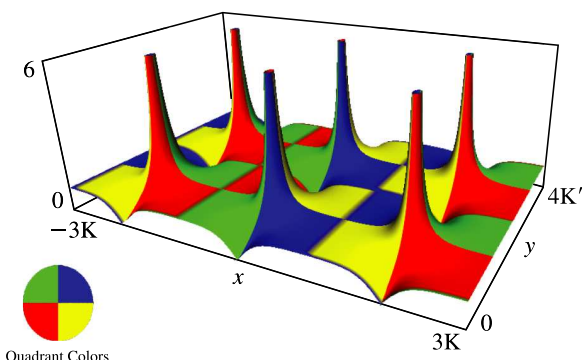


Figure 22.3.16:  $\text{sn}(x + iy, k)$  for  $k = 0.99$ ,  $-3K \leq x \leq 3K$ ,  $0 \leq y \leq 4K'$ .  $K = 3.3566\dots$ ,  $K' = 1.5786\dots$

For the corresponding surfaces for the copolar functions  $\text{cn}(z, k)$  and  $\text{dn}(z, k)$  and the coperiodic functions  $\text{cd}(z, k)$ ,  $\text{dc}(z, k)$ , and  $\text{ns}(z, k)$  with  $z = x + iy$  see <http://dlmf.nist.gov/22.3.iii>.

In Figures 22.3.24 and 22.3.25, height corresponds to the absolute value of the function and color to the phase. See p. xiv.

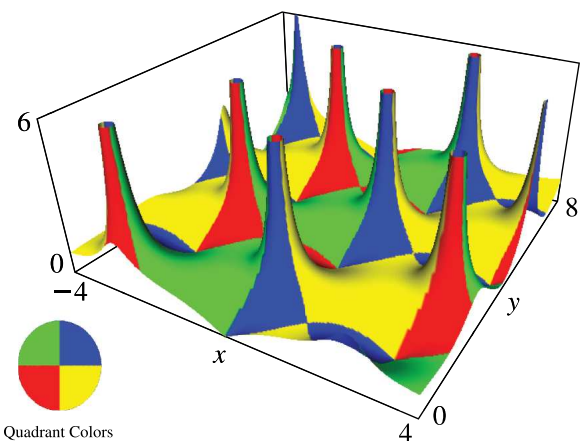


Figure 22.3.24:  $\text{sn}(x + iy, k)$  for  $-4 \leq x \leq 4$ ,  $0 \leq y \leq 8$ ,  $k = 1 + \frac{1}{2}i$ .  $K = 1.5149\dots + i0.5235\dots$ ,  $K' = 1.4620\dots - i0.3552\dots$

22.3(iv) Complex  $k$

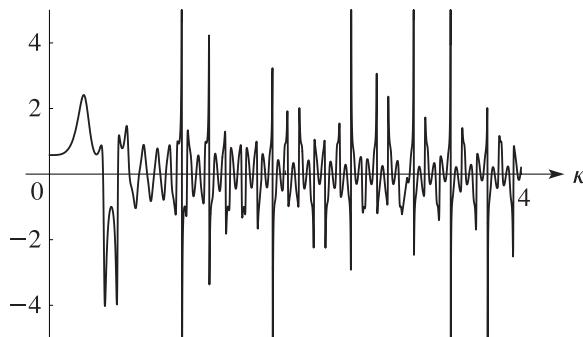


Figure 22.3.22:  $\Re \text{sn}(x, k)$ ,  $x = 120$ , as a function of  $k^2 = i\kappa$ ,  $0 \leq \kappa \leq 4$ .

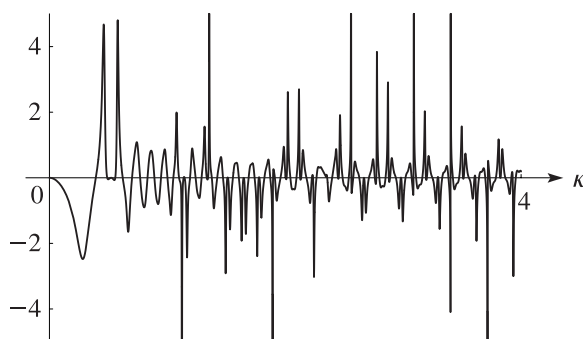


Figure 22.3.23:  $\Im \text{sn}(x, k)$ ,  $x = 120$ , as a function of  $k^2 = i\kappa$ ,  $0 \leq \kappa \leq 4$ .

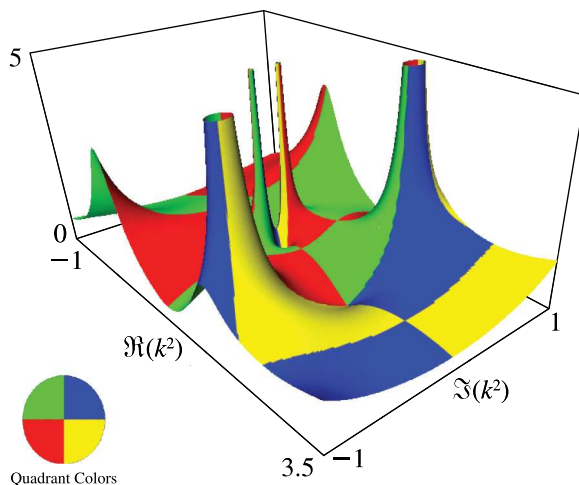


Figure 22.3.25:  $\text{sn}(5, k)$  as a function of complex  $k^2$ ,  $-1 \leq \Re(k^2) \leq 3.5$ ,  $-1 \leq \Im(k^2) \leq 1$ . Compare §22.17(ii).

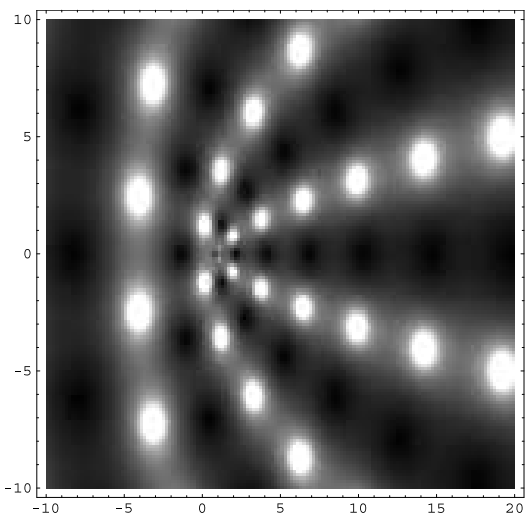


Figure 22.3.26: Density plot of  $|\operatorname{sn}(5, k)|$  as a function of complex  $k^2$ ,  $-10 \leq \Re(k^2) \leq 20$ ,  $-10 \leq \Im(k^2) \leq 10$ . Grayscale, running from 0 (black) to 10 (white), with  $|\operatorname{sn}(5, k)| > 10$  truncated to 10. White spots correspond to poles.

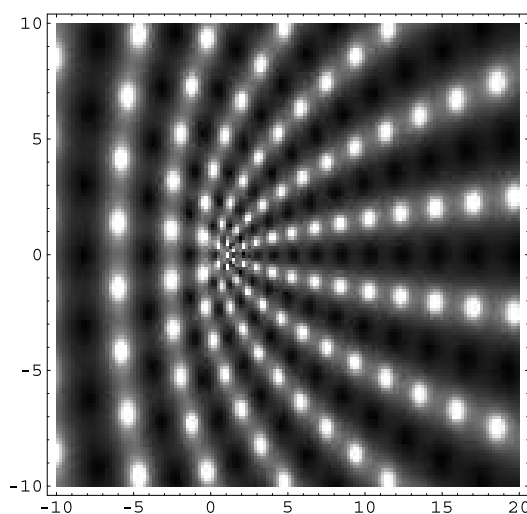


Figure 22.3.27: Density plot of  $|\operatorname{sn}(10, k)|$  as a function of complex  $k^2$ ,  $-10 \leq \Re(k^2) \leq 20$ ,  $-10 \leq \Im(k^2) \leq 10$ . Grayscale, running from 0 (black) to 10 (white), with  $|\operatorname{sn}(10, k)| > 10$  truncated to 10. White spots correspond to poles.

For corresponding density plots with arguments 20 and 30 see <http://dlmf.nist.gov/22.3.iv>.

## 22.4 Periods, Poles, and Zeros

### 22.4(i) Distribution

For each Jacobian function, Table 22.4.1 gives its periods in the  $z$ -plane in the left column, and the position of one of its poles in the second row. The other poles are at *congruent points*, which is the set of points obtained by making translations by  $2mK + 2niK'$ , where  $m, n \in \mathbb{Z}$ . For example, the poles of  $\operatorname{sn}(z, k)$ , abbreviated as  $\operatorname{sn}$  in the following tables, are at  $z = 2mK + (2n + 1)iK'$ .

Table 22.4.1: Periods and poles of Jacobian elliptic functions.

Periods	$z$ -Poles			
	$iK'$	$K + iK'$	$K$	$0$
$4K, 2iK'$	sn	cd	dc	ns
$4K, 2K + 2iK'$	cn	sd	nc	ds
$2K, 4iK'$	dn	nd	sc	cs

Three functions in the same column of Table 22.4.1 are *copolar*, and four functions in the same row are *cope-*

*riodic*.

Table 22.4.2 displays the periods and zeros of the functions in the  $z$ -plane in a similar manner to Table 22.4.1. Again, one member of each congruent set of zeros appears in the second row; all others are generated by translations of the form  $2mK + 2niK'$ , where  $m, n \in \mathbb{Z}$ .

Table 22.4.2: Periods and zeros of Jacobian elliptic functions.

Periods	$z$ -Zeros			
	$0$	$K$	$K + iK'$	$iK'$
$4K, 2iK'$	sn	cd	dc	ns
$4K, 2K + 2iK'$	sd	cn	ds	nc
$2K, 4iK'$	sc	cs	dn	nd

Figure 22.4.1 illustrates the locations in the  $z$ -plane of the poles and zeros of the three principal Jacobian functions in the rectangle with vertices  $0, 2K, 2K + 2iK', 2iK'$ . The other poles and zeros are at the congruent points.

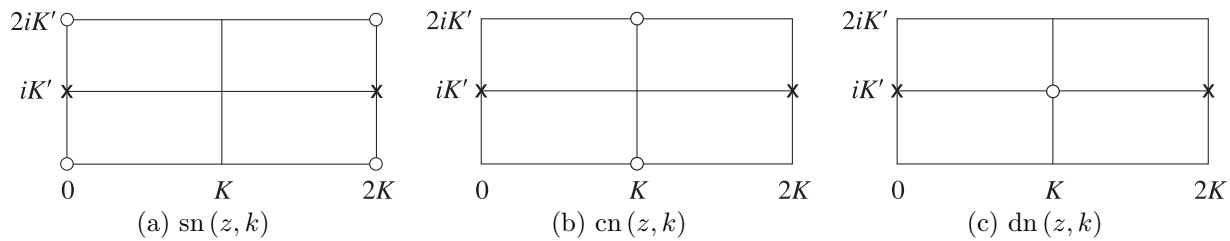


Figure 22.4.1:  $z$ -plane. Poles  $\times \times \times$  and zeros  $o o o$  of the principal Jacobian elliptic functions.

**22.4(ii) Graphical Interpretation via Glaisher's Notation**

Figure 22.4.2 depicts the *fundamental unit cell* in the  $z$ -plane, with vertices  $s = 0$ ,  $c = K$ ,  $d = K + iK'$ ,  $n = iK'$ . The set of points  $z = mK + niK'$ ,  $m, n \in \mathbb{Z}$ , comprise the *lattice* for the 12 Jacobian functions; all other lattice unit cells are generated by translation of the fundamental unit cell by  $mK + niK'$ , where again  $m, n \in \mathbb{Z}$ .

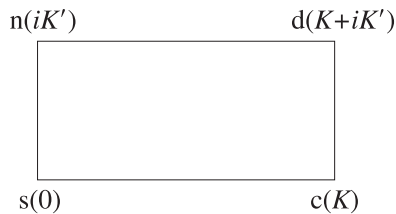


Figure 22.4.2:  $z$ -plane. Fundamental unit cell.

Using the  $p, q$  notation of (22.2.10), Figure 22.4.2 serves as a mnemonic for the poles, zeros, periods, and half-periods of the 12 Jacobian elliptic functions as follows. Let  $p, q$  be any two distinct letters from the set  $s, c, d, n$  which appear in counterclockwise orientation at the corners of all lattice unit cells. Then: (a) In any lattice unit cell  $pq(z, k)$  has a simple zero at  $z = p$  and a simple pole at  $z = q$ . (b) The difference between  $p$  and the nearest  $q$  is a half-period of  $pq(z, k)$ . This half-period will be plus or minus a member of the triple  $K, iK', K + iK'$ ; the other two members of this triple are quarter periods of  $pq(z, k)$ .

**22.4(iii) Translation by Half or Quarter Periods**

See Table 22.4.3.

For example,  $\text{sn}(z + K, k) = \text{cd}(z, k)$ . (The modulus  $k$  is suppressed throughout the table.)

For the other nine functions see <http://dlmf.nist.gov/22.4.iii>.

Table 22.4.3: Half- or quarter-period shifts of variable for the Jacobian elliptic functions.

	$u$					
	$z + K$	$z + K + iK'$	$z + iK'$	$z + 2K$	$z + 2K + 2iK'$	$z + 2iK'$
$\text{sn } u$	$\text{cd } z$	$k^{-1} \text{dc } z$	$k^{-1} \text{ns } z$	$-\text{sn } z$	$-\text{sn } z$	$\text{sn } z$
$\text{cn } u$	$-k' \text{sd } z$	$-ik'k^{-1} \text{nc } z$	$-ik^{-1} \text{ds } z$	$-\text{cn } z$	$\text{cn } z$	$-\text{cn } z$
$\text{dn } u$	$k' \text{nd } z$	$ik' \text{sc } z$	$-i \text{cs } z$	$\text{dn } z$	$-\text{dn } z$	$-\text{dn } z$

**22.5 Special Values**

**22.5(i) Special Values of  $z$**

Table 22.5.1 gives the value of each of the functions  $\text{sn}(z, k)$ ,  $\text{cn}(z, k)$ ,  $\text{dn}(z, k)$ , together with its  $z$ -derivative (or at a pole, the residue), for values of  $z$  that are integer multiples of  $K, iK'$ . For example, at  $z = K + iK'$ ,  $\text{sn}(z, k) = 1/k$ ,  $d\text{sn}(z, k)/dz = 0$ . (The modulus  $k$  is suppressed throughout the table.)

For the other nine functions see <http://dlmf.nist.gov/22.5.i>.

Table 22.5.1: Jacobian elliptic function values, together with derivatives or residues, for special values of the variable.

	$z$						
	0	$K$	$K + iK'$	$iK'$	$2K$	$2K + 2iK'$	$2iK'$
sn $z$	0, 1	1, 0	1/ $k$ , 0	$\infty$ , 1/ $k$	0, -1	0, -1	0, 1
cn $z$	1, 0	0, - $k'$	- $ik'/k$ , 0	$\infty$ , - $i/k$	-1, 0	1, 0	-1, 0
dn $z$	1, 0	$k'$ , 0	0, $ik'$	$\infty$ , - $i$	1, 0	-1, 0	-1, 0

Table 22.5.2 gives sn ( $z, k$ ), cn ( $z, k$ ), dn ( $z, k$ ) for other special values of  $z$ . For example, sn ( $\frac{1}{2}K, k$ ) =  $(1 + k')^{-1/2}$ . For the other nine functions ratios can be taken; compare (22.2.10).

Table 22.5.2: Other special values of Jacobian elliptic functions.

	$z$		
	$\frac{1}{2}K$	$\frac{1}{2}(K + iK')$	$\frac{1}{2}iK'$
sn $z$	$(1 + k')^{-1/2}$	$((1 + k)^{1/2} + i(1 - k)^{1/2}) / (2k)^{1/2}$	$ik^{-1/2}$
cn $z$	$(k' / (1 + k'))^{1/2}$	$(1 - i)k'^{1/2} / (2k)^{1/2}$	$(1 + k)^{1/2}k^{-1/2}$
dn $z$	$k'^{1/2}$	$k'^{1/2}((1 + k')^{1/2} - i(1 - k')^{1/2}) / 2^{1/2}$	$(1 + k)^{1/2}$
	$z$		
	$\frac{3}{2}K$	$\frac{3}{2}(K + iK')$	$\frac{3}{2}iK'$
sn $z$	$(1 + k')^{-1/2}$	$(1 + i)((1 + k)^{1/2} - i(1 - k)^{1/2}) / (2k^{1/2})$	$-ik^{-1/2}$
cn $z$	$-(k' / (1 + k'))^{1/2}$	$(1 - i)k'^{1/2} / (2k)^{1/2}$	$-(1 + k)^{1/2}k^{-1/2}$
dn $z$	$k'^{1/2}$	$(-1 + i)k'^{1/2}((1 + k')^{1/2} + i(1 - k')^{1/2}) / 2$	$-(1 + k)^{1/2}$

**22.5(ii) Limiting Values of  $k$**

If  $k \rightarrow 0+$ , then  $K \rightarrow \pi/2$  and  $K' \rightarrow \infty$ ; if  $k \rightarrow 1-$ , then  $K \rightarrow \infty$  and  $K' \rightarrow \pi/2$ . In these cases the elliptic functions degenerate into elementary trigonometric and hyperbolic functions, respectively. See Tables 22.5.3 and 22.5.4.

Table 22.5.3: Limiting forms of Jacobian elliptic functions as  $k \rightarrow 0$ .

sn ( $z, k$ ) $\rightarrow$ sin $z$	cd ( $z, k$ ) $\rightarrow$ cos $z$	dc ( $z, k$ ) $\rightarrow$ sec $z$	ns ( $z, k$ ) $\rightarrow$ csc $z$
cn ( $z, k$ ) $\rightarrow$ cos $z$	sd ( $z, k$ ) $\rightarrow$ sin $z$	nc ( $z, k$ ) $\rightarrow$ sec $z$	ds ( $z, k$ ) $\rightarrow$ csc $z$
dn ( $z, k$ ) $\rightarrow$ 1	nd ( $z, k$ ) $\rightarrow$ 1	sc ( $z, k$ ) $\rightarrow$ tan $z$	cs ( $z, k$ ) $\rightarrow$ cot $z$

Table 22.5.4: Limiting forms of Jacobian elliptic functions as  $k \rightarrow 1$ .

sn ( $z, k$ ) $\rightarrow$ tanh $z$	cd ( $z, k$ ) $\rightarrow$ 1	dc ( $z, k$ ) $\rightarrow$ 1	ns ( $z, k$ ) $\rightarrow$ coth $z$
cn ( $z, k$ ) $\rightarrow$ sech $z$	sd ( $z, k$ ) $\rightarrow$ sinh $z$	nc ( $z, k$ ) $\rightarrow$ cosh $z$	ds ( $z, k$ ) $\rightarrow$ csch $z$
dn ( $z, k$ ) $\rightarrow$ sech $z$	nd ( $z, k$ ) $\rightarrow$ cosh $z$	sc ( $z, k$ ) $\rightarrow$ cosh $z$	cs ( $z, k$ ) $\rightarrow$ csch $z$

Expansions for  $K, K'$  as  $k \rightarrow 0$  or 1 are given in §§19.5, 19.12.

For values of  $K, K'$  when  $k^2 = \frac{1}{2}$  (lemniscatic case) see §23.5(iii), and for  $k^2 = e^{i\pi/3}$  (equianharmonic case) see §23.5(v).

## 22.6 Elementary Identities

### 22.6(i) Sums of Squares

22.6.1

$$\operatorname{sn}^2(z, k) + \operatorname{cn}^2(z, k) = k^2 \operatorname{sn}^2(z, k) + \operatorname{dn}^2(z, k) = 1,$$

22.6.2  $1 + \operatorname{cs}^2(z, k) = k^2 + \operatorname{ds}^2(z, k) = \operatorname{ns}^2(z, k),$

22.6.3  $k'^2 \operatorname{sc}^2(z, k) + 1 = \operatorname{dc}^2(z, k) = k'^2 \operatorname{nc}^2(z, k) + k^2,$

22.6.4

$$-k^2 k'^2 \operatorname{sd}^2(z, k) = k^2(\operatorname{cd}^2(z, k) - 1) = k'^2(1 - \operatorname{nd}^2(z, k)).$$

### 22.6(ii) Double Argument

22.6.5  $\operatorname{sn}(2z, k) = \frac{2 \operatorname{sn}(z, k) \operatorname{cn}(z, k) \operatorname{dn}(z, k)}{1 - k^2 \operatorname{sn}^4(z, k)},$

22.6.6  $\operatorname{cn}(2z, k) = \frac{\operatorname{cn}^2(z, k) - \operatorname{sn}^2(z, k) \operatorname{dn}^2(z, k)}{1 - k^2 \operatorname{sn}^4(z, k)}$

$$= \frac{\operatorname{cn}^4(z, k) - k'^2 \operatorname{sn}^4(z, k)}{1 - k^2 \operatorname{sn}^4(z, k)},$$

22.6.7  $\operatorname{dn}(2z, k) = \frac{\operatorname{dn}^2(z, k) - k^2 \operatorname{sn}^2(z, k) \operatorname{dn}^2(z, k)}{1 - k^2 \operatorname{sn}^4(z, k)}$

$$= \frac{\operatorname{dn}^4(z, k) + k^2 k'^2 \operatorname{sn}^4(z, k)}{1 - k^2 \operatorname{sn}^4(z, k)}.$$

For corresponding results for the other nine functions see <http://dlmf.nist.gov/22.6.ii>. See also Carlson (2004).

22.6.17  $\frac{1 - \operatorname{cn}(2z, k)}{1 + \operatorname{cn}(2z, k)} = \frac{\operatorname{sn}^2(z, k) \operatorname{dn}^2(z, k)}{\operatorname{cn}^2(z, k)},$

22.6.18  $\frac{1 - \operatorname{dn}(2z, k)}{1 + \operatorname{dn}(2z, k)} = \frac{k^2 \operatorname{sn}^2(z, k) \operatorname{cn}^2(z, k)}{\operatorname{dn}^2(z, k)}.$

### 22.6(iii) Half Argument

22.6.19

$$\begin{aligned} \operatorname{sn}^2\left(\frac{1}{2}z, k\right) &= \frac{1 - \operatorname{cn}(z, k)}{1 + \operatorname{dn}(z, k)} = \frac{1 - \operatorname{dn}(z, k)}{k^2(1 + \operatorname{cn}(z, k))} \\ &= \frac{\operatorname{dn}(z, k) - k^2 \operatorname{cn}(z, k) - k'^2}{k^2(\operatorname{dn}(z, k) - \operatorname{cn}(z, k))}, \end{aligned}$$

22.6.20

$$\begin{aligned} \operatorname{cn}^2\left(\frac{1}{2}z, k\right) &= \frac{-k'^2 + \operatorname{dn}(z, k) + k^2 \operatorname{cn}(z, k)}{k^2(1 + \operatorname{cn}(z, k))} \\ &= \frac{k'^2(1 - \operatorname{dn}(z, k))}{k^2(\operatorname{dn}(z, k) - \operatorname{cn}(z, k))} \\ &= \frac{k'^2(1 + \operatorname{cn}(z, k))}{k'^2 + \operatorname{dn}(z, k) - k^2 \operatorname{cn}(z, k)}, \end{aligned}$$

22.6.21

$$\begin{aligned} \operatorname{dn}^2\left(\frac{1}{2}z, k\right) &= \frac{k^2 \operatorname{cn}(z, k) + \operatorname{dn}(z, k) + k'^2}{1 + \operatorname{dn}(z, k)} \\ &= \frac{k'^2(1 - \operatorname{cn}(z, k))}{\operatorname{dn}(z, k) - \operatorname{cn}(z, k)} \\ &= \frac{k'^2(1 + \operatorname{dn}(z, k))}{k'^2 + \operatorname{dn}(z, k) - k^2 \operatorname{cn}(z, k)}. \end{aligned}$$

If  $\{p, q, r\}$  is any permutation of  $\{c, d, n\}$ , then

22.6.22

$$\begin{aligned} \operatorname{pq}^2\left(\frac{1}{2}z, k\right) &= \frac{\operatorname{ps}(z, k) + \operatorname{rs}(z, k)}{\operatorname{qs}(z, k) + \operatorname{rs}(z, k)} \\ &= \frac{\operatorname{pq}(z, k) + \operatorname{rq}(z, k)}{1 + \operatorname{rq}(z, k)} = \frac{\operatorname{pr}(z, k) + 1}{\operatorname{qr}(z, k) + 1}. \end{aligned}$$

For (22.6.22) and similar results, see Carlson (2004).

### 22.6(iv) Rotation of Argument (Jacobi's Imaginary Transformation)

Table 22.6.1: Jacobi's imaginary transformation of Jacobian elliptic functions.

$\operatorname{sn}(iz, k) = i \operatorname{sc}(z, k')$	$\operatorname{dc}(iz, k) = \operatorname{dn}(z, k')$
$\operatorname{cn}(iz, k) = \operatorname{nc}(z, k')$	$\operatorname{nc}(iz, k) = \operatorname{cn}(z, k')$
$\operatorname{dn}(iz, k) = \operatorname{dc}(z, k')$	$\operatorname{sc}(iz, k) = i \operatorname{sn}(z, k')$
$\operatorname{cd}(iz, k) = \operatorname{nd}(z, k')$	$\operatorname{ns}(iz, k) = -i \operatorname{cs}(z, k')$
$\operatorname{sd}(iz, k) = i \operatorname{sd}(z, k')$	$\operatorname{ds}(iz, k) = -i \operatorname{ds}(z, k')$
$\operatorname{nd}(iz, k) = \operatorname{cd}(z, k')$	$\operatorname{cs}(iz, k) = -i \operatorname{ns}(z, k')$

### 22.6(v) Change of Modulus

See §22.17.

## 22.7 Landen Transformations

### 22.7(i) Descending Landen Transformation

With

22.7.1  $k_1 = \frac{1 - k'}{1 + k'},$

22.7.2  $\operatorname{sn}(z, k) = \frac{(1 + k_1) \operatorname{sn}(z/(1 + k_1), k_1)}{1 + k_1 \operatorname{sn}^2(z/(1 + k_1), k_1)},$

22.7.3

$$\operatorname{cn}(z, k) = \frac{\operatorname{cn}(z/(1 + k_1), k_1) \operatorname{dn}(z/(1 + k_1), k_1)}{1 + k_1 \operatorname{sn}^2(z/(1 + k_1), k_1)},$$

22.7.4  $\operatorname{dn}(z, k) = \frac{\operatorname{dn}^2(z/(1 + k_1), k_1) - (1 - k_1)}{1 + k_1 - \operatorname{dn}^2(z/(1 + k_1), k_1)}.$

**22.7(ii) Ascending Landen Transformation**

With

$$22.7.5 \quad k_2 = \frac{2\sqrt{k}}{1+k}, \quad k'_2 = \frac{1-k}{1+k},$$

22.7.6

$$\operatorname{sn}(z, k) = \frac{(1+k'_2) \operatorname{sn}(z/(1+k'_2), k_2) \operatorname{cn}(z/(1+k'_2), k_2)}{\operatorname{dn}(z/(1+k'_2), k_2)},$$

$$22.7.7 \quad \operatorname{cn}(z, k) = \frac{(1+k'_2)(\operatorname{dn}^2(z/(1+k'_2), k_2) - k'_2)}{k_2^2 \operatorname{dn}(z/(1+k'_2), k_2)},$$

$$22.7.8 \quad \operatorname{dn}(z, k) = \frac{(1-k'_2)(\operatorname{dn}^2(z/(1+k'_2), k_2) + k'_2)}{k_2^2 \operatorname{dn}(z/(1+k'_2), k_2)}.$$

**22.7(iii) Generalized Landen Transformations**

See Khare and Sukhatme (2004).

**22.8 Addition Theorems**

**22.8(i) Sum of Two Arguments**

For  $u, v \in \mathbb{C}$ , and with the common modulus  $k$  suppressed:

$$22.8.1 \quad \operatorname{sn}(u+v) = \frac{\operatorname{sn} u \operatorname{cn} v \operatorname{dn} v + \operatorname{sn} v \operatorname{cn} u \operatorname{dn} u}{1 - k^2 \operatorname{sn}^2 u \operatorname{sn}^2 v},$$

$$22.8.2 \quad \operatorname{cn}(u+v) = \frac{\operatorname{cn} u \operatorname{cn} v - \operatorname{sn} u \operatorname{dn} u \operatorname{sn} v \operatorname{dn} v}{1 - k^2 \operatorname{sn}^2 u \operatorname{sn}^2 v},$$

$$22.8.3 \quad \operatorname{dn}(u+v) = \frac{\operatorname{dn} u \operatorname{dn} v - k^2 \operatorname{sn} u \operatorname{cn} u \operatorname{sn} v \operatorname{cn} v}{1 - k^2 \operatorname{sn}^2 u \operatorname{sn}^2 v}.$$

See also Carlson (2004).

For the other nine functions see <http://dlmf.nist.gov/22.8.i>.

**22.8(ii) Alternative Forms for Sum of Two Arguments**

For  $u, v \in \mathbb{C}$ , and with the common modulus  $k$  suppressed:

$$22.8.13 \quad \operatorname{sn}(u+v) = \frac{\operatorname{sn}^2 u - \operatorname{sn}^2 v}{\operatorname{sn} u \operatorname{cn} v \operatorname{dn} v - \operatorname{sn} v \operatorname{cn} u \operatorname{dn} u},$$

$$22.8.14 \quad \operatorname{sn}(u+v) = \frac{\operatorname{sn} u \operatorname{cn} u \operatorname{dn} v + \operatorname{sn} v \operatorname{cn} v \operatorname{dn} u}{\operatorname{cn} u \operatorname{cn} v + \operatorname{sn} u \operatorname{dn} u \operatorname{sn} v \operatorname{dn} v},$$

$$22.8.15 \quad \operatorname{cn}(u+v) = \frac{\operatorname{sn} u \operatorname{cn} u \operatorname{dn} v - \operatorname{sn} v \operatorname{cn} v \operatorname{dn} u}{\operatorname{sn} u \operatorname{cn} v \operatorname{dn} v - \operatorname{sn} v \operatorname{cn} u \operatorname{dn} u},$$

$$22.8.16 \quad \operatorname{cn}(u+v) = \frac{1 - \operatorname{sn}^2 u - \operatorname{sn}^2 v + k^2 \operatorname{sn}^2 u \operatorname{sn}^2 v}{\operatorname{cn} u \operatorname{cn} v + \operatorname{sn} u \operatorname{dn} u \operatorname{sn} v \operatorname{dn} v},$$

$$22.8.17 \quad \operatorname{dn}(u+v) = \frac{\operatorname{sn} u \operatorname{cn} v \operatorname{dn} u - \operatorname{sn} v \operatorname{cn} u \operatorname{dn} v}{\operatorname{sn} u \operatorname{cn} v \operatorname{dn} v - \operatorname{sn} v \operatorname{cn} u \operatorname{dn} u},$$

$$22.8.18 \quad \operatorname{dn}(u+v) = \frac{\operatorname{cn} u \operatorname{dn} u \operatorname{cn} v \operatorname{dn} v + k'^2 \operatorname{sn} u \operatorname{sn} v}{\operatorname{cn} u \operatorname{cn} v + \operatorname{sn} u \operatorname{dn} u \operatorname{sn} v \operatorname{dn} v}.$$

See also Carlson (2004).

**22.8(iii) Special Relations Between Arguments**

In the following equations the common modulus  $k$  is again suppressed.

Let

$$22.8.19 \quad z_1 + z_2 + z_3 + z_4 = 0.$$

Then

$$22.8.20 \quad \begin{vmatrix} \operatorname{sn} z_1 & \operatorname{cn} z_1 & \operatorname{dn} z_1 & 1 \\ \operatorname{sn} z_2 & \operatorname{cn} z_2 & \operatorname{dn} z_2 & 1 \\ \operatorname{sn} z_3 & \operatorname{cn} z_3 & \operatorname{dn} z_3 & 1 \\ \operatorname{sn} z_4 & \operatorname{cn} z_4 & \operatorname{dn} z_4 & 1 \end{vmatrix} = 0,$$

and

$$22.8.21 \quad \begin{aligned} &k'^2 - k'^2 k^2 \operatorname{sn} z_1 \operatorname{sn} z_2 \operatorname{sn} z_3 \operatorname{sn} z_4 \\ &+ k^2 \operatorname{cn} z_1 \operatorname{cn} z_2 \operatorname{cn} z_3 \operatorname{cn} z_4 \\ &- \operatorname{dn} z_1 \operatorname{dn} z_2 \operatorname{dn} z_3 \operatorname{dn} z_4 = 0. \end{aligned}$$

A geometric interpretation of (22.8.20) analogous to that of (23.10.5) is given in Whittaker and Watson (1927, p. 530).

Next, let

$$22.8.22 \quad z_1 + z_2 + z_3 + z_4 = 2K(k).$$

Then

$$22.8.23 \quad \begin{vmatrix} \operatorname{sn} z_1 \operatorname{cn} z_1 & \operatorname{cn} z_1 \operatorname{dn} z_1 & \operatorname{cn} z_1 & \operatorname{dn} z_1 \\ \operatorname{sn} z_2 \operatorname{cn} z_2 & \operatorname{cn} z_2 \operatorname{dn} z_2 & \operatorname{cn} z_2 & \operatorname{dn} z_2 \\ \operatorname{sn} z_3 \operatorname{cn} z_3 & \operatorname{cn} z_3 \operatorname{dn} z_3 & \operatorname{cn} z_3 & \operatorname{dn} z_3 \\ \operatorname{sn} z_4 \operatorname{cn} z_4 & \operatorname{cn} z_4 \operatorname{dn} z_4 & \operatorname{cn} z_4 & \operatorname{dn} z_4 \end{vmatrix} = 0.$$

For these and related identities see Copson (1935, pp. 415–416).

If sums/differences of the  $z_j$ 's are rational multiples of  $K(k)$ , then further relations follow. For instance, if

$$22.8.24 \quad z_1 - z_2 = z_2 - z_3 = \frac{2}{3}K(k),$$

then

$$22.8.25 \quad \frac{(\operatorname{dn} z_2 + \operatorname{dn} z_3)(\operatorname{dn} z_3 + \operatorname{dn} z_1)(\operatorname{dn} z_1 + \operatorname{dn} z_2)}{\operatorname{dn} z_1 + \operatorname{dn} z_2 + \operatorname{dn} z_3}$$

is independent of  $z_1, z_2, z_3$ . Similarly, if

$$22.8.26 \quad z_1 - z_2 = z_2 - z_3 = z_3 - z_4 = \frac{1}{2}K(k),$$

then

$$22.8.27 \quad \operatorname{dn} z_1 \operatorname{dn} z_3 = \operatorname{dn} z_2 \operatorname{dn} z_4 = k'.$$

Greenhill (1959, pp. 121–130) reviews these results in terms of the geometric *poristic polygon* constructions of Poncelet. Generalizations are given in §22.9.

## 22.9 Cyclic Identities

### 22.9(i) Notation

The following notation is a generalization of that of Khare and Sukhatme (2002).

Throughout this subsection  $m$  and  $p$  are positive integers with  $1 \leq m \leq p$ .

$$22.9.1 \quad s_{m,p}^{(2)} = \operatorname{sn}(z + 2p^{-1}(m-1)K(k), k),$$

$$22.9.2 \quad c_{m,p}^{(2)} = \operatorname{cn}(z + 2p^{-1}(m-1)K(k), k),$$

$$22.9.3 \quad d_{m,p}^{(2)} = \operatorname{dn}(z + 2p^{-1}(m-1)K(k), k),$$

$$22.9.4 \quad s_{m,p}^{(4)} = \operatorname{sn}(z + 4p^{-1}(m-1)K(k), k),$$

$$22.9.5 \quad c_{m,p}^{(4)} = \operatorname{cn}(z + 4p^{-1}(m-1)K(k), k),$$

$$22.9.6 \quad d_{m,p}^{(4)} = \operatorname{dn}(z + 4p^{-1}(m-1)K(k), k).$$

In the remainder of this section the *rank* of an identity is the maximum number of elliptic function factors in each term in the identity. The value of  $p$  determines the number of *points* in the identity. The argument  $z$  is suppressed in the above notation, as all cyclic identities are independent of  $z$ .

### 22.9(ii) Typical Identities of Rank 2

In this subsection  $1 \leq m \leq p$  and  $1 \leq n \leq p$ .

#### Three Points

With

$$22.9.7 \quad \kappa = \operatorname{dn}(2K(k)/3, k),$$

$$22.9.8 \quad s_{1,2}^{(4)}s_{2,2}^{(4)} + s_{2,2}^{(4)}s_{3,2}^{(4)} + s_{3,2}^{(4)}s_{1,2}^{(4)} = \frac{\kappa^2 - 1}{k^2},$$

$$22.9.9 \quad c_{1,2}^{(4)}c_{2,2}^{(4)} + c_{2,2}^{(4)}c_{3,2}^{(4)} + c_{3,2}^{(4)}c_{1,2}^{(4)} = -\frac{\kappa(\kappa + 2)}{(1 + \kappa)^2},$$

$$22.9.10 \quad d_{1,2}^{(2)}d_{2,2}^{(2)} + d_{2,2}^{(2)}d_{3,2}^{(2)} + d_{3,2}^{(2)}d_{1,2}^{(2)} \\ = d_{1,2}^{(4)}d_{2,2}^{(4)} + d_{2,2}^{(4)}d_{3,2}^{(4)} + d_{3,2}^{(4)}d_{1,2}^{(4)} = \kappa(\kappa + 2).$$

These identities are *cyclic* in the sense that each of the indices  $m, n$  in the first product of, for example, the form  $s_{m,2}^{(4)}s_{n,2}^{(4)}$  are *simultaneously permuted* in the cyclic order:  $m \rightarrow m+1 \rightarrow m+2 \rightarrow \dots \rightarrow p \rightarrow 1 \rightarrow 2 \rightarrow \dots \rightarrow m-1$ ;  $n \rightarrow n+1 \rightarrow n+2 \rightarrow \dots \rightarrow p \rightarrow 1 \rightarrow 2 \rightarrow \dots \rightarrow n-1$ . Many of the identities that follow also have this property.

### 22.9(iii) Typical Identities of Rank 3

#### Two Points

$$22.9.11 \quad \left(d_{1,2}^{(2)}\right)^2 d_{2,2}^{(2)} \pm \left(d_{2,2}^{(2)}\right)^2 d_{1,2}^{(2)} = k' \left(d_{1,2}^{(2)} \pm d_{2,2}^{(2)}\right),$$

$$22.9.12 \quad c_{1,2}^{(2)}s_{1,2}^{(2)}d_{2,2}^{(2)} + c_{2,2}^{(2)}s_{2,2}^{(2)}d_{1,2}^{(2)} = 0.$$

#### Three Points

With  $\kappa$  defined as in (22.9.7),

$$22.9.13 \quad s_{1,3}^{(4)}s_{2,3}^{(4)}s_{3,3}^{(4)} = -\frac{1}{1 - \kappa^2} \left(s_{1,3}^{(4)} + s_{2,3}^{(4)} + s_{3,3}^{(4)}\right),$$

$$22.9.14 \quad c_{1,3}^{(4)}c_{2,3}^{(4)}c_{3,3}^{(4)} = \frac{\kappa^2}{1 - \kappa^2} \left(c_{1,3}^{(4)} + c_{2,3}^{(4)} + c_{3,3}^{(4)}\right),$$

$$22.9.15 \quad d_{1,3}^{(2)}d_{2,3}^{(2)}d_{3,3}^{(2)} \\ = \frac{\kappa^2 + k^2 - 1}{1 - \kappa^2} \left(d_{1,3}^{(2)} + d_{2,3}^{(2)} + d_{3,3}^{(2)}\right),$$

$$22.9.16 \quad s_{1,3}^{(4)}c_{2,3}^{(4)}c_{3,3}^{(4)} + s_{2,3}^{(4)}c_{3,3}^{(4)}c_{1,3}^{(4)} + s_{3,3}^{(4)}c_{1,3}^{(4)}c_{2,3}^{(4)} \\ = \frac{\kappa(\kappa + 2)}{1 - \kappa^2} \left(s_{1,3}^{(4)} + s_{2,3}^{(4)} + s_{3,3}^{(4)}\right).$$

#### Four Points

$$22.9.17 \quad d_{1,4}^{(2)}d_{2,4}^{(2)}d_{3,4}^{(2)} \pm d_{2,4}^{(2)}d_{3,4}^{(2)}d_{4,4}^{(2)} + d_{3,4}^{(2)}d_{4,4}^{(2)}d_{1,4}^{(2)} \pm d_{4,4}^{(2)}d_{1,4}^{(2)}d_{2,4}^{(2)} \\ = k' \left(\pm d_{1,4}^{(2)} + d_{2,4}^{(2)} \pm d_{3,4}^{(2)} + d_{4,4}^{(2)}\right),$$

$$22.9.18 \quad \left(d_{1,4}^{(2)}\right)^2 d_{3,4}^{(2)} \pm \left(d_{2,4}^{(2)}\right)^2 d_{4,4}^{(2)} + \left(d_{3,4}^{(2)}\right)^2 d_{1,4}^{(2)} \\ \pm \left(d_{4,4}^{(2)}\right)^2 d_{2,4}^{(2)} = k' \left(d_{1,4}^{(2)} \pm d_{2,4}^{(2)} + d_{3,4}^{(2)} \pm d_{4,4}^{(2)}\right),$$

$$22.9.19 \quad c_{1,4}^{(2)}s_{1,4}^{(2)}d_{3,4}^{(2)} + c_{3,4}^{(2)}s_{3,4}^{(2)}d_{1,4}^{(2)} \\ = c_{2,4}^{(2)}s_{2,4}^{(2)}d_{4,4}^{(2)} + c_{4,4}^{(2)}s_{4,4}^{(2)}d_{2,4}^{(2)} = 0.$$

For identities of rank 4 and higher see <http://dlmf.nist.gov/22.9.iv>.

## 22.10 Maclaurin Series

### 22.10(i) Maclaurin Series in $z$

Initial terms are given by

$$22.10.1 \quad \operatorname{sn}(z, k) = z - (1 + k^2) \frac{z^3}{3!} + (1 + 14k^2 + k^4) \frac{z^5}{5!} \\ - (1 + 135k^2 + 135k^4 + k^6) \frac{z^7}{7!} + O(z^9),$$

$$22.10.2 \quad \operatorname{cn}(z, k) = 1 - \frac{z^2}{2!} + (1 + 4k^2) \frac{z^4}{4!} \\ - (1 + 44k^2 + 16k^4) \frac{z^6}{6!} + O(z^8),$$

$$22.10.3 \quad \operatorname{dn}(z, k) = 1 - k^2 \frac{z^2}{2!} + k^2(4 + k^2) \frac{z^4}{4!} \\ - k^2(16 + 44k^2 + k^4) \frac{z^6}{6!} + O(z^8).$$

Further terms may be derived by substituting in the differential equations (22.13.13), (22.13.14), (22.13.15). The full expansions converge when  $|z| < \min(K(k), K'(k))$ .

**22.10(ii) Maclaurin Series in  $k$  and  $k'$**

Initial terms are given by

**22.10.4**

$$\operatorname{sn}(z, k) = \sin z - \frac{k^2}{4}(z - \sin z \cos z) \cos z + O(k^4),$$

**22.10.5**

$$\operatorname{cn}(z, k) = \cos z + \frac{k^2}{4}(z - \sin z \cos z) \sin z + O(k^4),$$

**22.10.6**

$$\operatorname{dn}(z, k) = 1 - \frac{k^2}{2} \sin^2 z + O(k^4),$$

**22.10.7**

$$\operatorname{sn}(z, k) = \tanh z - \frac{k'^2}{4}(z - \sinh z \cosh z) \operatorname{sech}^2 z + O(k'^4),$$

**22.10.8**

$$\operatorname{cn}(z, k) = \operatorname{sech} z + \frac{k'^2}{4}(z - \sinh z \cosh z) \tanh z \operatorname{sech} z + O(k'^4),$$

**22.10.9**

$$\operatorname{dn}(z, k) = \operatorname{sech} z + \frac{k'^2}{4}(z + \sinh z \cosh z) \tanh z \operatorname{sech} z + O(k'^4).$$

Further terms may be derived from the differential equations (22.13.13), (22.13.14), (22.13.15), or from the integral representations of the inverse functions in §22.15(ii). The radius of convergence is the distance to the origin from the nearest pole in the complex  $k$ -plane in the case of (22.10.4)–(22.10.6), or complex  $k'$ -plane in the case of (22.10.7)–(22.10.9); see §22.17.

**22.11 Fourier and Hyperbolic Series**

Throughout this section  $q$  and  $\zeta$  are defined as in §22.2.

If  $q \exp(2|\Im\zeta|) < 1$ , then

**22.11.1**

$$\operatorname{sn}(z, k) = \frac{2\pi}{Kk} \sum_{n=0}^{\infty} \frac{q^{n+\frac{1}{2}} \sin((2n+1)\zeta)}{1 - q^{2n+1}},$$

**22.11.2**

$$\operatorname{cn}(z, k) = \frac{2\pi}{Kk} \sum_{n=0}^{\infty} \frac{q^{n+\frac{1}{2}} \cos((2n+1)\zeta)}{1 + q^{2n+1}},$$

**22.11.3**

$$\operatorname{dn}(z, k) = \frac{\pi}{2K} + \frac{2\pi}{K} \sum_{n=1}^{\infty} \frac{q^n \cos(2n\zeta)}{1 + q^{2n}}.$$

For the other nine functions see <http://dlmf.nist.gov/22.11>.

Next, with  $E = E(k)$  denoting the complete elliptic integral of the second kind (§19.2(ii)) and  $q \exp(2|\Im\zeta|) < 1$ ,

**22.11.13**

$$\operatorname{sn}^2(z, k) = \frac{1}{k^2} \left(1 - \frac{E}{K}\right) - \frac{2\pi^2}{k^2 K^2} \sum_{n=1}^{\infty} \frac{nq^n}{1 - q^{2n}} \cos(2n\zeta).$$

Similar expansions for  $\operatorname{cn}^2(z, k)$  and  $\operatorname{dn}^2(z, k)$  follow immediately from (22.6.1).

For further Fourier series see Oberhettinger (1973, pp. 23–27).

A related hyperbolic series is

**22.11.14**

$$k^2 \operatorname{sn}^2(z, k) = \frac{E'}{K'} - \left(\frac{\pi}{2K'}\right)^2 \sum_{n=-\infty}^{\infty} \left(\operatorname{sech}^2\left(\frac{\pi}{2K'}(z - 2nK)\right)\right),$$

where  $E' = E'(k)$  is defined by §19.2.9. Again, similar expansions for  $\operatorname{cn}^2(z, k)$  and  $\operatorname{dn}^2(z, k)$  may be derived via (22.6.1). See Dunne and Rao (2000).

**22.12 Expansions in Other Trigonometric Series and Doubly-Infinite Partial Fractions: Eisenstein Series**

With  $t \in \mathbb{C}$  and

**22.12.1**

$$\tau = iK'(k)/K(k),$$

**22.12.2**

$$2Kk \operatorname{sn}(2Kt, k) = \sum_{n=-\infty}^{\infty} \frac{\pi}{\sin(\pi(t - (n + \frac{1}{2})\tau))} = \sum_{n=-\infty}^{\infty} \left( \sum_{m=-\infty}^{\infty} \frac{(-1)^m}{t - m - (n + \frac{1}{2})\tau} \right),$$

**22.12.3**

$$2iKk \operatorname{cn}(2Kt, k) = \sum_{n=-\infty}^{\infty} \frac{(-1)^n \pi}{\sin(\pi(t - (n + \frac{1}{2})\tau))} = \sum_{n=-\infty}^{\infty} \left( \sum_{m=-\infty}^{\infty} \frac{(-1)^{m+n}}{t - m - (n + \frac{1}{2})\tau} \right),$$

**22.12.4**

$$2iK \operatorname{dn}(2Kt, k) = \lim_{N \rightarrow \infty} \sum_{n=-N}^N (-1)^n \frac{\pi}{\tan(\pi(t - (n + \frac{1}{2})\tau))} = \lim_{N \rightarrow \infty} \sum_{n=-N}^N (-1)^n \left( \lim_{M \rightarrow \infty} \sum_{m=-M}^M \frac{1}{t - m - (n + \frac{1}{2})\tau} \right).$$

The double sums in (22.12.2)–(22.12.4) are convergent but not absolutely convergent, hence the order of the summations is important. Compare §20.5(iii).

For corresponding expansions for the subsidiary functions see <http://dlmf.nist.gov/22.12>.



## 22.13 Derivatives and Differential Equations

### 22.13(i) Derivatives

Table 22.13.1: Derivatives of Jacobian elliptic functions with respect to variable.

$\frac{d}{dz}(\operatorname{sn} z) = \operatorname{cn} z \operatorname{dn} z$	$\frac{d}{dz}(\operatorname{dc} z) = k'^2 \operatorname{sc} z \operatorname{nc} z$
$\frac{d}{dz}(\operatorname{cn} z) = -\operatorname{sn} z \operatorname{dn} z$	$\frac{d}{dz}(\operatorname{nc} z) = \operatorname{sc} z \operatorname{dc} z$
$\frac{d}{dz}(\operatorname{dn} z) = -k^2 \operatorname{sn} z \operatorname{cn} z$	$\frac{d}{dz}(\operatorname{sc} z) = \operatorname{dc} z \operatorname{nc} z$
$\frac{d}{dz}(\operatorname{cd} z) = -k'^2 \operatorname{sd} z \operatorname{nd} z$	$\frac{d}{dz}(\operatorname{ns} z) = -\operatorname{ds} z \operatorname{cs} z$
$\frac{d}{dz}(\operatorname{sd} z) = \operatorname{cd} z \operatorname{nd} z$	$\frac{d}{dz}(\operatorname{ds} z) = -\operatorname{cs} z \operatorname{ns} z$
$\frac{d}{dz}(\operatorname{nd} z) = k^2 \operatorname{sd} z \operatorname{cd} z$	$\frac{d}{dz}(\operatorname{cs} z) = -\operatorname{ns} z \operatorname{ds} z$

Note that each derivative in Table 22.13.1 is a constant multiple of the product of the corresponding copolar functions. (The modulus  $k$  is suppressed throughout the table.)

For alternative, and symmetric, formulations of these results see Carlson (2004, 2006a).

### 22.13(ii) First-Order Differential Equations

#### 22.13.1

$$\left(\frac{d}{dz} \operatorname{sn}(z, k)\right)^2 = (1 - \operatorname{sn}^2(z, k))(1 - k^2 \operatorname{sn}^2(z, k)),$$

#### 22.13.2

$$\left(\frac{d}{dz} \operatorname{cn}(z, k)\right)^2 = (1 - \operatorname{cn}^2(z, k))(k'^2 + k^2 \operatorname{cn}^2(z, k)),$$

#### 22.13.3

$$\left(\frac{d}{dz} \operatorname{dn}(z, k)\right)^2 = (1 - \operatorname{dn}^2(z, k))(\operatorname{dn}^2(z, k) - k'^2).$$

For corresponding equations for the subsidiary functions see <http://dlmf.nist.gov/22.13.ii>.

For alternative, and symmetric, formulations of these results see Carlson (2006a).

### 22.13(iii) Second-Order Differential Equations

#### 22.13.13

$$\frac{d^2}{dz^2} \operatorname{sn}(z, k) = -(1 + k^2) \operatorname{sn}(z, k) + 2k^2 \operatorname{sn}^3(z, k),$$

#### 22.13.14

$$\frac{d^2}{dz^2} \operatorname{cn}(z, k) = -(k'^2 - k^2) \operatorname{cn}(z, k) - 2k^2 \operatorname{cn}^3(z, k),$$

#### 22.13.15

$$\frac{d^2}{dz^2} \operatorname{dn}(z, k) = (1 + k'^2) \operatorname{dn}(z, k) - 2 \operatorname{dn}^3(z, k).$$

For corresponding equations for the subsidiary functions see <http://dlmf.nist.gov/22.13.iii>.

For alternative, and symmetric, formulations of these results see Carlson (2006a).

## 22.14 Integrals

### 22.14(i) Indefinite Integrals of Jacobian Elliptic Functions

With  $x \in \mathbb{R}$ ,

$$22.14.1 \quad \int \operatorname{sn}(x, k) dx = k^{-1} \ln(\operatorname{dn}(x, k) - k \operatorname{cn}(x, k)),$$

$$22.14.2 \quad \int \operatorname{cn}(x, k) dx = k^{-1} \operatorname{Arccos}(\operatorname{dn}(x, k)),$$

$$22.14.3 \quad \int \operatorname{dn}(x, k) dx = \operatorname{Arcsin}(\operatorname{sn}(x, k)) = \operatorname{am}(x, k).$$

The branches of the inverse trigonometric functions are chosen so that they are continuous. See §22.16(i) for  $\operatorname{am}(z, k)$ .

For alternative, and symmetric, formulations of these results see Carlson (2006a).

For the corresponding results for the subsidiary functions see <http://dlmf.nist.gov/22.14.i>.

### 22.14(ii) Indefinite Integrals of Powers of Jacobian Elliptic Functions

See §22.16(ii). The indefinite integral of the 3rd power of a Jacobian function can be expressed as an elementary function of Jacobian functions and a product of Jacobian functions. The indefinite integral of a 4th power can be expressed as a complete elliptic integral, a polynomial in Jacobian functions, and the integration variable. See Lawden (1989, pp. 87–88). See also Gradshteyn and Ryzhik (2000, pp. 618–619) and Carlson (2006a).

For indefinite integrals of squares and products of even powers of Jacobian functions in terms of symmetric elliptic integrals, see Carlson (2006b).

### 22.14(iii) Other Indefinite Integrals

In (22.14.13)–(22.14.15),  $0 < x < 2K$ .

$$22.14.13 \quad \int \frac{dx}{\operatorname{sn}(x, k)} = \ln\left(\frac{\operatorname{sn}(x, k)}{\operatorname{cn}(x, k) + \operatorname{dn}(x, k)}\right),$$

$$22.14.14 \quad \int \frac{\operatorname{cn}(x, k) dx}{\operatorname{sn}(x, k)} = \frac{1}{2} \ln\left(\frac{1 - \operatorname{dn}(x, k)}{1 + \operatorname{dn}(x, k)}\right),$$

$$22.14.15 \quad \int \frac{\operatorname{cn}(x, k) dx}{\operatorname{sn}^2(x, k)} = -\frac{\operatorname{dn}(x, k)}{\operatorname{sn}(x, k)}.$$

For additional results see Gradshteyn and Ryzhik (2000, pp. 619–622) and Lawden (1989, Chapter 3).

**22.14(iv) Definite Integrals**

**22.14.16**  $\int_0^{K(k)} \ln(\operatorname{sn}(t, k)) dt = -\frac{1}{4}K'(k) - \frac{1}{2}K(k) \ln k,$

**22.14.17**  $\int_0^{K(k)} \ln(\operatorname{cn}(t, k)) dt = -\frac{1}{4}K'(k) + \frac{1}{2}K(k) \ln(k'/k),$

**22.14.18**  $\int_0^{K(k)} \ln(\operatorname{dn}(t, k)) dt = \frac{1}{2}K(k) \ln k'.$

Corresponding results for the subsidiary functions follow by subtraction; compare (22.2.10).

**22.15 Inverse Functions**

**22.15(i) Definitions**

The inverse Jacobian elliptic functions can be defined in an analogous manner to the inverse trigonometric functions (§4.23). With real variables, the solutions of the equations

**22.15.1**  $\operatorname{sn}(\xi, k) = x, \quad -1 \leq x \leq 1,$

**22.15.2**  $\operatorname{cn}(\eta, k) = x, \quad -1 \leq x \leq 1,$

**22.15.3**  $\operatorname{dn}(\zeta, k) = x, \quad k' \leq x \leq 1,$

are denoted respectively by

**22.15.4**  $\xi = \operatorname{arcsn}(x, k), \quad \eta = \operatorname{arccn}(x, k), \quad \zeta = \operatorname{arcdn}(x, k).$

Each of these inverse functions is multivalued. The *principal values* satisfy

**22.15.5**  $-K \leq \operatorname{arcsn}(x, k) \leq K,$

**22.15.6**  $0 \leq \operatorname{arccn}(x, k) \leq 2K,$

**22.15.7**  $0 \leq \operatorname{arcdn}(x, k) \leq K,$

and *unless stated otherwise* it is assumed that the inverse functions assume their principal values. The general solutions of (22.15.1), (22.15.2), (22.15.3) are, respectively,

**22.15.8**  $\xi = (-1)^m \operatorname{arcsn}(x, k) + 2mK,$

**22.15.9**  $\eta = \pm \operatorname{arccn}(x, k) + 4mK,$

**22.15.10**  $\zeta = \pm \operatorname{arcdn}(x, k) + 2mK,$

where  $m \in \mathbb{Z}$ .

Equations (22.15.1) and (22.15.4), for  $\operatorname{arcsn}(x, k)$ , are equivalent to (22.15.12) and also to

**22.15.11**  $x = \int_0^{\operatorname{sn}(x, k)} \frac{dt}{\sqrt{(1-t^2)(1-k^2t^2)}}, \quad -1 \leq x \leq 1, 0 \leq k \leq 1.$

Similarly with (22.15.13)–(22.15.14) and also the other nine Jacobian elliptic functions.

**22.15(ii) Representations as Elliptic Integrals**

**22.15.12**  $\operatorname{arcsn}(x, k) = \int_0^x \frac{dt}{\sqrt{(1-t^2)(1-k^2t^2)}}, \quad -1 \leq x \leq 1,$

**22.15.13**  $\operatorname{arccn}(x, k) = \int_x^1 \frac{dt}{\sqrt{(1-t^2)(k'^2+k^2t^2)}}, \quad -1 \leq x \leq 1,$

**22.15.14**  $\operatorname{arcdn}(x, k) = \int_x^1 \frac{dt}{\sqrt{(1-t^2)(t^2-k'^2)}}, \quad k' \leq x \leq 1.$

For the corresponding results for the subsidiary functions see <http://dlmf.nist.gov/22.15.ii>.

The integrals (22.15.12)–(22.15.14) can be regarded as *normal forms* for representing the inverse functions. Other integrals, for example,

$$\int_x^b \frac{dt}{\sqrt{(a^2+t^2)(b^2-t^2)}}$$

can be transformed into normal form by elementary change of variables. Comprehensive treatments are given by Carlson (2005), Lawden (1989, pp. 52–55), Bowman (1953, Chapter IX), and Erdélyi *et al.* (1953b, pp. 296–301). See also Abramowitz and Stegun (1964, p. 596).

For representations of the inverse functions as symmetric elliptic integrals see §19.25(v). For power-series expansions see Carlson (2008).

**22.16 Related Functions**

**22.16(i) Jacobi’s Amplitude (am) Function**

**Definition**

**22.16.1**  $\operatorname{am}(x, k) = \operatorname{Arcsin}(\operatorname{sn}(x, k)), \quad x \in \mathbb{R},$  where the inverse sine has its principal value when  $-K \leq x \leq K$  and is defined by continuity elsewhere. See Figure 22.16.1.  $\operatorname{am}(x, k)$  is an infinitely differentiable function of  $x$ .

**Quasi-Periodicity**

**22.16.2**  $\operatorname{am}(x + 2K, k) = \operatorname{am}(x, k) + \pi.$

**Integral Representation**

**22.16.3**  $\operatorname{am}(x, k) = \int_0^x \operatorname{dn}(t, k) dt.$

**Special Values**

**22.16.4**  $\operatorname{am}(x, 0) = x,$

**22.16.5**  $\operatorname{am}(x, 1) = \operatorname{gd}(x).$

For the Gudermannian function  $\operatorname{gd}(x)$  see §4.23(viii).

**Approximation for Small  $x$**

**22.16.6**  $\operatorname{am}(x, k) = x - k^2 \frac{x^3}{3!} + k^2(4+k^2) \frac{x^5}{5!} + O(x^7).$

**Approximations for Small  $k, k'$**

22.16.7  $\operatorname{am}(x, k) = x - \frac{1}{4}k^2(x - \sin x \cos x) + O(k^4),$   
 $\operatorname{am}(x, k) = \operatorname{gd} x - \frac{1}{4}k'^2(x - \sinh x \cosh x) \operatorname{sech} x$   
 22.16.8  $+ O(k'^4).$

**Fourier Series**

With  $q$  as in (22.2.1) and  $\zeta = \pi x/(2K),$

22.16.9  $\operatorname{am}(x, k) = \frac{\pi}{2K}x + 2 \sum_{n=1}^{\infty} \frac{q^n \sin(2n\zeta)}{n(1+q^{2n})}.$

**Relation to Elliptic Integrals**

If  $-K \leq x \leq K,$  then the following four equations are equivalent:

22.16.10  $x = F(\phi, k),$   
 22.16.11  $\operatorname{am}(x, k) = \phi,$   
 22.16.12  $\operatorname{sn}(x, k) = \sin \phi = \sin(\operatorname{am}(x, k)),$   
 22.16.13  $\operatorname{cn}(x, k) = \cos \phi = \cos(\operatorname{am}(x, k)).$

For  $F(\phi, k)$  see §19.2(ii).

**22.16(ii) Jacobi's Epsilon Function**

**Definition**

For  $x \in \mathbb{R}$

22.16.14  $\mathcal{E}(x, k) = \int_0^x \sqrt{\frac{1-k^2t^2}{1-t^2}} dt;$

compare (19.2.5). See Figure 22.16.2.

**Other Integral Representations**

22.16.15  $\mathcal{E}(x, k) = x - k^2 \int_0^x \operatorname{sn}^2(t, k) dt,$

22.16.16  $\mathcal{E}(x, k) = k'^2x + k^2 \int_0^x \operatorname{cn}^2(t, k) dt,$

22.16.17  $\mathcal{E}(x, k) = \int_0^x \operatorname{dn}^2(t, k) dt.$

For corresponding formulas for the subsidiary functions see <http://dlmf.nist.gov/22.16.ii>.

**Quasi-Addition and Quasi-Periodic Formulas**

22.16.27  $\mathcal{E}(x_1 + x_2, k) = \mathcal{E}(x_1, k) + \mathcal{E}(x_2, k) - k^2 \operatorname{sn}(x_1, k) \operatorname{sn}(x_2, k) \operatorname{sn}(x_1 + x_2, k),$

22.16.28  $\mathcal{E}(x + K, k) = \mathcal{E}(x, k) + E(k) - k^2 \operatorname{sn}(x, k) \operatorname{cd}(x, k),$

22.16.29  $\mathcal{E}(x + 2K, k) = \mathcal{E}(x, k) + 2E(k).$

For  $E(k)$  see §19.2(ii).

**Relation to Theta Functions**

22.16.30  $\mathcal{E}(x, k) = \frac{1}{\theta_3^2(0, q) \theta_4(\xi, q)} \frac{d}{d\xi} \theta_4(\xi, q) + \frac{E(k)}{K(k)}x,$

where  $\xi = x/\theta_3^2(0, q).$  For  $\theta_j$  see §20.2(i). For  $E(k)$  see §19.2(ii).

**Relation to the Elliptic Integral  $E(\phi, k)$**

22.16.31  $E(\operatorname{am}(x, k), k) = \mathcal{E}(x, k), \quad -K \leq x \leq K.$

For  $E(\phi, k)$  see §19.2(ii). See also (22.16.14).

**22.16(iii) Jacobi's Zeta Function**

**Definition**

With  $E(k)$  and  $K(k)$  as in §19.2(ii) and  $x \in \mathbb{R},$

22.16.32  $Z(x|k) = \mathcal{E}(x, k) - (E(k)/K(k))x.$

See Figure 22.16.3. (Sometimes in the literature  $Z(x|k)$  is denoted by  $Z(\operatorname{am}(x, k), k^2).$ )

**Properties**

$Z(x|k)$  satisfies the same quasi-addition formula as the function  $\mathcal{E}(x, k),$  given by (22.16.27). Also,

22.16.33  $Z(x + K|k) = Z(x|k) - k^2 \operatorname{sn}(x, k) \operatorname{cd}(x, k),$

22.16.34  $Z(x + 2K|k) = Z(x|k).$

**22.16(iv) Graphs**

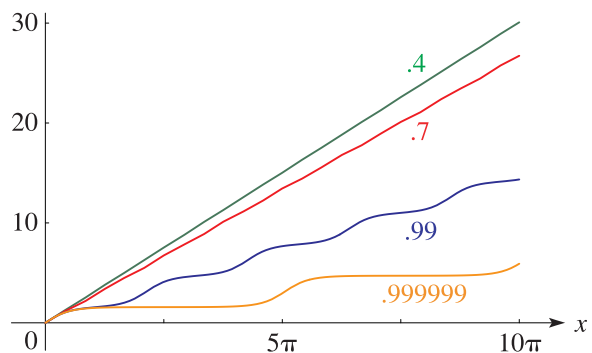


Figure 22.16.1: Jacobi's amplitude function  $\operatorname{am}(x, k)$  for  $0 \leq x \leq 10\pi$  and  $k = 0.4, 0.7, 0.99, 0.999999.$  Values of  $k$  greater than 1 are illustrated in Figure 22.19.1.

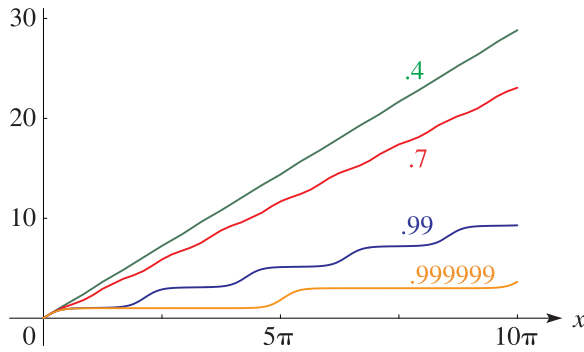


Figure 22.16.2: Jacobi's epsilon function  $\mathcal{E}(x, k)$  for  $0 \leq x \leq 10\pi$  and  $k = 0.4, 0.7, 0.99, 0.999999$ . (These graphs are similar to those in Figure 22.16.1; compare (22.16.3), (22.16.17), and the graphs of  $\text{dn}(x, k)$  in §22.3(i).)

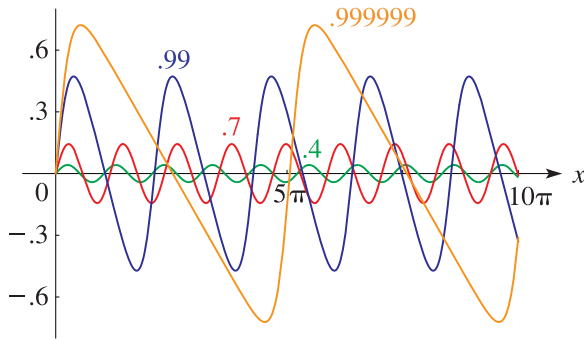


Figure 22.16.3: Jacobi's zeta function  $Z(x|k)$  for  $0 \leq x \leq 10\pi$  and  $k = 0.4, 0.7, 0.99, 0.999999$ .

## 22.17 Moduli Outside the Interval [0,1]

### 22.17(i) Real or Purely Imaginary Moduli

Jacobian elliptic functions with real moduli in the intervals  $(-\infty, 0)$  and  $(1, \infty)$ , or with purely imaginary moduli are related to functions with moduli in the interval  $[0, 1]$  by the following formulas.

First

$$22.17.1 \quad \text{pq}(z, k) = \text{pq}(z, -k),$$

for all twelve functions.

Secondly,

$$22.17.2 \quad \text{sn}(z, 1/k) = k \text{sn}(z/k, k),$$

$$22.17.3 \quad \text{cn}(z, 1/k) = \text{dn}(z/k, k),$$

$$22.17.4 \quad \text{dn}(z, 1/k) = \text{cn}(z/k, k).$$

Thirdly, with

$$22.17.5 \quad k_1 = \frac{k}{\sqrt{1+k^2}}, \quad k_1 k'_1 = \frac{k}{1+k^2},$$

$$22.17.6 \quad \text{sn}(z, ik) = k'_1 \text{sd}(z/k'_1, k_1),$$

$$22.17.7 \quad \text{cn}(z, ik) = \text{cd}(z/k'_1, k_1),$$

$$22.17.8 \quad \text{dn}(z, ik) = \text{nd}(z/k'_1, k_1).$$

In terms of the coefficients of the power series of §22.10(i), the above equations are polynomial identities in  $k$ . In (22.17.5) either value of the square root can be chosen.

### 22.17(ii) Complex Moduli

When  $z$  is fixed each of the twelve Jacobian elliptic functions is a meromorphic function of  $k^2$ . For illustrations see Figures 22.3.25–22.3.27. In consequence, the formulas in this chapter remain valid when  $k$  is complex. In particular, the Landen transformations in §§22.7(i) and 22.7(ii) are valid for all complex values of  $k$ , irrespective of which values of  $\sqrt{k}$  and  $k' = \sqrt{1-k^2}$  are chosen—as long as they are used consistently. For proofs of these results and further information see Walker (2003).

## Applications

### 22.18 Mathematical Applications

#### 22.18(i) Lengths and Parametrization of Plane Curves

##### Ellipse

$$22.18.1 \quad (x^2/a^2) + (y^2/b^2) = 1,$$

with  $a \geq b > 0$ , is parametrized by

$$22.18.2 \quad x = a \text{sn}(u, k), \quad y = b \text{cn}(u, k),$$

where  $k = \sqrt{1 - (b^2/a^2)}$  is the eccentricity, and  $0 \leq u \leq 4K(k)$ . The arc length  $l(u)$  in the first quadrant, measured from  $u = 0$ , is

$$22.18.3 \quad l(u) = a \mathcal{E}(u, k),$$

where  $\mathcal{E}(u, k)$  is Jacobi's epsilon function (§22.16(ii)).

##### Lemniscate

In polar coordinates,  $x = r \cos \phi$ ,  $y = r \sin \phi$ , the lemniscate is given by  $r^2 = \cos(2\phi)$ ,  $0 \leq \phi \leq 2\pi$ . The arc length  $l(r)$ , measured from  $\phi = 0$ , is

$$22.18.4 \quad l(r) = (1/\sqrt{2}) \text{arccn}(r, 1/\sqrt{2}).$$

Inversely:

$$22.18.5 \quad r = \text{cn}(\sqrt{2}l, 1/\sqrt{2}),$$

and

$$22.18.6 \quad x = \text{cn}(\sqrt{2}l, 1/\sqrt{2}) \text{dn}(\sqrt{2}l, 1/\sqrt{2}),$$

$$y = \text{cn}(\sqrt{2}l, 1/\sqrt{2}) \text{sn}(\sqrt{2}l, 1/\sqrt{2}) / \sqrt{2}.$$

For these and other examples see Lawden (1989, Chapter 4), Whittaker and Watson (1927, §22.8), and Siegel (1988, pp. 1–7).

### 22.18(ii) Conformal Mapping

With  $k \in [0, 1]$  the mapping  $z \rightarrow w = \operatorname{sn}(z, k)$  gives a conformal map of the closed rectangle  $[-K, K] \times [0, K']$  onto the half-plane  $\Im w \geq 0$ , with  $0, \pm K, \pm K + iK', iK'$  mapping to  $0, \pm 1, \pm k^{-2}, \infty$  respectively. The half-open rectangle  $(-K, K) \times [-K', K']$  maps onto  $\mathbb{C}$  cut along the intervals  $(-\infty, -1]$  and  $[1, \infty)$ . See Akhiezer (1990, Chapter 8) and McKean and Moll (1999, Chapter 2) for discussions of the inverse mapping. Bowman (1953, Chapters V–VI) gives an overview of the use of Jacobian elliptic functions in conformal maps for engineering applications.

### 22.18(iii) Uniformization and Other Parametrizations

By use of the functions  $\operatorname{sn}$  and  $\operatorname{cn}$ , parametrizations of algebraic equations, such as

$$22.18.7 \quad \begin{aligned} ax^2y^2 + b(x^2y + xy^2) + c(x^2 + y^2) \\ + 2dxy + e(x + y) + f = 0, \end{aligned}$$

in which  $a, b, c, d, e, f$  are real constants, can be achieved in terms of single-valued functions. This circumvents the cumbersome branch structure of the multivalued functions  $x(y)$  or  $y(x)$ , and constitutes the process of *uniformization*; see Siegel (1988, Chapter II). See Baxter (1982, p. 471) for an example from statistical mechanics. Discussion of parametrization of the angles of spherical trigonometry in terms of Jacobian elliptic functions is given in Greenhill (1959, p. 131) and Lawden (1989, §4.4).

### 22.18(iv) Elliptic Curves and the Jacobi–Abel Addition Theorem

Algebraic curves of the form  $y^2 = P(x)$ , where  $P$  is a nonsingular polynomial of degree 3 or 4 (see McKean and Moll (1999, §1.10)), are *elliptic curves*, which are also considered in §23.20(ii). The special case  $y^2 = (1 - x^2)(1 - k^2x^2)$  is in *Jacobian normal form*. For any two points  $(x_1, y_1)$  and  $(x_2, y_2)$  on this curve, their *sum*  $(x_3, y_3)$ , always a third point on the curve, is defined by the Jacobi–Abel addition law

$$22.18.8 \quad \begin{aligned} x_3 &= \frac{x_1y_2 + x_2y_1}{1 - k^2x_1^2x_2^2}, \\ y_3 &= \frac{y_1y_2 + x_2(-1 + k^2)x_1 + 2k^2x_1^3}{1 - k^2x_1^2x_2^2} + x_3 \frac{2k^2x_1y_1x_2^2}{1 - k^2x_1^2x_2^2}, \end{aligned}$$

a construction due to Abel; see Whittaker and Watson (1927, pp. 442, 496–497). This provides an abelian

group structure, and leads to important results in number theory, discussed in an elementary manner by Silverman and Tate (1992), and more fully by Koblitz (1993, Chapter 1, especially §1.7) and McKean and Moll (1999, Chapter 3). The existence of this group structure is connected to the Jacobian elliptic functions via the differential equation (22.13.1). With the identification  $x = \operatorname{sn}(z, k)$ ,  $y = d(\operatorname{sn}(z, k))/dz$ , the addition law (22.18.8) is transformed into the addition theorem (22.8.1); see Akhiezer (1990, pp. 42, 45, 73–74) and McKean and Moll (1999, §§2.14, 2.16). The theory of elliptic functions brings together complex analysis, algebraic curves, number theory, and geometry: Lang (1987), Siegel (1988), and Serre (1973).

## 22.19 Physical Applications

### 22.19(i) Classical Dynamics: The Pendulum

With appropriate scalings, Newton’s equation of motion for a pendulum with a mass in a gravitational field constrained to move in a vertical plane at a fixed distance from a fulcrum is

$$22.19.1 \quad \frac{d^2\theta(t)}{dt^2} = -\sin\theta(t),$$

$\theta$  being the angular displacement from the point of stable equilibrium,  $\theta = 0$ . The bounded  $(-\pi \leq \theta \leq \pi)$  oscillatory solution of (22.19.1) is traditionally written

$$22.19.2 \quad \sin\left(\frac{1}{2}\theta(t)\right) = \sin\left(\frac{1}{2}\alpha\right) \operatorname{sn}\left(t, \sin\left(\frac{1}{2}\alpha\right)\right),$$

for an initial angular displacement  $\alpha$ , with  $d\theta/dt = 0$  at time 0; see Lawden (1989, pp. 114–117). The period is  $4K(\sin(\frac{1}{2}\alpha))$ . The angle  $\alpha = \pi$  is a *separatrix*, separating oscillatory and unbounded motion. With the same initial conditions, if the sign of gravity is reversed then the new period is  $4K'(\sin(\frac{1}{2}\alpha))$ ; see Whittaker (1964, §44).

Alternatively, Sala (1989) writes:

$$22.19.3 \quad \theta(t) = 2 \operatorname{am}\left(t, \sqrt{2/E}\right),$$

for the initial conditions  $\theta(0) = 0$ , the point of stable equilibrium for  $E = 0$ , and  $d\theta(t)/dt = \sqrt{2E}$ . Here  $E = \frac{1}{2}(d\theta(t)/dt)^2 + 1 - \cos\theta(t)$  is the *energy*, which is a first integral of the motion. This formulation gives the bounded and unbounded solutions from the same formula (22.19.3), for  $k \geq 1$  and  $k \leq 1$ , respectively. Also,  $\theta(t)$  is not restricted to the principal range  $-\pi \leq \theta \leq \pi$ . Figure 22.19.1 shows the nature of the solutions  $\theta(t)$  of (22.19.3) by graphing  $\operatorname{am}(x, k)$  for both  $0 \leq k \leq 1$ , as in Figure 22.16.1, and  $k \geq 1$ , where it is periodic.

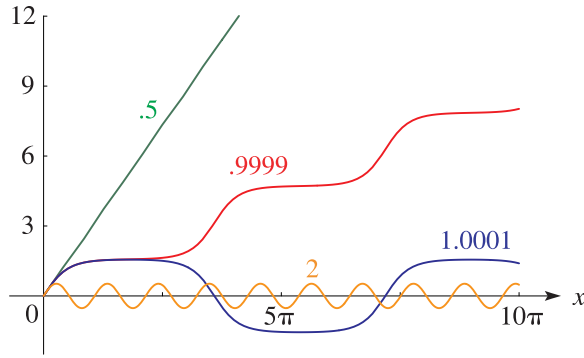


Figure 22.19.1: Jacobi's amplitude function  $\text{am}(x, k)$  for  $0 \leq x \leq 10\pi$  and  $k = 0.5, 0.9999, 1.0001, 2$ . When  $k < 1$ ,  $\text{am}(x, k)$  increases monotonically indicating that the motion of the pendulum is unbounded in  $\theta$ , corresponding to free rotation about the fulcrum; compare Figure 22.16.1. As  $k \rightarrow 1$ -, plateaus are seen as the motion approaches the separatrix where  $\theta = n\pi$ ,  $n = \pm 1, \pm 2, \dots$ , at which points the motion is time independent for  $k = 1$ . This corresponds to the pendulum being "upside down" at a point of unstable equilibrium. For  $k > 1$ , the motion is periodic in  $x$ , corresponding to bounded oscillatory motion.

### 22.19(ii) Classical Dynamics: The Quartic Oscillator

Classical motion in one dimension is described by Newton's equation

$$22.19.4 \quad \frac{d^2x(t)}{dt^2} = -\frac{dV(x)}{dx},$$

where  $V(x)$  is the potential energy, and  $x(t)$  is the coordinate as a function of time  $t$ . The potential

$$22.19.5 \quad V(x) = \pm \frac{1}{2}x^2 \pm \frac{1}{4}\beta x^4$$

plays a prototypical role in classical mechanics (Lawden (1989, §5.2)), quantum mechanics (Schulman (1981, Chapter 29)), and quantum field theory (Pokorski (1987, p. 203), Parisi (1988, §14.6)). Its dynamics for purely imaginary time is connected to the theory of instantons (Itzykson and Zuber (1980, p. 572), Schäfer and Shuryak (1998)), to WKB theory, and to large-order perturbation theory (Bender and Wu (1973), Simon (1982)).

For  $\beta$  real and positive, three of the four possible combinations of signs give rise to bounded oscillatory motions. We consider the case of a particle of mass 1, initially held at rest at displacement  $a$  from the origin and then released at time  $t = 0$ . The subsequent position as a function of time,  $x(t)$ , for the three cases is given with results expressed in terms of  $a$  and the dimensionless parameter  $\eta = \frac{1}{2}\beta a^2$ .

**Case I:**  $V(x) = \frac{1}{2}x^2 + \frac{1}{4}\beta x^4$

This is an example of *Duffing's equation*; see Ablowitz and Clarkson (1991, pp. 150–152) and Lawden (1989, pp. 117–119). The subsequent time evolution is always oscillatory with period  $4K(k)/\sqrt{1+\eta}$ :

$$22.19.6 \quad x(t) = a \operatorname{cn}\left(\sqrt{1+\eta}t, 1/\sqrt{2+\eta^{-1}}\right).$$

**Case II:**  $V(x) = \frac{1}{2}x^2 - \frac{1}{4}\beta x^4$

There is bounded oscillatory motion near  $x = 0$ , with period  $4K(k)/\sqrt{1-\eta}$ , for initial displacements with  $|a| \leq \sqrt{1/\beta}$ :

$$22.19.7 \quad x(t) = a \operatorname{sn}\left(\sqrt{1-\eta}t, 1/\sqrt{\eta^{-1}-1}\right).$$

As  $a \rightarrow \sqrt{1/\beta}$  from below the period diverges since  $a = \pm\sqrt{1/\beta}$  are points of unstable equilibrium.

**Case III:**  $V(x) = -\frac{1}{2}x^2 + \frac{1}{4}\beta x^4$

Two types of oscillatory motion are possible. For an initial displacement with  $\sqrt{1/\beta} \leq |a| \leq \sqrt{2/\beta}$ , bounded oscillations take place near one of the two points of stable equilibrium  $x = \pm\sqrt{1/\beta}$ . Such oscillations, of period  $4K(k)/\sqrt{\eta}$ , are given by:

$$22.19.8 \quad x(t) = a \operatorname{dn}\left(\sqrt{\eta}t, \sqrt{2-\eta^{-1}}\right).$$

As  $a \rightarrow \sqrt{2/\beta}$  from below the period diverges since  $x = 0$  is a point of unstable equilibrium. For initial displacement with  $|a| \geq \sqrt{2/\beta}$  the motion extends over the full range  $-a \leq x \leq a$ :

$$22.19.9 \quad x(t) = a \operatorname{cn}\left(\sqrt{2\eta-1}t, 1/\sqrt{2-\eta^{-1}}\right),$$

with period  $4K(k)/\sqrt{2\eta-1}$ . As  $|a| \rightarrow \sqrt{2/\beta}$  from above the period again diverges. Both the dn and cn solutions approach  $a \operatorname{sech} t$  as  $a \rightarrow \sqrt{2/\beta}$  from the appropriate directions.

### 22.19(iii) Nonlinear ODEs and PDEs

Many nonlinear ordinary and partial differential equations have solutions that may be expressed in terms of Jacobian elliptic functions. These include the time dependent, and time independent, nonlinear Schrödinger equations (NLSE) (Drazin and Johnson (1993, Chapter 2), Ablowitz and Clarkson (1991, pp. 42, 99)), the Korteweg–de Vries (KdV) equation (Kruskal (1974), Li and Olver (2000)), the sine-Gordon equation, and others; see Drazin and Johnson (1993, Chapter 2) for an overview. Such solutions include standing or stationary waves, periodic cnoidal waves, and single and multi-solitons occurring in diverse physical situations such as water waves, optical pulses, quantum fluids, and electrical impulses (Hasegawa (1989), Carr *et al.* (2000), Kivshar and Luther-Davies (1998), and Boyd (1998, Appendix D2.2)).

**22.19(iv) Tops**

The classical rotation of rigid bodies in free space or about a fixed point may be described in terms of elliptic, or *hyperelliptic*, functions if the motion is *integrable* (Audin (1999, Chapter 1)). Hyperelliptic functions  $u(z)$  are solutions of the equation  $z = \int_0^u (f(x))^{-1/2} dx$ , where  $f(x)$  is a polynomial of degree higher than 4. Elementary discussions of this topic appear in Lawden (1989, §5.7), Greenhill (1959, pp. 101–103), and Whittaker (1964, Chapter VI). A more abstract overview is Audin (1999, Chapters III and IV), and a complete discussion of analytical solutions in the elliptic and hyperelliptic cases appears in Golubev (1960, Chapters V and VII), the original hyperelliptic investigation being due to Kowalevski (1889).

**22.19(v) Other Applications**

Numerous other physical or engineering applications involving Jacobian elliptic functions, and their inverses, to problems of classical dynamics, electrostatics, and hydrodynamics appear in Bowman (1953, Chapters VII and VIII) and Lawden (1989, Chapter 5). Whittaker (1964, Chapter IV) enumerates the complete class of one-body classical mechanical problems that are solvable this way.

**Computation**

**22.20 Methods of Computation**

**22.20(i) Via Theta Functions**

A powerful way of computing the twelve Jacobian elliptic functions for real or complex values of both the argument  $z$  and the modulus  $k$  is to use the definitions in terms of theta functions given in §22.2, obtaining the theta functions via methods described in §20.14.

**22.20(ii) Arithmetic-Geometric Mean**

Given real or complex numbers  $a_0, b_0$ , with  $b_0/a_0$  not real and negative, define

**22.20.1** 
$$a_n = \frac{1}{2} (a_{n-1} + b_{n-1}), \quad b_n = (a_{n-1}b_{n-1})^{1/2},$$

$$c_n = \frac{1}{2} (a_{n-1} - b_{n-1}),$$

for  $n \geq 1$ , where the square root is chosen so that  $\text{ph } b_n = \frac{1}{2}(\text{ph } a_{n-1} + \text{ph } b_{n-1})$ , where  $\text{ph } a_{n-1}$  and  $\text{ph } b_{n-1}$  are chosen so that their difference is numerically less than  $\pi$ . Then as  $n \rightarrow \infty$  sequences  $\{a_n\}, \{b_n\}$  converge to a common limit  $M = M(a_0, b_0)$ , the *arithmetic-geometric mean* of  $a_0, b_0$ . And since

**22.20.2** 
$$\max(|a_n - M|, |b_n - M|, |c_n|) \leq (\text{const.}) \times 2^{-2^n},$$

convergence is very rapid.

For  $x$  real and  $k \in (0, 1)$ , use (22.20.1) with  $a_0 = 1, b_0 = k' \in (0, 1), c_0 = k$ , and continue until  $c_N$  is zero to the required accuracy. Next, compute  $\phi_N, \phi_{N-1}, \dots, \phi_0$ , where

**22.20.3** 
$$\phi_N = 2^N a_N x,$$

**22.20.4** 
$$\phi_{n-1} = \frac{1}{2} \left( \phi_n + \arcsin \left( \frac{c_n}{a_n} \sin \phi_n \right) \right),$$

and the inverse sine has its principal value (§4.23(ii)). Then

$$\text{sn}(x, k) = \sin \phi_0, \quad \text{cn}(x, k) = \cos \phi_0,$$

**22.20.5** 
$$\text{dn}(x, k) = \frac{\cos \phi_0}{\cos(\phi_1 - \phi_0)},$$

and the subsidiary functions can be found using (22.2.10).

See also Wachspress (2000).

**Example**

To compute  $\text{sn}, \text{cn}, \text{dn}$  to 10D when  $x = 0.8, k = 0.65$ .

Four iterations of (22.20.1) lead to  $c_4 = 6.5 \times 10^{-12}$ . From (22.20.3) and (22.20.4) we obtain  $\phi_1 = 1.40213 \ 91827$  and  $\phi_0 = 0.76850 \ 92170$ . Then from (22.20.5),  $\text{sn}(0.8, 0.65) = 0.69506 \ 42165$ ,  $\text{cn}(0.8, 0.65) = 0.71894 \ 76580$ ,  $\text{dn}(0.8, 0.65) = 0.89212 \ 34349$ .

**22.20(iii) Landen Transformations**

By application of the transformations given in §§22.7(i) and 22.7(ii),  $k$  or  $k'$  can always be made sufficiently small to enable the approximations given in §22.10(ii) to be applied. The rate of convergence is similar to that for the arithmetic-geometric mean.

**Example**

To compute  $\text{dn}(x, k)$  to 6D for  $x = 0.2, k^2 = 0.19, k' = 0.9$ .

From (22.7.1),  $k_1 = \frac{1}{19}$  and  $x/(1 + k_1) = 0.19$ . From the first two terms in (22.10.6) we find  $\text{dn}(0.19, \frac{1}{19}) = 0.999951$ . Then by using (22.7.4) we have  $\text{dn}(0.2, \sqrt{0.19}) = 0.996253$ .

If needed, the corresponding values of  $\text{sn}$  and  $\text{cn}$  can be found subsequently by applying (22.10.4) and (22.7.2), followed by (22.10.5) and (22.7.3).

**22.20(iv) Lattice Calculations**

If either  $\tau$  or  $q = e^{i\pi\tau}$  is given, then we use  $k = \theta_2^2(0, q)/\theta_3^2(0, q), k' = \theta_4^2(0, q)/\theta_3^2(0, q), K = \frac{1}{2}\pi \theta_3^2(0, q)$ , and  $K' = -i\tau K$ , obtaining the values of the theta functions as in §20.14.

If  $k, k'$  are given with  $k^2 + k'^2 = 1$  and  $\Im k'/\Im k < 0$ , then  $K, K'$  can be found from

**22.20.6** 
$$K = \frac{\pi}{2M(1, k')}, \quad K' = \frac{\pi}{2M(1, k)},$$

using the arithmetic-geometric mean.

**Example 1**

If  $k = k' = 1/\sqrt{2}$ , then three iterations of (22.20.1) give  $M = 0.84721\ 30848$ , and from (22.20.6)  $K = \pi/(2M) = 1.85407\ 46773$  —in agreement with the value of  $(\Gamma(\frac{1}{4}))^2 / (4\sqrt{\pi})$ ; compare (23.17.3) and (23.22.2).

**Example 2**

If  $k' = 1 - i$ , then four iterations of (22.20.1) give  $K = 1.23969\ 74481 + i0.56499\ 30988$ .

**22.20(v) Inverse Functions**

See Wachspress (2000).

**22.20(vi) Related Functions**

$\operatorname{am}(x, k)$  can be computed from its definition (22.16.1) or from its Fourier series (22.16.9). Alternatively, Sala (1989) shows how to apply the arithmetic-geometric mean to compute  $\operatorname{am}(x, k)$ .

Jacobi's epsilon function can be computed from its representation (22.16.30) in terms of theta functions and complete elliptic integrals; compare §20.14. Jacobi's zeta function can then be found by use of (22.16.32).

**22.20(vii) Further References**

For additional information on methods of computation for the Jacobi and related functions, see the introductory sections in the following books: Lawden (1989), Curtis (1964b), Milne-Thomson (1950), and Spenceley and Spenceley (1947).

**22.21 Tables**

Spenceley and Spenceley (1947) tabulates  $\operatorname{sn}(Kx, k)$ ,  $\operatorname{cn}(Kx, k)$ ,  $\operatorname{dn}(Kx, k)$ ,  $\operatorname{am}(Kx, k)$ ,  $\mathcal{E}(Kx, k)$  for  $\arcsin k = 1^\circ(1^\circ)89^\circ$  and  $x = 0(\frac{1}{90})1$  to 12D, or 12 decimals of a radian in the case of  $\operatorname{am}(Kx, k)$ .

Curtis (1964b) tabulates  $\operatorname{sn}(mK/n, k)$ ,  $\operatorname{cn}(mK/n, k)$ ,  $\operatorname{dn}(mK/n, k)$  for  $n = 2(1)15$ ,  $m = 1(1)n - 1$ , and  $q$  (not  $k$ ) = 0(.005)0.35 to 20D.

Lawden (1989, pp. 280–284 and 293–297) tabulates  $\operatorname{sn}(x, k)$ ,  $\operatorname{cn}(x, k)$ ,  $\operatorname{dn}(x, k)$ ,  $\mathcal{E}(x, k)$ ,  $Z(x|k)$  to 5D for  $k = 0.1(.1)0.9$ ,  $x = 0(.1)X$ , where  $X$  ranges from 1.5 to 2.2.

Zhang and Jin (1996, p. 678) tabulates  $\operatorname{sn}(Kx, k)$ ,  $\operatorname{cn}(Kx, k)$ ,  $\operatorname{dn}(Kx, k)$  for  $k = \frac{1}{4}, \frac{1}{2}$  and  $x = 0(.1)4$  to 7D.

For other tables prior to 1961 see Fletcher *et al.* (1962, pp. 500–503) and Lebedev and Fedorova (1960, pp. 221–223).

Tables of theta functions (§20.15) can also be used to compute the twelve Jacobian elliptic functions by application of the quotient formulas given in §22.2.

**22.22 Software**

See <http://dlmf.nist.gov/22.22>.

**References****General References**

The main references used for the mathematical properties in this chapter are Bowman (1953), Copson (1935), Lawden (1989), McKean and Moll (1999), Walker (1996), Whittaker and Watson (1927), and for physical applications Drazin and Johnson (1993), Lawden (1989), Walker (1996).

**Sources**

The following list gives the references or other indications of proofs that were used in constructing the various sections in this chapter. These sources supplement the references that are quoted in the text.

§22.2 Lawden (1989, §2.1), Whittaker and Watson (1927, §22.1), Walker (1996, §§5.1, 6.2), Walker (2003).

§22.3 These graphics were produced at NIST and by the authors.

§22.4 Lawden (1989, §§2.1, 2.2), Whittaker and Watson (1927, §§22.1–22.3), Walker (1996, §6.2).

§22.5 Lawden (1989, §§2.1–2.2, 2.6), Whittaker and Watson (1927, §22.3).

§22.6 Lawden (1989, §§2.4–2.6), Whittaker and Watson (1927, §§22.1, 22.4), Walker (1996, §6.2). For (22.6.6) and (22.6.7) set  $u = v = z$  in (22.8.2) and use (22.6.1) repeatedly.

§22.7 Lawden (1989, §3.9), Whittaker and Watson (1927, §22.42), Walker (1996, p. 148).

§22.8 Lawden (1989, §2.4 and p. 43), Whittaker and Watson (1927, §22.2 and p. 530), Walker (1996, §6.2).

§22.9 Khare and Sukhatme (2002), Khare *et al.* (2003).

§22.10 Lawden (1989, §§2.5, 3.1). The expansions in powers of  $k'$  follow from those in powers of  $k$  by use of Table 22.6.1 and (4.28.8)–(4.28.10).



- §22.11** Walker (1996, §5.4), Whittaker and Watson (1927, §22.6). For (22.11.13) see Deconinck and Kutz (2006, Eq. (48)). The version of this formula in Byrd and Friedman (1971, p. 307, Eq. (911.01)) is incorrect; see Tang (1969).
- §22.12** For the first right-hand sides of (22.12.2)–(22.12.4) see Lawden (1989, §8.8). The second right-hand sides of (22.12.2)–(22.12.4) can be obtained from the corresponding first right-hand sides by substituting, as appropriate, the expansions  $\pi \csc(\pi\zeta) = \sum_{m=-\infty}^{\infty} (-1)^m / (\zeta - m)$  or  $\pi \cot(\pi\zeta) = \lim_{M \rightarrow \infty} \sum_{m=-M}^M 1 / (\zeta - m)$ ; compare (4.22.5) and (4.22.3).
- §22.13** Lawden (1989, §2.5), Walker (1996, §6.2), Whittaker and Watson (1927, §§22.1–22.2). (22.13.13)–(22.13.15) are obtained by differentiation of (22.13.1)–(22.13.3).
- §22.14** Lawden (1989, §2.7), Whittaker and Watson (1927, §§22.5, 22.72).
- §22.15** Bowman (1953, Chapter 1), Lawden (1989, §§3.1, 3.2), Whittaker and Watson (1927, §22.72).
- §22.16** Lawden (1989, §§3.4–3.6), Walker (1996, §6.5), Whittaker and Watson (1927, §§22.72–22.73). The figures were produced at NIST.
- §22.17** Lawden (1989, §3.9).
- §22.19** Lawden (1989, §§5.1–5.2). The figure was produced at NIST.
- §22.20** Walker (1996, pp. 141–143).

## Chapter 23

# Weierstrass Elliptic and Modular Functions

W. P. Reinhardt<sup>1</sup> and P. L. Walker<sup>2</sup>

<b>Notation</b>	<b>570</b>	<b>Modular Functions</b>	<b>579</b>
23.1 Special Notation . . . . .	570	23.15 Definitions . . . . .	579
<b>Weierstrass Elliptic Functions</b>	<b>570</b>	23.16 Graphics . . . . .	579
23.2 Definitions and Periodic Properties . . . . .	570	23.17 Elementary Properties . . . . .	580
23.3 Differential Equations . . . . .	571	23.18 Modular Transformations . . . . .	580
23.4 Graphics . . . . .	571	23.19 Interrelations . . . . .	581
23.5 Special Lattices . . . . .	574	<b>Applications</b>	<b>581</b>
23.6 Relations to Other Functions . . . . .	574	23.20 Mathematical Applications . . . . .	581
23.7 Quarter Periods . . . . .	576	23.21 Physical Applications . . . . .	582
23.8 Trigonometric Series and Products . . . . .	576	<b>Computation</b>	<b>583</b>
23.9 Laurent and Other Power Series . . . . .	577	23.22 Methods of Computation . . . . .	583
23.10 Addition Theorems and Other Identities . . . . .	577	23.23 Tables . . . . .	584
23.11 Integral Representations . . . . .	578	23.24 Software . . . . .	584
23.12 Asymptotic Approximations . . . . .	578	<b>References</b>	<b>584</b>
23.13 Zeros . . . . .	579		
23.14 Integrals . . . . .	579		

<sup>1</sup>University of Washington, Seattle, Washington.

<sup>2</sup>American University of Sharjah, Sharjah, United Arab Emirates.

**Acknowledgments:** This chapter is based in part on Abramowitz and Stegun (1964, Chapter 18) by T. H. Southard.

**Copyright** © 2009 National Institute of Standards and Technology. All rights reserved.

## Notation

### 23.1 Special Notation

(For other notation see pp. [xiv](#) and [873](#).)

$\mathbb{L}$	lattice in $\mathbb{C}$ .
$\ell, n$	integers.
$m$	integer, except in §23.20(ii).
$z = x + iy$	complex variable, except in §§23.20(ii), 23.21(iii).
$[a, b]$ or $(a, b)$	closed, or open, straight-line segment joining $a$ and $b$ , whether or not $a$ and $b$ are real.
primes	derivatives with respect to the variable, except where indicated otherwise.
$K(k), K'(k)$	complete elliptic integrals (§19.2(i)).
$2\omega_1, 2\omega_3$	lattice generators ( $\Im(\omega_3/\omega_1) > 0$ ).
$\omega_2$	$-\omega_1 - \omega_3$ .
$\tau = \omega_3/\omega_1$	lattice parameter ( $\Im\tau > 0$ ).
$q = e^{i\pi\omega_3/\omega_1}$ $= e^{i\pi\tau}$	nome.
$g_2, g_3$	lattice invariants.
$e_1, e_2, e_3$	zeros of Weierstrass normal cubic $4z^3 - g_2z - g_3$ .
$\Delta$	discriminant $g_2^3 - 27g_3^2$ .
$n\mathbb{Z}$	set of all integer multiples of $n$ .
$S_1/S_2$	set of all elements of $S_1$ , modulo elements of $S_2$ . Thus two elements of $S_1/S_2$ are equivalent if they are both in $S_1$ and their difference is in $S_2$ . (For an example see §20.12(ii).)
$G \times H$	Cartesian product of groups $G$ and $H$ , that is, the set of all pairs of elements $(g, h)$ with group operation $(g_1, h_1) + (g_2, h_2) = (g_1 + g_2, h_1 + h_2)$ .

The main functions treated in this chapter are the Weierstrass  $\wp$ -function  $\wp(z) = \wp(z|\mathbb{L}) = \wp(z; g_2, g_3)$ ; the Weierstrass zeta function  $\zeta(z) = \zeta(z|\mathbb{L}) = \zeta(z; g_2, g_3)$ ; the Weierstrass sigma function  $\sigma(z) = \sigma(z|\mathbb{L}) = \sigma(z; g_2, g_3)$ ; the elliptic modular function  $\lambda(\tau)$ ; Klein's complete invariant  $J(\tau)$ ; Dedekind's eta function  $\eta(\tau)$ .

#### Other Notations

[Whittaker and Watson \(1927\)](#) requires only  $\Im(\omega_3/\omega_1) \neq 0$ , instead of  $\Im(\omega_3/\omega_1) > 0$ . [Abramowitz and Stegun \(1964, Chapter 18\)](#) considers only rectangular and rhombic lattices (§23.5);  $\omega_1, \omega_3$  are replaced by  $\omega, \omega'$  for the former and by  $\omega_2, \omega'$  for the latter. [Silverman and Tate \(1992\)](#) and [Koblitz \(1993\)](#) replace  $2\omega_1$  and  $2\omega_3$  by  $\omega_1$  and  $\omega_3$ , respectively. [Walker \(1996\)](#) normalizes  $2\omega_1 = 1, 2\omega_3 = \tau$ , and uses homogeneity (§23.10(iv)). [McKean and Moll \(1999\)](#) replaces  $2\omega_1$  and  $2\omega_3$  by  $\omega_1$  and  $\omega_2$ , respectively.

## Weierstrass Elliptic Functions

### 23.2 Definitions and Periodic Properties

#### 23.2(i) Lattices

If  $\omega_1$  and  $\omega_3$  are nonzero real or complex numbers such that  $\Im(\omega_3/\omega_1) > 0$ , then the set of points  $2m\omega_1 + 2n\omega_3$ , with  $m, n \in \mathbb{Z}$ , constitutes a *lattice*  $\mathbb{L}$  with  $2\omega_1$  and  $2\omega_3$  *lattice generators*.

The generators of a given lattice  $\mathbb{L}$  are not unique. For example, if

$$23.2.1 \quad \omega_1 + \omega_2 + \omega_3 = 0,$$

then  $2\omega_2, 2\omega_3$  are generators, as are  $2\omega_2, 2\omega_1$ . In general, if

$$23.2.2 \quad \chi_1 = a\omega_1 + b\omega_3, \quad \chi_3 = c\omega_1 + d\omega_3,$$

where  $a, b, c, d$  are integers, then  $2\chi_1, 2\chi_3$  are generators of  $\mathbb{L}$  iff

$$23.2.3 \quad ad - bc = 1.$$

#### 23.2(ii) Weierstrass Elliptic Functions

$$23.2.4 \quad \wp(z) = \frac{1}{z^2} + \sum_{w \in \mathbb{L} \setminus \{0\}} \left( \frac{1}{(z-w)^2} - \frac{1}{w^2} \right),$$

$$23.2.5 \quad \zeta(z) = \frac{1}{z} + \sum_{w \in \mathbb{L} \setminus \{0\}} \left( \frac{1}{z-w} + \frac{1}{w} + \frac{z}{w^2} \right),$$

$$23.2.6 \quad \sigma(z) = z \prod_{w \in \mathbb{L} \setminus \{0\}} \left( \left(1 - \frac{z}{w}\right) \exp\left(\frac{z}{w} + \frac{z^2}{2w^2}\right) \right).$$

The double series and double product are absolutely and uniformly convergent in compact sets in  $\mathbb{C}$  that do not include lattice points. Hence the order of the terms or factors is immaterial.

When  $z \notin \mathbb{L}$  the functions are related by

$$23.2.7 \quad \wp(z) = -\zeta'(z),$$

$$23.2.8 \quad \zeta(z) = \sigma'(z)/\sigma(z).$$

$\wp(z)$  and  $\zeta(z)$  are meromorphic functions with poles at the lattice points.  $\wp(z)$  is even and  $\zeta(z)$  is odd. The poles of  $\wp(z)$  are double with residue 0; the poles of  $\zeta(z)$  are simple with residue 1. The function  $\sigma(z)$  is entire and odd, with simple zeros at the lattice points. When it is important to display the lattice with the functions they are denoted by  $\wp(z|\mathbb{L}), \zeta(z|\mathbb{L}),$  and  $\sigma(z|\mathbb{L})$ , respectively.

### 23.2(iii) Periodicity

If  $2\omega_1, 2\omega_3$  is any pair of generators of  $\mathbb{L}$ , and  $\omega_2$  is defined by (23.2.1), then

$$23.2.9 \quad \wp(z + 2\omega_j) = \wp(z), \quad j = 1, 2, 3.$$

Hence  $\wp(z)$  is an *elliptic function*, that is,  $\wp(z)$  is meromorphic and periodic on a lattice; equivalently,  $\wp(z)$  is meromorphic and has two periods whose ratio is not real. We also have

$$23.2.10 \quad \wp'(\omega_j) = 0, \quad j = 1, 2, 3.$$

The function  $\zeta(z)$  is quasi-periodic: for  $j = 1, 2, 3$ ,

$$23.2.11 \quad \zeta(z + 2\omega_j) = \zeta(z) + 2\eta_j,$$

where

$$23.2.12 \quad \eta_j = \zeta(\omega_j).$$

Also,

$$23.2.13 \quad \eta_1 + \eta_2 + \eta_3 = 0,$$

$$23.2.14 \quad \eta_3\omega_2 - \eta_2\omega_3 = \eta_2\omega_1 - \eta_1\omega_2 = \eta_1\omega_3 - \eta_3\omega_1 = \frac{1}{2}\pi i.$$

For  $j = 1, 2, 3$ , the function  $\sigma(z)$  satisfies

$$23.2.15 \quad \sigma(z + 2\omega_j) = -e^{2\eta_j(z+\omega_j)} \sigma(z),$$

$$23.2.16 \quad \sigma'(2\omega_j) = -e^{2\eta_j\omega_j}.$$

More generally, if  $j = 1, 2, 3, k = 1, 2, 3, j \neq k$ , and  $m, n \in \mathbb{Z}$ , then

$$23.2.17 \quad \begin{aligned} & \sigma(z + 2m\omega_j + 2n\omega_k) / \sigma(z) \\ &= (-1)^{m+n+mn} \exp((2m\eta_j + 2n\eta_k)(m\omega_j + n\omega_k + z)). \end{aligned}$$

For further quasi-periodic properties of the  $\sigma$ -function see Lawden (1989, §6.2).

## 23.3 Differential Equations

### 23.3(i) Invariants, Roots, and Discriminant

The *lattice invariants* are defined by

$$23.3.1 \quad g_2 = 60 \sum_{w \in \mathbb{L} \setminus \{0\}} w^{-4},$$

$$23.3.2 \quad g_3 = 140 \sum_{w \in \mathbb{L} \setminus \{0\}} w^{-6}.$$

The *lattice roots* satisfy the cubic equation

$$23.3.3 \quad 4z^3 - g_2z - g_3 = 0,$$

and are denoted by  $e_1, e_2, e_3$ . The *discriminant* (§1.11(ii)) is given by

$$23.3.4 \quad \Delta = g_2^3 - 27g_3^2 = 16(e_2 - e_3)^2(e_3 - e_1)^2(e_1 - e_2)^2.$$

In consequence,

$$23.3.5 \quad e_1 + e_2 + e_3 = 0,$$

$$23.3.6 \quad g_2 = 2(e_1^2 + e_2^2 + e_3^2) = -4(e_2e_3 + e_3e_1 + e_1e_2),$$

$$23.3.7 \quad g_3 = 4e_1e_2e_3 = \frac{4}{3}(e_1^3 + e_2^3 + e_3^3).$$

Let  $g_2^3 \neq 27g_3^2$ , or equivalently  $\Delta$  be nonzero, or  $e_1, e_2, e_3$  be distinct. Given  $g_2$  and  $g_3$  there is a unique lattice  $\mathbb{L}$  such that (23.3.1) and (23.3.2) are satisfied. We may therefore define

$$23.3.8 \quad \wp(z; g_2, g_3) = \wp(z|\mathbb{L}).$$

Similarly for  $\zeta(z; g_2, g_3)$  and  $\sigma(z; g_2, g_3)$ . As functions of  $g_2$  and  $g_3$ ,  $\wp(z; g_2, g_3)$  and  $\zeta(z; g_2, g_3)$  are meromorphic and  $\sigma(z; g_2, g_3)$  is entire.

Conversely,  $g_2, g_3$ , and the set  $\{e_1, e_2, e_3\}$  are determined uniquely by the lattice  $\mathbb{L}$  independently of the choice of generators. However, given any pair of generators  $2\omega_1, 2\omega_3$  of  $\mathbb{L}$ , and with  $\omega_2$  defined by (23.2.1), we can identify the  $e_j$  individually, via

$$23.3.9 \quad e_j = \wp(\omega_j|\mathbb{L}), \quad j = 1, 2, 3.$$

In what follows, *it will be assumed that* (23.3.9) always applies.

### 23.3(ii) Differential Equations and Derivatives

$$23.3.10 \quad \wp'^2(z) = 4\wp^3(z) - g_2\wp(z) - g_3,$$

$$23.3.11 \quad \wp'^2(z) = 4(\wp(z) - e_1)(\wp(z) - e_2)(\wp(z) - e_3),$$

$$23.3.12 \quad \wp''(z) = 6\wp^2(z) - \frac{1}{2}g_2,$$

$$23.3.13 \quad \wp'''(z) = 12\wp(z)\wp'(z).$$

See also (23.2.7) and (23.2.8).

## 23.4 Graphics

### 23.4(i) Real Variables

See Figures 23.4.1–23.4.7 for line graphs of the Weierstrass functions  $\wp(x), \zeta(x)$ , and  $\sigma(x)$ , illustrating the lemniscatic and equianharmonic cases. (The figures in this subsection may be compared with the figures in §22.3(i).)

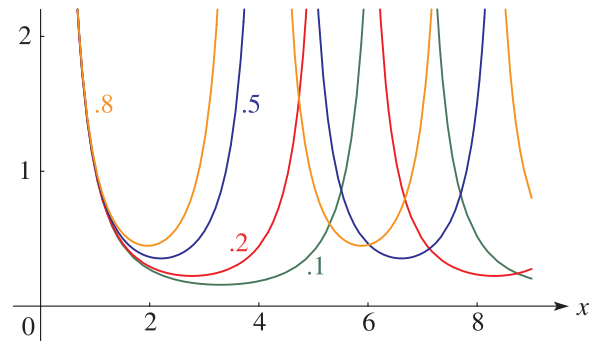


Figure 23.4.1:  $\wp(x; g_2, 0)$  for  $0 \leq x \leq 9, g_2 = 0.1, 0.2, 0.5, 0.8$ . (Lemniscatic case.)

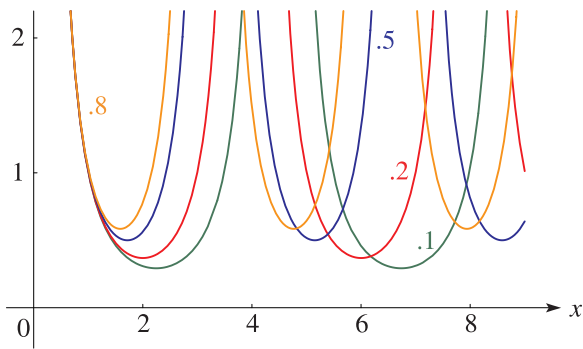


Figure 23.4.2:  $\wp(x; 0, g_3)$  for  $0 \leq x \leq 9$ ,  $g_3 = 0.1, 0.2, 0.5, 0.8$ . (Equianharmonic case.)

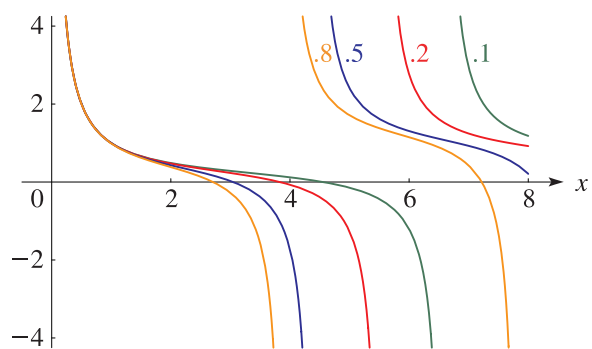


Figure 23.4.3:  $\zeta(x; g_2, 0)$  for  $0 \leq x \leq 8$ ,  $g_2 = 0.1, 0.2, 0.5, 0.8$ . (Lemniscatic case.)

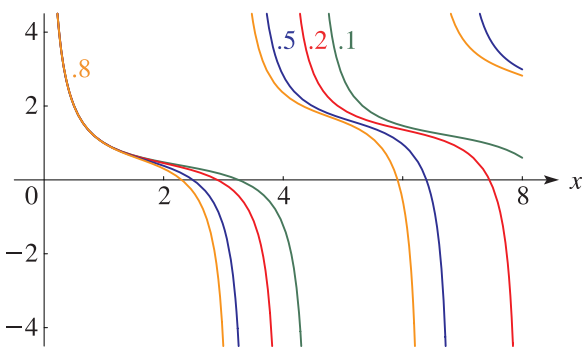


Figure 23.4.4:  $\zeta(x; 0, g_3)$  for  $0 \leq x \leq 8$ ,  $g_3 = 0.1, 0.2, 0.5, 0.8$ . (Equianharmonic case.)

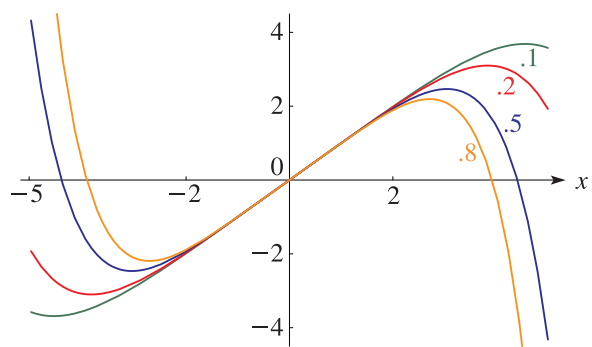


Figure 23.4.5:  $\sigma(x; g_2, 0)$  for  $-5 \leq x \leq 5$ ,  $g_2 = 0.1, 0.2, 0.5, 0.8$ . (Lemniscatic case.)

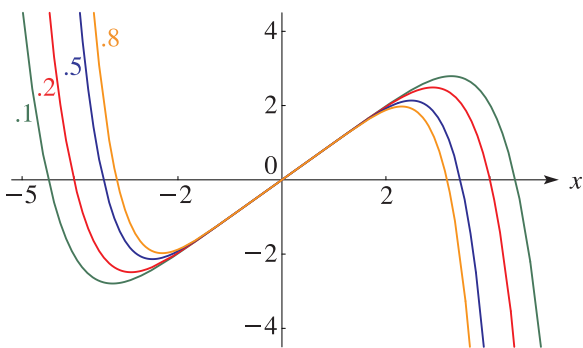


Figure 23.4.6:  $\sigma(x; 0, g_3)$  for  $-5 \leq x \leq 5$ ,  $g_3 = 0.1, 0.2, 0.5, 0.8$ . (Equianharmonic case.)

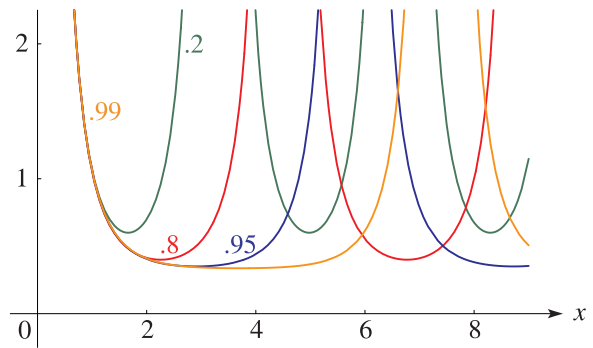


Figure 23.4.7:  $\wp(x)$  with  $\omega_1 = K(k)$ ,  $\omega_3 = iK'(k)$  for  $0 \leq x \leq 9$ ,  $k^2 = 0.2, 0.8, 0.95, 0.99$ . (Lemniscatic case.)

### 23.4(ii) Complex Variables

See Figures 23.4.8–23.4.12 for surfaces for the Weierstrass functions  $\wp(z)$ ,  $\zeta(z)$ , and  $\sigma(z)$ . Height corresponds to the absolute value of the function and color to the phase. See also p. xiv. (The figures in this subsection may be compared with the figures in §22.3(iii).)

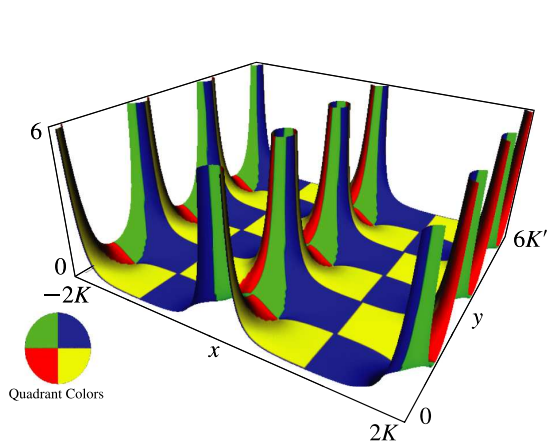


Figure 23.4.8:  $\wp(x + iy)$  with  $\omega_1 = K(k)$ ,  $\omega_3 = iK'(k)$  for  $-2K(k) \leq x \leq 2K(k)$ ,  $0 \leq y \leq 6K'(k)$ ,  $k^2 = 0.9$ . (The scaling makes the lattice appear to be square.)

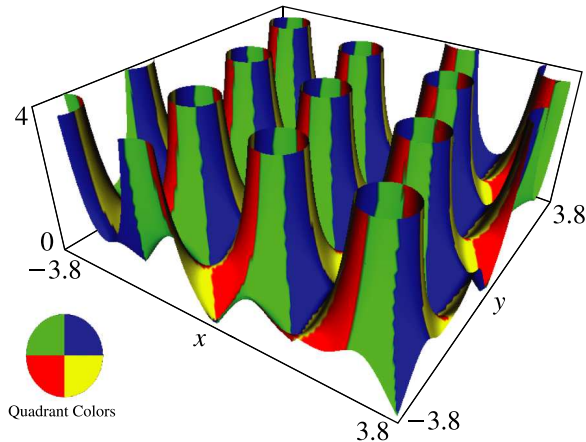


Figure 23.4.9:  $\wp(x + iy; 1, 4i)$  for  $-3.8 \leq x \leq 3.8$ ,  $-3.8 \leq y \leq 3.8$ . (The variables are unscaled and the lattice is skew.)

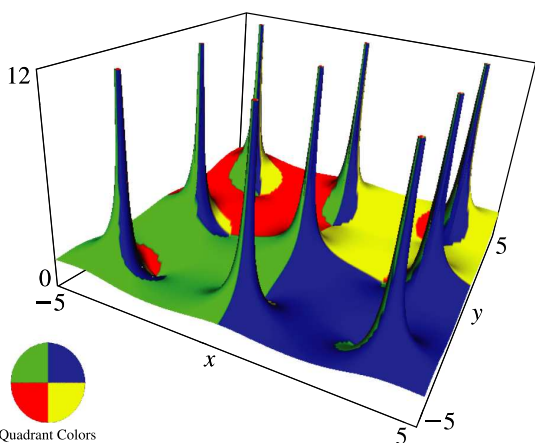


Figure 23.4.10:  $\zeta(x + iy; 1, 0)$  for  $-5 \leq x \leq 5$ ,  $-5 \leq y \leq 5$ .

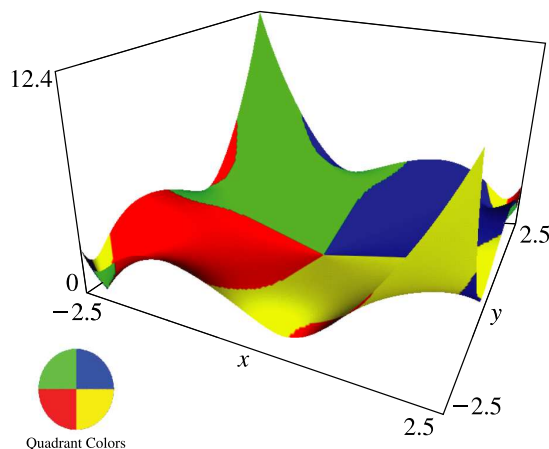


Figure 23.4.11:  $\sigma(x + iy; 1, i)$  for  $-2.5 \leq x \leq 2.5$ ,  $-2.5 \leq y \leq 2.5$ .

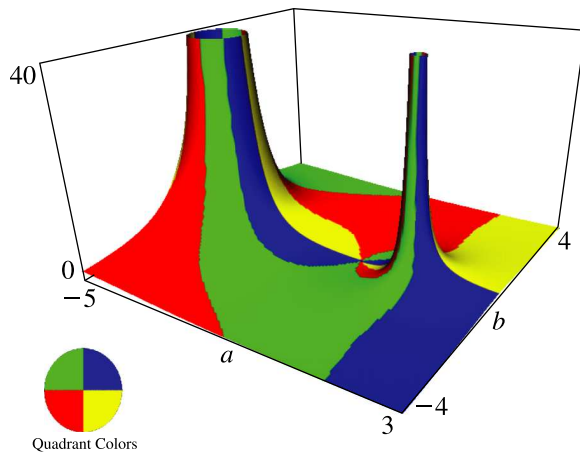


Figure 23.4.12:  $\wp(3.7; a + ib, 0)$  for  $-5 \leq a \leq 3$ ,  $-4 \leq b \leq 4$ . There is a double zero at  $a = b = 0$  and double poles on the real axis.

## 23.5 Special Lattices

### 23.5(i) Real-Valued Functions

The Weierstrass functions take real values on the real axis iff the lattice is fixed under complex conjugation:  $\mathbb{L} = \overline{\mathbb{L}}$ ; equivalently, when  $g_2, g_3 \in \mathbb{R}$ . This happens in the cases treated in the following four subsections.

### 23.5(ii) Rectangular Lattice

This occurs when both  $\omega_1$  and  $\omega_3/i$  are real and positive. Then  $\Delta > 0$  and the parallelogram with vertices at  $0, 2\omega_1, 2\omega_1 + 2\omega_3, 2\omega_3$  is a rectangle.

In this case the lattice roots  $e_1, e_2$ , and  $e_3$  are real and distinct. When they are identified as in (23.3.9)

$$23.5.1 \quad e_1 > e_2 > e_3, \quad e_1 > 0 > e_3.$$

Also,  $e_2$  and  $g_3$  have opposite signs unless  $\omega_3 = i\omega_1$ , in which event both are zero.

As functions of  $\Im\omega_3$ ,  $e_1$  and  $e_2$  are decreasing and  $e_3$  is increasing.

### 23.5(iii) Lemniscatic Lattice

This occurs when  $\omega_1$  is real and positive and  $\omega_3 = i\omega_1$ . The parallelogram  $0, 2\omega_1, 2\omega_1 + 2\omega_3, 2\omega_3$  is a square, and

$$23.5.2 \quad \eta_1 = i\eta_3 = \pi/(4\omega_1),$$

$$23.5.3 \quad e_1 = -e_3 = (\Gamma(\frac{1}{4}))^4 / (32\pi\omega_1^2), \quad e_2 = 0,$$

$$23.5.4 \quad g_2 = (\Gamma(\frac{1}{4}))^8 / (256\pi^2\omega_1^4), \quad g_3 = 0.$$

Note also that in this case  $\tau = i$ . In consequence,

$$23.5.5 \quad k^2 = \frac{1}{2}, \quad K(k) = K'(k) = (\Gamma(\frac{1}{4}))^2 / (4\sqrt{\pi}).$$

### 23.5(iv) Rhombic Lattice

This occurs when  $\omega_1$  is real and positive,  $\Im\omega_3 > 0$ ,  $\Re\omega_3 = \frac{1}{2}\omega_1$ , and  $\Delta < 0$ . The parallelogram  $0, 2\omega_1 - 2\omega_3, 2\omega_1, 2\omega_3$ , is a rhombus: see Figure 23.5.1.

The lattice root  $e_1$  is real, and  $e_3 = \bar{e}_2$ , with  $\Im e_2 > 0$ .  $e_1$  and  $g_3$  have the same sign unless  $2\omega_3 = (1 + i)\omega_1$  when both are zero: the *pseudo-lemniscatic* case. As a function of  $\Im e_3$  the root  $e_1$  is increasing. For the case  $\omega_3 = e^{\pi i/3}\omega_1$  see §23.5(v).

### 23.5(v) Equianharmonic Lattice

This occurs when  $\omega_1$  is real and positive and  $\omega_3 = e^{\pi i/3}\omega_1$ . The rhombus  $0, 2\omega_1 - 2\omega_3, 2\omega_1, 2\omega_3$  can be regarded as the union of two equilateral triangles: see Figure 23.5.2.

$$23.5.6 \quad \eta_1 = e^{\pi i/3}\eta_3 = \frac{\pi}{2\sqrt{3}\omega_1},$$

and the lattice roots and invariants are given by

$$23.5.7 \quad e_1 = e^{2\pi i/3}e_3 = e^{-2\pi i/3}e_2 = \frac{(\Gamma(\frac{1}{3}))^6}{2^{14/3}\pi^2\omega_1^2},$$

$$23.5.8 \quad g_2 = 0, \quad g_3 = \frac{(\Gamma(\frac{1}{3}))^{18}}{(4\pi\omega_1)^6}.$$

Note also that in this case  $\tau = e^{i\pi/3}$ . In consequence,

$$23.5.9 \quad k^2 = e^{i\pi/3}, \quad K(k) = e^{i\pi/6} K'(k) = e^{i\pi/12} \frac{3^{1/4} (\Gamma(\frac{1}{3}))^3}{27^{1/3}\pi}.$$

## 23.6 Relations to Other Functions

### 23.6(i) Theta Functions

In this subsection  $2\omega_1, 2\omega_3$  are any pair of generators of the lattice  $\mathbb{L}$ , and the lattice roots  $e_1, e_2, e_3$  are given by (23.3.9).

$$23.6.1 \quad q = e^{i\pi\tau}, \quad \tau = \omega_3/\omega_1.$$

$$23.6.2 \quad e_1 = \frac{\pi^2}{12\omega_1^2} (\theta_2^4(0, q) + 2\theta_4^4(0, q)),$$

$$23.6.3 \quad e_2 = \frac{\pi^2}{12\omega_1^2} (\theta_2^4(0, q) - \theta_4^4(0, q)),$$

$$23.6.4 \quad e_3 = -\frac{\pi^2}{12\omega_1^2} (2\theta_2^4(0, q) + \theta_4^4(0, q)).$$

23.6.5

$$\wp(z) - e_1 = \left( \frac{\pi \theta_3(0, q) \theta_4(0, q) \theta_2(\pi z/(2\omega_1), q)}{2\omega_1 \theta_1(\pi z/(2\omega_1), q)} \right)^2,$$

23.6.6

$$\wp(z) - e_2 = \left( \frac{\pi \theta_2(0, q) \theta_4(0, q) \theta_3(\pi z/(2\omega_1), q)}{2\omega_1 \theta_1(\pi z/(2\omega_1), q)} \right)^2,$$

23.6.7

$$\wp(z) - e_3 = \left( \frac{\pi \theta_2(0, q) \theta_3(0, q) \theta_4(\pi z/(2\omega_1), q)}{2\omega_1 \theta_1(\pi z/(2\omega_1), q)} \right)^2.$$

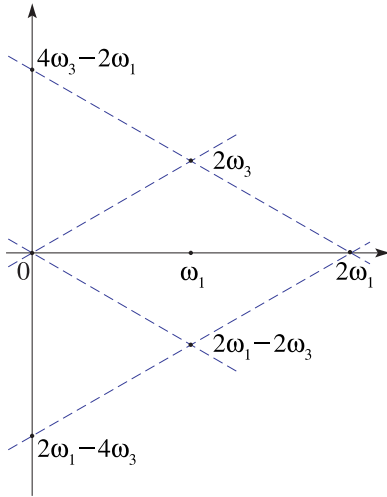


Figure 23.5.1: Rhombic lattice.  $\Re(2\omega_3) = \omega_1$ .

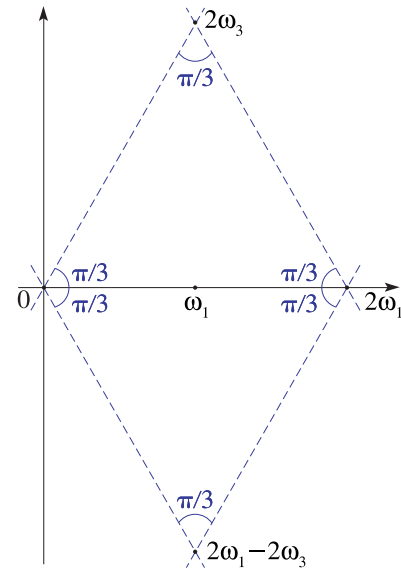


Figure 23.5.2: Equianharmonic lattice.  $2\omega_3 = e^{\pi i/3}2\omega_1$ ,  $2\omega_1 - 2\omega_3 = e^{-\pi i/3}2\omega_1$ .

23.6.8 
$$\eta_1 = -\frac{\pi^2}{12\omega_1} \frac{\theta_1'''(0, q)}{\theta_1'(0, q)}.$$

23.6.9 
$$\sigma(z) = 2\omega_1 \exp\left(\frac{\eta_1 z^2}{2\omega_1}\right) \frac{\theta_1(\pi z/(2\omega_1), q)}{\pi \theta_1'(0, q)},$$

23.6.10 
$$\sigma(\omega_1) = 2\omega_1 \frac{\exp(\frac{1}{2}\eta_1\omega_1) \theta_2(0, q)}{\pi \theta_1'(0, q)},$$

23.6.11 
$$\sigma(\omega_2) = 2\omega_1 i \frac{\exp(\frac{1}{2}\eta_1\omega_1\tau^2) \theta_3(0, q)}{\pi q^{1/4} \theta_1'(0, q)},$$

23.6.12 
$$\sigma(\omega_3) = -2\omega_1 \frac{\exp(\frac{1}{2}\eta_1\omega_1) \theta_4(0, q)}{\pi q^{1/4} \theta_1'(0, q)}.$$

With  $z = \pi u/(2\omega_1)$ ,

23.6.13 
$$\zeta(u) = \frac{\eta_1}{\omega_1} u + \frac{\pi}{2\omega_1} \frac{d}{dz} \ln \theta_1(z, q),$$

23.6.14 
$$\wp(u) = \left(\frac{\pi}{2\omega_1}\right)^2 \left(\frac{\theta_1'''(0, q)}{3\theta_1'(0, q)} - \frac{d^2}{dz^2} \ln \theta_1(z, q)\right),$$

23.6.15 
$$\frac{\sigma(u + \omega_j)}{\sigma(\omega_j)} = \exp\left(\eta_j u + \frac{\eta_j u^2}{2\omega_1}\right) \frac{\theta_{j+1}(z, q)}{\theta_{j+1}(0, q)}, \quad j = 1, 2, 3.$$

For further results for the  $\sigma$ -function see Lawden (1989, §6.2).

**23.6(ii) Jacobian Elliptic Functions**

Again, in Equations (23.6.16)–(23.6.26),  $2\omega_1, 2\omega_3$  are any pair of generators of the lattice  $\mathbb{L}$  and  $e_1, e_2, e_3$  are given by (23.3.9).

23.6.16 
$$k^2 = \frac{e_2 - e_3}{e_1 - e_3}, \quad k'^2 = \frac{e_1 - e_2}{e_1 - e_3},$$

23.6.17 
$$K^2 = (K(k))^2 = \omega_1^2(e_1 - e_3),$$
  

$$K'^2 = (K(k'))^2 = \omega_3^2(e_3 - e_1).$$

23.6.18 
$$e_1 = \frac{K^2}{3\omega_1^2}(1 + k'^2),$$

23.6.19 
$$e_2 = \frac{K^2}{3\omega_1^2}(k^2 - k'^2),$$

23.6.20 
$$e_3 = -\frac{K^2}{3\omega_1^2}(1 + k^2).$$

23.6.21 
$$\wp(z) - e_1 = \frac{K^2}{\omega_1^2} \operatorname{cs}^2\left(\frac{Kz}{\omega_1}, k\right),$$

23.6.22 
$$\wp(z) - e_2 = \frac{K^2}{\omega_1^2} \operatorname{ds}^2\left(\frac{Kz}{\omega_1}, k\right),$$

23.6.23 
$$\wp(z) - e_3 = \frac{K^2}{\omega_1^2} \operatorname{ns}^2\left(\frac{Kz}{\omega_1}, k\right).$$

23.6.24 
$$\wp(z + \omega_1) - e_1 = \left(\frac{Kk'}{\omega_1}\right)^2 \operatorname{sc}^2\left(\frac{Kz}{\omega_1}, k\right),$$

23.6.25 
$$\wp(z + \omega_2) - e_2 = -\left(\frac{Kkk'}{\omega_1}\right)^2 \operatorname{sd}^2\left(\frac{Kz}{\omega_1}, k\right),$$

23.6.26 
$$\wp(z + \omega_3) - e_3 = \left(\frac{Kk}{\omega_1}\right)^2 \operatorname{sn}^2\left(\frac{Kz}{\omega_1}, k\right).$$

In (23.6.27)–(23.6.29) the modulus  $k$  is given and  $K = K(k)$ ,  $K' = K(k')$  are the corresponding complete elliptic integrals (§19.2(ii)). Also,  $\mathbb{L}_1, \mathbb{L}_2, \mathbb{L}_3$  are the lattices with generators  $(4K, 2iK')$ ,  $(2K - 2iK', 2K + 2iK')$ ,  $(2K, 4iK')$ , respectively.

23.6.27 
$$\zeta(z|\mathbb{L}_1) - \zeta(z + 2K|\mathbb{L}_1) + \zeta(2K|\mathbb{L}_1) = \operatorname{ns}(z, k),$$



**23.6.28**  $\zeta(z|\mathbb{L}_2) - \zeta(z + 2K|\mathbb{L}_2) + \zeta(2K|\mathbb{L}_2) = \text{ds}(z, k),$

**23.6.29**  $\zeta(z|\mathbb{L}_3) - \zeta(z + 2iK'|\mathbb{L}_3) - \zeta(2iK'|\mathbb{L}_3) = \text{cs}(z, k).$

Similar results for some of the other nine Jacobi functions can be constructed with the aid of the transformations given by Table 22.4.3, or for all nine by referring to the augmented version of Table 22.4.3 at <http://dlmf.nist.gov/22.4.t3>.

For representations of the Jacobi functions sn, cn, and dn as quotients of  $\sigma$ -functions see Lawden (1989, §§6.2, 6.3).

**23.6(iii) General Elliptic Functions**

For representations of general elliptic functions (§23.2(iii)) in terms of  $\sigma(z)$  and  $\wp(z)$  see Lawden (1989, §§8.9, 8.10), and for expansions in terms of  $\zeta(z)$  see Lawden (1989, §8.11).

**23.6(iv) Elliptic Integrals**

**Rectangular Lattice**

Let  $z$  be on the perimeter of the rectangle with vertices  $0, 2\omega_1, 2\omega_1 + 2\omega_3, 2\omega_3$ . Then  $t = \wp(z)$  is real (§§23.5(i)–23.5(ii)), and

**23.6.30** 
$$z = \frac{1}{2} \int_t^\infty \frac{du}{\sqrt{(u - e_1)(u - e_2)(u - e_3)}},$$

$$t \geq e_1, z \in (0, \omega_1],$$

**23.6.31** 
$$z - \omega_1 = \frac{i}{2} \int_t^{e_1} \frac{du}{\sqrt{(e_1 - u)(u - e_2)(u - e_3)}},$$

$$e_2 \leq t \leq e_1, z \in [\omega_1, \omega_1 + \omega_3],$$

**23.6.32** 
$$z - \omega_3 = \frac{1}{2} \int_{e_3}^t \frac{du}{\sqrt{(e_1 - u)(e_2 - u)(u - e_3)}},$$

$$e_3 \leq t \leq e_2, z \in [\omega_3, \omega_1 + \omega_3],$$

**23.6.33** 
$$z = \frac{i}{2} \int_{-\infty}^t \frac{du}{\sqrt{(e_1 - u)(e_2 - u)(e_3 - u)}},$$

$$t \leq e_3, z \in (0, \omega_3].$$

**23.6.34** 
$$2\omega_1 = \int_{e_1}^\infty \frac{du}{\sqrt{(u - e_1)(u - e_2)(u - e_3)}} = \int_{e_3}^{e_2} \frac{du}{\sqrt{(e_1 - u)(e_2 - u)(u - e_3)}},$$

**23.6.35** 
$$2\omega_3 = i \int_{e_2}^{e_1} \frac{du}{\sqrt{(e_1 - u)(u - e_2)(u - e_3)}} = i \int_{-\infty}^{e_3} \frac{du}{\sqrt{(e_1 - u)(e_2 - u)(e_3 - u)}}.$$

For (23.6.30)–(23.6.35) and further identities see Lawden (1989, §6.12).

See also §§19.2(i), 19.14, and Erdélyi *et al.* (1953b, §13.14).

For relations to symmetric elliptic integrals see §19.25(vi).

**General Lattice**

Let  $z$  be a point of  $\mathbb{C}$  different from  $e_1, e_2, e_3$ , and define  $w$  by

**23.6.36** 
$$w = \int_z^\infty \frac{du}{\sqrt{4u^3 - g_2u - g_3}} = \frac{1}{2} \int_z^\infty \frac{du}{\sqrt{(u - e_1)(u - e_2)(u - e_3)}},$$

where the integral is taken along any path from  $z$  to  $\infty$  that does not pass through any of  $e_1, e_2, e_3$ . Then  $z = \wp(w)$ , where the value of  $w$  depends on the choice of path and determination of the square root; see McKean and Moll (1999, pp. 87–88 and §2.5).

**23.7 Quarter Periods**

**23.7.1** 
$$\wp\left(\frac{1}{2}\omega_1\right) = e_1 + \sqrt{(e_1 - e_3)(e_1 - e_2)} = e_1 + \omega_1^{-2}(K(k))^2k',$$

**23.7.2** 
$$\wp\left(\frac{1}{2}\omega_2\right) = e_2 - i\sqrt{(e_1 - e_2)(e_2 - e_3)} = e_2 - i\omega_1^{-2}(K(k))^2kk',$$

**23.7.3** 
$$\wp\left(\frac{1}{2}\omega_3\right) = e_3 - \sqrt{(e_1 - e_3)(e_2 - e_3)} = e_3 - \omega_1^{-2}(K(k))^2k,$$

where  $k, k'$  and the square roots are real and positive when the lattice is rectangular; otherwise they are determined by continuity from the rectangular case.

**23.8 Trigonometric Series and Products**

**23.8(i) Fourier Series**

If  $q = e^{i\pi\omega_3/\omega_1}$ ,  $\Im(z/\omega_1) < 2\Im(\omega_3/\omega_1)$ , and  $z \notin \mathbb{L}$ , then

**23.8.1** 
$$\wp(z) + \frac{\eta_1}{\omega_1} - \frac{\pi^2}{4\omega_1^2} \csc^2\left(\frac{\pi z}{2\omega_1}\right) = -\frac{2\pi^2}{\omega_1^2} \sum_{n=1}^\infty \frac{nq^{2n}}{1 - q^{2n}} \cos\left(\frac{n\pi z}{\omega_1}\right),$$

**23.8.2** 
$$\zeta(z) - \frac{\eta_1 z}{\omega_1} - \frac{\pi}{2\omega_1} \cot\left(\frac{\pi z}{2\omega_1}\right) = \frac{2\pi}{\omega_1} \sum_{n=1}^\infty \frac{q^{2n}}{1 - q^{2n}} \sin\left(\frac{n\pi z}{\omega_1}\right).$$

**23.8(ii) Series of Cosecants and Cotangents**

When  $z \notin \mathbb{L}$ ,

$$23.8.3 \quad \wp(z) = -\frac{\eta_1}{\omega_1} + \frac{\pi^2}{4\omega_1^2} \sum_{n=-\infty}^{\infty} \operatorname{csc}^2\left(\frac{\pi(z + 2n\omega_3)}{2\omega_1}\right),$$

$$23.8.4 \quad \zeta(z) = \frac{\eta_1 z}{\omega_1} + \frac{\pi}{2\omega_1} \sum_{n=-\infty}^{\infty} \cot\left(\frac{\pi(z + 2n\omega_3)}{2\omega_1}\right),$$

where in (23.8.4) the terms in  $n$  and  $-n$  are to be bracketed together (the *Eisenstein convention* or *principal value*: see Weil (1999, p. 6) or Walker (1996, p. 3)).

$$23.8.5 \quad \eta_1 = \frac{\pi^2}{2\omega_1} \left( \frac{1}{6} + \sum_{n=1}^{\infty} \operatorname{csc}^2\left(\frac{n\pi\omega_3}{\omega_1}\right) \right),$$

with similar results for  $\eta_2$  and  $\eta_3$  obtainable by use of (23.2.14).

**23.8(iii) Infinite Products**

$$23.8.6 \quad \sigma(z) = \frac{2\omega_1}{\pi} \exp\left(\frac{\eta_1 z^2}{2\omega_1}\right) \sin\left(\frac{\pi z}{2\omega_1}\right) \prod_{n=1}^{\infty} \frac{1 - 2q^{2n} \cos(\pi z/\omega_1) + q^{4n}}{(1 - q^{2n})^2},$$

$$23.8.7 \quad \sigma(z) = \frac{2\omega_1}{\pi} \exp\left(\frac{\eta_1 z^2}{2\omega_1}\right) \sin\left(\frac{\pi z}{2\omega_1}\right) \prod_{n=1}^{\infty} \frac{\sin(\pi(2n\omega_3 + z)/(2\omega_1)) \sin(\pi(2n\omega_3 - z)/(2\omega_1))}{\sin^2(\pi n\omega_3/\omega_1)}.$$

**23.9 Laurent and Other Power Series**

Let  $z_0 (\neq 0)$  be the nearest lattice point to the origin, and define

$$23.9.1 \quad c_n = (2n - 1) \sum_{w \in \mathbb{L} \setminus \{0\}} w^{-2n}, \quad n = 2, 3, 4, \dots$$

Then

$$23.9.2 \quad \wp(z) = \frac{1}{z^2} + \sum_{n=2}^{\infty} c_n z^{2n-2}, \quad 0 < |z| < |z_0|,$$

$$23.9.3 \quad \zeta(z) = \frac{1}{z} - \sum_{n=2}^{\infty} \frac{c_n}{2n-1} z^{2n-1}, \quad 0 < |z| < |z_0|.$$

Here

$$23.9.4 \quad c_2 = \frac{1}{20}g_2, \quad c_3 = \frac{1}{28}g_3,$$

$$23.9.5 \quad c_n = \frac{3}{(2n+1)(n-3)} \sum_{m=2}^{n-2} c_m c_{n-m}, \quad n \geq 4.$$

Explicit coefficients  $c_n$  in terms of  $c_2$  and  $c_3$  are given up to  $c_{19}$  in Abramowitz and Stegun (1964, p. 636).

For  $j = 1, 2, 3$ , and with  $e_j$  as in §23.3(i),

$$23.9.6 \quad \wp(\omega_j + t) = e_j + (3e_j^2 - 5c_2)t^2 + (10c_2e_j + 21c_3)t^4 + (7c_2e_j^2 + 21c_3e_j + 5c_2^2)t^6 + O(t^8),$$

as  $t \rightarrow 0$ . For the next four terms see Abramowitz and Stegun (1964, (18.5.56)). Also, Abramowitz and Stegun (1964, (18.5.25)) supplies the first 22 terms in the reverted form of (23.9.2) as  $1/\wp(z) \rightarrow 0$ .

For  $z \in \mathbb{C}$

$$23.9.7 \quad \sigma(z) = \sum_{m,n=0}^{\infty} a_{m,n} (10c_2)^m (56c_3)^n \frac{z^{4m+6n+1}}{(4m+6n+1)!},$$

where  $a_{0,0} = 1$ ,  $a_{m,n} = 0$  if either  $m$  or  $n < 0$ , and

$$23.9.8 \quad a_{m,n} = 3(m+1)a_{m+1,n-1} + \frac{16}{3}(n+1)a_{m-2,n+1} - \frac{1}{3}(2m+3n-1)(4m+6n-1)a_{m-1,n}.$$

For  $a_{m,n}$  with  $m = 0, 1, \dots, 12$  and  $n = 0, 1, \dots, 8$ , see Abramowitz and Stegun (1964, p. 637).

**23.10 Addition Theorems and Other Identities**

**23.10(i) Addition Theorems**

$$23.10.1 \quad \wp(u+v) = \frac{1}{4} \left( \frac{\wp'(u) - \wp'(v)}{\wp(u) - \wp(v)} \right)^2 - \wp(u) - \wp(v),$$

$$23.10.2 \quad \zeta(u+v) = \zeta(u) + \zeta(v) + \frac{1}{2} \frac{\zeta''(u) - \zeta''(v)}{\zeta'(u) - \zeta'(v)},$$

$$23.10.3 \quad \frac{\sigma(u+v)\sigma(u-v)}{\sigma^2(u)\sigma^2(v)} = \wp(v) - \wp(u),$$

$$23.10.4 \quad \begin{aligned} &\sigma(u+v)\sigma(u-v)\sigma(x+y)\sigma(x-y) \\ &+ \sigma(v+x)\sigma(v-x)\sigma(u+y)\sigma(u-y) \\ &+ \sigma(x+u)\sigma(x-u)\sigma(v+y)\sigma(v-y) = 0. \end{aligned}$$

For further addition-type identities for the  $\sigma$ -function see Lawden (1989, §6.4).

If  $u + v + w = 0$ , then

$$23.10.5 \quad \begin{vmatrix} 1 & \wp(u) & \wp'(u) \\ 1 & \wp(v) & \wp'(v) \\ 1 & \wp(w) & \wp'(w) \end{vmatrix} = 0,$$

and

$$23.10.6 \quad (\zeta(u) + \zeta(v) + \zeta(w))^2 + \zeta'(u) + \zeta'(v) + \zeta'(w) = 0.$$

**23.10(ii) Duplication Formulas**

**23.10.7**  $\wp(2z) = -2\wp(z) + \frac{1}{4} \left( \frac{\wp''(z)}{\wp'(z)} \right)^2,$

**23.10.8**  
 $(\wp(2z) - e_1)\wp'^2(z) = ((\wp(z) - e_1)^2 - (e_1 - e_2)(e_1 - e_3))^2.$   
 (23.10.8) continues to hold when  $e_1, e_2, e_3$  are permuted cyclically.

**23.10.9**  $\zeta(2z) = 2\zeta(z) + \frac{1}{2} \frac{\zeta'''(z)}{\zeta''(z)},$

**23.10.10**  $\sigma(2z) = -\wp'(z)\sigma^4(z).$

**23.10(iii)  $n$ -Tuple Formulas**

For  $n = 2, 3, \dots,$

**23.10.11**  $n^2 \wp(nz) = \sum_{j=0}^{n-1} \sum_{\ell=0}^{n-1} \wp \left( z + \frac{2j}{n} \omega_1 + \frac{2\ell}{n} \omega_3 \right),$

---

**23.10.15**  $A_n = \left( \frac{\pi^2 G^2}{\omega_1} \right)^{n^2-1} \frac{q^{n(n-1)/2}}{i^{n-1}} \exp \left( -\frac{(n-1)\eta_1}{3\omega_1} ((2n-1)(\omega_1^2 + \omega_3^2) + 3(n-1)\omega_1\omega_3) \right),$

where

**23.10.16**  $q = e^{\pi i \omega_3 / \omega_1}, \quad G = \prod_{n=1}^{\infty} (1 - q^{2n}).$

**23.10(iv) Homogeneity**

For any nonzero real or complex constant  $c$

**23.10.17**  $\wp(cz|c\mathbb{L}) = c^{-2} \wp(z|\mathbb{L}),$

**23.10.18**  $\zeta(cz|c\mathbb{L}) = c^{-1} \zeta(z|\mathbb{L}),$

**23.10.19**  $\sigma(cz|c\mathbb{L}) = c \sigma(z|\mathbb{L}).$

Also, when  $\mathbb{L}$  is replaced by  $c\mathbb{L}$  the lattice invariants  $g_2$  and  $g_3$  are divided by  $c^4$  and  $c^6$ , respectively.

For these results and further identities see Lawden (1989, §6.6) and Apostol (1990, p. 14).

**23.11 Integral Representations**

Let  $\tau = \omega_3/\omega_1$  and

**23.11.1**  $f_1(s, \tau) = \frac{\cosh^2(\frac{1}{2}\tau s)}{1 - 2e^{-s} \cosh(\tau s) + e^{-2s}},$   
 $f_2(s, \tau) = \frac{\cos^2(\frac{1}{2}s)}{1 - 2e^{i\tau s} \cos s + e^{2i\tau s}}.$

Then

**23.11.2**  $\wp(z) = \frac{1}{z^2} + 8 \int_0^{\infty} s (e^{-s} \sinh^2(\frac{1}{2}zs) f_1(s, \tau) + e^{i\tau s} \sin^2(\frac{1}{2}zs) f_2(s, \tau)) ds,$

$n \zeta(nz) = -n(n-1)(\eta_1 + \eta_3) + \sum_{j=0}^{n-1} \sum_{\ell=0}^{n-1} \zeta \left( z + \frac{2j}{n} \omega_1 + \frac{2\ell}{n} \omega_3 \right),$

**23.10.12**

**23.10.13**

$\sigma(nz) = A_n e^{-n(n-1)(\eta_1 + \eta_3)z} \prod_{j=0}^{n-1} \prod_{\substack{\ell=0 \\ \ell \neq j}}^{n-1} \sigma \left( z + \frac{2j}{n} \omega_1 + \frac{2\ell}{n} \omega_3 \right),$

where

**23.10.14**  $A_n = n \prod_{j=0}^{n-1} \prod_{\substack{\ell=0 \\ \ell \neq j}}^{n-1} \frac{1}{\sigma((2j\omega_1 + 2\ell\omega_3)/n)}.$

Equivalently,

and

**23.11.3**  $\zeta(z) = \frac{1}{z} + \int_0^{\infty} (e^{-s}(zs - \sinh(zs)) f_1(s, \tau) - e^{i\tau s}(zs - \sin(zs)) f_2(s, \tau)) ds,$   
 provided that  $-1 < \Re(z + \tau) < 1$  and  $|\Im z| < \Im \tau.$

**23.12 Asymptotic Approximations**

If  $q (= e^{\pi i \omega_3 / \omega_1}) \rightarrow 0$  with  $\omega_1$  and  $z$  fixed, then

**23.12.1**  $\wp(z) = \frac{\pi^2}{4\omega_1^2} \left( -\frac{1}{3} + \csc^2 \left( \frac{\pi z}{2\omega_1} \right) + 8 \left( 1 - \cos \left( \frac{\pi z}{\omega_1} \right) \right) q^2 + O(q^4) \right),$

**23.12.2**  $\zeta(z) = \frac{\pi^2}{4\omega_1^2} \left( \frac{z}{3} + \frac{2\omega_1}{\pi} \cot \left( \frac{\pi z}{\omega_1} \right) - 8 \left( z - \frac{\omega_1}{\pi} \sin \left( \frac{\pi z}{\omega_1} \right) \right) q^2 + O(q^4) \right),$

**23.12.3**

$\sigma(z) = \frac{2\omega_1}{\pi} \exp \left( \frac{\pi^2 z^2}{24\omega_1^2} \right) \sin \left( \frac{\pi z}{2\omega_1} \right) \times \left( 1 - \left( \frac{\pi^2 z^2}{\omega_1^2} - 4 \sin^2 \left( \frac{\pi z}{2\omega_1} \right) \right) q^2 + O(q^4) \right),$

provided that  $z \notin \mathbb{L}$  in the case of (23.12.1) and (23.12.2). Also,

**23.12.4**  $\eta_1 = \frac{\pi^2}{4\omega_1} \left( \frac{1}{3} - 8q^2 + O(q^4) \right),$

with similar results for  $\eta_2$  and  $\eta_3$  obtainable by use of (23.2.14).

### 23.13 Zeros

For information on the zeros of  $\wp(z)$  see Eichler and Zagier (1982).

### 23.14 Integrals

$$23.14.1 \quad \int \wp(z) dz = -\zeta(z),$$

$$23.14.2 \quad \int \wp^2(z) dz = \frac{1}{6} \wp'(z) + \frac{1}{12} g_2 z,$$

$$23.14.3 \quad \int \wp^3(z) dz = \frac{1}{120} \wp'''(z) - \frac{3}{20} g_2 \zeta(z) + \frac{1}{10} g_3 z.$$

For further integrals see Gröbner and Hofreiter (1949, Vol. 1, pp. 161–162), Gradshteyn and Ryzhik (2000, p. 622), and Prudnikov *et al.* (1990, pp. 51–52).

## Modular Functions

### 23.15 Definitions

#### 23.15(i) General Modular Functions

In §§23.15–23.19,  $k$  and  $k'$  ( $\in \mathbb{C}$ ) denote the Jacobi modulus and complementary modulus, respectively, and  $q = e^{i\pi\tau}$  ( $\Im\tau > 0$ ) denotes the nome; compare §§20.1 and 22.1. Thus

$$23.15.1 \quad q = \exp\left(-\pi \frac{K'(k)}{K(k)}\right),$$

$$23.15.2 \quad k = \frac{\theta_2^2(0, q)}{\theta_3^2(0, q)}, \quad k' = \frac{\theta_4^2(0, q)}{\theta_3^2(0, q)}.$$

Also  $\mathcal{A}$  denotes a bilinear transformation on  $\tau$ , given by

$$23.15.3 \quad \mathcal{A}\tau = \frac{a\tau + b}{c\tau + d},$$

in which  $a, b, c, d$  are integers, with

$$23.15.4 \quad ad - bc = 1.$$

The set of all bilinear transformations of this form is denoted by  $SL(2, \mathbb{Z})$  (Serre (1973, p. 77)).

A *modular function*  $f(\tau)$  is a function of  $\tau$  that is meromorphic in the half-plane  $\Im\tau > 0$ , and has the property that for all  $\mathcal{A} \in SL(2, \mathbb{Z})$ , or for all  $\mathcal{A}$  belonging to a subgroup of  $SL(2, \mathbb{Z})$ ,

$$23.15.5 \quad f(\mathcal{A}\tau) = c_{\mathcal{A}}(c\tau + d)^{\ell} f(\tau), \quad \Im\tau > 0,$$

where  $c_{\mathcal{A}}$  is a constant depending only on  $\mathcal{A}$ , and  $\ell$  (the *level*) is an integer or half an odd integer. (Some references refer to  $2\ell$  as the level). If, as a function of  $q$ ,  $f(\tau)$  is analytic at  $q = 0$ , then  $f(\tau)$  is called a *modular form*. If, in addition,  $f(\tau) \rightarrow 0$  as  $q \rightarrow 0$ , then  $f(\tau)$  is called a *cuspidal form*.

#### 23.15(ii) Functions $\lambda(\tau)$ , $J(\tau)$ , $\eta(\tau)$

##### Elliptic Modular Function

$$23.15.6 \quad \lambda(\tau) = \frac{\theta_2^4(0, q)}{\theta_3^4(0, q)},$$

compare also (23.15.2).

##### Klein's Complete Invariant

$$23.15.7 \quad J(\tau) = \frac{(\theta_2^8(0, q) + \theta_3^8(0, q) + \theta_4^8(0, q))^3}{54(\theta_1'(0, q))^8},$$

where (as in §20.2(i))

$$23.15.8 \quad \theta_1'(0, q) = \partial\theta_1(z, q)/\partial z|_{z=0}.$$

##### Dedekind's Eta Function (or Dedekind Modular Function)

##### 23.15.9

$$\eta(\tau) = \left(\frac{1}{2} \theta_1'(0, q)\right)^{1/3} = e^{i\pi\tau/12} \theta_3\left(\frac{1}{2}\pi(1+\tau)|3\tau\right).$$

In (23.15.9) the branch of the cube root is chosen to agree with the second equality; in particular, when  $\tau$  lies on the positive imaginary axis the cube root is real and positive.

### 23.16 Graphics

See Figures 23.16.1–23.16.3 for the modular functions  $\lambda$ ,  $J$ , and  $\eta$ . In Figures 23.16.2 and 23.16.3, height corresponds to the absolute value of the function and color to the phase. See also p. xiv.

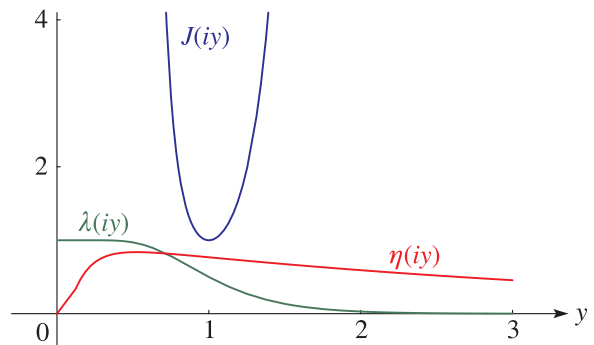


Figure 23.16.1: Modular functions  $\lambda(iy)$ ,  $J(iy)$ ,  $\eta(iy)$  for  $0 \leq y \leq 3$ . See also Figure 20.3.2.

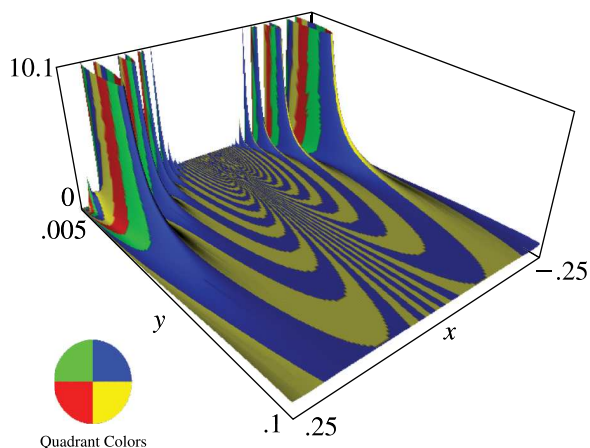


Figure 23.16.2: Elliptic modular function  $\lambda(x + iy)$  for  $-0.25 \leq x \leq 0.25$ ,  $0.005 \leq y \leq 0.1$ .

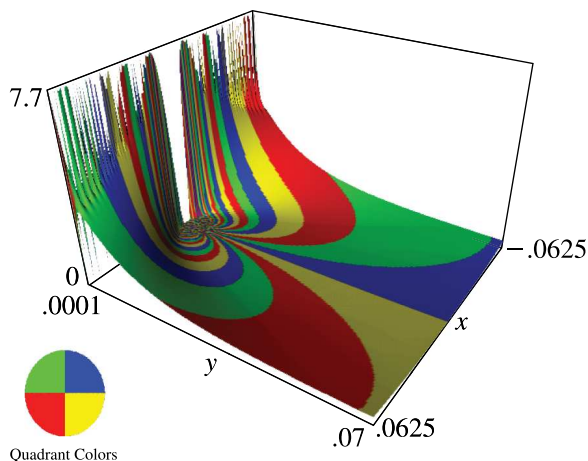


Figure 23.16.3: Dedekind's eta function  $\eta(x + iy)$  for  $-0.0625 \leq x \leq 0.0625$ ,  $0.0001 \leq y \leq 0.07$ .

### 23.17 Elementary Properties

#### 23.17(i) Special Values

23.17.1  $\lambda(i) = \frac{1}{2}, \quad \lambda(e^{\pi i/3}) = e^{\pi i/3},$

23.17.2  $J(i) = 1, \quad J(e^{\pi i/3}) = 0,$

23.17.3

$$\eta(i) = \frac{\Gamma(\frac{1}{4})}{2\pi^{3/4}}, \quad \eta(e^{\pi i/3}) = \frac{3^{1/8} (\Gamma(\frac{1}{3}))^{3/2}}{2\pi} e^{\pi i/24}.$$

For further results for  $J(\tau)$  see Cohen (1993, p. 376).

#### 23.17(ii) Power and Laurent Series

When  $|q| < 1$

23.17.4  $\lambda(\tau) = 16q(1 - 8q + 44q^2 + \dots),$

23.17.5

$$1728J(\tau) = q^{-2} + 744 + 1\,96884q^2 + 214\,93760q^4 + \dots,$$

23.17.6 
$$\eta(\tau) = \sum_{n=-\infty}^{\infty} (-1)^n q^{(6n+1)^2/12}.$$

In (23.17.5) for terms up to  $q^{48}$  see Zuckerman (1939), and for terms up to  $q^{100}$  see van Wijngaarden (1953). See also Apostol (1990, p. 22).

#### 23.17(iii) Infinite Products

23.17.7 
$$\lambda(\tau) = 16q \prod_{n=1}^{\infty} \left( \frac{1 + q^{2n}}{1 + q^{2n-1}} \right)^8,$$

23.17.8 
$$\eta(\tau) = q^{1/12} \prod_{n=1}^{\infty} (1 - q^{2n}),$$

with  $q^{1/12} = e^{i\pi\tau/12}$ .

### 23.18 Modular Transformations

#### Elliptic Modular Function

$\lambda(\mathcal{A}\tau)$  equals

23.18.1 
$$\lambda(\tau), \quad 1 - \lambda(\tau), \quad \frac{1}{\lambda(\tau)},$$

$$\frac{1}{1 - \lambda(\tau)}, \quad \frac{\lambda(\tau)}{\lambda(\tau) - 1}, \quad 1 - \frac{1}{\lambda(\tau)},$$

according as the elements  $\begin{bmatrix} a & b \\ c & d \end{bmatrix}$  of  $\mathcal{A}$  in (23.15.3) have the respective forms

23.18.2 
$$\begin{bmatrix} o & e \\ e & o \end{bmatrix}, \quad \begin{bmatrix} e & o \\ o & e \end{bmatrix}, \quad \begin{bmatrix} o & e \\ o & o \end{bmatrix},$$

$$\begin{bmatrix} e & o \\ o & o \end{bmatrix}, \quad \begin{bmatrix} o & o \\ e & o \end{bmatrix}, \quad \begin{bmatrix} o & o \\ o & e \end{bmatrix}.$$

Here e and o are generic symbols for even and odd integers, respectively. In particular, if  $a - 1, b, c,$  and  $d - 1$  are all even, then

23.18.3 
$$\lambda(\mathcal{A}\tau) = \lambda(\tau),$$

and  $\lambda(\tau)$  is a cusp form of level zero for the corresponding subgroup of  $SL(2, \mathbb{Z})$ .

#### Klein's Complete Invariant

23.18.4 
$$J(\mathcal{A}\tau) = J(\tau).$$

$J(\tau)$  is a modular form of level zero for  $SL(2, \mathbb{Z})$ .

**Dedekind's Eta Function**

23.18.5  $\eta(\mathcal{A}\tau) = \varepsilon(\mathcal{A}) (-i(c\tau + d))^{1/2} \eta(\tau),$

where the square root has its principal value and

23.18.6  $\varepsilon(\mathcal{A}) = \exp\left(\pi i \left(\frac{a+d}{12c} + s(-d, c)\right)\right),$

23.18.7  $s(d, c) = \sum_{\substack{r=1 \\ (r,c)=1}}^{c-1} \frac{r}{c} \left(\frac{dr}{c} - \left\lfloor \frac{dr}{c} \right\rfloor - \frac{1}{2}\right), \quad c > 0.$

Here the notation  $(r, c) = 1$  means that the sum is confined to those values of  $r$  that are relatively prime to  $c$ . See §27.14(iii) and Apostol (1990, pp. 48 and 51–53). Note that  $\eta(\tau)$  is of level  $\frac{1}{2}$ .

**23.19 Interrelations**

23.19.1  $\lambda(\tau) = 16 \left(\frac{\eta^2(2\tau)\eta(\frac{1}{2}\tau)}{\eta^3(\tau)}\right)^8,$

23.19.2  $J(\tau) = \frac{4}{27} \frac{(1 - \lambda(\tau) + \lambda^2(\tau))^3}{(\lambda(\tau)(1 - \lambda(\tau)))^2},$

23.19.3  $J(\tau) = \frac{g_2^3}{g_3^3 - 27g_3^2},$

where  $g_2, g_3$  are the invariants of the lattice  $\mathbb{L}$  with generators 1 and  $\tau$ ; see §23.3(i).

Also, with  $\Delta$  defined as in (23.3.4),

23.19.4  $\Delta = (2\pi)^{12} \eta^{24}(\tau).$

**Applications**

**23.20 Mathematical Applications**

**23.20(i) Conformal Mappings**

**Rectangular Lattice**

The boundary of the rectangle  $R$ , with vertices  $0, \omega_1, \omega_1 + \omega_3, \omega_3$ , is mapped strictly monotonically by  $\wp$  onto the real line with  $0 \rightarrow \infty, \omega_1 \rightarrow e_1, \omega_1 + \omega_3 \rightarrow e_2, \omega_3 \rightarrow e_3, 0 \rightarrow -\infty$ . There is a unique point  $z_0 \in [\omega_1, \omega_1 + \omega_3] \cup [\omega_1 + \omega_3, \omega_3]$  such that  $\wp(z_0) = 0$ . The interior of  $R$  is mapped one-to-one onto the lower half-plane.

**Rhombic Lattice**

The two pairs of edges  $[0, \omega_1] \cup [\omega_1, 2\omega_3]$  and  $[2\omega_3, 2\omega_3 - \omega_1] \cup [2\omega_3 - \omega_1, 0]$  of  $R$  are each mapped strictly monotonically by  $\wp$  onto the real line, with  $0 \rightarrow \infty, \omega_1 \rightarrow e_1, 2\omega_3 \rightarrow -\infty$ ; similarly for the other pair of edges. For each pair of edges there is a unique point  $z_0$  such that  $\wp(z_0) = 0$ .

The interior of the rectangle with vertices  $0, \omega_1, 2\omega_3, 2\omega_3 - \omega_1$  is mapped two-to-one onto the lower half-plane. The interior of the rectangle with vertices  $0, \omega_1, \frac{1}{2}\omega_1 + \omega_3, \frac{1}{2}\omega_1 - \omega_3$  is mapped one-to-one onto the lower half-plane with a cut from  $e_3$  to  $\wp(\frac{1}{2}\omega_1 + \omega_3)$  ( $= \wp(\frac{1}{2}\omega_1 - \omega_3)$ ). The cut is the image of the edge from  $\frac{1}{2}\omega_1 + \omega_3$  to  $\frac{1}{2}\omega_1 - \omega_3$  and is not a line segment.

For examples of conformal mappings of the function  $\wp(z)$ , see Abramowitz and Stegun (1964, pp. 642–648, 654–655, and 659–60).

For conformal mappings via modular functions see Apostol (1990, §2.7).

**23.20(ii) Elliptic Curves**

An algebraic curve that can be put either into the form

23.20.1  $C : y^2 = x^3 + ax + b,$

or equivalently, on replacing  $x$  by  $x/z$  and  $y$  by  $y/z$  (projective coordinates), into the form

23.20.2  $C : y^2z = x^3 + axz^2 + bz^3,$

is an example of an *elliptic curve* (§22.18(iv)). Here  $a$  and  $b$  are real or complex constants.

Points  $P = (x, y)$  on the curve can be parametrized by  $x = \wp(z; g_2, g_3), 2y = \wp'(z; g_2, g_3)$ , where  $g_2 = -4a$  and  $g_3 = -4b$ : in this case we write  $P = P(z)$ . The curve  $C$  is made into an abelian group (Macdonald (1968, Chapter 5)) by defining the zero element  $o = (0, 1, 0)$  as the point at infinity, the negative of  $P = (x, y)$  by  $-P = (x, -y)$ , and generally  $P_1 + P_2 + P_3 = 0$  on the curve iff the points  $P_1, P_2, P_3$  are collinear. It follows from the addition formula (23.10.1) that the points  $P_j = P(z_j), j = 1, 2, 3$ , have zero sum iff  $z_1 + z_2 + z_3 \in \mathbb{L}$ , so that addition of points on the curve  $C$  corresponds to addition of parameters  $z_j$  on the torus  $\mathbb{C}/\mathbb{L}$ ; see McKean and Moll (1999, §§2.11, 2.14).

In terms of  $(x, y)$  the addition law can be expressed  $(x, y) + o = (x, y), (x, y) + (x, -y) = o$ ; otherwise  $(x_1, y_1) + (x_2, y_2) = (x_3, y_3)$ , where

23.20.3  $x_3 = m^2 - x_1 - x_2, \quad y_3 = -m(x_3 - x_1) - y_1,$

and

23.20.4  $m = \begin{cases} (3x_1^2 + a)/(2y_1), & P_1 = P_2, \\ (y_2 - y_1)/(x_2 - x_1), & P_1 \neq P_2. \end{cases}$

If  $a, b \in \mathbb{R}$ , then  $C$  intersects the plane  $\mathbb{R}^2$  in a curve that is connected if  $\Delta \equiv 4a^3 + 27b^2 > 0$ ; if  $\Delta < 0$ ,

then the intersection has two components, one of which is a closed loop. These cases correspond to rhombic and rectangular lattices, respectively. The addition law states that to find the sum of two points, take the third intersection with  $C$  of the chord joining them (or the tangent if they coincide); then its reflection in the  $x$ -axis gives the required sum. The geometric nature of this construction is illustrated in McKean and Moll (1999, §2.14), Koblitz (1993, §§6, 7), and Silverman and Tate (1992, Chapter 1, §§3, 4): each of these references makes a connection with the addition theorem (23.10.1).

If  $a, b \in \mathbb{Q}$ , then by rescaling we may assume  $a, b \in \mathbb{Z}$ . Let  $T$  denote the set of points on  $C$  that are of finite order (that is, those points  $P$  for which there exists a positive integer  $n$  with  $nP = o$ ), and let  $I, K$  be the sets of points with integer and rational coordinates, respectively. Then  $\emptyset \subseteq T \subseteq I \subseteq K \subseteq C$ . Both  $T, K$  are subgroups of  $C$ , though  $I$  may not be.  $K$  always has the form  $T \times \mathbb{Z}^r$  (Mordell's Theorem: Silverman and Tate (1992, Chapter 3, §5)); the determination of  $r$ , the rank of  $K$ , raises questions of great difficulty, many of which are still open. Both  $T$  and  $I$  are finite sets.  $T$  must have one of the forms  $\mathbb{Z}/(n\mathbb{Z})$ ,  $1 \leq n \leq 10$  or  $n = 12$ , or  $(\mathbb{Z}/(2\mathbb{Z})) \times (\mathbb{Z}/(2n\mathbb{Z}))$ ,  $1 \leq n \leq 4$ . To determine  $T$ , we make use of the fact that if  $(x, y) \in T$  then  $y^2$  must be a divisor of  $\Delta$ ; hence there are only a finite number of possibilities for  $y$ . Values of  $x$  are then found as integer solutions of  $x^3 + ax + b - y^2 = 0$  (in particular  $x$  must be a divisor of  $b - y^2$ ). The resulting points are then tested for finite order as follows. Given  $P$ , calculate  $2P, 4P, 8P$  by doubling as above. If any of these quantities is zero, then the point has finite order. If any of  $2P, 4P, 8P$  is not an integer, then the point has infinite order. Otherwise observe any equalities between  $P, 2P, 4P, 8P$ , and their negatives. The order of a point (if finite and not already determined) can have only the values 3, 5, 6, 7, 9, 10, or 12, and so can be found from  $2P = -P, 4P = -P, 4P = -2P, 8P = P, 8P = -P, 8P = -2P$ , or  $8P = -4P$ . If none of these equalities hold, then  $P$  has infinite order.

For extensive tables of elliptic curves see Cremona (1997, pp. 84–340).

### 23.20(iii) Factorization

§27.16 describes the use of primality testing and factorization in cryptography. For applications of the Weierstrass function and the elliptic curve method to these problems see Bressoud (1989) and Koblitz (1999).

### 23.20(iv) Modular and Quintic Equations

The *modular equation* of degree  $p$ ,  $p$  prime, is an algebraic equation in  $\alpha = \lambda(p\tau)$  and  $\beta = \lambda(\tau)$ . For

$p = 2, 3, 5, 7$  and with  $u = \alpha^{1/4}$ ,  $v = \beta^{1/4}$ , the modular equation is as follows:

$$23.20.5 \quad v^8(1 + u^8) = 4u^4, \quad p = 2,$$

$$23.20.6 \quad u^4 - v^4 + 2uv(1 - u^2v^2) = 0, \quad p = 3,$$

$$23.20.7 \quad u^6 - v^6 + 5u^2v^2(u^2 - v^2) + 4uv(1 - u^4v^4) = 0, \quad p = 5,$$

$$23.20.8 \quad (1 - u^8)(1 - v^8) = (1 - uv)^8, \quad p = 7.$$

For further information, including the application of (23.20.7) to the solution of the general quintic equation, see Borwein and Borwein (1987, Chapter 4).

## 23.20(v) Modular Functions and Number Theory

For applications of modular functions to number theory see §27.14(iv) and Apostol (1990). See also Silverman and Tate (1992), Serre (1973, Part 2, Chapters 6, 7), Koblitz (1993), and Cornell *et al.* (1997).

## 23.21 Physical Applications

### 23.21(i) Classical Dynamics

In §22.19(ii) it is noted that Jacobian elliptic functions provide a natural basis of solutions for problems in Newtonian classical dynamics with quartic potentials in canonical form  $(1 - x^2)(1 - k^2x^2)$ . The Weierstrass function  $\wp$  plays a similar role for cubic potentials in canonical form  $g_3 + g_2x - 4x^3$ . See, for example, Lawden (1989, Chapter 7) and Whittaker (1964, Chapters 4–6).

### 23.21(ii) Nonlinear Evolution Equations

Airault *et al.* (1977) applies the function  $\wp$  to an integrable classical many-body problem, and relates the solutions to nonlinear partial differential equations. For applications to soliton solutions of the Korteweg–de Vries (KdV) equation see McKean and Moll (1999, p. 91), Deconinck and Segur (2000), and Walker (1996, §8.1).

### 23.21(iii) Ellipsoidal Coordinates

Ellipsoidal coordinates  $(\xi, \eta, \zeta)$  may be defined as the three roots  $\rho$  of the equation

$$23.21.1 \quad \frac{x^2}{\rho - e_1} + \frac{y^2}{\rho - e_2} + \frac{z^2}{\rho - e_3} = 1,$$

where  $x, y, z$  are the corresponding Cartesian coordinates and  $e_1, e_2, e_3$  are constants. The Laplacian operator  $\nabla^2$  (§1.5(ii)) is given by

**23.21.2**

$$(\eta - \zeta)(\zeta - \xi)(\xi - \eta)\nabla^2 = (\zeta - \eta)f(\xi)f'(\xi)\frac{\partial}{\partial\xi} + (\xi - \zeta)f(\eta)f'(\eta)\frac{\partial}{\partial\eta} + (\eta - \xi)f(\zeta)f'(\zeta)\frac{\partial}{\partial\zeta},$$

where

**23.21.3**  $f(\rho) = 2((\rho - e_1)(\rho - e_2)(\rho - e_3))^{1/2}.$

Another form is obtained by identifying  $e_1, e_2, e_3$  as lattice roots (§23.3(i)), and setting

**23.21.4**  $\xi = \wp(u), \quad \eta = \wp(v), \quad \zeta = \wp(w).$

Then

**23.21.5** 
$$\begin{aligned} &(\wp(v) - \wp(w))(\wp(w) - \wp(u))(\wp(u) - \wp(v))\nabla^2 \\ &= (\wp(w) - \wp(v))\frac{\partial^2}{\partial u^2} + (\wp(u) - \wp(w))\frac{\partial^2}{\partial v^2} \\ &\quad + (\wp(v) - \wp(u))\frac{\partial^2}{\partial w^2}. \end{aligned}$$

See also §29.18(ii).

**23.21(iv) Modular Functions**

Physical applications of modular functions include:

- Quantum field theory. See Witten (1987).
- Statistical mechanics. See Baxter (1982, p. 434) and Itzykson and Drouffe (1989, §9.3).
- String theory. See Green *et al.* (1988a, §8.2) and Polchinski (1998, §7.2).

## Computation

**23.22 Methods of Computation**

**23.22(i) Function Values**

Given  $\omega_1$  and  $\omega_3$ , with  $\Im(\omega_3/\omega_1) > 0$ , the nome  $q$  is computed from  $q = e^{i\pi\omega_3/\omega_1}$ . For  $\wp(z)$  we apply (23.6.2) and (23.6.5), generating all needed values of the theta functions by the methods described in §20.14.

The functions  $\zeta(z)$  and  $\sigma(z)$  are computed in a similar manner: the former by replacing  $u$  and  $z$  in (23.6.13) by  $z$  and  $\pi z/(2\omega_1)$ , respectively, and also referring to (23.6.8); the latter by applying (23.6.9).

The modular functions  $\lambda(\tau)$ ,  $J(\tau)$ , and  $\eta(\tau)$  are also obtainable in a similar manner from their definitions in §23.15(ii).

**23.22(ii) Lattice Calculations**

**Starting from Lattice**

Suppose that the lattice  $\mathbb{L}$  is given. Then a pair of generators  $2\omega_1$  and  $2\omega_3$  can be chosen in an almost canonical way as follows. For  $2\omega_1$  choose a nonzero point of  $\mathbb{L}$  of smallest absolute value. (There will be 2, 4, or 6 possible choices.) For  $2\omega_3$  choose a nonzero point that is not a multiple of  $2\omega_1$  and is such that  $\Im\tau > 0$  and  $|\tau|$  is as small as possible, where  $\tau = \omega_3/\omega_1$ . (There will be either 1 or 2 possible choices.) This yields a pair of generators that satisfy  $\Im\tau > 0$ ,  $|\Re\tau| \leq \frac{1}{2}$ ,  $|\tau| > 1$ . In consequence,  $q = e^{i\pi\omega_3/\omega_1}$  satisfies  $|q| \leq e^{-\pi\sqrt{3}/2} = 0.0658\dots$ . The corresponding values of  $e_1, e_2, e_3$  are calculated from (23.6.2)–(23.6.4), then  $g_2$  and  $g_3$  are obtained from (23.3.6) and (23.3.7).

**Starting from Invariants**

Suppose that the invariants  $g_2 = c, g_3 = d$ , are given, for example in the differential equation (23.3.10) or via coefficients of an elliptic curve (§23.20(ii)). The determination of suitable generators  $2\omega_1$  and  $2\omega_3$  is the classical *inversion problem* (Whittaker and Watson (1927, §21.73), McKean and Moll (1999, §2.12); see also §20.9(i) and McKean and Moll (1999, §2.16)). This problem is solvable as follows:

- (a) In the general case, given by  $cd \neq 0$ , we compute the roots  $\alpha, \beta, \gamma$ , say, of the cubic equation  $4t^3 - ct - d = 0$ ; see §1.11(iii). These roots are necessarily distinct and represent  $e_1, e_2, e_3$  in some order.

If  $c$  and  $d$  are real, then  $e_1, e_2, e_3$  can be identified via (23.5.1), and  $k^2, k'^2$  obtained from (23.6.16).

If  $c$  and  $d$  are not both real, then we label  $\alpha, \beta, \gamma$  so that the triangle with vertices  $\alpha, \beta, \gamma$  is positively oriented and  $[\alpha, \gamma]$  is its longest side (chosen arbitrarily if there is more than one). In particular, if  $\alpha, \beta, \gamma$  are collinear, then we label them so that  $\beta$  is on the line segment  $(\alpha, \gamma)$ . In consequence,  $k^2 = (\beta - \gamma)/(\alpha - \gamma), k'^2 = (\alpha - \beta)/(\alpha - \gamma)$  satisfy  $\Im k^2 \geq 0 \geq \Im k'^2$  (with strict inequality unless  $\alpha, \beta, \gamma$  are collinear); also  $|k^2|, |k'^2| \leq 1$ .

Finally, on taking the principal square roots of  $k^2$  and  $k'^2$  we obtain values for  $k$  and  $k'$  that lie in the 1st and 4th quadrants, respectively, and  $2\omega_1, 2\omega_3$  are given by

**23.22.1** 
$$\begin{aligned} 2\omega_1 M(1, k') &= -2i\omega_3 M(1, k) \\ &= \frac{\pi}{3} \sqrt{\frac{c(2 + k^2 k'^2)(k'^2 - k^2)}{d(1 - k^2 k'^2)}}, \end{aligned}$$

where  $M$  denotes the arithmetic-geometric mean (see §§19.8(i) and 22.20(ii)). This process yields 2



possible pairs  $(2\omega_1, 2\omega_3)$ , corresponding to the 2 possible choices of the square root.

(b) If  $d = 0$ , then

$$23.22.2 \quad 2\omega_1 = -2i\omega_3 = \frac{\left(\Gamma\left(\frac{1}{4}\right)\right)^2}{2\sqrt{\pi}c^{1/4}}.$$

There are 4 possible pairs  $(2\omega_1, 2\omega_3)$ , corresponding to the 4 rotations of a square lattice. The lemniscatic case occurs when  $c > 0$  and  $\omega_1 > 0$ .

(c) If  $c = 0$ , then

$$23.22.3 \quad 2\omega_1 = 2e^{-\pi i/3}\omega_3 = \frac{\left(\Gamma\left(\frac{1}{3}\right)\right)^3}{2\pi d^{1/6}}.$$

There are 6 possible pairs  $(2\omega_1, 2\omega_3)$ , corresponding to the 6 rotations of a lattice of equilateral triangles. The equianharmonic case occurs when  $d > 0$  and  $\omega_1 > 0$ .

#### Example

Assume  $c = g_2 = -4(3 - 2i)$  and  $d = g_3 = 4(4 - 2i)$ . Then  $\alpha = -1 - 2i$ ,  $\beta = 1$ ,  $\gamma = 2i$ ;  $k^2 = (7 + 6i)/17$ , and  $k'^2 = (10 - 6i)/17$ . Working to 6 decimal places we obtain

$$23.22.4 \quad \begin{aligned} 2\omega_1 &= 0.867568 + i1.466607, \\ 2\omega_3 &= -1.223741 + i1.328694, \\ \tau &= 0.305480 + i1.015109. \end{aligned}$$

### 23.23 Tables

Table 18.2 in Abramowitz and Stegun (1964) gives values of  $\wp(z)$ ,  $\wp'(z)$ , and  $\zeta(z)$  to 7 or 8D in the rectangular and rhombic cases, normalized so that  $\omega_1 = 1$  and  $\omega_3 = ia$  (rectangular case), or  $\omega_1 = 1$  and  $\omega_3 = \frac{1}{2} + ia$  (rhombic case), for  $a = 1.00, 1.05, 1.1, 1.2, 1.4, 2, 4$ . The values are tabulated on the real and imaginary  $z$ -axes, mostly ranging from 0 to 1 or  $i$  in steps of length 0.05, and in the case of  $\wp(z)$  the user may deduce values for complex  $z$  by application of the addition theorem (23.10.1).

Abramowitz and Stegun (1964) also includes other tables to assist the computation of the Weierstrass functions, for example, the generators as functions of the lattice invariants  $g_2$  and  $g_3$ .

For earlier tables related to Weierstrass functions see Fletcher *et al.* (1962, pp. 503–505) and Lebedev and Fedorova (1960, pp. 223–226).

### 23.24 Software

See <http://dlmf.nist.gov/23.24>.

## References

### General References

The main references used in writing this chapter are Lawden (1989, Chapters 6, 7, 9), McKean and Moll (1999, Chapters 1–5), Walker (1996, Chapter 7 and §§3.4, 8.4), and Whittaker and Watson (1927, Chapter 20 and §21.7). For additional bibliographic reading see Apostol (1990, Chapters 1–6), Copson (1935, Chapters 13 and 15), Erdélyi *et al.* (1953b, §§13.12–13.15 and 13.24), and Koblitz (1993, Chapters 1–4).

### Sources

The following list gives the references or other indications of proofs that were used in constructing the various sections of this chapter. These sources supplement the references that are quoted in the text.

§23.2 Whittaker and Watson (1927, §§20.2–20.21, 20.4–20.421), Walker (1996, §3.1), Lawden (1989, Chapter 6). For (23.2.16) differentiate (23.2.15) and use (23.2.6). For (23.2.17) use (23.2.15) and induction.

§23.3 Whittaker and Watson (1927, §§20.22, 20.32, 21.73), Lawden (1989, §6.7), Walker (1996, §3.4). (23.3.11) follows from (23.3.3), (23.3.10). For (23.3.12), (23.3.13) differentiate (23.3.10).

§23.4 These graphics were produced at NIST.

§23.5 Walker (1996, §§7.5, 8.4.2). (Some errors in §7.5 are corrected here.)

§23.6 For (23.6.2)–(23.6.7) see Walker (1996, pp. 94 and 103). For (23.6.8) and (23.6.9) see Whittaker and Watson (1927, §21.43). For (23.6.10)–(23.6.12) use (23.6.9). For (23.6.13) and (23.6.14) see Lawden (1989, §6.6). For (23.6.15) combine (20.2.6) and (23.6.9). For (23.6.16) and (23.6.17) combine (23.6.2)–(23.6.4) with (22.2.2) and (20.7.5). For (23.6.18)–(23.6.20) combine (20.9.1) and (20.9.2) with (23.6.2)–(23.6.4). For (23.6.21)–(23.6.23) combine (23.6.5)–(23.6.7) with (22.2.4)–(22.2.9). For (23.6.24)–(23.6.26) combine (23.6.21)–(23.6.23) with §22.4(iii). (23.6.27)–(23.6.29) can be verified by matching periods, poles, and residues as in Lawden (1989, §8.11).

§23.7 Lawden (1989, p. 182).

§23.8 Lawden (1989, §6.5, pp. 183–184, §8.6).

- §23.9** For (23.9.2)–(23.9.5) equate coefficients in (23.2.4), (23.2.5), and also apply (23.10.1), (23.10.2). The first two coefficients in the Maclaurin expansion (23.9.6) are given by (23.3.9), (23.2.10); the others are obtained from §23.3(ii) combined with (23.9.4). (23.9.7) follows from (23.2.8) and (23.9.3).
- §23.10** Whittaker and Watson (1927, §§20.3–20.311, 20.41), Lawden (1989, pp. 152–158, 161–162). For (23.10.7), (23.10.9), (23.10.10) let  $v \rightarrow u$  in (23.10.1)–(23.10.3). For (23.10.8) see Walker (1996, p. 83). For (23.10.11) and (23.10.12) compare the poles and residues of the two sides. (23.10.13) follows by integration. For (23.10.15) combine (23.10.14), (23.8.7), and (4.21.35).
- §23.11** Dienstfrey and Huang (2006).
- §23.12** These approximations follow from the expansions given in §23.8(ii). For (23.12.4) use Lawden (1989, Eq. 6.2.7) and (20.4.8).
- §23.14** To verify these results differentiate and use (23.2.7), §23.3(ii).
- §23.15** Apostol (1990, Chapters 1, 2), Walker (1996, Chapter 7), McKean and Moll (1999, Chapters 4, 6). For (23.15.9) use (20.5.3) and (23.17.8).
- §23.16** These graphics were produced at NIST.
- §23.17** Walker (1996, §7.5). For (23.17.4)–(23.17.6) combine §23.15(ii) with the  $q$ -expansions of the theta functions obtained by setting  $z = 0$  in §20.2(i). For (23.17.7), (23.17.8) combine (23.15.6), (23.15.9), and (20.5.1)–(20.5.3).
- §23.18** See Walker (1996, Chapter 7), Ahlfors (1966, pp. 271–274), and Serre (1973, Chapter 7). For (23.18.4)–(23.18.7) see Apostol (1990, pp. 17, 52).
- §23.19** Apostol (1990, Chapters 2, 3), Serre (1973, Chapter 7). (23.19.4) follows from (20.5.3) and (23.17.8).
- §23.20** McKean and Moll (1999, §2.8).
- §23.21** Jones (1964, pp. 31–33).
- §23.22** For (23.22.1) combine (23.6.2)–(23.6.4) and §23.10(iv). (23.22.2) and (23.22.3) follow from (23.5.3) and (23.5.7), respectively.



## Chapter 24

# Bernoulli and Euler Polynomials

K. Dilcher<sup>1</sup>

<b>Notation</b>	<b>588</b>	24.13 Integrals . . . . .	594
24.1 Special Notation . . . . .	588	24.14 Sums . . . . .	595
<b>Properties</b>	<b>588</b>	24.15 Related Sequences of Numbers . . . . .	595
24.2 Definitions and Generating Functions . . . . .	588	24.16 Generalizations . . . . .	596
24.3 Graphs . . . . .	589	<b>Applications</b>	<b>597</b>
24.4 Basic Properties . . . . .	589	24.17 Mathematical Applications . . . . .	597
24.5 Recurrence Relations . . . . .	591	24.18 Physical Applications . . . . .	598
24.6 Explicit Formulas . . . . .	591	<b>Computation</b>	<b>598</b>
24.7 Integral Representations . . . . .	592	24.19 Methods of Computation . . . . .	598
24.8 Series Expansions . . . . .	592	24.20 Tables . . . . .	598
24.9 Inequalities . . . . .	593	24.21 Software . . . . .	598
24.10 Arithmetic Properties . . . . .	593	<b>References</b>	<b>598</b>
24.11 Asymptotic Approximations . . . . .	593		
24.12 Zeros . . . . .	594		

<sup>1</sup>Dalhousie University, Halifax, Nova Scotia, Canada.

**Acknowledgments:** This chapter is based in part on Abramowitz and Stegun (1964, Chapter 23) by E. V. Haynsworth and K. Goldberg.

**Copyright** © 2009 National Institute of Standards and Technology. All rights reserved.

## Notation

### 24.1 Special Notation

(For other notation see pp. xiv and 873.)

$j, k, \ell, m, n$	integers, nonnegative unless stated otherwise.
$t, x$	real or complex variables.
$p$	prime.
$p \mid m$	$p$ divides $m$ .
$(k, m)$	greatest common divisor of $m, n$ .
$(k, m) = 1$	$k$ and $m$ relatively prime.

Unless otherwise noted, the formulas in this chapter hold for all values of the variables  $x$  and  $t$ , and for all nonnegative integers  $n$ .

#### Bernoulli Numbers and Polynomials

The origin of the notation  $B_n, B_n(x)$ , is not clear. The present notation, as defined in §24.2(i), was used in Lucas (1891) and Nörlund (1924), and has become the prevailing notation; see Table 24.2.1. Among various older notations, the most common one is

$$B_1 = \frac{1}{6}, \quad B_2 = \frac{1}{30}, \quad B_3 = \frac{1}{42}, \quad B_4 = \frac{1}{30}, \dots$$

It was used in Saalschütz (1893), Nielsen (1923), Schwatt (1962), and Whittaker and Watson (1927).

#### Euler Numbers and Polynomials

The secant series ((4.19.5)) first occurs in the work of Gregory in 1671. Its coefficients were first studied in Euler (1755); they were called Euler numbers by Raabe in 1851. The notations  $E_n, E_n(x)$ , as defined in §24.2(ii), were used in Lucas (1891) and Nörlund (1924).

Other historical remarks on notations can be found in Cajori (1929, pp. 42–44). Various systems of notation are summarized in Adrian (1959) and D'Ocagne (1904).

## Properties

### 24.2 Definitions and Generating Functions

#### 24.2(i) Bernoulli Numbers and Polynomials

$$24.2.1 \quad \frac{t}{e^t - 1} = \sum_{n=0}^{\infty} B_n \frac{t^n}{n!}, \quad |t| < 2\pi.$$

$$24.2.2 \quad B_{2n+1} = 0, \quad (-1)^{n+1} B_{2n} > 0, \quad n = 1, 2, \dots$$

$$24.2.3 \quad \frac{te^{xt}}{e^t - 1} = \sum_{n=0}^{\infty} B_n(x) \frac{t^n}{n!}, \quad |t| < 2\pi.$$

$$24.2.4 \quad B_n = B_n(0),$$

$$24.2.5 \quad B_n(x) = \sum_{k=0}^n \binom{n}{k} B_k x^{n-k}.$$

See also §§4.19 and 4.33.

#### 24.2(ii) Euler Numbers and Polynomials

$$24.2.6 \quad \frac{2e^t}{e^{2t} + 1} = \sum_{n=0}^{\infty} E_n \frac{t^n}{n!}, \quad |t| < \frac{1}{2}\pi,$$

$$24.2.7 \quad E_{2n+1} = 0, \quad (-1)^n E_{2n} > 0.$$

$$24.2.8 \quad \frac{2e^{xt}}{e^t + 1} = \sum_{n=0}^{\infty} E_n(x) \frac{t^n}{n!}, \quad |t| < \pi,$$

$$24.2.9 \quad E_n = 2^n E_n\left(\frac{1}{2}\right) = \text{integer},$$

$$24.2.10 \quad E_n(x) = \sum_{k=0}^n \binom{n}{k} \frac{E_k}{2^k} \left(x - \frac{1}{2}\right)^{n-k}.$$

See also (4.19.5).

#### 24.2(iii) Periodic Bernoulli and Euler Functions

$$24.2.11 \quad \tilde{B}_n(x) = B_n(x), \quad \tilde{E}_n(x) = E_n(x), \quad 0 \leq x < 1,$$

$$24.2.12 \quad \tilde{B}_n(x+1) = \tilde{B}_n(x), \quad \tilde{E}_n(x+1) = -\tilde{E}_n(x), \\ x \in \mathbb{R}.$$

**24.2(iv) Tables**

Table 24.2.1: Bernoulli and Euler numbers.

$n$	$B_n$	$E_n$
0	1	1
1	$-\frac{1}{2}$	0
2	$\frac{1}{6}$	-1
4	$-\frac{1}{30}$	5
6	$\frac{1}{42}$	-61
8	$-\frac{1}{30}$	1385
10	$\frac{5}{66}$	-50521
12	$-\frac{691}{2730}$	27 02765
14	$\frac{7}{6}$	-1993 60981
16	$-\frac{3617}{510}$	1 93915 12145

Table 24.2.2: Bernoulli and Euler polynomials.

$n$	$B_n(x)$	$E_n(x)$
0	1	1
1	$x - \frac{1}{2}$	$x - \frac{1}{2}$
2	$x^2 - x + \frac{1}{6}$	$x^2 - x$
3	$x^3 - \frac{3}{2}x^2 + \frac{1}{2}x$	$x^3 - \frac{3}{2}x^2 + \frac{1}{4}$
4	$x^4 - 2x^3 + x^2 - \frac{1}{30}$	$x^4 - 2x^3 + x$
5	$x^5 - \frac{5}{2}x^4 + \frac{5}{3}x^3 - \frac{1}{6}x$	$x^5 - \frac{5}{2}x^4 + \frac{5}{2}x^2 - \frac{1}{2}$

For extensions of Tables 24.2.1 and 24.2.2 see <http://dlmf.nist.gov/24.2.iv>.

**24.3 Graphs**

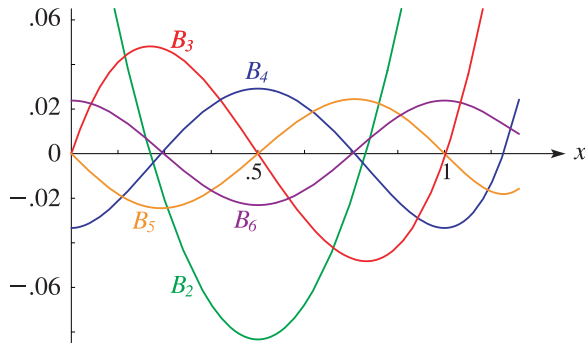


Figure 24.3.1: Bernoulli polynomials  $B_n(x)$ ,  $n = 2, 3, \dots, 6$ .

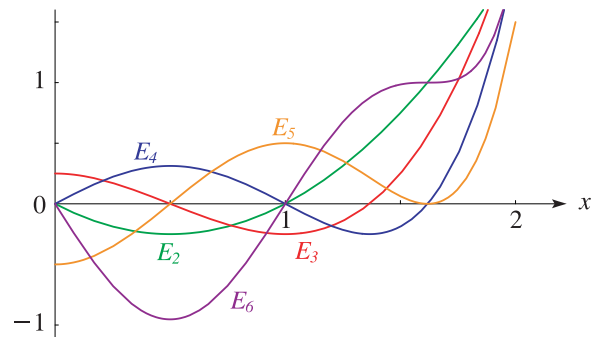


Figure 24.3.2: Euler polynomials  $E_n(x)$ ,  $n = 2, 3, \dots, 6$ .

**24.4 Basic Properties**

**24.4(i) Difference Equations**

24.4.1  $B_n(x + 1) - B_n(x) = nx^{n-1}$ ,

24.4.2  $E_n(x + 1) + E_n(x) = 2x^n$ .

**24.4(ii) Symmetry**

24.4.3  $B_n(1 - x) = (-1)^n B_n(x)$ ,

24.4.4  $E_n(1 - x) = (-1)^n E_n(x)$ .

24.4.5  $(-1)^n B_n(-x) = B_n(x) + nx^{n-1}$ ,

24.4.6  $(-1)^{n+1} E_n(-x) = E_n(x) - 2x^n$ .

**24.4(iii) Sums of Powers**

24.4.7 
$$\sum_{k=1}^m k^n = \frac{B_{n+1}(m+1) - B_{n+1}}{n+1}$$
,

24.4.8 
$$\sum_{k=1}^m (-1)^{m-k} k^n = \frac{E_n(m+1) + (-1)^m E_n(0)}{2}$$
.

**24.4.9**

$$\sum_{k=0}^{m-1} (a + dk)^n = \frac{d^n}{n+1} \left( B_{n+1} \left( m + \frac{a}{d} \right) - B_{n+1} \left( \frac{a}{d} \right) \right),$$

**24.4.10**

$$\sum_{k=0}^{m-1} (-1)^k (a + dk)^n = \frac{d^n}{2} \left( (-1)^{m-1} E_n \left( m + \frac{a}{d} \right) + E_n \left( \frac{a}{d} \right) \right).$$

**24.4.11**

$$\sum_{\substack{k=1 \\ (k,m)=1}}^m k^n = \frac{1}{n+1} \sum_{j=1}^{n+1} \binom{n+1}{j} \times \left( \prod_{p|m} (1 - p^{n-j}) B_{n+1-j} \right) m^j.$$

**24.4(iv) Finite Expansions**

**24.4.12**  $B_n(x+h) = \sum_{k=0}^n \binom{n}{k} B_k(x) h^{n-k},$

**24.4.13**  $E_n(x+h) = \sum_{k=0}^n \binom{n}{k} E_k(x) h^{n-k},$

**24.4.14**  $E_{n-1}(x) = \frac{2}{n} \sum_{k=0}^n \binom{n}{k} (1-2^k) B_k x^{n-k},$

**24.4.15**

$$B_{2n} = \frac{2n}{2^{2n}(2^{2n}-1)} \sum_{k=0}^{n-1} \binom{2n-1}{2k} E_{2k},$$

**24.4.16**

$$E_{2n} = \frac{1}{2n+1} - \sum_{k=1}^n \binom{2n}{2k-1} \frac{2^{2k}(2^{2k-1}-1) B_{2k}}{k},$$

**24.4.17**

$$E_{2n} = 1 - \sum_{k=1}^n \binom{2n}{2k-1} \frac{2^{2k}(2^{2k}-1) B_{2k}}{2k}.$$

**24.4(v) Multiplication Formulas**

**Raabe's Theorem**

**24.4.18**  $B_n(mx) = m^{n-1} \sum_{k=0}^{m-1} B_n \left( x + \frac{k}{m} \right).$

Next,

**24.4.19**  $E_n(mx) = -\frac{2m^n}{n+1} \sum_{k=0}^{m-1} (-1)^k B_{n+1} \left( x + \frac{k}{m} \right),$   
 $m = 2, 4, 6, \dots,$

**24.4.20**

$$E_n(mx) = m^n \sum_{k=0}^{m-1} (-1)^k E_n \left( x + \frac{k}{m} \right), \quad m = 1, 3, 5, \dots$$

**24.4.21**  $B_n(x) = 2^{n-1} \left( B_n \left( \frac{1}{2}x \right) + B_n \left( \frac{1}{2}x + \frac{1}{2} \right) \right),$

**24.4.22**  $E_{n-1}(x) = \frac{2}{n} \left( B_n(x) - 2^n B_n \left( \frac{1}{2}x \right) \right),$

**24.4.23**  $E_{n-1}(x) = \frac{2^n}{n} \left( B_n \left( \frac{1}{2}x + \frac{1}{2} \right) - B_n \left( \frac{1}{2}x \right) \right),$

**24.4.24**

$$B_n(mx) = m^n B_n(x) + n \sum_{k=1}^n \sum_{j=0}^{k-1} (-1)^j \binom{n}{k} \times \left( \sum_{r=1}^{m-1} \frac{e^{2\pi i(k-j)r/m}}{(1 - e^{2\pi ir/m})^n} \right) (j+mx)^{n-1},$$

$$n = 1, 2, \dots, m = 2, 3, \dots$$

**24.4(vi) Special Values**

**24.4.25**  $B_n(0) = (-1)^n B_n(1) = B_n,$

**24.4.26**  $E_n(0) = -E_n(1) = -\frac{2}{n+1} (2^{n+1} - 1) B_{n+1}.$

**24.4.27**  $B_n \left( \frac{1}{2} \right) = -(1 - 2^{1-n}) B_n,$

**24.4.28**  $E_n \left( \frac{1}{2} \right) = 2^{-n} E_n.$

**24.4.29**  $B_{2n} \left( \frac{1}{3} \right) = B_{2n} \left( \frac{2}{3} \right) = -\frac{1}{2} (1 - 3^{1-2n}) B_{2n}.$

**24.4.30**

$$E_{2n-1} \left( \frac{1}{3} \right) = -E_{2n-1} \left( \frac{2}{3} \right) = -\frac{(1 - 3^{1-2n})(2^{2n} - 1)}{2n} B_{2n},$$

$$n = 1, 2, \dots$$

**24.4.31**

$$B_n \left( \frac{1}{4} \right) = (-1)^n B_n \left( \frac{3}{4} \right) = -\frac{1 - 2^{1-n}}{2^n} B_n - \frac{n}{4^n} E_{n-1},$$

$$n = 1, 2, \dots$$

**24.4.32**

$$B_{2n} \left( \frac{1}{6} \right) = B_{2n} \left( \frac{5}{6} \right) = \frac{1}{2} (1 - 2^{1-2n})(1 - 3^{1-2n}) B_{2n},$$

**24.4.33**  $E_{2n} \left( \frac{1}{6} \right) = E_{2n} \left( \frac{5}{6} \right) = \frac{1 + 3^{-2n}}{2^{2n+1}} E_{2n}.$

**24.4(vii) Derivatives**

**24.4.34**  $\frac{d}{dx} B_n(x) = n B_{n-1}(x), \quad n = 1, 2, \dots,$

**24.4.35**  $\frac{d}{dx} E_n(x) = n E_{n-1}(x), \quad n = 1, 2, \dots$

**24.4(viii) Symbolic Operations**

Let  $P(x)$  denote any polynomial in  $x$ , and after expanding set  $(B(x))^n = B_n(x)$  and  $(E(x))^n = E_n(x)$ . Then

**24.4.36**  $P(B(x) + 1) - P(B(x)) = P'(x),$

**24.4.37**  $B_n(x+h) = (B(x) + h)^n,$

**24.4.38**  $P(E(x) + 1) + P(E(x)) = 2P(x),$

**24.4.39**  $E_n(x+h) = (E(x) + h)^n.$

For these results and also connections with the umbral calculus see Gessel (2003).

### 24.4(ix) Relations to Other Functions

For the relation of Bernoulli numbers to the Riemann zeta function see §25.6, and to the Eulerian numbers see (26.14.11).

## 24.5 Recurrence Relations

### 24.5(i) Basic Relations

$$24.5.1 \quad \sum_{k=0}^{n-1} \binom{n}{k} B_k(x) = nx^{n-1}, \quad n = 2, 3, \dots,$$

$$24.5.2 \quad \sum_{k=0}^n \binom{n}{k} E_k(x) + E_n(x) = 2x^n, \quad n = 1, 2, \dots$$

$$24.5.3 \quad \sum_{k=0}^{n-1} \binom{n}{k} B_k = 0, \quad n = 2, 3, \dots,$$

$$24.5.4 \quad \sum_{k=0}^n \binom{2n}{2k} E_{2k} = 0, \quad n = 1, 2, \dots,$$

$$24.5.5 \quad \sum_{k=0}^n \binom{n}{k} 2^k E_{n-k} + E_n = 2.$$

### 24.5(ii) Other Identities

$$24.5.6 \quad \sum_{k=2}^n \binom{n}{k-2} \frac{B_k}{k} = \frac{1}{(n+1)(n+2)} - B_{n+1}, \quad n = 2, 3, \dots,$$

$$24.5.7 \quad \sum_{k=0}^n \binom{n}{k} \frac{B_k}{n+2-k} = \frac{B_{n+1}}{n+1}, \quad n = 1, 2, \dots,$$

$$24.5.8 \quad \sum_{k=0}^n \frac{2^{2k} B_{2k}}{(2k)!(2n+1-2k)!} = \frac{1}{(2n)!}, \quad n = 1, 2, \dots$$

### 24.5(iii) Inversion Formulas

In each of (24.5.9) and (24.5.10) the first identity implies the second one and vice-versa.

$$24.5.9 \quad a_n = \sum_{k=0}^n \binom{n}{k} \frac{b_{n-k}}{k+1}, \quad b_n = \sum_{k=0}^n \binom{n}{k} B_k a_{n-k}.$$

$$a_n = \sum_{k=0}^{\lfloor n/2 \rfloor} \binom{n}{2k} b_{n-2k},$$

$$24.5.10 \quad b_n = \sum_{k=0}^{\lfloor n/2 \rfloor} \binom{n}{2k} E_{2k} a_{n-2k}.$$

## 24.6 Explicit Formulas

The identities in this section hold for  $n = 1, 2, \dots$  (24.6.7), (24.6.8), (24.6.10), and (24.6.12) are valid also for  $n = 0$ .

$$24.6.1 \quad B_{2n} = \sum_{k=2}^{2n+1} \frac{(-1)^{k-1}}{k} \binom{2n+1}{k} \sum_{j=1}^{k-1} j^{2n},$$

$$24.6.2 \quad B_n = \frac{1}{n+1} \sum_{k=1}^n \sum_{j=1}^k (-1)^j j^n \binom{n+1}{k-j} \Big/ \binom{n}{k},$$

$$24.6.3 \quad B_{2n} = \sum_{k=1}^n \frac{(k-1)!k!}{(2k+1)!} \sum_{j=1}^k (-1)^{j-1} \binom{2k}{k+j} j^{2n}.$$

$$24.6.4 \quad E_{2n} = \sum_{k=1}^n \frac{1}{2^{k-1}} \sum_{j=1}^k (-1)^j \binom{2k}{k-j} j^{2n},$$

24.6.5

$$E_{2n} = \frac{1}{2^{n-1}} \sum_{k=0}^{n-1} (-1)^{n-k} (n-k)^{2n} \sum_{j=0}^k \binom{2n-2j}{k-j} 2^j,$$

24.6.6

$$E_{2n} = \sum_{k=1}^{2n} \frac{(-1)^k}{2^{k-1}} \binom{2n+1}{k+1} \sum_{j=0}^{\lfloor \frac{1}{2}k - \frac{1}{2} \rfloor} \binom{k}{j} (k-2j)^{2n}.$$

$$24.6.7 \quad B_n(x) = \sum_{k=0}^n \frac{1}{k+1} \sum_{j=0}^k (-1)^j \binom{k}{j} (x+j)^n,$$

$$24.6.8 \quad E_n(x) = \frac{1}{2^n} \sum_{k=1}^{n+1} \sum_{j=0}^{k-1} (-1)^j \binom{n+1}{k} (x+j)^n.$$

$$24.6.9 \quad B_n = \sum_{k=0}^n \frac{1}{k+1} \sum_{j=0}^k (-1)^j \binom{k}{j} j^n,$$

$$24.6.10 \quad E_n = \frac{1}{2^n} \sum_{k=1}^{n+1} \binom{n+1}{k} \sum_{j=0}^{k-1} (-1)^j (2j+1)^n.$$

$$24.6.11 \quad B_n = \frac{n}{2^n(2^n-1)} \sum_{k=1}^n \sum_{j=0}^{k-1} (-1)^{j+1} \binom{n}{k} j^{n-1},$$

$$24.6.12 \quad E_{2n} = \sum_{k=0}^{2n} \frac{1}{2^k} \sum_{j=0}^k (-1)^j \binom{k}{j} (1+2j)^{2n}.$$



### 24.7 Integral Representations

#### 24.7(i) Bernoulli and Euler Numbers

The identities in this subsection hold for  $n = 1, 2, \dots$  (24.7.6) also holds for  $n = 0$ .

24.7.1

$$B_{2n} = (-1)^{n+1} \frac{4n}{1 - 2^{1-2n}} \int_0^\infty \frac{t^{2n-1}}{e^{2\pi t} + 1} dt$$

$$= (-1)^{n+1} \frac{2n}{1 - 2^{1-2n}} \int_0^\infty t^{2n-1} e^{-\pi t} \operatorname{sech}(\pi t) dt,$$

24.7.2

$$B_{2n} = (-1)^{n+1} 4n \int_0^\infty \frac{t^{2n-1}}{e^{2\pi t} - 1} dt$$

$$= (-1)^{n+1} 2n \int_0^\infty t^{2n-1} e^{-\pi t} \operatorname{csch}(\pi t) dt,$$

24.7.3

$$B_{2n} = (-1)^{n+1} \frac{\pi}{1 - 2^{1-2n}} \int_0^\infty t^{2n} \operatorname{sech}^2(\pi t) dt,$$

24.7.4

$$B_{2n} = (-1)^{n+1} \pi \int_0^\infty t^{2n} \operatorname{csch}^2(\pi t) dt,$$

24.7.5

$$B_{2n} = (-1)^n \frac{2n(2n-1)}{\pi} \int_0^\infty t^{2n-2} \ln(1 - e^{-2\pi t}) dt.$$

24.7.6

$$E_{2n} = (-1)^n 2^{2n+1} \int_0^\infty t^{2n} \operatorname{sech}(\pi t) dt.$$

#### 24.7(ii) Bernoulli and Euler Polynomials

The following four equations hold for  $0 < \Re x < 1$ .

24.7.7

$$B_{2n}(x) = (-1)^{n+1} 2n$$

$$\times \int_0^\infty \frac{\cos(2\pi x) - e^{-2\pi t}}{\cosh(2\pi t) - \cos(2\pi x)} t^{2n-1} dt,$$

$n = 1, 2, \dots,$

24.7.8

$$B_{2n+1}(x) = (-1)^{n+1} (2n+1)$$

$$\times \int_0^\infty \frac{\sin(2\pi x)}{\cosh(2\pi t) - \cos(2\pi x)} t^{2n} dt.$$

24.7.9

$$E_{2n}(x) = (-1)^n 4 \int_0^\infty \frac{\sin(\pi x) \cosh(\pi t)}{\cosh(2\pi t) - \cos(2\pi x)} t^{2n} dt,$$

24.7.10

$$E_{2n+1}(x) = (-1)^{n+1} 4$$

$$\times \int_0^\infty \frac{\cos(\pi x) \sinh(\pi t)}{\cosh(2\pi t) - \cos(2\pi x)} t^{2n+1} dt.$$

#### Mellin–Barnes Integral

24.7.11

$$B_n(x) = \frac{1}{2\pi i} \int_{-c-i\infty}^{-c+i\infty} (x+t)^n \left( \frac{\pi}{\sin(\pi t)} \right)^2 dt, \quad 0 < c < 1.$$

#### 24.7(iii) Compendia

For further integral representations see Prudnikov *et al.* (1986a, §§2.3–2.6) and Gradshteyn and Ryzhik (2000, Chapters 3 and 4).

### 24.8 Series Expansions

#### 24.8(i) Fourier Series

If  $n = 1, 2, \dots$  and  $0 \leq x \leq 1$ , then

24.8.1 
$$B_{2n}(x) = (-1)^{n+1} \frac{2(2n)!}{(2\pi)^{2n}} \sum_{k=1}^\infty \frac{\cos(2\pi kx)}{k^{2n}},$$

24.8.2 
$$B_{2n+1}(x) = (-1)^{n+1} \frac{2(2n+1)!}{(2\pi)^{2n+1}} \sum_{k=1}^\infty \frac{\sin(2\pi kx)}{k^{2n+1}}.$$

The second expansion holds also for  $n = 0$  and  $0 < x < 1$ .

If  $n = 1$  with  $0 < x < 1$ , or  $n = 2, 3, \dots$  with  $0 \leq x \leq 1$ , then

24.8.3 
$$B_n(x) = -\frac{n!}{(2\pi i)^n} \sum_{\substack{k=-\infty \\ k \neq 0}}^\infty \frac{e^{2\pi i kx}}{k^n}.$$

If  $n = 1, 2, \dots$  and  $0 \leq x \leq 1$ , then

24.8.4

$$E_{2n}(x) = (-1)^n \frac{4(2n)!}{\pi^{2n+1}} \sum_{k=0}^\infty \frac{\sin((2k+1)\pi x)}{(2k+1)^{2n+1}},$$

24.8.5

$$E_{2n-1}(x) = (-1)^n \frac{4(2n-1)!}{\pi^{2n}} \sum_{k=0}^\infty \frac{\cos((2k+1)\pi x)}{(2k+1)^{2n}}.$$

#### 24.8(ii) Other Series

24.8.6

$$B_{4n+2} = (8n+4) \sum_{k=1}^\infty \frac{k^{4n+1}}{e^{2\pi k} - 1}, \quad n = 1, 2, \dots,$$

24.8.7

$$B_{2n} = \frac{(-1)^{n+1} 4n}{2^{2n} - 1} \sum_{k=1}^\infty \frac{k^{2n-1}}{e^{\pi k} + (-1)^{k+n}}, \quad n = 2, 3, \dots$$

Let  $\alpha\beta = \pi^2$ . Then

$$\frac{B_{2n}}{4n} (\alpha^n - (-\beta)^n) = \alpha^n \sum_{k=1}^\infty \frac{k^{2n-1}}{e^{2\alpha k} - 1}$$

24.8.8

$$- (-\beta)^n \sum_{k=1}^\infty \frac{k^{2n-1}}{e^{2\beta k} - 1},$$

$n = 2, 3, \dots$

24.8.9

$$E_{2n} = (-1)^n \sum_{k=1}^\infty \frac{k^{2n}}{\cosh(\frac{1}{2}\pi k)}$$

$$- 4 \sum_{k=0}^\infty \frac{(-1)^k (2k+1)^{2n}}{e^{2\pi(2k+1)} - 1}, \quad n = 1, 2, \dots$$

### 24.9 Inequalities

Except where otherwise noted, the inequalities in this section hold for  $n = 1, 2, \dots$

**24.9.1**  $|B_{2n}| > |B_{2n}(x)|, \quad 1 > x > 0,$

**24.9.2**  $(2 - 2^{1-2n})|B_{2n}| \geq |B_{2n}(x) - B_{2n}|, \quad 1 \geq x \geq 0.$   
 (24.9.3)–(24.9.5) hold for  $\frac{1}{2} > x > 0.$

**24.9.3**  $4^{-n}|E_{2n}| > (-1)^n E_{2n}(x) > 0,$

**24.9.4**  $\frac{2(2n+1)!}{(2\pi)^{2n+1}} > (-1)^{n+1} B_{2n+1}(x) > 0, \quad n = 2, 3, \dots,$

**24.9.5**  $\frac{4(2n-1)!}{\pi^{2n}} \frac{2^{2n}-1}{2^{2n}-2} > (-1)^n E_{2n-1}(x) > 0.$   
 (24.9.6)–(24.9.7) hold for  $n = 2, 3, \dots$

**24.9.6**  $5\sqrt{\pi n} \left(\frac{n}{\pi e}\right)^{2n} > (-1)^{n+1} B_{2n} > 4\sqrt{\pi n} \left(\frac{n}{\pi e}\right)^{2n},$

**24.9.7**  $8\sqrt{\frac{n}{\pi}} \left(\frac{4n}{\pi e}\right)^{2n} \left(1 + \frac{1}{12n}\right) > (-1)^n E_{2n} > 8\sqrt{\frac{n}{\pi}} \left(\frac{4n}{\pi e}\right)^{2n}.$

Lastly,

**24.9.8**  $\frac{2(2n)!}{(2\pi)^{2n}} \frac{1}{1 - 2^{\beta-2n}} \geq (-1)^{n+1} B_{2n} \geq \frac{2(2n)!}{(2\pi)^{2n}} \frac{1}{1 - 2^{-2n}}$

with

**24.9.9**  $\beta = 2 + \frac{\ln(1 - 6\pi^{-2})}{\ln 2} = 0.6491\dots$

**24.9.10**  $\frac{4^{n+1}(2n)!}{\pi^{2n+1}} > (-1)^n E_{2n} > \frac{4^{n+1}(2n)!}{\pi^{2n+1}} \frac{1}{1 + 3^{-1-2n}}.$

### 24.10 Arithmetic Properties

#### 24.10(i) Von Staudt–Clausen Theorem

Here and elsewhere in §24.10 the symbol  $p$  denotes a prime number.

**24.10.1**  $B_{2n} + \sum_{(p-1)|2n} \frac{1}{p} = \text{integer},$

where the summation is over all  $p$  such that  $p-1$  divides  $2n$ . The denominator of  $B_{2n}$  is the product of all these primes  $p$ .

**24.10.2**  $p B_{2n} \equiv p - 1 \pmod{p^{\ell+1}},$

where  $n \geq 2$ , and  $\ell(\geq 1)$  is an arbitrary integer such that  $(p-1)p^\ell | 2n$ . Here and elsewhere two rational numbers are *congruent* if the modulus divides the numerator of their difference.

#### 24.10(ii) Kummer Congruences

**24.10.3**  $\frac{B_m}{m} \equiv \frac{B_n}{n} \pmod{p},$

where  $m \equiv n \not\equiv 0 \pmod{p-1}$ .

**24.10.4**  $(1 - p^{m-1})\frac{B_m}{m} \equiv (1 - p^{n-1})\frac{B_n}{n} \pmod{p^{\ell+1}},$   
 valid when  $m \equiv n \pmod{(p-1)p^\ell}$  and  $n \not\equiv 0 \pmod{p-1}$ , where  $\ell(\geq 0)$  is a fixed integer.

**24.10.5**  $E_n \equiv E_{n+p-1} \pmod{p},$   
 where  $p(> 2)$  is a prime and  $n \geq 2$ .

**24.10.6**  $E_{2n} \equiv E_{2n+w} \pmod{2^\ell},$   
 valid for fixed integers  $\ell(\geq 0)$ , and for all  $n(\geq 0)$  and  $w(\geq 0)$  such that  $2^\ell | w$ .

#### 24.10(iii) Voronoi's Congruence

Let  $B_{2n} = N_{2n}/D_{2n}$ , with  $N_{2n}$  and  $D_{2n}$  relatively prime and  $D_{2n} > 0$ . Then

$(b^{2n} - 1)N_{2n} \equiv 2nb^{2n-1}D_{2n} \sum_{k=1}^{M-1} k^{2n-1} \left\lfloor \frac{kb}{M} \right\rfloor \pmod{M},$   
**24.10.7**

where  $M(\geq 2)$  and  $b$  are integers, with  $b$  relatively prime to  $M$ .

For historical notes, generalizations, and applications, see Porubský (1998).

#### 24.10(iv) Factors

With  $N_{2n}$  as in §24.10(iii)

**24.10.8**  $N_{2n} \equiv 0 \pmod{p^\ell},$   
 valid for fixed integers  $\ell(\geq 1)$ , and for all  $n(\geq 1)$  such that  $2n \not\equiv 0 \pmod{p-1}$  and  $p^\ell | 2n$ .

**24.10.9**  $E_{2n} \equiv \begin{cases} 0 \pmod{p^\ell} & \text{if } p \equiv 1 \pmod{4}, \\ 2 \pmod{p^\ell} & \text{if } p \equiv 3 \pmod{4}, \end{cases}$

valid for fixed integers  $\ell(\geq 1)$  and for all  $n(\geq 1)$  such that  $(p-1)p^{\ell-1} | 2n$ .

### 24.11 Asymptotic Approximations

As  $n \rightarrow \infty$

**24.11.1**  $(-1)^{n+1} B_{2n} \sim \frac{2(2n)!}{(2\pi)^{2n}},$

**24.11.2**  $(-1)^{n+1} B_{2n} \sim 4\sqrt{\pi n} \left(\frac{n}{\pi e}\right)^{2n},$

**24.11.3**  $(-1)^n E_{2n} \sim \frac{2^{2n+2}(2n)!}{\pi^{2n+1}},$

**24.11.4**  $(-1)^n E_{2n} \sim 8\sqrt{\frac{n}{\pi}} \left(\frac{4n}{\pi e}\right)^{2n}.$

Also,

24.11.5

$$(-1)^{\lfloor n/2 \rfloor - 1} \frac{(2\pi)^n}{2(n!)} B_n(x) \rightarrow \begin{cases} \cos(2\pi x), & n \text{ even,} \\ \sin(2\pi x), & n \text{ odd,} \end{cases}$$

24.11.6

$$(-1)^{\lfloor (n+1)/2 \rfloor} \frac{\pi^{n+1}}{4(n!)} E_n(x) \rightarrow \begin{cases} \sin(\pi x), & n \text{ even,} \\ \cos(\pi x), & n \text{ odd,} \end{cases}$$

uniformly for  $x$  on compact subsets of  $\mathbb{C}$ .

For further results see Temme (1995b) and López and Temme (1999b).

## 24.12 Zeros

### 24.12(i) Bernoulli Polynomials: Real Zeros

In the interval  $0 \leq x \leq 1$  the only zeros of  $B_{2n+1}(x)$ ,  $n = 1, 2, \dots$ , are  $0, \frac{1}{2}, 1$ , and the only zeros of  $B_{2n}(x) - B_{2n}$ ,  $n = 1, 2, \dots$ , are  $0, 1$ .

For the interval  $\frac{1}{2} \leq x < \infty$  denote the zeros of  $B_n(x)$  by  $x_j^{(n)}$ ,  $j = 1, 2, \dots$ , with

24.12.1 
$$\frac{1}{2} \leq x_1^{(n)} \leq x_2^{(n)} \leq \dots$$

Then the zeros in the interval  $-\infty < x \leq \frac{1}{2}$  are  $1 - x_j^{(n)}$ .

When  $n(\geq 2)$  is even

24.12.2 
$$\frac{3}{4} + \frac{1}{2^{n+2}\pi} < x_1^{(n)} < \frac{3}{4} + \frac{1}{2^{n+1}\pi},$$

24.12.3 
$$x_1^{(n)} - \frac{3}{4} \sim \frac{1}{2^{n+1}\pi}, \quad n \rightarrow \infty,$$

and as  $n \rightarrow \infty$  with  $m(\geq 1)$  fixed,

24.12.4 
$$x_{2m-1}^{(n)} \rightarrow m - \frac{1}{4}, \quad x_{2m}^{(n)} \rightarrow m + \frac{1}{4}.$$

When  $n$  is odd  $x_1^{(n)} = \frac{1}{2}$ ,  $x_2^{(n)} = 1$  ( $n \geq 3$ ), and as  $n \rightarrow \infty$  with  $m(\geq 1)$  fixed,

24.12.5 
$$x_{2m-1}^{(n)} \rightarrow m - \frac{1}{2}, \quad x_{2m}^{(n)} \rightarrow m.$$

Let  $R(n)$  be the total number of real zeros of  $B_n(x)$ . Then  $R(n) = n$  when  $1 \leq n \leq 5$ , and

24.12.6 
$$R(n) \sim 2n/(\pi e), \quad n \rightarrow \infty.$$

### 24.12(ii) Euler Polynomials: Real Zeros

For the interval  $\frac{1}{2} \leq x < \infty$  denote the zeros of  $E_n(x)$  by  $y_j^{(n)}$ ,  $j = 1, 2, \dots$ , with

24.12.7 
$$\frac{1}{2} \leq y_1^{(n)} \leq y_2^{(n)} \leq \dots$$

Then the zeros in the interval  $-\infty < x \leq \frac{1}{2}$  are  $1 - y_j^{(n)}$ .

When  $n(\geq 2)$  is even  $y_1^{(n)} = 1$ , and as  $n \rightarrow \infty$  with  $m(\geq 1)$  fixed,

24.12.8 
$$y_m^{(n)} \rightarrow m.$$

When  $n$  is odd  $y_1^{(n)} = \frac{1}{2}$ ,

24.12.9 
$$\frac{3}{2} - \frac{\pi^{n+1}}{3(n!)} < y_2^{(n)} < \frac{3}{2}, \quad n = 3, 7, 11, \dots,$$

24.12.10 
$$\frac{3}{2} < y_2^{(n)} < \frac{3}{2} + \frac{\pi^{n+1}}{3(n!)}, \quad n = 5, 9, 13, \dots,$$

and as  $n \rightarrow \infty$  with  $m(\geq 1)$  fixed,

24.12.11 
$$y_{2m}^{(n)} \rightarrow m - \frac{1}{2}.$$

### 24.12(iii) Complex Zeros

For complex zeros of Bernoulli and Euler polynomials, see Delange (1987) and Dilcher (1988). A related topic is the irreducibility of Bernoulli and Euler polynomials. For details and references, see Dilcher (1987b), Kimura (1988), or Adelberg (1992).

### 24.12(iv) Multiple Zeros

$B_n(x)$ ,  $n = 1, 2, \dots$ , has no multiple zeros. The only polynomial  $E_n(x)$  with multiple zeros is  $E_5(x) = (x - \frac{1}{2})(x^2 - x - 1)^2$ .

## 24.13 Integrals

### 24.13(i) Bernoulli Polynomials

24.13.1 
$$\int B_n(t) dt = \frac{B_{n+1}(t)}{n+1} + \text{const.},$$

24.13.2 
$$\int_x^{x+1} B_n(t) dt = x^n, \quad n = 1, 2, \dots,$$

24.13.3 
$$\int_x^{x+(1/2)} B_n(t) dt = \frac{E_n(2x)}{2^{n+1}},$$

24.13.4 
$$\int_0^{1/2} B_n(t) dt = \frac{1 - 2^{n+1}}{2^n} \frac{B_{n+1}}{n+1},$$

24.13.5 
$$\int_{1/4}^{3/4} B_n(t) dt = \frac{E_n}{2^{2n+1}}.$$

For  $m, n = 1, 2, \dots$ ,

24.13.6 
$$\int_0^1 B_n(t) B_m(t) dt = \frac{(-1)^{n-1} m! n!}{(m+n)!} B_{m+n}.$$

### 24.13(ii) Euler Polynomials

24.13.7 
$$\int E_n(t) dt = \frac{E_{n+1}(t)}{n+1} + \text{const.},$$

24.13.8 
$$\int_0^1 E_n(t) dt = -2 \frac{E_{n+1}(0)}{n+1} = \frac{4(2^{n+2} - 1)}{(n+1)(n+2)} B_{n+2},$$

24.13.9 
$$\int_0^{1/2} E_{2n}(t) dt = -\frac{E_{2n+1}(0)}{2n+1} = \frac{2(2^{2n+2} - 1) B_{2n+2}}{(2n+1)(2n+2)},$$

$$24.13.10 \quad \int_0^{1/2} E_{2n-1}(t) dt = \frac{E_{2n}}{n2^{2n+1}}, \quad n = 1, 2, \dots$$

For  $m, n = 1, 2, \dots$ ,

$$24.13.11 \quad \int_0^1 E_n(t) E_m(t) dt = (-1)^n 4 \frac{(2^{m+n+2} - 1)m!n!}{(m+n+2)!} B_{m+n+2}.$$

### 24.13(iii) Compendia

For Laplace and inverse Laplace transforms see Prudnikov *et al.* (1992a, §§3.28.1–3.28.2) and Prudnikov *et al.* (1992b, §§3.26.1–3.26.2). For other integrals see Prudnikov *et al.* (1990, pp. 55–57).

## 24.14 Sums

### 24.14(i) Quadratic Recurrence Relations

$$24.14.1 \quad \sum_{k=0}^n \binom{n}{k} B_k(x) B_{n-k}(y) = n(x+y-1) B_{n-1}(x+y) - (n-1) B_n(x+y),$$

$$24.14.2 \quad \sum_{k=0}^n \binom{n}{k} B_k B_{n-k} = (1-n) B_n - n B_{n-1}.$$

$$24.14.3 \quad \sum_{k=0}^n \binom{n}{k} E_k(h) E_{n-k}(x) = 2(E_{n+1}(x+h) - (x+h-1) E_n(x+h)),$$

$$24.14.4 \quad \sum_{k=0}^n \binom{n}{k} E_k E_{n-k} = -2^{n+1} E_{n+1}(0) = -2^{n+2} (1 - 2^{n+2}) \frac{B_{n+2}}{n+2}.$$

$$24.14.5 \quad \sum_{k=0}^n \binom{n}{k} E_k(h) B_{n-k}(x) = 2^n B_n\left(\frac{1}{2}(x+h)\right),$$

$$24.14.6 \quad \sum_{k=0}^n \binom{n}{k} 2^k B_k E_{n-k} = 2(1 - 2^{n-1}) B_n - n E_{n-1}.$$

Let  $m+n$  be even with  $m$  and  $n$  nonzero. Then

$$24.14.7 \quad \sum_{j=0}^m \sum_{k=0}^n \binom{m}{j} \binom{n}{k} \frac{B_j B_k}{m+n-j-k+1} = (-1)^{m-1} \frac{m!n!}{(m+n)!} B_{m+n}.$$

### 24.14(ii) Higher-Order Recurrence Relations

In the following two identities, valid for  $n \geq 2$ , the sums are taken over all nonnegative integers  $j, k, \ell$  with  $j+k+\ell=n$ .

$$24.14.8 \quad \sum \frac{(2n)!}{(2j)!(2k)!(2\ell)!} B_{2j} B_{2k} B_{2\ell} = (n-1)(2n-1) B_{2n} + n(n-\frac{1}{2}) B_{2n-2},$$

$$24.14.9 \quad \sum \frac{(2n)!}{(2j)!(2k)!(2\ell)!} E_{2j} E_{2k} E_{2\ell} = \frac{1}{2} (E_{2n} - E_{2n+2}).$$

In the next identity, valid for  $n \geq 4$ , the sum is taken over all positive integers  $j, k, \ell, m$  with  $j+k+\ell+m=n$ .

$$24.14.10 \quad \sum \frac{(2n)!}{(2j)!(2k)!(2\ell)!(2m)!} B_{2j} B_{2k} B_{2\ell} B_{2m} = -\binom{2n+3}{3} B_{2n} - \frac{4}{3} n^2 (2n-1) B_{2n-2}.$$

For (24.14.11) and (24.14.12), see Al-Salam and Carlitz (1959). These identities can be regarded as higher-order recurrences. Let  $\det[a_{r+s}]$  denote a *Hankel* (or *persymmetric*) *determinant*, that is, an  $(n+1) \times (n+1)$  determinant with element  $a_{r+s}$  in row  $r$  and column  $s$  for  $r, s = 0, 1, \dots, n$ . Then

$$24.14.11 \quad \det[B_{r+s}] = (-1)^{n(n+1)/2} \left( \prod_{k=1}^n k! \right)^6 \bigg/ \left( \prod_{k=1}^{2n+1} k! \right),$$

$$24.14.12 \quad \det[E_{r+s}] = (-1)^{n(n+1)/2} \left( \prod_{k=1}^n k! \right)^2.$$

See also Sachse (1882).

### 24.14(iii) Compendia

For other sums involving Bernoulli and Euler numbers and polynomials see Hansen (1975, pp. 331–347) and Prudnikov *et al.* (1990, pp. 383–386).

## 24.15 Related Sequences of Numbers

### 24.15(i) Genocchi Numbers

$$24.15.1 \quad \frac{2t}{e^t + 1} = \sum_{n=1}^{\infty} G_n \frac{t^n}{n!},$$

$$24.15.2 \quad G_n = 2(1 - 2^n) B_n.$$

See Table 24.15.1.

**24.15(ii) Tangent Numbers**

24.15.3 
$$\tan t = \sum_{n=0}^{\infty} T_n \frac{t^n}{n!},$$

24.15.4 
$$T_{2n-1} = (-1)^{n-1} \frac{2^{2n}(2^{2n} - 1)}{2n} B_{2n}, \quad n = 1, 2, \dots,$$

24.15.5 
$$T_{2n} = 0, \quad n = 0, 1, \dots$$

Table 24.15.1: Genocchi and Tangent numbers.

$n$	0	1	2	3	4	5	6	7	8
$G_n$	0	1	-1	0	1	0	-3	0	17
$T_n$	0	1	0	2	0	16	0	272	0

**24.15(iii) Stirling Numbers**

The Stirling numbers of the first kind  $s(n, m)$ , and the second kind  $S(n, m)$ , are as defined in §26.8(i).

24.15.6 
$$B_n = \sum_{k=0}^n (-1)^k \frac{k! S(n, k)}{k+1},$$

24.15.7 
$$B_n = \sum_{k=0}^n (-1)^k \binom{n+1}{k+1} S(n+k, k) / \binom{n+k}{k},$$

24.15.8 
$$\sum_{k=0}^n (-1)^{n+k} s(n+1, k+1) B_k = \frac{n!}{n+1}.$$

In (24.15.9) and (24.15.10)  $p$  denotes a prime. See Horata (1991).

24.15.9 
$$p \frac{B_n}{n} \equiv S(p-1+n, p-1) \pmod{p^2}, \quad 1 \leq n \leq p-2,$$

24.15.10 
$$\frac{2n-1}{4n} p^2 B_{2n} \equiv S(p+2n, p-1) \pmod{p^3}, \quad 2 \leq 2n \leq p-3.$$

**24.15(iv) Fibonacci and Lucas Numbers**

The Fibonacci numbers are defined by  $u_0 = 0, u_1 = 1$ , and  $u_{n+1} = u_n + u_{n-1}, n \geq 1$ . The Lucas numbers are defined by  $v_0 = 2, v_1 = 1$ , and  $v_{n+1} = v_n + v_{n-1}, n \geq 1$ .

24.15.11 
$$\sum_{k=0}^{\lfloor n/2 \rfloor} \binom{n}{2k} \left(\frac{5}{9}\right)^k B_{2k} u_{n-2k} = \frac{n}{6} v_{n-1} + \frac{n}{3^n} v_{2n-2},$$

24.15.12 
$$\sum_{k=0}^{\lfloor n/2 \rfloor} \binom{n}{2k} \left(\frac{5}{4}\right)^k E_{2k} v_{n-2k} = \frac{1}{2^{n-1}}.$$

For further information on the Fibonacci numbers see §26.11.

**24.16 Generalizations**

**24.16(i) Higher-Order Analogs**

**Polynomials and Numbers of Integer Order**

For  $\ell = 0, 1, 2, \dots$ , *Bernoulli* and *Euler polynomials of order  $\ell$*  are defined respectively by

24.16.1 
$$\left(\frac{t}{e^t - 1}\right)^\ell e^{xt} = \sum_{n=0}^{\infty} B_n^{(\ell)}(x) \frac{t^n}{n!}, \quad |t| < 2\pi,$$

24.16.2 
$$\left(\frac{2}{e^t + 1}\right)^\ell e^{xt} = \sum_{n=0}^{\infty} E_n^{(\ell)}(x) \frac{t^n}{n!}, \quad |t| < \pi.$$

When  $x = 0$  they reduce to the *Bernoulli* and *Euler numbers of order  $\ell$* :

24.16.3 
$$B_n^{(\ell)} = B_n^{(\ell)}(0), \quad E_n^{(\ell)} = E_n^{(\ell)}(0).$$

Also for  $\ell = 1, 2, 3, \dots$ ,

24.16.4 
$$\left(\frac{\ln(1+t)}{t}\right)^\ell = \ell \sum_{n=0}^{\infty} \frac{B_n^{(\ell+n)} t^n}{\ell+n} \frac{1}{n!}, \quad |t| < 1.$$

For this and other properties see Milne-Thomson (1933, pp. 126–153) or Nörlund (1924, pp. 144–162).

For extensions of  $B_n^{(\ell)}(x)$  to complex values of  $x, n$ , and  $\ell$ , and also for uniform asymptotic expansions for large  $x$  and large  $n$ , see Temme (1995b).

**Bernoulli Numbers of the Second Kind**

24.16.5 
$$\frac{t}{\ln(1+t)} = \sum_{n=0}^{\infty} b_n t^n, \quad |t| < 1,$$

24.16.6 
$$n! b_n = -\frac{1}{n-1} B_n^{(n-1)}, \quad n = 2, 3, \dots$$

**Degenerate Bernoulli Numbers**

For sufficiently small  $|t|$ ,

24.16.7 
$$\frac{t}{(1+\lambda t)^{1/\lambda} - 1} = \sum_{n=0}^{\infty} \beta_n(\lambda) \frac{t^n}{n!},$$

24.16.8

$$\beta_n(\lambda) = n! b_n \lambda^n + \sum_{k=1}^{\lfloor n/2 \rfloor} \frac{n}{2k} B_{2k} s(n-1, 2k-1) \lambda^{n-2k}, \quad n = 2, 3, \dots$$

Here  $s(n, m)$  again denotes the Stirling number of the first kind.

**Nörlund Polynomials**

24.16.9 
$$\left(\frac{t}{e^t - 1}\right)^x = \sum_{n=0}^{\infty} B_n^{(x)} \frac{t^n}{n!}, \quad |t| < 2\pi.$$

$B_n^{(x)}$  is a polynomial in  $x$  of degree  $n$ . (This notation is consistent with (24.16.3) when  $x = \ell$ .)

**24.16(ii) Character Analogs**

Let  $\chi$  be a primitive Dirichlet character mod  $f$  (see §27.8). Then  $f$  is called the *conductor* of  $\chi$ . Generalized Bernoulli numbers and polynomials belonging to  $\chi$  are defined by

**24.16.10** 
$$\sum_{a=1}^f \frac{\chi(a)te^{at}}{e^{ft}-1} = \sum_{n=0}^{\infty} B_{n,\chi} \frac{t^n}{n!},$$

**24.16.11** 
$$B_{n,\chi}(x) = \sum_{k=0}^n \binom{n}{k} B_{k,\chi} x^{n-k}.$$

Let  $\chi_0$  be the trivial character and  $\chi_4$  the unique (non-trivial) character with  $f = 4$ ; that is,  $\chi_4(1) = 1, \chi_4(3) = -1, \chi_4(2) = \chi_4(4) = 0$ . Then

**24.16.12** 
$$B_n(x) = B_{n,\chi_0}(x-1),$$

**24.16.13** 
$$E_n(x) = -\frac{2^{1-n}}{n+1} B_{n+1,\chi_4}(2x-1).$$

For further properties see Berndt (1975a).

**24.16(iii) Other Generalizations**

In no particular order, other generalizations include: Bernoulli numbers and polynomials with arbitrary complex index (Butzer *et al.* (1992)); Euler numbers and polynomials with arbitrary complex index (Butzer *et al.* (1994));  $q$ -analogs (Carlitz (1954b), Andrews and Foata (1980)); conjugate Bernoulli and Euler polynomials (Hausz (1997, 1998)); Bernoulli–Hurwitz numbers (Katz (1975)); poly-Bernoulli numbers (Kaneko (1997)); Universal Bernoulli numbers (Clarke (1989));  $p$ -adic integer order Bernoulli numbers (Adelberg (1996));  $p$ -adic  $q$ -Bernoulli numbers (Kim and Kim (1999)); periodic Bernoulli numbers (Berndt (1975b)); cotangent numbers (Girstmair (1990a)); Bernoulli–Carlitz numbers (Goss (1978)); Bernoulli–Padé numbers (Dilcher (2002)); Bernoulli numbers belonging to periodic functions (Urbanowicz (1988)); cyclotomic Bernoulli numbers (Girstmair (1990b)); modified Bernoulli numbers (Zagier (1998)); higher-order Bernoulli and Euler polynomials with multiple parameters (Erdélyi *et al.* (1953a, §§1.13.1, 1.14.1)).

**Applications**

**24.17 Mathematical Applications**

**24.17(i) Summation**

**Euler–Maclaurin Summation Formula**

See §2.10(i). For a generalization see Olver (1997b, p. 284).

**Boole Summation Formula**

Let  $0 \leq h \leq 1$  and  $a, m$ , and  $n$  be integers such that  $n > a, m > 0$ , and  $f^{(m)}(x)$  is absolutely integrable over  $[a, n]$ . Then with the notation of §24.2(iii)

**24.17.1** 
$$\sum_{j=a}^{n-1} (-1)^j f(j+h) = \frac{1}{2} \sum_{k=0}^{m-1} \frac{E_k(h)}{k!} \left( (-1)^{n-1} f^{(k)}(n) + (-1)^a f^{(k)}(a) \right) + R_m(n),$$

where

**24.17.2** 
$$R_m(n) = \frac{1}{2(m-1)!} \int_a^n f^{(m)}(x) \tilde{E}_{m-1}(h-x) dx.$$

**Calculus of Finite Differences**

See Milne-Thomson (1933), Nörlund (1924), or Jordan (1965). For a more modern perspective see Graham *et al.* (1994).

**24.17(ii) Spline Functions**

**Euler Splines**

Let  $\mathcal{S}_n$  denote the class of functions that have  $n - 1$  continuous derivatives on  $\mathbb{R}$  and are polynomials of degree at most  $n$  in each interval  $(k, k + 1), k \in \mathbb{Z}$ . The members of  $\mathcal{S}_n$  are called *cardinal spline functions*. The functions

**24.17.3** 
$$S_n(x) = \frac{\tilde{E}_n(x + \frac{1}{2}n + \frac{1}{2})}{\tilde{E}_n(\frac{1}{2}n + \frac{1}{2})}, \quad n = 0, 1, \dots,$$

are called *Euler splines of degree  $n$* . For each  $n, S_n(x)$  is the unique bounded function such that  $S_n(x) \in \mathcal{S}_n$  and

**24.17.4** 
$$S_n(k) = (-1)^k, \quad k \in \mathbb{Z}.$$

The function  $S_n(x)$  is also optimal in a certain sense; see Schoenberg (1971).

**Bernoulli Monosplines**

A function of the form  $x^n - S(x)$ , with  $S(x) \in \mathcal{S}_{n-1}$  is called a *cardinal monospline of degree  $n$* . Again with the notation of §24.2(iii) define

**24.17.5** 
$$M_n(x) = \begin{cases} \tilde{B}_n(x) - B_n, & n \text{ even,} \\ \tilde{B}_n(x + \frac{1}{2}), & n \text{ odd.} \end{cases}$$

$M_n(x)$  is a monospline of degree  $n$ , and it follows from (24.4.25) and (24.4.27) that

**24.17.6** 
$$M_n(k) = 0, \quad k \in \mathbb{Z}.$$

For each  $n = 1, 2, \dots$  the function  $M_n(x)$  is also the unique cardinal monospline of degree  $n$  satisfying (24.17.6), provided that

**24.17.7** 
$$M_n(x) = O(|x|^\gamma), \quad x \rightarrow \pm\infty,$$
 for some positive constant  $\gamma$ .

For any  $n \geq 2$  the function

$$24.17.8 \quad F(x) = \tilde{B}_n(x) - 2^{-n} B_n$$

is the unique cardinal monospline of degree  $n$  having the least supremum norm  $\|F\|_\infty$  on  $\mathbb{R}$  (minimality property).

### 24.17(iii) Number Theory

Bernoulli and Euler numbers and polynomials occur in number theory via (24.4.7), (24.4.8), and other identities involving sums of powers; the Riemann zeta function and  $L$ -series (§25.15, Apostol (1976), and Ireland and Rosen (1990)); arithmetic of cyclotomic fields and the classical theory of Fermat's last theorem (Ribenoim (1979) and Washington (1997));  $p$ -adic analysis (Koblitz (1984, Chapter 2)).

### 24.18 Physical Applications

Bernoulli polynomials appear in statistical physics (Ordóñez and Driebe (1996)), in discussions of Casimir forces (Li *et al.* (1991)), and in a study of quark-gluon plasma (Meisinger *et al.* (2002)).

Euler polynomials also appear in statistical physics as well as in semi-classical approximations to quantum probability distributions (Ballentine and McRae (1998)).

## Computation

### 24.19 Methods of Computation

#### 24.19(i) Bernoulli and Euler Numbers and Polynomials

Equations (24.5.3) and (24.5.4) enable  $B_n$  and  $E_n$  to be computed by recurrence. For higher values of  $n$  more efficient methods are available. For example, the tangent numbers  $T_n$  can be generated by simple recurrence relations obtained from (24.15.3), then (24.15.4) is applied. A similar method can be used for the Euler numbers based on (4.19.5). For details see Knuth and Buckholtz (1967).

Another method is based on the identities

$$24.19.1 \quad N_{2n} = \frac{2(2n)!}{(2\pi)^{2n}} \left( \prod_{p-1|2n} p \right) \left( \prod_p \frac{p^{2n}}{p^{2n}-1} \right),$$

$$24.19.2 \quad D_{2n} = \prod_{p-1|2n} p, \quad B_{2n} = \frac{N_{2n}}{D_{2n}}.$$

If  $\tilde{N}_{2n}$  denotes the right-hand side of (24.19.1) but with the second product taken only for  $p \leq \lfloor (\pi e)^{-1} 2n \rfloor + 1$ ,

then  $N_{2n} = \lceil \tilde{N}_{2n} \rceil$  for  $n \geq 2$ . For proofs and further information see Fillebrown (1992).

For other information see Chellali (1988) and Zhang and Jin (1996, pp. 1–11). For algorithms for computing  $B_n$ ,  $E_n$ ,  $B_n(x)$ , and  $E_n(x)$  see Spanier and Oldham (1987, pp. 37, 41, 171, and 179–180).

#### 24.19(ii) Values of $B_n$ Modulo $p$

For number-theoretic applications it is important to compute  $B_{2n} \pmod{p}$  for  $2n \leq p-3$ ; in particular to find the *irregular pairs*  $(2n, p)$  for which  $B_{2n} \equiv 0 \pmod{p}$ . We list here three methods, arranged in increasing order of efficiency.

- Tanner and Wagstaff (1987) derives a congruence  $\pmod{p}$  for Bernoulli numbers in terms of sums of powers. See also §24.10(iii).
- Buhler *et al.* (1992) uses the expansion

$$24.19.3 \quad \frac{t^2}{\cosh t - 1} = -2 \sum_{n=0}^{\infty} (2n-1) B_{2n} \frac{t^{2n}}{(2n)!},$$

and computes inverses modulo  $p$  of the left-hand side. Multisectioning techniques are applied in implementations. See also Crandall (1996, pp. 116–120).

- A method related to “Stickelberger codes” is applied in Buhler *et al.* (2001); in particular, it allows for an efficient search for the irregular pairs  $(2n, p)$ . Discrete Fourier transforms are used in the computations. See also Crandall (1996, pp. 120–124).

### 24.20 Tables

Abramowitz and Stegun (1964, Chapter 23) includes exact values of  $\sum_{k=1}^m k^n$ ,  $m = 1(1)100$ ,  $n = 1(1)10$ ;  $\sum_{k=1}^{\infty} k^{-n}$ ,  $\sum_{k=1}^{\infty} (-1)^{k-1} k^{-n}$ ,  $\sum_{k=0}^{\infty} (2k+1)^{-n}$ ,  $n = 1, 2, \dots, 20D$ ;  $\sum_{k=0}^{\infty} (-1)^k (2k+1)^{-n}$ ,  $n = 1, 2, \dots, 18D$ .

Wagstaff (1978) gives complete prime factorizations of  $N_n$  and  $E_n$  for  $n = 20(2)60$  and  $n = 8(2)42$ , respectively. In Wagstaff (2002) these results are extended to  $n = 60(2)152$  and  $n = 40(2)88$ , respectively, with further complete and partial factorizations listed up to  $n = 300$  and  $n = 200$ , respectively.

For information on tables published before 1961 see Fletcher *et al.* (1962, v. 1, §4) and Lebedev and Fedorova (1960, Chapters 11 and 14).

### 24.21 Software

See <http://dlmf.nist.gov/24.21>.

## References

### General References

The main references used in writing this chapter are Erdélyi *et al.* (1953a, Chapter 1), Nörlund (1924, Chapter 2), and Nörlund (1922). Introductions to the subject are contained in Dence and Dence (1999) and Rademacher (1973); see also Apostol (2008). A comprehensive bibliography on the topics of this chapter can be found in Dilcher *et al.* (1991).

### Sources

The following list gives the references or other indications of proofs that were used in constructing the various sections of this chapter. These sources supplement the references that are quoted in the text.

- §24.2 Nörlund (1924, Chapter 2), Milne-Thomson (1933, Chapter 6). Tables are from Abramowitz and Stegun (1964, pp. 809–810).
- §24.3 These graphs were produced at NIST.
- §24.4 Nörlund (1924, Chapter 2), Milne-Thomson (1933, Chapter 6), Howard (1996b), Slavutskiĭ (2000), Apostol (2006), Todorov (1991). For (24.4.12)–(24.4.17) use (24.2.3) and (24.2.8). For (24.4.25)–(24.4.33) use §§24.4(ii) and 24.4(v). For (24.4.34) and (24.4.35) use (24.2.3) and (24.2.8).
- §24.5 Erdélyi *et al.* (1953a, Chapter 1), Nörlund (1924, pp. 19 and 24), Apostol (2008), Apostol (1976, p. 275), Riordan (1979, p. 114).
- §24.6 Gould (1972, pp. 45–46), Horata (1989), Todorov (1978), Schwatt (1962, p. 270), Carlitz (1961b, p. 134), Todorov (1991, pp. 176–177), Jordan (1965, p. 236).
- §24.7 Erdélyi *et al.* (1953a, Chapter 1), Ramanujan (1927, p. 7), Paris and Kaminski (2001, p. 173).
- §24.8 Apostol (1976, p. 267), Erdélyi *et al.* (1953a, p. 42), Berndt (1975b, pp. 176–178).
- §24.9 Olver (1997b, p. 283), Temme (1996a, p. 16), Lehmer (1940, p. 538), Leeming (1989), Alzer (2000). For (24.9.5) use (24.9.8), (24.4.35), (24.2.7), and (24.4.26). For (24.9.10) use (24.4.28) and (24.8.4) with  $x = \frac{1}{2}$ ; see also Lehmer (1940, p. 538).
- §24.10 Ireland and Rosen (1990, Chapter 15), Washington (1997, Chapter 5), Carlitz (1953, p. 167), Ernvall (1979, pp. 36 and 24), Slavutskiĭ (1995, 1999), Uspensky and Heaslet (1939, p. 261), Ribenboim (1979, p. 105), Girstmair (1990b), Carlitz (1954a).
- §24.11 Leeming (1977), Dilcher (1987a).
- §24.12 Olver (1997b, p. 283), Inkeri (1959), Leeming (1989), Delange (1991), Lehmer (1940), Dilcher (1988, p. 77), Howard (1976), Delange (1988), Dilcher (2008), Brillhart (1969).
- §24.13 Nörlund (1922, p. 143), Apostol (1976, p. 276), Nörlund (1924, pp. 31 and 36). For (24.13.1) and (24.13.2) use (24.4.34) and (24.4.1).
- §24.14 Nörlund (1922, pp. 135–142), Carlitz (1961a, p. 992), Dilcher (1996), Sitaramachandrarao and Davis (1986), Huang and Huang (1999).
- §24.15 Dumont and Viennot (1980), Graham *et al.* (1994, Chapter 6), Knuth and Buckholtz (1967), Todorov (1984, pp. 310 and 343), Gould (1972, pp. 44 and 48), Kelisky (1957, pp. 32 and 34).
- §24.16 Howard (1996a), Washington (1997, pp. 31–34), Dilcher (1988, pp. 8 and 9).
- §24.17 Temme (1996a, pp. 17 and 18), Nörlund (1924, pp. 29–36), Schumaker (1981, pp. 152–153), Schoenberg (1973, pp. 40–41 and 101).
- §24.19 For (24.19.3) use (24.2.1).





## Chapter 25

# Zeta and Related Functions

T. M. Apostol<sup>1</sup>

<b>Notation</b>	<b>602</b>	25.12 Polylogarithms . . . . .	610
25.1 Special Notation . . . . .	602	25.13 Periodic Zeta Function . . . . .	612
<b>Riemann Zeta Function</b>	<b>602</b>	25.14 Lerch's Transcendent . . . . .	612
25.2 Definition and Expansions . . . . .	602	25.15 Dirichlet $L$ -functions . . . . .	612
25.3 Graphics . . . . .	603	<b>Applications</b>	<b>613</b>
25.4 Reflection Formulas . . . . .	603	25.16 Mathematical Applications . . . . .	613
25.5 Integral Representations . . . . .	604	25.17 Physical Applications . . . . .	614
25.6 Integer Arguments . . . . .	605	<b>Computation</b>	<b>614</b>
25.7 Integrals . . . . .	606	25.18 Methods of Computation . . . . .	614
25.8 Sums . . . . .	606	25.19 Tables . . . . .	614
25.9 Asymptotic Approximations . . . . .	606	25.20 Approximations . . . . .	615
25.10 Zeros . . . . .	606	25.21 Software . . . . .	615
<b>Related Functions</b>	<b>607</b>	<b>References</b>	<b>615</b>
25.11 Hurwitz Zeta Function . . . . .	607		

<sup>1</sup>California Institute of Technology, Pasadena, California.

Copyright © 2009 National Institute of Standards and Technology. All rights reserved.

## Notation

### 25.1 Special Notation

(For other notation see pp. xiv and 873.)

$k, m, n$	nonnegative integers.
$p$	prime number.
$x$	real variable.
$a$	real or complex parameter.
$s = \sigma + it$	complex variable.
$z = x + iy$	complex variable.
$\gamma$	Euler's constant (§5.2(ii)).
$\psi(x)$	digamma function $\Gamma'(x)/\Gamma(x)$ except in §25.16. See §5.2(i).
$B_n, B_n(x)$	Bernoulli number and polynomial (§24.2(i)).
$\tilde{B}_n(x)$	periodic Bernoulli function $B_n(x - [x])$ .
$m   n$	$m$ divides $n$ .
primes	on function symbols: derivatives with respect to argument.

The main function treated in this chapter is the Riemann zeta function  $\zeta(s)$ . This notation was introduced in Riemann (1859).

The main related functions are the Hurwitz zeta function  $\zeta(s, a)$ , the dilogarithm  $\text{Li}_2(z)$ , the polylogarithm  $\text{Li}_s(z)$  (also known as Jonquière's function  $\phi(z, s)$ ), Lerch's transcendent  $\Phi(z, s, a)$ , and the Dirichlet  $L$ -functions  $L(s, \chi)$ .

## Riemann Zeta Function

### 25.2 Definition and Expansions

#### 25.2(i) Definition

When  $\Re s > 1$ ,

$$25.2.1 \quad \zeta(s) = \sum_{n=1}^{\infty} \frac{1}{n^s}.$$

Elsewhere  $\zeta(s)$  is defined by analytic continuation. It is a meromorphic function whose only singularity in  $\mathbb{C}$  is a simple pole at  $s = 1$ , with residue 1.

#### 25.2(ii) Other Infinite Series

$$25.2.2 \quad \zeta(s) = \frac{1}{1-2^{-s}} \sum_{n=0}^{\infty} \frac{1}{(2n+1)^s}, \quad \Re s > 1.$$

$$25.2.3 \quad \zeta(s) = \frac{1}{1-2^{1-s}} \sum_{n=1}^{\infty} \frac{(-1)^{n-1}}{n^s}, \quad \Re s > 0.$$

$$25.2.4 \quad \zeta(s) = \frac{1}{s-1} + \sum_{n=0}^{\infty} \frac{(-1)^n}{n!} \gamma_n (s-1)^n, \quad \Re s > 0,$$

where

$$25.2.5 \quad \gamma_n = \lim_{m \rightarrow \infty} \left( \sum_{k=1}^m \frac{(\ln k)^n}{k} - \frac{(\ln m)^{n+1}}{n+1} \right).$$

$$25.2.6 \quad \zeta'(s) = - \sum_{n=2}^{\infty} (\ln n) n^{-s}, \quad \Re s > 1.$$

#### 25.2.7

$$\zeta^{(k)}(s) = (-1)^k \sum_{n=2}^{\infty} (\ln n)^k n^{-s}, \quad \Re s > 1, \quad k = 1, 2, 3, \dots$$

For further expansions of functions similar to (25.2.1) (Dirichlet series) see §27.4. This includes, for example,  $1/\zeta(s)$ .

#### 25.2(iii) Representations by the Euler–Maclaurin Formula

$$25.2.8 \quad \zeta(s) = \sum_{k=1}^N \frac{1}{k^s} + \frac{N^{1-s}}{s-1} - s \int_N^{\infty} \frac{x - [x]}{x^{s+1}} dx, \quad \Re s > 0, \quad N = 1, 2, 3, \dots$$

$$25.2.9 \quad \zeta(s) = \sum_{k=1}^N \frac{1}{k^s} + \frac{N^{1-s}}{s-1} - \frac{1}{2} N^{-s} + \sum_{k=1}^n \binom{s+2k-2}{2k-1} \frac{B_{2k}}{2k} N^{1-s-2k} - \binom{s+2n}{2n+1} \int_N^{\infty} \frac{\tilde{B}_{2n+1}(x)}{x^{s+2n+1}} dx, \quad \Re s > -2n; \quad n, N = 1, 2, 3, \dots$$

$$25.2.10 \quad \zeta(s) = \frac{1}{s-1} + \frac{1}{2} + \sum_{k=1}^n \binom{s+2k-2}{2k-1} \frac{B_{2k}}{2k} - \binom{s+2n}{2n+1} \int_1^{\infty} \frac{\tilde{B}_{2n+1}(x)}{x^{s+2n+1}} dx, \quad \Re s > -2n, \quad n = 1, 2, 3, \dots$$

For  $B_{2k}$  see §24.2(i), and for  $\tilde{B}_n(x)$  see §24.2(iii).

#### 25.2(iv) Infinite Products

$$25.2.11 \quad \zeta(s) = \prod_p (1 - p^{-s})^{-1}, \quad \Re s > 1,$$

product over all primes  $p$ .

$$25.2.12 \quad \zeta(s) = \frac{(2\pi)^s e^{-s-(\gamma s/2)}}{2(s-1) \Gamma(\frac{1}{2}s+1)} \prod_{\rho} \left( 1 - \frac{s}{\rho} \right) e^{s/\rho},$$

product over zeros  $\rho$  of  $\zeta$  with  $\Re \rho > 0$  (see §25.10(i));  $\gamma$  is Euler's constant (§5.2(ii)).

### 25.3 Graphics

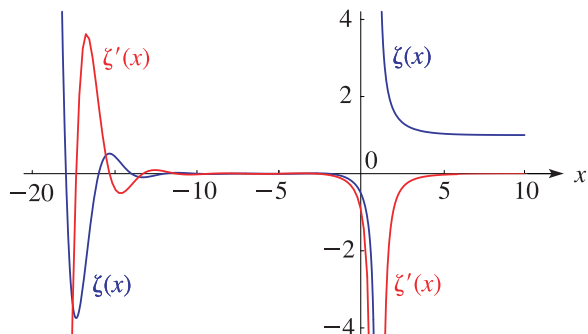


Figure 25.3.1: Riemann zeta function  $\zeta(x)$  and its derivative  $\zeta'(x)$ ,  $-20 \leq x \leq 10$ .

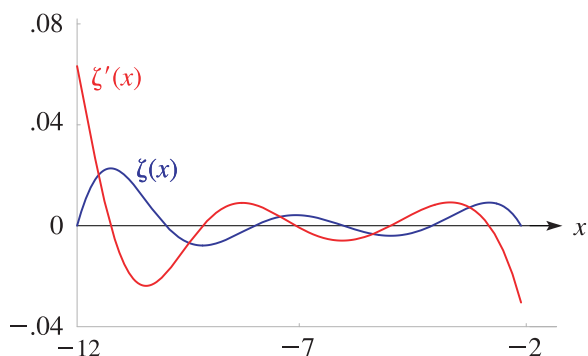


Figure 25.3.2: Riemann zeta function  $\zeta(x)$  and its derivative  $\zeta'(x)$ ,  $-12 \leq x \leq -2$ .

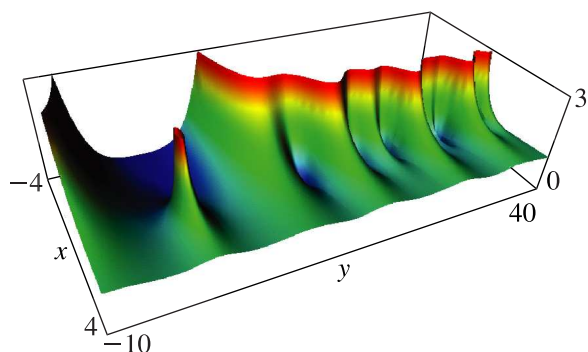


Figure 25.3.3: Modulus of the Riemann zeta function  $|\zeta(x + iy)|$ ,  $-4 \leq x \leq 4$ ,  $-10 \leq y \leq 40$ .

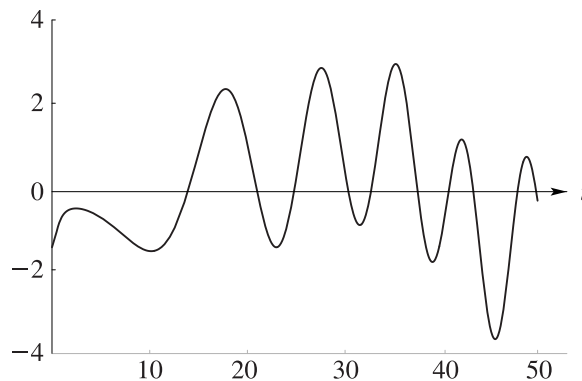


Figure 25.3.4:  $Z(t)$ ,  $0 \leq t \leq 50$ .  $Z(t)$  and  $\zeta(\frac{1}{2} + it)$  have the same zeros. See §25.10(i).

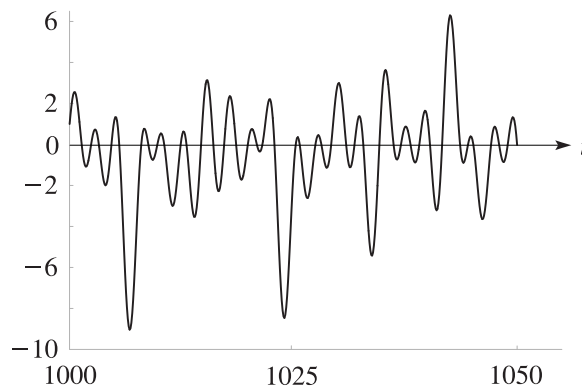


Figure 25.3.5:  $Z(t)$ ,  $1000 \leq t \leq 1050$ .

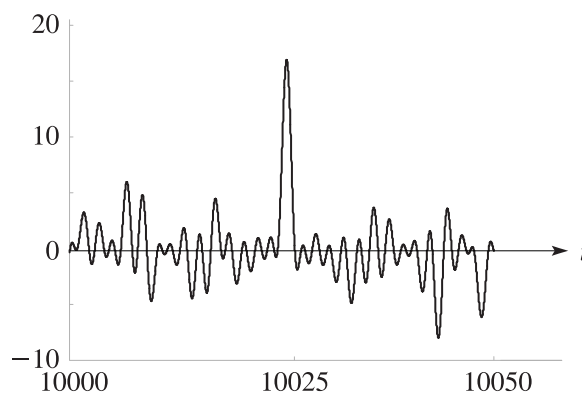


Figure 25.3.6:  $Z(t)$ ,  $10000 \leq t \leq 10050$ .

### 25.4 Reflection Formulas

For  $s \neq 0, 1$ ,

$$25.4.1 \quad \zeta(1 - s) = 2(2\pi)^{-s} \cos\left(\frac{1}{2}\pi s\right) \Gamma(s) \zeta(s),$$

$$25.4.2 \quad \zeta(s) = 2(2\pi)^{s-1} \sin\left(\frac{1}{2}\pi s\right) \Gamma(1 - s) \zeta(1 - s).$$

Equivalently,

$$25.4.3 \quad \xi(s) = \xi(1 - s),$$

where  $\xi(s)$  is Riemann's  $\xi$ -function, defined by:

$$25.4.4 \quad \xi(s) = \frac{1}{2}s(s-1)\Gamma\left(\frac{1}{2}s\right)\pi^{-s/2}\zeta(s).$$

For  $s \neq 0, 1$  and  $k = 1, 2, 3, \dots$ ,

$$25.4.5 \quad \begin{aligned} & (-1)^k \zeta^{(k)}(1-s) \\ &= \frac{2}{(2\pi)^s} \sum_{m=0}^k \sum_{r=0}^m \binom{k}{m} \binom{m}{r} (\Re(c^{k-m}) \cos(\tfrac{1}{2}\pi s) \\ & \quad + \Im(c^{k-m}) \sin(\tfrac{1}{2}\pi s)) \Gamma^{(r)}(s) \zeta^{(m-r)}(s), \end{aligned}$$

where

$$25.4.6 \quad c = -\ln(2\pi) - \frac{1}{2}\pi i.$$

## 25.5 Integral Representations

### 25.5(i) In Terms of Elementary Functions

Throughout this subsection  $s \neq 1$ .

$$25.5.7 \quad \zeta(s) = \frac{1}{2} + \frac{1}{s-1} + \sum_{m=1}^n \frac{B_{2m}}{(2m)!} \frac{\Gamma(s+2m-1)}{\Gamma(s)} + \frac{1}{\Gamma(s)} \int_0^\infty \left( \frac{1}{e^x-1} - \frac{1}{x} + \frac{1}{2} - \sum_{m=1}^n \frac{B_{2m}}{(2m)!} x^{2m-1} \right) \frac{x^{s-1}}{e^x} dx, \\ \Re s > -(2n+1), n = 1, 2, 3, \dots$$

$$25.5.8 \quad \zeta(s) = \frac{1}{2(1-2^{-s})\Gamma(s)} \int_0^\infty \frac{x^{s-1}}{\sinh x} dx, \quad \Re s > 1.$$

$$25.5.9 \quad \zeta(s) = \frac{2^{s-1}}{\Gamma(s+1)} \int_0^\infty \frac{x^s}{(\sinh x)^2} dx, \quad \Re s > 1.$$

$$25.5.10 \quad \zeta(s) = \frac{2^{s-1}}{1-2^{1-s}} \int_0^\infty \frac{\cos(s \arctan x)}{(1+x^2)^{s/2} \cosh(\frac{1}{2}\pi x)} dx.$$

$$25.5.11 \quad \zeta(s) = \frac{1}{2} + \frac{1}{s-1} + 2 \int_0^\infty \frac{\sin(s \arctan x)}{(1+x^2)^{s/2} (e^{2\pi x} - 1)} dx.$$

$$25.5.12 \quad \zeta(s) = \frac{2^{s-1}}{s-1} - 2^s \int_0^\infty \frac{\sin(s \arctan x)}{(1+x^2)^{s/2} (e^{\pi x} + 1)} dx.$$

### 25.5(ii) In Terms of Other Functions

$$25.5.13 \quad \begin{aligned} \zeta(s) &= \frac{\pi^{s/2}}{s(s-1)\Gamma(\frac{1}{2}s)} \\ & \quad + \frac{\pi^{s/2}}{\Gamma(\frac{1}{2}s)} \int_1^\infty \left( x^{s/2} + x^{(1-s)/2} \right) \frac{\omega(x)}{x} dx, \\ & \quad s \neq 1, \end{aligned}$$

where

$$25.5.14 \quad \omega(x) = \sum_{n=1}^\infty e^{-n^2\pi x} = \frac{1}{2} (\theta_3(0|ix) - 1).$$

$$25.5.1 \quad \zeta(s) = \frac{1}{\Gamma(s)} \int_0^\infty \frac{x^{s-1}}{e^x-1} dx, \quad \Re s > 1.$$

$$25.5.2 \quad \zeta(s) = \frac{1}{\Gamma(s+1)} \int_0^\infty \frac{e^x x^s}{(e^x-1)^2} dx, \quad \Re s > 1.$$

$$25.5.3 \quad \zeta(s) = \frac{1}{(1-2^{1-s})\Gamma(s)} \int_0^\infty \frac{x^{s-1}}{e^x+1} dx, \quad \Re s > 0.$$

$$25.5.4 \quad \zeta(s) = \frac{1}{(1-2^{1-s})\Gamma(s+1)} \int_0^\infty \frac{e^x x^s}{(e^x+1)^2} dx, \\ \Re s > 0.$$

$$25.5.5 \quad \zeta(s) = -s \int_0^\infty \frac{x - [x] - \frac{1}{2}}{x^{s+1}} dx, \quad -1 < \Re s < 0.$$

$$25.5.6 \quad \zeta(s) = \frac{1}{2} + \frac{1}{s-1} + \frac{1}{\Gamma(s)} \int_0^\infty \left( \frac{1}{e^x-1} - \frac{1}{x} + \frac{1}{2} \right) \frac{x^{s-1}}{e^x} dx, \\ \Re s > -1.$$

For  $\theta_3$  see §20.2(i). For similar representations involving other theta functions see Erdélyi *et al.* (1954a, p. 339).

In (25.5.15)–(25.5.19),  $0 < \Re s < 1$ ,  $\psi(x)$  is the digamma function, and  $\gamma$  is Euler's constant (§5.2). (25.5.16) is also valid for  $0 < \Re s < 2$ ,  $s \neq 1$ .

$$25.5.15 \quad \begin{aligned} \zeta(s) &= \frac{1}{s-1} + \frac{\sin(\pi s)}{\pi} \\ & \quad \times \int_0^\infty (\ln(1+x) - \psi(1+x)) x^{-s} dx, \end{aligned}$$

$$25.5.16 \quad \begin{aligned} \zeta(s) &= \frac{1}{s-1} + \frac{\sin(\pi s)}{\pi(s-1)} \\ & \quad \times \int_0^\infty \left( \frac{1}{1+x} - \psi'(1+x) \right) x^{1-s} dx, \end{aligned}$$

$$25.5.17 \quad \zeta(1+s) = \frac{\sin(\pi s)}{\pi} \int_0^\infty (\gamma + \psi(1+x)) x^{-s-1} dx,$$

$$25.5.18 \quad \zeta(1+s) = \frac{\sin(\pi s)}{\pi s} \int_0^\infty \psi'(1+x) x^{-s} dx,$$

$$25.5.19 \quad \begin{aligned} \zeta(m+s) &= (-1)^{m-1} \frac{\Gamma(s)\sin(\pi s)}{\pi\Gamma(m+s)} \\ & \quad \times \int_0^\infty \psi^{(m)}(1+x) x^{-s} dx, \\ & \quad m = 1, 2, 3, \dots \end{aligned}$$

**25.5(iii) Contour Integrals**

25.5.20

$$\zeta(s) = \frac{\Gamma(1-s)}{2\pi i} \int_{-\infty}^{(0+)} \frac{z^{s-1}}{e^{-z}-1} dz, \quad s \neq 1, 2, \dots,$$

where the integration contour is a loop around the negative real axis; it starts at  $-\infty$ , encircles the origin once in the positive direction without enclosing any of the points  $z = \pm 2\pi i, \pm 4\pi i, \dots$ , and returns to  $-\infty$ . Equivalently,

25.5.21

$$\zeta(s) = \frac{\Gamma(1-s)}{2\pi i(1-2^{1-s})} \int_{-\infty}^{(0+)} \frac{z^{s-1}}{e^{-z}+1} dz, \quad s \neq 1, 2, \dots$$

The contour here is any loop that encircles the origin in the positive direction not enclosing any of the points  $\pm \pi i, \pm 3\pi i, \dots$ .

**25.6 Integer Arguments**

**25.6(i) Function Values**

25.6.1

$$\zeta(0) = -\frac{1}{2}, \quad \zeta(2) = \frac{\pi^2}{6}, \quad \zeta(4) = \frac{\pi^4}{90}, \quad \zeta(6) = \frac{\pi^6}{945}.$$

25.6.2  $\zeta(2n) = \frac{(2\pi)^{2n}}{2(2n)!} |B_{2n}|, \quad n = 1, 2, 3, \dots$

25.6.3  $\zeta(-n) = -\frac{B_{n+1}}{n+1}, \quad n = 1, 2, 3, \dots$

25.6.4  $\zeta(-2n) = 0, \quad n = 1, 2, 3, \dots$

With  $c$  defined by (25.4.6) and  $n = 1, 2, 3, \dots$ ,

25.6.13 
$$(-1)^k \zeta^{(k)}(-2n) = \frac{2(-1)^n}{(2\pi)^{2n+1}} \sum_{m=0}^k \sum_{r=0}^m \binom{k}{m} \binom{m}{r} \Im(c^{k-m}) \Gamma^{(r)}(2n+1) \zeta^{(m-r)}(2n+1),$$

25.6.14 
$$(-1)^k \zeta^{(k)}(1-2n) = \frac{2(-1)^n}{(2\pi)^{2n}} \sum_{m=0}^k \sum_{r=0}^m \binom{k}{m} \binom{m}{r} \Re(c^{k-m}) \Gamma^{(r)}(2n) \zeta^{(m-r)}(2n),$$

25.6.15 
$$\zeta'(2n) = \frac{(-1)^{n+1}(2\pi)^{2n}}{2(2n)!} (2n \zeta'(1-2n) - (\psi(2n) - \ln(2\pi)) B_{2n}).$$

**25.6(iii) Recursion Formulas**

25.6.16 
$$(n + \frac{1}{2}) \zeta(2n) = \sum_{k=1}^{n-1} \zeta(2k) \zeta(2n-2k), \quad n \geq 2.$$

25.6.17 
$$(n + \frac{3}{4}) \zeta(4n+2) = \sum_{k=1}^n \zeta(2k) \zeta(4n+2-2k), \quad n \geq 1.$$

25.6.5

$$\zeta(k+1) = \frac{1}{k!} \sum_{n_1=1}^{\infty} \dots \sum_{n_k=1}^{\infty} \frac{1}{n_1 \dots n_k (n_1 + \dots + n_k)}, \quad k = 1, 2, 3, \dots$$

25.6.6

$$\zeta(2k+1) = \frac{(-1)^{k+1}(2\pi)^{2k+1}}{2(2k+1)!} \int_0^1 B_{2k+1}(t) \cot(\pi t) dt, \quad k = 1, 2, 3, \dots$$

25.6.7 
$$\zeta(2) = \int_0^1 \int_0^1 \frac{1}{1-xy} dx dy.$$

25.6.8 
$$\zeta(2) = 3 \sum_{k=1}^{\infty} \frac{1}{k^2 \binom{2k}{k}}.$$

25.6.9 
$$\zeta(3) = \frac{5}{2} \sum_{k=1}^{\infty} \frac{(-1)^{k-1}}{k^3 \binom{2k}{k}}.$$

25.6.10 
$$\zeta(4) = \frac{36}{17} \sum_{k=1}^{\infty} \frac{1}{k^4 \binom{2k}{k}}.$$

**25.6(ii) Derivative Values**

25.6.11 
$$\zeta'(0) = -\frac{1}{2} \ln(2\pi).$$

25.6.12 
$$\zeta''(0) = -\frac{1}{2}(\ln(2\pi))^2 + \frac{1}{2}\gamma^2 - \frac{1}{24}\pi^2 + \gamma_1,$$
 where  $\gamma_1$  is given by (25.2.5).

25.6.18

$$(n + \frac{1}{4}) \zeta(4n) + \frac{1}{2}(\zeta(2n))^2 = \sum_{k=1}^n \zeta(2k) \zeta(4n-2k), \quad n \geq 1.$$

$$(m + n + \frac{3}{2}) \zeta(2m+2n+2)$$

25.6.19 
$$= \left( \sum_{k=1}^m + \sum_{k=1}^n \right) \zeta(2k) \zeta(2m+2n+2-2k), \quad m \geq 0, n \geq 0, m+n \geq 1.$$

## 25.6.20

$$\frac{1}{2}(2^{2n} - 1)\zeta(2n) = \sum_{k=1}^{n-1} (2^{2n-2k} - 1)\zeta(2n - 2k)\zeta(2k),$$

$$n \geq 2.$$

For related results see Basu and Apostol (2000).

## 25.7 Integrals

For definite integrals of the Riemann zeta function see Prudnikov *et al.* (1986b, §2.4), Prudnikov *et al.* (1992a, §3.2), and Prudnikov *et al.* (1992b, §3.2).

## 25.8 Sums

$$25.8.1 \quad \sum_{k=2}^{\infty} (\zeta(k) - 1) = 1.$$

$$25.8.2 \quad \sum_{k=0}^{\infty} \frac{\Gamma(s+k)}{(k+1)!} (\zeta(s+k) - 1) = \Gamma(s-1), \quad s \neq 1, 0, -1, -2, \dots$$

$$25.8.3 \quad \sum_{k=0}^{\infty} \frac{\Gamma(s+k)\zeta(s+k)}{k!\Gamma(s)2^{s+k}} = (1-2^{-s})\zeta(s), \quad s \neq 1.$$

$$25.8.4 \quad \sum_{k=1}^{\infty} \frac{(-1)^k}{k} (\zeta(nk) - 1) = \ln \left( \prod_{j=0}^{n-1} \Gamma \left( 2 - e^{(2j+1)\pi i/n} \right) \right),$$

$$n = 2, 3, 4, \dots$$

$$25.8.5 \quad \sum_{k=2}^{\infty} \zeta(k)z^k = -\gamma z - z\psi(1-z), \quad |z| < 1.$$

$$25.8.6 \quad \sum_{k=0}^{\infty} \zeta(2k)z^{2k} = -\frac{1}{2}\pi z \cot(\pi z), \quad |z| < 1.$$

$$25.8.7 \quad \sum_{k=2}^{\infty} \frac{\zeta(k)}{k} z^k = -\gamma z + \ln \Gamma(1-z), \quad |z| < 1.$$

$$25.8.8 \quad \sum_{k=1}^{\infty} \frac{\zeta(2k)}{k} z^{2k} = \ln \left( \frac{\pi z}{\sin(\pi z)} \right), \quad |z| < 1.$$

$$25.8.9 \quad \sum_{k=1}^{\infty} \frac{\zeta(2k)}{(2k+1)2^{2k}} = \frac{1}{2} - \frac{1}{2} \ln 2.$$

$$25.8.10 \quad \sum_{k=1}^{\infty} \frac{\zeta(2k)}{(2k+1)(2k+2)2^{2k}} = \frac{1}{4} - \frac{7}{4\pi^2} \zeta(3).$$

For other sums see Prudnikov *et al.* (1986b, pp. 648–649), Hansen (1975, pp. 355–357), Ogreid and Osland (1998), and Srivastava and Choi (2001, Chapter 3).

## 25.9 Asymptotic Approximations

If  $x \geq 1$ ,  $y \geq 1$ ,  $2\pi xy = t$ , and  $0 \leq \sigma \leq 1$ , then as  $t \rightarrow \infty$  with  $\sigma$  fixed,

$$25.9.1 \quad \zeta(\sigma + it) = \sum_{1 \leq n \leq x} \frac{1}{n^\sigma} + \chi(s) \sum_{1 \leq n \leq y} \frac{1}{n^{1-s}} + O(x^{-\sigma}) + O(y^{\sigma-1}t^{\frac{1}{2}-\sigma}),$$

where  $s = \sigma + it$  and

$$25.9.2 \quad \chi(s) = \pi^{s-\frac{1}{2}} \Gamma\left(\frac{1}{2} - \frac{1}{2}s\right) / \Gamma\left(\frac{1}{2}s\right).$$

If  $\sigma = \frac{1}{2}$ ,  $x = y = \sqrt{t/(2\pi)}$ , and  $m = \lfloor x \rfloor$ , then (25.9.1) becomes

$$25.9.3 \quad \zeta\left(\frac{1}{2} + it\right) = \sum_{n=1}^m \frac{1}{n^{\frac{1}{2}+it}} + \chi\left(\frac{1}{2} + it\right) \sum_{n=1}^m \frac{1}{n^{\frac{1}{2}-it}} + O(t^{-1/4}).$$

For other asymptotic approximations see Berry and Keating (1992), Paris and Cang (1997); see also Paris and Kaminski (2001, pp. 380–389).

## 25.10 Zeros

## 25.10(i) Distribution

The product representation (25.2.11) implies  $\zeta(s) \neq 0$  for  $\Re s > 1$ . Also,  $\zeta(s) \neq 0$  for  $\Re s = 1$ , a property first established in Hadamard (1896) and de la Vallée Poussin (1896a,b) in the proof of the prime number theorem (25.16.3). The functional equation (25.4.1) implies  $\zeta(-2n) = 0$  for  $n = 1, 2, 3, \dots$ . These are called the *trivial zeros*. Except for the trivial zeros,  $\zeta(s) \neq 0$  for  $\Re s \leq 0$ . In the region  $0 < \Re s < 1$ , called the *critical strip*,  $\zeta(s)$  has infinitely many zeros, distributed symmetrically about the real axis and about the *critical line*  $\Re s = \frac{1}{2}$ . The *Riemann hypothesis* states that all nontrivial zeros lie on this line.

Calculations relating to the zeros on the critical line make use of the real-valued function

$$25.10.1 \quad Z(t) = \exp(i\vartheta(t)) \zeta\left(\frac{1}{2} + it\right),$$

where

$$25.10.2 \quad \vartheta(t) \equiv \text{ph} \Gamma\left(\frac{1}{4} + \frac{1}{2}it\right) - \frac{1}{2}t \ln \pi$$

is chosen to make  $Z(t)$  real, and  $\text{ph} \Gamma\left(\frac{1}{4} + \frac{1}{2}it\right)$  assumes its principal value. Because  $|Z(t)| = |\zeta\left(\frac{1}{2} + it\right)|$ ,  $Z(t)$  vanishes at the zeros of  $\zeta\left(\frac{1}{2} + it\right)$ , which can be separated by observing sign changes of  $Z(t)$ . Because  $Z(t)$  changes sign infinitely often,  $\zeta\left(\frac{1}{2} + it\right)$  has infinitely many zeros with  $t$  real.

**25.10(ii) Riemann–Siegel Formula**

Riemann developed a method for counting the total number  $N(T)$  of zeros of  $\zeta(s)$  in that portion of the critical strip with  $0 < t < T$ . By comparing  $N(T)$  with the number of sign changes of  $Z(t)$  we can decide whether  $\zeta(s)$  has any zeros off the line in this region. Sign changes of  $Z(t)$  are determined by multiplying (25.9.3) by  $\exp(i\vartheta(t))$  to obtain the *Riemann–Siegel formula*:

$$25.10.3 \quad Z(t) = 2 \sum_{n=1}^m \frac{\cos(\vartheta(t) - t \ln n)}{n^{1/2}} + R(t),$$

where  $R(t) = O(t^{-1/4})$  as  $t \rightarrow \infty$ .

The error term  $R(t)$  can be expressed as an asymptotic series that begins

**25.10.4**

$$R(t) = (-1)^{m-1} \left(\frac{2\pi}{t}\right)^{1/4} \frac{\cos\left(t - (2m+1)\sqrt{2\pi t} - \frac{1}{8}\pi\right)}{\cos(\sqrt{2\pi t})} + O\left(t^{-3/4}\right).$$

Riemann also developed a technique for determining further terms. Calculations based on the Riemann–Siegel formula reveal that the first ten billion zeros of  $\zeta(s)$  in the critical strip are on the critical line (van de Lune *et al.* (1986)). More than one-third of all the zeros in the critical strip lie on the critical line (Levinson (1974)).

For further information on the Riemann–Siegel expansion see Berry (1995).

**25.11(ii) Graphics**

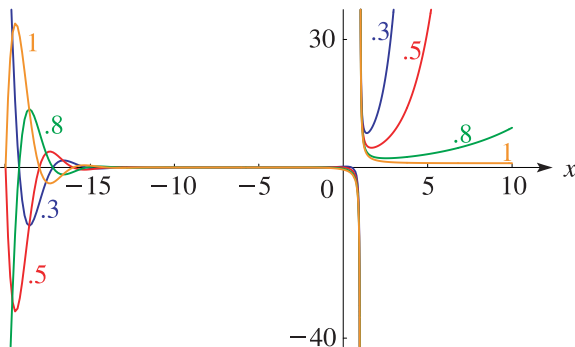


Figure 25.11.1: Hurwitz zeta function  $\zeta(x, a)$ ,  $a = 0.3, 0.5, 0.8, 1$ ,  $-20 \leq x \leq 10$ . The curves are almost indistinguishable for  $-14 < x < -1$ , approximately.

**Related Functions**

**25.11 Hurwitz Zeta Function**

**25.11(i) Definition**

The function  $\zeta(s, a)$  was introduced in Hurwitz (1882) and defined by the series expansion

**25.11.1**

$$\zeta(s, a) = \sum_{n=0}^{\infty} \frac{1}{(n+a)^s}, \quad \Re s > 1, a \neq 0, -1, -2, \dots$$

$\zeta(s, a)$  has a meromorphic continuation in the  $s$ -plane, its only singularity in  $\mathbb{C}$  being a simple pole at  $s = 1$  with residue 1. As a function of  $a$ , with  $s (\neq 1)$  fixed,  $\zeta(s, a)$  is analytic in the half-plane  $\Re a > 0$ . The Riemann zeta function is a special case:

**25.11.2**

$$\zeta(s, 1) = \zeta(s).$$

For most purposes it suffices to restrict  $0 < \Re a \leq 1$  because of the following straightforward consequences of (25.11.1):

**25.11.3**

$$\zeta(s, a) = \zeta(s, a+1) + a^{-s},$$

**25.11.4**

$$\zeta(s, a) = \zeta(s, a+m) + \sum_{n=0}^{m-1} \frac{1}{(n+a)^s}, \quad m = 1, 2, 3, \dots$$

Most references treat real  $a$  with  $0 < a \leq 1$ .

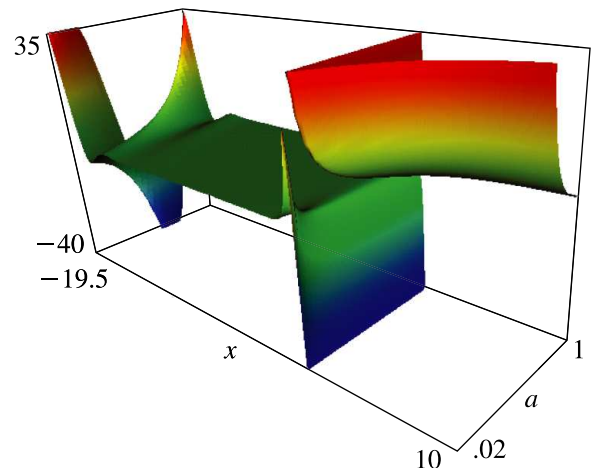


Figure 25.11.2: Hurwitz zeta function  $\zeta(x, a)$ ,  $-19.5 \leq x \leq 10$ ,  $0.02 \leq a \leq 1$ .



**25.11(iii) Representations by the Euler–Maclaurin Formula**

**25.11.5** 
$$\zeta(s, a) = \sum_{n=0}^N \frac{1}{(n+a)^s} + \frac{(N+a)^{1-s}}{s-1} - s \int_N^\infty \frac{x - [x]}{(x+a)^{s+1}} dx, \quad s \neq 1, \Re s > 0, a > 0, N = 0, 1, 2, 3, \dots$$

**25.11.6** 
$$\zeta(s, a) = \frac{1}{a^s} \left( \frac{1}{2} + \frac{a}{s-1} \right) - s(s+1) \int_0^\infty \frac{\tilde{B}_2(x)}{(x+a)^{s+2}} dx, \quad s \neq 1, \Re s > -1, a > 0.$$

**25.11.7** 
$$\zeta(s, a) = \frac{1}{a^s} + \frac{1}{(1+a)^s} \left( \frac{1}{2} + \frac{1+a}{s-1} \right) + \sum_{k=1}^n \binom{s+2k-2}{2k-1} \frac{B_{2k}}{2k} \frac{1}{(1+a)^{s+2k-1}} - \binom{s+2n}{2n+1} \int_1^\infty \frac{\tilde{B}_{2n+1}(x)}{(x+a)^{s+2n+1}} dx,$$
  
 $s \neq 1, a > 0, n = 1, 2, 3, \dots, \Re s > -2n.$

For  $\tilde{B}_n(x)$  see §24.2(iii).

**25.11(iv) Series Representations**

**25.11.8** 
$$\zeta\left(s, \frac{1}{2}a\right) = \zeta\left(s, \frac{1}{2}a + \frac{1}{2}\right) + 2^s \sum_{n=0}^\infty \frac{(-1)^n}{(n+a)^s},$$
  
 $\Re s > 0, s \neq 1, 0 < a \leq 1.$

**25.11.9** 
$$\zeta(1-s, a) = \frac{2\Gamma(s)}{(2\pi)^s} \sum_{n=1}^\infty \frac{1}{n^s} \cos\left(\frac{1}{2}\pi s - 2n\pi a\right),$$
  
 $\Re s > 1, 0 < a \leq 1.$

**25.11.10** 
$$\zeta(s, a) = \sum_{n=0}^\infty \frac{\Gamma(n+s)}{n! \Gamma(s)} \zeta(n+s)(1-a)^n,$$
  
 $s \neq 1, |a-1| < 1.$

When  $a = \frac{1}{2}$ , (25.11.10) reduces to (25.8.3); compare (25.11.11).

**25.11(v) Special Values**

Throughout this subsection  $\Re a > 0$ .

**25.11.11** 
$$\zeta\left(s, \frac{1}{2}\right) = (2^s - 1)\zeta(s), \quad s \neq 1.$$

**25.11.12** 
$$\zeta(n+1, a) = \frac{(-1)^{n+1} \psi^{(n)}(a)}{n!}, \quad n = 1, 2, 3, \dots$$

**25.11.13** 
$$\zeta(0, a) = \frac{1}{2} - a.$$

**25.11.14** 
$$\zeta(-n, a) = -\frac{B_{n+1}(a)}{n+1}, \quad n = 0, 1, 2, \dots$$

**25.11.15** 
$$\zeta(s, ka) = k^{-s} \sum_{n=0}^{k-1} \zeta\left(s, a + \frac{n}{k}\right), \quad s \neq 1, k = 1, 2, 3, \dots$$

**25.11.16** 
$$\zeta\left(1-s, \frac{h}{k}\right) = \frac{2\Gamma(s)}{(2\pi k)^s} \sum_{r=1}^k \cos\left(\frac{\pi s}{2} - \frac{2\pi r h}{k}\right) \zeta\left(s, \frac{r}{k}\right),$$
  
 $s \neq 0, 1; h, k \text{ integers}, 1 \leq h \leq k.$

**25.11(vi) Derivatives**

**a-Derivative**

**25.11.17** 
$$\frac{\partial}{\partial a} \zeta(s, a) = -s\zeta(s+1, a), \quad s \neq 0, 1; \Re a > 0.$$

**s-Derivatives**

In (25.11.18)–(25.11.24) primes on  $\zeta$  denote derivatives with respect to  $s$ . Similarly in §§25.11(viii) and 25.11(xii).

**25.11.18** 
$$\zeta'(0, a) = \ln \Gamma(a) - \frac{1}{2} \ln(2\pi), \quad a > 0.$$

**25.11.19** 
$$\zeta'(s, a) = -\frac{\ln a}{a^s} \left( \frac{1}{2} + \frac{a}{s-1} \right) - \frac{a^{1-s}}{(s-1)^2} + s(s+1) \int_0^\infty \frac{\tilde{B}_2(x) \ln(x+a)}{(x+a)^{s+2}} dx - (2s+1) \int_0^\infty \frac{\tilde{B}_2(x)}{(x+a)^{s+2}} dx,$$
  
 $\Re s > -1, s \neq 1, a > 0.$

**25.11.20** 
$$(-1)^k \zeta^{(k)}(s, a) = \frac{(\ln a)^k}{a^s} \left( \frac{1}{2} + \frac{a}{s-1} \right) + k! a^{1-s} \sum_{r=0}^{k-1} \frac{(\ln a)^r}{r!(s-1)^{k-r+1}} - s(s+1) \int_0^\infty \frac{\tilde{B}_2(x) (\ln(x+a))^k}{(x+a)^{s+2}} dx$$
  
 $+ k(2s+1) \int_0^\infty \frac{\tilde{B}_2(x) (\ln(x+a))^{k-1}}{(x+a)^{s+2}} dx - k(k-1) \int_0^\infty \frac{\tilde{B}_2(x) (\ln(x+a))^{k-2}}{(x+a)^{s+2}} dx,$   
 $\Re s > -1, s \neq 1, a > 0.$

25.11.21

$$\zeta' \left( 1 - 2n, \frac{h}{k} \right) = \frac{(\psi(2n) - \ln(2\pi k)) B_{2n}(h/k)}{2n} - \frac{(\psi(2n) - \ln(2\pi)) B_{2n}}{2nk^{2n}} + \frac{(-1)^{n+1} \pi}{(2\pi k)^{2n}} \sum_{r=1}^{k-1} \sin \left( \frac{2\pi r h}{k} \right) \psi^{(2n-1)} \left( \frac{r}{k} \right) + \frac{(-1)^{n+1} 2 \cdot (2n-1)!}{(2\pi k)^{2n}} \sum_{r=1}^{k-1} \cos \left( \frac{2\pi r h}{k} \right) \zeta' \left( 2n, \frac{r}{k} \right) + \frac{\zeta'(1-2n)}{k^{2n}},$$

where  $h, k$  are integers with  $1 \leq h \leq k$  and  $n = 1, 2, 3, \dots$

25.11.22 
$$\zeta'(1-2n, \frac{1}{2}) = -\frac{B_{2n} \ln 2}{n \cdot 4^n} - \frac{(2^{2n-1} - 1) \zeta'(1-2n)}{2^{2n-1}}, \quad n = 1, 2, 3, \dots$$

25.11.23

$$\zeta'(1-2n, \frac{1}{3}) = -\frac{\pi(9^n - 1) B_{2n}}{8n\sqrt{3}(3^{2n-1} - 1)} - \frac{B_{2n} \ln 3}{4n \cdot 3^{2n-1}} - \frac{(-1)^n \psi^{(2n-1)}(\frac{1}{3})}{2\sqrt{3}(6\pi)^{2n-1}} - \frac{(3^{2n-1} - 1) \zeta'(1-2n)}{2 \cdot 3^{2n-1}}, \quad n = 1, 2, 3, \dots$$

25.11.24 
$$\sum_{r=1}^{k-1} \zeta' \left( s, \frac{r}{k} \right) = (k^s - 1) \zeta'(s) + k^s \zeta(s) \ln k, \quad s \neq 1, k = 1, 2, 3, \dots$$

25.11(vii) Integral Representations

25.11.25 
$$\zeta(s, a) = \frac{1}{\Gamma(s)} \int_0^\infty \frac{x^{s-1} e^{-ax}}{1 - e^{-x}} dx, \quad \Re s > 1, \Re a > 0.$$

25.11.26 
$$\zeta(s, a) = -s \int_{-a}^\infty \frac{x - [x] - \frac{1}{2}}{(x+a)^{s+1}} dx, \quad -1 < \Re s < 0, 0 < a \leq 1.$$

25.11.27 
$$\zeta(s, a) = \frac{1}{2} a^{-s} + \frac{a^{1-s}}{s-1} + \frac{1}{\Gamma(s)} \int_0^\infty \left( \frac{1}{e^x - 1} - \frac{1}{x} + \frac{1}{2} \right) \frac{x^{s-1}}{e^{ax}} dx, \quad \Re s > -1, s \neq 1, \Re a > 0.$$

25.11.28 
$$\zeta(s, a) = \frac{1}{2} a^{-s} + \frac{a^{1-s}}{s-1} + \sum_{k=1}^n \frac{\Gamma(s+2k-1)}{\Gamma(s)} \frac{B_{2k}}{(2k)!} a^{-2k-s+1} + \frac{1}{\Gamma(s)} \int_0^\infty \left( \frac{1}{e^x - 1} - \frac{1}{x} + \frac{1}{2} - \sum_{k=1}^n \frac{B_{2k}}{(2k)!} x^{2k-1} \right) x^{s-1} e^{-ax} dx, \quad \Re s > -(2n+1), s \neq 1, \Re a > 0.$$

25.11.29 
$$\zeta(s, a) = \frac{1}{2} a^{-s} + \frac{a^{1-s}}{s-1} + 2 \int_0^\infty \frac{\sin(s \arctan(x/a))}{(a^2 + x^2)^{s/2} (e^{2\pi x} - 1)} dx, \quad s \neq 1, \Re a > 0.$$

25.11.30 
$$\zeta(s, a) = \frac{\Gamma(1-s)}{2\pi i} \int_{-\infty}^{(0+)} \frac{e^{az} z^{s-1}}{1 - e^z} dz, \quad s \neq 1, \Re a > 0,$$

where the integration contour is a loop around the negative real axis as described for (25.5.20).

25.11(viii) Further Integral Representations

25.11.31 
$$\frac{1}{\Gamma(s)} \int_0^\infty \frac{x^{s-1} e^{-ax}}{2 \cosh x} dx = 4^{-s} \left( \zeta \left( s, \frac{1}{4} + \frac{1}{4}a \right) - \zeta \left( s, \frac{3}{4} + \frac{1}{4}a \right) \right), \quad \Re s > 0, \Re a > -1.$$

25.11.32 
$$\int_0^a x^n \psi(x) dx = (-1)^{n-1} \zeta'(-n) + (-1)^n h(n) \frac{B_{n+1}}{n+1} - \sum_{k=0}^n (-1)^k \binom{n}{k} h(k) \frac{B_{k+1}(a)}{k+1} a^{n-k} + \sum_{k=0}^n (-1)^k \binom{n}{k} \zeta'(-k, a) a^{n-k}, \quad n = 1, 2, \dots, \Re a > 0,$$

where

25.11.33 
$$h(n) = \sum_{k=1}^n k^{-1}.$$

25.11.34 
$$\int_0^a \zeta'(1-n, x) dx = \zeta'(-n, a) - \zeta'(-n) + \frac{B_{n+1} - B_{n+1}(a)}{n(n+1)}, \quad n = 1, 2, \dots, \Re a > 0.$$

**25.11(ix) Integrals**

See Prudnikov *et al.* (1990, §2.3), Prudnikov *et al.* (1992a, §3.2), and Prudnikov *et al.* (1992b, §3.2).

**25.11(x) Further Series Representations**

**25.11.35**

$$\begin{aligned} & \sum_{n=0}^{\infty} \frac{(-1)^n}{(n+a)^s} \\ &= \frac{1}{\Gamma(s)} \int_0^{\infty} \frac{x^{s-1} e^{-ax}}{1+e^{-x}} dx \\ &= 2^{-s} \left( \zeta\left(s, \frac{1}{2}a\right) - \zeta\left(s, \frac{1}{2}(1+a)\right) \right), \\ & \Re a > 0, \Re s > 0; \text{ or } \Re a = 0, \Im a \neq 0, 0 < \Re s < 1. \end{aligned}$$

When  $a = 1$ , (25.11.35) reduces to (25.2.3).

**25.11.36** 
$$\sum_{n=1}^{\infty} \frac{\chi(n)}{n^s} = k^{-s} \sum_{r=1}^k \chi(r) \zeta\left(s, \frac{r}{k}\right), \quad \Re s > 1,$$

where  $\chi(n)$  is a Dirichlet character (mod  $k$ ) (§27.8).

See also Srivastava and Choi (2001).

**25.11(xi) Sums**

**25.11.37**

$$\begin{aligned} \sum_{k=1}^{\infty} \frac{(-1)^k}{k} \zeta(nk, a) &= -n \ln \Gamma(a) \\ &+ \ln \left( \prod_{j=0}^{n-1} \Gamma\left(a - e^{(2j+1)\pi i/n}\right) \right), \\ & n = 2, 3, 4, \dots, \Re a \geq 1. \end{aligned}$$

**25.11.38** 
$$\begin{aligned} & \sum_{k=1}^{\infty} \binom{n+k}{k} \zeta(n+k+1, a) z^k \\ &= \frac{(-1)^n}{n!} \left( \psi^{(n)}(a) - \psi^{(n)}(a-z) \right), \\ & n = 1, 2, 3, \dots, \Re a > 0, |z| < |a|. \end{aligned}$$

**25.11.39** 
$$\sum_{k=2}^{\infty} \frac{k}{2^k} \zeta\left(k+1, \frac{3}{4}\right) = 8G,$$

where  $G$  is Catalan's constant:

**25.11.40** 
$$G = \sum_{n=0}^{\infty} \frac{(-1)^n}{(2n+1)^2} = 0.91596\ 55941\ 772\dots$$

For further sums see Prudnikov *et al.* (1990, pp. 396–397) and Hansen (1975, pp. 358–360).

**25.11(xii)  $a$ -Asymptotic Behavior**

As  $a \rightarrow 0$  with  $s (\neq 1)$  fixed,

**25.11.41** 
$$\zeta(s, a+1) = \zeta(s) - s\zeta(s+1)a + O(a^2).$$

As  $\beta \rightarrow \pm\infty$  with  $s$  fixed,  $\Re s > 1$ ,

**25.11.42** 
$$\zeta(s, \alpha + i\beta) \rightarrow 0,$$

uniformly with respect to bounded nonnegative values of  $\alpha$ .

As  $a \rightarrow \infty$  in the sector  $|\text{ph } a| \leq \pi - \delta (< \pi)$ , with  $s (\neq 1)$  and  $\delta$  fixed, we have the asymptotic expansion

**25.11.43**

$$\zeta(s, a) - \frac{a^{1-s}}{s-1} - \frac{1}{2}a^{-s} \sim \sum_{k=1}^{\infty} \frac{B_{2k}}{(2k)!} \frac{\Gamma(s+2k-1)}{\Gamma(s)} a^{1-s-2k}.$$

Similarly, as  $a \rightarrow \infty$  in the sector  $|\text{ph } a| \leq \frac{1}{2}\pi - \delta (< \frac{1}{2}\pi)$ ,

$$\zeta'(-1, a) - \frac{1}{12} + \frac{1}{4}a^2 - \left( \frac{1}{12} - \frac{1}{2}a + \frac{1}{2}a^2 \right) \ln a$$

**25.11.44**

$$\sim - \sum_{k=1}^{\infty} \frac{B_{2k+2}}{(2k+2)(2k+1)2k} a^{-2k},$$

and

$$\zeta'(-2, a) - \frac{1}{12}a + \frac{1}{9}a^3 - \left( \frac{1}{6}a - \frac{1}{2}a^2 + \frac{1}{3}a^3 \right) \ln a$$

**25.11.45**

$$\sim \sum_{k=1}^{\infty} \frac{2B_{2k+2}}{(2k+2)(2k+1)2k(2k-1)} a^{-(2k-1)}.$$

For the more general case  $\zeta'(-m, a)$ ,  $m = 1, 2, \dots$ , see Elizalde (1986).

For an exponentially-improved form of (25.11.43) see Paris (2005b).

**25.12 Polylogarithms**

**25.12(i) Dilogarithms**

The notation  $\text{Li}_2(z)$  was introduced in Lewin (1981) for a function discussed in Euler (1768) and called the *dilogarithm* in Hill (1828):

**25.12.1** 
$$\text{Li}_2(z) = \sum_{n=1}^{\infty} \frac{z^n}{n^2}, \quad |z| \leq 1.$$

**25.12.2** 
$$\text{Li}_2(z) = - \int_0^z t^{-1} \ln(1-t) dt, \quad z \in \mathbb{C} \setminus (1, \infty).$$

Other notations and names for  $\text{Li}_2(z)$  include  $S_2(z)$  (Kölbig *et al.* (1970)), Spence function  $\text{Sp}(z)$  ('t Hooft and Veltman (1979)), and  $L_2(z)$  (Maximon (2003)).

In the complex plane  $\text{Li}_2(z)$  has a branch point at  $z = 1$ . The principal branch has a cut along the interval  $[1, \infty)$  and agrees with (25.12.1) when  $|z| \leq 1$ ; see also §4.2(i). The remainder of the equations in this subsection apply to principal branches.

**25.12.3**

$$\text{Li}_2(z) + \text{Li}_2\left(\frac{z}{z-1}\right) = -\frac{1}{2}(\ln(1-z))^2, \quad z \in \mathbb{C} \setminus [1, \infty).$$

**25.12.4**

$$\text{Li}_2(z) + \text{Li}_2\left(\frac{1}{z}\right) = -\frac{1}{6}\pi^2 - \frac{1}{2}(\ln(-z))^2, \quad z \in \mathbb{C} \setminus [0, \infty).$$

**25.12.5**

$$\text{Li}_2(z^m) = m \sum_{k=0}^{m-1} \text{Li}_2\left(ze^{2\pi ik/m}\right),$$

$m = 1, 2, 3, \dots, |z| < 1.$

**25.12.6**

$$\operatorname{Li}_2(x) + \operatorname{Li}_2(1-x) = \frac{1}{6}\pi^2 - (\ln x)\ln(1-x), \quad 0 < x < 1.$$

When  $z = e^{i\theta}$ ,  $0 \leq \theta \leq 2\pi$ , (25.12.1) becomes

$$\mathbf{25.12.7} \quad \operatorname{Li}_2(e^{i\theta}) = \sum_{n=1}^{\infty} \frac{\cos(n\theta)}{n^2} + i \sum_{n=1}^{\infty} \frac{\sin(n\theta)}{n^2}.$$

The cosine series in (25.12.7) has the elementary sum

$$\mathbf{25.12.8} \quad \sum_{n=1}^{\infty} \frac{\cos(n\theta)}{n^2} = \frac{\pi^2}{6} - \frac{\pi\theta}{2} + \frac{\theta^2}{4}.$$

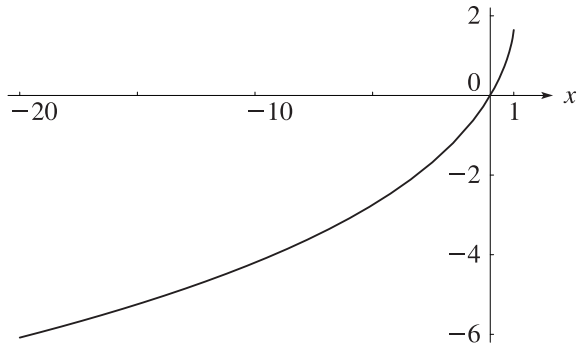


Figure 25.12.1: Dilogarithm function  $\operatorname{Li}_2(x)$ ,  $-20 \leq x < 1$ .

**25.12(ii) Polylogarithms**

For real or complex  $s$  and  $z$  the *polylogarithm*  $\operatorname{Li}_s(z)$  is defined by

$$\mathbf{25.12.10} \quad \operatorname{Li}_s(z) = \sum_{n=1}^{\infty} \frac{z^n}{n^s}.$$

For each fixed complex  $s$  the series defines an analytic function of  $z$  for  $|z| < 1$ . The series also converges when  $|z| = 1$ , provided that  $\Re s > 1$ . For other values of  $z$ ,  $\operatorname{Li}_s(z)$  is defined by analytic continuation.

The notation  $\phi(z, s)$  was used for  $\operatorname{Li}_s(z)$  in Truesdell (1945) for a series treated in Jonquière (1889), hence the alternative name *Jonquière's function*. The special case  $z = 1$  is the Riemann zeta function:  $\zeta(s) = \operatorname{Li}_s(1)$ .

**Integral Representation**

$$\mathbf{25.12.11} \quad \operatorname{Li}_s(z) = \frac{z}{\Gamma(s)} \int_0^{\infty} \frac{x^{s-1}}{e^x - z} dx,$$

valid when  $\Re s > 0$  and  $|\operatorname{ph}(1-z)| < \pi$ , or  $\Re s > 1$  and  $z = 1$ . (In the latter case (25.12.11) becomes (25.5.1)).

By (25.12.2)

$$\mathbf{25.12.9} \quad \sum_{n=1}^{\infty} \frac{\sin(n\theta)}{n^2} = - \int_0^{\theta} \ln(2 \sin(\frac{1}{2}x)) dx.$$

The right-hand side is called *Clausen's integral*.

For graphics see Figures 25.12.1 and 25.12.2, and for further properties see Maximon (2003), Kirillov (1995), Lewin (1981), Nielsen (1909), and Zagier (1989).

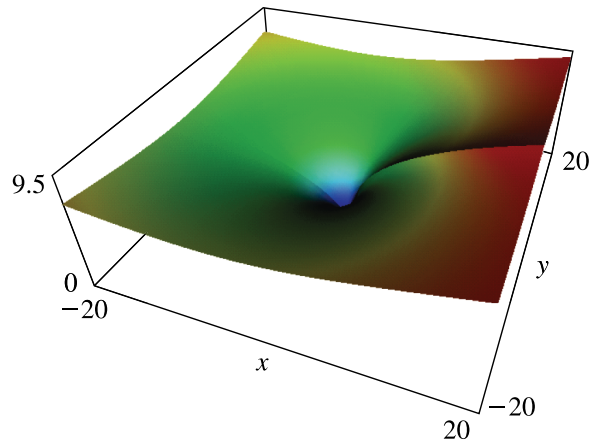


Figure 25.12.2: Absolute value of the dilogarithm function  $|\operatorname{Li}_2(x + iy)|$ ,  $-20 \leq x \leq 20$ ,  $-20 \leq y \leq 20$ . Principal value. There is a cut along the real axis from 1 to  $\infty$ .

Further properties include

**25.12.12**

$$\operatorname{Li}_s(z) = \Gamma(1-s) \left( \ln \frac{1}{z} \right)^{s-1} + \sum_{n=0}^{\infty} \zeta(s-n) \frac{(\ln z)^n}{n!},$$

$s \neq 1, 2, 3, \dots, |\ln z| < 2\pi,$

and

**25.12.13**

$$\operatorname{Li}_s(e^{2\pi ia}) + e^{\pi is} \operatorname{Li}_s(e^{-2\pi ia}) = \frac{(2\pi)^s e^{\pi is/2}}{\Gamma(s)} \zeta(1-s, a),$$

valid when  $\Re s > 0$ ,  $\Im a > 0$  or  $\Re s > 1$ ,  $\Im a = 0$ . When  $s = 2$  and  $e^{2\pi ia} = z$ , (25.12.13) becomes (25.12.4).

See also Lewin (1981), Kölbig (1986), Maximon (2003), Prudnikov *et al.* (1990, §§1.2 and 2.5), Prudnikov *et al.* (1992a, §3.3), and Prudnikov *et al.* (1992b, §3.3).

**25.12(iii) Fermi–Dirac and Bose–Einstein Integrals**

The Fermi–Dirac and Bose–Einstein integrals are defined by

$$25.12.14 \quad F_s(x) = \frac{1}{\Gamma(s+1)} \int_0^\infty \frac{t^s}{e^{t-x} + 1} dt, \quad s > -1,$$

$$25.12.15 \quad G_s(x) = \frac{1}{\Gamma(s+1)} \int_0^\infty \frac{t^s}{e^{t-x} - 1} dt, \\ s > -1, x < 0; \text{ or } s > 0, x \leq 0,$$

respectively. Sometimes the factor  $1/\Gamma(s+1)$  is omitted. See Cloutman (1989) and Gautschi (1993).

In terms of polylogarithms

$$25.12.16 \quad F_s(x) = -\text{Li}_{s+1}(-e^x), \quad G_s(x) = \text{Li}_{s+1}(e^x).$$

For a uniform asymptotic approximation for  $F_s(x)$  see Temme and Olde Daalhuis (1990).

## 25.13 Periodic Zeta Function

The notation  $F(x, s)$  is used for the polylogarithm  $\text{Li}_s(e^{2\pi ix})$  with  $x$  real:

$$25.13.1 \quad F(x, s) = \sum_{n=1}^{\infty} \frac{e^{2\pi inx}}{n^s},$$

where  $\Re s > 1$  if  $x$  is an integer,  $\Re s > 0$  otherwise.

$F(x, s)$  is periodic in  $x$  with period 1, and equals  $\zeta(s)$  when  $x$  is an integer. Also,

$$25.13.2 \quad F(x, s) = \frac{\Gamma(1-s)}{(2\pi)^{1-s}} \left( e^{\pi i(1-s)/2} \zeta(1-s, x) \right. \\ \left. + e^{\pi i(s-1)/2} \zeta(1-s, 1-x) \right), \\ 0 < x < 1, \Re s > 1,$$

$$25.13.3 \quad \zeta(1-s, x) = \frac{\Gamma(s)}{(2\pi)^s} \left( e^{-\pi is/2} F(x, s) + e^{\pi is/2} F(-x, s) \right), \\ 0 < x < 1, \Re s > 0.$$

## 25.14 Lerch's Transcendent

### 25.14(i) Definition

$$25.14.1 \quad \Phi(z, s, a) = \sum_{n=0}^{\infty} \frac{z^n}{(a+n)^s}, \\ a \neq 0, -1, -2, \dots, |z| < 1; \Re s > 1, |z| = 1.$$

For other values of  $z$ ,  $\Phi(z, s, a)$  is defined by analytic continuation. This is the notation used in Erdélyi *et al.* (1953a, p. 27). Lerch (1887) used  $\mathfrak{R}(a, x, s) = \Phi(e^{2\pi ix}, s, a)$ .

The Hurwitz zeta function  $\zeta(s, a)$  (§25.11) and the polylogarithm  $\text{Li}_s(z)$  (§25.12(ii)) are special cases:

$$25.14.2 \quad \zeta(s, a) = \Phi(1, s, a), \quad \Re s > 1, a \neq 0, -1, -2, \dots,$$

$$25.14.3 \quad \text{Li}_s(z) = z \Phi(z, s, 1), \quad \Re s > 1, |z| \leq 1.$$

### 25.14(ii) Properties

With the conditions of (25.14.1) and  $m = 1, 2, 3, \dots$ ,

$$25.14.4 \quad \Phi(z, s, a) = z^m \Phi(z, s, a+m) + \sum_{n=0}^{m-1} \frac{z^n}{(a+n)^s}.$$

$$25.14.5 \quad \Phi(z, s, a) = \frac{1}{\Gamma(s)} \int_0^\infty \frac{x^{s-1} e^{-ax}}{1 - ze^{-x}} dx, \\ \Re s > 0, \Re a > 0, z \in \mathbb{C} \setminus [1, \infty).$$

### 25.14.6

$$\Phi(z, s, a) = \frac{1}{2} a^{-s} + \int_0^\infty \frac{z^x}{(a+x)^s} dx \\ - 2 \int_0^\infty \frac{\sin(x \ln z - s \arctan(x/a))}{(a^2 + x^2)^{s/2} (e^{2\pi x} - 1)} dx, \\ \Re s > 0 \text{ if } |z| < 1; \Re s > 1 \text{ if } |z| = 1, \Re a > 0.$$

For these and further properties see Erdélyi *et al.* (1953a, pp. 27–31).

## 25.15 Dirichlet $L$ -functions

### 25.15(i) Definitions and Basic Properties

The notation  $L(s, \chi)$  was introduced by Dirichlet (1837) for the meromorphic continuation of the function defined by the series

$$25.15.1 \quad L(s, \chi) = \sum_{n=1}^{\infty} \frac{\chi(n)}{n^s}, \quad \Re s > 1,$$

where  $\chi(n)$  is a Dirichlet character (mod  $k$ ) (§27.8). For the principal character  $\chi_1$  (mod  $k$ ),  $L(s, \chi_1)$  is analytic everywhere except for a simple pole at  $s = 1$  with residue  $\phi(k)/k$ , where  $\phi(k)$  is Euler's totient function (§27.2). If  $\chi \neq \chi_1$ , then  $L(s, \chi)$  is an entire function of  $s$ .

$$25.15.2 \quad L(s, \chi) = \prod_p \left( 1 - \frac{\chi(p)}{p^s} \right)^{-1}, \quad \Re s > 1,$$

with the product taken over all primes  $p$ , beginning with  $p = 2$ . This implies that  $L(s, \chi) \neq 0$  if  $\Re s > 1$ .

Equations (25.15.3) and (25.15.4) hold for all  $s$  if  $\chi \neq \chi_1$ , and for all  $s$  ( $\neq 1$ ) if  $\chi = \chi_1$ :

$$25.15.3 \quad L(s, \chi) = k^{-s} \sum_{r=1}^{k-1} \chi(r) \zeta\left(s, \frac{r}{k}\right),$$

$$25.15.4 \quad L(s, \chi) = L(s, \chi_0) \prod_{p|k} \left( 1 - \frac{\chi_0(p)}{p^s} \right),$$

where  $\chi_0$  is a primitive character (mod  $d$ ) for some positive divisor  $d$  of  $k$  (§27.8).

When  $\chi$  is a primitive character (mod  $k$ ) the  $L$ -functions satisfy the functional equation:

### 25.15.5

$$L(1-s, \chi) = \frac{k^{s-1} \Gamma(s)}{(2\pi)^s} \left( e^{-\pi is/2} + \chi(-1) e^{\pi is/2} \right) \\ \times G(\chi) L(s, \bar{\chi}),$$

where  $\bar{\chi}$  is the complex conjugate of  $\chi$ , and

$$25.15.6 \quad G(\chi) = \sum_{r=1}^k \chi(r) e^{2\pi i r/k}.$$

**25.15(ii) Zeros**

Since  $L(s, \chi) \neq 0$  if  $\Re s > 1$ , (25.15.5) shows that for a primitive character  $\chi$  the only zeros of  $L(s, \chi)$  for  $\Re s < 0$  (the so-called trivial zeros) are as follows:

$$25.15.7 \quad L(-2n, \chi) = 0 \text{ if } \chi(-1) = 1, \quad n = 0, 1, 2, \dots,$$

$$25.15.8 \quad L(-2n - 1, \chi) = 0 \text{ if } \chi(-1) = -1, \quad n = 0, 1, 2, \dots$$

There are also infinitely many zeros in the critical strip  $0 \leq \Re s \leq 1$ , located symmetrically about the critical line  $\Re s = \frac{1}{2}$ , but not necessarily symmetrically about the real axis.

25.15.9  $L(1, \chi) \neq 0$  if  $\chi \neq \chi_1$ , where  $\chi_1$  is the principal character (mod  $k$ ). This result plays an important role in the proof of Dirichlet's theorem on primes in arithmetic progressions (§27.11). Related results are:

$$25.15.10 \quad L(0, \chi) = \begin{cases} -\frac{1}{k} \sum_{r=1}^k r\chi(r), & \chi \neq \chi_1, \\ 0, & \chi = \chi_1. \end{cases}$$

**Applications**

**25.16 Mathematical Applications**

**25.16(i) Distribution of Primes**

In studying the distribution of primes  $p \leq x$ , Chebyshev (1851) introduced a function  $\psi(x)$  (not to be confused

$$25.16.6 \quad H(s) = -\zeta'(s) + \gamma \zeta(s) + \frac{1}{2} \zeta(s+1) + \sum_{r=1}^k \zeta(1-2r) \zeta(s+2r) + \sum_{n=1}^{\infty} \frac{1}{n^s} \int_n^{\infty} \frac{\tilde{B}_{2k+1}(x)}{x^{2k+2}} dx,$$

$$25.16.7 \quad H(s) = \frac{1}{2} \zeta(s+1) + \frac{\zeta(s)}{s-1} - \sum_{r=1}^k \binom{s+2r-2}{2r-1} \zeta(1-2r) \zeta(s+2r) - \binom{s+2k}{2k+1} \sum_{n=1}^{\infty} \frac{1}{n} \int_n^{\infty} \frac{\tilde{B}_{2k+1}(x)}{x^{s+2k+1}} dx.$$

For integer  $s (\geq 2)$ ,  $H(s)$  can be evaluated in terms of the zeta function:

$$25.16.8 \quad H(2) = 2 \zeta(3), \quad H(3) = \frac{5}{4} \zeta(4),$$

$$25.16.9 \quad H(a) = \frac{a+2}{2} \zeta(a+1) - \frac{1}{2} \sum_{r=1}^{a-2} \zeta(r+1) \zeta(a-r), \quad a = 2, 3, 4, \dots$$

with the digamma function used elsewhere in this chapter), given by

$$25.16.1 \quad \psi(x) = \sum_{m=1}^{\infty} \sum_{p^m \leq x} \ln p,$$

which is related to the Riemann zeta function by

$$25.16.2 \quad \psi(x) = x - \frac{\zeta'(0)}{\zeta(0)} - \sum_{\rho} \frac{x^{\rho}}{\rho} + o(1), \quad x \rightarrow \infty,$$

where the sum is taken over the nontrivial zeros  $\rho$  of  $\zeta(s)$ .

The prime number theorem (27.2.3) is equivalent to the statement

$$25.16.3 \quad \psi(x) = x + o(x), \quad x \rightarrow \infty.$$

The Riemann hypothesis is equivalent to the statement

$$25.16.4 \quad \psi(x) = x + O(x^{\frac{1}{2}+\epsilon}), \quad x \rightarrow \infty,$$

for every  $\epsilon > 0$ .

**25.16(ii) Euler Sums**

Euler sums have the form

$$25.16.5 \quad H(s) = \sum_{n=1}^{\infty} \frac{h(n)}{n^s},$$

where  $h(n)$  is given by (25.11.33).

$H(s)$  is analytic for  $\Re s > 1$ , and can be extended meromorphically into the half-plane  $\Re s > -2k$  for every positive integer  $k$  by use of the relations

Also,

$$25.16.10 \quad H(-2a) = \frac{1}{2} \zeta(1-2a) = -\frac{B_{2a}}{4a}, \quad a = 1, 2, 3, \dots$$

$H(s)$  has a simple pole with residue  $\zeta(1-2r)$  ( $= -B_{2r}/(2r)$ ) at each odd negative integer  $s = 1-2r$ ,  $r = 1, 2, 3, \dots$

$H(s)$  is the special case  $H(s, 1)$  of the function

$$25.16.11 \quad H(s, z) = \sum_{n=1}^{\infty} \frac{1}{n^s} \sum_{m=1}^n \frac{1}{m^z}, \quad \Re(s+z) > 1,$$

which satisfies the reciprocity law

$$25.16.12 \quad H(s, z) + H(z, s) = \zeta(s)\zeta(z) + \zeta(s+z),$$

when both  $H(s, z)$  and  $H(z, s)$  are finite.

For further properties of  $H(s, z)$  see Apostol and Vu (1984). Related results are:

$$25.16.13 \quad \sum_{n=1}^{\infty} \left( \frac{h(n)}{n} \right)^2 = \frac{17}{4} \zeta(4),$$

$$25.16.14 \quad \sum_{r=1}^{\infty} \sum_{k=1}^r \frac{1}{rk(r+k)} = \frac{5}{4} \zeta(3),$$

$$25.16.15 \quad \sum_{r=1}^{\infty} \sum_{k=1}^r \frac{1}{r^2(r+k)} = \frac{3}{4} \zeta(3).$$

For further generalizations, see Flajolet and Salvy (1998).

## 25.17 Physical Applications

Analogies exist between the distribution of the zeros of  $\zeta(s)$  on the critical line and of semiclassical quantum eigenvalues. This relates to a suggestion of Hilbert and Pólya that the zeros are eigenvalues of some operator, and the Riemann hypothesis is true if that operator is Hermitian. See Armitage (1989), Berry and Keating (1998, 1999), Keating (1993, 1999), and Sarnak (1999).

The zeta function arises in the calculation of the partition function of ideal quantum gases (both Bose–Einstein and Fermi–Dirac cases), and it determines the critical gas temperature and density for the Bose–Einstein condensation phase transition in a dilute gas (Lifshitz and Pitaevskiĭ (1980)). Quantum field theory often encounters formally divergent sums that need to be evaluated by a process of regularization: for example, the energy of the electromagnetic vacuum in a confined space (*Casimir–Polder effect*). It has been found possible to perform such regularizations by equating the divergent sums to zeta functions and associated functions (Elizalde (1995)).

## Computation

### 25.18 Methods of Computation

#### 25.18(i) Function Values and Derivatives

The principal tools for computing  $\zeta(s)$  are the expansion (25.2.9) for general values of  $s$ , and the Riemann–Siegel formula (25.10.3) (extended to higher terms) for

$\zeta(\frac{1}{2} + it)$ . Details are provided in Haselgrove and Miller (1960). See also Allasia and Besenghi (1989), Butzer and Hauss (1992), Kerimov (1980), and Yeremin *et al.* (1985). Calculations relating to derivatives of  $\zeta(s)$  and/or  $\zeta(s, a)$  can be found in Apostol (1985a), Choudhury (1995), Miller and Adamchik (1998), and Yeremin *et al.* (1988).

For the Hurwitz zeta function  $\zeta(s, a)$  see Spanier and Oldham (1987, p. 653).

For dilogarithms and polylogarithms see Jacobs and Lambert (1972), Osácar *et al.* (1995), and Spanier and Oldham (1987, pp. 231–232).

For Fermi–Dirac and Bose–Einstein integrals see Cloutman (1989), Gautschi (1993), Mohankumar and Natarajan (1997), Natarajan and Mohankumar (1993), Paszkowski (1988, 1991), Pichon (1989), and Sagar (1991a,b).

#### 25.18(ii) Zeros

Most numerical calculations of the Riemann zeta function are concerned with locating zeros of  $\zeta(\frac{1}{2} + it)$  in an effort to prove or disprove the Riemann hypothesis, which states that all nontrivial zeros of  $\zeta(s)$  lie on the critical line  $\Re s = \frac{1}{2}$ . Calculations to date (2008) have found no nontrivial zeros off the critical line. For recent investigations see, for example, van de Lune *et al.* (1986) and Odlyzko (1987). For earlier work see Haselgrove and Miller (1960).

### 25.19 Tables

- Abramowitz and Stegun (1964) tabulates:  $\zeta(n)$ ,  $n = 2, 3, 4, \dots$ , 20D (p. 811);  $\text{Li}_2(1-x)$ ,  $x = 0(.01)0.5$ , 9D (p. 1005);  $f(\theta)$ ,  $\theta = 15^\circ(1^\circ)30^\circ(2^\circ)90^\circ(5^\circ)180^\circ$ ,  $f(\theta) + \theta \ln \theta$ ,  $\theta = 0(1^\circ)15^\circ$ , 6D (p. 1006). Here  $f(\theta)$  denotes Clausen’s integral, given by the right-hand side of (25.12.9).
- Morris (1979) tabulates  $\text{Li}_2(x)$  (§25.12(i)) for  $\pm x = 0.02(.02)1(.1)6$  to 30D.
- Cloutman (1989) tabulates  $\Gamma(s+1)F_s(x)$ , where  $F_s(x)$  is the Fermi–Dirac integral (25.12.14), for  $s = -\frac{1}{2}, \frac{1}{2}, \frac{3}{2}, \frac{5}{2}$ ,  $x = -5(.05)25$ , to 12S.
- Fletcher *et al.* (1962, §22.1) lists many sources for earlier tables of  $\zeta(s)$  for both real and complex  $s$ . §22.133 gives sources for numerical values of coefficients in the Riemann–Siegel formula, §22.15 describes tables of values of  $\zeta(s, a)$ , and §22.17 lists tables for some Dirichlet  $L$ -functions for real characters. For tables of dilogarithms, polylogarithms, and Clausen’s integral see §§22.84–22.858.

## 25.20 Approximations

- Cody *et al.* (1971) gives rational approximations for  $\zeta(s)$  in the form of quotients of polynomials or quotients of Chebyshev series. The ranges covered are  $0.5 \leq s \leq 5$ ,  $5 \leq s \leq 11$ ,  $11 \leq s \leq 25$ ,  $25 \leq s \leq 55$ . Precision is varied, with a maximum of 20S.
- Piessens and Branders (1972) gives the coefficients of the Chebyshev-series expansions of  $s\zeta(s+1)$  and  $\zeta(s+k)$ ,  $k = 2, 3, 4, 5, 8$ , for  $0 \leq s \leq 1$  (23D).
- Luke (1969b, p. 306) gives coefficients in Chebyshev-series expansions that cover  $\zeta(s)$  for  $0 \leq s \leq 1$  (15D),  $\zeta(s+1)$  for  $0 \leq s \leq 1$  (20D), and  $\ln \xi(\frac{1}{2} + ix)$  (§25.4) for  $-1 \leq x \leq 1$  (20D). For errata see Piessens and Branders (1972).
- Morris (1979) gives rational approximations for  $\text{Li}_2(x)$  (§25.12(i)) for  $0.5 \leq x \leq 1$ . Precision is varied with a maximum of 24S.
- Antia (1993) gives minimax rational approximations for  $\Gamma(s+1)F_s(x)$ , where  $F_s(x)$  is the Fermi-Dirac integral (25.12.14), for the intervals  $-\infty < x \leq 2$  and  $2 \leq x < \infty$ , with  $s = -\frac{1}{2}, \frac{1}{2}, \frac{3}{2}, \frac{5}{2}$ . For each  $s$  there are three sets of approximations, with relative maximum errors  $10^{-4}, 10^{-8}, 10^{-12}$ .

## 25.21 Software

See <http://dlmf.nist.gov/25.21>.

## References

### General References

The main references used in writing this chapter are Apostol (1976), Erdélyi *et al.* (1953a), and Titchmarsh (1986b). For additional bibliographic reading see Edwards (1974), Ivić (1985), Karatsuba and Voronin (1992).

### Sources

The following list gives the references or other indications of proofs that were used in constructing the various sections of this chapter. These sources supplement the references that are quoted in the text.

§25.2 Apostol (1976, Chapter 12). For (25.2.2)–(25.2.7) see also Hardy (1912). For (25.2.8)–(25.2.10) see also Knopp (1948, p. 533). (25.2.9) follows from (25.2.8) by repeated integration by parts. For (25.2.11), (25.2.12) see also Titchmarsh (1986b, p. 30).

§25.3 These graphics were constructed at NIST.

§25.4 Apostol (1976, Chapter 12).

§25.5 Apostol (1976, Chapter 12), Erdélyi *et al.* (1953a, Chapter I). For (25.5.2) and (25.5.4) integrate (25.5.1) and (25.5.3) by parts. For (25.5.5) see Titchmarsh (1986b, p. 15). (25.5.6) comes from (25.5.1) by using the identity  $e^{-x} = (1 - e^{-x})/(e^x - 1)$  in the integral  $\Gamma(s) = \int_0^\infty e^{-x} x^{s-1} dx$  together with (5.5.1). (25.5.7) follows from (25.5.6) because  $\Gamma(s+2m-1) = \int_0^\infty e^{-x} x^{s+2m-2} dx$ . For (25.5.10) and (25.5.11) see Lindelöf (1905, p. 103). For (25.5.12) see Srivastava and Choi (2001, p. 12). For (25.5.13) see Titchmarsh (1986b, p. 22). For (25.5.14)–(25.5.19) see de Bruijn (1937). For (25.5.21) see Erdélyi *et al.* (1953a, p. 32).

§25.6 For (25.6.1)–(25.6.4) see Apostol (1976, pp. 266–268). For (25.6.5) see Mordell (1958). For (25.6.6) see Nörlund (1924, p. 66). For (25.6.7) see Apostol (1983). For (25.6.8)–(25.6.10) see van der Poorten (1980, pp. 271, 274). For (25.6.11)–(25.6.14) see Apostol (1985a). For (25.6.15) see Miller and Adamchik (1998). For (25.6.16)–(25.6.20) see Basu and Apostol (2000).

§25.8 Titchmarsh (1986b, Chapter IV), Adamchik and Srivastava (1998), Erdélyi *et al.* (1953a, pp. 45 and 51). For (25.8.2) see Landau (1953, p. 274). For (25.8.3) see Srivastava (1988). For (25.8.7), (25.8.8) divide by  $x$  in (25.8.5), (25.8.6) and integrate. For (25.8.9) see Srivastava and Choi (2001, p. 212). For (25.8.10) see Ewell (1990).

§25.9 Titchmarsh (1986b, Chapter XV), Berry (1995).

§25.10 Apostol (1976, Chapter 12), Titchmarsh (1986b, pp. 89 and 263).

§25.11 Apostol (1976, Chapter 12). Analytic properties of  $\zeta(s, a)$  with respect to  $a$  follow from (25.11.30). For (25.11.5)–(25.11.6) see Apostol (1985a). For (25.11.7) take  $N = 1$  in (25.11.5) and integrate by parts. For (25.11.8)–(25.11.9) see Srivastava and Choi (2001, p. 89). For (25.11.10) use Taylor's theorem (§§1.4(vi), 1.10(i)) and (25.11.17). For (25.11.11) apply (25.2.2) and (25.11.1). For (25.11.12) see Erdélyi *et al.* (1953a,



p. 45). For (25.11.13) and (25.11.14) see Apostol (1976, pp. 268, 264). For (25.11.15) use (25.11.1) and analytic continuation. For (25.11.16) see Apostol (1976, p. 263). For (25.11.17) differentiate (25.11.1). For (25.11.18) see Erdélyi *et al.* (1953a, p. 26). For (25.11.19)–(25.11.23) see Apostol (1985a, p. 231) and Miller and Adamchik (1998). For (25.11.24) use (25.11.15) with  $a = 1/k$ , multiply by  $k^s$  and differentiate. For (25.11.25) see Srivastava and Choi (2001, p. 89) For (25.11.26) see Berndt (1972). For (25.11.27) and (25.11.28) argue as indicated above for (25.5.6) and (25.5.7). For (25.11.29) see Lindelöf (1905, p. 106). For (25.11.30) assume  $\Re s > 1$ , collapse the integration path onto the real axis, apply (25.11.25) and (5.5.3) followed by analytic continuation. For (25.11.31) use (25.11.25). For (25.11.32)–(25.11.34) see Adamchik (1998). For (25.11.35) use (25.11.25) and (25.11.8). For

(25.11.36) see Apostol (1976). For (25.11.37)–(25.11.40) see Adamchik and Srivastava (1998). For (25.11.41) and (25.11.42) see Apostol (1952). For (25.11.43) see Paris (2005b). For (25.11.44) and (25.11.45) see Elizalde (1986). The graphics were constructed at NIST.

**§25.12** Erdélyi *et al.* (1953a, pp. 27, 29), Maximon (2003). For (25.12.13) see Erdélyi *et al.* (1953a, p. 31) with change of notation. The graphics were constructed at NIST.

**§25.13** Apostol (1976, Chapter 13).

**§25.15** Apostol (1976, Chapter 12), Apostol (1985b). For (25.15.9) see Apostol (1976, pp. 142, 149).

**§25.16** Apostol (1976, Chapter 13). For (25.16.2) see Apostol (2000). For (25.16.4) see Ingham (1932, p. 84). For (25.16.5)–(25.16.15) see Apostol and Vu (1984) and Basu and Apostol (2000).

## Chapter 26

# Combinatorial Analysis

D. M. Bressoud<sup>1</sup>

<b>Notation</b>	<b>618</b>	26.12 Plane Partitions . . . . .	629
26.1 Special Notation . . . . .	618	26.13 Permutations: Cycle Notation . . . . .	631
<b>Properties</b>	<b>618</b>	26.14 Permutations: Order Notation . . . . .	632
26.2 Basic Definitions . . . . .	618	26.15 Permutations: Matrix Notation . . . . .	633
26.3 Lattice Paths: Binomial Coefficients . . . . .	619	26.16 Multiset Permutations . . . . .	634
26.4 Lattice Paths: Multinomial Coefficients and Set Partitions . . . . .	620	26.17 The Twelffold Way . . . . .	634
26.5 Lattice Paths: Catalan Numbers . . . . .	620	26.18 Counting Techniques . . . . .	634
26.6 Other Lattice Path Numbers . . . . .	621	<b>Applications</b>	<b>635</b>
26.7 Set Partitions: Bell Numbers . . . . .	623	26.19 Mathematical Applications . . . . .	635
26.8 Set Partitions: Stirling Numbers . . . . .	624	26.20 Physical Applications . . . . .	635
26.9 Integer Partitions: Restricted Number and Part Size . . . . .	626	<b>Computation</b>	<b>635</b>
26.10 Integer Partitions: Other Restrictions . . . . .	627	26.21 Tables . . . . .	635
26.11 Integer Partitions: Compositions . . . . .	628	26.22 Software . . . . .	635
		<b>References</b>	<b>635</b>

<sup>1</sup>Macalester College, Saint Paul, Minnesota.

Copyright © 2009 National Institute of Standards and Technology. All rights reserved.

## Notation

### 26.1 Special Notation

(For other notation see pp. xiv and 873.)

$x$	real variable.
$h, j, k, \ell, m, n$	nonnegative integers.
$\lambda$	integer partition.
$\pi$	plane partition.
$ A $	number of elements of a finite set $A$ .
$j \mid k$	$j$ divides $k$ .
$(h, k)$	greatest common divisor of positive integers $h$ and $k$ .

The main functions treated in this chapter are:

$\binom{m}{n}$	binomial coefficient.
$\binom{m}{n_1, n_2, \dots, n_k}$	multinomial coefficient.
$\langle \binom{m}{n} \rangle$	Eulerian number.
$[m]_q$	Gaussian polynomial.
$B(n)$	Bell number.
$C(n)$	Catalan number.
$p(n)$	number of partitions of $n$ .
$p_k(n)$	number of partitions of $n$ into at most $k$ parts.
$pp(n)$	number of plane partitions of $n$ .
$s(n, k)$	Stirling numbers of the first kind.
$S(n, k)$	Stirling numbers of the second kind.

#### Alternative Notations

Many combinatorics references use the rising and falling factorials:

$$26.1.1 \quad \begin{aligned} x^{\overline{n}} &= x(x+1)(x+2)\cdots(x+n-1), \\ x^{\underline{n}} &= x(x-1)(x-2)\cdots(x-n+1). \end{aligned}$$

Other notations for  $s(n, k)$ , the Stirling numbers of the first kind, include  $S_n^{(k)}$  (Abramowitz and Stegun (1964, Chapter 24), Fort (1948)),  $S_n^k$  (Jordan (1939), Moser and Wyman (1958a)),  $\binom{n-1}{k-1} B_{n-k}^{(n)}$  (Milne-Thomson (1933)),  $(-1)^{n-k} S_1(n-1, n-k)$  (Carlitz (1960), Gould (1960)),  $(-1)^{n-k} \left[ \begin{smallmatrix} n \\ k \end{smallmatrix} \right]$  (Knuth (1992), Graham *et al.* (1994), Rosen *et al.* (2000)).

Other notations for  $S(n, k)$ , the Stirling numbers of the second kind, include  $\mathcal{S}_n^{(k)}$  (Fort (1948)),  $\mathfrak{S}_n^k$  (Jordan (1939)),  $\sigma_n^k$  (Moser and Wyman (1958b)),  $\binom{n}{k} B_{n-k}^{(-k)}$  (Milne-Thomson (1933)),  $S_2(k, n-k)$  (Carlitz (1960), Gould (1960)),  $\left\{ \begin{smallmatrix} n \\ k \end{smallmatrix} \right\}$  (Knuth (1992), Graham *et al.* (1994), Rosen *et al.* (2000)), and also an unconventional symbol in Abramowitz and Stegun (1964, Chapter 24).

## Properties

### 26.2 Basic Definitions

#### Permutation

A *permutation* is a one-to-one and onto function from a non-empty set to itself. If the set consists of the integers 1 through  $n$ , a permutation  $\sigma$  can be thought of as a rearrangement of these integers where the integer in position  $j$  is  $\sigma(j)$ . Thus 231 is the permutation  $\sigma(1) = 2, \sigma(2) = 3, \sigma(3) = 1$ .

#### Cycle

Given a finite set  $S$  with permutation  $\sigma$ , a *cycle* is an ordered equivalence class of elements of  $S$  where  $j$  is equivalent to  $k$  if there exists an  $\ell = \ell(j, k)$  such that  $j = \sigma^\ell(k)$ , where  $\sigma^1 = \sigma$  and  $\sigma^\ell$  is the composition of  $\sigma$  with  $\sigma^{\ell-1}$ . It is ordered so that  $\sigma(j)$  follows  $j$ . If, for example, a permutation of the integers 1 through 6 is denoted by 256413, then the cycles are (1, 2, 5), (3, 6), and (4). Here  $\sigma(1) = 2, \sigma(2) = 5$ , and  $\sigma(5) = 1$ . The function  $\sigma$  also interchanges 3 and 6, and sends 4 to itself.

#### Lattice Path

A *lattice path* is a directed path on the plane integer lattice  $\{0, 1, 2, \dots\} \times \{0, 1, 2, \dots\}$ . Unless otherwise specified, it consists of horizontal segments corresponding to the vector (1, 0) and vertical segments corresponding to the vector (0, 1). For an example see Figure 26.9.2.

A *k-dimensional lattice path* is a directed path composed of segments that connect vertices in  $\{0, 1, 2, \dots\}^k$  so that each segment increases one coordinate by exactly one unit.

#### Partition

A *partition of a set*  $S$  is an unordered collection of pairwise disjoint nonempty sets whose union is  $S$ . As an example,  $\{1, 3, 4\}, \{2, 6\}, \{5\}$  is a partition of  $\{1, 2, 3, 4, 5, 6\}$ .

A *partition of a nonnegative integer*  $n$  is an unordered collection of positive integers whose sum is  $n$ . As an example,  $\{1, 1, 1, 2, 4, 4\}$  is a partition of 13. The total number of partitions of  $n$  is denoted by  $p(n)$ . See Table 26.2.1 for  $n = 0(1)50$ . For the actual partitions ( $\pi$ ) for  $n = 1(1)5$  see Table 26.4.1.

The integers whose sum is  $n$  are referred to as the *parts* in the partition. The example  $\{1, 1, 1, 2, 4, 4\}$  has six parts, three of which equal 1.

Table 26.2.1: Partitions  $p(n)$ .

$n$	$p(n)$	$n$	$p(n)$	$n$	$p(n)$
0	1	17	297	34	12310
1	1	18	385	35	14883
2	2	19	490	36	17977
3	3	20	627	37	21637
4	5	21	792	38	26015
5	7	22	1002	39	31185
6	11	23	1255	40	37338
7	15	24	1575	41	44583
8	22	25	1958	42	53174
9	30	26	2436	43	63261
10	42	27	3010	44	75175
11	56	28	3718	45	89134
12	77	29	4565	46	1 05558
13	101	30	5604	47	1 24754
14	135	31	6842	48	1 47273
15	176	32	8349	49	1 73525
16	231	33	10143	50	2 04226

### 26.3 Lattice Paths: Binomial Coefficients

#### 26.3(i) Definitions

$\binom{m}{n}$  is the number of ways of choosing  $n$  objects from a collection of  $m$  distinct objects without regard to order.  $\binom{m+n}{n}$  is the number of lattice paths from  $(0, 0)$  to  $(m, n)$ . The number of lattice paths from  $(0, 0)$  to  $(m, n)$ ,  $m \leq n$ , that stay on or above the line  $y = x$  is  $\binom{m+n}{m} - \binom{m+n}{m-1}$ .

$$26.3.1 \quad \binom{m}{n} = \binom{m}{m-n} = \frac{m!}{(m-n)!n!}, \quad m \geq n,$$

$$26.3.2 \quad \binom{m}{n} = 0, \quad n > m.$$

For numerical values of  $\binom{m}{n}$  and  $\binom{m+n}{n}$  see Tables 26.3.1 and 26.3.2.

Table 26.3.1: Binomial coefficients  $\binom{m}{n}$ .

$m$	$n$										
	0	1	2	3	4	5	6	7	8	9	10
0	1										
1	1	1									
2	1	2	1								
3	1	3	3	1							
4	1	4	6	4	1						
5	1	5	10	10	5	1					
6	1	6	15	20	15	6	1				
7	1	7	21	35	35	21	7	1			
8	1	8	28	56	70	56	28	8	1		
9	1	9	36	84	126	126	84	36	9	1	
10	1	10	45	120	210	252	210	120	45	10	1

Table 26.3.2: Binomial coefficients  $\binom{m+n}{m}$  for lattice paths.

$m$	$n$									
	0	1	2	3	4	5	6	7	8	9
0	1	1	1	1	1	1	1	1	1	1
1	1	2	3	4	5	6	7	8	9	
2	1	3	6	10	15	21	28	36	45	
3	1	4	10	20	35	56	84	120	165	
4	1	5	15	35	70	126	210	330	495	
5	1	6	21	56	126	252	462	792	1287	
6	1	7	28	84	210	462	924	1716	3003	
7	1	8	36	120	330	792	1716	3432	6435	
8	1	9	45	165	495	1287	3003	6435	12870	

#### 26.3(ii) Generating Functions

$$26.3.3 \quad \sum_{n=0}^m \binom{m}{n} x^n = (1+x)^m, \quad m = 0, 1, \dots,$$

$$26.3.4 \quad \sum_{m=0}^{\infty} \binom{m+n}{m} x^m = \frac{1}{(1-x)^{n+1}}, \quad |x| < 1.$$

#### 26.3(iii) Recurrence Relations

$$26.3.5 \quad \binom{m}{n} = \binom{m-1}{n} + \binom{m-1}{n-1}, \quad m \geq n \geq 1,$$

$$26.3.6 \quad \binom{m}{n} = \frac{m}{n} \binom{m-1}{n-1} = \frac{m-n+1}{n} \binom{m}{n-1}, \quad m \geq n \geq 1,$$

$$26.3.7 \quad \binom{m+1}{n+1} = \sum_{k=n}^m \binom{k}{n}, \quad m \geq n \geq 0,$$

$$26.3.8 \quad \binom{m}{n} = \sum_{k=0}^n \binom{m-n-1+k}{k}, \quad m \geq n \geq 0.$$

#### 26.3(iv) Identities

$$26.3.9 \quad \binom{n}{0} = \binom{n}{n} = 1,$$

$$26.3.10 \quad \binom{m}{n} = \sum_{k=0}^n (-1)^{n-k} \binom{m+1}{k}, \quad m \geq n \geq 0,$$

$$26.3.11 \quad \binom{2n}{n} = \frac{2^n(2n-1)(2n-3)\cdots 3 \cdot 1}{n!}.$$

See also §1.2(i).

#### 26.3(v) Limiting Form

$$26.3.12 \quad \binom{2n}{n} \sim \frac{4^n}{\sqrt{\pi n}}, \quad n \rightarrow \infty.$$

## 26.4 Lattice Paths: Multinomial Coefficients and Set Partitions

### 26.4(i) Definitions

$\binom{n}{n_1, n_2, \dots, n_k}$  is the number of ways of placing  $n = n_1 + n_2 + \dots + n_k$  distinct objects into  $k$  labeled boxes so that there are  $n_j$  objects in the  $j$ th box. It is also the number of  $k$ -dimensional lattice paths from  $(0, 0, \dots, 0)$  to  $(n_1, n_2, \dots, n_k)$ . For  $k = 0, 1$ , the multinomial coefficient is defined to be 1. For  $k = 2$

$$26.4.1 \quad \binom{n_1 + n_2}{n_1, n_2} = \binom{n_1 + n_2}{n_1} = \binom{n_1 + n_2}{n_2},$$

and in general,

$$26.4.2 \quad \binom{n_1 + n_2 + \dots + n_k}{n_1, n_2, \dots, n_k} = \frac{(n_1 + n_2 + \dots + n_k)!}{n_1! n_2! \dots n_k!} \\ = \prod_{j=1}^{k-1} \binom{n_j + n_{j+1} + \dots + n_k}{n_j}.$$

Table 26.4.1 gives numerical values of multinomials and partitions  $\lambda, M_1, M_2, M_3$  for  $1 \leq m \leq n \leq 5$ . These are given by the following equations in which  $a_1, a_2, \dots, a_n$  are nonnegative integers such that

$$26.4.3 \quad n = a_1 + 2a_2 + \dots + na_n,$$

$$26.4.4 \quad m = a_1 + a_2 + \dots + a_n.$$

$\lambda$  is a partition of  $n$ :

$$26.4.5 \quad \lambda = 1^{a_1}, 2^{a_2}, \dots, n^{a_n}.$$

$M_1$  is the multinomial coefficient (26.4.2):

$$26.4.6 \quad M_1 = \binom{n}{\underbrace{1, \dots, 1}_{a_1}, \dots, \underbrace{n, \dots, n}_{a_n}} \\ = \frac{n!}{(1!)^{a_1} (2!)^{a_2} \dots (n!)^{a_n}}.$$

$M_2$  is the number of permutations of  $\{1, 2, \dots, n\}$  with  $a_1$  cycles of length 1,  $a_2$  cycles of length 2,  $\dots$ , and  $a_n$  cycles of length  $n$ :

$$26.4.7 \quad M_2 = \frac{n!}{1^{a_1} (a_1!) 2^{a_2} (a_2!) \dots n^{a_n} (a_n!)}.$$

(The empty set is considered to have one permutation consisting of no cycles.)  $M_3$  is the number of set partitions of  $\{1, 2, \dots, n\}$  with  $a_1$  subsets of size 1,  $a_2$  subsets of size 2,  $\dots$ , and  $a_n$  subsets of size  $n$ :

$$26.4.8 \quad M_3 = \frac{n!}{(1!)^{a_1} (a_1!) (2!)^{a_2} (a_2!) \dots (n!)^{a_n} (a_n!)}.$$

For each  $n$  all possible values of  $a_1, a_2, \dots, a_n$  are covered.

Table 26.4.1: Multinomials and partitions.

$n$	$m$	$\lambda$	$M_1$	$M_2$	$M_3$
1	1	$1^1$	1	1	1
2	1	$2^1$	1	1	1
2	2	$1^2$	2	1	1
3	1	$3^1$	1	2	1
3	2	$1^1, 2^1$	3	3	3
3	3	$1^3$	6	1	1
4	1	$4^1$	1	6	1
4	2	$1^1, 3^1$	4	8	4
4	2	$2^2$	6	3	3
4	3	$1^2, 2^1$	12	6	6
4	4	$1^4$	24	1	1
5	1	$5^1$	1	24	1
5	2	$1^1, 4^1$	5	30	5
5	2	$2^1, 3^1$	10	20	10
5	3	$1^2, 3^1$	20	20	10
5	3	$1^1, 2^2$	30	15	15
5	4	$1^3, 2^1$	60	10	10
5	5	$1^5$	120	1	1

### 26.4(ii) Generating Function

$$26.4.9 \quad (x_1 + x_2 + \dots + x_k)^n \\ = \sum \binom{n}{n_1, n_2, \dots, n_k} x_1^{n_1} x_2^{n_2} \dots x_k^{n_k},$$

where the summation is over all nonnegative integers  $n_1, n_2, \dots, n_k$  such that  $n_1 + n_2 + \dots + n_k = n$ .

### 26.4(iii) Recurrence Relation

$$26.4.10 \quad \binom{n_1 + n_2 + \dots + n_m}{n_1, n_2, \dots, n_m} \\ = \sum_{k=1}^m \binom{n_1 + n_2 + \dots + n_m - 1}{n_1, n_2, \dots, n_{k-1}, n_k - 1, n_{k+1}, \dots, n_m}, \\ n_1, n_2, \dots, n_m \geq 1.$$

## 26.5 Lattice Paths: Catalan Numbers

### 26.5(i) Definitions

$C(n)$  is the Catalan number. It counts the number of lattice paths from  $(0, 0)$  to  $(n, n)$  that stay on or above the line  $y = x$ .

#### 26.5.1

$$C(n) = \frac{1}{n+1} \binom{2n}{n} = \frac{1}{2n+1} \binom{2n+1}{n} \\ = \binom{2n}{n} - \binom{2n}{n-1} = \binom{2n-1}{n} - \binom{2n-1}{n+1}.$$

(Sixty-six equivalent definitions of  $C(n)$  are given in Stanley (1999, pp. 219–229).)

See Table 26.5.1.

Table 26.5.1: Catalan numbers.

$n$	$C(n)$	$n$	$C(n)$	$n$	$C(n)$
0	1	7	429	14	26 74440
1	1	8	1430	15	96 94845
2	2	9	4862	16	353 57670
3	5	10	16796	17	1296 44790
4	14	11	58786	18	4776 38700
5	42	12	2 08012	19	17672 63190
6	132	13	7 42900	20	65641 20420

**26.5(ii) Generating Function**

26.5.2 
$$\sum_{n=0}^{\infty} C(n)x^n = \frac{1 - \sqrt{1 - 4x}}{2x}, \quad |x| < \frac{1}{4}.$$

**26.5(iii) Recurrence Relations**

26.5.3 
$$C(n + 1) = \sum_{k=0}^n C(k) C(n - k),$$

26.5.4 
$$C(n + 1) = \frac{2(2n + 1)}{n + 2} C(n),$$

26.5.5 
$$C(n + 1) = \sum_{k=0}^{\lfloor n/2 \rfloor} \binom{n}{2k} 2^{n-2k} C(k).$$

**26.5(iv) Limiting Forms**

26.5.6 
$$C(n) \sim \frac{4^n}{\sqrt{\pi n^3}}, \quad n \rightarrow \infty,$$

26.5.7 
$$\lim_{n \rightarrow \infty} \frac{C(n + 1)}{C(n)} = 4.$$

**26.6 Other Lattice Path Numbers**

**26.6(i) Definitions**

**Dellany Number  $D(m, n)$**

$D(m, n)$  is the number of paths from  $(0, 0)$  to  $(m, n)$  that are composed of directed line segments of the form  $(1, 0)$ ,  $(0, 1)$ , or  $(1, 1)$ .

**26.6.1**

$$D(m, n) = \sum_{k=0}^n \binom{n}{k} \binom{m + n - k}{n} = \sum_{k=0}^n 2^k \binom{m}{k} \binom{n}{k}.$$

See Table 26.6.1.

Table 26.6.1: Dellany numbers  $D(m, n)$ .

$m$	$n$										
	0	1	2	3	4	5	6	7	8	9	10
0	1	1	1	1	1	1	1	1	1	1	1
1	1	3	5	7	9	11	13	15	17	19	21
2	1	5	13	25	41	61	85	113	145	181	221
3	1	7	25	63	129	231	377	575	833	1159	1561
4	1	9	41	129	321	681	1289	2241	3649	5641	8361
5	1	11	61	231	681	1683	3653	7183	13073	22363	36365
6	1	13	85	377	1289	3653	8989	19825	40081	75517	1 34245
7	1	15	113	575	2241	7183	19825	48639	1 08545	2 24143	4 33905
8	1	17	145	833	3649	13073	40081	1 08545	2 65729	5 98417	12 56465
9	1	19	181	1159	5641	22363	75517	2 24143	5 98417	14 62563	33 17445
10	1	21	221	1561	8361	36365	1 34245	4 33905	12 56465	33 17445	80 97453

**Motzkin Number  $M(n)$**

$M(n)$  is the number of lattice paths from  $(0, 0)$  to  $(n, n)$  that stay on or above the line  $y = x$  and are composed of directed line segments of the form  $(2, 0)$ ,  $(0, 2)$ , or  $(1, 1)$ .

26.6.2 
$$M(n) = \sum_{k=0}^n \frac{(-1)^k}{n + 2 - k} \binom{n}{k} \binom{2n + 2 - 2k}{n + 1 - k}.$$

See Table 26.6.2.

Table 26.6.2: Motzkin numbers  $M(n)$ .

$n$	$M(n)$	$n$	$M(n)$	$n$	$M(n)$	$n$	$M(n)$	$n$	$M(n)$
0	1	4	9	8	323	12	15511	16	8 53467
1	1	5	21	9	835	13	41835	17	23 56779
2	2	6	51	10	2188	14	1 13634	18	65 36382
3	4	7	127	11	5798	15	3 10572	19	181 99284

**Narayana Number  $N(n, k)$**

$N(n, k)$  is the number of lattice paths from  $(0, 0)$  to  $(n, n)$  that stay on or above the line  $y = x$ , are composed of directed line segments of the form  $(1, 0)$  or  $(0, 1)$ , and for which there are exactly  $k$  occurrences at which a segment of the form  $(0, 1)$  is followed by a segment of the form  $(1, 0)$ .

**26.6.3** 
$$N(n, k) = \frac{1}{n} \binom{n}{k} \binom{n}{k-1}.$$

See Table 26.6.3.

Table 26.6.3: Narayana numbers  $N(n, k)$ .

$n$	$k$										
	0	1	2	3	4	5	6	7	8	9	10
0	1										
1	0	1									
2	0	1	1								
3	0	1	3	1							
4	0	1	6	6	1						
5	0	1	10	20	10	1					
6	0	1	15	50	50	15	1				
7	0	1	21	105	175	105	21	1			
8	0	1	28	196	490	490	196	28	1		
9	0	1	36	336	1176	1764	1176	336	36	1	
10	0	1	45	540	2520	5292	5292	2520	540	45	1

**Schröder Number  $r(n)$**

$r(n)$  is the number of paths from  $(0, 0)$  to  $(n, n)$  that stay on or above the diagonal  $y = x$  and are composed of directed line segments of the form  $(1, 0)$ ,  $(0, 1)$ , or  $(1, 1)$ .

**26.6.4** 
$$r(n) = D(n, n) - D(n + 1, n - 1), \quad n \geq 1.$$

See Table 26.6.4.

Table 26.6.4: Schröder numbers  $r(n)$ .

$n$	$r(n)$	$n$	$r(n)$	$n$	$r(n)$	$n$	$r(n)$	$n$	$r(n)$
0	1	4	90	8	41586	12	272 97738	16	2 09271 56706
1	2	5	394	9	2 06098	13	1420 78746	17	11 18180 26018
2	6	6	1806	10	10 37718	14	7453 87038	18	60 03188 53926
3	22	7	8558	11	52 93446	15	39376 03038	19	323 67243 17174

**26.6(ii) Generating Functions**

For sufficiently small  $|x|$  and  $|y|$ ,

26.6.5 
$$\sum_{m,n=0}^{\infty} D(m,n)x^m y^n = \frac{1}{1-x-y-xy},$$

26.6.6 
$$\sum_{n=0}^{\infty} D(n,n)x^n = \frac{1}{\sqrt{1-6x+x^2}},$$

26.6.7 
$$\sum_{n=0}^{\infty} M(n)x^n = \frac{1-x-\sqrt{1-2x-3x^2}}{2x^2},$$

26.6.8 
$$\sum_{n,k=1}^{\infty} N(n,k)x^n y^k = \frac{1-x-xy-\sqrt{(1-x-xy)^2-4x^2y}}{2x},$$

26.6.9 
$$\sum_{n=0}^{\infty} r(n)x^n = \frac{1-x-\sqrt{1-6x+x^2}}{2x}.$$

**26.6(iii) Recurrence Relations**

26.6.10 
$$D(m,n) = D(m,n-1) + D(m-1,n) + D(m-1,n-1), \quad m,n \geq 1,$$

26.6.11 
$$M(n) = M(n-1) + \sum_{k=2}^n M(k-2)M(n-k), \quad n \geq 2.$$

**26.6(iv) Identities**

26.6.12 
$$C(n) = \sum_{k=1}^n N(n,k),$$

26.6.13 
$$M(n) = \sum_{k=0}^n (-1)^k \binom{n}{k} C(n+1-k),$$

26.6.14 
$$C(n) = \sum_{k=0}^{2n} (-1)^k \binom{2n}{k} M(2n-k).$$

**26.7 Set Partitions: Bell Numbers**

**26.7(i) Definitions**

$B(n)$  is the number of partitions of  $\{1, 2, \dots, n\}$ . For  $S(n, k)$  see §26.8(i).

26.7.1 
$$B(0) = 1,$$

26.7.2 
$$B(n) = \sum_{k=0}^n S(n,k),$$

26.7.3 
$$B(n) = \sum_{k=1}^m \frac{k^n}{k!} \sum_{j=0}^{m-k} \frac{(-1)^j}{j!}, \quad m \geq n,$$

26.7.4 
$$B(n) = e^{-1} \sum_{k=1}^{\infty} \frac{k^n}{k!} = 1 + \left[ e^{-1} \sum_{k=1}^{2n} \frac{k^n}{k!} \right].$$

See Table 26.7.1.

Table 26.7.1: Bell numbers.

$n$	$B(n)$	$n$	$B(n)$
0	1	10	1 15975
1	1	11	6 78570
2	2	12	42 13597
3	5	13	276 44437
4	15	14	1908 99322
5	52	15	13829 58545
6	203	16	1 04801 42147
7	877	17	8 28648 69804
8	4140	18	68 20768 06159
9	21147	19	583 27422 05057

**26.7(ii) Generating Function**

26.7.5 
$$\sum_{n=0}^{\infty} B(n) \frac{x^n}{n!} = \exp(e^x - 1).$$

**26.7(iii) Recurrence Relation**

26.7.6 
$$B(n+1) = \sum_{k=0}^n \binom{n}{k} B(k).$$

**26.7(iv) Asymptotic Approximation**

26.7.7

$$B(n) = \frac{N^n e^{N-n-1}}{(1 + \ln N)^{1/2}} \left( 1 + O\left(\frac{(\ln n)^{1/2}}{n^{1/2}}\right) \right), \quad n \rightarrow \infty,$$

where

26.7.8 
$$N \ln N = n,$$

or, equivalently,  $N = e^{Wm(n)}$ , with properties of the Lambert function  $Wm(n)$  given in §4.13. For higher approximations to  $B(n)$  as  $n \rightarrow \infty$  see de Bruijn (1961, pp. 104–108).



### 26.8 Set Partitions: Stirling Numbers

#### 26.8(i) Definitions

$s(n, k)$  denotes the *Stirling number of the first kind*:  $(-1)^{n-k}$  times the number of permutations of  $\{1, 2, \dots, n\}$  with exactly  $k$  cycles. See Table 26.8.1.

**26.8.1**  $s(n, n) = 1, \quad n \geq 0,$

**26.8.2**  $s(1, k) = \delta_{1,k},$

**26.8.3** 
$$(-1)^{n-k} s(n, k) = \sum_{1 \leq b_1 < \dots < b_{n-k} \leq n-1} b_1 b_2 \dots b_{n-k}, \quad n > k \geq 1.$$

$S(n, k)$  denotes the *Stirling number of the second kind*: the number of partitions of  $\{1, 2, \dots, n\}$  into exactly  $k$  nonempty subsets. See Table 26.8.2.

**26.8.4**  $S(n, n) = 1, \quad n \geq 0,$

**26.8.5**  $S(n, k) = \sum 1^{c_1} 2^{c_2} \dots k^{c_k},$

where the summation is over all nonnegative integers  $c_1, c_2, \dots, c_k$  such that  $c_1 + c_2 + \dots + c_k = n - k$ .

**26.8.6** 
$$S(n, k) = \frac{1}{k!} \sum_{j=0}^k (-1)^{k-j} \binom{k}{j} j^n.$$

Table 26.8.1: Stirling numbers of the first kind  $s(n, k)$ .

$n$	$k$										
	0	1	2	3	4	5	6	7	8	9	10
0	1										
1	0	1									
2	0	-1	1								
3	0	2	-3	1							
4	0	-6	11	-6	1						
5	0	24	-50	35	-10	1					
6	0	-120	274	-225	85	-15	1				
7	0	720	-1764	1624	-735	175	-21	1			
8	0	-5040	13068	-13132	6769	-1960	322	-28	1		
9	0	40320	-1 09584	1 18124	-67284	22449	-4536	546	-36	1	
10	0	-3 62880	10 26576	-11 72700	7 23680	-2 69325	6327	-9450	870	-45	1

Table 26.8.2: Stirling numbers of the second kind  $S(n, k)$ .

$n$	$k$										
	0	1	2	3	4	5	6	7	8	9	10
0	1										
1	0	1									
2	0	1	1								
3	0	1	3	1							
4	0	1	7	6	1						
5	0	1	15	25	10	1					
6	0	1	31	90	65	15	1				
7	0	1	63	301	350	140	21	1			
8	0	1	127	966	1701	1050	266	28	1		
9	0	1	255	3025	7770	6951	2646	462	36	1	
10	0	1	511	9330	34105	42525	22827	5880	750	45	1

#### 26.8(ii) Generating Functions

**26.8.7** 
$$\sum_{k=0}^n s(n, k) x^k = (x - n + 1)_n,$$

where  $(x)_n$  is the Pochhammer symbol:  $x(x+1)\dots(x+n-1)$ .

**26.8.8** 
$$\sum_{n=0}^{\infty} s(n, k) \frac{x^n}{n!} = \frac{(\ln(1+x))^k}{k!}, \quad |x| < 1,$$

$$26.8.9 \quad \sum_{n,k=0}^{\infty} s(n,k) \frac{x^n}{n!} y^k = (1+x)^y, \quad |x| < 1.$$

$$26.8.10 \quad \sum_{k=1}^n S(n,k)(x-k+1)_k = x^n,$$

$$26.8.11 \quad \sum_{n=0}^{\infty} S(n,k) x^n = \frac{x^k}{(1-x)(1-2x)\cdots(1-kx)}, \quad |x| < 1/k,$$

$$26.8.12 \quad \sum_{n=0}^{\infty} S(n,k) \frac{x^n}{n!} = \frac{(e^x - 1)^k}{k!},$$

$$26.8.13 \quad \sum_{n,k=0}^{\infty} S(n,k) \frac{x^n}{n!} y^k = \exp(y(e^x - 1)).$$

**26.8(iii) Special Values**

For  $n \geq 1$ ,

$$26.8.14 \quad s(n,0) = 0, \quad s(n,1) = (-1)^{n-1}(n-1)!,$$

$$26.8.15 \quad s(n,2) = (-1)^n(n-1)! \left(1 + \frac{1}{2} + \cdots + \frac{1}{n-1}\right),$$

$$26.8.16 \quad -s(n,n-1) = S(n,n-1) = \binom{n}{2},$$

$$26.8.17 \quad S(n,0) = 0, \quad S(n,1) = 1, \quad S(n,2) = 2^{n-1} - 1.$$

**26.8(iv) Recurrence Relations**

$$26.8.18 \quad s(n,k) = s(n-1,k-1) - (n-1)s(n-1,k),$$

$$26.8.19 \quad \binom{k}{h} s(n,k) = \sum_{j=k-h}^{n-h} \binom{n}{j} s(n-j,h) s(j,k-h),$$

$n \geq k \geq h,$

$$26.8.20 \quad s(n+1,k+1) = n! \sum_{j=k}^n \frac{(-1)^{n-j}}{j!} s(j,k),$$

$$26.8.21 \quad s(n+k+1,k) = - \sum_{j=0}^k (n+j) s(n+j,j).$$

$$26.8.22 \quad S(n,k) = k S(n-1,k) + S(n-1,k-1),$$

$$26.8.23 \quad \binom{k}{h} S(n,k) = \sum_{j=k-h}^{n-h} \binom{n}{j} S(n-j,h) S(j,k-h),$$

$n \geq k \geq h,$

$$26.8.24 \quad S(n,k) = \sum_{j=k}^n S(j-1,k-1) k^{n-j},$$

$$26.8.25 \quad S(n+1,k+1) = \sum_{j=k}^n \binom{n}{j} S(j,k),$$

$$26.8.26 \quad S(n+k+1,k) = \sum_{j=0}^k j S(n+j,j).$$

**26.8(v) Identities**

$$26.8.27 \quad \begin{aligned} & s(n,n-k) \\ &= \sum_{j=0}^k (-1)^j \binom{n-1+j}{k+j} \binom{n+k}{k-j} S(k+j,j), \end{aligned}$$

$$26.8.28 \quad \sum_{k=1}^n s(n,k) = 0, \quad n > 1,$$

$$26.8.29 \quad \sum_{k=1}^n (-1)^{n-k} s(n,k) = n!,$$

$$26.8.30 \quad \sum_{j=k}^n s(n+1,j+1) n^{j-k} = s(n,k).$$

$$26.8.31 \quad \frac{1}{k!} \frac{d^k}{dx^k} f(x) = \sum_{n=k}^{\infty} \frac{s(n,k)}{n!} \Delta^n f(x),$$

when  $f(x)$  is analytic for all  $x$ , and the series converges, where

$$26.8.32 \quad \Delta f(x) = f(x+1) - f(x);$$

compare §3.6(i).

$$26.8.33 \quad \begin{aligned} & S(n,n-k) \\ &= \sum_{j=0}^k (-1)^j \binom{n-1+j}{k+j} \binom{n+k}{k-j} s(k+j,j), \end{aligned}$$

$$26.8.34 \quad \sum_{j=0}^n j^k x^j = \sum_{j=0}^k S(k,j) x^j \frac{d^j}{dx^j} \left( \frac{1-x^{n+1}}{1-x} \right),$$

$$26.8.35 \quad \sum_{j=0}^n j^k = \sum_{j=0}^k j! S(k,j) \binom{n+1}{j+1},$$

$$26.8.36 \quad \sum_{k=0}^n (-1)^{n-k} k! S(n,k) = 1.$$

$$26.8.37 \quad \frac{1}{k!} \Delta^k f(x) = \sum_{n=k}^{\infty} \frac{S(n,k)}{n!} \frac{d^n}{dx^n} f(x),$$

when  $f(x)$  is analytic for all  $x$ , and the series converges.

Let  $A$  and  $B$  be the  $n \times n$  matrices with  $(j,k)$ th elements  $s(j,k)$ , and  $S(j,k)$ , respectively. Then

$$26.8.38 \quad A^{-1} = B.$$

$$26.8.39 \quad \sum_{j=k}^n s(j,k) S(n,j) = \sum_{j=k}^n s(n,j) S(j,k) = \delta_{n,k}.$$

**26.8(vi) Relations to Bernoulli Numbers**

See §24.15(iii).

**26.8(vii) Asymptotic Approximations**

**26.8.40**

$s(n + 1, k + 1) \sim (-1)^{n-k} \frac{n!}{k!} (\gamma + \ln n)^k$ ,  $n \rightarrow \infty$ , uniformly for  $k = o(\ln n)$ , where  $\gamma$  is Euler's constant (§5.2(ii)).

**26.8.41**  $s(n + k, k) \sim \frac{(-1)^n}{2^n n!} k^{2n}$ ,  $k \rightarrow \infty$ ,  $n$  fixed.

**26.8.42**  $S(n, k) \sim \frac{k^n}{k!}$ ,  $n \rightarrow \infty$ ,  $k$  fixed.

**26.8.43**  $S(n + k, k) \sim \frac{k^{2n}}{2^n n!}$ ,  $k \rightarrow \infty$ , uniformly for  $n = o(k^{1/2})$ .

For asymptotic approximations for  $s(n + 1, k + 1)$  and  $S(n, k)$  that apply uniformly for  $1 \leq k \leq n$  as  $n \rightarrow \infty$  see Temme (1993).

For other asymptotic approximations and also expansions see Moser and Wyman (1958a) for Stirling numbers of the first kind, and Moser and Wyman (1958b), Bleick and Wang (1974) for Stirling numbers of the second kind.

For asymptotic estimates for generalized Stirling numbers see Chelluri *et al.* (2000).

**26.9 Integer Partitions: Restricted Number and Part Size**

**26.9(i) Definitions**

$p_k(n)$  denotes the number of partitions of  $n$  into at most  $k$  parts. See Table 26.9.1.

**26.9.1**  $p_k(n) = p(n)$ ,  $k \geq n$ .

Unrestricted partitions are covered in §27.14.

Table 26.9.1: Partitions  $p_k(n)$ .

$n$	$k$										
	0	1	2	3	4	5	6	7	8	9	10
0	1	1	1	1	1	1	1	1	1	1	1
1	0	1	1	1	1	1	1	1	1	1	1
2	0	1	2	2	2	2	2	2	2	2	2
3	0	1	2	3	3	3	3	3	3	3	3
4	0	1	3	4	5	5	5	5	5	5	5
5	0	1	3	5	6	7	7	7	7	7	7
6	0	1	4	7	9	10	11	11	11	11	11
7	0	1	4	8	11	13	14	15	15	15	15
8	0	1	5	10	15	18	20	21	22	22	22
9	0	1	5	12	18	23	26	28	29	30	30
10	0	1	6	14	23	30	35	38	40	41	42

A useful representation for a partition is the *Ferrers graph* in which the integers in the partition are each

represented by a row of dots. An example is provided in Figure 26.9.1.

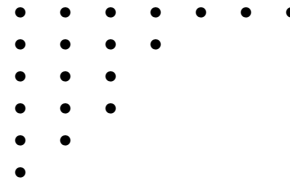


Figure 26.9.1: Ferrers graph of the partition  $7 + 4 + 3 + 3 + 2 + 1$ .

The *conjugate* partition is obtained by reflecting the Ferrers graph across the main diagonal or, equivalently, by representing each integer by a column of dots. The conjugate to the example in Figure 26.9.1 is  $6 + 5 + 4 + 2 + 1 + 1 + 1$ . Conjugation establishes a one-to-one correspondence between partitions of  $n$  into at most  $k$  parts and partitions of  $n$  into parts with largest part less than or equal to  $k$ . It follows that  $p_k(n)$  also equals the number of partitions of  $n$  into parts that are less than or equal to  $k$ .

$p_k(\leq m, n)$  is the number of partitions of  $n$  into at most  $k$  parts, each less than or equal to  $m$ . It is also equal to the number of lattice paths from  $(0, 0)$  to  $(m, k)$  that have exactly  $n$  vertices  $(h, j)$ ,  $1 \leq h \leq m$ ,  $1 \leq j \leq k$ , above and to the left of the lattice path. See Figure 26.9.2.

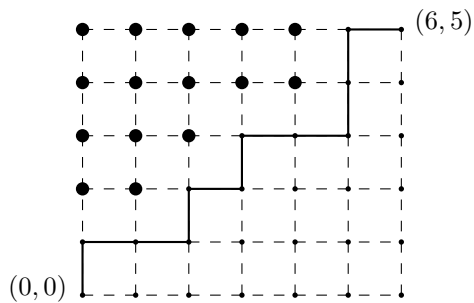


Figure 26.9.2: The partition  $5 + 5 + 3 + 2$  represented as a lattice path.

Equations (26.9.2)–(26.9.3) are examples of closed forms that can be computed explicitly for any positive integer  $k$ . See Andrews (1976, p. 81).

**26.9.2**  $p_0(n) = 0$ ,  $n > 0$ ,

$p_1(n) = 1$ ,  $p_2(n) = 1 + \lfloor n/2 \rfloor$ ,

**26.9.3**  $p_3(n) = 1 + \lfloor \frac{n^2 + 6n}{12} \rfloor$ .

**26.9(ii) Generating Functions**

In what follows

$$26.9.4 \quad \begin{bmatrix} m \\ n \end{bmatrix}_q = \prod_{j=1}^n \frac{1 - q^{m-n+j}}{1 - q^j}, \quad n \geq 0,$$

is the *Gaussian polynomial* (or *q-binomial coefficient*); compare §§17.2(i)–17.2(ii). In the present chapter  $m \geq n \geq 0$  in all cases. It is also assumed everywhere that  $|q| < 1$ .

26.9.5

$$\sum_{n=0}^{\infty} p_k(n)q^n = \prod_{j=1}^k \frac{1}{1 - q^j} = 1 + \sum_{m=1}^{\infty} \begin{bmatrix} k + m - 1 \\ m \end{bmatrix}_q q^m,$$

$$26.9.6 \quad \sum_{n=0}^{\infty} p_k(\leq m, n)q^n = \begin{bmatrix} m + k \\ k \end{bmatrix}_q.$$

Also, when  $|xq| < 1$

$$26.9.7 \quad \sum_{m,n=0}^{\infty} p_k(\leq m, n)x^k q^n = 1 + \sum_{k=1}^{\infty} \begin{bmatrix} m + k \\ k \end{bmatrix}_q x^k \\ = \prod_{j=0}^m \frac{1}{1 - xq^j}.$$

**26.9(iii) Recurrence Relations**

$$26.9.8 \quad p_k(n) = p_k(n - k) + p_{k-1}(n);$$

equivalently, partitions into at most  $k$  parts either have exactly  $k$  parts, in which case we can subtract one from each part, or they have strictly fewer than  $k$  parts.

$$26.9.9 \quad p_k(n) = \frac{1}{n} \sum_{t=1}^n p_k(n - t) \sum_{\substack{j|t \\ j \leq k}} j,$$

where the inner sum is taken over all positive divisors of  $t$  that are less than or equal to  $k$ .

**26.9(iv) Limiting Form**

As  $n \rightarrow \infty$  with  $k$  fixed,

$$26.9.10 \quad p_k(n) \sim \frac{n^{k-1}}{k!(k-1)!}.$$

**26.10 Integer Partitions: Other Restrictions**

**26.10(i) Definitions**

$p(\mathcal{D}, n)$  denotes the number of partitions of  $n$  into distinct parts.  $p_m(\mathcal{D}, n)$  denotes the number of partitions of  $n$  into at most  $m$  distinct parts.  $p(\mathcal{D}k, n)$  denotes the number of partitions of  $n$  into parts with difference at least  $k$ .  $p(\mathcal{D}'3, n)$  denotes the number of partitions of  $n$  into parts with difference at least 3, except that multiples of 3 must differ by at least 6.  $p(\mathcal{O}, n)$  denotes

the number of partitions of  $n$  into odd parts.  $p(\in S, n)$  denotes the number of partitions of  $n$  into parts taken from the set  $S$ . The set  $\{n \geq 1 | n \equiv \pm j \pmod{k}\}$  is denoted by  $A_{j,k}$ . The set  $\{2, 3, 4, \dots\}$  is denoted by  $T$ . If more than one restriction applies, then the restrictions are separated by commas, for example,  $p(\mathcal{D}2, \in T, n)$ . See Table 26.10.1.

$$26.10.1 \quad p(\mathcal{D}, 0) = p(\mathcal{D}k, 0) = p(\in S, 0) = 1.$$

Table 26.10.1: Partitions restricted by difference conditions, or equivalently with parts from  $A_{j,k}$ .

$n$	$p(\mathcal{D}, n)$ and $p(\mathcal{O}, n)$	$p(\mathcal{D}2, n)$ and $p(\in A_{1,5}, n)$	$p(\mathcal{D}2, \in T, n)$ and $p(\in A_{2,5}, n)$	$p(\mathcal{D}'3, n)$ and $p(\in A_{1,6}, n)$
0	1	1	1	1
1	1	1	0	1
2	1	1	1	1
3	2	1	1	1
4	2	2	1	1
5	3	2	1	2
6	4	3	2	2
7	5	3	2	3
8	6	4	3	3
9	8	5	3	3
10	10	6	4	4
11	12	7	4	5
12	15	9	6	6
13	18	10	6	7
14	22	12	8	8
15	27	14	9	9
16	32	17	11	10
17	38	19	12	12
18	46	23	15	14
19	54	26	16	16
20	64	31	20	18

**26.10(ii) Generating Functions**

Throughout this subsection it is assumed that  $|q| < 1$ .

$$26.10.2 \quad \sum_{n=0}^{\infty} p(\mathcal{D}, n)q^n \\ = \prod_{j=1}^{\infty} (1 + q^j) = \prod_{j=1}^{\infty} \frac{1}{1 - q^{2j-1}} \\ = 1 + \sum_{m=1}^{\infty} \frac{q^{m(m+1)/2}}{(1 - q)(1 - q^2) \cdots (1 - q^m)} \\ = 1 + \sum_{m=1}^{\infty} q^m (1 + q)(1 + q^2) \cdots (1 + q^{m-1}),$$

where the last right-hand side is the sum over  $m \geq 0$  of the generating functions for partitions into distinct parts with largest part equal to  $m$ .

$$(1-x) \sum_{m,n=0}^{\infty} p_m(\leq k, \mathcal{D}, n) x^m q^n$$

$$= \sum_{m=0}^k \begin{bmatrix} k \\ m \end{bmatrix}_q q^{m(m+1)/2} x^m = \prod_{j=1}^k (1+xq^j),$$

$|x| < 1,$

$$\sum_{n=0}^{\infty} p(\mathcal{D}k, n) q^n = 1 + \sum_{m=1}^{\infty} \frac{q^{(km^2+(2-k)m)/2}}{(1-q)(1-q^2)\cdots(1-q^m)},$$

$$\sum_{n=0}^{\infty} p(\in S, n) q^n = \prod_{j \in S} \frac{1}{1-q^j}.$$

**26.10(iii) Recurrence Relations**

$$p(\mathcal{D}, n) = \frac{1}{n} \sum_{t=1}^n p(\mathcal{D}, n-t) \sum_{\substack{j|t \\ j \text{ odd}}} j,$$

where the inner sum is the sum of all positive odd divisors of  $t$ .

$$\sum (-1)^k p(\mathcal{D}, n - \frac{1}{2}(3k^2 \pm k))$$

$$= \begin{cases} (-1)^r, & n = 3r^2 \pm r, \\ 0, & \text{otherwise,} \end{cases}$$

where the sum is over nonnegative integer values of  $k$  for which  $n - \frac{1}{2}(3k^2 \pm k) \geq 0$ .

$$\sum (-1)^k p(\mathcal{D}, n - (3k^2 \pm k)) = \begin{cases} 1, & n = \frac{1}{2}(r^2 \pm r), \\ 0, & \text{otherwise,} \end{cases}$$

where the sum is over nonnegative integer values of  $k$  for which  $n - (3k^2 \pm k) \geq 0$ .

In exact analogy with (26.9.8), we have

$$p_m(\mathcal{D}, n) = p_m(\mathcal{D}, n-m) + p_{m-1}(\mathcal{D}, n),$$

$$p(\mathcal{D}k, n) = \sum p_m(n - \frac{1}{2}km^2 - m + \frac{1}{2}km),$$

where the sum is over nonnegative integer values of  $m$  for which  $n - \frac{1}{2}km^2 - m + \frac{1}{2}km \geq 0$ .

$$p(\in S, n) = \frac{1}{n} \sum_{t=1}^n p(\in S, n-t) \sum_{\substack{j|t \\ j \in S}} j,$$

where the inner sum is the sum of all positive divisors of  $t$  that are in  $S$ .

**26.10(iv) Identities**

Equations (26.10.13) and (26.10.14) are the *Rogers-Ramanujan identities*. See also §17.2(vi).

$$p(\mathcal{D}, n) = p(\mathcal{O}, n),$$

$$p(\mathcal{D}2, n) = p(\in A_{1,5}, n),$$

$$p(\mathcal{D}2, \in T, n) = p(\in A_{2,5}, n), \quad T = \{2, 3, 4, \dots\},$$

$$p(\mathcal{D}'3, n) = p(\in A_{1,6}, n).$$

Note that  $p(\mathcal{D}'3, n) \leq p(\mathcal{D}3, n)$ , with strict inequality for  $n \geq 9$ . It is known that for  $k > 3$ ,  $p(\mathcal{D}k, n) \geq p(\in A_{1,k+3}, n)$ , with strict inequality for  $n$  sufficiently large, provided that  $k = 2^m - 1, m = 3, 4, 5$ , or  $k \geq 32$ ; see Yee (2004).

**26.10(v) Limiting Form**

$$p(\mathcal{D}, n) \sim \frac{e^{\pi\sqrt{n/3}}}{(768n^3)^{1/4}}, \quad n \rightarrow \infty.$$

**26.10(vi) Bessel-Function Expansion**

$$p(\mathcal{D}, n) = \pi \sum_{k=1}^{\infty} \frac{A_{2k-1}(n)}{(2k-1)\sqrt{24n+1}} I_1\left(\frac{\pi}{2k-1} \sqrt{\frac{24n+1}{72}}\right),$$

where  $I_1(x)$  is the modified Bessel function (§10.25(ii)), and

$$A_k(n) = \sum_{\substack{1 < h \leq k \\ (h,k)=1}} e^{\pi i f(h,k) - (2\pi i n h/k)},$$

with

$$f(h, k) = \sum_{j=1}^k \left[ \frac{2j-1}{2k} \right] \left[ \frac{h(2j-1)}{k} \right],$$

and

$$[x] = \begin{cases} x - [x] - \frac{1}{2}, & x \notin \mathbb{Z}, \\ 0, & x \in \mathbb{Z}. \end{cases}$$

The quantity  $A_k(n)$  is real-valued.

**26.11 Integer Partitions: Compositions**

A *composition* is an integer partition in which order is taken into account. For example, there are eight compositions of 4: 4, 3+1, 1+3, 2+2, 2+1+1, 1+2+1, 1+1+2, and 1+1+1+1.  $c(n)$  denotes the number of compositions of  $n$ , and  $c_m(n)$  is the number of compositions into *exactly*  $m$  parts.  $c(\in T, n)$  is the number of compositions of  $n$  with no 1's, where again  $T = \{2, 3, 4, \dots\}$ . The integer 0 is considered to have one composition consisting of no parts:

$$c(0) = c(\in T, 0) = 1.$$

Also,

$$c_m(0) = \delta_{0,m},$$

$$c_m(n) = \binom{n-1}{m-1},$$

$$\sum_{n=0}^{\infty} c_m(n) q^n = \frac{q^m}{(1-q)^m}.$$

The *Fibonacci numbers* are determined recursively by

**26.11.5**  $F_0 = 0, \quad F_1 = 1, \quad F_n = F_{n-1} + F_{n-2},$   
 $n \geq 2.$

**26.11.6**  $c(\in T, n) = F_{n-1},$   $n \geq 1.$   
 Explicitly,

**26.11.7**  $F_n = \frac{(1 + \sqrt{5})^n - (1 - \sqrt{5})^n}{2^n \sqrt{5}}.$

Additional information on Fibonacci numbers can be found in Rosen *et al.* (2000, pp. 140–145).

## 26.12 Plane Partitions

### 26.12(i) Definitions

A *plane partition*,  $\pi$ , of a positive integer  $n$ , is a partition of  $n$  in which the parts have been arranged in a 2-dimensional array that is weakly decreasing (non-increasing) across rows and down columns. Different configurations are counted as different plane partitions. As an example, there are six plane partitions of 3:

**26.12.1**

$$3, \quad 2 \ 1, \quad \begin{matrix} 2 \\ 1 \end{matrix}, \quad 1 \ 1 \ 1, \quad \begin{matrix} 1 & 1 \\ 1 \end{matrix}, \quad \begin{matrix} 1 \\ 1 \\ 1 \end{matrix}.$$

An equivalent definition is that a plane partition is a finite subset of  $\mathbb{N} \times \mathbb{N} \times \mathbb{N}$  with the property that if  $(r, s, t) \in \pi$  and  $(1, 1, 1) \leq (h, j, k) \leq (r, s, t)$ , then  $(h, j, k)$  must be an element of  $\pi$ . Here  $(h, j, k) \leq (r, s, t)$  means  $h \leq r, j \leq s$ , and  $k \leq t$ . It is useful to be able to visualize a plane partition as a pile of blocks, one block at each lattice point  $(h, j, k) \in \pi$ . For example, Figure 26.12.1 depicts the pile of blocks that represents the plane partition of 75 given by (26.12.2).

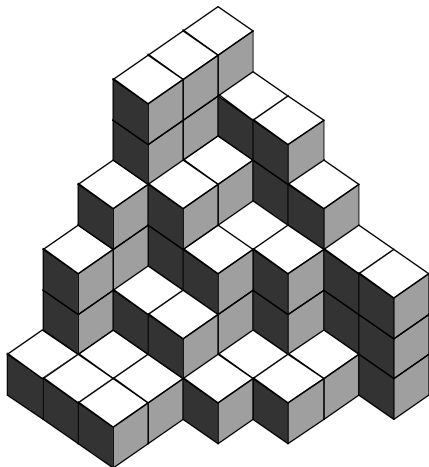


Figure 26.12.1: A plane partition of 75.

6	5	5	4	3	3
6	4	3	3	1	
6	4	3	1	1	
4	2	2	1		
3	1	1			
1	1	1			

**26.12.2**

The number of plane partitions of  $n$  is denoted by  $pp(n)$ , with  $pp(0) = 1$ . See Table 26.12.1.

Table 26.12.1: Plane partitions.

$n$	$pp(n)$	$n$	$pp(n)$	$n$	$pp(n)$
0	1	17	18334	34	281 75955
1	1	18	29601	35	416 91046
2	3	19	47330	36	614 84961
3	6	20	75278	37	903 79784
4	13	21	1 18794	38	1324 41995
5	24	22	1 86475	39	1934 87501
6	48	23	2 90783	40	2818 46923
7	86	24	4 51194	41	4093 83981
8	160	25	6 96033	42	5930 01267
9	282	26	10 68745	43	8566 67495
10	500	27	16 32658	44	12343 63833
11	859	28	24 83234	45	17740 79109
12	1479	29	37 59612	46	25435 35902
13	2485	30	56 68963	47	36379 93036
14	4167	31	85 12309	48	51913 04973
15	6879	32	127 33429	49	73910 26522
16	11297	33	189 74973	50	1 04996 40707

We define the  $r \times s \times t$  box  $B(r, s, t)$  as

**26.12.3**

$$B(r, s, t) = \{(h, j, k) \mid 1 \leq h \leq r, 1 \leq j \leq s, 1 \leq k \leq t\}.$$

Then the number of plane partitions in  $B(r, s, t)$  is

**26.12.4**

$$\prod_{(h,j,k) \in B(r,s,t)} \frac{h+j+k-1}{h+j+k-2} = \prod_{h=1}^r \prod_{j=1}^s \frac{h+j+t-1}{h+j-1}.$$

A plane partition is *symmetric* if  $(h, j, k) \in \pi$  implies that  $(j, h, k) \in \pi$ . The number of symmetric plane partitions in  $B(r, r, t)$  is

**26.12.5**  $\prod_{h=1}^r \frac{2h+t-1}{2h-1} \prod_{1 \leq h < j \leq r} \frac{h+j+t-1}{h+j-1}.$

A plane partition is *cyclically symmetric* if  $(h, j, k) \in \pi$  implies  $(j, k, h) \in \pi$ . The plane partition in Figure 26.12.1 is an example of a cyclically symmetric plane partition. The number of cyclically symmetric plane partitions in  $B(r, r, r)$  is

**26.12.6**  $\prod_{h=1}^r \frac{3h-1}{3h-2} \prod_{1 \leq h < j \leq r} \frac{h+2j-1}{h+j-1},$

or equivalently,

$$26.12.7 \quad \prod_{h=1}^r \left( \frac{3h-1}{3h-2} \prod_{j=h}^r \frac{r+h+j-1}{2h+j-1} \right).$$

A plane partition is *totally symmetric* if it is both symmetric and cyclically symmetric. The number of totally symmetric plane partitions in  $B(r, r, r)$  is

$$26.12.8 \quad \prod_{1 \leq h \leq j \leq r} \frac{h+j+r-1}{h+2j-2}.$$

The *complement* of  $\pi \subseteq B(r, s, t)$  is  $\pi^c = \{(h, j, k) \mid (r-h+1, s-j+1, t-k+1) \notin \pi\}$ . A plane partition is *self-complementary* if it is equal to its complement. The number of self-complementary plane partitions in  $B(2r, 2s, 2t)$  is

$$26.12.9 \quad \left( \prod_{h=1}^r \prod_{j=1}^s \frac{h+j+t-1}{h+j-1} \right)^2;$$

in  $B(2r+1, 2s, 2t)$  it is

$$26.12.10 \quad \left( \prod_{h=1}^r \prod_{j=1}^s \frac{h+j+t-1}{h+j-1} \right) \left( \prod_{h=1}^{r+1} \prod_{j=1}^s \frac{h+j+t-1}{h+j-1} \right);$$

in  $B(2r+1, 2s+1, 2t)$  it is

$$26.12.11 \quad \left( \prod_{h=1}^{r+1} \prod_{j=1}^s \frac{h+j+t-1}{h+j-1} \right) \left( \prod_{h=1}^r \prod_{j=1}^{s+1} \frac{h+j+t-1}{h+j-1} \right).$$

A plane partition is *transpose complement* if it is equal to the reflection through the  $(x, y)$ -plane of its complement. The number of transpose complement plane partitions in  $B(r, r, 2t)$  is

$$26.12.12 \quad \binom{t+r-1}{r-1} \prod_{1 \leq h \leq j \leq r-2} \frac{h+j+2t+1}{h+j+1}.$$

The number of symmetric self-complementary plane partitions in  $B(2r, 2r, 2t)$  is

$$26.12.13 \quad \prod_{h=1}^r \prod_{j=1}^r \frac{h+j+t-1}{h+j-1};$$

in  $B(2r+1, 2r+1, 2t)$  it is

$$26.12.14 \quad \prod_{h=1}^r \prod_{j=1}^{r+1} \frac{h+j+t-1}{h+j-1}.$$

The number of cyclically symmetric transpose complement plane partitions in  $B(2r, 2r, 2r)$  is

$$26.12.15 \quad \prod_{h=0}^{r-1} \frac{(3h+1)(6h)!(2h)!}{(4h+1)!(4h)!}.$$

The number of cyclically symmetric self-complementary plane partitions in  $B(2r, 2r, 2r)$  is

$$26.12.16 \quad \left( \prod_{h=0}^{r-1} \frac{(3h+1)!}{(r+h)!} \right)^2.$$

The number of totally symmetric self-complementary plane partitions in  $B(2r, 2r, 2r)$  is

$$26.12.17 \quad \prod_{h=0}^{r-1} \frac{(3h+1)!}{(r+h)!}.$$

A *strict shifted plane partition* is an arrangement of the parts in a partition so that each row is indented one space from the previous row and there is weak decrease across rows and strict decrease down columns. An example is given by:

$$26.12.18 \quad \begin{array}{cccccc} 6 & 6 & 6 & 4 & 3 & \\ & 3 & 3 & & & \\ & & 2 & & & \end{array}$$

A *descending plane partition* is a strict shifted plane partition in which the number of parts in each row is strictly less than the largest part in that row and is greater than or equal to the largest part in the next row. The example of a strict shifted plane partition also satisfies the conditions of a descending plane partition. The number of descending plane partitions in  $B(r, r, r)$  is

$$26.12.19 \quad \prod_{h=0}^{r-1} \frac{(3h+1)!}{(r+h)!}.$$

### 26.12(ii) Generating Functions

The notation  $\sum_{\pi \subseteq B(r,s,t)}$  denotes the sum over all plane partitions contained in  $B(r, s, t)$ , and  $|\pi|$  denotes the number of elements in  $\pi$ .

$$26.12.20 \quad \sum_{\pi \subseteq \mathbb{N} \times \mathbb{N} \times \mathbb{N}} q^{|\pi|} = \prod_{k=1}^{\infty} \frac{1}{(1-q^k)^k},$$

$$26.12.21 \quad \sum_{\pi \subseteq B(r,s,t)} q^{|\pi|} = \prod_{(h,j,k) \in B(r,s,t)} \frac{1-q^{h+j+k-1}}{1-q^{h+j+k-2}} = \prod_{h=1}^r \prod_{j=1}^s \frac{1-q^{h+j+t-1}}{1-q^{h+j-1}},$$

$$26.12.22 \quad \sum_{\substack{\pi \subseteq B(r,r,t) \\ \pi \text{ symmetric}}} q^{|\pi|} = \prod_{h=1}^r \frac{1-q^{2h+t-1}}{1-q^{2h-1}} \prod_{1 \leq h < j \leq r} \frac{1-q^{2(h+j+t-1)}}{1-q^{2(h+j-1)}}.$$

$$\begin{aligned}
 26.12.23 \quad & \sum_{\substack{\pi \subseteq B(r,r,r) \\ \pi \text{ cyclically symmetric}}} q^{|\pi|} \\
 &= \prod_{h=1}^r \frac{1 - q^{3h-1}}{1 - q^{3h-2}} \prod_{1 \leq h < j \leq r} \frac{1 - q^{3(h+2j-1)}}{1 - q^{3(h+j-1)}} \\
 &= \prod_{h=1}^r \left( \frac{1 - q^{3h-1}}{1 - q^{3h-2}} \prod_{j=h}^r \frac{1 - q^{3(r+h+j-1)}}{1 - q^{3(2h+j-1)}} \right).
 \end{aligned}$$

$$26.12.24 \quad \sum_{\substack{\pi \subseteq B(r,r,r) \\ \pi \text{ descending plane partition}}} q^{|\pi|} = \prod_{1 \leq h < j \leq r} \frac{1 - q^{r+h+j-1}}{1 - q^{2h+j-1}}.$$

**26.12(iii) Recurrence Relation**

$$26.12.25 \quad pp(n) = \frac{1}{n} \sum_{j=1}^n pp(n-j) \sigma_2(j),$$

where  $\sigma_2(j)$  is the sum of the squares of the divisors of  $j$ .

**26.12(iv) Limiting Form**

As  $n \rightarrow \infty$

$$26.12.26 \quad pp(n) \sim \left( \frac{\zeta(3)}{2^{11} n^{25}} \right)^{1/36} \exp \left( 3 \left( \frac{\zeta(3)n^2}{4} \right)^{1/3} + \zeta'(-1) \right),$$

where  $\zeta$  is the Riemann  $\zeta$ -function (§25.2(i)).

**26.13 Permutations: Cycle Notation**

$\mathfrak{S}_n$  denotes the set of permutations of  $\{1, 2, \dots, n\}$ .  $\sigma \in \mathfrak{S}_n$  is a one-to-one and onto mapping from  $\{1, 2, \dots, n\}$  to itself. An explicit representation of  $\sigma$  can be given by the  $2 \times n$  matrix:

$$26.13.1 \quad \begin{bmatrix} 1 & 2 & 3 & \cdots & n \\ \sigma(1) & \sigma(2) & \sigma(3) & \cdots & \sigma(n) \end{bmatrix}.$$

In cycle notation, the elements in each cycle are put inside parentheses, ordered so that  $\sigma(j)$  immediately follows  $j$  or, if  $j$  is the last listed element of the cycle, then  $\sigma(j)$  is the first element of the cycle. The permutation

$$26.13.2 \quad \begin{bmatrix} 1 & 2 & 3 & 4 & 5 & 6 & 7 & 8 \\ 3 & 5 & 2 & 4 & 7 & 8 & 1 & 6 \end{bmatrix}$$

is  $(1, 3, 2, 5, 7)(4)(6, 8)$  in cycle notation. Cycles of length one are *fixed points*. They are often dropped from the cycle notation. In consequence, (26.13.2) can also be written as  $(1, 3, 2, 5, 7)(6, 8)$ .

An element of  $\mathfrak{S}_n$  with  $a_1$  fixed points,  $a_2$  cycles of length 2, ...,  $a_n$  cycles of length  $n$ , where  $n = a_1 + 2a_2 + \dots + na_n$ , is said to have *cycle type*

$(a_1, a_2, \dots, a_n)$ . The number of elements of  $\mathfrak{S}_n$  with cycle type  $(a_1, a_2, \dots, a_n)$  is given by (26.4.7).

The *Stirling cycle numbers* of the first kind, denoted by  $\left[ \begin{smallmatrix} n \\ k \end{smallmatrix} \right]$ , count the number of permutations of  $\{1, 2, \dots, n\}$  with exactly  $k$  cycles. They are related to Stirling numbers of the first kind by

$$26.13.3 \quad \left[ \begin{smallmatrix} n \\ k \end{smallmatrix} \right] = |s(n, k)|.$$

See §26.8 for generating functions, recurrence relations, identities, and asymptotic approximations.

A *derangement* is a permutation with no fixed points. The *derangement number*,  $d(n)$ , is the number of elements of  $\mathfrak{S}_n$  with no fixed points:

$$26.13.4 \quad d(n) = n! \sum_{j=0}^n (-1)^j \frac{1}{j!} = \left\lfloor \frac{n! + e - 2}{e} \right\rfloor.$$

A *transposition* is a permutation that consists of a single cycle of length two. An *adjacent transposition* is a transposition of two consecutive integers. A permutation that consists of a single cycle of length  $k$  can be written as the composition of  $k - 1$  two-cycles (read from right to left):

$$26.13.5 \quad (j_1, j_2, \dots, j_k) = (j_1, j_2)(j_2, j_3) \cdots (j_{k-2}, j_{k-1})(j_{k-1}, j_k).$$

Every permutation is a product of transpositions. A permutation with cycle type  $(a_1, a_2, \dots, a_n)$  can be written as a product of  $a_2 + 2a_3 + \dots + (n - 1)a_n = n - (a_1 + a_2 + \dots + a_n)$  transpositions, and no fewer. For the example (26.13.2), this decomposition is given by  $(1, 3, 2, 5, 7)(6, 8) = (1, 3)(2, 3)(2, 5)(5, 7)(6, 8)$ .

A permutation is *even* or *odd* according to the parity of the number of transpositions. The *sign of a permutation* is  $+$  if the permutation is even,  $-$  if it is odd.

Every transposition is the product of adjacent transpositions. If  $j < k$ , then  $(j, k)$  is a product of  $2k - 2j - 1$  adjacent transpositions:

$$26.13.6 \quad (j, k) = (k - 1, k)(k - 2, k - 1) \cdots (j + 1, j + 2) \\
 \times (j, j + 1)(j + 1, j + 2) \cdots (k - 1, k).$$

Every permutation is a product of adjacent transpositions. Given a permutation  $\sigma \in \mathfrak{S}_n$ , the *inversion number* of  $\sigma$ , denoted  $\text{inv}(\sigma)$ , is the least number of adjacent transpositions required to represent  $\sigma$ . Again, for the example (26.13.2) a minimal decomposition into adjacent transpositions is given by  $(1, 3, 2, 5, 7)(6, 8) = (2, 3)(1, 2)(4, 5)(3, 4)(2, 3)(3, 4)(4, 5)(6, 7)(5, 6)(7, 8) \times (6, 7)$ :  $\text{inv}((1, 3, 2, 5, 7)(6, 8)) = 11$ .



### 26.14 Permutations: Order Notation

#### 26.14(i) Definitions

The set  $\mathfrak{S}_n$  (§26.13) can be viewed as the collection of all ordered lists of elements of  $\{1, 2, \dots, n\}$ :  $\{\sigma(1)\sigma(2)\cdots\sigma(n)\}$ . As an example, 35247816 is an element of  $\mathfrak{S}_8$ . The *inversion number* is the number of pairs of elements for which the larger element precedes the smaller:

$$\text{26.14.1} \quad \text{inv}(\sigma) = \sum_{\substack{1 \leq j < k \leq n \\ \sigma(j) > \sigma(k)}} 1.$$

Equivalently, this is the sum over  $1 \leq j < n$  of the number of integers less than  $\sigma(j)$  that lie in positions to the right of the  $j$ th position:  $\text{inv}(35247816) = 2 + 3 + 1 + 1 + 2 + 2 + 0 = 11$ .

A *descent* of a permutation is a pair of adjacent elements for which the first is larger than the second. The

permutation 35247816 has two descents: 52 and 81. The *major index* is the sum of all positions that mark the first element of a descent:

$$\text{26.14.2} \quad \text{maj}(\sigma) = \sum_{\substack{1 \leq j < n \\ \sigma(j) > \sigma(j+1)}} j.$$

For example,  $\text{maj}(35247816) = 2 + 6 = 8$ . The major index is also called the *greater index* of the permutation.

The *Eulerian number*, denoted  $\langle n \rangle_k$ , is the number of permutations in  $\mathfrak{S}_n$  with exactly  $k$  descents. An *excedance* in  $\sigma \in \mathfrak{S}_n$  is a position  $j$  for which  $\sigma(j) > j$ . A *weak excedance* is a position  $j$  for which  $\sigma(j) \geq j$ . The Eulerian number  $\langle n \rangle_k$  is equal to the number of permutations in  $\mathfrak{S}_n$  with exactly  $k$  excedances. It is also equal to the number of permutations in  $\mathfrak{S}_n$  with exactly  $k + 1$  weak excedances. See Table 26.14.1.

Table 26.14.1: Eulerian numbers  $\langle n \rangle_k$ .

$n$	$k$									
	0	1	2	3	4	5	6	7	8	9
0	1									
1	1									
2	1	1								
3	1	4	1							
4	1	11	11	1						
5	1	26	66	26	1					
6	1	57	302	302	57	1				
7	1	120	1191	2416	1191	120	1			
8	1	247	4293	15619	15619	4293	247	1		
9	1	502	14608	88234	1 56190	88234	14608	502	1	
10	1	1013	47840	4 55192	13 10354	13 10354	4 55192	47840	1013	1

#### 26.14(ii) Generating Functions

$$\text{26.14.3} \quad \sum_{\sigma \in \mathfrak{S}_n} q^{\text{inv}(\sigma)} = \sum_{\sigma \in \mathfrak{S}_n} q^{\text{maj}(\sigma)} = \prod_{j=1}^n \frac{1 - q^j}{1 - q}.$$

$$\text{26.14.4} \quad \sum_{n,k=0}^{\infty} \langle n \rangle_k x^k \frac{t^n}{n!} = \frac{1 - x}{\exp((x - 1)t) - x}, \quad |x| < 1, |t| < 1.$$

$$\text{26.14.5} \quad \sum_{k=0}^{n-1} \langle n \rangle_k \binom{x + k}{n} = x^n.$$

#### 26.14(iii) Identities

In this subsection  $S(n, k)$  is again the Stirling number of the second kind (§26.8), and  $B_m$  is the  $m$ th Bernoulli

number (§24.2(i)).

$$\text{26.14.6} \quad \langle n \rangle_k = \sum_{j=0}^k (-1)^j \binom{n+1}{j} (k+1-j)^n, \quad n \geq 1,$$

$$\text{26.14.7} \quad \langle n \rangle_k = \sum_{j=0}^{n-k} (-1)^{n-k-j} j! \binom{n-j}{k} S(n, j),$$

$$\text{26.14.8} \quad \langle n \rangle_k = (k+1) \langle n-1 \rangle_k + (n-k) \langle n-1 \rangle_{k-1}, \quad n \geq 2,$$

$$\text{26.14.9} \quad \langle n \rangle_k = \langle n-1-k \rangle_k, \quad n \geq 1,$$

$$\text{26.14.10} \quad \sum_{k=0}^{n-1} \langle n \rangle_k = n!, \quad n \geq 1.$$

26.14.11

$$B_m = \frac{m}{2^m(2^m - 1)} \sum_{k=0}^{m-2} (-1)^k \left\langle \begin{matrix} m-1 \\ k \end{matrix} \right\rangle, \quad m \geq 2.$$

26.14.12

$$S(n, m) = \frac{1}{m!} \sum_{k=0}^{n-1} \left\langle \begin{matrix} n \\ k \end{matrix} \right\rangle \binom{k}{n-m}, \quad n \geq m, n \geq 1.$$

**26.14(iv) Special Values**

26.14.13  $\left\langle \begin{matrix} 0 \\ k \end{matrix} \right\rangle = \delta_{0,k},$

26.14.14  $\left\langle \begin{matrix} n \\ 0 \end{matrix} \right\rangle = 1,$

26.14.15  $\left\langle \begin{matrix} n \\ 1 \end{matrix} \right\rangle = 2^n - n - 1, \quad n \geq 1,$

26.14.16  $\left\langle \begin{matrix} n \\ 2 \end{matrix} \right\rangle = 3^n - (n+1)2^n + \binom{n+1}{2}, \quad n \geq 1.$

**26.15 Permutations: Matrix Notation**

The set  $\mathfrak{S}_n$  (§26.13) can be identified with the set of  $n \times n$  matrices of 0's and 1's with exactly one 1 in each row and column. The permutation  $\sigma$  corresponds to the matrix in which there is a 1 at the intersection of row  $j$  with column  $\sigma(j)$ , and 0's in all other positions. The permutation 35247816 corresponds to the matrix

26.15.1 
$$\begin{bmatrix} 0 & 0 & 1 & 0 & 0 & 0 & 0 & 0 \\ 0 & 0 & 0 & 0 & 1 & 0 & 0 & 0 \\ 0 & 1 & 0 & 0 & 0 & 0 & 0 & 0 \\ 0 & 0 & 0 & 1 & 0 & 0 & 0 & 0 \\ 0 & 0 & 0 & 0 & 0 & 0 & 1 & 0 \\ 0 & 0 & 0 & 0 & 0 & 0 & 0 & 1 \\ 1 & 0 & 0 & 0 & 0 & 0 & 0 & 0 \\ 0 & 0 & 0 & 0 & 0 & 1 & 0 & 0 \end{bmatrix}$$

The *sign* of the permutation  $\sigma$  is the sign of the determinant of its matrix representation. The *inversion number* of  $\sigma$  is a sum of products of pairs of entries in the matrix representation of  $\sigma$ :

26.15.2 
$$\text{inv}(\sigma) = \sum a_{gh}a_{k\ell},$$

where the sum is over  $1 \leq g < k \leq n$  and  $n \geq h > \ell \geq 1$ .

The matrix represents the placement of  $n$  nonattacking rooks on an  $n \times n$  chessboard, that is, rooks that share neither a row nor a column with any other rook. A *permutation with restricted position* specifies a subset  $B \subseteq \{1, 2, \dots, n\} \times \{1, 2, \dots, n\}$ . If  $(j, k) \in B$ , then  $\sigma(j) \neq k$ . The number of *derangements* of  $n$  is the number of permutations with forbidden positions  $B = \{(1, 1), (2, 2), \dots, (n, n)\}$ .

Let  $r_j(B)$  be the number of ways of placing  $j$  nonattacking rooks on the squares of  $B$ . Define  $r_0(B) = 1$ .

For the problem of derangements,  $r_j(B) = \binom{n}{j}$ . The *rook polynomial* is the generating function for  $r_j(B)$ :

26.15.3 
$$R(x, B) = \sum_{j=0}^n r_j(B) x^j.$$

If  $B = B_1 \cup B_2$ , where no element of  $B_1$  is in the same row or column as any element of  $B_2$ , then

26.15.4 
$$R(x, B) = R(x, B_1) R(x, B_2).$$

For  $(j, k) \in B$ ,  $B \setminus [j, k]$  denotes  $B$  after removal of all elements of the form  $(j, t)$  or  $(t, k)$ ,  $t = 1, 2, \dots, n$ .  $B \setminus (j, k)$  denotes  $B$  with the element  $(j, k)$  removed.

26.15.5 
$$R(x, B) = x R(x, B \setminus [j, k]) + R(x, B \setminus (j, k)).$$

$N_k(B)$  is the number of permutations in  $\mathfrak{S}_n$  for which exactly  $k$  of the pairs  $(j, \sigma(j))$  are elements of  $B$ .  $N(x, B)$  is the generating function:

26.15.6 
$$N(x, B) = \sum_{k=0}^n N_k(B) x^k,$$

and

26.15.7 
$$N(x, B) = \sum_{k=0}^n r_k(B)(n-k)!(x-1)^k.$$

The number of permutations that avoid  $B$  is

26.15.8 
$$N_0(B) \equiv N(0, B) = \sum_{k=0}^n (-1)^k r_k(B)(n-k)!$$

**Example 1**

The *problème des ménages* asks for the number of ways of seating  $n$  married couples around a circular table with labeled seats so that no men are adjacent, no women are adjacent, and no husband and wife are adjacent. There are  $2(n!)$  ways to place the wives. Let  $B = \{(j, j), (j, j+1) \mid 1 \leq j < n\} \cup \{(n, n), (n, 1)\}$ . Then

26.15.9 
$$r_k(B) = \frac{2n}{2n-k} \binom{2n-k}{k}.$$

The solution is

26.15.10 
$$2(n!)N_0(B) = 2(n!) \sum_{k=0}^n (-1)^k \frac{2n}{2n-k} \binom{2n-k}{k} (n-k)!$$

**Example 2**

The *Ferrers board* of shape  $(b_1, b_2, \dots, b_n)$ ,  $0 \leq b_1 \leq b_2 \leq \dots \leq b_n$ , is the set  $B = \{(j, k) \mid 1 \leq j \leq n, 1 \leq k \leq b_j\}$ . For this set,

26.15.11 
$$\sum_{k=0}^n r_{n-k}(B)(x-k+1)_k = \prod_{j=1}^n (x+b_j-j+1).$$

If  $B$  is the Ferrers board of shape  $(0, 1, 2, \dots, n-1)$ , then

26.15.12 
$$\sum_{k=0}^n r_{n-k}(B)(x-k+1)_k = x^n,$$

and therefore by (26.8.10),

26.15.13 
$$r_{n-k}(B) = S(n, k).$$

### 26.16 Multiset Permutations

Let  $S = \{1^{a_1}, 2^{a_2}, \dots, n^{a_n}\}$  be the multiset that has  $a_j$  copies of  $j$ ,  $1 \leq j \leq n$ .  $\mathfrak{S}_S$  denotes the set of permutations of  $S$  for all distinct orderings of the  $a_1 + a_2 + \dots + a_n$  integers. The number of elements in  $\mathfrak{S}_S$  is the multinomial coefficient (§26.4)  $\binom{a_1 + a_2 + \dots + a_n}{a_1, a_2, \dots, a_n}$ . Additional information can be found in Andrews (1976, pp. 39–45).

The definitions of inversion number and major index can be extended to permutations of a multiset such as  $351322453154 \in \mathfrak{S}_{\{1^2, 2^2, 3^3, 4^2, 5^3\}}$ . Thus  $\text{inv}(351322453154) = 4 + 8 + 0 + 3 + 1 + 1 + 2 + 3 + 1 + 0 + 1 = 24$ , and  $\text{maj}(351322453154) = 2 + 4 + 8 + 9 + 11 = 34$ .

The  $q$ -multinomial coefficient is defined in terms of Gaussian polynomials (§26.9(ii)) by

26.16.1

$$\left[ \begin{matrix} a_1 + a_2 + \dots + a_n \\ a_1, a_2, \dots, a_n \end{matrix} \right]_q = \prod_{k=1}^{n-1} \left[ \begin{matrix} a_k + a_{k+1} + \dots + a_n \\ a_k \end{matrix} \right]_q,$$

and again with  $S = \{1^{a_1}, 2^{a_2}, \dots, n^{a_n}\}$  we have

26.16.2 
$$\sum_{\sigma \in \mathfrak{S}_S} q^{\text{inv}(\sigma)} = \left[ \begin{matrix} a_1 + a_2 + \dots + a_n \\ a_1, a_2, \dots, a_n \end{matrix} \right]_q,$$

26.16.3 
$$\sum_{\sigma \in \mathfrak{S}_S} q^{\text{maj}(\sigma)} = \left[ \begin{matrix} a_1 + a_2 + \dots + a_n \\ a_1, a_2, \dots, a_n \end{matrix} \right]_q.$$

### 26.17 The Twelfold Way

The *twelfold way* gives the number of mappings  $f$  from set  $N$  of  $n$  objects to set  $K$  of  $k$  objects (putting balls from set  $N$  into boxes in set  $K$ ). See Table 26.17.1. In this table  $\binom{k}{n}$  is Pochhammer’s symbol, and  $S(n, k)$  and  $p_k(n)$  are defined in §§26.8(i) and 26.9(i).

Table 26.17.1 is reproduced (in modified form) from Stanley (1997, p. 33). See also Example 3 in §26.18.

Table 26.17.1: The twelfold way.

elements of $N$	elements of $K$	$f$ unrestricted	$f$ one-to-one	$f$ onto
labeled	labeled	$k^n$	$(k - n + 1)_n$	$k! S(n, k)$
unlabeled	labeled	$\binom{k + n - 1}{n}$	$\binom{k}{n}$	$\binom{n - 1}{n - k}$
labeled	unlabeled	$S(n, 1) + S(n, 2) + \dots + S(n, k)$	$\begin{cases} 1 & n \leq k \\ 0 & n > k \end{cases}$	$S(n, k)$
unlabeled	unlabeled	$p_k(n)$	$\begin{cases} 1 & n \leq k \\ 0 & n > k \end{cases}$	$p_k(n) - p_{k-1}(n)$

### 26.18 Counting Techniques

Let  $A_1, A_2, \dots, A_n$  be subsets of a set  $S$  that are not necessarily disjoint. Then the number of elements in the set  $S \setminus (A_1 \cup A_2 \cup \dots \cup A_n)$  is

26.18.1 
$$|S \setminus (A_1 \cup A_2 \cup \dots \cup A_n)| = |S| + \sum_{t=1}^n (-1)^t \sum_{1 \leq j_1 < j_2 < \dots < j_t \leq n} |A_{j_1} \cap A_{j_2} \cap \dots \cap A_{j_t}|.$$

**Example 1**

The number of positive integers  $\leq N$  that are not divisible by any of the primes  $p_1, p_2, \dots, p_n$  (§27.2(i)) is

26.18.2 
$$N + \sum_{t=1}^n (-1)^t \sum_{1 \leq j_1 < j_2 < \dots < j_t \leq n} \left\lfloor \frac{N}{p_{j_1} p_{j_2} \dots p_{j_t}} \right\rfloor.$$

**Example 2**

With the notation of §26.15, the number of placements of  $n$  nonattacking rooks on an  $n \times n$  chessboard that avoid the squares in a specified subset  $B$  is

$$26.18.3 \quad n! + \sum_{t=1}^n (-1)^t r_t(B) (n-t)!$$

**Example 3**

The number of ways of placing  $n$  labeled objects into  $k$  labeled boxes so that at least one object is in each box is

$$26.18.4 \quad k^n + \sum_{t=1}^n (-1)^t \binom{k}{t} (k-t)^n.$$

Note that this is also one of the counting problems for which a formula is given in Table 26.17.1. Elements of  $N$  are labeled, elements of  $K$  are labeled, and  $f$  is onto.

For further examples in the use of generating functions, see Stanley (1997, 1999) and Wilf (1994). See also Pólya *et al.* (1983).

## Applications

### 26.19 Mathematical Applications

Combinatorics has applications to analysis, algebra, and geometry. Examples can be found in Beckenbach (1981), Billera *et al.* (1996), and Lovász *et al.* (1995). Partitions and plane partitions have applications to representation theory (Bressoud (1999), Macdonald (1995), and Sagan (2001)) and to special functions (Andrews *et al.* (1999) and Gasper and Rahman (2004)).

Other areas of combinatorial analysis include graph theory, coding theory, and combinatorial designs. These have applications in operations research, probability theory, and statistics. See Graham *et al.* (1995) and Rosen *et al.* (2000).

### 26.20 Physical Applications

An English translation of Pólya (1937) on applications of combinatorics to chemistry has been published as Pólya and Read (1987). Other articles on this subject are de Bruijn (1981) and Rouvray (1995). The latter reference also describes chemical applications of other combinatorial techniques.

Applications of combinatorics, especially integer and plane partitions, to counting lattice structures and other problems of statistical mechanics, of which the Ising model is the principal example, can be found in Montroll (1964), Godsil *et al.* (1995), Baxter (1982), and

Korepin *et al.* (1993). For an application of statistical mechanics to combinatorics, see Bressoud (1999).

Other applications to problems in engineering, crystallography, biology, and computer science can be found in Beckenbach (1981) and Graham *et al.* (1995).

## Computation

### 26.21 Tables

Abramowitz and Stegun (1964, Chapter 24) tabulates binomial coefficients  $\binom{m}{n}$  for  $m$  up to 50 and  $n$  up to 25; extends Table 26.4.1 to  $n = 10$ ; tabulates Stirling numbers of the first and second kinds,  $s(n, k)$  and  $S(n, k)$ , for  $n$  up to 25 and  $k$  up to  $n$ ; tabulates partitions  $p(n)$  and partitions into distinct parts  $p(\mathcal{D}, n)$  for  $n$  up to 500.

Andrews (1976) contains tables of the number of unrestricted partitions, partitions into odd parts, partitions into parts  $\not\equiv \pm 2 \pmod{5}$ , partitions into parts  $\not\equiv \pm 1 \pmod{5}$ , and unrestricted plane partitions up to 100. It also contains a table of Gaussian polynomials up to  $\begin{bmatrix} 12 \\ 6 \end{bmatrix}_q$ .

Goldberg *et al.* (1976) contains tables of binomial coefficients to  $n = 100$  and Stirling numbers to  $n = 40$ .

### 26.22 Software

See <http://dlmf.nist.gov/26.22>.

## References

### General References

Comprehensive references include Graham *et al.* (1995) and Rosen *et al.* (2000). Most of this chapter is treated in detail in Comtet (1974), Riordan (1958), and Stanley (1997, 1999).

### Sources

The following list gives the references or other indications of proofs that were used in constructing the various sections of this chapter. These sources supplement the references that are quoted in the text.

§26.2 Table 26.2.1 is from Abramowitz and Stegun (1964, Table 24.5).

§26.3 Comtet (1974, pp. 8–10, 22–23, 292), Riordan (1958, pp. 4–11), and (5.11.7). Tables 26.3.1 and 26.3.2 are from Abramowitz and Stegun (1964, Table 24.1).

- §26.4** Comtet (1974, pp. 28–29). Table 26.4.1 is from Abramowitz and Stegun (1964, Table 24.2).
- §26.5** Comtet (1974, pp. 52–54), Riordan (1979, p. 157). For (26.5.6) and (26.5.7) use (26.3.12) and (26.5.1). Table 26.5.1 was computed by the author.
- §26.6** Comtet (1974, pp. 80–81), Stanley (1999, pp. 237–241). (26.6.4) is a consequence of André’s reflection principle; see Comtet (1974, pp. 22–23). For (26.6.11) use (26.6.7). Tables 26.6.1–26.6.4 were computed by the author.
- §26.7** Comtet (1974, pp. 210–211). For (26.7.3) see Wilf (1994, p. 22). For (26.7.7) see de Bruijn (1961, pp. 104–108) and Olver (1997b, pp. 329–331). Table 26.7.1 was computed by the author.
- §26.8** Comtet (1974, pp. 206–216), Riordan (1979, pp. 195 and 203–227), Graham *et al.* (1994, pp. 264–265). For (26.8.31) use (26.8.37) and (26.8.39). For (26.8.40)–(26.8.43) see Jordan (1939, pp. 161–174) (as corrected here). Tables 26.8.1 and 26.8.2 are from Abramowitz and Stegun (1964, Tables 24.3 and 24.4).
- §26.9** Andrews (1976, Chapter 6 and pp. 1–13, 36, 47, 81). For (26.9.9) see Bressoud (1999, p. 60, Eq. (2.23)). Table 26.9.1 was computed by the author.
- §26.10** Andrews (1976, pp. 5, 11–12, 16–17, 19, 36, 82, 97, 104, 116), Bressoud (1999, pp. 60, 78–79). Table 26.10.1 was computed by the author.
- §26.11** Andrews (1976, Chapter 4).
- §26.12** Bressoud (1999, pp. 11, 13–18, 22, 57, 197–199 (with corrections)), Andrews (1976, p. 199), Andrews (1979, p. 195). Table 26.12.1 was computed by the author.
- §26.13** Cameron (1994, pp. 77, 80–84), Stanley (1997, pp. 20–21, 67).
- §26.14** Andrews (1976, pp. 39–42), Graham *et al.* (1994, pp. 267–272), Riordan (1958, pp. 38–39), Stanley (1997, pp. 20–23). For (26.14.10) and (26.14.11) use (26.14.4) and (24.2.1). Table 26.14.1 was computed by the author.
- §26.15** Stanley (1997, pp. 71–76), Tucker (2006, pp. 335–345).
- §26.16** Andrews (1976, pp. 39–45).
- §26.18** Riordan (1958, pp. 50–65).

## Chapter 27

# Functions of Number Theory

T. M. Apostol<sup>1</sup>

<b>Notation</b>	<b>638</b>	<b>Additive Number Theory</b>	<b>644</b>
27.1 Special Notation . . . . .	638	27.13 Functions . . . . .	644
<b>Multiplicative Number Theory</b>	<b>638</b>	27.14 Unrestricted Partitions . . . . .	645
27.2 Functions . . . . .	638	<b>Applications</b>	<b>647</b>
27.3 Multiplicative Properties . . . . .	640	27.15 Chinese Remainder Theorem . . . . .	647
27.4 Euler Products and Dirichlet Series . . . . .	640	27.16 Cryptography . . . . .	647
27.5 Inversion Formulas . . . . .	641	27.17 Other Applications . . . . .	647
27.6 Divisor Sums . . . . .	641	<b>Computation</b>	<b>648</b>
27.7 Lambert Series as Generating Functions . . . . .	641	27.18 Methods of Computation: Primes . . . . .	648
27.8 Dirichlet Characters . . . . .	642	27.19 Methods of Computation: Factorization . . . . .	648
27.9 Quadratic Characters . . . . .	642	27.20 Methods of Computation: Other Number- Theoretic Functions . . . . .	649
27.10 Periodic Number-Theoretic Functions . . . . .	642	27.21 Tables . . . . .	649
27.11 Asymptotic Formulas: Partial Sums . . . . .	643	27.22 Software . . . . .	649
27.12 Asymptotic Formulas: Primes . . . . .	644	<b>References</b>	<b>649</b>

<sup>1</sup>California Institute of Technology, Pasadena, California.

**Acknowledgments:** The author thanks Basil Gordon for comments on an earlier draft, and David Bressoud for providing §§27.12, 27.18, 27.19, and 27.22.

**Copyright** © 2009 National Institute of Standards and Technology. All rights reserved.

## Notation

### 27.1 Special Notation

(For other notation see pp. xiv and 873.)

$d, k, m, n$	positive integers (unless otherwise indicated).
$d \mid n$	$d$ divides $n$ .
$(m, n)$	greatest common divisor of $m, n$ . If $(m, n) = 1$ , $m$ and $n$ are called relatively prime, or coprime.
$(d_1, \dots, d_n)$	greatest common divisor of $d_1, \dots, d_n$ .
$\sum_{d \mid n}, \prod_{d \mid n}$	sum, product taken over divisors of $n$ .
$\sum_{(m,n)=1}$	sum taken over $m$ , $1 \leq m \leq n$ and $m$ relatively prime to $n$ .
$p, p_1, p_2, \dots$	prime numbers (or primes): integers ( $> 1$ ) with only two positive integer divisors, 1 and the number itself.
$\sum_p, \prod_p$	sum, product extended over all primes.
$x, y$	real numbers.
$\sum_{n \leq x}$	$\sum_{n=1}^{\lfloor x \rfloor}$ .
$\log x$	natural logarithm of $x$ , written as $\ln x$ in other chapters.
$\zeta(s)$	Riemann zeta function; see §25.2(i).
$(n \mid P)$	Jacobi symbol; see §27.9.
$(n \mid p)$	Legendre symbol; see §27.9.

## Multiplicative Number Theory

### 27.2 Functions

#### 27.2(i) Definitions

Functions in this section derive their properties from the *fundamental theorem of arithmetic*, which states that every integer  $n > 1$  can be represented uniquely as a product of prime powers,

$$27.2.1 \quad n = \prod_{r=1}^{\nu(n)} p_r^{a_r},$$

where  $p_1, p_2, \dots, p_{\nu(n)}$  are the distinct prime factors of  $n$ , each exponent  $a_r$  is positive, and  $\nu(n)$  is the number of distinct primes dividing  $n$ . ( $\nu(1)$  is defined to be 0.) Euclid's Elements (Euclid (1908, Book IX, Proposition 20)) gives an elegant proof that there are infinitely many primes. Tables of primes (§27.21) reveal great irregularity in their distribution. They tend to thin out among the large integers, but this thinning out is not completely regular. There is great interest in the function

$\pi(x)$  that counts the number of primes not exceeding  $x$ . It can be expressed as a sum over all primes  $p \leq x$ :

$$27.2.2 \quad \pi(x) = \sum_{p \leq x} 1.$$

Gauss and Legendre conjectured that  $\pi(x)$  is asymptotic to  $x/\log x$  as  $x \rightarrow \infty$ :

$$27.2.3 \quad \pi(x) \sim \frac{x}{\log x}.$$

(See Gauss (1863, Band II, pp. 437–477) and Legendre (1808, p. 394).)

This result, first proved in Hadamard (1896) and de la Vallée Poussin (1896a,b), is known as the *prime number theorem*. An equivalent form states that the  $n$ th prime  $p_n$  (when the primes are listed in increasing order) is asymptotic to  $n \log n$  as  $n \rightarrow \infty$ :

$$27.2.4 \quad p_n \sim n \log n.$$

(See also §27.12.) Other examples of number-theoretic functions treated in this chapter are as follows.

$$27.2.5 \quad \left\lfloor \frac{1}{n} \right\rfloor = \begin{cases} 1, & n = 1, \\ 0, & n > 1. \end{cases}$$

$$27.2.6 \quad \phi_k(n) = \sum_{(m,n)=1} m^k,$$

the sum of the  $k$ th powers of the positive integers  $m \leq n$  that are relatively prime to  $n$ .

$$27.2.7 \quad \phi(n) = \phi_0(n).$$

This is the number of positive integers  $\leq n$  that are relatively prime to  $n$ ;  $\phi(n)$  is *Euler's totient*.

If  $(a, n) = 1$ , then the *Euler–Fermat theorem* states that

$$27.2.8 \quad a^{\phi(n)} \equiv 1 \pmod{n},$$

and if  $\phi(n)$  is the smallest positive integer  $f$  such that  $a^f \equiv 1 \pmod{n}$ , then  $a$  is a *primitive root mod n*. The  $\phi(n)$  numbers  $a, a^2, \dots, a^{\phi(n)}$  are relatively prime to  $n$  and distinct  $\pmod{n}$ . Such a set is a *reduced residue system modulo n*.

$$27.2.9 \quad d(n) = \sum_{d \mid n} 1$$

is the number of divisors of  $n$  and is the *divisor function*. It is the special case  $k = 2$  of the function  $d_k(n)$  that counts the number of ways of expressing  $n$  as the product of  $k$  factors, with the order of factors taken into account.

$$27.2.10 \quad \sigma_\alpha(n) = \sum_{d \mid n} d^\alpha,$$

is the sum of the  $\alpha$ th powers of the divisors of  $n$ , where the exponent  $\alpha$  can be real or complex. Note that  $\sigma_0(n) = d(n)$ .

$$27.2.11 \quad J_k(n) = \sum_{((d_1, \dots, d_k), n)=1} 1,$$

is the number of  $k$ -tuples of integers  $\leq n$  whose greatest common divisor is relatively prime to  $n$ . This is *Jordan's function*. Note that  $J_1(n) = \phi(n)$ .

In the following examples,  $a_1, \dots, a_{\nu(n)}$  are the exponents in the factorization of  $n$  in (27.2.1).

$$27.2.12 \quad \mu(n) = \begin{cases} 1, & n = 1, \\ (-1)^{\nu(n)}, & a_1 = a_2 = \dots = a_{\nu(n)} = 1, \\ 0, & \text{otherwise.} \end{cases}$$

This is the *Möbius function*.

$$27.2.13 \quad \lambda(n) = \begin{cases} 1, & n = 1, \\ (-1)^{a_1 + \dots + a_{\nu(n)}}, & n > 1. \end{cases}$$

This is *Liouville's function*.

$$27.2.14 \quad \Lambda(n) = \log p, \quad n = p^a,$$

where  $p^a$  is a prime power with  $a \geq 1$ ; otherwise  $\Lambda(n) = 0$ . This is *Mangoldt's function*.

### 27.2(ii) Tables

Table 27.2.1 lists the first 100 prime numbers  $p_n$ . Table 27.2.2 tabulates the Euler totient function  $\phi(n)$ , the divisor function  $d(n)$  ( $= \sigma_0(n)$ ), and the sum of the divisors  $\sigma(n)$  ( $= \sigma_1(n)$ ), for  $n = 1(1)52$ .

Table 27.2.1: Primes.

$n$	$p_n$	$p_{n+10}$	$p_{n+20}$	$p_{n+30}$	$p_{n+40}$	$p_{n+50}$	$p_{n+60}$	$p_{n+70}$	$p_{n+80}$	$p_{n+90}$
1	2	31	73	127	179	233	283	353	419	467
2	3	37	79	131	181	239	293	359	421	479
3	5	41	83	137	191	241	307	367	431	487
4	7	43	89	139	193	251	311	373	433	491
5	11	47	97	149	197	257	313	379	439	499
6	13	53	101	151	199	263	317	383	443	503
7	17	59	103	157	211	269	331	389	449	509
8	19	61	107	163	223	271	337	397	457	521
9	23	67	109	167	227	277	347	401	461	523
10	29	71	113	173	229	281	349	409	463	541

Table 27.2.2: Functions related to division.

$n$	$\phi(n)$	$d(n)$	$\sigma(n)$	$n$	$\phi(n)$	$d(n)$	$\sigma(n)$	$n$	$\phi(n)$	$d(n)$	$\sigma(n)$	$n$	$\phi(n)$	$d(n)$	$\sigma(n)$
1	1	1	1	14	6	4	24	27	18	4	40	40	16	8	90
2	1	2	3	15	8	4	24	28	12	6	56	41	40	2	42
3	2	2	4	16	8	5	31	29	28	2	30	42	12	8	96
4	2	3	7	17	16	2	18	30	8	8	72	43	42	2	44
5	4	2	6	18	6	6	39	31	30	2	32	44	20	6	84
6	2	4	12	19	18	2	20	32	16	6	63	45	24	6	78
7	6	2	8	20	8	6	42	33	20	4	48	46	22	4	72
8	4	4	15	21	12	4	32	34	16	4	54	47	46	2	48
9	6	3	13	22	10	4	36	35	24	4	48	48	16	10	124
10	4	4	18	23	22	2	24	36	12	9	91	49	42	3	57
11	10	2	12	24	8	8	60	37	36	2	38	50	20	6	93
12	4	6	28	25	20	3	31	38	18	4	60	51	32	4	72
13	12	2	14	26	12	4	42	39	24	4	56	52	24	6	98



### 27.3 Multiplicative Properties

Except for  $\nu(n)$ ,  $\Lambda(n)$ ,  $p_n$ , and  $\pi(x)$ , the functions in §27.2 are *multiplicative*, which means  $f(1) = 1$  and

$$27.3.1 \quad f(mn) = f(m)f(n), \quad (m, n) = 1.$$

If  $f$  is multiplicative, then the values  $f(n)$  for  $n > 1$  are determined by the values at the prime powers. Specifically, if  $n$  is factored as in (27.2.1), then

$$27.3.2 \quad f(n) = \prod_{r=1}^{\nu(n)} f(p_r^{a_r}).$$

In particular,

$$27.3.3 \quad \phi(n) = n \prod_{p|n} (1 - p^{-1}),$$

$$27.3.4 \quad J_k(n) = n^k \prod_{p|n} (1 - p^{-k}),$$

$$27.3.5 \quad d(n) = \prod_{r=1}^{\nu(n)} (1 + a_r),$$

$$27.3.6 \quad \sigma_\alpha(n) = \prod_{r=1}^{\nu(n)} \frac{p_r^{\alpha(1+a_r)} - 1}{p_r^\alpha - 1}, \quad \alpha \neq 0.$$

Related multiplicative properties are

$$27.3.7 \quad \sigma_\alpha(m) \sigma_\alpha(n) = \sum_{d|(m,n)} d^\alpha \sigma_\alpha\left(\frac{mn}{d^2}\right),$$

$$27.3.8 \quad \phi(m) \phi(n) = \phi(mn) \phi((m, n)) / (m, n).$$

A function  $f$  is *completely multiplicative* if  $f(1) = 1$  and

$$27.3.9 \quad f(mn) = f(m)f(n), \quad m, n = 1, 2, \dots$$

Examples are  $[1/n]$  and  $\lambda(n)$ , and the Dirichlet characters, defined in §27.8.

If  $f$  is completely multiplicative, then (27.3.2) becomes

$$27.3.10 \quad f(n) = \prod_{r=1}^{\nu(n)} (f(p_r))^{a_r}.$$

### 27.4 Euler Products and Dirichlet Series

The fundamental theorem of arithmetic is linked to analysis through the concept of the Euler product. Every multiplicative  $f$  satisfies the identity

$$27.4.1 \quad \sum_{n=1}^{\infty} f(n) = \prod_p \left( 1 + \sum_{r=1}^{\infty} f(p^r) \right),$$

if the series on the left is absolutely convergent. In this case the infinite product on the right (extended over all primes  $p$ ) is also absolutely convergent and is called the

*Euler product* of the series. If  $f(n)$  is completely multiplicative, then each factor in the product is a geometric series and the Euler product becomes

$$27.4.2 \quad \sum_{n=1}^{\infty} f(n) = \prod_p (1 - f(p))^{-1}.$$

Euler products are used to find series that generate many functions of multiplicative number theory. The completely multiplicative function  $f(n) = n^{-s}$  gives the Euler product representation of the *Riemann zeta function*  $\zeta(s)$  (§25.2(i)):

$$27.4.3 \quad \zeta(s) = \sum_{n=1}^{\infty} n^{-s} = \prod_p (1 - p^{-s})^{-1}, \quad \Re s > 1.$$

The Riemann zeta function is the prototype of series of the form

$$27.4.4 \quad F(s) = \sum_{n=1}^{\infty} f(n)n^{-s},$$

called *Dirichlet series* with coefficients  $f(n)$ . The function  $F(s)$  is a *generating function*, or more precisely, a *Dirichlet generating function*, for the coefficients. The following examples have generating functions related to the zeta function:

$$27.4.5 \quad \sum_{n=1}^{\infty} \mu(n)n^{-s} = \frac{1}{\zeta(s)}, \quad \Re s > 1,$$

$$27.4.6 \quad \sum_{n=1}^{\infty} \phi(n)n^{-s} = \frac{\zeta(s-1)}{\zeta(s)}, \quad \Re s > 2,$$

$$27.4.7 \quad \sum_{n=1}^{\infty} \lambda(n)n^{-s} = \frac{\zeta(2s)}{\zeta(s)}, \quad \Re s > 1,$$

$$27.4.8 \quad \sum_{n=1}^{\infty} |\mu(n)|n^{-s} = \frac{\zeta(s)}{\zeta(2s)}, \quad \Re s > 1,$$

$$27.4.9 \quad \sum_{n=1}^{\infty} 2^{\nu(n)}n^{-s} = \frac{(\zeta(s))^2}{\zeta(2s)}, \quad \Re s > 1,$$

$$27.4.10 \quad \sum_{n=1}^{\infty} d_k(n)n^{-s} = (\zeta(s))^k, \quad \Re s > 1,$$

$$27.4.11 \quad \sum_{n=1}^{\infty} \sigma_\alpha(n)n^{-s} = \zeta(s) \zeta(s - \alpha), \quad \Re s > \max(1, 1 + \Re \alpha),$$

$$27.4.12 \quad \sum_{n=1}^{\infty} \Lambda(n)n^{-s} = -\frac{\zeta'(s)}{\zeta(s)}, \quad \Re s > 1,$$

$$27.4.13 \quad \sum_{n=2}^{\infty} (\log n)n^{-s} = -\zeta'(s), \quad \Re s > 1.$$

In (27.4.12) and (27.4.13)  $\zeta'(s)$  is the derivative of  $\zeta(s)$ .

### 27.5 Inversion Formulas

If a Dirichlet series  $F(s)$  generates  $f(n)$ , and  $G(s)$  generates  $g(n)$ , then the product  $F(s)G(s)$  generates

$$27.5.1 \quad h(n) = \sum_{d|n} f(d)g\left(\frac{n}{d}\right),$$

called the *Dirichlet product* (or *convolution*) of  $f$  and  $g$ . The set of all number-theoretic functions  $f$  with  $f(1) \neq 0$  forms an abelian group under Dirichlet multiplication, with the function  $[1/n]$  in (27.2.5) as identity element; see Apostol (1976, p. 129). The multiplicative functions are a subgroup of this group. Generating functions yield many relations connecting number-theoretic functions. For example, the equation  $\zeta(s) \cdot (1/\zeta(s)) = 1$  is equivalent to the identity

$$27.5.2 \quad \sum_{d|n} \mu(d) = \left[ \frac{1}{n} \right],$$

which, in turn, is the basis for the *Möbius inversion formula* relating sums over divisors:

$$27.5.3 \quad g(n) = \sum_{d|n} f(d) \iff f(n) = \sum_{d|n} g(d) \mu\left(\frac{n}{d}\right).$$

Special cases of Möbius inversion pairs are:

$$27.5.4 \quad n = \sum_{d|n} \phi(d) \iff \phi(n) = \sum_{d|n} d \mu\left(\frac{n}{d}\right),$$

$$27.5.5 \quad \log n = \sum_{d|n} \Lambda(d) \iff \Lambda(n) = \sum_{d|n} (\log d) \mu\left(\frac{n}{d}\right).$$

Other types of Möbius inversion formulas include:

$$27.5.6 \quad G(x) = \sum_{n \leq x} F\left(\frac{x}{n}\right) \iff F(x) = \sum_{n \leq x} \mu(n)G\left(\frac{x}{n}\right),$$

$$27.5.7 \quad G(x) = \sum_{m=1}^{\infty} \frac{F(mx)}{m^s} \iff F(x) = \sum_{m=1}^{\infty} \mu(m) \frac{G(mx)}{m^s},$$

$$27.5.8 \quad g(n) = \prod_{d|n} f(d) \iff f(n) = \prod_{d|n} \left(g\left(\frac{n}{d}\right)\right)^{\mu(d)}.$$

For a general theory of Möbius inversion with applications to combinatorial theory see Rota (1964).

### 27.6 Divisor Sums

Sums of number-theoretic functions extended over divisors are of special interest. For example,

$$27.6.1 \quad \sum_{d|n} \lambda(d) = \begin{cases} 1, & n \text{ is a square,} \\ 0, & \text{otherwise.} \end{cases}$$

If  $f$  is multiplicative, then

$$27.6.2 \quad \sum_{d|n} \mu(d)f(d) = \prod_{p|n} (1 - f(p)), \quad n > 1.$$

Generating functions, Euler products, and Möbius inversion are used to evaluate many sums extended over divisors. Examples include:

$$27.6.3 \quad \sum_{d|n} |\mu(d)| = 2^{\nu(n)},$$

$$27.6.4 \quad \sum_{d^2|n} \mu(d) = |\mu(n)|,$$

$$27.6.5 \quad \sum_{d|n} \frac{|\mu(d)|}{\phi(d)} = \frac{n}{\phi(n)},$$

$$27.6.6 \quad \sum_{d|n} \phi_k(d) \left(\frac{n}{d}\right)^k = 1^k + 2^k + \dots + n^k,$$

$$27.6.7 \quad \sum_{d|n} \mu(d) \left(\frac{n}{d}\right)^k = J_k(n),$$

$$27.6.8 \quad \sum_{d|n} J_k(d) = n^k.$$

### 27.7 Lambert Series as Generating Functions

*Lambert series* have the form

$$27.7.1 \quad \sum_{n=1}^{\infty} f(n) \frac{x^n}{1-x^n}.$$

If  $|x| < 1$ , then the quotient  $x^n/(1-x^n)$  is the sum of a geometric series, and when the series (27.7.1) converges absolutely it can be rearranged as a power series:

$$27.7.2 \quad \sum_{n=1}^{\infty} f(n) \frac{x^n}{1-x^n} = \sum_{n=1}^{\infty} \sum_{d|n} f(d)x^n.$$

Again with  $|x| < 1$ , special cases of (27.7.2) include:

$$27.7.3 \quad \sum_{n=1}^{\infty} \mu(n) \frac{x^n}{1-x^n} = x,$$

$$27.7.4 \quad \sum_{n=1}^{\infty} \phi(n) \frac{x^n}{1-x^n} = \frac{x}{(1-x)^2},$$

$$27.7.5 \quad \sum_{n=1}^{\infty} n^\alpha \frac{x^n}{1-x^n} = \sum_{n=1}^{\infty} \sigma_\alpha(n)x^n,$$

$$27.7.6 \quad \sum_{n=1}^{\infty} \lambda(n) \frac{x^n}{1-x^n} = \sum_{n=1}^{\infty} x^{n^2}.$$

### 27.8 Dirichlet Characters

If  $k (> 1)$  is a given integer, then a function  $\chi(n)$  is called a *Dirichlet character* (mod  $k$ ) if it is completely multiplicative, periodic with period  $k$ , and vanishes when  $(n, k) > 1$ . In other words, Dirichlet characters (mod  $k$ ) satisfy the four conditions:

- 27.8.1  $\chi(1) = 1,$
- 27.8.2  $\chi(mn) = \chi(m)\chi(n), \quad m, n = 1, 2, \dots,$
- 27.8.3  $\chi(n + k) = \chi(n), \quad n = 1, 2, \dots,$
- 27.8.4  $\chi(n) = 0, \quad (n, k) > 1.$

An example is the *principal character* (mod  $k$ ):

27.8.5 
$$\chi_1(n) = \begin{cases} 1, & (n, k) = 1, \\ 0, & (n, k) > 1. \end{cases}$$

For any character  $\chi$  (mod  $k$ ),  $\chi(n) \neq 0$  if and only if  $(n, k) = 1$ , in which case the Euler–Fermat theorem (27.2.8) implies  $(\chi(n))^{\phi(k)} = 1$ . There are exactly  $\phi(k)$  different characters (mod  $k$ ), which can be labeled as  $\chi_1, \dots, \chi_{\phi(k)}$ . If  $\chi$  is a character (mod  $k$ ), so is its complex conjugate  $\bar{\chi}$ . If  $(n, k) = 1$ , then the characters satisfy the *orthogonality relation*

27.8.6 
$$\sum_{r=1}^{\phi(k)} \chi_r(m)\bar{\chi}_r(n) = \begin{cases} \phi(k), & m \equiv n \pmod{k}, \\ 0, & \text{otherwise.} \end{cases}$$

A Dirichlet character  $\chi$  (mod  $k$ ) is called *primitive* (mod  $k$ ) if for every proper divisor  $d$  of  $k$  (that is, a divisor  $d < k$ ), there exists an integer  $a \equiv 1 \pmod{d}$ , with  $(a, k) = 1$  and  $\chi(a) \neq 1$ . If  $k$  is prime, then every nonprincipal character  $\chi$  (mod  $k$ ) is primitive. A divisor  $d$  of  $k$  is called an *induced modulus* for  $\chi$  if

27.8.7  $\chi(a) = 1$  for all  $a \equiv 1 \pmod{d}$ ,  $(a, k) = 1$ .

Every Dirichlet character  $\chi$  (mod  $k$ ) is a product

27.8.8 
$$\chi(n) = \chi_0(n)\chi_1(n),$$

where  $\chi_0$  is a character (mod  $d$ ) for some induced modulus  $d$  for  $\chi$ , and  $\chi_1$  is the principal character (mod  $k$ ). A character is *real* if all its values are real. If  $k$  is odd, then the real characters (mod  $k$ ) are the principal character and the quadratic characters described in the next section.

### 27.9 Quadratic Characters

For an odd prime  $p$ , the *Legendre symbol*  $(n|p)$  is defined as follows. If  $p$  divides  $n$ , then the value of  $(n|p)$  is 0. If  $p$  does not divide  $n$ , then  $(n|p)$  has the value 1 when the quadratic congruence  $x^2 \equiv n \pmod{p}$  has a solution, and the value  $-1$  when this congruence has no solution. The Legendre symbol  $(n|p)$ , as a function

of  $n$ , is a Dirichlet character (mod  $p$ ). It is sometimes written as  $(\frac{n}{p})$ . Special values include:

27.9.1 
$$(-1|p) = (-1)^{(p-1)/2},$$

27.9.2 
$$(2|p) = (-1)^{(p^2-1)/8}.$$

If  $p, q$  are distinct odd primes, then the *quadratic reciprocity law* states that

27.9.3 
$$(p|q)(q|p) = (-1)^{(p-1)(q-1)/4}.$$

If an odd integer  $P$  has prime factorization  $P = \prod_{r=1}^{\nu(n)} p_r^{a_r}$ , then the *Jacobi symbol*  $(n|P)$  is defined by  $(n|P) = \prod_{r=1}^{\nu(n)} (n|p_r)^{a_r}$ , with  $(n|1) = 1$ . The Jacobi symbol  $(n|P)$  is a Dirichlet character (mod  $P$ ). Both (27.9.1) and (27.9.2) are valid with  $p$  replaced by  $P$ ; the reciprocity law (27.9.3) holds if  $p, q$  are replaced by any two relatively prime odd integers  $P, Q$ .

### 27.10 Periodic Number-Theoretic Functions

If  $k$  is a fixed positive integer, then a number-theoretic function  $f$  is *periodic* (mod  $k$ ) if

27.10.1 
$$f(n + k) = f(n), \quad n = 1, 2, \dots$$

Examples are the Dirichlet characters (mod  $k$ ) and the greatest common divisor  $(n, k)$  regarded as a function of  $n$ .

Every function periodic (mod  $k$ ) can be expressed as a *finite Fourier series* of the form

27.10.2 
$$f(n) = \sum_{m=1}^k g(m)e^{2\pi imn/k},$$

where  $g(m)$  is also periodic (mod  $k$ ), and is given by

27.10.3 
$$g(m) = \frac{1}{k} \sum_{n=1}^k f(n)e^{-2\pi imn/k}.$$

An example is *Ramanujan’s sum*:

27.10.4 
$$c_k(n) = \sum_{m=1}^k \chi_1(m)e^{2\pi imn/k},$$

where  $\chi_1$  is the principal character (mod  $k$ ). This is the sum of the  $n$ th powers of the primitive  $k$ th roots of unity. It can also be expressed in terms of the Möbius function as a divisor sum:

27.10.5 
$$c_k(n) = \sum_{d|(n,k)} d \mu\left(\frac{k}{d}\right).$$

More generally, if  $f$  and  $g$  are arbitrary, then the sum

27.10.6 
$$s_k(n) = \sum_{d|(n,k)} f(d)g\left(\frac{k}{d}\right)$$

is a periodic function of  $n \pmod k$  and has the finite Fourier-series expansion

$$27.10.7 \quad s_k(n) = \sum_{m=1}^k a_k(m)e^{2\pi imn/k},$$

where

$$27.10.8 \quad a_k(m) = \sum_{d|(m,k)} g(d)f\left(\frac{k}{d}\right)\frac{d}{k}.$$

Another generalization of Ramanujan's sum is the *Gauss sum*  $G(n, \chi)$  associated with a Dirichlet character  $\chi \pmod k$ . It is defined by the relation

$$27.10.9 \quad G(n, \chi) = \sum_{m=1}^k \chi(m)e^{2\pi imn/k}.$$

In particular,  $G(n, \chi_1) = c_k(n)$ .

$G(n, \chi)$  is *separable* for some  $n$  if

$$27.10.10 \quad G(n, \chi) = \bar{\chi}(n)G(1, \chi).$$

For any Dirichlet character  $\chi \pmod k$ ,  $G(n, \chi)$  is separable for  $n$  if  $(n, k) = 1$ , and is separable for every  $n$  if and only if  $G(n, \chi) = 0$  whenever  $(n, k) > 1$ . For a primitive character  $\chi \pmod k$ ,  $G(n, \chi)$  is separable for every  $n$ , and

$$27.10.11 \quad |G(1, \chi)|^2 = k.$$

Conversely, if  $G(n, \chi)$  is separable for every  $n$ , then  $\chi$  is primitive  $\pmod k$ .

The finite Fourier expansion of a primitive Dirichlet character  $\chi \pmod k$  has the form

$$27.10.12 \quad \chi(n) = \frac{G(1, \chi)}{k} \sum_{m=1}^k \bar{\chi}(m)e^{-2\pi imn/k}.$$

### 27.11 Asymptotic Formulas: Partial Sums

The behavior of a number-theoretic function  $f(n)$  for large  $n$  is often difficult to determine because the function values can fluctuate considerably as  $n$  increases. It is more fruitful to study partial sums and seek asymptotic formulas of the form

$$27.11.1 \quad \sum_{n \leq x} f(n) = F(x) + O(g(x)),$$

where  $F(x)$  is a known function of  $x$ , and  $O(g(x))$  represents the error, a function of smaller order than  $F(x)$  for all  $x$  in some prescribed range. For example, Dirichlet (1849) proves that for all  $x \geq 1$ ,

$$27.11.2 \quad \sum_{n \leq x} d(n) = x \log x + (2\gamma - 1)x + O(\sqrt{x}),$$

where  $\gamma$  is Euler's constant (§5.2(ii)). *Dirichlet's divisor problem* (unsolved in 2009) is to determine the least number  $\theta_0$  such that the error term in (27.11.2) is  $O(x^\theta)$  for all  $\theta > \theta_0$ . Kolesnik (1969) proves that  $\theta_0 \leq \frac{12}{37}$ .

Equations (27.11.3)–(27.11.11) list further asymptotic formulas related to some of the functions listed in §27.2. They are valid for all  $x \geq 2$ . The error terms given here are not necessarily the best known.

$$27.11.3 \quad \sum_{n \leq x} \frac{d(n)}{n} = \frac{1}{2}(\log x)^2 + 2\gamma \log x + O(1),$$

where  $\gamma$  again is Euler's constant.

$$27.11.4 \quad \sum_{n \leq x} \sigma_1(n) = \frac{\pi^2}{12}x^2 + O(x \log x).$$

$$27.11.5 \quad \sum_{n \leq x} \sigma_\alpha(n) = \frac{\zeta(\alpha + 1)}{\alpha + 1}x^{\alpha+1} + O(x^\beta),$$

$$\alpha > 0, \alpha \neq 1, \beta = \max(1, \alpha).$$

$$27.11.6 \quad \sum_{n \leq x} \phi(n) = \frac{3}{\pi^2}x^2 + O(x \log x).$$

$$27.11.7 \quad \sum_{n \leq x} \frac{\phi(n)}{n} = \frac{6}{\pi^2}x + O(\log x).$$

$$27.11.8 \quad \sum_{p \leq x} \frac{1}{p} = \log \log x + A + O\left(\frac{1}{\log x}\right),$$

where  $A$  is a constant.

$$27.11.9 \quad \sum_{\substack{p \leq x \\ p \equiv h \pmod k}} \frac{1}{p} = \frac{1}{\phi(k)} \log \log x + B + O\left(\frac{1}{\log x}\right),$$

where  $(h, k) = 1$ ,  $k > 0$ , and  $B$  is a constant depending on  $h$  and  $k$ .

$$27.11.10 \quad \sum_{p \leq x} \frac{\log p}{p} = \log x + O(1).$$

$$27.11.11 \quad \sum_{\substack{p \leq x \\ p \equiv h \pmod k}} \frac{\log p}{p} = \frac{1}{\phi(k)} \log x + O(1),$$

where  $(h, k) = 1$ ,  $k > 0$ .

Letting  $x \rightarrow \infty$  in (27.11.9) or in (27.11.11) we see that there are infinitely many primes  $p \equiv h \pmod k$  if  $h, k$  are coprime; this is *Dirichlet's theorem on primes in arithmetic progressions*.

$$27.11.12 \quad \sum_{n \leq x} \mu(n) = O\left(xe^{-C\sqrt{\log x}}\right), \quad x \rightarrow \infty,$$

for some positive constant  $C$ ,

$$27.11.13 \quad \lim_{x \rightarrow \infty} \frac{1}{x} \sum_{n \leq x} \mu(n) = 0,$$

$$27.11.14 \quad \lim_{x \rightarrow \infty} \sum_{n \leq x} \frac{\mu(n)}{n} = 0,$$

$$27.11.15 \quad \lim_{x \rightarrow \infty} \sum_{n \leq x} \frac{\mu(n) \log n}{n} = -1.$$

Each of (27.11.13)–(27.11.15) is equivalent to the prime number theorem (27.2.3). *The prime number theorem for arithmetic progressions*—an extension of (27.2.3) and first proved in de la Vallée Poussin (1896a,b)—states that if  $(h, k) = 1$ , then the number of primes  $p \leq x$  with  $p \equiv h \pmod{k}$  is asymptotic to  $x/(\phi(k) \log x)$  as  $x \rightarrow \infty$ .

## 27.12 Asymptotic Formulas: Primes

$p_n$  is the  $n$ th prime, beginning with  $p_1 = 2$ .  $\pi(x)$  is the number of primes less than or equal to  $x$ .

$$27.12.1 \quad \lim_{n \rightarrow \infty} \frac{p_n}{n \log n} = 1,$$

$$27.12.2 \quad p_n > n \log n, \quad n = 1, 2, \dots$$

27.12.3

$$\pi(x) = [x] - 1 - \sum_{p_j \leq \sqrt{x}} \left\lfloor \frac{x}{p_j} \right\rfloor + \sum_{r \geq 2} (-1)^r \sum_{p_{j_1} < p_{j_2} < \dots < p_{j_r} \leq \sqrt{x}} \left\lfloor \frac{x}{p_{j_1} p_{j_2} \dots p_{j_r}} \right\rfloor, \quad x \geq 1,$$

where the series terminates when the product of the first  $r$  primes exceeds  $x$ .

As  $x \rightarrow \infty$

$$27.12.4 \quad \pi(x) \sim \sum_{k=1}^{\infty} \frac{(k-1)! x}{(\log x)^k}.$$

### Prime Number Theorem

There exists a positive constant  $c$  such that

27.12.5

$$|\pi(x) - \text{li}(x)| = O\left(x \exp\left(-c\sqrt{\log x}\right)\right), \quad x \rightarrow \infty.$$

For the logarithmic integral  $\text{li}(x)$  see (6.2.8). The best available asymptotic error estimate (2009) appears in Korobov (1958) and Vinogradov (1958): there exists a positive constant  $d$  such that

$$27.12.6 \quad \begin{aligned} & |\pi(x) - \text{li}(x)| \\ &= O\left(x \exp\left(-d(\log x)^{3/5} (\log \log x)^{-1/5}\right)\right). \end{aligned}$$

$\pi(x) - \text{li}(x)$  changes sign infinitely often as  $x \rightarrow \infty$ ; see Littlewood (1914), Bays and Hudson (2000).

The *Riemann hypothesis* (§25.10(i)) is equivalent to the statement that for every  $x \geq 2657$ ,

$$27.12.7 \quad |\pi(x) - \text{li}(x)| < \frac{1}{8\pi} \sqrt{x} \log x.$$

If  $a$  is relatively prime to the modulus  $m$ , then there are infinitely many primes congruent to  $a \pmod{m}$ .

The number of such primes not exceeding  $x$  is

$$27.12.8 \quad \frac{x}{\phi(m)} + O\left(x \exp\left(-\lambda(\alpha)(\log x)^{1/2}\right)\right), \quad m \leq (\log x)^\alpha, \alpha > 0,$$

where  $\lambda(\alpha)$  depends only on  $\alpha$ , and  $\phi(m)$  is the Euler totient function (§27.2).

A *Mersenne prime* is a prime of the form  $2^p - 1$ . The largest known prime (2009) is the Mersenne prime  $2^{43,112,609} - 1$ . For current records online, see <http://dlmf.nist.gov/27.12>.

A *pseudoprime test* is a test that correctly identifies most composite numbers. For example, if  $2^n \not\equiv 2 \pmod{n}$ , then  $n$  is composite. Descriptions and comparisons of pseudoprime tests are given in Bressoud and Wagon (2000, §§2.4, 4.2, and 8.2) and Crandall and Pomerance (2005, §§3.4–3.6).

A *Carmichael number* is a composite number  $n$  for which  $b^n \equiv b \pmod{n}$  for all  $b \in \mathbb{N}$ . There are infinitely many Carmichael numbers.

## Additive Number Theory

### 27.13 Functions

#### 27.13(i) Introduction

Whereas multiplicative number theory is concerned with functions arising from prime factorization, additive number theory treats functions related to addition of integers. The basic problem is that of expressing a given positive integer  $n$  as a sum of integers from some prescribed set  $S$  whose members are primes, squares, cubes, or other special integers. Each representation of  $n$  as a sum of elements of  $S$  is called a *partition* of  $n$ , and the number  $S(n)$  of such partitions is often of great interest. The subsections that follow describe problems from additive number theory. See also Apostol (1976, Chapter 14) and Apostol and Niven (1994, pp. 33–34).

#### 27.13(ii) Goldbach Conjecture

*Every even integer  $n > 4$  is the sum of two odd primes.*

In this case,  $S(n)$  is the number of solutions of the equation  $n = p + q$ , where  $p$  and  $q$  are odd primes. Goldbach's assertion is that  $S(n) \geq 1$  for all even  $n > 4$ . This conjecture dates back to 1742 and was undecided in 2009, although it has been confirmed numerically up to very large numbers. Vinogradov (1937) proves that every sufficiently large odd integer is the sum of three odd primes, and Chen (1966) shows that every sufficiently large even integer is the sum of a prime and a number with no more than two prime factors.

For an online account of the current status of Goldbach's conjecture see <http://dlmf.nist.gov/27.13.ii>.

**27.13(iii) Waring’s Problem**

This problem is named after Edward Waring who, in 1770, stated without proof and with limited numerical evidence, that every positive integer  $n$  is the sum of four squares, of nine cubes, of nineteen fourth powers, and so on. Waring’s problem is to find, for each positive integer  $k$ , whether there is an integer  $m$  (depending only on  $k$ ) such that the equation

$$27.13.1 \quad n = x_1^k + x_2^k + \cdots + x_m^k$$

has nonnegative integer solutions for all  $n \geq 1$ . The smallest  $m$  that exists for a given  $k$  is denoted by  $g(k)$ . Similarly,  $G(k)$  denotes the smallest  $m$  for which (27.13.1) has nonnegative integer solutions for all sufficiently large  $n$ .

Lagrange (1770) proves that  $g(2) = 4$ , and during the next 139 years the existence of  $g(k)$  was shown for  $k = 3, 4, 5, 6, 7, 8, 10$ . Hilbert (1909) proves the existence of  $g(k)$  for every  $k$  but does not determine its corresponding numerical value. The exact value of  $g(k)$  is now known for every  $k \leq 200,000$ . For example,  $g(3) = 9$ ,  $g(4) = 19$ ,  $g(5) = 37$ ,  $g(6) = 73$ ,  $g(7) = 143$ , and  $g(8) = 279$ . A general formula states that

$$27.13.2 \quad g(k) \geq 2^k + \left\lfloor \frac{3^k}{2^k} \right\rfloor - 2,$$

for all  $k \geq 2$ , with equality if  $4 \leq k \leq 200,000$ . If  $3^k = q2^k + r$  with  $0 < r < 2^k$ , then equality holds in (27.13.2) provided  $r + q \leq 2^k$ , a condition that is satisfied with at most a finite number of exceptions.

The existence of  $G(k)$  follows from that of  $g(k)$  because  $G(k) \leq g(k)$ , but only the values  $G(2) = 4$  and  $G(4) = 16$  are known exactly. Some upper bounds smaller than  $g(k)$  are known. For example,  $G(3) \leq 7$ ,  $G(5) \leq 23$ ,  $G(6) \leq 36$ ,  $G(7) \leq 53$ , and  $G(8) \leq 73$ . Hardy and Littlewood (1925) conjectures that  $G(k) < 2k + 1$  when  $k$  is not a power of 2, and that  $G(k) \leq 4k$  when  $k$  is a power of 2, but the most that is known (in 2009) is  $G(k) < ck \log k$  for some constant  $c$ . A survey is given in Ellison (1971).

**27.13(iv) Representation by Squares**

For a given integer  $k \geq 2$  the function  $r_k(n)$  is defined as the number of solutions of the equation

$$27.13.3 \quad n = x_1^2 + x_2^2 + \cdots + x_k^2,$$

where the  $x_j$  are integers, positive, negative, or zero, and the order of the summands is taken into account.

Jacobi (1829) notes that  $r_2(n)$  is the coefficient of  $x^n$  in the square of the theta function  $\vartheta(x)$ :

$$27.13.4 \quad \vartheta(x) = 1 + 2 \sum_{m=1}^{\infty} x^{m^2}, \quad |x| < 1.$$

(In §20.2(i),  $\vartheta(x)$  is denoted by  $\theta_3(0, x)$ .) Thus,

$$27.13.5 \quad (\vartheta(x))^2 = 1 + \sum_{n=1}^{\infty} r_2(n)x^n.$$

One of Jacobi’s identities implies that

$$27.13.6 \quad (\vartheta(x))^2 = 1 + 4 \sum_{n=1}^{\infty} (\delta_1(n) - \delta_3(n)) x^n,$$

where  $\delta_1(n)$  and  $\delta_3(n)$  are the number of divisors of  $n$  congruent respectively to 1 and 3 (mod 4), and by equating coefficients in (27.13.5) and (27.13.6) Jacobi deduced that

$$27.13.7 \quad r_2(n) = 4(\delta_1(n) - \delta_3(n)).$$

Hence  $r_2(5) = 8$  because both divisors, 1 and 5, are congruent to 1 (mod 4). In fact, there are four representations, given by  $5 = 2^2 + 1^2 = 2^2 + (-1)^2 = (-2)^2 + 1^2 = (-2)^2 + (-1)^2$ , and four more with the order of summands reversed.

By similar methods Jacobi proved that  $r_4(n) = 8\sigma_1(n)$  if  $n$  is odd, whereas, if  $n$  is even,  $r_4(n) = 24$  times the sum of the odd divisors of  $n$ . Mordell (1917) notes that  $r_k(n)$  is the coefficient of  $x^n$  in the power-series expansion of the  $k$ th power of the series for  $\vartheta(x)$ . Explicit formulas for  $r_k(n)$  have been obtained by similar methods for  $k = 6, 8, 10$ , and 12, but they are more complicated. Exact formulas for  $r_k(n)$  have also been found for  $k = 3, 5$ , and 7, and for all even  $k \leq 24$ . For values of  $k > 24$  the analysis of  $r_k(n)$  is considerably more complicated (see Hardy (1940)). Also, Milne (1996, 2002) announce new infinite families of explicit formulas extending Jacobi’s identities. For more than 8 squares, Milne’s identities are not the same as those obtained earlier by Mordell and others.

**27.14 Unrestricted Partitions**

**27.14(i) Partition Functions**

A fundamental problem studies the number of ways  $n$  can be written as a sum of positive integers  $\leq n$ , that is, the number of solutions of

$$27.14.1 \quad n = a_1 + a_2 + \cdots, \quad a_1 \geq a_2 \geq \cdots \geq 1.$$

The number of summands is unrestricted, repetition is allowed, and the order of the summands is not taken into account. The corresponding *unrestricted partition function* is denoted by  $p(n)$ , and the summands are called *parts*; see §26.9(i). For example,  $p(5) = 7$  because there are exactly seven partitions of 5:  $5 = 4 + 1 = 3 + 2 = 3 + 1 + 1 = 2 + 2 + 1 = 2 + 1 + 1 + 1 = 1 + 1 + 1 + 1 + 1$ .

The number of partitions of  $n$  into at most  $k$  parts is denoted by  $p_k(n)$ ; again see §26.9(i).

**27.14(ii) Generating Functions and Recursions**

Euler introduced the reciprocal of the infinite product

$$27.14.2 \quad f(x) = \prod_{m=1}^{\infty} (1 - x^m), \quad |x| < 1,$$

as a generating function for the function  $p(n)$  defined in §27.14(i):

$$27.14.3 \quad \frac{1}{f(x)} = \sum_{n=0}^{\infty} p(n)x^n,$$

with  $p(0) = 1$ . Euler's *pentagonal number theorem* states that

$$27.14.4 \quad \begin{aligned} f(x) &= 1 - x - x^2 + x^5 + x^7 - x^{12} - x^{15} + \dots \\ &= 1 + \sum_{k=1}^{\infty} (-1)^k \left( x^{\omega(k)} + x^{\omega(-k)} \right), \end{aligned}$$

where the exponents 1, 2, 5, 7, 12, 15, ... are the *pentagonal numbers*, defined by

$$27.14.5 \quad \omega(\pm k) = (3k^2 \mp k)/2, \quad k = 1, 2, 3, \dots$$

Multiplying the power series for  $f(x)$  with that for  $1/f(x)$  and equating coefficients, we obtain the recursion formula

$$27.14.6 \quad \begin{aligned} p(n) &= \sum_{k=1}^{\infty} (-1)^{k+1} (p(n - \omega(k)) + p(n - \omega(-k))) \\ &= p(n - 1) + p(n - 2) - p(n - 5) - p(n - 7) + \dots, \end{aligned}$$

where  $p(k)$  is defined to be 0 if  $k < 0$ . Logarithmic differentiation of the generating function  $1/f(x)$  leads to another recursion:

$$27.14.7 \quad n p(n) = \sum_{k=1}^n \sigma_1(n) p(n - k),$$

where  $\sigma_1(n)$  is defined by (27.2.10) with  $\alpha = 1$ .

**27.14(iii) Asymptotic Formulas**

These recursions can be used to calculate  $p(n)$ , which grows very rapidly. For example,  $p(10) = 42, p(100) = 1905\ 69292$ , and  $p(200) = 397\ 29990\ 29388$ . For large  $n$

$$27.14.8 \quad p(n) \sim e^{K\sqrt{n}} / (4n\sqrt{3}),$$

where  $K = \pi\sqrt{2/3}$  (Hardy and Ramanujan (1918)). Rademacher (1938) derives a convergent series that also provides an asymptotic expansion for  $p(n)$ :

$$27.14.9 \quad \begin{aligned} p(n) &= \frac{1}{\pi\sqrt{2}} \sum_{k=1}^{\infty} \sqrt{k} A_k(n) \left[ \frac{d \sinh(K\sqrt{t}/k)}{dt \sqrt{t}} \right]_{t=n-(1/24)}, \end{aligned}$$

where

$$27.14.10 \quad A_k(n) = \sum_{\substack{h=1 \\ (h,k)=1}}^k \exp\left(\pi i s(h, k) - 2\pi i n \frac{h}{k}\right),$$

and  $s(h, k)$  is a *Dedekind sum* given by

$$27.14.11 \quad s(h, k) = \sum_{r=1}^{k-1} \frac{r}{k} \left( \frac{hr}{k} - \left\lfloor \frac{hr}{k} \right\rfloor - \frac{1}{2} \right).$$

**27.14(iv) Relation to Modular Functions**

Dedekind sums occur in the transformation theory of the *Dedekind modular function*  $\eta(\tau)$ , defined by

$$27.14.12 \quad \eta(\tau) = e^{\pi i \tau / 12} \prod_{n=1}^{\infty} (1 - e^{2\pi i n \tau}), \quad \Im \tau > 0.$$

This is related to the function  $f(x)$  in (27.14.2) by

$$27.14.13 \quad \eta(\tau) = e^{\pi i \tau / 12} f(e^{2\pi i \tau}).$$

$\eta(\tau)$  satisfies the following functional equation: if  $a, b, c, d$  are integers with  $ad - bc = 1$  and  $c > 0$ , then

$$27.14.14 \quad \eta\left(\frac{a\tau + b}{c\tau + d}\right) = \varepsilon(-i(c\tau + d))^{\frac{1}{2}} \eta(\tau),$$

where  $\varepsilon = \exp(\pi i(((a + d)/(12c)) - s(d, c)))$  and  $s(d, c)$  is given by (27.14.11).

For further properties of the function  $\eta(\tau)$  see §§23.15–23.19.

**27.14(v) Divisibility Properties**

Ramanujan (1921) gives identities that imply divisibility properties of the partition function. For example, the Ramanujan identity

$$27.14.15 \quad 5 \frac{(f(x^5))^5}{(f(x))^6} = \sum_{n=0}^{\infty} p(5n + 4)x^n$$

implies  $p(5n + 4) \equiv 0 \pmod{5}$ . Ramanujan also found that  $p(7n + 5) \equiv 0 \pmod{7}$  and  $p(11n + 6) \equiv 0 \pmod{11}$  for all  $n$ . After decades of nearly fruitless searching for further congruences of this type, it was believed that no others existed, until it was shown in Ono (2000) that there are infinitely many. Ono proved that for every prime  $q > 3$  there are integers  $a$  and  $b$  such that  $p(an + b) \equiv 0 \pmod{q}$  for all  $n$ . For example,  $p(1575\ 25693n + 1\ 11247) \equiv 0 \pmod{13}$ .

**27.14(vi) Ramanujan's Tau Function**

The *discriminant function*  $\Delta(\tau)$  is defined by

$$27.14.16 \quad \Delta(\tau) = (2\pi)^{12} (\eta(\tau))^{24}, \quad \Im \tau > 0,$$

and satisfies the functional equation

$$27.14.17 \quad \Delta\left(\frac{a\tau + b}{c\tau + d}\right) = (c\tau + d)^{12} \Delta(\tau),$$

if  $a, b, c, d$  are integers with  $ad - bc = 1$  and  $c > 0$ .

The 24th power of  $\eta(\tau)$  in (27.14.12) with  $e^{2\pi i \tau} = x$  is an infinite product that generates a power series in

$x$  with integer coefficients called *Ramanujan's tau function*  $\tau(n)$ :

$$27.14.18 \quad x \prod_{n=1}^{\infty} (1 - x^n)^{24} = \sum_{n=1}^{\infty} \tau(n)x^n, \quad |x| < 1.$$

The tau function is multiplicative and satisfies the more general relation:

$$27.14.19 \quad \tau(m)\tau(n) = \sum_{d|(m,n)} d^{11} \tau\left(\frac{mn}{d^2}\right), \quad m, n = 1, 2, \dots$$

Lehmer (1947) conjectures that  $\tau(n)$  is never 0 and verifies this for all  $n < 21\,49286\,39999$  by studying various congruences satisfied by  $\tau(n)$ , for example:

$$27.14.20 \quad \tau(n) \equiv \sigma_{11}(n) \pmod{691}.$$

For further information on partitions and generating functions see Andrews (1976); also §§17.2–17.14, and §§26.9–26.10.

## Applications

### 27.15 Chinese Remainder Theorem

The Chinese remainder theorem states that a system of congruences  $x \equiv a_1 \pmod{m_1}, \dots, x \equiv a_k \pmod{m_k}$ , always has a solution if the moduli are relatively prime in pairs; the solution is unique  $\pmod{m}$ , where  $m$  is the product of the moduli.

This theorem is employed to increase efficiency in calculating with large numbers by making use of smaller numbers in most of the calculation. For example, suppose a lengthy calculation involves many 10-digit integers. Most of the calculation can be done with five-digit integers as follows. Choose four relatively prime moduli  $m_1, m_2, m_3$ , and  $m_4$  of five digits each, for example  $2^{16} - 3$ ,  $2^{16} - 1$ ,  $2^{16} + 1$ , and  $2^{16} + 3$ . Their product  $m$  has 20 digits, twice the number of digits in the data. By the Chinese remainder theorem each integer in the data can be uniquely represented by its residues  $\pmod{m_1}$ ,  $\pmod{m_2}$ ,  $\pmod{m_3}$ , and  $\pmod{m_4}$ , respectively. Because each residue has no more than five digits, the arithmetic can be performed efficiently on these residues with respect to each of the moduli, yielding answers  $a_1 \pmod{m_1}$ ,  $a_2 \pmod{m_2}$ ,  $a_3 \pmod{m_3}$ , and  $a_4 \pmod{m_4}$ , where each  $a_j$  has no more than five digits. These numbers, in turn, are combined by the Chinese remainder theorem to obtain the final result  $\pmod{m}$ , which is correct to 20 digits.

Even though the lengthy calculation is repeated four times, once for each modulus, most of it only uses five-digit integers and is accomplished quickly without overwhelming the machine's memory. Details of a machine

program describing the method together with typical numerical results can be found in Newman (1967). See also Apostol and Niven (1994, pp. 18–19).

### 27.16 Cryptography

Applications to cryptography rely on the disparity in computer time required to find large primes and to factor large integers.

For example, a code maker chooses two large primes  $p$  and  $q$  of about 100 decimal digits each. Procedures for finding such primes require very little computer time. The primes are kept secret but their product  $n = pq$ , a 200-digit number, is made public. For this reason, these are often called public key codes. Messages are coded by a method (described below) that requires only the knowledge of  $n$ . But to decode, both factors  $p$  and  $q$  must be known. With the most efficient computer techniques devised to date (2009), factoring a 200-digit number may require billions of years on a single computer. For this reason, the codes are considered unbreakable, at least with the current state of knowledge on factoring large numbers.

To code a message by this method, we replace each letter by two digits, say  $A = 01, B = 02, \dots, Z = 26$ , and divide the message into pieces of convenient length smaller than the public value  $n = pq$ . Choose a prime  $r$  that does not divide either  $p - 1$  or  $q - 1$ . Like  $n$ , the prime  $r$  is made public. To code a piece  $x$ , raise  $x$  to the power  $r$  and reduce  $x^r$  modulo  $n$  to obtain an integer  $y$  (the coded form of  $x$ ) between 1 and  $n$ . Thus,  $y \equiv x^r \pmod{n}$  and  $1 \leq y < n$ .

To decode, we must recover  $x$  from  $y$ . To do this, let  $s$  denote the reciprocal of  $r$  modulo  $\phi(n)$ , so that  $rs = 1 + t\phi(n)$  for some integer  $t$ . (Here  $\phi(n)$  is Euler's totient (§27.2).) By the Euler–Fermat theorem (27.2.8),  $x^{\phi(n)} \equiv 1 \pmod{n}$ ; hence  $x^{t\phi(n)} \equiv 1 \pmod{n}$ . But  $y^s \equiv x^{rs} \equiv x^{1+t\phi(n)} \equiv x \pmod{n}$ , so  $y^s$  is the same as  $x$  modulo  $n$ . In other words, to recover  $x$  from  $y$  we simply raise  $y$  to the power  $s$  and reduce modulo  $n$ . If  $p$  and  $q$  are known,  $s$  and  $y^s$  can be determined  $\pmod{n}$  by straightforward calculations that require only a few minutes of machine time. But if  $p$  and  $q$  are not known, the problem of recovering  $x$  from  $y$  seems insurmountable.

For further information see Apostol and Niven (1994, p. 24), and for other applications to cryptography see Menezes *et al.* (1997) and Schroeder (2006).

### 27.17 Other Applications

Reed *et al.* (1990, pp. 458–470) describes a number-theoretic approach to Fourier analysis (called the *arithmetic Fourier transform*) that uses the Möbius inversion



(27.5.7) to increase efficiency in computing coefficients of Fourier series.

Congruences are used in constructing perpetual calendars, splicing telephone cables, scheduling round-robin tournaments, devising systematic methods for storing computer files, and generating pseudorandom numbers. Rosen (2004, Chapters 5 and 10) describes many of these applications. Apostol and Zuckerman (1951) uses congruences to construct magic squares.

There are also applications of number theory in many diverse areas, including physics, biology, chemistry, communications, and art. Schroeder (2006) describes many of these applications, including the design of concert hall ceilings to scatter sound into broad lateral patterns for improved acoustic quality, precise measurements of delays of radar echoes from Venus and Mercury to confirm one of the relativistic effects predicted by Einstein's theory of general relativity, and the use of primes in creating artistic graphical designs.

## Computation

### 27.18 Methods of Computation: Primes

An overview of methods for precise counting of the number of primes not exceeding an arbitrary integer  $x$  is given in Crandall and Pomerance (2005, §3.7). T. Oliveira e Silva has calculated  $\pi(x)$  for  $x = 10^{23}$ , using the combinatorial methods of Lagarias *et al.* (1985) and Deléglise and Rivat (1996); see Oliveira e Silva (2006). An analytic approach using a contour integral of the Riemann zeta function (§25.2(i)) is discussed in Borwein *et al.* (2000).

The *Sieve of Eratosthenes* (Crandall and Pomerance (2005, §3.2)) generates a list of all primes below a given bound. An alternative procedure is the *binary quadratic sieve* of Atkin and Bernstein (Crandall and Pomerance (2005, p. 170)).

For small values of  $n$ , primality is proven by showing that  $n$  is not divisible by any prime not exceeding  $\sqrt{n}$ .

Two simple algorithms for proving primality require a knowledge of all or part of the factorization of  $n - 1, n + 1$ , or both; see Crandall and Pomerance (2005, §§4.1–4.2). These algorithms are used for testing primality of *Mersenne numbers*,  $2^n - 1$ , and *Fermat numbers*,  $2^{2^n} + 1$ .

The *APR (Adleman–Pomerance–Rumely)* algorithm for primality testing is based on Jacobi sums. It runs in time  $O((\log n)^{c \log \log \log n})$ . Explanations are given in Cohen (1993, §9.1) and Crandall and Pomerance (2005, §4.4). A practical version is described in Bosma and van der Hulst (1990).

The *AKS (Agrawal–Kayal–Saxena)* algorithm is the first deterministic, polynomial-time, primality test. That is to say, it runs in time  $O((\log n)^c)$  for some constant  $c$ . An explanation is given in Crandall and Pomerance (2005, §4.5).

The *ECPP (Elliptic Curve Primality Proving)* algorithm handles primes with over 20,000 digits. Explanations are given in Cohen (1993, §9.2) and Crandall and Pomerance (2005, §7.6).

### 27.19 Methods of Computation: Factorization

Techniques for factorization of integers fall into three general classes: *Deterministic algorithms*, *Type I probabilistic algorithms* whose expected running time depends on the size of the smallest prime factor, and *Type II probabilistic algorithms* whose expected running time depends on the size of the number to be factored.

Deterministic algorithms are slow but are guaranteed to find the factorization within a known period of time. Trial division is one example. Fermat's algorithm is another; see Bressoud (1989, §5.1).

Type I probabilistic algorithms include the *Brent–Pollard rho algorithm* (also called *Monte Carlo method*), the *Pollard  $p - 1$  algorithm*, and the *Elliptic Curve Method* (ECM). Descriptions of these algorithms are given in Crandall and Pomerance (2005, §§5.2, 5.4, and 7.4). As of January 2009 the largest prime factors found by these methods are a 19-digit prime for Brent–Pollard rho, a 58-digit prime for Pollard  $p - 1$ , and a 67-digit prime for ECM.

Type II probabilistic algorithms for factoring  $n$  rely on finding a pseudo-random pair of integers  $(x, y)$  that satisfy  $x^2 \equiv y^2 \pmod{n}$ . These algorithms include the *Continued Fraction Algorithm* (CFRAC), the *Multiple Polynomial Quadratic Sieve* (MPQS), the *General Number Field Sieve* (GNFS), and the *Special Number Field Sieve* (SNFS). A description of CFRAC is given in Bressoud and Wagon (2000). Descriptions of MPQS, GNFS, and SNFS are given in Crandall and Pomerance (2005, §§6.1 and 6.2). As of January 2009 the SNFS holds the record for the largest integer that has been factored by a Type II probabilistic algorithm, a 307-digit composite integer. The SNFS can be applied only to numbers that are very close to a power of a very small base. The largest composite numbers that have been factored by other Type II probabilistic algorithms are a 63-digit integer by CFRAC, a 135-digit integer by MPQS, and a 182-digit integer by GNFS.

For further information see Crandall and Pomerance (2005) and §26.22.

For current records online, see <http://dlmf.nist.gov/27.19>.

## 27.20 Methods of Computation: Other Number-Theoretic Functions

To calculate a multiplicative function it suffices to determine its values at the prime powers and then use (27.3.2). For a completely multiplicative function we use the values at the primes together with (27.3.10). The recursion formulas (27.14.6) and (27.14.7) can be used to calculate the partition function  $p(n)$ . A similar recursion formula obtained by differentiating (27.14.18) can be used to calculate Ramanujan's function  $\tau(n)$ , and the values can be checked by the congruence (27.14.20).

For further information see Lehmer (1941, pp. 5–83) and Lehmer (1943, pp. 483–492).

### 27.21 Tables

Lehmer (1914) lists all primes up to 100 06721. Bresoud and Wagon (2000, pp. 103–104) supplies tables and graphs that compare  $\pi(x)$ ,  $x/\log x$ , and  $\text{li}(x)$ . Glaisher (1940) contains four tables: Table I tabulates, for all  $n \leq 10^4$ : (a) the canonical factorization of  $n$  into powers of primes; (b) the Euler totient  $\phi(n)$ ; (c) the divisor function  $d(n)$ ; (d) the sum  $\sigma(n)$  of these divisors. Table II lists all solutions  $n$  of the equation  $f(n) = m$  for all  $m \leq 2500$ , where  $f(n)$  is defined by (27.14.2). Table III lists all solutions  $n \leq 10^4$  of the equation  $d(n) = m$ , and Table IV lists all solutions  $n$  of the equation  $\sigma(n) = m$  for all  $m \leq 10^4$ . Table 24.7 of Abramowitz and Stegun (1964) also lists the factorizations in Glaisher's Table I(a); Table 24.6 lists  $\phi(n)$ ,  $d(n)$ , and  $\sigma(n)$  for  $n \leq 1000$ ; Table 24.8 gives examples of primitive roots of all primes  $\leq 9973$ ; Table 24.9 lists all primes that are less than 1 00000.

The partition function  $p(n)$  is tabulated in Gupta (1935, 1937), Watson (1937), and Gupta *et al.* (1958). Tables of the Ramanujan function  $\tau(n)$  are published in Lehmer (1943) and Watson (1949). Lehmer (1941) gives a comprehensive account of tables in the theory of numbers, including virtually every table published from 1918 to 1941. Those published prior to 1918 are mentioned in Dickson (1919). The bibliography in Lehmer (1941) gives references to the places in Dickson's History where the older tables are cited. Lehmer (1941) also has a section that supplies errata and corrections to all tables cited.

No sequel to Lehmer (1941) exists to date, but many tables of functions of number theory are included in Unpublished Mathematical Tables (1944).

### 27.22 Software

See <http://dlmf.nist.gov/27.22>.

## References

### General References

The main references used in writing this chapter are Apostol (1976, 1990), and Apostol and Niven (1994). Further information can be found in Andrews (1976), Erdélyi *et al.* (1955, Chapter XVII), Hardy and Wright (1979), and Niven *et al.* (1991).

### Sources

The following list gives the references or other indications of proofs that were used in constructing the various sections of this chapter. These sources supplement the references quoted in the text.

- §27.2 Apostol (1976, Chapter 2). For (27.2.11) see Erdélyi *et al.* (1955, p. 168). Tables 27.2.1 and 27.2.2 are from Abramowitz and Stegun (1964, Tables 24.6 and 24.9).
- §27.3 Apostol (1976, Chapter 2).
- §27.4 Apostol (1976, Chapter 11). For (27.4.10) see Titchmarsh (1986b, p. 4).
- §27.5 Apostol (1976, Chapter 2 and p. 228). For (27.5.7) use (27.5.2) and formal substitution.
- §27.6 Apostol (1976, Chapter 2).
- §27.7 Apostol (1990, Chapter 1).
- §27.8 Apostol (1976, Chapter 6).
- §27.9 Apostol (1976, Chapter 9).
- §27.10 Apostol (1976, Chapter 8).
- §27.11 Apostol (1976, Chapters 3, 4). For (27.11.12), (27.11.14), and (27.11.15) see Prachar (1957, pp. 71–74).
- §27.12 Crandall and Pomerance (2005, pp. 131–152), Davenport (2000), Narkiewicz (2000), Rosser (1939). For (27.12.7) see Schoenfeld (1976) and Crandall and Pomerance (2005, pp. 37, 60). For the proof that there are infinitely many Carmichael numbers see Alford *et al.* (1994).
- §27.13 Apostol (1976, Chapter 14), Ellison (1971), Grosswald (1985, pp. 8, 32). For (27.13.4) see (20.2.3).
- §27.14(ii) Apostol (1976, Chapter 14), Apostol (1990, Chapters 3–5).



## Chapter 28

# Mathieu Functions and Hill's Equation

G. Wolf<sup>1</sup>

<b>Notation</b>	<b>652</b>		
28.1 Special Notation . . . . .	652	28.21 Graphics . . . . .	669
<b>Mathieu Functions of Integer Order</b>	<b>652</b>	28.22 Connection Formulas . . . . .	669
28.2 Definitions and Basic Properties . . . . .	652	28.23 Expansions in Series of Bessel Functions .	670
28.3 Graphics . . . . .	655	28.24 Expansions in Series of Cross-Products of Bessel Functions or Modified Bessel Func- tions . . . . .	671
28.4 Fourier Series . . . . .	656	28.25 Asymptotic Expansions for Large $\Re z$ . . .	672
28.5 Second Solutions $fe_n, ge_n$ . . . . .	657	28.26 Asymptotic Approximations for Large $q$ .	672
28.6 Expansions for Small $q$ . . . . .	659	28.27 Addition Theorems . . . . .	672
28.7 Analytic Continuation of Eigenvalues . . .	661	28.28 Integrals, Integral Representations, and In- tegral Equations . . . . .	672
28.8 Asymptotic Expansions for Large $q$ . . . .	661	<b>Hill's Equation</b>	<b>674</b>
28.9 Zeros . . . . .	663	28.29 Definitions and Basic Properties . . . . .	674
28.10 Integral Equations . . . . .	663	28.30 Expansions in Series of Eigenfunctions . .	676
28.11 Expansions in Series of Mathieu Functions	664	28.31 Equations of Whittaker–Hill and Ince . .	676
<b>Mathieu Functions of Noninteger Order</b>	<b>664</b>	<b>Applications</b>	<b>677</b>
28.12 Definitions and Basic Properties . . . . .	664	28.32 Mathematical Applications . . . . .	677
28.13 Graphics . . . . .	665	28.33 Physical Applications . . . . .	678
28.14 Fourier Series . . . . .	666	<b>Computation</b>	<b>679</b>
28.15 Expansions for Small $q$ . . . . .	666	28.34 Methods of Computation . . . . .	679
28.16 Asymptotic Expansions for Large $q$ . . . .	666	28.35 Tables . . . . .	680
28.17 Stability as $x \rightarrow \pm\infty$ . . . . .	667	28.36 Software . . . . .	681
28.18 Integrals and Integral Equations . . . . .	667	<b>References</b>	<b>681</b>
28.19 Expansions in Series of $me_{\nu+2n}$ Functions	667		
<b>Modified Mathieu Functions</b>	<b>667</b>		
28.20 Definitions and Basic Properties . . . . .	667		

<sup>1</sup>Fachbereich Mathematik, University Duisburg-Essen, Essen, Germany.

**Acknowledgments:** This chapter is based in part on Abramowitz and Stegun (1964, Chapter 20) by G. Blanch.  
**Copyright** © 2009 National Institute of Standards and Technology. All rights reserved.

## Notation

### 28.1 Special Notation

(For other notation see pp. [xiv](#) and [873](#).)

$m, n$	integers.
$x, y$	real variables.
$z = x + iy$	complex variable.
$\nu$	order of the Mathieu function or modified Mathieu function. (When $\nu$ is an integer it is often replaced by $n$ .)
$\delta$	arbitrary small positive number.
$a, q, h$	real or complex parameters of Mathieu's equation with $q = h^2$ .
primes	unless indicated otherwise, derivatives with respect to the argument

The main functions treated in this chapter are the Mathieu functions

$$ce_\nu(z, q), se_\nu(z, q), fe_n(z, q), ge_n(z, q), me_\nu(z, q),$$

and the modified Mathieu functions

$$\begin{matrix} Ce_\nu(z, q), & Se_\nu(z, q), & Fe_n(z, q), & Ge_n(z, q), \\ Me_\nu(z, q), & M_\nu^{(j)}(z, h), & Mc_n^{(j)}(z, h), & Ms_n^{(j)}(z, h), \\ Ie_n(z, h), & Io_n(z, h), & Ke_n(z, h), & Ko_n(z, h). \end{matrix}$$

The functions  $Mc_n^{(j)}(z, h)$  and  $Ms_n^{(j)}(z, h)$  are also known as the radial Mathieu functions.

The eigenvalues of Mathieu's equation are denoted by

$$a_n(q), \quad b_n(q), \quad \lambda_\nu(q).$$

The notation for the joining factors is

$$ge_n(h), \quad go_n(h), \quad fe_n(h), \quad fo_n(h).$$

Alternative notations for the parameters  $a$  and  $q$  are shown in Table [28.1.1](#).

Table 28.1.1: Notations for parameters in Mathieu's equation.

Reference	$a$	$q$
Erdélyi <i>et al.</i> (1955)	$h$	$\theta$
Meixner and Schäfer (1954)	$\lambda$	$h^2$
Moon and Spencer (1971)	$\lambda$	$q$
Strutt (1932)	$\lambda$	$h^2$
Whittaker and Watson (1927)	$a$	$8q$

Alternative notations for the functions are as follows.

#### Arcscott (1964b) and McLachlan (1947)

$$\begin{aligned} Fey_n(z, q) &= \sqrt{\frac{1}{2}\pi} ge_{e,n}(h) ce_n(0, q) Mc_n^{(2)}(z, h), \\ Me_n^{(1,2)}(z, q) &= \sqrt{\frac{1}{2}\pi} ge_{e,n}(h) ce_n(0, q) Mc_n^{(3,4)}(z, h), \\ Gey_n(z, q) &= \sqrt{\frac{1}{2}\pi} go_{o,n}(h) se'_n(0, q) Ms_n^{(2)}(z, h), \\ Ne_n^{(1,2)}(z, q) &= \sqrt{\frac{1}{2}\pi} go_{o,n}(h) se'_n(0, q) Ms_n^{(3,4)}(z, h). \end{aligned}$$

Arcscott (1964b) also uses  $-i\mu$  for  $\nu$ .

#### Campbell (1955)

$$\begin{matrix} in_n = fe_n, & ceh_n = Ce_n, & inh_n = Fe_n, \\ jn_n = ge_n, & seh_n = Se_n, & jnh_n = Ge_n. \end{matrix}$$

#### Abramowitz and Stegun (1964, Chapter 20)

$$F_\nu(z) = Me_\nu(z, q).$$

#### NBS (1967)

With  $s = 4q$ ,

$$Se_n(s, z) = \frac{ce_n(z, q)}{ce_n(0, q)}, \quad So_n(s, z) = \frac{se_n(z, q)}{se'_n(0, q)}.$$

#### Stratton et al. (1941)

With  $c = 2\sqrt{q}$ ,

$$Se_n(c, z) = \frac{ce_n(z, q)}{ce_n(0, q)}, \quad So_n(c, z) = \frac{se_n(z, q)}{se'_n(0, q)}.$$

#### Zhang and Jin (1996)

The radial functions  $Mc_n^{(j)}(z, h)$  and  $Ms_n^{(j)}(z, h)$  are denoted by  $Mc_n^{(j)}(z, q)$  and  $Ms_n^{(j)}(z, q)$ , respectively.

## Mathieu Functions of Integer Order

### 28.2 Definitions and Basic Properties

#### 28.2(i) Mathieu's Equation

The *standard form* of Mathieu's equation with parameters  $(a, q)$  is

**28.2.1**  $w'' + (a - 2q \cos(2z))w = 0.$

With  $\zeta = \sin^2 z$  we obtain the *algebraic form* of Mathieu's equation

**28.2.2**

$$\zeta(1 - \zeta)w'' + \frac{1}{2}(1 - 2\zeta)w' + \frac{1}{4}(a - 2q(1 - 2\zeta))w = 0.$$

This equation has regular singularities at 0 and 1, both with exponents 0 and  $\frac{1}{2}$ , and an irregular singular point at  $\infty$ . With  $\zeta = \cos z$  we obtain another algebraic form:

**28.2.3**  $(1 - \zeta^2)w'' - \zeta w' + (a + 2q - 4q\zeta^2)w = 0.$

**28.2(ii) Basic Solutions  $w_I, w_{II}$**

Since (28.2.1) has no finite singularities its solutions are entire functions of  $z$ . Furthermore, a solution  $w$  with given initial constant values of  $w$  and  $w'$  at a point  $z_0$  is an entire function of the three variables  $z, a,$  and  $q$ .

The following three transformations

**28.2.4**  $z \rightarrow -z; \quad z \rightarrow z \pm \pi; \quad z \rightarrow z \pm \frac{1}{2}\pi, q \rightarrow -q;$

each leave (28.2.1) unchanged. (28.2.1) possesses a fundamental pair of solutions  $w_I(z; a, q), w_{II}(z; a, q)$  called *basic solutions* with

**28.2.5** 
$$\begin{bmatrix} w_I(0; a, q) & w_{II}(0; a, q) \\ w_I'(0; a, q) & w_{II}'(0; a, q) \end{bmatrix} = \begin{bmatrix} 1 & 0 \\ 0 & 1 \end{bmatrix}.$$

$w_I(z; a, q)$  is even and  $w_{II}(z; a, q)$  is odd. Other properties are as follows.

**28.2.6**  $\mathscr{W} \{w_I, w_{II}\} = 1,$

**28.2.7** 
$$w_I(z \pm \pi; a, q) = w_I(\pi; a, q)w_I(z; a, q) \pm w_I'(\pi; a, q)w_{II}(z; a, q),$$

**28.2.8** 
$$w_{II}(z \pm \pi; a, q) = \pm w_{II}(\pi; a, q)w_I(z; a, q) + w_{II}'(\pi; a, q)w_{II}(z; a, q),$$

**28.2.9**  $w_I(\pi; a, q) = w_{II}'(\pi; a, q),$

**28.2.10**  $w_I(\pi; a, q) - 1 = 2w_I'(\frac{1}{2}\pi; a, q)w_{II}(\frac{1}{2}\pi; a, q),$

**28.2.11**  $w_I(\pi; a, q) + 1 = 2w_I(\frac{1}{2}\pi; a, q)w_{II}'(\frac{1}{2}\pi; a, q),$

**28.2.12**  $w_I'(\pi; a, q) = 2w_I(\frac{1}{2}\pi; a, q)w_I'(\frac{1}{2}\pi; a, q),$

**28.2.13**  $w_{II}(\pi; a, q) = 2w_{II}(\frac{1}{2}\pi; a, q)w_{II}'(\frac{1}{2}\pi; a, q).$

**28.2(iii) Floquet's Theorem and the Characteristic Exponents**

Let  $\nu$  be any real or complex constant. Then Mathieu's equation (28.2.1) has a nontrivial solution  $w(z)$  such that

**28.2.14**  $w(z + \pi) = e^{\pi i\nu} w(z),$

iff  $e^{\pi i\nu}$  is an eigenvalue of the matrix

**28.2.15** 
$$\begin{bmatrix} w_I(\pi; a, q) & w_{II}(\pi; a, q) \\ w_I'(\pi; a, q) & w_{II}'(\pi; a, q) \end{bmatrix}.$$

Equivalently,

**28.2.16**  $\cos(\pi\nu) = w_I(\pi; a, q) = w_I(\pi; a, -q).$

This is the *characteristic equation* of Mathieu's equation (28.2.1).  $\cos(\pi\nu)$  is an entire function of  $a, q^2$ . The solutions of (28.2.16) are given by  $\nu = \pi^{-1} \arccos(w_I(\pi; a, q))$ . If the inverse cosine takes its principal value (§4.23(ii)), then  $\nu = \hat{\nu}$ , where  $0 \leq \Re \hat{\nu} \leq 1$ . The general solution of (28.2.16) is  $\nu = \pm \hat{\nu} + 2n$ , where  $n \in \mathbb{Z}$ . Either  $\hat{\nu}$  or  $\nu$  is called a *characteristic exponent* of (28.2.1). If  $\hat{\nu} = 0$  or  $1$ , or equivalently,  $\nu = n$ , then  $\nu$  is a double root of the characteristic equation, otherwise it is a simple root.

**28.2(iv) Floquet Solutions**

A solution with the *pseudoperiodic property* (28.2.14) is called a *Floquet solution with respect to  $\nu$* . (28.2.9), (28.2.16), and (28.2.7) give for each solution  $w(z)$  of (28.2.1) the connection formula

**28.2.17**  $w(z + \pi) + w(z - \pi) = 2 \cos(\pi\nu)w(z).$

Therefore a nontrivial solution  $w(z)$  is either a Floquet solution with respect to  $\nu$ , or  $w(z + \pi) - e^{i\nu\pi}w(z)$  is a Floquet solution with respect to  $-\nu$ .

If  $q \neq 0$ , then for a given value of  $\nu$  the corresponding Floquet solution is unique, except for an arbitrary constant factor (Theorem of Ince; see also 28.5(i)).

The Fourier series of a Floquet solution

**28.2.18** 
$$w(z) = \sum_{n=-\infty}^{\infty} c_{2n} e^{i(\nu+2n)z}$$

converges absolutely and uniformly in compact subsets of  $\mathbb{C}$ . The coefficients  $c_{2n}$  satisfy

**28.2.19** 
$$qc_{2n+2} - (a - (\nu + 2n)^2) c_{2n} + qc_{2n-2} = 0, \quad n \in \mathbb{Z}.$$

Conversely, a nontrivial solution  $c_{2n}$  of (28.2.19) that satisfies

**28.2.20** 
$$\lim_{n \rightarrow \pm\infty} |c_{2n}|^{1/|n|} = 0$$

leads to a Floquet solution.

**28.2(v) Eigenvalues  $a_n, b_n$**

For given  $\nu$  and  $q$ , equation (28.2.16) determines an infinite discrete set of values of  $a$ , the *eigenvalues* or *characteristic values*, of Mathieu's equation. When  $\hat{\nu} = 0$  or  $1$ , the notation for the two sets of eigenvalues corresponding to each  $\hat{\nu}$  is shown in Table 28.2.1, together with the boundary conditions of the associated eigenvalue problem. In Table 28.2.1  $n = 0, 1, 2, \dots$

Table 28.2.1: Eigenvalues of Mathieu's equation.

$\hat{\nu}$	Boundary Conditions	Eigenvalues
0	$w'(0) = w'(\frac{1}{2}\pi) = 0$	$a_{2n}(q)$
1	$w'(0) = w(\frac{1}{2}\pi) = 0$	$a_{2n+1}(q)$
1	$w(0) = w'(\frac{1}{2}\pi) = 0$	$b_{2n+1}(q)$
0	$w(0) = w(\frac{1}{2}\pi) = 0$	$b_{2n+2}(q)$

An equivalent formulation is given by

**28.2.21** 
$$w_I'(\frac{1}{2}\pi; a, q) = 0, \quad a = a_{2n}(q),$$

$$w_I(\frac{1}{2}\pi; a, q) = 0, \quad a = a_{2n+1}(q),$$

and

**28.2.22** 
$$w_{II}'(\frac{1}{2}\pi; a, q) = 0, \quad a = b_{2n+1}(q),$$

$$w_{II}(\frac{1}{2}\pi; a, q) = 0, \quad a = b_{2n+2}(q),$$

where  $n = 0, 1, 2, \dots$ . When  $q = 0$ ,

**28.2.23**  $a_n(0) = n^2, \quad n = 0, 1, 2, \dots,$

**28.2.24**  $b_n(0) = n^2, \quad n = 1, 2, 3, \dots$

Near  $q = 0$ ,  $a_n(q)$  and  $b_n(q)$  can be expanded in power series in  $q$  (see §28.6(i)); elsewhere they are determined by analytic continuation (see §28.7). For nonnegative real values of  $q$ , see Figure 28.2.1.

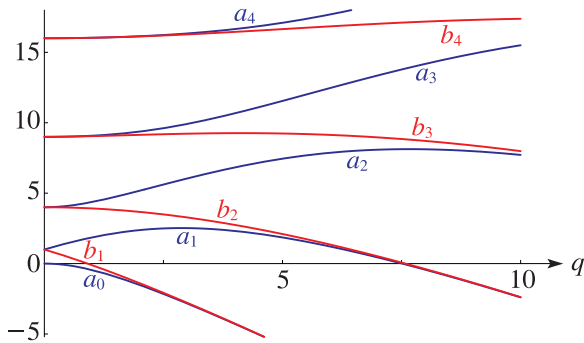


Figure 28.2.1: Eigenvalues  $a_n(q)$ ,  $b_n(q)$  of Mathieu's equation as functions of  $q$  for  $0 \leq q \leq 10$ ,  $n = 0, 1, 2, 3, 4$  ( $a$ 's),  $n = 1, 2, 3, 4$  ( $b$ 's).

**Distribution**

**28.2.25**  
 for  $q > 0$ :  $a_0 < b_1 < a_1 < b_2 < a_2 < b_3 < \dots,$   
 for  $q < 0$ :  $a_0 < a_1 < b_1 < b_2 < a_2 < a_3 < \dots.$

**Change of Sign of  $q$**

**28.2.26**  $a_{2n}(-q) = a_{2n}(q),$

**28.2.27**  $a_{2n+1}(-q) = b_{2n+1}(q),$

**28.2.28**  $b_{2n+2}(-q) = b_{2n+2}(q).$

**28.2(vi) Eigenfunctions**

Table 28.2.2 gives the notation for the eigenfunctions corresponding to the eigenvalues in Table 28.2.1. *Period*  $\pi$  means that the eigenfunction has the property  $w(z + \pi) = w(z)$ , whereas *antiperiod*  $\pi$  means that  $w(z + \pi) = -w(z)$ . *Even parity* means  $w(-z) = w(z)$ , and *odd parity* means  $w(-z) = -w(z)$ .

Table 28.2.2: Eigenfunctions of Mathieu's equation.

Eigenvalues	Eigenfunctions	Periodicity	Parity
$a_{2n}(q)$	$ce_{2n}(z, q)$	Period $\pi$	Even
$a_{2n+1}(q)$	$ce_{2n+1}(z, q)$	Antiperiod $\pi$	Even
$b_{2n+1}(q)$	$se_{2n+1}(z, q)$	Antiperiod $\pi$	Odd
$b_{2n+2}(q)$	$se_{2n+2}(z, q)$	Period $\pi$	Odd

When  $q = 0$ ,

**28.2.29**  $ce_0(z, 0) = 1/\sqrt{2}, \quad ce_n(z, 0) = \cos(nz),$   
 $se_n(z, 0) = \sin(nz), \quad n = 1, 2, 3, \dots$

For simple roots  $q$  of the corresponding equations (28.2.21) and (28.2.22), the functions are made unique by the normalizations

**28.2.30**  
 $\int_0^{2\pi} (ce_n(x, q))^2 dx = \pi, \quad \int_0^{2\pi} (se_n(x, q))^2 dx = \pi,$

the ambiguity of sign being resolved by (28.2.29) when  $q = 0$  and by continuity for the other values of  $q$ .

The functions are orthogonal, that is,

**28.2.31**  $\int_0^{2\pi} ce_m(x, q) ce_n(x, q) dx = 0, \quad n \neq m,$

**28.2.32**  $\int_0^{2\pi} se_m(x, q) se_n(x, q) dx = 0, \quad n \neq m,$

**28.2.33**  $\int_0^{2\pi} ce_m(x, q) se_n(x, q) dx = 0.$

For change of sign of  $q$  (compare (28.2.4))

**28.2.34**  $ce_{2n}(z, -q) = (-1)^n ce_{2n}(\frac{1}{2}\pi - z, q),$

**28.2.35**  $ce_{2n+1}(z, -q) = (-1)^n se_{2n+1}(\frac{1}{2}\pi - z, q),$

**28.2.36**  $se_{2n+1}(z, -q) = (-1)^n ce_{2n+1}(\frac{1}{2}\pi - z, q),$

**28.2.37**  $se_{2n+2}(z, -q) = (-1)^n se_{2n+2}(\frac{1}{2}\pi - z, q).$

For the connection with the basic solutions in §28.2(ii),

**28.2.38**  $\frac{ce_n(z, q)}{ce_n(0, q)} = w_I(z; a_n(q), q), \quad n = 0, 1, \dots,$

**28.2.39**  $\frac{se_n(z, q)}{se'_n(0, q)} = w_{II}(z; b_n(q), q), \quad n = 1, 2, \dots$

### 28.3 Graphics

#### 28.3(i) Line Graphs: Mathieu Functions with Fixed $q$ and Variable $x$

##### Even $\pi$ -Periodic Solutions

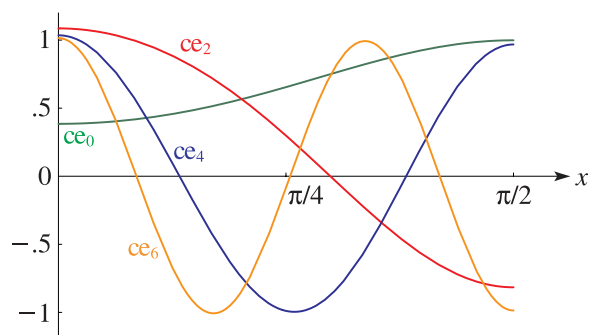


Figure 28.3.1:  $ce_{2n}(x, 1)$  for  $0 \leq x \leq \pi/2$ ,  $n = 0, 1, 2, 3$ .

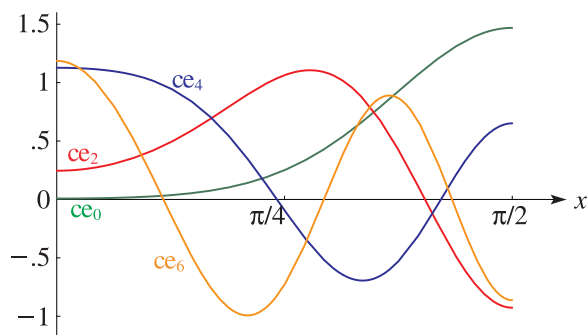


Figure 28.3.2:  $ce_{2n}(x, 10)$  for  $0 \leq x \leq \pi/2$ ,  $n = 0, 1, 2, 3$ .

##### Even $\pi$ -Antiperiodic Solutions

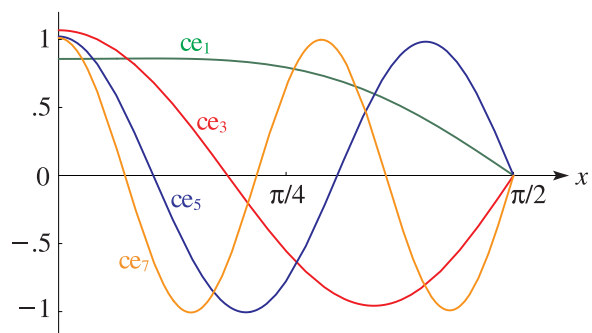


Figure 28.3.3:  $ce_{2n+1}(x, 1)$  for  $0 \leq x \leq \pi/2$ ,  $n = 0, 1, 2, 3$ .

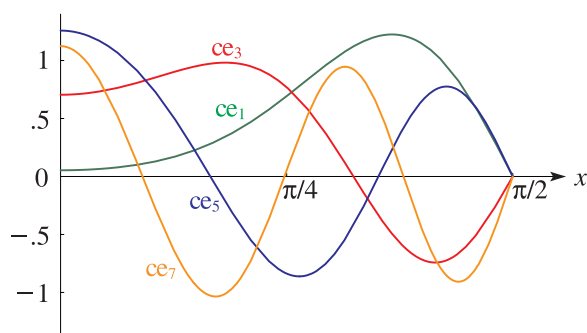


Figure 28.3.4:  $ce_{2n+1}(x, 10)$  for  $0 \leq x \leq \pi/2$ ,  $n = 0, 1, 2, 3$ .

##### Odd $\pi$ -Antiperiodic Solutions

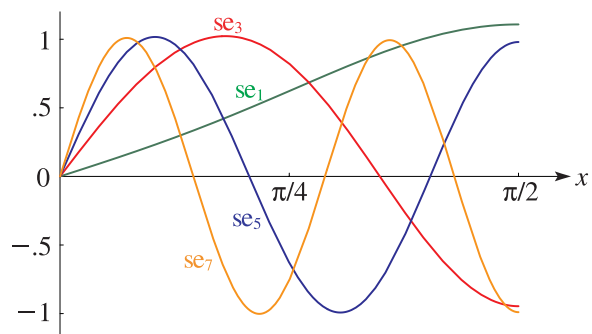


Figure 28.3.5:  $se_{2n+1}(x, 1)$  for  $0 \leq x \leq \pi/2$ ,  $n = 0, 1, 2, 3$ .

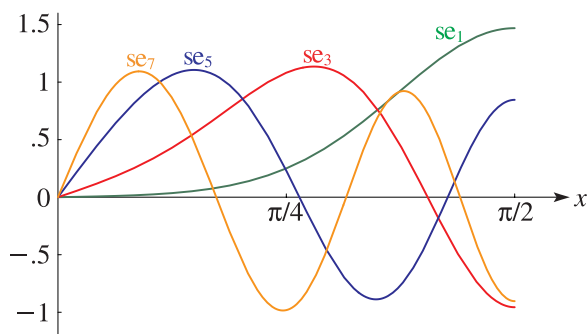


Figure 28.3.6:  $se_{2n+1}(x, 10)$  for  $0 \leq x \leq \pi/2$ ,  $n = 0, 1, 2, 3$ .



**Odd  $\pi$ -Periodic Solutions**

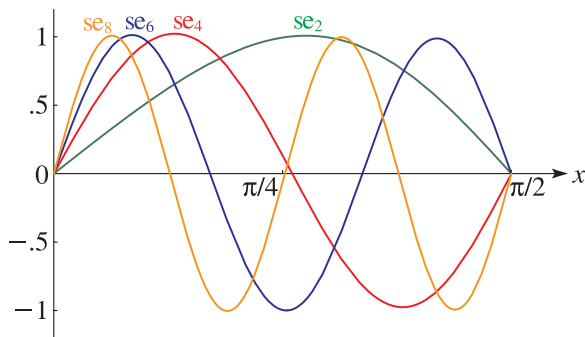


Figure 28.3.7:  $se_{2n}(x, 1)$  for  $0 \leq x \leq \pi/2$ ,  $n = 1, 2, 3, 4$ .

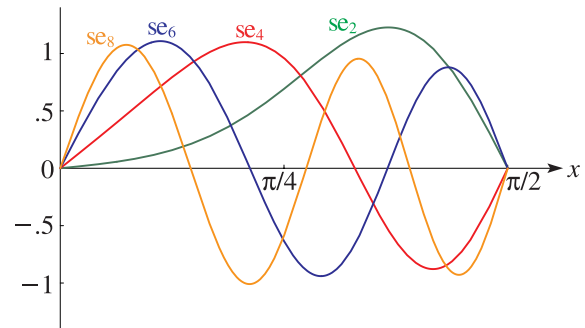


Figure 28.3.8:  $se_{2n}(x, 10)$  for  $0 \leq x \leq \pi/2$ ,  $n = 1, 2, 3, 4$ .

For further graphs see Jahnke *et al.* (1966, pp. 264–265 and 268–275).

**28.3(ii) Surfaces: Mathieu Functions with Variable  $x$  and  $q$**

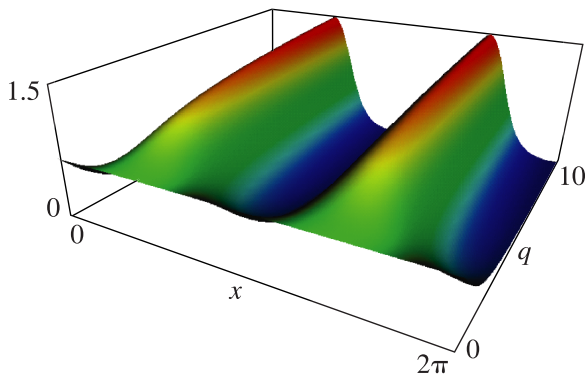


Figure 28.3.9:  $ce_0(x, q)$  for  $0 \leq x \leq 2\pi$ ,  $0 \leq q \leq 10$ .

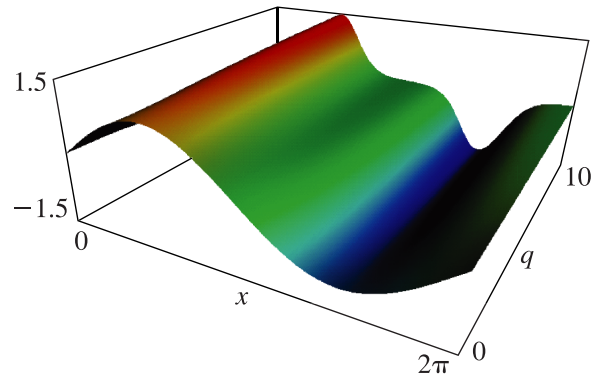


Figure 28.3.10:  $se_1(x, q)$  for  $0 \leq x \leq 2\pi$ ,  $0 \leq q \leq 10$ .

For further graphics see <http://dlmf.nist.gov/28.3.ii>.

**28.4 Fourier Series**

**28.4(i) Definitions**

The Fourier series of the periodic Mathieu functions converge absolutely and uniformly on all compact sets in the  $z$ -plane. For  $n = 0, 1, 2, 3, \dots$ ,

$$28.4.1 \quad ce_{2n}(z, q) = \sum_{m=0}^{\infty} A_{2m}^{2n}(q) \cos 2mz,$$

$$28.4.2 \quad ce_{2n+1}(z, q) = \sum_{m=0}^{\infty} A_{2m+1}^{2n+1}(q) \cos (2m+1)z,$$

$$28.4.3 \quad se_{2n+1}(z, q) = \sum_{m=0}^{\infty} B_{2m+1}^{2n+1}(q) \sin (2m+1)z,$$

$$28.4.4 \quad se_{2n+2}(z, q) = \sum_{m=0}^{\infty} B_{2m+2}^{2n+2}(q) \sin (2m+2)z.$$

**28.4(ii) Recurrence Relations**

$$28.4.5 \quad \begin{aligned} aA_0 - qA_2 &= 0, & (a-4)A_2 - q(2A_0 + A_4) &= 0, \\ (a-4m^2)A_{2m} - q(A_{2m-2} + A_{2m+2}) &= 0, \\ m &= 2, 3, 4, \dots, & a &= a_{2n}(q), & A_{2m} &= A_{2m}^{2n}(q). \end{aligned}$$

$$28.4.6 \quad \begin{aligned} (a-1-q)A_1 - qA_3 &= 0, \\ (a-(2m+1)^2)A_{2m+1} - q(A_{2m-1} + A_{2m+3}) &= 0, \\ m &= 1, 2, 3, \dots, & a &= a_{2n+1}(q), & A_{2m+1} &= A_{2m+1}^{2n+1}(q). \end{aligned}$$

$$28.4.7 \quad \begin{aligned} (a-1+q)B_1 - qB_3 &= 0, \\ (a-(2m+1)^2)B_{2m+1} - q(B_{2m-1} + B_{2m+3}) &= 0, \\ m &= 1, 2, 3, \dots, & a &= b_{2n+1}(q), & B_{2m+1} &= B_{2m+1}^{2n+1}(q). \end{aligned}$$

**28.4.8**

$$(a-4)B_2 - qB_4 = 0,$$

$$(a-4m^2)B_{2m} - q(B_{2m-2} + B_{2m+2}) = 0,$$

$$m = 2, 3, 4, \dots, a = b_{2n+2}(q), B_{2m+2} = B_{2m+2}^{2n+2}(q).$$

**28.4(iii) Normalization**

$$28.4.9 \quad 2(A_0^{2n}(q))^2 + \sum_{m=1}^{\infty} (A_{2m}^{2n}(q))^2 = 1,$$

$$28.4.10 \quad \sum_{m=0}^{\infty} (A_{2m+1}^{2n+1}(q))^2 = 1,$$

$$28.4.11 \quad \sum_{m=0}^{\infty} (B_{2m+1}^{2n+1}(q))^2 = 1,$$

$$28.4.12 \quad \sum_{m=0}^{\infty} (B_{2m+2}^{2n+2}(q))^2 = 1.$$

Ambiguities in sign are resolved by (28.4.13)–(28.4.16) when  $q = 0$ , and by continuity for the other values of  $q$ .

**28.4(iv) Case  $q = 0$** 

$$28.4.13 \quad A_0^0(0) = 1/\sqrt{2}, \quad A_{2n}^{2n}(0) = 1, \quad n > 0,$$

$$A_{2m}^{2m}(0) = 0, \quad n \neq m,$$

$$28.4.14 \quad A_{2n+1}^{2n+1}(0) = 1, \quad A_{2m+1}^{2n+1}(0) = 0, \quad n \neq m,$$

$$28.4.15 \quad B_{2n+1}^{2n+1}(0) = 1, \quad B_{2m+1}^{2n+1}(0) = 0, \quad n \neq m,$$

$$28.4.16 \quad B_{2n+2}^{2n+2}(0) = 1, \quad B_{2m+2}^{2n+2}(0) = 0, \quad n \neq m.$$

**28.4(v) Change of Sign of  $q$** 

$$28.4.17 \quad A_{2m}^{2n}(-q) = (-1)^{n-m} A_{2m}^{2n}(q),$$

$$28.4.18 \quad B_{2m+2}^{2n+2}(-q) = (-1)^{n-m} B_{2m+2}^{2n+2}(q),$$

$$28.4.19 \quad A_{2m+1}^{2n+1}(-q) = (-1)^{n-m} A_{2m+1}^{2n+1}(q),$$

$$28.4.20 \quad B_{2m+1}^{2n+1}(-q) = (-1)^{n-m} B_{2m+1}^{2n+1}(q).$$

**28.4(vi) Behavior for Small  $q$** 

For fixed  $s = 1, 2, 3, \dots$  and fixed  $m = 1, 2, 3, \dots$ ,

$$28.4.21 \quad A_{2s}^0(q) = \left( \frac{(-1)^{s2}}{(s!)^2} \left( \frac{q}{4} \right)^s + O(q^{s+2}) \right) A_0^0(q),$$

**28.4.22**

$$\left. \begin{matrix} A_{m+2s}^m(q) \\ B_{m+2s}^m(q) \end{matrix} \right\} = \left( \frac{(-1)^s m!}{s!(m+s)!} \left( \frac{q}{4} \right)^s + O(q^{s+1}) \right) \left\{ \begin{matrix} A_m^m(q) \\ B_m^m(q) \end{matrix} \right\},$$

**28.4.23**

$$\left. \begin{matrix} A_{m-2s}^m(q) \\ B_{m-2s}^m(q) \end{matrix} \right\} = \left( \frac{(m-s-1)!}{s!(m-1)!} \left( \frac{q}{4} \right)^s + O(q^{s+1}) \right) \left\{ \begin{matrix} A_m^m(q) \\ B_m^m(q) \end{matrix} \right\}.$$

For further terms and expansions see Meixner and Schäfer (1954, p. 122) and McLachlan (1947, §3.33).

**28.4(vii) Asymptotic Forms for Large  $m$** 

As  $m \rightarrow \infty$ , with fixed  $q (\neq 0)$  and fixed  $n$ ,

**28.4.24**

$$\frac{A_{2m}^{2n}(q)}{A_0^{2n}(q)} = \frac{(-1)^m}{(m!)^2} \left( \frac{q}{4} \right)^m \frac{\pi (1 + O(m^{-1}))}{w_{II}(\frac{1}{2}\pi; a_{2n}(q), q)},$$

**28.4.25**

$$\frac{A_{2m+1}^{2n+1}(q)}{A_1^{2n+1}(q)} = \frac{(-1)^{m+1}}{\left( \left( \frac{1}{2} \right)_{m+1} \right)^2} \left( \frac{q}{4} \right)^{m+1} \frac{2(1 + O(m^{-1}))}{w'_{II}(\frac{1}{2}\pi; a_{2n+1}(q), q)},$$

**28.4.26**

$$\frac{B_{2m+1}^{2n+1}(q)}{B_1^{2n+1}(q)} = \frac{(-1)^m}{\left( \left( \frac{1}{2} \right)_{m+1} \right)^2} \left( \frac{q}{4} \right)^{m+1} \frac{2(1 + O(m^{-1}))}{w_I(\frac{1}{2}\pi; b_{2n+1}(q), q)},$$

**28.4.27**

$$\frac{B_{2m}^{2n+2}(q)}{B_2^{2n+2}(q)} = \frac{(-1)^m}{(m!)^2} \left( \frac{q}{4} \right)^m \frac{q\pi (1 + O(m^{-1}))}{w'_I(\frac{1}{2}\pi; b_{2n+2}(q), q)}.$$

For the basic solutions  $w_I$  and  $w_{II}$  see §28.2(ii).

**28.5 Second Solutions  $fe_n, ge_n$** **28.5(i) Definitions****Theorem of Ince (1922)**

If a nontrivial solution of Mathieu's equation with  $q \neq 0$  has period  $\pi$  or  $2\pi$ , then any linearly independent solution cannot have either period.

Second solutions of (28.2.1) are given by

$$28.5.1 \quad fe_n(z, q) = C_n(q) (z ce_n(z, q) + f_n(z, q)),$$

when  $a = a_n(q)$ ,  $n = 0, 1, 2, \dots$ , and by

$$28.5.2 \quad ge_n(z, q) = S_n(q) (z se_n(z, q) + g_n(z, q)),$$

when  $a = b_n(q)$ ,  $n = 1, 2, 3, \dots$ . For  $m = 0, 1, 2, \dots$ , we have

$$28.5.3 \quad \left. \begin{matrix} f_{2m}(z, q) & \pi\text{-periodic, odd,} \\ f_{2m+1}(z, q) & \pi\text{-antiperiodic, odd,} \end{matrix} \right\}$$

and

$$28.5.4 \quad \left. \begin{matrix} g_{2m+1}(z, q) & \pi\text{-antiperiodic, even,} \\ g_{2m+2}(z, q) & \pi\text{-periodic, even;} \end{matrix} \right\}$$

compare §28.2(vi). The functions  $f_n(z, q)$ ,  $g_n(z, q)$  are unique.

The factors  $C_n(q)$  and  $S_n(q)$  in (28.5.1) and (28.5.2) are normalized so that

$$28.5.5 \quad \begin{aligned} & (C_n(q))^2 \int_0^{2\pi} (f_n(x, q))^2 dx \\ & = (S_n(q))^2 \int_0^{2\pi} (g_n(x, q))^2 dx = \pi. \end{aligned}$$

As  $q \rightarrow 0$  with  $n \neq 0$ ,  $C_n(q) \rightarrow 0$ ,  $S_n(q) \rightarrow 0$ ,  $C_n(q)f_n(z, q) \rightarrow \sin nz$ , and  $S_n(q)g_n(z, q) \rightarrow \cos nz$ . This determines the signs of  $C_n(q)$  and  $S_n(q)$ . (Other normalizations for  $C_n(q)$  and  $S_n(q)$  can be found in

the literature, but most formulas—including connection formulas—are unaffected since  $fe_n(z, q)/C_n(q)$  and  $ge_n(z, q)/S_n(q)$  are invariant.)

$$\begin{aligned}
 & C_{2m}(-q) = C_{2m}(q), \\
 \text{28.5.6} \quad & C_{2m+1}(-q) = S_{2m+1}(q), \\
 & S_{2m+2}(-q) = S_{2m+2}(q).
 \end{aligned}$$

For  $q = 0$ ,

$$\begin{aligned}
 \text{28.5.7} \quad & fe_0(z, 0) = z, \quad fe_n(z, 0) = \sin nz, \\
 & ge_n(z, 0) = \cos nz, \quad n = 1, 2, 3, \dots;
 \end{aligned}$$

compare (28.2.29).

As a consequence of the factor  $z$  on the right-hand sides of (28.5.1), (28.5.2), all solutions of Mathieu's

equation that are linearly independent of the periodic solutions are unbounded as  $z \rightarrow \pm\infty$  on  $\mathbb{R}$ .

**Wronskians**

$$\text{28.5.8} \quad \mathscr{W} \{ce_n, fe_n\} = ce_n(0, q) fe'_n(0, q),$$

$$\text{28.5.9} \quad \mathscr{W} \{se_n, ge_n\} = -se'_n(0, q) ge_n(0, q).$$

See (28.22.12) for  $fe'_n(0, q)$  and  $ge_n(0, q)$ .

For further information on  $C_n(q)$ ,  $S_n(q)$ , and expansions of  $f_n(z, q)$ ,  $g_n(z, q)$  in Fourier series or in series of  $ce_n$ ,  $se_n$  functions, see McLachlan (1947, Chapter VII) or Meixner and Schäfer (1954, §2.72).

**28.5(ii) Graphics: Line Graphs of Second Solutions of Mathieu's Equation**

**Odd Second Solutions**

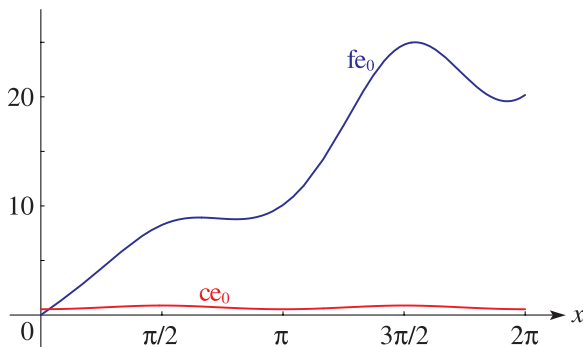


Figure 28.5.1:  $fe_0(x, 0.5)$  for  $0 \leq x \leq 2\pi$  and (for comparison)  $ce_0(x, 0.5)$ .

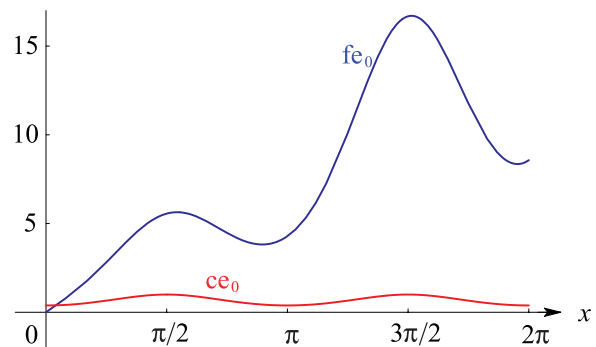


Figure 28.5.2:  $fe_0(x, 1)$  for  $0 \leq x \leq 2\pi$  and (for comparison)  $ce_0(x, 1)$ .

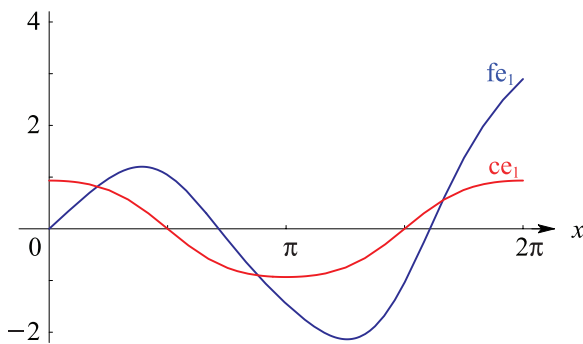


Figure 28.5.3:  $fe_1(x, 0.5)$  for  $0 \leq x \leq 2\pi$  and (for comparison)  $ce_1(x, 0.5)$ .

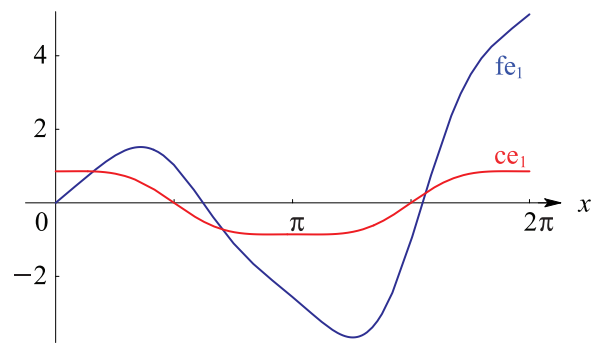


Figure 28.5.4:  $fe_1(x, 1)$  for  $0 \leq x \leq 2\pi$  and (for comparison)  $ce_1(x, 1)$ .

**Even Second Solutions**

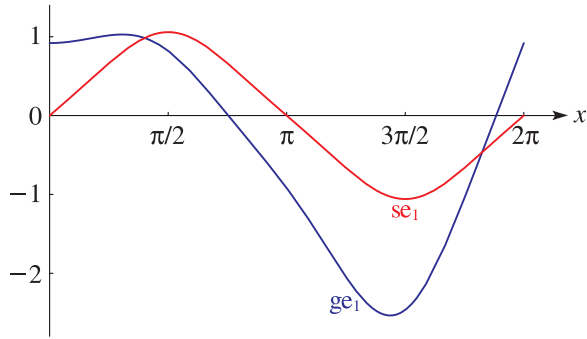


Figure 28.5.5:  $ge_1(x, 0.5)$  for  $0 \leq x \leq 2\pi$  and (for comparison)  $se_1(x, 0.5)$ .

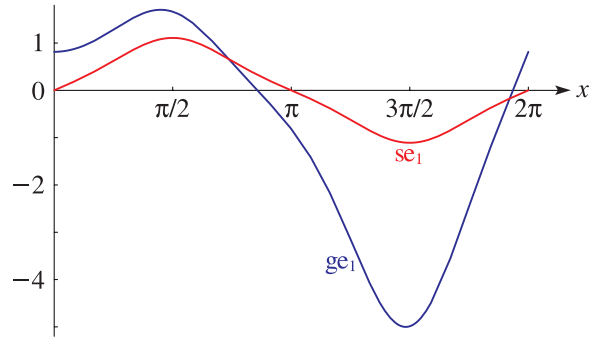


Figure 28.5.6:  $ge_1(x, 1)$  for  $0 \leq x \leq 2\pi$  and (for comparison)  $se_1(x, 1)$ .

**28.6 Expansions for Small  $q$**

**28.6(i) Eigenvalues**

Leading terms of the power series for  $a_m(q)$  and  $b_m(q)$  for  $m \leq 6$  are:

- 28.6.1  $a_0(q) = -\frac{1}{2}q^2 + \frac{7}{128}q^4 - \frac{29}{2304}q^6 + \frac{68687}{188\,74368}q^8 + \dots,$
- 28.6.2  $a_1(q) = 1 + q - \frac{1}{8}q^2 - \frac{1}{64}q^3 - \frac{1}{1536}q^4 + \frac{11}{36864}q^5 + \frac{49}{5\,89824}q^6 + \frac{55}{94\,37184}q^7 - \frac{83}{353\,89440}q^8 + \dots,$
- 28.6.3  $b_1(q) = 1 - q - \frac{1}{8}q^2 + \frac{1}{64}q^3 - \frac{1}{1536}q^4 - \frac{11}{36864}q^5 + \frac{49}{5\,89824}q^6 - \frac{55}{94\,37184}q^7 - \frac{83}{353\,89440}q^8 + \dots,$
- 28.6.4  $a_2(q) = 4 + \frac{5}{12}q^2 - \frac{763}{13824}q^4 + \frac{10\,02401}{796\,26240}q^6 - \frac{16690\,68401}{45\,86471\,42400}q^8 + \dots,$
- 28.6.5  $b_2(q) = 4 - \frac{1}{12}q^2 + \frac{5}{13824}q^4 - \frac{289}{796\,26240}q^6 + \frac{21391}{45\,86471\,42400}q^8 + \dots,$
- 28.6.6  $a_3(q) = 9 + \frac{1}{16}q^2 + \frac{1}{64}q^3 + \frac{13}{20480}q^4 - \frac{5}{16384}q^5 - \frac{1961}{235\,92960}q^6 - \frac{609}{1048\,57600}q^7 + \dots,$
- 28.6.7  $b_3(q) = 9 + \frac{1}{16}q^2 - \frac{1}{64}q^3 + \frac{13}{20480}q^4 + \frac{5}{16384}q^5 - \frac{1961}{235\,92960}q^6 + \frac{609}{1048\,57600}q^7 + \dots,$
- 28.6.8  $a_4(q) = 16 + \frac{1}{30}q^2 + \frac{433}{8\,64000}q^4 - \frac{5701}{27216\,00000}q^6 + \dots,$
- 28.6.9  $b_4(q) = 16 + \frac{1}{30}q^2 - \frac{317}{8\,64000}q^4 + \frac{10049}{27216\,00000}q^6 + \dots,$
- 28.6.10  $a_5(q) = 25 + \frac{1}{48}q^2 + \frac{11}{7\,74144}q^4 + \frac{1}{1\,47456}q^5 + \frac{37}{8918\,13888}q^6 + \dots,$
- 28.6.11  $b_5(q) = 25 + \frac{1}{48}q^2 + \frac{11}{7\,74144}q^4 - \frac{1}{1\,47456}q^5 + \frac{37}{8918\,13888}q^6 + \dots,$
- 28.6.12  $a_6(q) = 36 + \frac{1}{70}q^2 + \frac{187}{439\,04000}q^4 + \frac{67\,43617}{9293\,59872\,00000}q^6 + \dots,$
- 28.6.13  $b_6(q) = 36 + \frac{1}{70}q^2 + \frac{187}{439\,04000}q^4 - \frac{58\,61633}{9293\,59872\,00000}q^6 + \dots.$

Leading terms of the of the power series for  $m = 7, 8, 9, \dots$  are:

28.6.14  $\left. \begin{matrix} a_m(q) \\ b_m(q) \end{matrix} \right\} = m^2 + \frac{1}{2(m^2 - 1)}q^2 + \frac{5m^2 + 7}{32(m^2 - 1)^3(m^2 - 4)}q^4 + \frac{9m^4 + 58m^2 + 29}{64(m^2 - 1)^5(m^2 - 4)(m^2 - 9)}q^6 + \dots.$

The coefficients of the power series of  $a_{2n}(q)$ ,  $b_{2n}(q)$  and also  $a_{2n+1}(q)$ ,  $b_{2n+1}(q)$  are the same until the terms in  $q^{2n-2}$  and  $q^{2n}$ , respectively. Then

28.6.15 
$$a_m(q) - b_m(q) = \frac{2q^m}{(2^{m-1}(m-1)!)^2} (1 + O(q^2)).$$

Higher coefficients in the foregoing series can be found by equating coefficients in the following continued-fraction equations:

28.6.16 
$$a - (2n)^2 - \frac{q^2}{a - (2n-2)^2 - \frac{q^2}{a - (2n-4)^2 - \dots - \frac{q^2}{a - 2^2 - \frac{2q^2}{a}}} = -\frac{q^2}{(2n+2)^2 - a - \frac{q^2}{(2n+4)^2 - a - \dots}}, \quad a = a_{2n}(q),$$

**28.6.17**

$$a - (2n + 1)^2 - \frac{q^2}{a - (2n - 1)^2} \cdots \frac{q^2}{a - 3^2} - \frac{q^2}{a - 1^2 - q} = -\frac{q^2}{(2n + 3)^2 - a} - \frac{q^2}{(2n + 5)^2 - a} \cdots, \quad a = a_{2n+1}(q),$$

**28.6.18**

$$a - (2n + 1)^2 - \frac{q^2}{a - (2n - 1)^2} \cdots \frac{q^2}{a - 3^2} - \frac{q^2}{a - 1^2 + q} = -\frac{q^2}{(2n + 3)^2 - a} - \frac{q^2}{(2n + 5)^2 - a} \cdots, \quad a = b_{2n+1}(q),$$

**28.6.19**

$$a - (2n + 2)^2 - \frac{q^2}{a - (2n)^2} - \frac{q^2}{a - (2n - 2)^2} \cdots \frac{q^2}{a - 2^2} = -\frac{q^2}{(2n + 4)^2 - a} - \frac{q^2}{(2n + 6)^2 - a} \cdots, \quad a = b_{2n+2}(q).$$

Numerical values of the radii of convergence  $\rho_n^{(j)}$  of the power series (28.6.1)–(28.6.14) for  $n = 0, 1, \dots, 9$  are given in Table 28.6.1. Here  $j = 1$  for  $a_{2n}(q)$ ,  $j = 2$  for  $b_{2n+2}(q)$ , and  $j = 3$  for  $a_{2n+1}(q)$  and  $b_{2n+1}(q)$ . (Table 28.6.1 is reproduced from Meixner *et al.* (1980, §2.4).)

Table 28.6.1: Radii of convergence for power-series expansions of eigenvalues of Mathieu's equation.

$n$	$\rho_n^{(1)}$	$\rho_n^{(2)}$	$\rho_n^{(3)}$
0 or 1	1.46876 86138	6.92895 47588	3.76995 74940
2	7.26814 68935	16.80308 98254	11.27098 52655
3	16.47116 58923	30.09677 28376	22.85524 71216
4	30.42738 20960	48.13638 18593	38.52292 50099
5	47.80596 57026	69.59879 32769	58.27413 84472
6	69.92930 51764	95.80595 67052	82.10894 36067
7	95.47527 27072	125.43541 1314	110.02736 9210
8	125.76627 89677	159.81025 4642	142.02943 1279
9	159.47921 26694	197.60667 8692	178.11513 940

It is conjectured that for large  $n$ , the radii increase in proportion to the square of the eigenvalue number  $n$ ; see Meixner *et al.* (1980, §2.4). It is known that

**28.6.20** 
$$\liminf_{n \rightarrow \infty} \frac{\rho_n^{(j)}}{n^2} \geq k k' (K(k))^2 = 2.04183 4 \dots,$$

where  $k$  is the unique root of the equation  $2E(k) = K(k)$  in the interval  $(0, 1)$ , and  $k' = \sqrt{1 - k^2}$ . For  $E(k)$  and  $K(k)$  see §19.2(ii).

**28.6(ii) Functions  $ce_n$  and  $se_n$**

Leading terms of the power series for the normalized functions are:

**28.6.21** 
$$2^{1/2} ce_0(z, q) = 1 - \frac{1}{2}q \cos 2z + \frac{1}{32}q^2 (\cos 4z - 2) - \frac{1}{128}q^3 \left(\frac{1}{9} \cos 6z - 11 \cos 2z\right) + \dots,$$

**28.6.22** 
$$ce_1(z, q) = \cos z - \frac{1}{8}q \cos 3z + \frac{1}{128}q^2 \left(\frac{2}{3} \cos 5z - 2 \cos 3z - \cos z\right) - \frac{1}{1024}q^3 \left(\frac{1}{9} \cos 7z - \frac{8}{9} \cos 5z - \frac{1}{3} \cos 3z + 2 \cos z\right) + \dots,$$

**28.6.23** 
$$se_1(z, q) = \sin z - \frac{1}{8}q \sin 3z + \frac{1}{128}q^2 \left(\frac{2}{3} \sin 5z + 2 \sin 3z - \sin z\right) - \frac{1}{1024}q^3 \left(\frac{1}{9} \sin 7z + \frac{8}{9} \sin 5z - \frac{1}{3} \sin 3z - 2 \sin z\right) + \dots,$$

**28.6.24** 
$$ce_2(z, q) = \cos 2z - \frac{1}{4}q \left(\frac{1}{3} \cos 4z - 1\right) + \frac{1}{128}q^2 \left(\frac{1}{3} \cos 6z - \frac{76}{9} \cos 2z\right) + \dots,$$

**28.6.25** 
$$se_2(z, q) = \sin 2z - \frac{1}{12}q \sin 4z + \frac{1}{128}q^2 \left(\frac{1}{3} \sin 6z - \frac{4}{9} \sin 2z\right) + \dots.$$

For  $m = 3, 4, 5, \dots$ ,

**28.6.26** 
$$ce_m(z, q) = \cos mz - \frac{q}{4} \left( \frac{1}{m+1} \cos(m+2)z - \frac{1}{m-1} \cos(m-2)z \right) + \frac{q^2}{32} \left( \frac{1}{(m+1)(m+2)} \cos(m+4)z + \frac{1}{(m-1)(m-2)} \cos(m-4)z - \frac{2(m^2+1)}{(m^2-1)^2} \cos mz \right) + \dots.$$

For the corresponding expansions of  $se_m(z, q)$  for  $m = 3, 4, 5, \dots$  change  $\cos$  to  $\sin$  everywhere in (28.6.26).

The radii of convergence of the series (28.6.21)–(28.6.26) are the same as the radii of the corresponding series for  $a_n(q)$  and  $b_n(q)$ ; compare Table 28.6.1 and (28.6.20).

### 28.7 Analytic Continuation of Eigenvalues

As functions of  $q$ ,  $a_n(q)$  and  $b_n(q)$  can be continued analytically in the complex  $q$ -plane. The only singularities are algebraic branch points, with  $a_n(q)$  and  $b_n(q)$  finite at these points. The number of branch points is infinite, but countable, and there are no finite limit points. In consequence, the functions can be defined uniquely by introducing suitable cuts in the  $q$ -plane. See Meixner and Schäfke (1954, §2.22). The branch points are called the *exceptional values*, and the other points *normal values*. The normal values are simple roots of the corresponding equations (28.2.21) and (28.2.22). All real values of  $q$  are normal values. To 4D the first branch points between  $a_0(q)$  and  $a_2(q)$  are at  $q_0 = \pm i1.4688$  with  $a_0(q_0) = a_2(q_0) = 2.0886$ , and between  $b_2(q)$  and  $b_4(q)$  they are at  $q_1 = \pm i6.9289$  with  $b_2(q_1) = b_4(q_1) = 11.1904$ . For real  $q$  with  $|q| < |q_0|$ ,  $a_0(iq)$  and  $a_2(iq)$  are real-valued, whereas for real  $q$  with  $|q| > |q_0|$ ,  $a_0(iq)$  and  $a_2(iq)$  are complex conjugates. See also Mulholland and Goldstein (1929), Bouwkamp (1948), Meixner *et al.* (1980), Hunter and Guerrieri (1981), Hunter (1981), and Shivakumar and Xue (1999).

For a visualization of the first branch point of  $a_0(i\hat{q})$  and  $a_2(i\hat{q})$  see Figure 28.7.1.

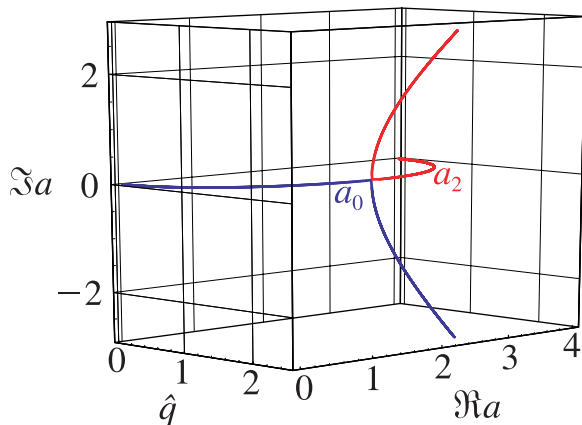


Figure 28.7.1: Branch point of the eigenvalues  $a_0(i\hat{q})$  and  $a_2(i\hat{q})$ :  $0 \leq \hat{q} \leq 2.5$ .

All the  $a_{2n}(q)$ ,  $n = 0, 1, 2, \dots$ , can be regarded as belonging to a complete analytic function (in the large). Therefore  $w_1'(\frac{1}{2}\pi; a, q)$  is irreducible, in the sense that it cannot be decomposed into a product of entire functions

that contain its zeros; see Meixner *et al.* (1980, p. 88). Analogous statements hold for  $a_{2n+1}(q)$ ,  $b_{2n+1}(q)$ , and  $b_{2n+2}(q)$ , also for  $n = 0, 1, 2, \dots$ . Closely connected with the preceding statements, we have

$$28.7.1 \quad \sum_{n=0}^{\infty} (a_{2n}(q) - (2n)^2) = 0,$$

$$28.7.2 \quad \sum_{n=0}^{\infty} (a_{2n+1}(q) - (2n+1)^2) = q,$$

$$28.7.3 \quad \sum_{n=0}^{\infty} (b_{2n+1}(q) - (2n+1)^2) = -q,$$

$$28.7.4 \quad \sum_{n=0}^{\infty} (b_{2n+2}(q) - (2n+2)^2) = 0.$$

### 28.8 Asymptotic Expansions for Large $q$

#### 28.8(i) Eigenvalues

Denote  $h = \sqrt{q}$  and  $s = 2m + 1$ . Then as  $h \rightarrow +\infty$  with  $m = 0, 1, 2, \dots$ ,

$$28.8.1 \quad \left. \begin{aligned} a_m(h^2) \\ b_{m+1}(h^2) \end{aligned} \right\} \sim -2h^2 + 2sh - \frac{1}{8}(s^2 + 1) - \frac{1}{27h}(s^3 + 3s) \\ - \frac{1}{2^{12}h^2}(5s^4 + 34s^2 + 9) \\ - \frac{1}{2^{17}h^3}(33s^5 + 410s^3 + 405s) \\ - \frac{1}{2^{20}h^4}(63s^6 + 1260s^4 + 2943s^2 + 486) \\ - \frac{1}{2^{25}h^5}(527s^7 + 15617s^5 + 69001s^3 \\ + 41607s) + \dots$$

For error estimates see Kurz (1979), and for graphical interpretation see Figure 28.2.1. Also,

$$28.8.2 \quad \begin{aligned} & b_{m+1}(h^2) - a_m(h^2) \\ &= \frac{2^{4m+5}}{m!} \left(\frac{2}{\pi}\right)^{1/2} h^{m+(3/2)} e^{-4h} \\ & \times \left(1 - \frac{6m^2 + 14m + 7}{32h} + O\left(\frac{1}{h^2}\right)\right). \end{aligned}$$

#### 28.8(ii) Sips' Expansions

Let  $x = \frac{1}{2}\pi + \lambda h^{-1/4}$ , where  $\lambda$  is a real constant such that  $|\lambda| < 2^{1/4}$ . Also let  $\xi = 2\sqrt{h} \cos x$  and  $D_m(\xi) = e^{-\xi^2/4} He_m(\xi)$  (§18.3). Then as  $h \rightarrow +\infty$

$$28.8.3 \quad \begin{aligned} ce_m(x, h^2) &= \widehat{C}_m(U_m(\xi) + V_m(\xi)), \\ \frac{se_{m+1}(x, h^2)}{\sin x} &= \widehat{S}_m(U_m(\xi) - V_m(\xi)), \end{aligned}$$

where

$$\begin{aligned}
 28.8.4 \quad U_m(\xi) &\sim D_m(\xi) - \frac{1}{2^6 h} \left( D_{m+4}(\xi) - 4! \binom{m}{4} D_{m-4}(\xi) \right) \\
 &\quad + \frac{1}{2^{13} h^2} \left( D_{m+8}(\xi) - 2^5(m+2) D_{m+4}(\xi) + 4! 2^5(m-1) \binom{m}{4} D_{m-4}(\xi) + 8! \binom{m}{8} D_{m-8}(\xi) \right) + \dots,
 \end{aligned}$$

$$\begin{aligned}
 28.8.5 \quad V_m(\xi) &\sim \frac{1}{2^4 h} \left( -D_{m+2}(\xi) - m(m-1) D_{m-2}(\xi) \right) + \frac{1}{2^{10} h^2} \left( D_{m+6}(\xi) + (m^2 - 25m - 36) D_{m+2}(\xi) \right. \\
 &\quad \left. - m(m-1)(m^2 + 27m - 10) D_{m-2}(\xi) + 6! \binom{m}{6} D_{m-6}(\xi) \right) + \dots,
 \end{aligned}$$

and

$$28.8.6 \quad \widehat{C}_m \sim \left( \frac{\pi h}{2(m!)^2} \right)^{1/4} \left( 1 + \frac{2m+1}{8h} + \frac{m^4 + 2m^3 + 263m^2 + 262m + 108}{2048h^2} + \dots \right)^{-1/2},$$

$$28.8.7 \quad \widehat{S}_m \sim \left( \frac{\pi h}{2(m!)^2} \right)^{1/4} \left( 1 - \frac{2m+1}{8h} + \frac{m^4 + 2m^3 - 121m^2 - 122m - 84}{2048h^2} + \dots \right)^{-1/2}.$$

These results are derived formally in Sips (1949, 1959, 1965). See also Meixner and Schäfke (1954, §2.84).

### 28.8(iii) Goldstein's Expansions

Let  $x = \frac{1}{2}\pi - \mu h^{-1/4}$ , where  $\mu$  is a constant such that  $\mu \geq 1$ , and  $s = 2m + 1$ . Then as  $h \rightarrow +\infty$

$$\begin{aligned}
 28.8.8 \quad \frac{ce_m(x, h^2)}{ce_m(0, h^2)} &= \frac{2^{m-(1/2)}}{\sigma_m} (W_m^+(x)(P_m(x) - Q_m(x)) + W_m^-(x)(P_m(x) + Q_m(x))), \\
 \frac{se_{m+1}(x, h^2)}{se'_{m+1}(0, h^2)} &= \frac{2^{m-(1/2)}}{\tau_{m+1}} (W_m^+(x)(P_m(x) - Q_m(x)) - W_m^-(x)(P_m(x) + Q_m(x))),
 \end{aligned}$$

where

$$28.8.9 \quad W_m^\pm(x) = \frac{e^{\pm 2h \sin x}}{(\cos x)^{m+1}} \begin{cases} (\cos(\frac{1}{2}x + \frac{1}{4}\pi))^{2m+1}, \\ (\sin(\frac{1}{2}x + \frac{1}{4}\pi))^{2m+1}, \end{cases}$$

and

$$28.8.10 \quad \sigma_m \sim 1 + \frac{s}{2^3 h} + \frac{4s^2 + 3}{2^7 h^2} + \frac{19s^3 + 59s}{2^{11} h^3} + \dots, \quad \tau_{m+1} \sim 2h - \frac{1}{4}s - \frac{2s^2 + 3}{2^6 h} - \frac{7s^3 + 47s}{2^{10} h^2} - \dots,$$

$$28.8.11 \quad P_m(x) \sim 1 + \frac{s}{2^3 h \cos^2 x} + \frac{1}{h^2} \left( \frac{s^4 + 86s^2 + 105}{2^{11} \cos^4 x} - \frac{s^4 + 22s^2 + 57}{2^{11} \cos^2 x} \right) + \dots,$$

$$28.8.12 \quad Q_m(x) \sim \frac{\sin x}{\cos^2 x} \left( \frac{1}{2^5 h} (s^2 + 3) + \frac{1}{2^9 h^2} \left( s^3 + 3s + \frac{4s^3 + 44s}{\cos^2 x} \right) \right) + \dots.$$

### 28.8(iv) Uniform Approximations

#### Barrett's Expansions

Barrett (1981) supplies asymptotic approximations for numerically satisfactory pairs of solutions of both Mathieu's equation (28.2.1) and the modified Mathieu equation (28.20.1). The approximations apply when the parameters  $a$  and  $q$  are real and large, and are uniform with respect to various regions in the  $z$ -plane. The approximants are elementary functions, Airy functions, Bessel functions, and parabolic cylinder functions; compare §2.8. It is stated that corresponding uniform approximations can be obtained for other solutions, including the eigensolutions, of the differential equations

by application of the results, but these approximations are not included.

#### Dunster's Approximations

Dunster (1994a) supplies uniform asymptotic approximations for numerically satisfactory pairs of solutions of Mathieu's equation (28.2.1). These approximations apply when  $q$  and  $a$  are real and  $q \rightarrow \infty$ . They are uniform with respect to  $a$  when  $-2q \leq a \leq (2 - \delta)q$ , where  $\delta$  is an arbitrary constant such that  $0 < \delta < 4$ , and also with respect to  $z$  in the semi-infinite strip given by  $0 \leq \Re z \leq \pi$  and  $\Im z \geq 0$ .

The approximations are expressed in terms of Whittaker functions  $W_{\kappa, \mu}(z)$  and  $M_{\kappa, \mu}(z)$  with  $\mu = \frac{1}{4}$ ; com-

pare §2.8(vi). They are derived by rigorous analysis and accompanied by strict and realistic error bounds. With additional restrictions on  $z$ , uniform asymptotic approximations for solutions of (28.2.1) and (28.20.1) are also obtained in terms of elementary functions by re-expansions of the Whittaker functions; compare §2.8(ii).

Subsequently the asymptotic solutions involving either elementary or Whittaker functions are identified in terms of the Floquet solutions  $me_\nu(z, q)$  (§28.12(ii)) and modified Mathieu functions  $M_\nu^{(j)}(z, h)$  (§28.20(iii)).

For related results see Langer (1934) and Sharples (1967, 1971).

### 28.9 Zeros

For real  $q$  each of the functions  $ce_{2n}(z, q)$ ,  $se_{2n+1}(z, q)$ ,  $ce_{2n+1}(z, q)$ , and  $se_{2n+2}(z, q)$  has exactly  $n$  zeros in  $0 < z < \frac{1}{2}\pi$ . They are continuous in  $q$ . For  $q \rightarrow \infty$  the zeros of  $ce_{2n}(z, q)$  and  $se_{2n+1}(z, q)$  approach asymptotically the zeros of  $He_{2n}(q^{1/4}(\pi - 2z))$ , and the zeros of  $ce_{2n+1}(z, q)$  and  $se_{2n+2}(z, q)$  approach asymptotically the zeros of  $He_{2n+1}(q^{1/4}(\pi - 2z))$ . Here  $He_n(z)$  denotes the Hermite polynomial of degree  $n$  (§18.3). Furthermore, for  $q > 0$   $ce_m(z, q)$  and  $se_m(z, q)$  also have purely imaginary zeros that correspond uniquely to the purely imaginary  $z$ -zeros of  $J_m(2\sqrt{q} \cos z)$  (§10.21(i)), and they are asymptotically equal as  $q \rightarrow 0$  and  $|\Im z| \rightarrow \infty$ . There are no zeros within the strip  $|\Re z| < \frac{1}{2}\pi$  other than those on the real and imaginary axes.

For further details see McLachlan (1947, pp. 234–239) and Meixner and Schäfer (1954, §§2.331, 2.8, 2.81, and 2.85).

### 28.10 Integral Equations

#### 28.10(i) Equations with Elementary Kernels

With the notation of §28.4 for Fourier coefficients,

$$\begin{aligned} 28.10.1 \quad & \frac{2}{\pi} \int_0^{\pi/2} \cos(2h \cos z \cos t) ce_{2n}(t, h^2) dt \\ & = \frac{A_0^{2n}(h^2)}{ce_{2n}(\frac{1}{2}\pi, h^2)} ce_{2n}(z, h^2), \end{aligned}$$

$$\begin{aligned} 28.10.2 \quad & \frac{2}{\pi} \int_0^{\pi/2} \cosh(2h \sin z \sin t) ce_{2n}(t, h^2) dt \\ & = \frac{A_0^{2n}(h^2)}{ce_{2n}(0, h^2)} ce_{2n}(z, h^2), \end{aligned}$$

$$\begin{aligned} 28.10.3 \quad & \frac{2}{\pi} \int_0^{\pi/2} \sin(2h \cos z \cos t) ce_{2n+1}(t, h^2) dt \\ & = -\frac{hA_1^{2n+1}(h^2)}{ce'_{2n+1}(\frac{1}{2}\pi, h^2)} ce_{2n+1}(z, h^2), \end{aligned}$$

#### 28.10.4

$$\begin{aligned} & \frac{2}{\pi} \int_0^{\pi/2} \cos z \cos t \cosh(2h \sin z \sin t) ce_{2n+1}(t, h^2) dt \\ & = \frac{A_1^{2n+1}(h^2)}{2 ce_{2n+1}(0, h^2)} ce_{2n+1}(z, h^2), \end{aligned}$$

#### 28.10.5

$$\begin{aligned} & \frac{2}{\pi} \int_0^{\pi/2} \sinh(2h \sin z \sin t) se_{2n+1}(t, h^2) dt \\ & = \frac{hB_1^{2n+1}(h^2)}{se'_{2n+1}(0, h^2)} se_{2n+1}(z, h^2), \end{aligned}$$

#### 28.10.6

$$\begin{aligned} & \frac{2}{\pi} \int_0^{\pi/2} \sin z \sin t \cos(2h \cos z \cos t) se_{2n+1}(t, h^2) dt \\ & = \frac{B_1^{2n+1}(h^2)}{2 se_{2n+1}(\frac{1}{2}\pi, h^2)} se_{2n+1}(z, h^2), \end{aligned}$$

#### 28.10.7

$$\begin{aligned} & \frac{2}{\pi} \int_0^{\pi/2} \sin z \sin t \sin(2h \cos z \cos t) se_{2n+2}(t, h^2) dt \\ & = -\frac{hB_2^{2n+2}(h^2)}{2 se'_{2n+2}(\frac{1}{2}\pi, h^2)} se_{2n+2}(z, h^2), \end{aligned}$$

#### 28.10.8

$$\begin{aligned} & \frac{2}{\pi} \int_0^{\pi/2} \cos z \cos t \sinh(2h \sin z \sin t) se_{2n+2}(t, h^2) dt \\ & = \frac{hB_2^{2n+2}(h^2)}{2 se'_{2n+2}(0, h^2)} se_{2n+2}(z, h^2). \end{aligned}$$

#### 28.10(ii) Equations with Bessel-Function Kernels

$$\begin{aligned} 28.10.9 \quad & \int_0^{\pi/2} J_0\left(2\sqrt{q(\cos^2 \tau - \sin^2 \zeta)}\right) ce_{2n}(\tau, q) d\tau \\ & = w_{II}\left(\frac{1}{2}\pi; a_{2n}(q), q\right) ce_{2n}(\zeta, q), \end{aligned}$$

$$\begin{aligned} 28.10.10 \quad & \int_0^\pi J_0(2\sqrt{q}(\cos \tau + \cos \zeta)) ce_n(\tau, q) d\tau \\ & = w_{II}(\pi; a_n(q), q) ce_n(\zeta, q). \end{aligned}$$

#### 28.10(iii) Further Equations

See §28.28. See also Prudnikov *et al.* (1990, pp. 359–368), Erdélyi *et al.* (1955, p. 115), and Gradshteyn and Ryzhik (2000, pp. 755–759). For relations with variable boundaries see Volkmer (1983).



### 28.11 Expansions in Series of Mathieu Functions

Let  $f(z)$  be a  $2\pi$ -periodic function that is analytic in an open doubly-infinite strip  $S$  that contains the real axis, and  $q$  be a normal value (§28.7). Then

28.11.1

$$f(z) = \alpha_0 \operatorname{ce}_0(z, q) + \sum_{n=1}^{\infty} (\alpha_n \operatorname{ce}_n(z, q) + \beta_n \operatorname{se}_n(z, q)),$$

where

28.11.2

$$\alpha_n = \frac{1}{\pi} \int_0^{2\pi} f(x) \operatorname{ce}_n(x, q) dx,$$

$$\beta_n = \frac{1}{\pi} \int_0^{2\pi} f(x) \operatorname{se}_n(x, q) dx.$$

The series (28.11.1) converges absolutely and uniformly on any compact subset of the strip  $S$ . See Meixner and Schäfer (1954, §2.28), and for expansions in the case of the exceptional values of  $q$  see Meixner *et al.* (1980, p. 33).

#### Examples

With the notation of §28.4,

28.11.3

$$1 = 2 \sum_{n=0}^{\infty} A_0^{2n}(q) \operatorname{ce}_{2n}(z, q),$$

28.11.4

$$\cos 2mz = \sum_{n=0}^{\infty} A_{2m}^{2n}(q) \operatorname{ce}_{2n}(z, q), \quad m \neq 0,$$

28.11.5

$$\cos (2m + 1)z = \sum_{n=0}^{\infty} A_{2m+1}^{2n+1}(q) \operatorname{ce}_{2n+1}(z, q),$$

28.11.6

$$\sin (2m + 1)z = \sum_{n=0}^{\infty} B_{2m+1}^{2n+1}(q) \operatorname{se}_{2n+1}(z, q),$$

28.11.7

$$\sin (2m + 2)z = \sum_{n=0}^{\infty} B_{2m+2}^{2n+2}(q) \operatorname{se}_{2n+2}(z, q).$$

## Mathieu Functions of Noninteger Order

### 28.12 Definitions and Basic Properties

#### 28.12(i) Eigenvalues $\lambda_{\nu+2n}(q)$

The introduction to the eigenvalues and the functions of general order proceeds as in §§28.2(i), 28.2(ii), and 28.2(iii), except that we now restrict  $\hat{\nu} \neq 0, 1$ ; equivalently  $\nu \neq n$ . In consequence, for the Floquet solutions  $w(z)$  the factor  $e^{\pi i \nu}$  in (28.2.14) is no longer  $\pm 1$ .

For given  $\nu$  (or  $\cos(\nu\pi)$ ) and  $q$ , equation (28.2.16) determines an infinite discrete set of values of  $a$ , denoted by  $\lambda_{\nu+2n}(q)$ ,  $n = 0, \pm 1, \pm 2, \dots$ . When  $q = 0$  Equation (28.2.16) has simple roots, given by

28.12.1

$$\lambda_{\nu+2n}(0) = (\nu + 2n)^2.$$

For other values of  $q$ ,  $\lambda_{\nu+2n}(q)$  is determined by analytic continuation. Without loss of generality, from now on we replace  $\nu + 2n$  by  $\nu$ .

For change of signs of  $\nu$  and  $q$ ,

28.12.2

$$\lambda_{\nu}(-q) = \lambda_{\nu}(q) = \lambda_{-\nu}(q).$$

As in §28.7 values of  $q$  for which (28.2.16) has simple roots  $\lambda$  are called *normal values* with respect to  $\nu$ . For real values of  $\nu$  and  $q$  all the  $\lambda_{\nu}(q)$  are real, and  $q$  is normal. For graphical interpretation see Figure 28.13.1. To complete the definition we require

28.12.3

$$\lambda_m(q) = \begin{cases} a_m(q), & m = 0, 1, \dots, \\ b_{-m}(q), & m = -1, -2, \dots \end{cases}$$

As a function of  $\nu$  with fixed  $q$  ( $\neq 0$ ),  $\lambda_{\nu}(q)$  is discontinuous at  $\nu = \pm 1, \pm 2, \dots$ . See Figure 28.13.2.

#### 28.12(ii) Eigenfunctions $\operatorname{me}_{\nu}(z, q)$

Two eigenfunctions correspond to each eigenvalue  $a = \lambda_{\nu}(q)$ . The Floquet solution with respect to  $\nu$  is denoted by  $\operatorname{me}_{\nu}(z, q)$ . For  $q = 0$ ,

28.12.4

$$\operatorname{me}_{\nu}(z, 0) = e^{i\nu z}.$$

The other eigenfunction is  $\operatorname{me}_{\nu}(-z, q)$ , a Floquet solution with respect to  $-\nu$  with  $a = \lambda_{\nu}(q)$ . If  $q$  is a normal value of the corresponding equation (28.2.16), then these functions are uniquely determined as analytic functions of  $z$  and  $q$  by the normalization

28.12.5

$$\int_0^{\pi} \operatorname{me}_{\nu}(x, q) \operatorname{me}_{\nu}(-x, q) dx = \pi.$$

They have the following pseudoperiodic and orthogonality properties:

28.12.6

$$\operatorname{me}_{\nu}(z + \pi, q) = e^{\pi i \nu} \operatorname{me}_{\nu}(z, q),$$

28.12.7

$$\int_0^{\pi} \operatorname{me}_{\nu+2m}(x, q) \operatorname{me}_{\nu+2n}(-x, q) dx = 0, \quad m \neq n.$$

For changes of sign of  $\nu$ ,  $q$ , and  $z$ ,

28.12.8

$$\operatorname{me}_{-\nu}(z, q) = \operatorname{me}_{\nu}(-z, q),$$

28.12.9

$$\operatorname{me}_{\nu}(z, -q) = e^{i\nu\pi/2} \operatorname{me}_{\nu}(z - \frac{1}{2}\pi, q),$$

28.12.10

$$\overline{\operatorname{me}_{\nu}(z, q)} = \operatorname{me}_{\bar{\nu}}(-\bar{z}, \bar{q}).$$

(28.12.10) is not valid for cuts on the real axis in the  $q$ -plane for special complex values of  $\nu$ ; but it remains valid for small  $q$ ; compare §28.7.

To complete the definitions of the  $me_\nu$  functions we set

28.12.11  $me_n(z, q) = \sqrt{2} ce_n(z, q), \quad n = 0, 1, 2, \dots,$   
 $me_{-n}(z, q) = -\sqrt{2}i se_n(z, q), \quad n = 1, 2, \dots;$

compare (28.12.3). However, these functions are *not* the limiting values of  $me_{\pm\nu}(z, q)$  as  $\nu \rightarrow n (\neq 0)$ .

**28.12(iii) Functions  $ce_\nu(z, q)$ ,  $se_\nu(z, q)$ , when  $\nu \notin \mathbb{Z}$**

28.12.12  $ce_\nu(z, q) = \frac{1}{2} (me_\nu(z, q) + me_\nu(-z, q)),$

28.12.13  $se_\nu(z, q) = -\frac{1}{2}i (me_\nu(z, q) - me_\nu(-z, q)).$

These functions are real-valued for real  $\nu$ , real  $q$ , and  $z = x$ , whereas  $me_\nu(x, q)$  is complex. When  $\nu = s/m$  is a rational number, but not an integer, all solutions of Mathieu's equation are periodic with period  $2m\pi$ .

For change of signs of  $\nu$  and  $z$ ,

28.12.14  $ce_\nu(z, q) = ce_\nu(-z, q) = ce_{-\nu}(z, q),$

28.12.15  $se_\nu(z, q) = -se_\nu(-z, q) = -se_{-\nu}(z, q).$

Again, the limiting values of  $ce_\nu(z, q)$  and  $se_\nu(z, q)$  as  $\nu \rightarrow n (\neq 0)$  are *not* the functions  $ce_n(z, q)$  and  $se_n(z, q)$  defined in §28.2(vi). Compare e.g. Figure 28.13.3.

**28.13 Graphics**

**28.13(i) Eigenvalues  $\lambda_\nu(q)$  for General  $\nu$**

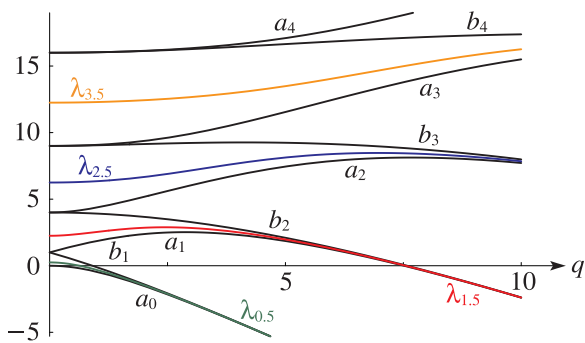


Figure 28.13.1:  $\lambda_\nu(q)$  as a function of  $q$  for  $\nu = 0.5(1)3.5$  and  $a_n(q), b_n(q)$  for  $n = 0, 1, 2, 3, 4$  ( $a$ 's),  $n = 1, 2, 3, 4$  ( $b$ 's). (Compare Figure 28.2.1.)

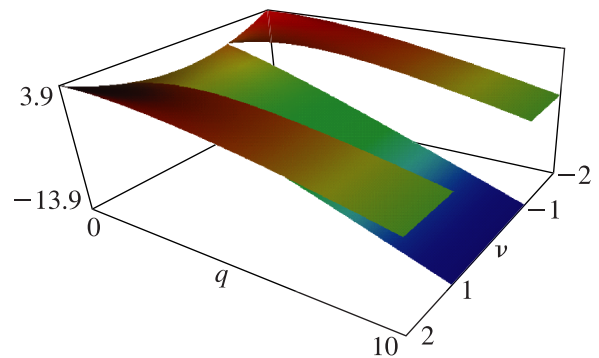


Figure 28.13.2:  $\lambda_\nu(q)$  for  $-2 < \nu < 2, 0 \leq q \leq 10$ .

**28.13(ii) Solutions  $ce_\nu(x, q)$ ,  $se_\nu(x, q)$ , and  $me_\nu(x, q)$  for General  $\nu$**

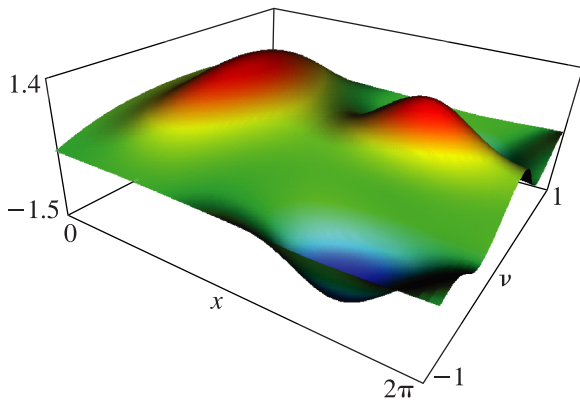


Figure 28.13.3:  $ce_\nu(x, 1)$  for  $-1 < \nu < 1, 0 \leq x \leq 2\pi$ .

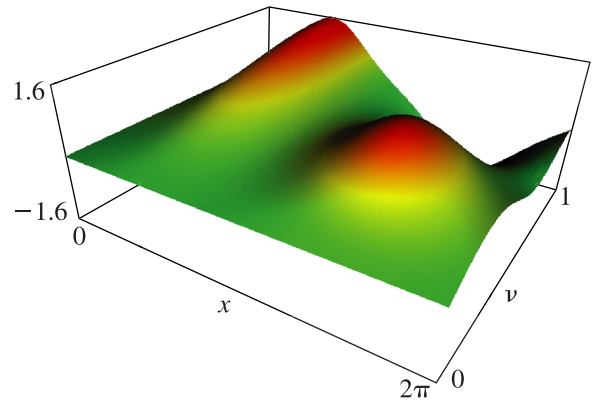


Figure 28.13.4:  $se_\nu(x, 1)$  for  $0 < \nu < 1, 0 \leq x \leq 2\pi$ .

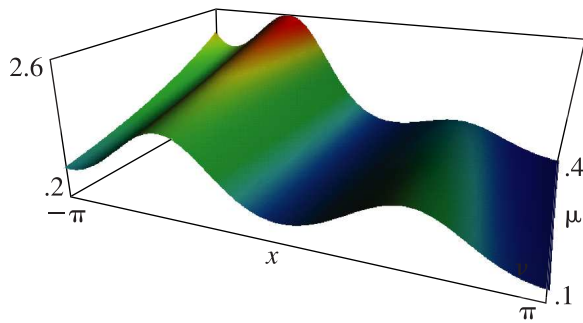


Figure 28.13.5:  $me_{i\mu}(x, 1)$  for  $0.1 \leq \mu \leq 0.4$ ,  $-\pi \leq x \leq \pi$ .

### 28.14 Fourier Series

The Fourier series

$$28.14.1 \quad me_{\nu}(z, q) = \sum_{m=-\infty}^{\infty} c_{2m}^{\nu}(q) e^{i(\nu+2m)z},$$

$$28.14.2 \quad ce_{\nu}(z, q) = \sum_{m=-\infty}^{\infty} c_{2m}^{\nu}(q) \cos(\nu + 2m)z,$$

$$28.14.3 \quad se_{\nu}(z, q) = \sum_{m=-\infty}^{\infty} c_{2m}^{\nu}(q) \sin(\nu + 2m)z,$$

converge absolutely and uniformly on all compact sets in the  $z$ -plane. The coefficients satisfy

$$28.14.4 \quad qc_{2m+2} - (a - (\nu + 2m)^2) c_{2m} + qc_{2m-2} = 0, \\ a = \lambda_{\nu}(q), c_{2m} = c_{2m}^{\nu}(q),$$

and the normalization relation

$$28.14.5 \quad \sum_{m=-\infty}^{\infty} (c_{2m}^{\nu}(q))^2 = 1;$$

compare (28.12.5). Ambiguities in sign are resolved by (28.14.9) when  $q = 0$ , and by continuity for other values of  $q$ .

The rate of convergence is indicated by

$$28.14.6 \quad \frac{c_{2m}^{\nu}(q)}{c_{2m\mp 2}^{\nu}(q)} = \frac{-q}{4m^2} \left( 1 + O\left(\frac{1}{m}\right) \right), \quad m \rightarrow \pm\infty.$$

For changes of sign of  $\nu$ ,  $q$ , and  $m$ ,

$$28.14.7 \quad c_{-2m}^{-\nu}(q) = c_{2m}^{\nu}(q),$$

$$28.14.8 \quad c_{2m}^{\nu}(-q) = (-1)^m c_{2m}^{\nu}(q).$$

When  $q = 0$ ,

$$28.14.9 \quad c_0^{\nu}(0) = 1, \quad c_{2m}^{\nu}(0) = 0, \quad m \neq 0.$$

When  $q \rightarrow 0$  with  $m (\geq 1)$  and  $\nu$  fixed,

$$28.14.10 \quad c_{2m}^{\nu}(q) = \left( \frac{(-1)^m q^m \Gamma(\nu + 1)}{m! 2^{2m} \Gamma(\nu + m + 1)} + O(q^{m+2}) \right) c_0^{\nu}(q).$$

### 28.15 Expansions for Small $q$

#### 28.15(i) Eigenvalues $\lambda_{\nu}(q)$

28.15.1

$$\lambda_{\nu}(q) = \nu^2 + \frac{1}{2(\nu^2 - 1)} q^2 + \frac{5\nu^2 + 7}{32(\nu^2 - 1)^3(\nu^2 - 4)} q^4 \\ + \frac{9\nu^4 + 58\nu^2 + 29}{64(\nu^2 - 1)^5(\nu^2 - 4)(\nu^2 - 9)} q^6 + \dots$$

Higher coefficients can be found by equating powers of  $q$  in the following continued-fraction equation, with  $a = \lambda_{\nu}(q)$ :

$$28.15.2 \quad a - \nu^2 - \frac{q^2}{a - (\nu + 2)^2} - \frac{q^2}{a - (\nu + 4)^2} - \dots \\ = \frac{q^2}{a - (\nu - 2)^2} - \frac{q^2}{a - (\nu - 4)^2} - \dots$$

#### 28.15(ii) Solutions $me_{\nu}(z, q)$

28.15.3

$$me_{\nu}(z, q) \\ = e^{i\nu z} - \frac{q}{4} \left( \frac{1}{\nu + 1} e^{i(\nu+2)z} - \frac{1}{\nu - 1} e^{i(\nu-2)z} \right) \\ + \frac{q^2}{32} \left( \frac{1}{(\nu + 1)(\nu + 2)} e^{i(\nu+4)z} \right. \\ \left. + \frac{1}{(\nu - 1)(\nu - 2)} e^{i(\nu-4)z} - \frac{2(\nu^2 + 1)}{(\nu^2 - 1)^2} e^{i\nu z} \right) + \dots;$$

compare §28.6(ii).

### 28.16 Asymptotic Expansions for Large $q$

Let  $s = 2m + 1$ ,  $m = 0, 1, 2, \dots$ , and  $\nu$  be fixed with  $m < \nu < m + 1$ . Then as  $h(= \sqrt{q}) \rightarrow +\infty$

28.16.1

$$\lambda_{\nu}(h^2) \sim -2h^2 + 2sh - \frac{1}{8}(s^2 + 1) - \frac{1}{27h}(s^3 + 3s) \\ - \frac{1}{2^{12}h^2}(5s^4 + 34s^2 + 9) \\ - \frac{1}{2^{17}h^3}(33s^5 + 410s^3 + 405s) \\ - \frac{1}{2^{20}h^4}(63s^6 + 1260s^4 + 2943s^2 + 486) \\ - \frac{1}{2^{25}h^5}(527s^7 + 15617s^5 + 69001s^3 + 41607s) \\ + \dots$$

For graphical interpretation, see Figures 28.13.1 and 28.13.2.

See also §28.8(iv).

### 28.17 Stability as $x \rightarrow \pm\infty$

If all solutions of (28.2.1) are bounded when  $x \rightarrow \pm\infty$  along the real axis, then the corresponding pair of parameters  $(a, q)$  is called *stable*. All other pairs are *unstable*.

For example, positive real values of  $a$  with  $q = 0$  comprise stable pairs, as do values of  $a$  and  $q$  that correspond to real, but noninteger, values of  $\nu$ .

However, if  $\Im\nu \neq 0$ , then  $(a, q)$  always comprises an unstable pair. For example, as  $x \rightarrow +\infty$  one of the solutions  $\text{me}_\nu(x, q)$  and  $\text{me}_\nu(-x, q)$  tends to 0 and the other is unbounded (compare Figure 28.13.5). Also, all nontrivial solutions of (28.2.1) are unbounded on  $\mathbb{R}$ .

For real  $a$  and  $q$  ( $\neq 0$ ) the stable regions are the open regions indicated in color in Figure 28.17.1. The boundary of each region comprises the *characteristic curves*  $a = a_n(q)$  and  $a = b_n(q)$ ; compare Figure 28.2.1.

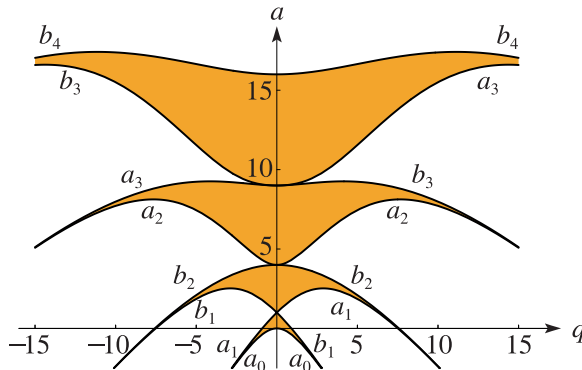


Figure 28.17.1: Stability chart for eigenvalues of Mathieu's equation (28.2.1).

### 28.18 Integrals and Integral Equations

See §28.28.

### 28.19 Expansions in Series of $\text{me}_{\nu+2n}$ Functions

Let  $q$  be a normal value (§28.12(i)) with respect to  $\nu$ , and  $f(z)$  be a function that is analytic on a doubly-infinite open strip  $S$  that contains the real axis. Assume also

$$28.19.1 \quad f(z + \pi) = e^{i\nu\pi} f(z).$$

Then

$$28.19.2 \quad f(z) = \sum_{n=-\infty}^{\infty} f_n \text{me}_{\nu+2n}(z, q),$$

where

$$28.19.3 \quad f_n = \frac{1}{\pi} \int_0^\pi f(z) \text{me}_{\nu+2n}(-z, q) dz.$$

The series (28.19.2) converges absolutely and uniformly on compact subsets within  $S$ .

### Example

$$28.19.4 \quad e^{i\nu z} = \sum_{n=-\infty}^{\infty} c_{-2n}^{\nu+2n}(q) \text{me}_{\nu+2n}(z, q),$$

where the coefficients are as in §28.14.

## Modified Mathieu Functions

### 28.20 Definitions and Basic Properties

#### 28.20(i) Modified Mathieu's Equation

When  $z$  is replaced by  $\pm iz$ , (28.2.1) becomes the *modified Mathieu's equation*:

$$28.20.1 \quad w'' - (a - 2q \cosh(2z)) w = 0,$$

with its *algebraic form*

$$28.20.2 \quad (\zeta^2 - 1)w'' + \zeta w' + (4q\zeta^2 - 2q - a) w = 0, \quad \zeta = \cosh z.$$

#### 28.20(ii) Solutions $\text{Ce}_\nu, \text{Se}_\nu, \text{Me}_\nu, \text{Fe}_n, \text{Ge}_n$

$$28.20.3 \quad \text{Ce}_\nu(z, q) = \text{ce}_\nu(\pm iz, q), \quad \nu \neq -1, -2, \dots,$$

$$28.20.4 \quad \text{Se}_\nu(z, q) = \mp i \text{se}_\nu(\pm iz, q), \quad \nu \neq 0, -1, \dots,$$

$$28.20.5 \quad \text{Me}_\nu(z, q) = \text{me}_\nu(-iz, q),$$

$$28.20.6 \quad \text{Fe}_n(z, q) = \mp i \text{fe}_n(\pm iz, q), \quad n = 0, 1, \dots,$$

$$28.20.7 \quad \text{Ge}_n(z, q) = \text{ge}_n(\pm iz, q), \quad n = 1, 2, \dots$$

#### 28.20(iii) Solutions $\text{M}_\nu^{(j)}$

Assume first that  $\nu$  is real,  $q$  is positive, and  $a = \lambda_\nu(q)$ ; see §28.12(i). Write

$$28.20.8 \quad h = \sqrt{q} (> 0).$$

Then from §2.7(ii) it is seen that equation (28.20.2) has independent and unique solutions that are asymptotic to  $\zeta^{1/2} e^{\pm 2ih\zeta}$  as  $\zeta \rightarrow \infty$  in the respective sectors  $|\text{ph}(\mp i\zeta)| \leq \frac{3}{2}\pi - \delta$ ,  $\delta$  being an arbitrary small positive constant. It follows that (28.20.1) has independent and unique solutions  $\text{M}_\nu^{(3)}(z, h), \text{M}_\nu^{(4)}(z, h)$  such that

$$28.20.9 \quad \text{M}_\nu^{(3)}(z, h) = H_\nu^{(1)}(2h \cosh z) (1 + O(\text{sech } z)),$$

as  $\Re z \rightarrow +\infty$  with  $-\pi + \delta \leq \Im z \leq 2\pi - \delta$ , and

$$28.20.10 \quad \text{M}_\nu^{(4)}(z, h) = H_\nu^{(2)}(2h \cosh z) (1 + O(\text{sech } z)),$$

as  $\Re z \rightarrow +\infty$  with  $-2\pi + \delta \leq \Im z \leq \pi - \delta$ . See §10.2(ii) for the notation. In addition, there are unique solutions  $\text{M}_\nu^{(1)}(z, h), \text{M}_\nu^{(2)}(z, h)$  that are real when  $z$  is real and have the properties

$$28.20.11 \quad \text{M}_\nu^{(1)}(z, h) = J_\nu(2h \cosh z) + e^{|\Im(2h \cosh z)|} O((\text{sech } z)^{3/2}),$$

#### 28.20.11

$$\text{M}_\nu^{(1)}(z, h) = J_\nu(2h \cosh z) + e^{|\Im(2h \cosh z)|} O((\text{sech } z)^{3/2}),$$

**28.20.12**

$M_\nu^{(2)}(z, h) = Y_\nu(2h \cosh z) + e^{|\Im(2h \cosh z)|} O\left((\operatorname{sech} z)^{3/2}\right)$ ,  
 as  $\Re z \rightarrow +\infty$  with  $|\Im z| \leq \pi - \delta$ .

For other values of  $z, h$ , and  $\nu$  the functions  $M_\nu^{(j)}(z, h), j = 1, 2, 3, 4$ , are determined by analytic continuation. Furthermore,

**28.20.13**  $M_\nu^{(3)}(z, h) = M_\nu^{(1)}(z, h) + i M_\nu^{(2)}(z, h),$

**28.20.14**  $M_\nu^{(4)}(z, h) = M_\nu^{(1)}(z, h) - i M_\nu^{(2)}(z, h).$

**28.20(iv) Radial Mathieu Functions  $Mc_n^{(j)}, Ms_n^{(j)}$**

For  $j = 1, 2, 3, 4$ ,

**28.20.15**  $Mc_n^{(j)}(z, h) = M_n^{(j)}(z, h), \quad n = 0, 1, \dots,$

**28.20.16**  $Ms_n^{(j)}(z, h) = (-1)^n M_{-n}^{(j)}(z, h), \quad n = 1, 2, \dots$

**28.20(v) Solutions  $Ie_n, Io_n, Ke_n, Ko_n$**

**28.20.17**  $Ie_n(z, h) = i^{-n} Mc_n^{(1)}(z, ih),$

**28.20.18**  $Io_n(z, h) = i^{-n} Ms_n^{(1)}(z, ih),$

**28.20.19**

$Ke_{2m}(z, h) = (-1)^m \frac{1}{2} \pi i Mc_{2m}^{(3)}(z, ih),$

$Ke_{2m+1}(z, h) = (-1)^{m+1} \frac{1}{2} \pi Mc_{2m+1}^{(3)}(z, ih),$

**28.20.20**

$Ko_{2m}(z, h) = (-1)^m \frac{1}{2} \pi i Ms_{2m}^{(3)}(z, ih),$

$Ko_{2m+1}(z, h) = (-1)^{m+1} \frac{1}{2} \pi Ms_{2m+1}^{(3)}(z, ih).$

**28.20(vi) Wronskians**

**28.20.21**

$$\begin{aligned} \mathscr{W} \{M_\nu^{(1)}, M_\nu^{(2)}\} &= -\mathscr{W} \{M_\nu^{(2)}, M_\nu^{(3)}\} \\ &= -\mathscr{W} \{M_\nu^{(2)}, M_\nu^{(4)}\} = 2/\pi, \\ \mathscr{W} \{M_\nu^{(1)}, M_\nu^{(3)}\} &= -\mathscr{W} \{M_\nu^{(1)}, M_\nu^{(4)}\} \\ &= -\frac{1}{2} \mathscr{W} \{M_\nu^{(3)}, M_\nu^{(4)}\} = 2i/\pi. \end{aligned}$$

**28.20(vii) Shift of Variable**

**28.20.22**  $M_\nu^{(j)}(z \pm \frac{1}{2} \pi i, h) = M_\nu^{(j)}(z, \pm ih), \quad \nu \notin \mathbb{Z}.$

For  $n = 0, 1, 2, \dots,$

**28.20.23**  $Mc_{2n}^{(j)}(z \pm \frac{1}{2} \pi i, h) = Mc_{2n}^{(j)}(z, \pm ih),$

$Ms_{2n+1}^{(j)}(z \pm \frac{1}{2} \pi i, h) = Mc_{2n+1}^{(j)}(z, \pm ih),$

**28.20.24**  $Mc_{2n+1}^{(j)}(z \pm \frac{1}{2} \pi i, h) = Ms_{2n+1}^{(j)}(z, \pm ih),$

$Ms_{2n+2}^{(j)}(z \pm \frac{1}{2} \pi i, h) = Ms_{2n+2}^{(j)}(z, \pm ih).$

For  $s \in \mathbb{Z},$

**28.20.25**

$M_\nu^{(1)}(z + s\pi i, h) = e^{is\pi\nu} M_\nu^{(1)}(z, h),$

$M_\nu^{(2)}(z + s\pi i, h) = e^{-is\pi\nu} M_\nu^{(2)}(z, h) + 2i \cot(\pi\nu) \sin(s\pi\nu) M_\nu^{(1)}(z, h),$

$M_\nu^{(3)}(z + s\pi i, h) = -\frac{\sin((s-1)\pi\nu)}{\sin(\pi\nu)} M_\nu^{(3)}(z, h) - e^{-i\pi\nu} \frac{\sin(s\pi\nu)}{\sin(\pi\nu)} M_\nu^{(4)}(z, h),$

$M_\nu^{(4)}(z + s\pi i, h) = e^{i\pi\nu} \frac{\sin(s\pi\nu)}{\sin(\pi\nu)} M_\nu^{(3)}(z, h) + \frac{\sin((s+1)\pi\nu)}{\sin(\pi\nu)} M_\nu^{(4)}(z, h).$

When  $\nu$  is an integer the right-hand sides of (28.20.25) are replaced by the their limiting values. And for the corresponding identities for the radial functions use (28.20.15) and (28.20.16).

## 28.21 Graphics

### Radial Mathieu Functions: Surfaces

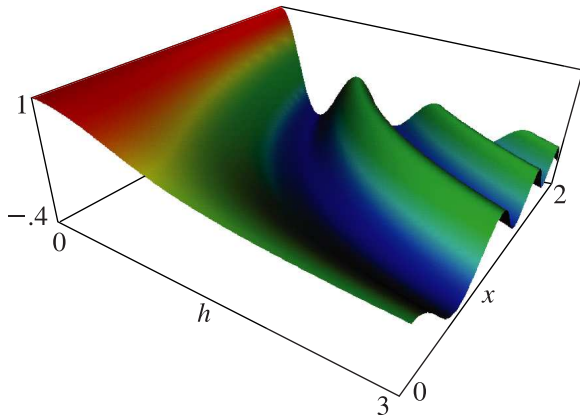


Figure 28.21.1:  $\text{Mc}_0^{(1)}(x, h)$  for  $0 \leq h \leq 3$ ,  $0 \leq x \leq 2$ .

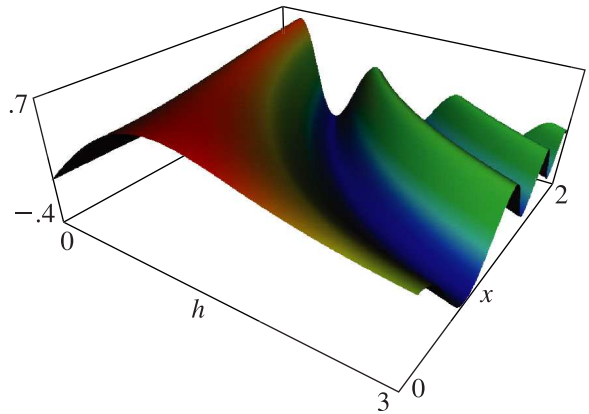


Figure 28.21.2:  $\text{Mc}_1^{(1)}(x, h)$  for  $0 \leq h \leq 3$ ,  $0 \leq x \leq 2$ .

For further graphics see <http://dlmf.nist.gov/28.21>.

## 28.22 Connection Formulas

### 28.22(i) Integer $\nu$

28.22.1

$$\text{Mc}_m^{(1)}(z, h) = \sqrt{\frac{2}{\pi}} \frac{1}{g_{e,m}(h) \text{ce}_m(0, h^2)} \text{Ce}_m(z, h^2),$$

28.22.2

$$\text{Ms}_m^{(1)}(z, h) = \sqrt{\frac{2}{\pi}} \frac{1}{g_{o,m}(h) \text{se}'_m(0, h^2)} \text{Se}_m(z, h^2),$$

28.22.3

$$\begin{aligned} \text{Mc}_m^{(2)}(z, h) = & \sqrt{\frac{2}{\pi}} \frac{1}{g_{e,m}(h) \text{ce}_m(0, h^2)} \\ & \times \left( -f_{e,m}(h) \text{Ce}_m(z, h^2) \right. \\ & \left. + \frac{2}{\pi C_m(h^2)} \text{Fe}_m(z, h^2) \right), \end{aligned}$$

28.22.4

$$\begin{aligned} \text{Ms}_m^{(2)}(z, h) = & \sqrt{\frac{2}{\pi}} \frac{1}{g_{o,m}(h) \text{se}'_m(0, h^2)} \\ & \times \left( -f_{o,m}(h) \text{Se}_m(z, h^2) \right. \\ & \left. - \frac{2}{\pi S_m(h^2)} \text{Ge}_m(z, h^2) \right). \end{aligned}$$

The *joining factors* in the above formulas are given by

28.22.5 
$$g_{e,2m}(h) = (-1)^m \sqrt{\frac{2}{\pi}} \frac{\text{ce}_{2m}(\frac{1}{2}\pi, h^2)}{A_0^{2m}(h^2)},$$

28.22.6 
$$g_{e,2m+1}(h) = (-1)^{m+1} \sqrt{\frac{2}{\pi}} \frac{\text{ce}'_{2m+1}(\frac{1}{2}\pi, h^2)}{h A_1^{2m+1}(h^2)},$$

28.22.7 
$$g_{o,2m+1}(h) = (-1)^m \sqrt{\frac{2}{\pi}} \frac{\text{se}_{2m+1}(\frac{1}{2}\pi, h^2)}{h B_1^{2m+1}(h^2)},$$

28.22.8 
$$g_{o,2m+2}(h) = (-1)^{m+1} \sqrt{\frac{2}{\pi}} \frac{\text{se}'_{2m+2}(\frac{1}{2}\pi, h^2)}{h^2 B_2^{2m+2}(h^2)},$$

28.22.9 
$$f_{e,m}(h) = -\sqrt{\pi/2} g_{e,m}(h) \text{Mc}_m^{(2)}(0, h),$$

28.22.10 
$$f_{o,m}(h) = -\sqrt{\pi/2} g_{o,m}(h) \text{Ms}_m^{(2)'}(0, h),$$
  
 where  $A_n^m(h^2)$ ,  $B_n^m(h^2)$  are as in §28.4(i), and  $C_m(h^2)$ ,  $S_m(h^2)$  are as in §28.5(i). Furthermore,

28.22.11 
$$\begin{aligned} \text{Mc}_m^{(2)'}(0, h) &= \sqrt{2/\pi} g_{e,m}(h), \\ \text{Ms}_m^{(2)}(0, h) &= -\sqrt{2/\pi} g_{o,m}(h), \end{aligned}$$

28.22.12

$$\begin{aligned} \text{fe}'_m(0, h^2) &= \frac{1}{2} \pi C_m(h^2) (g_{e,m}(h))^2 \text{ce}_m(0, h^2), \\ \text{ge}_m(0, h^2) &= \frac{1}{2} \pi S_m(h^2) (g_{o,m}(h))^2 \text{se}'_m(0, h^2). \end{aligned}$$

### 28.22(ii) Noninteger $\nu$

28.22.13 
$$\text{M}_\nu^{(1)}(z, h) = \frac{\text{M}_\nu^{(1)}(0, h)}{\text{me}_\nu(0, h^2)} \text{Me}_\nu(z, h^2).$$

Here  $\text{me}_\nu(0, h^2)$  ( $\neq 0$ ) is given by (28.14.1) with  $z = 0$ , and  $\text{M}_\nu^{(1)}(0, h)$  is given by (28.24.1) with  $j = 1$ ,  $z = 0$ , and  $n$  chosen so that  $|c_{2n}^{\nu}(h^2)| = \max(|c_{2\ell}^{\nu}(h^2)|)$ , where the maximum is taken over all integers  $\ell$ .

28.22.14

$$\text{M}_\nu^{(2)}(z, h) = \cot(\nu\pi) \text{M}_\nu^{(1)}(z, h) - \frac{1}{\sin(\nu\pi)} \text{M}_{-\nu}^{(1)}(z, h).$$

See also (28.20.13) and (28.20.14).

### 28.23 Expansions in Series of Bessel Functions

We use the following notations:

$$28.23.1 \quad \mathcal{C}_\mu^{(1)} = J_\mu, \quad \mathcal{C}_\mu^{(2)} = Y_\mu, \quad \mathcal{C}_\mu^{(3)} = H_\mu^{(1)}, \quad \mathcal{C}_\mu^{(4)} = H_\mu^{(2)};$$

compare §10.2(ii). For the coefficients  $c_n^\nu(q)$  see §28.14. For  $A_n^m(q)$  and  $B_n^m(q)$  see §28.4.

$$28.23.2 \quad \text{me}_\nu(0, h^2) M_\nu^{(j)}(z, h) = \sum_{n=-\infty}^{\infty} (-1)^n c_{2n}^\nu(h^2) \mathcal{C}_{\nu+2n}^{(j)}(2h \cosh z),$$

$$28.23.3 \quad \text{me}'_\nu(0, h^2) M_\nu^{(j)}(z, h) = i \tanh z \sum_{n=-\infty}^{\infty} (-1)^n (\nu + 2n) c_{2n}^\nu(h^2) \mathcal{C}_{\nu+2n}^{(j)}(2h \cosh z),$$

valid for all  $z$  when  $j = 1$ , and for  $\Re z > 0$  and  $|\cosh z| > 1$  when  $j = 2, 3, 4$ .

$$28.23.4 \quad \text{me}_\nu(\tfrac{1}{2}\pi, h^2) M_\nu^{(j)}(z, h) = e^{i\nu\pi/2} \sum_{n=-\infty}^{\infty} c_{2n}^\nu(h^2) \mathcal{C}_{\nu+2n}^{(j)}(2h \sinh z),$$

$$28.23.5 \quad \text{me}'_\nu(\tfrac{1}{2}\pi, h^2) M_\nu^{(j)}(z, h) = i e^{i\nu\pi/2} \coth z \sum_{n=-\infty}^{\infty} (\nu + 2n) c_{2n}^\nu(h^2) \mathcal{C}_{\nu+2n}^{(j)}(2h \sinh z),$$

valid for all  $z$  when  $j = 1$ , and for  $\Re z > 0$  and  $|\sinh z| > 1$  when  $j = 2, 3, 4$ .

In the case when  $\nu$  is an integer

$$28.23.6 \quad \text{Mc}_{2m}^{(j)}(z, h) = (-1)^m (\text{ce}_{2m}(0, h^2))^{-1} \sum_{\ell=0}^{\infty} (-1)^\ell A_{2\ell}^{2m}(h^2) \mathcal{C}_{2\ell}^{(j)}(2h \cosh z),$$

$$28.23.7 \quad \text{Mc}_{2m}^{(j)}(z, h) = (-1)^m (\text{ce}_{2m}(\tfrac{1}{2}\pi, h^2))^{-1} \sum_{\ell=0}^{\infty} A_{2\ell}^{2m}(h^2) \mathcal{C}_{2\ell}^{(j)}(2h \sinh z),$$

$$28.23.8 \quad \text{Mc}_{2m+1}^{(j)}(z, h) = (-1)^m (\text{ce}_{2m+1}(0, h^2))^{-1} \sum_{\ell=0}^{\infty} (-1)^\ell A_{2\ell+1}^{2m+1}(h^2) \mathcal{C}_{2\ell+1}^{(j)}(2h \cosh z),$$

$$28.23.9 \quad \text{Mc}_{2m+1}^{(j)}(z, h) = (-1)^{m+1} (\text{ce}'_{2m+1}(\tfrac{1}{2}\pi, h^2))^{-1} \coth z \sum_{\ell=0}^{\infty} (2\ell + 1) A_{2\ell+1}^{2m+1}(h^2) \mathcal{C}_{2\ell+1}^{(j)}(2h \sinh z),$$

$$28.23.10 \quad \text{Ms}_{2m+1}^{(j)}(z, h) = (-1)^m (\text{se}_{2m+1}(0, h^2))^{-1} \tanh z \sum_{\ell=0}^{\infty} (-1)^\ell (2\ell + 1) B_{2\ell+1}^{2m+1}(h^2) \mathcal{C}_{2\ell+1}^{(j)}(2h \cosh z),$$

$$28.23.11 \quad \text{Ms}_{2m+1}^{(j)}(z, h) = (-1)^m (\text{se}_{2m+1}(\tfrac{1}{2}\pi, h^2))^{-1} \sum_{\ell=0}^{\infty} B_{2\ell+1}^{2m+1}(h^2) \mathcal{C}_{2\ell+1}^{(j)}(2h \sinh z),$$

$$28.23.12 \quad \text{Ms}_{2m+2}^{(j)}(z, h) = (-1)^m (\text{se}'_{2m+2}(0, h^2))^{-1} \tanh z \sum_{\ell=0}^{\infty} (-1)^\ell (2\ell + 2) B_{2\ell+2}^{2m+2}(h^2) \mathcal{C}_{2\ell+2}^{(j)}(2h \cosh z),$$

$$28.23.13 \quad \text{Ms}_{2m+2}^{(j)}(z, h) = (-1)^{m+1} (\text{se}'_{2m+2}(\tfrac{1}{2}\pi, h^2))^{-1} \coth z \sum_{\ell=0}^{\infty} (2\ell + 2) B_{2\ell+2}^{2m+2}(h^2) \mathcal{C}_{2\ell+2}^{(j)}(2h \sinh z).$$

When  $j = 1$ , each of the series (28.23.6)–(28.23.13) converges for all  $z$ . When  $j = 2, 3, 4$  the series in the even-numbered equations converge for  $\Re z > 0$  and  $|\cosh z| > 1$ , and the series in the odd-numbered equations converge for  $\Re z > 0$  and  $|\sinh z| > 1$ .

For proofs and generalizations, see Meixner and Schäfer (1954, §§2.62 and 2.64).

## 28.24 Expansions in Series of Cross-Products of Bessel Functions or Modified Bessel Functions

Throughout this section  $\varepsilon_0 = 2$  and  $\varepsilon_s = 1$ ,  $s = 1, 2, 3, \dots$

With  $\mathcal{C}_\mu^{(j)}$ ,  $c'_n(q)$ ,  $A_n^m(q)$ , and  $B_n^m(q)$  as in §28.23,

$$28.24.1 \quad c'_{2n}(h^2) M_\nu^{(j)}(z, h) = \sum_{\ell=-\infty}^{\infty} (-1)^\ell c'_{2\ell}(h^2) J_{\ell-n}(he^{-z}) \mathcal{C}_{\nu+n+\ell}^{(j)}(he^z),$$

where  $j = 1, 2, 3, 4$  and  $n \in \mathbb{Z}$ .

In the case when  $\nu$  is an integer,

$$28.24.2 \quad \varepsilon_s \text{Mc}_{2m}^{(j)}(z, h) = (-1)^m \sum_{\ell=0}^{\infty} (-1)^\ell \frac{A_{2\ell}^{2m}(h^2)}{A_{2s}^{2m}(h^2)} \left( J_{\ell-s}(he^{-z}) \mathcal{C}_{\ell+s}^{(j)}(he^z) + J_{\ell+s}(he^{-z}) \mathcal{C}_{\ell-s}^{(j)}(he^z) \right),$$

$$28.24.3 \quad \text{Mc}_{2m+1}^{(j)}(z, h) = (-1)^m \sum_{\ell=0}^{\infty} (-1)^\ell \frac{A_{2\ell+1}^{2m+1}(h^2)}{A_{2s+1}^{2m+1}(h^2)} \left( J_{\ell-s}(he^{-z}) \mathcal{C}_{\ell+s+1}^{(j)}(he^z) + J_{\ell+s+1}(he^{-z}) \mathcal{C}_{\ell-s}^{(j)}(he^z) \right),$$

$$28.24.4 \quad \text{Ms}_{2m+1}^{(j)}(z, h) = (-1)^m \sum_{\ell=0}^{\infty} (-1)^\ell \frac{B_{2\ell+1}^{2m+1}(h^2)}{B_{2s+1}^{2m+1}(h^2)} \left( J_{\ell-s}(he^{-z}) \mathcal{C}_{\ell+s+1}^{(j)}(he^z) - J_{\ell+s+1}(he^{-z}) \mathcal{C}_{\ell-s}^{(j)}(he^z) \right),$$

$$28.24.5 \quad \text{Ms}_{2m+2}^{(j)}(z, h) = (-1)^m \sum_{\ell=0}^{\infty} (-1)^\ell \frac{B_{2\ell+2}^{2m+2}(h^2)}{B_{2s+2}^{2m+2}(h^2)} \left( J_{\ell-s}(he^{-z}) \mathcal{C}_{\ell+s+2}^{(j)}(he^z) - J_{\ell+s+2}(he^{-z}) \mathcal{C}_{\ell-s}^{(j)}(he^z) \right),$$

where  $j = 1, 2, 3, 4$ , and  $s = 0, 1, 2, \dots$

Also, with  $I_n$  and  $K_n$  denoting the modified Bessel functions (§10.25(ii)), and again with  $s = 0, 1, 2, \dots$ ,

$$28.24.6 \quad \varepsilon_s \text{Ie}_{2m}(z, h) = (-1)^s \sum_{\ell=0}^{\infty} (-1)^\ell \frac{A_{2\ell}^{2m}(h^2)}{A_{2s}^{2m}(h^2)} \left( I_{\ell-s}(he^{-z}) I_{\ell+s}(he^z) + I_{\ell+s}(he^{-z}) I_{\ell-s}(he^z) \right),$$

$$28.24.7 \quad \text{Io}_{2m+2}(z, h) = (-1)^s \sum_{\ell=0}^{\infty} (-1)^\ell \frac{B_{2\ell+2}^{2m+2}(h^2)}{B_{2s+2}^{2m+2}(h^2)} \left( I_{\ell-s}(he^{-z}) I_{\ell+s+2}(he^z) - I_{\ell+s+2}(he^{-z}) I_{\ell-s}(he^z) \right),$$

$$28.24.8 \quad \text{Ie}_{2m+1}(z, h) = (-1)^s \sum_{\ell=0}^{\infty} (-1)^\ell \frac{B_{2\ell+1}^{2m+1}(h^2)}{B_{2s+1}^{2m+1}(h^2)} \left( I_{\ell-s}(he^{-z}) I_{\ell+s+1}(he^z) + I_{\ell+s+1}(he^{-z}) I_{\ell-s}(he^z) \right),$$

$$28.24.9 \quad \text{Io}_{2m+1}(z, h) = (-1)^s \sum_{\ell=0}^{\infty} (-1)^\ell \frac{A_{2\ell+1}^{2m+1}(h^2)}{A_{2s+1}^{2m+1}(h^2)} \left( I_{\ell-s}(he^{-z}) I_{\ell+s+1}(he^z) - I_{\ell+s+1}(he^{-z}) I_{\ell-s}(he^z) \right),$$

$$28.24.10 \quad \varepsilon_s \text{Ke}_{2m}(z, h) = \sum_{\ell=0}^{\infty} \frac{A_{2\ell}^{2m}(h^2)}{A_{2s}^{2m}(h^2)} \left( I_{\ell-s}(he^{-z}) K_{\ell+s}(he^z) + I_{\ell+s}(he^{-z}) K_{\ell-s}(he^z) \right),$$

$$28.24.11 \quad \text{Ko}_{2m+2}(z, h) = \sum_{\ell=0}^{\infty} \frac{B_{2\ell+2}^{2m+2}(h^2)}{B_{2s+2}^{2m+2}(h^2)} \left( I_{\ell-s}(he^{-z}) K_{\ell+s+2}(he^z) - I_{\ell+s+2}(he^{-z}) K_{\ell-s}(he^z) \right),$$

$$28.24.12 \quad \text{Ke}_{2m+1}(z, h) = \sum_{\ell=0}^{\infty} \frac{B_{2\ell+1}^{2m+1}(h^2)}{B_{2s+1}^{2m+1}(h^2)} \left( I_{\ell-s}(he^{-z}) K_{\ell+s+1}(he^z) - I_{\ell+s+1}(he^{-z}) K_{\ell-s}(he^z) \right),$$

$$28.24.13 \quad \text{Ko}_{2m+1}(z, h) = \sum_{\ell=0}^{\infty} \frac{A_{2\ell+1}^{2m+1}(h^2)}{A_{2s+1}^{2m+1}(h^2)} \left( I_{\ell-s}(he^{-z}) K_{\ell+s+1}(he^z) + I_{\ell+s+1}(he^{-z}) K_{\ell-s}(he^z) \right).$$

The expansions (28.24.1)–(28.24.13) converge absolutely and uniformly on compact sets of the  $z$ -plane.



### 28.25 Asymptotic Expansions for Large $\Re z$

For fixed  $h (\neq 0)$  and fixed  $\nu$ ,

$$28.25.1 \quad M_\nu^{(3,4)}(z, h) \sim \frac{e^{\pm i(2h \cosh z - (\frac{1}{2}\nu + \frac{1}{4})\pi)}}{(\pi h (\cosh z + 1))^{\frac{1}{2}}} \times \sum_{m=0}^{\infty} \frac{D_m^\pm}{(\mp 4ih (\cosh z + 1))^m},$$

where the coefficients are given by

$$28.25.2 \quad D_{-1}^\pm = 0, \quad D_0^\pm = 1,$$

and

$$28.25.3 \quad (m+1)D_{m+1}^\pm + ((m + \frac{1}{2})^2 \pm (m + \frac{1}{4})8ih + 2h^2 - a) D_m^\pm \pm (m - \frac{1}{2})(8ihm) D_{m-1}^\pm = 0, \quad m \geq 0.$$

The upper signs correspond to  $M_\nu^{(3)}(z, h)$  and the lower signs to  $M_\nu^{(4)}(z, h)$ . The expansion (28.25.1) is valid for  $M_\nu^{(3)}(z, h)$  when

$$28.25.4 \quad \Re z \rightarrow +\infty, \quad -\pi + \delta \leq \text{ph } h + \Im z \leq 2\pi - \delta,$$

and for  $M_\nu^{(4)}(z, h)$  when

$$28.25.5 \quad \Re z \rightarrow +\infty, \quad -2\pi + \delta \leq \text{ph } h + \Im z \leq \pi - \delta,$$

where  $\delta$  again denotes an arbitrary small positive constant.

For proofs and generalizations see Meixner and Schäfer (1954, §2.63).

### 28.26 Asymptotic Approximations for Large $q$

#### 28.26(i) Goldstein's Expansions

Denote

$$28.26.1 \quad \text{Mc}_m^{(3)}(z, h) = \frac{e^{i\phi}}{(\pi h \cosh z)^{1/2}} \times (\text{Fc}_m(z, h) - i \text{Gc}_m(z, h)),$$

$$28.26.2 \quad i \text{Ms}_{m+1}^{(3)}(z, h) = \frac{e^{i\phi}}{(\pi h \cosh z)^{1/2}} \times (\text{Fs}_m(z, h) - i \text{Gs}_m(z, h)),$$

where

$$28.26.3 \quad \phi = 2h \sinh z - (m + \frac{1}{2}) \arctan(\sinh z).$$

Then as  $h \rightarrow +\infty$  with fixed  $z$  in  $\Re z > 0$  and fixed  $s = 2m + 1$ ,

$$28.26.4 \quad \text{Fc}_m(z, h) \sim 1 + \frac{s}{8h \cosh^2 z} + \frac{1}{2^{11}h^2} \left( \frac{s^4 + 86s^2 + 105}{\cosh^4 z} - \frac{s^4 + 22s^2 + 57}{\cosh^2 z} \right) + \frac{1}{2^{14}h^3} \left( -\frac{s^5 + 14s^3 + 33s}{\cosh^2 z} - \frac{2s^5 + 124s^3 + 1122s}{\cosh^4 z} + \frac{3s^5 + 290s^3 + 1627s}{\cosh^6 z} \right) + \dots,$$

$$28.26.5 \quad \text{Gc}_m(z, h) \sim \frac{\sinh z}{\cosh^2 z} \left( \frac{s^2 + 3}{2^5 h} + \frac{1}{2^9 h^2} \left( s^3 + 3s + \frac{4s^3 + 44s}{\cosh^2 z} \right) + \frac{1}{2^{14}h^3} \left( 5s^4 + 34s^2 + 9 - \frac{s^6 - 47s^4 + 667s^2 + 2835}{12 \cosh^2 z} + \frac{s^6 + 505s^4 + 12139s^2 + 10395}{12 \cosh^4 z} \right) \right) + \dots.$$

The asymptotic expansions of  $\text{Fs}_m(z, h)$  and  $\text{Gs}_m(z, h)$  in the same circumstances are also given by the right-hand sides of (28.26.4) and (28.26.5), respectively.

For additional terms see Goldstein (1927).

#### 28.26(ii) Uniform Approximations

See §28.8(iv). For asymptotic approximations for  $M_\nu^{(3,4)}(z, h)$  see also Naylor (1984, 1987, 1989).

### 28.27 Addition Theorems

Addition theorems provide important connections between Mathieu functions with different parameters and in different coordinate systems. They are analogous to the addition theorems for Bessel functions (§10.23(ii)) and modified Bessel functions (§10.44(ii)). For a comprehensive treatment see Meixner *et al.* (1980, §2.2).

### 28.28 Integrals, Integral Representations, and Integral Equations

#### 28.28(i) Equations with Elementary Kernels

Let

$$28.28.1 \quad w = \cosh z \cos t \cos \alpha + \sinh z \sin t \sin \alpha.$$

Then

$$28.28.2 \quad \frac{1}{2\pi} \int_0^{2\pi} e^{2ihw} \text{ce}_n(t, h^2) dt = i^n \text{ce}_n(\alpha, h^2) \text{Mc}_n^{(1)}(z, h),$$

$$28.28.3 \quad \frac{1}{2\pi} \int_0^{2\pi} e^{2ihw} \text{se}_n(t, h^2) dt = i^n \text{se}_n(\alpha, h^2) \text{Ms}_n^{(1)}(z, h),$$

$$\begin{aligned}
 \text{28.28.4} \quad & \frac{ih}{\pi} \int_0^{2\pi} \frac{\partial w}{\partial \alpha} e^{2ihw} ce_n(t, h^2) dt \\
 & = i^n ce'_n(\alpha, h^2) Mc_n^{(1)}(z, h),
 \end{aligned}$$

$$\begin{aligned}
 \text{28.28.5} \quad & \frac{ih}{\pi} \int_0^{2\pi} \frac{\partial w}{\partial \alpha} e^{2ihw} se_n(t, h^2) dt \\
 & = i^n se'_n(\alpha, h^2) Ms_n^{(1)}(z, h).
 \end{aligned}$$

In (28.28.7)–(28.28.9) the paths of integration  $\mathcal{L}_j$  are given by

$$\mathcal{L}_1 : \text{from } -\eta_1 + i\infty \text{ to } 2\pi - \eta_1 + i\infty,$$

$$\text{28.28.6} \quad \mathcal{L}_3 : \text{from } -\eta_1 + i\infty \text{ to } \eta_2 - i\infty,$$

$$\mathcal{L}_4 : \text{from } \eta_2 - i\infty \text{ to } 2\pi - \eta_1 + i\infty,$$

where  $\eta_1$  and  $\eta_2$  are real constants.

$$\begin{aligned}
 \text{28.28.7} \quad & \frac{1}{\pi} \int_{\mathcal{L}_j} e^{2ihw} me_\nu(t, h^2) dt \\
 & = e^{i\nu\pi/2} me_\nu(\alpha, h^2) M_\nu^{(j)}(z, h), \quad j = 3, 4,
 \end{aligned}$$

$$\begin{aligned}
 \text{28.28.8} \quad & \frac{1}{\pi} \int_{\mathcal{L}_j} 2ih \frac{\partial w}{\partial \alpha} e^{2ihw} me_\nu(t, h^2) dt \\
 & = e^{i\nu\pi/2} me'_\nu(\alpha, h^2) M_\nu^{(j)}(z, h), \quad j = 3, 4,
 \end{aligned}$$

$$\begin{aligned}
 \text{28.28.9} \quad & \frac{1}{2\pi} \int_{\mathcal{L}_1} e^{2ihw} me_\nu(t, h^2) dt \\
 & = e^{i\nu\pi/2} me_\nu(\alpha, h^2) M_\nu^{(1)}(z, h).
 \end{aligned}$$

In (28.28.11)–(28.28.14)

$$\text{28.28.10} \quad 0 < \text{ph}(h(\cosh z \pm 1)) < \pi.$$

$$\begin{aligned}
 \text{28.28.11} \quad & \int_0^\infty e^{2ih \cosh z \cosh t} Ce_\nu(t, h^2) dt \\
 & = \frac{1}{2} \pi i e^{i\nu\pi} ce_\nu(0, h^2) M_\nu^{(3)}(z, h),
 \end{aligned}$$

$$\begin{aligned}
 \text{28.28.12} \quad & \int_0^\infty e^{2ih \cosh z \cosh t} \sinh z \sinh t Se_\nu(t, h^2) dt \\
 & = -\frac{\pi}{4h} e^{i\nu\pi/2} se'_\nu(0, h^2) M_\nu^{(3)}(z, h),
 \end{aligned}$$

$$\begin{aligned}
 \text{28.28.13} \quad & \int_0^\infty e^{2ih \cosh z \cosh t} \sinh z \sinh t Fe_m(t, h^2) dt \\
 & = -\frac{\pi}{4h} i^m fe'_m(0, h^2) Mc_m^{(3)}(z, h),
 \end{aligned}$$

$$\begin{aligned}
 \text{28.28.14} \quad & \int_0^\infty e^{2ih \cosh z \cosh t} Ge_m(t, h^2) dt \\
 & = \frac{1}{2} \pi i^{m+1} ge_m(0, h^2) Ms_m^{(3)}(z, h).
 \end{aligned}$$

In particular, when  $h > 0$  the integrals (28.28.11), (28.28.14) converge absolutely and uniformly in the half strip  $\Re z \geq 0, 0 \leq \Im z \leq \pi$ .

$$\text{28.28.15} \quad \int_0^\infty \cos(2h \cos y \cosh t) Ce_{2n}(t, h^2) dt = (-1)^{n+1} \frac{1}{2} \pi Mc_{2n}^{(2)}(0, h) ce_{2n}(y, h^2),$$

$$\text{28.28.16} \quad \int_0^\infty \sin(2h \cos y \cosh t) Ce_{2n}(t, h^2) dt = -\frac{\pi A_0^{2n}(h^2)}{2 ce_{2n}(\frac{1}{2}\pi, h^2)} \left( ce_{2n}(y, h^2) \mp \frac{2}{\pi C_{2n}(h^2)} fe_{2n}(y, h^2) \right),$$

where the upper or lower sign is taken according as  $0 \leq y \leq \pi$  or  $\pi \leq y \leq 2\pi$ . For  $A_0^{2n}(q)$  and  $C_{2n}(q)$  see §§28.4 and 28.5(i).

For details and further equations see Meixner *et al.* (1980, §2.1.1) and Sips (1970).

### 28.28(ii) Integrals of Products with Bessel Functions

With the notations of §28.4 for  $A_m^n(q)$  and  $B_m^n(q)$ , §28.14 for  $c_\nu^n(q)$ , and (28.23.1) for  $C_\mu^{(j)}$ ,  $j = 1, 2, 3, 4$ ,

$$\begin{aligned}
 \text{28.28.17} \quad & \frac{1}{\pi} \int_0^\pi C_{\nu+2s}^{(j)}(2hR) e^{-i(\nu+2s)\phi} me_\nu(t, h^2) dt \\
 & = (-1)^s c_{2s}^\nu(h^2) M_\nu^{(j)}(z, h), \quad s \in \mathbb{Z},
 \end{aligned}$$

where  $R = R(z, t)$  and  $\phi = \phi(z, t)$  are analytic functions for  $\Re z > 0$  and real  $t$  with

$$\begin{aligned}
 \text{28.28.18} \quad & R(z, t) = \left( \frac{1}{2} (\cosh(2z) + \cos(2t)) \right)^{1/2}, \\
 & R(z, 0) = \cosh z,
 \end{aligned}$$

and

$$\begin{aligned}
 \text{28.28.19} \quad & e^{2i\phi} = \frac{\cosh(z + it)}{\cosh(z - it)}, \\
 & \phi(z, 0) = 0.
 \end{aligned}$$

In particular, for integer  $\nu$  and  $\ell = 0, 1, 2, \dots$ ,

$$\begin{aligned}
 \text{28.28.20} \quad & \frac{2}{\pi} \int_0^\pi C_{2\ell}^{(j)}(2hR) \cos(2\ell\phi) ce_{2m}(t, h^2) dt \\
 & = \varepsilon_\ell (-1)^{\ell+m} A_{2\ell}^{2m}(h^2) Mc_{2m}^{(j)}(z, h),
 \end{aligned}$$

where again  $\varepsilon_0 = 2$  and  $\varepsilon_\ell = 1$ ,  $\ell = 1, 2, 3, \dots$

$$\begin{aligned}
 \text{28.28.21} \quad & \frac{2}{\pi} \int_0^\pi C_{2\ell+1}^{(j)}(2hR) \cos((2\ell+1)\phi) ce_{2m+1}(t, h^2) dt \\
 & = (-1)^{\ell+m} A_{2\ell+1}^{2m+1}(h^2) Mc_{2m+1}^{(j)}(z, h),
 \end{aligned}$$

$$\begin{aligned}
 \text{28.28.22} \quad & \frac{2}{\pi} \int_0^\pi C_{2\ell+1}^{(j)}(2hR) \sin((2\ell+1)\phi) se_{2m+1}(t, h^2) dt \\
 & = (-1)^{\ell+m} B_{2\ell+1}^{2m+1}(h^2) Ms_{2m+1}^{(j)}(z, h),
 \end{aligned}$$

## 28.28.23

$$\begin{aligned} & \frac{2}{\pi} \int_0^\pi C_{2\ell+2}^{(j)}(2hR) \sin((2\ell+2)\phi) \operatorname{se}_{2m+2}(t, h^2) dt \\ &= (-1)^{\ell+m} B_{2\ell+2}^{2m+2}(h^2) \operatorname{Ms}_{2m+2}^{(j)}(z, h). \end{aligned}$$

### 28.28(iii) Integrals of Products of Mathieu Functions of Noninteger Order

With the parameter  $h$  suppressed we use the notation

## 28.28.24

$$\begin{aligned} D_0(\nu, \mu, z) &= M_\nu^{(3)}(z) M_\mu^{(4)}(z) - M_\nu^{(4)}(z) M_\mu^{(3)}(z), \\ D_1(\nu, \mu, z) &= M_\nu^{(3)'}(z) M_\mu^{(4)}(z) - M_\nu^{(4)'}(z) M_\mu^{(3)}(z), \end{aligned}$$

and assume  $\nu \notin \mathbb{Z}$  and  $m \in \mathbb{Z}$ . Then

## 28.28.25

$$\begin{aligned} & \frac{\sinh z}{\pi^2} \int_0^{2\pi} \frac{\cos t \operatorname{me}_\nu(t, h^2) \operatorname{me}_{-\nu-2m-1}(t, h^2)}{\sinh^2 z + \sin^2 t} dt \\ &= (-1)^{m+1} i h \alpha_{\nu, m}^{(0)} D_0(\nu, \nu + 2m + 1, z), \end{aligned}$$

## 28.28.26

$$\begin{aligned} & \frac{\cosh z}{\pi^2} \int_0^{2\pi} \frac{\sin t \operatorname{me}_\nu(t, h^2) \operatorname{me}_{-\nu-2m-1}(t, h^2)}{\sinh^2 z + \sin^2 t} dt \\ &= (-1)^{m+1} i h \alpha_{\nu, m}^{(1)} D_0(\nu, \nu + 2m + 1, z), \end{aligned}$$

where

## 28.28.27

$$\begin{aligned} \alpha_{\nu, m}^{(0)} &= \frac{1}{2\pi} \int_0^{2\pi} \cos t \operatorname{me}_\nu(t, h^2) \operatorname{me}_{-\nu-2m-1}(t, h^2) dt \\ &= (-1)^m \frac{2i \operatorname{me}_\nu(0, h^2) \operatorname{me}_{-\nu-2m-1}(0, h^2)}{\pi h D_0(\nu, \nu + 2m + 1, 0)}, \end{aligned}$$

## 28.28.28

$$\begin{aligned} \alpha_{\nu, m}^{(1)} &= \frac{1}{2\pi} \int_0^{2\pi} \sin t \operatorname{me}_\nu(t, h^2) \operatorname{me}_{-\nu-2m-1}(t, h^2) dt \\ &= (-1)^{m+1} \frac{2i \operatorname{me}'_\nu(0, h^2) \operatorname{me}_{-\nu-2m-1}(0, h^2)}{\pi h D_1(\nu, \nu + 2m + 1, 0)}. \end{aligned}$$

For further integrals see <http://dlmf.nist.gov/28.28.iii>.

### 28.28(iv) Integrals of Products of Mathieu Functions of Integer Order

Again with the parameter  $h$  suppressed, let

## 28.28.35

$$\begin{aligned} \operatorname{Ds}_0(n, m, z) &= \operatorname{Ms}_n^{(3)}(z) \operatorname{Ms}_m^{(4)}(z) - \operatorname{Ms}_n^{(4)}(z) \operatorname{Ms}_m^{(3)}(z), \\ \operatorname{Ds}_1(n, m, z) &= \operatorname{Ms}_n^{(3)'}(z) \operatorname{Ms}_m^{(4)}(z) - \operatorname{Ms}_n^{(4)'}(z) \operatorname{Ms}_m^{(3)}(z), \\ \operatorname{Ds}_2(n, m, z) &= \operatorname{Ms}_n^{(3)'}(z) \operatorname{Ms}_m^{(4)'}(z) - \operatorname{Ms}_n^{(4)'}(z) \operatorname{Ms}_m^{(3)'}(z). \end{aligned}$$

Then

$$\begin{aligned} \text{28.28.36} \quad & \frac{\sinh z}{\pi^2} \int_0^{2\pi} \frac{\cos t \operatorname{se}_n(t, h^2) \operatorname{se}_m(t, h^2)}{\sinh^2 z + \sin^2 t} dt \\ &= (-1)^{p+1} i h \widehat{\alpha}_{n, m}^{(s)} \operatorname{Ds}_0(n, m, z), \end{aligned}$$

$$\begin{aligned} \text{28.28.37} \quad & \frac{\cosh z}{\pi^2} \int_0^{2\pi} \frac{\sin t \operatorname{se}'_n(t, h^2) \operatorname{se}_m(t, h^2)}{\sinh^2 z + \sin^2 t} dt \\ &= (-1)^{p+1} i h \widehat{\alpha}_{n, m}^{(s)} \operatorname{Ds}_1(n, m, z), \end{aligned}$$

where  $m - n = 2p + 1$ ,  $p \in \mathbb{Z}$ ;  $m, n = 1, 2, 3, \dots$ . Also,

$$\begin{aligned} \widehat{\alpha}_{n, m}^{(s)} &= \frac{1}{2\pi} \int_0^{2\pi} \cos t \operatorname{se}_n(t, h^2) \operatorname{se}_m(t, h^2) dt \\ \text{28.28.38} \quad &= (-1)^p \frac{2 \operatorname{se}'_n(0, h^2) \operatorname{se}'_m(0, h^2)}{i\pi h \operatorname{Ds}_2(n, m, 0)}. \end{aligned}$$

For further integrals see <http://dlmf.nist.gov/28.28.iv> and Schäfke (1983).

### 28.28(v) Compendia

See Prudnikov *et al.* (1990, pp. 359–368), Gradshteyn and Ryzhik (2000, pp. 755–759), Sips (1970), and Meixner *et al.* (1980, §2.1.1).

## Hill's Equation

### 28.29 Definitions and Basic Properties

#### 28.29(i) Hill's Equation

A generalization of Mathieu's equation (28.2.1) is *Hill's equation*

$$\text{28.29.1} \quad w''(z) + (\lambda + Q(z)) w = 0,$$

with

$$\text{28.29.2} \quad Q(z + \pi) = Q(z),$$

and

$$\text{28.29.3} \quad \int_0^\pi Q(z) dz = 0.$$

$Q(z)$  is either a continuous and real-valued function for  $z \in \mathbb{R}$  or an analytic function of  $z$  in a doubly-infinite open strip that contains the real axis.  $\pi$  is the minimum period of  $Q$ .

#### 28.29(ii) Floquet's Theorem and the Characteristic Exponent

The *basic solutions*  $w_I(z, \lambda)$ ,  $w_{II}(z, \lambda)$  are defined in the same way as in §28.2(ii) (compare (28.2.5), (28.2.6)). Then

## 28.29.4

$$w_I(z + \pi, \lambda) = w_I(\pi, \lambda) w_I(z, \lambda) + w_I'(\pi, \lambda) w_{II}(z, \lambda),$$

## 28.29.5

$$w_{II}(z + \pi, \lambda) = w_{II}(\pi, \lambda) w_I(z, \lambda) + w_{II}'(\pi, \lambda) w_{II}(z, \lambda).$$

Let  $\nu$  be a real or complex constant satisfying (without loss of generality)

$$\text{28.29.6} \quad -1 < \Re \nu \leq 1$$

throughout this section. Then (28.29.1) has a nontrivial solution  $w(z)$  with the pseudoperiodic property

$$\text{28.29.7} \quad w(z + \pi) = e^{\pi i \nu} w(z),$$

iff  $e^{\pi i \nu}$  is an eigenvalue of the matrix

$$28.29.8 \quad \begin{bmatrix} w_I(\pi, \lambda) & w_{II}(\pi, \lambda) \\ w'_I(\pi, \lambda) & w'_{II}(\pi, \lambda) \end{bmatrix}.$$

Equivalently,

$$28.29.9 \quad 2 \cos(\pi \nu) = w_I(\pi, \lambda) + w'_{II}(\pi, \lambda).$$

This is the *characteristic equation* of (28.29.1), and  $\cos(\pi \nu)$  is an entire function of  $\lambda$ . Given  $\lambda$  together with the condition (28.29.6), the solutions  $\pm \nu$  of (28.29.9) are the *characteristic exponents* of (28.29.1). A solution satisfying (28.29.7) is called a *Floquet solution with respect to  $\nu$*  (or *Floquet solution*). It has the form

$$28.29.10 \quad F_\nu(z) = e^{i\nu z} P_\nu(z),$$

where the function  $P_\nu(z)$  is  $\pi$ -periodic.

If  $\nu (\neq 0, 1)$  is a solution of (28.29.9), then  $F_\nu(z)$ ,  $F_{-\nu}(z)$  comprise a fundamental pair of solutions of Hill's equation.

If  $\nu = 0$  or  $1$ , then (28.29.1) has a nontrivial solution  $P(z)$  which is periodic with period  $\pi$  (when  $\nu = 0$ ) or  $2\pi$  (when  $\nu = 1$ ). Let  $w(z)$  be a solution linearly independent of  $P(z)$ . Then

$$28.29.11 \quad w(z + \pi) = (-1)^\nu w(z) + cP(z),$$

where  $c$  is a constant. The case  $c = 0$  is equivalent to

$$28.29.12 \quad \begin{bmatrix} w_I(\pi, \lambda) & w_{II}(\pi, \lambda) \\ w'_I(\pi, \lambda) & w'_{II}(\pi, \lambda) \end{bmatrix} = \begin{bmatrix} (-1)^\nu & 0 \\ 0 & (-1)^\nu \end{bmatrix}.$$

The solutions of period  $\pi$  or  $2\pi$  are exceptional in the following sense. If (28.29.1) has a periodic solution with minimum period  $n\pi$ ,  $n = 3, 4, \dots$ , then all solutions are periodic with period  $n\pi$ .

Furthermore, for each solution  $w(z)$  of (28.29.1)

$$28.29.13 \quad w(z + \pi) + w(z - \pi) = 2 \cos(\pi \nu) w(z).$$

A nontrivial solution  $w(z)$  is either a Floquet solution with respect to  $\nu$ , or  $w(z + \pi) - e^{i\nu\pi} w(z)$  is a Floquet solution with respect to  $-\nu$ .

In the *symmetric case*  $Q(z) = Q(-z)$ ,  $w_I(z, \lambda)$  is an even solution and  $w_{II}(z, \lambda)$  is an odd solution; compare §28.2(ii). (28.29.9) reduces to

$$28.29.14 \quad \cos(\pi \nu) = w_I(\pi, \lambda).$$

The cases  $\nu = 0$  and  $\nu = 1$  split into four subcases as in (28.2.21) and (28.2.22). The  $\pi$ -periodic or  $\pi$ -antiperiodic solutions are multiples of  $w_I(z, \lambda)$ ,  $w_{II}(z, \lambda)$ , respectively.

For details and proofs see Magnus and Winkler (1966, §1.3).

### 28.29(iii) Discriminant and Eigenvalues in the Real Case

$Q(x)$  is assumed to be real-valued throughout this subsection.

The function

$$28.29.15 \quad \Delta(\lambda) = w_I(\pi, \lambda) + w'_{II}(\pi, \lambda)$$

is called the *discriminant* of (28.29.1). It is an entire function of  $\lambda$ . Its order of growth for  $|\lambda| \rightarrow \infty$  is exactly  $\frac{1}{2}$ ; see Magnus and Winkler (1966, Chapter II, pp. 19–28).

For a given  $\nu$ , the characteristic equation  $\Delta(\lambda) - 2 \cos(\pi \nu) = 0$  has infinitely many roots  $\lambda$ . Conversely, for a given  $\lambda$ , the value of  $\Delta(\lambda)$  is needed for the computation of  $\nu$ . For this purpose the discriminant can be expressed as an infinite determinant involving the Fourier coefficients of  $Q(x)$ ; see Magnus and Winkler (1966, §2.3, pp. 28–36).

To every equation (28.29.1), there belong two increasing infinite sequences of real *eigenvalues*:

$$28.29.16 \quad \lambda_n, \quad n = 0, 1, 2, \dots, \quad \text{with } \Delta(\lambda_n) = 2,$$

$$28.29.17 \quad \mu_n, \quad n = 1, 2, 3, \dots, \quad \text{with } \Delta(\mu_n) = -2.$$

In consequence, (28.29.1) has a solution of period  $\pi$  iff  $\lambda = \lambda_n$ , and a solution of period  $2\pi$  iff  $\lambda = \mu_n$ . Both  $\lambda_n$  and  $\mu_n \rightarrow \infty$  as  $n \rightarrow \infty$ , and interlace according to the inequalities

#### 28.29.18

$$\lambda_0 < \mu_1 \leq \mu_2 < \lambda_1 \leq \lambda_2 < \mu_3 \leq \mu_4 < \lambda_3 \leq \lambda_4 < \dots$$

Assume that the second derivative of  $Q(x)$  in (28.29.1) exists and is continuous. Then with

$$28.29.19 \quad N = \frac{1}{\pi} \int_0^\pi (Q(x))^2 dx,$$

we have for  $m \rightarrow \infty$

$$28.29.20 \quad \mu_{2m-1} - (2m-1)^2 - \frac{N}{(4m)^2} = o(m^{-2}),$$

$$\mu_{2m} - (2m-1)^2 - \frac{N}{(4m)^2} = o(m^{-2}),$$

$$28.29.21 \quad \lambda_{2m-1} - (2m)^2 - \frac{N}{(4m)^2} = o(m^{-2}),$$

$$\lambda_{2m} - (2m)^2 - \frac{N}{(4m)^2} = o(m^{-2}).$$

If  $Q(x)$  has  $k$  continuous derivatives, then as  $m \rightarrow \infty$

$$28.29.22 \quad \lambda_{2m} - \lambda_{2m-1} = o(1/m^k),$$

$$\mu_{2m} - \mu_{2m-1} = o(1/m^k);$$

see Hochstadt (1963).

For further results, especially when  $Q(z)$  is analytic in a strip, see Weinstein and Keller (1987).

### 28.30 Expansions in Series of Eigenfunctions

#### 28.30(i) Real Variable

Let  $\widehat{\lambda}_m, m = 0, 1, 2, \dots$ , be the set of characteristic values (28.29.16) and (28.29.17), arranged in their natural order (see (28.29.18)), and let  $w_m(x), m = 0, 1, 2, \dots$ , be the *eigenfunctions*, that is, an orthonormal set of  $2\pi$ -periodic solutions; thus

$$28.30.1 \quad w''_m + (\widehat{\lambda}_m + Q(x))w_m = 0,$$

$$28.30.2 \quad \frac{1}{2\pi} \int_0^{2\pi} w_m(x)w_n(x) dx = \delta_{m,n}.$$

Then every continuous  $2\pi$ -periodic function  $f(x)$  whose second derivative is square-integrable over the interval  $[0, 2\pi]$  can be expanded in a uniformly and absolutely convergent series

$$28.30.3 \quad f(x) = \sum_{m=0}^{\infty} f_m w_m(x),$$

where

$$28.30.4 \quad f_m = \frac{1}{2\pi} \int_0^{2\pi} f(x)w_m(x) dx.$$

#### 28.30(ii) Complex Variable

For analogous results to those of §28.19, see Schäpfke (1960, 1961b), and Meixner *et al.* (1980, §1.1.11).

### 28.31 Equations of Whittaker–Hill and Ince

#### 28.31(i) Whittaker–Hill Equation

Hill's equation with three terms

28.31.1  $W'' + (A + B \cos(2z) - \frac{1}{2}(kc)^2 \cos(4z)) W = 0$  and constant values of  $A, B, k$ , and  $c$ , is called the *Equation of Whittaker–Hill*. It has been discussed in detail by Arscott (1967) for  $k^2 < 0$ , and by Urwin and Arscott (1970) for  $k^2 > 0$ .

#### 28.31(ii) Equation of Ince; Ince Polynomials

When  $k^2 < 0$ , we substitute

$$28.31.2 \quad \xi^2 = -4k^2c^2, \quad A = \eta - \frac{1}{8}\xi^2, \quad B = -(p+1)\xi, \\ W(z) = w(z) \exp(-\frac{1}{4}\xi \cos(2z)),$$

in (28.31.1). The result is the *Equation of Ince*:

$$28.31.3 \quad w'' + \xi \sin(2z)w' + (\eta - p\xi \cos(2z))w = 0.$$

Formal  $2\pi$ -periodic solutions can be constructed as Fourier series; compare §28.4:

$$28.31.4 \quad w_{e,s}(z) = \sum_{\ell=0}^{\infty} A_{2\ell+s} \cos(2\ell+s)z, \quad s = 0, 1,$$

$$28.31.5 \quad w_{o,s}(z) = \sum_{\ell=0}^{\infty} B_{2\ell+s} \sin(2\ell+s)z, \quad s = 1, 2,$$

where the coefficients satisfy

$$28.31.6 \quad -2\eta A_0 + (2+p)\xi A_2 = 0, \quad p\xi A_0 + (4-\eta)A_2 + (\frac{1}{2}p+2)\xi A_4 = 0, \\ (\frac{1}{2}p-\ell+1)\xi A_{2\ell-2} + (4\ell^2-\eta)A_{2\ell} + (\frac{1}{2}p+\ell+1)\xi A_{2\ell+2} = 0, \quad \ell \geq 2,$$

$$28.31.7 \quad (1-\eta + (\frac{1}{2}p + \frac{1}{2})\xi)A_1 + (\frac{1}{2}p + \frac{3}{2})\xi A_3 = 0, \\ (\frac{1}{2}p-\ell + \frac{1}{2})\xi A_{2\ell-1} + ((2\ell+1)^2-\eta)A_{2\ell+1} + (\frac{1}{2}p+\ell + \frac{3}{2})\xi A_{2\ell+3} = 0, \quad \ell \geq 1,$$

$$28.31.8 \quad (1-\eta - (\frac{1}{2}p + \frac{1}{2})\xi)B_1 + (\frac{1}{2}p + \frac{3}{2})\xi B_3 = 0, \\ (\frac{1}{2}p-\ell + \frac{1}{2})\xi B_{2\ell-1} + ((2\ell+1)^2-\eta)B_{2\ell+1} + (\frac{1}{2}p+\ell + \frac{3}{2})\xi B_{2\ell+3} = 0, \quad \ell \geq 1,$$

$$28.31.9 \quad (4-\eta)B_2 + (\frac{1}{2}p+2)\xi B_4 = 0, \\ (\frac{1}{2}p-\ell+1)\xi B_{2\ell-2} + (4\ell^2-\eta)B_{2\ell} + (\frac{1}{2}p+\ell+1)\xi B_{2\ell+2} = 0, \quad \ell \geq 2.$$

When  $p$  is a nonnegative integer, the parameter  $\eta$  can be chosen so that solutions of (28.31.3) are trigonometric polynomials, called *Ince polynomials*. They are denoted by

$$28.31.10 \quad C_{2n}^{2m}(z, \xi) \quad \text{with } p = 2n, \\ C_{2n+1}^{2m+1}(z, \xi) \quad \text{with } p = 2n + 1,$$

$$28.31.11 \quad S_{2n+1}^{2m+1}(z, \xi) \quad \text{with } p = 2n + 1, \\ S_{2n+2}^{2m+2}(z, \xi) \quad \text{with } p = 2n + 2,$$

and  $m = 0, 1, \dots, n$  in all cases.

The values of  $\eta$  corresponding to  $C_p^m(z, \xi), S_p^m(z, \xi)$  are denoted by  $a_p^m(\xi), b_p^m(\xi)$ , respectively. They are real and distinct, and can be ordered so that  $C_p^m(z, \xi)$  and  $S_p^m(z, \xi)$  have precisely  $m$  zeros, all simple, in  $0 \leq z < \pi$ . The normalization is given by

$$28.31.12 \quad \frac{1}{\pi} \int_0^{2\pi} (C_p^m(x, \xi))^2 dx = \frac{1}{\pi} \int_0^{2\pi} (S_p^m(x, \xi))^2 dx = 1,$$

ambiguities in sign being resolved by requiring  $C_p^m(x, \xi)$  and  $S_p^m(x, \xi)$  to be continuous functions of  $x$  and positive when  $x = 0$ .

For  $\xi \rightarrow 0$ , with  $x$  fixed,

**28.31.13**

$$C_p^0(x, \xi) \rightarrow 1/\sqrt{2}, \quad C_p^m(x, \xi) \rightarrow \cos(mx), \\ S_p^m(x, \xi) \rightarrow \sin(mx), \quad m \neq 0; \quad a_p^m(\xi), b_p^m(\xi) \rightarrow m^2.$$

If  $p \rightarrow \infty$  and  $\xi \rightarrow 0$  in such a way that  $p\xi \rightarrow 2q$ , then in the notation of §§28.2(v) and 28.2(vi)

**28.31.14**  $C_p^m(x, \xi) \rightarrow ce_m(x, q), \quad S_p^m(x, \xi) \rightarrow se_m(x, q),$

**28.31.15**  $a_p^m(\xi) \rightarrow a_m(q), \quad b_p^m(\xi) \rightarrow b_m(q).$

For proofs and further information, including convergence of the series (28.31.4), (28.31.5), see Arscott (1967).

**28.31(iii) Paraboloidal Wave Functions**

With (28.31.10) and (28.31.11),

**28.31.16**  $hc_p^m(z, \xi) = e^{-\frac{1}{4}\xi \cos(2z)} C_p^m(z, \xi),$

**28.31.17**  $hs_p^m(z, \xi) = e^{-\frac{1}{4}\xi \cos(2z)} S_p^m(z, \xi),$

are called *paraboloidal wave functions*. They satisfy the differential equation

**28.31.18**

$$w'' + \left(\eta - \frac{1}{8}\xi^2 - (p+1)\xi \cos(2z) + \frac{1}{8}\xi^2 \cos(4z)\right) w = 0,$$

with  $\eta = a_p^m(\xi)$ ,  $\eta = b_p^m(\xi)$ , respectively.

For change of sign of  $\xi$ ,

**28.31.19**

$$hc_{2n}^{2m}(z, -\xi) = (-1)^m hc_{2n}^{2m}(\frac{1}{2}\pi - z, \xi), \\ hc_{2n+1}^{2m+1}(z, -\xi) = (-1)^m hs_{2n+1}^{2m+1}(\frac{1}{2}\pi - z, \xi),$$

and

**28.31.20**

$$hs_{2n+1}^{2m+1}(z, -\xi) = (-1)^m hc_{2n+1}^{2m+1}(\frac{1}{2}\pi - z, \xi), \\ hs_{2n+2}^{2m+2}(z, -\xi) = (-1)^m hs_{2n+2}^{2m+2}(\frac{1}{2}\pi - z, \xi).$$

For  $m_1 \neq m_2$ ,

**28.31.21** 
$$\int_0^{2\pi} hc_p^{m_1}(x, \xi) hc_p^{m_2}(x, \xi) dx \\ = \int_0^{2\pi} hs_p^{m_1}(x, \xi) hs_p^{m_2}(x, \xi) dx = 0.$$

More important are the *double orthogonality relations* for  $p_1 \neq p_2$  or  $m_1 \neq m_2$  or both, given by

**28.31.22**

$$\int_{u_0}^{u_\infty} \int_0^{2\pi} hc_{p_1}^{m_1}(u, \xi) hc_{p_1}^{m_1}(v, \xi) hc_{p_2}^{m_2}(u, \xi) hc_{p_2}^{m_2}(v, \xi) \\ \times (\cos(2u) - \cos(2v)) dv du = 0,$$

and

**28.31.23**

$$\int_{u_0}^{u_\infty} \int_0^{2\pi} hs_{p_1}^{m_1}(u, \xi) hs_{p_1}^{m_1}(v, \xi) hs_{p_2}^{m_2}(u, \xi) hs_{p_2}^{m_2}(v, \xi) \\ \times (\cos(2u) - \cos(2v)) dv du = 0,$$

and also for all  $p_1, p_2, m_1, m_2$ , given by

**28.31.24**

$$\int_{u_0}^{u_\infty} \int_0^{2\pi} hc_{p_1}^{m_1}(u, \xi) hc_{p_1}^{m_1}(v, \xi) hs_{p_2}^{m_2}(u, \xi) hs_{p_2}^{m_2}(v, \xi) \\ \times (\cos(2u) - \cos(2v)) dv du = 0,$$

where  $(u_0, u_\infty) = (0, i\infty)$  when  $\xi > 0$ , and  $(u_0, u_\infty) = (\frac{1}{2}\pi, \frac{1}{2}\pi + i\infty)$  when  $\xi < 0$ .

For proofs and further integral equations see Urwin (1964, 1965).

**Asymptotic Behavior**

For  $\xi > 0$ , the functions  $hc_p^m(z, \xi)$ ,  $hs_p^m(z, \xi)$  behave asymptotically as multiples of  $\exp(-\frac{1}{4}\xi \cos(2z)) (\cos z)^p$  as  $z \rightarrow \pm i\infty$ . All other periodic solutions behave as multiples of  $\exp(\frac{1}{4}\xi \cos(2z)) (\cos z)^{-p-2}$ .

For  $\xi < 0$ , the functions  $hc_p^m(z, -\xi)$ ,  $hs_p^m(z, -\xi)$  behave asymptotically as multiples of  $\exp(\frac{1}{4}\xi \cos(2z)) (\cos z)^{-p-2}$  as  $z \rightarrow \frac{1}{2}\pi \pm i\infty$ . All other periodic solutions behave as multiples of  $\exp(-\frac{1}{4}\xi \cos(2z)) (\cos z)^p$ .

**Applications**

**28.32 Mathematical Applications**

**28.32(i) Elliptical Coordinates and an Integral Relationship**

If the boundary conditions in a physical problem relate to the perimeter of an ellipse, then elliptical coordinates are convenient. These are given by

**28.32.1**  $x = c \cosh \xi \cos \eta, \quad y = c \sinh \xi \sin \eta.$

The two-dimensional wave equation

**28.32.2** 
$$\frac{\partial^2 V}{\partial x^2} + \frac{\partial^2 V}{\partial y^2} + k^2 V = 0$$

then becomes

**28.32.3** 
$$\frac{\partial^2 V}{\partial \xi^2} + \frac{\partial^2 V}{\partial \eta^2} + \frac{1}{2}c^2 k^2 (\cosh(2\xi) - \cos(2\eta)) V = 0.$$

The separated solutions  $V(\xi, \eta) = v(\xi)w(\eta)$  can be obtained from the modified Mathieu's equation (28.20.1) for  $v$  and from Mathieu's equation (28.2.1) for  $w$ , where  $a$  is the separation constant and  $q = \frac{1}{4}c^2 k^2$ .

This leads to integral equations and an integral relation between the solutions of Mathieu's equation (setting  $\zeta = i\xi$ ,  $z = \eta$  in (28.32.3)).

Let  $u(\zeta)$  be a solution of Mathieu's equation (28.2.1) and  $K(z, \zeta)$  be a solution of

$$28.32.4 \quad \frac{\partial^2 K}{\partial z^2} - \frac{\partial^2 K}{\partial \zeta^2} = 2q(\cos(2z) - \cos(2\zeta))K.$$

Also let  $\mathcal{L}$  be a curve (possibly improper) such that the quantity

$$28.32.5 \quad K(z, \zeta) \frac{du(\zeta)}{d\zeta} - u(\zeta) \frac{\partial K(z, \zeta)}{\partial \zeta}$$

approaches the same value when  $\zeta$  tends to the endpoints of  $\mathcal{L}$ . Then

$$28.32.6 \quad w(z) = \int_{\mathcal{L}} K(z, \zeta) u(\zeta) d\zeta$$

defines a solution of Mathieu's equation, provided that (in the case of an improper curve) the integral converges with respect to  $z$  uniformly on compact subsets of  $\mathbb{C}$ .

Kernels  $K$  can be found, for example, by separating solutions of the wave equation in other systems of orthogonal coordinates. See Schmidt and Wolf (1979).

### 28.32(ii) Paraboloidal Coordinates

The general paraboloidal coordinate system is linked with Cartesian coordinates via

$$28.32.7 \quad \begin{aligned} x_1 &= \frac{1}{2}c(\cosh(2\alpha) + \cos(2\beta) - \cosh(2\gamma)), \\ x_2 &= 2c \cosh \alpha \cos \beta \sinh \gamma, \quad x_3 = 2c \sinh \alpha \sin \beta \cosh \gamma, \end{aligned}$$

where  $c$  is a parameter,  $0 \leq \alpha < \infty$ ,  $-\pi < \beta \leq \pi$ , and  $0 \leq \gamma < \infty$ . When the Helmholtz equation

$$28.32.8 \quad \nabla^2 V + k^2 V = 0$$

is separated in this system, each of the separated equations can be reduced to the Whittaker–Hill equation (28.31.1), in which  $A, B$  are *separation constants*. Two conditions are used to determine  $A, B$ . The first is the  $2\pi$ -periodicity of the solutions; the second can be their asymptotic form. For further information see Arscott (1967) for  $k^2 < 0$ , and Urwin and Arscott (1970) for  $k^2 > 0$ .

## 28.33 Physical Applications

### 28.33(i) Introduction

Mathieu functions occur in practical applications in two main categories:

- Boundary-values problems arising from solution of the two-dimensional wave equation in elliptical coordinates. This yields a pair of equations of the form (28.2.1) and (28.20.1), and the appropriate solution of (28.2.1) is usually a periodic solution of integer order. See §28.33(ii).
- Initial-value problems, in which only one equation (28.2.1) or (28.20.1) is involved. See §28.33(iii).

### 28.33(ii) Boundary-Value Problems

Physical problems involving Mathieu functions include vibrational problems in elliptical coordinates; see (28.32.1). We shall derive solutions to the uniform, homogeneous, loss-free, and stretched elliptical ring membrane with mass  $\rho$  per unit area, and radial tension  $\tau$  per unit arc length. The wave equation

$$28.33.1 \quad \frac{\partial^2 W}{\partial x^2} + \frac{\partial^2 W}{\partial y^2} - \frac{\rho}{\tau} \frac{\partial^2 W}{\partial t^2} = 0,$$

with  $W(x, y, t) = e^{i\omega t}V(x, y)$ , reduces to (28.32.2) with  $k^2 = \omega^2\rho/\tau$ . In elliptical coordinates (28.32.2) becomes (28.32.3). The separated solutions  $V_n(\xi, \eta)$  must be  $2\pi$ -periodic in  $\eta$ , and have the form

$$28.33.2 \quad V_n(\xi, \eta) = \left( c_n M_n^{(1)}(\xi, \sqrt{q}) + d_n M_n^{(2)}(\xi, \sqrt{q}) \right) m e_n(\eta, q),$$

where  $q = \frac{1}{4}c^2k^2$  and  $a_n(q)$  or  $b_n(q)$  is the separation constant; compare (28.12.11), (28.20.11), and (28.20.12). Here  $c_n$  and  $d_n$  are constants. The boundary conditions for  $\xi = \xi_0$  (outer clamp) and  $\xi = \xi_1$  (inner clamp) yield the following equation for  $q$ :

$$28.33.3 \quad \begin{aligned} &M_n^{(1)}(\xi_0, \sqrt{q}) M_n^{(2)}(\xi_1, \sqrt{q}) \\ &- M_n^{(1)}(\xi_1, \sqrt{q}) M_n^{(2)}(\xi_0, \sqrt{q}) = 0. \end{aligned}$$

If we denote the positive solutions  $q$  of (28.33.3) by  $q_{n,m}$ , then the vibration of the membrane is given by  $\omega_{n,m}^2 = 4q_{n,m}\tau/(c^2\rho)$ . The general solution of the problem is a superposition of the separated solutions.

For a visualization see Gutiérrez-Vega *et al.* (2003), and for references to other boundary-value problems see:

- McLachlan (1947, Chapters XVI–XIX) for applications of the wave equation to vibrational systems, electrical and thermal diffusion, electromagnetic wave guides, elliptical cylinders in viscous fluids, and diffraction of sound and electromagnetic waves.
- Meixner and Schäfke (1954, §§4.3, 4.4) for elliptic membranes and electromagnetic waves.
- Daymond (1955) for vibrating systems.
- Troesch and Troesch (1973) for elliptic membranes.
- Alhargan and Judah (1995), Bhattacharyya and Shafai (1988), and Shen (1981) for ring antennas.
- Alhargan and Judah (1992), Germey (1964), Ragheb *et al.* (1991), and Sips (1967) for electromagnetic waves.

More complete bibliographies will be found in McLachlan (1947) and Meixner and Schäfke (1954).

### 28.33(iii) Stability and Initial-Value Problems

If the parameters of a physical system vary periodically with time, then the question of stability arises, for example, a mathematical pendulum whose length varies as  $\cos(2\omega t)$ . The equation of motion is given by

$$28.33.4 \quad w''(t) + (b - f \cos(2\omega t)) w(t) = 0,$$

with  $b$ ,  $f$ , and  $\omega$  positive constants. Substituting  $z = \omega t$ ,  $a = b/\omega^2$ , and  $2q = f/\omega^2$ , we obtain Mathieu's standard form (28.2.1).

As  $\omega$  runs from 0 to  $+\infty$ , with  $b$  and  $f$  fixed, the point  $(q, a)$  moves from  $\infty$  to 0 along the ray  $\mathcal{L}$  given by the part of the line  $a = (2b/f)q$  that lies in the first quadrant of the  $(q, a)$ -plane. Hence from §28.17 the corresponding Mathieu equation is stable or unstable according as  $(q, a)$  is in the intersection of  $\mathcal{L}$  with the colored or the uncolored open regions depicted in Figure 28.17.1. In particular, the equation is stable for all sufficiently large values of  $\omega$ .

For points  $(q, a)$  that are at intersections of  $\mathcal{L}$  with the characteristic curves  $a = a_n(q)$  or  $a = b_n(q)$ , a periodic solution is possible. However, in response to a small perturbation at least one solution may become unbounded.

References for other initial-value problems include:

- McLachlan (1947, Chapter XV) for amplitude distortion in moving-coil loud-speakers, frequency modulation, dynamical systems, and vibration of stretched strings.
- Vedeler (1950) for ships rolling among waves.
- Meixner and Schäfer (1954, §§4.1, 4.2, and 4.7) for quantum mechanical problems and rotation of molecules.
- Aly *et al.* (1975) for scattering theory.
- Hunter and Kuriyan (1976) and Rushchitsky and Rushchitska (2000) for wave mechanics.
- Fukui and Horiguchi (1992) for quantum theory.
- Jager (1997, 1998) for relativistic oscillators.
- Torres-Vega *et al.* (1998) for Mathieu functions in phase space.

## Computation

### 28.34 Methods of Computation

#### 28.34(i) Characteristic Exponents

Methods available for computing the values of  $w_1(\pi; a, \pm q)$  needed in (28.2.16) include:

- (a) Direct numerical integration of the differential equation (28.2.1), with initial values given by (28.2.5) (§§3.7(ii), 3.7(v)).
- (b) Representations for  $w_1(\pi; a, \pm q)$  with limit formulas for special solutions of the recurrence relations §28.4(ii) for fixed  $a$  and  $q$ ; see Schäfer (1961a).

#### 28.34(ii) Eigenvalues

Methods for computing the eigenvalues  $a_n(q)$ ,  $b_n(q)$ , and  $\lambda_\nu(q)$ , defined in §§28.2(v) and 28.12(i), include:

- (a) Summation of the power series in §§28.6(i) and 28.15(i) when  $|q|$  is small.
- (b) Use of asymptotic expansions and approximations for large  $q$  (§§28.8(i), 28.16). See also Zhang and Jin (1996, pp. 482–485).
- (c) Methods described in §3.7(iv) applied to the differential equation (28.2.1) with the conditions (28.2.5) and (28.2.16).
- (d) Solution of the matrix eigenvalue problem for each of the five infinite matrices that correspond to the linear algebraic equations (28.4.5)–(28.4.8) and (28.14.4). See Zhang and Jin (1996, pp. 479–482) and §3.2(iv).
- (e) Solution of the continued-fraction equations (28.6.16)–(28.6.19) and (28.15.2) by successive approximation. See Blanch (1966), Shirts (1993), and Meixner and Schäfer (1954, §2.87).

#### 28.34(iii) Floquet Solutions

- (a) Summation of the power series in §§28.6(ii) and 28.15(ii) when  $|q|$  is small.
- (b) Use of asymptotic expansions and approximations for large  $q$  (§§28.8(ii)–28.8(iv)).

Also, once the eigenvalues  $a_n(q)$ ,  $b_n(q)$ , and  $\lambda_\nu(q)$  have been computed the following methods are applicable:



- (c) Solution of (28.2.1) by boundary-value methods; see §3.7(iii). This can be combined with §28.34(ii)(c).
- (d) Solution of the systems of linear algebraic equations (28.4.5)–(28.4.8) and (28.14.4), with the conditions (28.4.9)–(28.4.12) and (28.14.5), by boundary-value methods (§3.6) to determine the Fourier coefficients. Subsequently, the Fourier series can be summed with the aid of Clenshaw's algorithm (§3.11(ii)). See Meixner and Schäfke (1954, §2.87). This procedure can be combined with §28.34(ii)(d).

### 28.34(iv) Modified Mathieu Functions

For the modified functions we have:

- (a) Numerical summation of the expansions in series of Bessel functions (28.24.1)–(28.24.13). These series converge quite rapidly for a wide range of values of  $q$  and  $z$ .
- (b) Direct numerical integration (§3.7) of the differential equation (28.20.1) for moderate values of the parameters.
- (c) Use of asymptotic expansions for large  $z$  or large  $q$ . See §§28.25 and 28.26.

## 28.35 Tables

### 28.35(i) Real Variables

- Blanch and Clemm (1962) includes values of  $\text{Mc}_n^{(1)}(x, \sqrt{q})$  and  $\text{Mc}_n^{(1)'}(x, \sqrt{q})$  for  $n = 0(1)15$  with  $q = 0(.05)1$ ,  $x = 0(.02)1$ . Also  $\text{Ms}_n^{(1)}(x, \sqrt{q})$  and  $\text{Ms}_n^{(1)'}(x, \sqrt{q})$  for  $n = 1(1)15$  with  $q = 0(.05)1$ ,  $x = 0(.02)1$ . Precision is generally 7D.
- Blanch and Clemm (1965) includes values of  $\text{Mc}_n^{(2)}(x, \sqrt{q})$ ,  $\text{Mc}_n^{(2)'}(x, \sqrt{q})$  for  $n = 0(1)7$ ,  $x = 0(.02)1$ ;  $n = 8(1)15$ ,  $x = 0(.01)1$ . Also  $\text{Ms}_n^{(2)}(x, \sqrt{q})$ ,  $\text{Ms}_n^{(2)'}(x, \sqrt{q})$  for  $n = 1(1)7$ ,  $x = 0(.02)1$ ;  $n = 8(1)15$ ,  $x = 0(.01)1$ . In all cases  $q = 0(.05)1$ . Precision is generally 7D. Approximate formulas and graphs are also included.
- Blanch and Rhodes (1955) includes  $Be_n(t)$ ,  $Bo_n(t)$ ,  $t = \frac{1}{2}\sqrt{q}$ ,  $n = 0(1)15$ ; 8D. The range of  $t$  is 0 to 0.1, with step sizes ranging from 0.002 down to 0.00025. Notation:  $Be_n(t) = a_n(q) + 2q - (4n + 2)\sqrt{q}$ ,  $Bo_n(t) = b_n(q) + 2q - (4n - 2)\sqrt{q}$ .

- Ince (1932) includes eigenvalues  $a_n$ ,  $b_n$ , and Fourier coefficients for  $n = 0$  or  $1(1)6$ ,  $q = 0(1)10(2)20(4)40$ ; 7D. Also  $ce_n(x, q)$ ,  $se_n(x, q)$  for  $q = 0(1)10$ ,  $x = 1(1)90$ , corresponding to the eigenvalues in the tables; 5D. Notation:  $a_n = be_n - 2q$ ,  $b_n = bo_n - 2q$ .
- Kirkpatrick (1960) contains tables of the modified functions  $Ce_n(x, q)$ ,  $Se_{n+1}(x, q)$  for  $n = 0(1)5$ ,  $q = 1(1)20$ ,  $x = 0.1(1)1$ ; 4D or 5D.
- NBS (1967) includes the eigenvalues  $a_n(q)$ ,  $b_n(q)$  for  $n = 0(1)3$  with  $q = 0(.2)20(.5)37(1)100$ , and  $n = 4(1)15$  with  $q = 0(2)100$ ; Fourier coefficients for  $ce_n(x, q)$  and  $se_n(x, q)$  for  $n = 0(1)15$ ,  $n = 1(1)15$ , respectively, and various values of  $q$  in the interval  $[0, 100]$ ; joining factors  $g_{e,n}(\sqrt{q})$ ,  $f_{e,n}(\sqrt{q})$  for  $n = 0(1)15$  with  $q = 0(.5 \text{ to } 10)100$  (but in a different notation). Also, eigenvalues for large values of  $q$ . Precision is generally 8D.
- Stratton *et al.* (1941) includes  $b_n$ ,  $b'_n$ , and the corresponding Fourier coefficients for  $Se_n(c, x)$  and  $So_n(c, x)$  for  $n = 0$  or  $1(1)4$ ,  $c = 0(.1 \text{ or } .2)4.5$ . Precision is mostly 5S. Notation:  $c = 2\sqrt{q}$ ,  $b_n = a_n + 2q$ ,  $b'_n = b_n + 2q$ , and for  $Se_n(c, x)$ ,  $So_n(c, x)$  see §28.1.
- Zhang and Jin (1996, pp. 521–532) includes the eigenvalues  $a_n(q)$ ,  $b_{n+1}(q)$  for  $n = 0(1)4$ ,  $q = 0(1)50$ ;  $n = 0(1)20$  ( $a$ 's) or 19 ( $b$ 's),  $q = 1, 3, 5, 10, 15, 25, 50(50)200$ . Fourier coefficients for  $ce_n(x, 10)$ ,  $se_{n+1}(x, 10)$ ,  $n = 0(1)7$ . Mathieu functions  $ce_n(x, 10)$ ,  $se_{n+1}(x, 10)$ , and their first  $x$ -derivatives for  $n = 0(1)4$ ,  $x = 0(5^\circ)90^\circ$ . Modified Mathieu functions  $\text{Mc}_n^{(j)}(x, \sqrt{10})$ ,  $\text{Ms}_{n+1}^{(j)}(x, \sqrt{10})$ , and their first  $x$ -derivatives for  $n = 0(1)4$ ,  $j = 1, 2$ ,  $x = 0(.2)4$ . Precision is mostly 9S.

### 28.35(ii) Complex Variables

- Blanch and Clemm (1969) includes eigenvalues  $a_n(q)$ ,  $b_n(q)$  for  $q = \rho e^{i\phi}$ ,  $\rho = 0(.5)25$ ,  $\phi = 5^\circ(5^\circ)90^\circ$ ,  $n = 0(1)15$ ; 4D. Also  $a_n(q)$  and  $b_n(q)$  for  $q = i\rho$ ,  $\rho = 0(.5)100$ ,  $n = 0(2)14$  and  $n = 2(2)16$ , respectively; 8D. Double points for  $n = 0(1)15$ ; 8D. Graphs are included.

### 28.35(iii) Zeros

- Blanch and Clemm (1965) includes the first and second zeros of  $\text{Mc}_n^{(2)}(x, \sqrt{q})$ ,  $\text{Mc}_n^{(2)'}(x, \sqrt{q})$  for  $n = 0, 1$ , and  $\text{Ms}_n^{(2)}(x, \sqrt{q})$ ,  $\text{Ms}_n^{(2)'}(x, \sqrt{q})$  for  $n = 1, 2$ , with  $q = 0(.05)1$ ; 7D.

- Ince (1932) includes the first zero for  $ce_n$ ,  $se_n$  for  $n = 2(1)5$  or  $6$ ,  $q = 0(1)10(2)40$ ; 4D. This reference also gives zeros of the first derivatives, together with expansions for small  $q$ .
- Zhang and Jin (1996, pp. 533–535) includes the zeros (in degrees) of  $ce_n(x, 10)$ ,  $se_n(x, 10)$  for  $n = 1(1)10$ , and the first 5 zeros of  $Mc_n^{(j)}(x, \sqrt{10})$ ,  $Ms_n^{(j)}(x, \sqrt{10})$  for  $n = 0$  or  $1(1)8$ ,  $j = 1, 2$ . Precision is mostly 9S.

### 28.35(iv) Further Tables

For other tables prior to 1961 see Fletcher *et al.* (1962, §2.2) and Lebedev and Fedorova (1960, Chapter 11).

### 28.36 Software

See <http://dlmf.nist.gov/28.36>.

## References

### General References

The main references used in writing this chapter are Arscott (1964b), McLachlan (1947), Meixner and Schäfke (1954), and Meixner *et al.* (1980). For §§28.29–28.30 the main source is Magnus and Winkler (1966).

### Sources

The following list gives the references or other indications of proofs that were used in constructing the various sections of this chapter. These sources supplement the references that are quoted in the text.

- §28.2 Arscott (1964b, Chapter II), Erdélyi *et al.* (1955, §§16.2, 16.4), McLachlan (1947, Chapter II), Meixner and Schäfke (1954, §2.1), Meixner *et al.* (1980, Chapter 2). Figure 28.2.1 was produced at NIST.
- §28.3 These graphics were produced at NIST.
- §28.4 Arscott (1964b, Chapter III), McLachlan (1947, Chapter III), Meixner and Schäfke (1954, §§2.25, 2.71), Wolf (2008).
- §28.5 Arscott (1964b, §2.4), McLachlan (1947, Chapter VII), Meixner and Schäfke (1954, §2.7). The graphics were produced at NIST.
- §28.6 McLachlan (1947, Chapter II), Meixner and Schäfke (1954, §2.2), Meixner *et al.* (1980, §2.4), Volkmer (1998).
- §28.7 Meixner and Schäfke (1954, §§2.22, 2.25). Figure 28.7.1 was provided by the author.
- §28.8 Goldstein (1927), Meixner and Schäfke (1954, §§2.33, 2.84).
- §28.10 Arscott (1964b, Chapter IV), Meixner and Schäfke (1954, §2.6), Meixner *et al.* (1980, §2.1.2).
- §28.11 Arscott (1964b, §3.9.1).
- §28.12 Arscott (1964b, Chapter VI), McLachlan (1947, Chapter IV), Meixner and Schäfke (1954, §2.2).
- §28.13 These graphics were produced at NIST.
- §28.14 Arscott (1964b, Chapter VI), McLachlan (1947, Chapter IV), Meixner and Schäfke (1954, §2.2).
- §28.15 Meixner and Schäfke (1954, §2.2).
- §28.16 Meixner and Schäfke (1954, §2.2).
- §28.17 Arscott (1964b, §6.2), McLachlan (1947, Chapter III), Meixner and Schäfke (1954, §2.3). Figure 28.17.1 was recomputed by the author.
- §28.19 Meixner and Schäfke (1954, §2.28).
- §28.20 Arscott (1964b, Chapter VI), Meixner and Schäfke (1954, §2.4).
- §28.21 These graphics were produced at NIST.
- §28.22 Meixner and Schäfke (1954, §§2.29, 2.65, 2.73, 2.76).
- §28.23 Meixner and Schäfke (1954, §2.6).
- §28.24 Meixner and Schäfke (1954, §§2.6, 2.7).
- §28.26 Goldstein (1927), Meixner and Schäfke (1954, §2.84), NBS (1967, IV).
- §28.28 Arscott (1964b, Chapters IV and VI), McLachlan (1947, Chapters IX and XIV), Meixner and Schäfke (1954, §2.7), Meixner *et al.* (1980, §2.1), Schäfke (1983). There is a sign error on p. 158 of the last reference.
- §28.29 Magnus and Winkler (1966, Part I, pp. 1–43), Arscott (1964b, Chapter VII), McLachlan (1947, §6.10).
- §28.30 Magnus and Winkler (1966, Part I, §2.5).
- §28.31 Arscott (1967), Urwin and Arscott (1970), Urwin (1964, 1965).
- §28.32 Arscott (1967, §§1.3 and 2.6), Meixner and Schäfke (1954, §1.135).



## Chapter 29

# Lamé Functions

H. Volkmer<sup>1</sup>

<b>Notation</b>	<b>684</b>	29.13 Graphics . . . . .	691
29.1 Special Notation . . . . .	684	29.14 Orthogonality . . . . .	692
<b>Lamé Functions</b>	<b>684</b>	29.15 Fourier Series and Chebyshev Series . . . . .	692
29.2 Differential Equations . . . . .	684	29.16 Asymptotic Expansions . . . . .	693
29.3 Definitions and Basic Properties . . . . .	685	29.17 Other Solutions . . . . .	693
29.4 Graphics . . . . .	686	<b>Applications</b>	<b>693</b>
29.5 Special Cases and Limiting Forms . . . . .	688	29.18 Mathematical Applications . . . . .	693
29.6 Fourier Series . . . . .	688	29.19 Physical Applications . . . . .	694
29.7 Asymptotic Expansions . . . . .	689	<b>Computation</b>	<b>694</b>
29.8 Integral Equations . . . . .	689	29.20 Methods of Computation . . . . .	694
29.9 Stability . . . . .	690	29.21 Tables . . . . .	694
29.10 Lamé Functions with Imaginary Periods . . . . .	690	29.22 Software . . . . .	695
29.11 Lamé Wave Equation . . . . .	690	<b>References</b>	<b>695</b>
<b>Lamé Polynomials</b>	<b>690</b>		
29.12 Definitions . . . . .	690		

<sup>1</sup>Department of Mathematical Sciences, University of Wisconsin–Milwaukee, Milwaukee, Wisconsin.  
Copyright © 2009 National Institute of Standards and Technology. All rights reserved.

## Notation

### 29.1 Special Notation

(For other notation see pp. xiv and 873.)

- $m, n, p$  nonnegative integers.
- $x$  real variable.
- $z$  complex variable.
- $h, k, \nu$  real parameters,  $0 < k < 1, \nu \geq -\frac{1}{2}$ .
- $k'$   $\sqrt{1 - k^2}, 0 < k' < 1$ .
- $K, K'$  complete elliptic integrals of the first kind with moduli  $k, k'$ , respectively (see §19.2(ii)).

All derivatives are denoted by differentials, not by primes.

The main functions treated in this chapter are the eigenvalues  $a_\nu^{2m}(k^2), a_\nu^{2m+1}(k^2), b_\nu^{2m+1}(k^2), b_\nu^{2m+2}(k^2)$ , the Lamé functions  $Ec_\nu^{2m}(z, k^2), Ec_\nu^{2m+1}(z, k^2), Es_\nu^{2m+1}(z, k^2), Es_\nu^{2m+2}(z, k^2)$ , and the Lamé polynomials  $uE_{2n}^m(z, k^2), sE_{2n+1}^m(z, k^2), cE_{2n+1}^m(z, k^2), dE_{2n+1}^m(z, k^2), scE_{2n+2}^m(z, k^2), sdE_{2n+2}^m(z, k^2), cdE_{2n+2}^m(z, k^2), scdE_{2n+3}^m(z, k^2)$ . The notation for the eigenvalues and functions is due to Erdélyi *et al.* (1955, §15.5.1) and that for the polynomials is due to Arscott (1964b, §9.3.2). The normalization is that of Jansen (1977, §3.1).

Other notations that have been used are as follows: Ince (1940a) interchanges  $a_\nu^{2m+1}(k^2)$  with  $b_\nu^{2m+1}(k^2)$ . The relation to the Lamé functions  $L_{c\nu}^{(m)}, L_{s\nu}^{(m)}$  of Jansen (1977) is given by

$$\begin{aligned} Ec_\nu^{2m}(z, k^2) &= (-1)^m L_{c\nu}^{(2m)}(\psi, k'^2), \\ Ec_\nu^{2m+1}(z, k^2) &= (-1)^m L_{s\nu}^{(2m+1)}(\psi, k'^2), \\ Es_\nu^{2m+1}(z, k^2) &= (-1)^m L_{c\nu}^{(2m+1)}(\psi, k'^2), \\ Es_\nu^{2m+2}(z, k^2) &= (-1)^m L_{s\nu}^{(2m+2)}(\psi, k'^2), \end{aligned}$$

where  $\psi = \text{am}(z, k)$ ; see §22.16(i). The relation to the Lamé functions  $Ec_\nu^m, Es_\nu^m$  of Ince (1940b) is given by

$$\begin{aligned} Ec_\nu^{2m}(z, k^2) &= c_\nu^{2m}(k^2) Ec_\nu^{2m}(z, k^2), \\ Ec_\nu^{2m+1}(z, k^2) &= c_\nu^{2m+1}(k^2) Es_\nu^{2m+1}(z, k^2), \\ Es_\nu^{2m+1}(z, k^2) &= s_\nu^{2m+1}(k^2) Ec_\nu^{2m+1}(z, k^2), \\ Es_\nu^{2m+2}(z, k^2) &= s_\nu^{2m+2}(k^2) Es_\nu^{2m+2}(z, k^2), \end{aligned}$$

where the positive factors  $c_\nu^m(k^2)$  and  $s_\nu^m(k^2)$  are determined by

$$\begin{aligned} (c_\nu^m(k^2))^2 &= \frac{4}{\pi} \int_0^K (Ec_\nu^m(x, k^2))^2 dx, \\ (s_\nu^m(k^2))^2 &= \frac{4}{\pi} \int_0^K (Es_\nu^m(x, k^2))^2 dx. \end{aligned}$$

## Lamé Functions

### 29.2 Differential Equations

#### 29.2(i) Lamé's Equation

$$29.2.1 \quad \frac{d^2w}{dz^2} + (h - \nu(\nu + 1)k^2 \text{sn}^2(z, k))w = 0,$$

where  $k$  and  $\nu$  are real parameters such that  $0 < k < 1$  and  $\nu \geq -\frac{1}{2}$ . For  $\text{sn}(z, k)$  see §22.2. This equation has regular singularities at the points  $2pK + (2q + 1)iK'$ , where  $p, q \in \mathbb{Z}$ , and  $K, K'$  are the complete elliptic integrals of the first kind with moduli  $k, k' (= (1 - k^2)^{1/2})$ , respectively; see §19.2(ii). In general, at each singularity each solution of (29.2.1) has a branch point (§2.7(i)). See Figure 29.2.1.

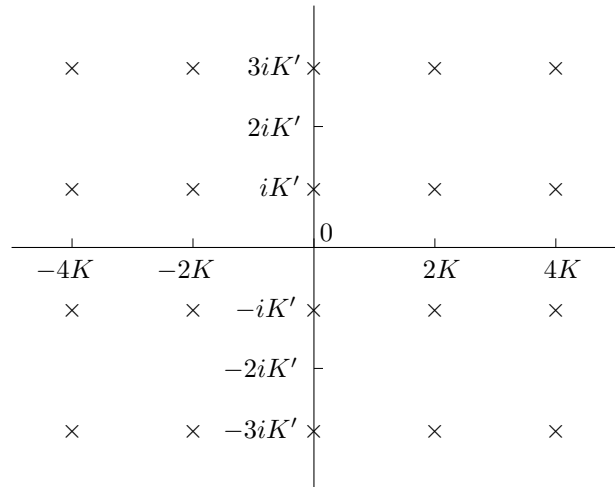


Figure 29.2.1:  $z$ -plane: singularities  $\times \times \times$  of Lamé's equation.

#### 29.2(ii) Other Forms

$$29.2.2 \quad \frac{d^2w}{d\xi^2} + \frac{1}{2} \left( \frac{1}{\xi} + \frac{1}{\xi - 1} + \frac{1}{\xi - k^{-2}} \right) \frac{dw}{d\xi} + \frac{hk^{-2} - \nu(\nu + 1)\xi}{4\xi(\xi - 1)(\xi - k^{-2})} w = 0,$$

where

$$29.2.3 \quad \xi = \text{sn}^2(z, k).$$

$$29.2.4 \quad (1 - k^2 \cos^2 \phi) \frac{d^2w}{d\phi^2} + k^2 \cos \phi \sin \phi \frac{dw}{d\phi} + (h - \nu(\nu + 1)k^2 \cos^2 \phi)w = 0,$$

where

$$29.2.5 \quad \phi = \frac{1}{2}\pi - \text{am}(z, k).$$

For  $\text{am}(z, k)$  see §22.16(i).

Next, let  $e_1, e_2, e_3$  be any real constants that satisfy  $e_1 > e_2 > e_3$  and

**29.2.6**  $e_1 + e_2 + e_3 = 0, \quad (e_2 - e_3)/(e_1 - e_3) = k^2.$   
 (These constants are not unique.) Then with

**29.2.7**  $g = (e_1 - e_3)h + \nu(\nu + 1)e_3,$

**29.2.8**  $\eta = (e_1 - e_3)^{-1/2}(z - iK'),$

we have

**29.2.9**  $\frac{d^2w}{d\eta^2} + (g - \nu(\nu + 1)\wp(\eta))w = 0,$

and

**29.2.10**  $\frac{d^2w}{d\zeta^2} + \frac{1}{2} \left( \frac{1}{\zeta - e_1} + \frac{1}{\zeta - e_2} + \frac{1}{\zeta - e_3} \right) \frac{dw}{d\zeta}$   
 $+ \frac{g - \nu(\nu + 1)\zeta}{4(\zeta - e_1)(\zeta - e_2)(\zeta - e_3)}w = 0,$

where

**29.2.11**  $\zeta = \wp(\eta; g_2, g_3) = \wp(\eta),$

with

**29.2.12**  $g_2 = -4(e_2e_3 + e_3e_1 + e_1e_2), \quad g_3 = 4e_1e_2e_3.$

For the Weierstrass function  $\wp$  see §23.2(ii).

Equation (29.2.10) is a special case of Heun's equation (31.2.1).

### 29.3 Definitions and Basic Properties

#### 29.3(i) Eigenvalues

For each pair of values of  $\nu$  and  $k$  there are four infinite unbounded sets of real eigenvalues  $h$  for which equation (29.2.1) has even or odd solutions with periods  $2K$  or  $4K$ . They are denoted by  $a_\nu^{2m}(k^2), a_\nu^{2m+1}(k^2), b_\nu^{2m+1}(k^2), b_\nu^{2m+2}(k^2)$ , where  $m = 0, 1, 2, \dots$ ; see Table 29.3.1.

Table 29.3.1: Eigenvalues of Lamé's equation.

eigenvalue $h$	parity	period
$a_\nu^{2m}(k^2)$	even	$2K$
$a_\nu^{2m+1}(k^2)$	odd	$4K$
$b_\nu^{2m+1}(k^2)$	even	$4K$
$b_\nu^{2m+2}(k^2)$	odd	$2K$

#### 29.3(ii) Distribution

The eigenvalues interlace according to

**29.3.1**  $a_\nu^m(k^2) < a_\nu^{m+1}(k^2),$

**29.3.2**  $a_\nu^m(k^2) < b_\nu^{m+1}(k^2),$

**29.3.3**  $b_\nu^m(k^2) < b_\nu^{m+1}(k^2),$

**29.3.4**  $b_\nu^m(k^2) < a_\nu^{m+1}(k^2).$

The eigenvalues coalesce according to

**29.3.5**  $a_\nu^m(k^2) = b_\nu^m(k^2), \quad \nu = 0, 1, \dots, m - 1.$

If  $\nu$  is distinct from  $0, 1, \dots, m - 1$ , then

**29.3.6**  $(a_\nu^m(k^2) - b_\nu^m(k^2))\nu(\nu - 1)\cdots(\nu - m + 1) > 0.$

If  $\nu$  is a nonnegative integer, then

**29.3.7**  $a_\nu^m(k^2) + a_\nu^{\nu-m}(1 - k^2) = \nu(\nu + 1), \quad m = 0, 1, \dots, \nu,$

**29.3.8**  $b_\nu^m(k^2) + b_\nu^{\nu-m+1}(1 - k^2) = \nu(\nu + 1), \quad m = 1, 2, \dots, \nu.$

For the special case  $k = k' = 1/\sqrt{2}$  see Erdélyi *et al.* (1955, §15.5.2).

#### 29.3(iii) Continued Fractions

The quantity

**29.3.9**  $H = 2a_\nu^{2m}(k^2) - \nu(\nu + 1)k^2$   
 satisfies the continued-fraction equation

**29.3.10**  $\beta_p - H - \frac{\alpha_{p-1}\gamma_p}{\beta_{p-1} - H -} - \frac{\alpha_{p-2}\gamma_{p-1}}{\beta_{p-2} - H -} \cdots$   
 $= \frac{\alpha_p\gamma_{p+1}}{\beta_{p+1} - H -} - \frac{\alpha_{p+1}\gamma_{p+2}}{\beta_{p+2} - H -} \cdots,$

where  $p$  is any nonnegative integer, and

**29.3.11**  $\alpha_p = \begin{cases} (\nu - 1)(\nu + 2)k^2, & p = 0, \\ \frac{1}{2}(\nu - 2p - 1)(\nu + 2p + 2)k^2, & p \geq 1, \end{cases}$

$\beta_p = 4p^2(2 - k^2),$

**29.3.12**  $\gamma_p = \frac{1}{2}(\nu - 2p + 2)(\nu + 2p - 1)k^2.$

The continued fraction following the second negative sign on the left-hand side of (29.3.10) is finite: it equals 0 if  $p = 0$ , and if  $p > 0$ , then the last denominator is  $\beta_0 - H$ . If  $\nu$  is a nonnegative integer and  $2p \leq \nu$ , then the continued fraction on the right-hand side of (29.3.10) terminates, and (29.3.10) has only the solutions (29.3.9) with  $2m \leq \nu$ . If  $\nu$  is a nonnegative integer and  $2p > \nu$ , then (29.3.10) has only the solutions (29.3.9) with  $2m > \nu$ .

For the corresponding continued-fraction equations for  $a_\nu^{2m+1}(k^2), b_\nu^{2m+1}(k^2)$ , and  $b_\nu^{2m+2}(k^2)$  see <http://dlmf.nist.gov/29.3.iii>.

#### 29.3(iv) Lamé Functions

The eigenfunctions corresponding to the eigenvalues of §29.3(i) are denoted by  $Ec_\nu^{2m}(z, k^2), Ec_\nu^{2m+1}(z, k^2), Es_\nu^{2m+1}(z, k^2), Es_\nu^{2m+2}(z, k^2)$ . They are called *Lamé functions with real periods and of order  $\nu$* , or more simply, *Lamé functions*. See Table 29.3.2. In this table the nonnegative integer  $m$  corresponds to the number of zeros of each Lamé function in  $(0, K)$ , whereas the superscripts  $2m, 2m + 1, \text{ or } 2m + 2$  correspond to the number of zeros in  $[0, 2K)$ .

Table 29.3.2: Lamé functions.

boundary conditions	eigenvalue $h$	eigenfunction $w(z)$	parity of $w(z)$	parity of $w(z - K)$	period of $w(z)$
$dw/dz _{z=0} = dw/dz _{z=K} = 0$	$a_\nu^{2m}(k^2)$	$Ec_\nu^{2m}(z, k^2)$	even	even	$2K$
$w(0) = dw/dz _{z=K} = 0$	$a_\nu^{2m+1}(k^2)$	$Ec_\nu^{2m+1}(z, k^2)$	odd	even	$4K$
$dw/dz _{z=0} = w(K) = 0$	$b_\nu^{2m+1}(k^2)$	$Es_\nu^{2m+1}(z, k^2)$	even	odd	$4K$
$w(0) = w(K) = 0$	$b_\nu^{2m+2}(k^2)$	$Es_\nu^{2m+2}(z, k^2)$	odd	odd	$2K$

**29.3(v) Normalization**

$$\begin{aligned}
 &\int_0^K \operatorname{dn}(x, k) (Ec_\nu^{2m}(x, k^2))^2 dx = \frac{1}{4}\pi, \\
 \text{29.3.18} \quad &\int_0^K \operatorname{dn}(x, k) (Ec_\nu^{2m+1}(x, k^2))^2 dx = \frac{1}{4}\pi, \\
 &\int_0^K \operatorname{dn}(x, k) (Es_\nu^{2m+1}(x, k^2))^2 dx = \frac{1}{4}\pi, \\
 &\int_0^K \operatorname{dn}(x, k) (Es_\nu^{2m+2}(x, k^2))^2 dx = \frac{1}{4}\pi.
 \end{aligned}$$

For  $\operatorname{dn}(z, k)$  see §22.2.

To complete the definitions,  $Ec_\nu^m(K, k^2)$  is positive and  $dEs_\nu^m(z, k^2)/dz|_{z=K}$  is negative.

**29.3(vi) Orthogonality**

For  $m \neq p$ ,

$$\begin{aligned}
 \text{29.3.19} \quad &\int_0^K Ec_\nu^{2m}(x, k^2) Ec_\nu^{2p}(x, k^2) dx = 0, \\
 &\int_0^K Ec_\nu^{2m+1}(x, k^2) Ec_\nu^{2p+1}(x, k^2) dx = 0, \\
 &\int_0^K Es_\nu^{2m+1}(x, k^2) Es_\nu^{2p+1}(x, k^2) dx = 0, \\
 &\int_0^K Es_\nu^{2m+2}(x, k^2) Es_\nu^{2p+2}(x, k^2) dx = 0.
 \end{aligned}$$

For the values of these integrals when  $m = p$  see §29.6.

**29.3(vii) Power Series**

For power-series expansions of the eigenvalues see Volkmer (2004b).

**29.4 Graphics**

**29.4(i) Eigenvalues of Lamé’s Equation: Line Graphs**

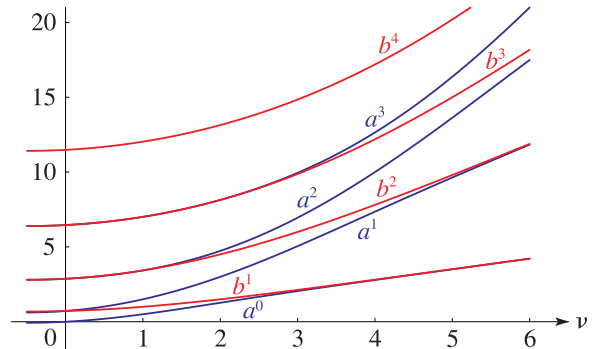


Figure 29.4.1:  $a_\nu^m(0.5)$ ,  $b_\nu^{m+1}(0.5)$  as functions of  $\nu$  for  $m = 0, 1, 2, 3$ .

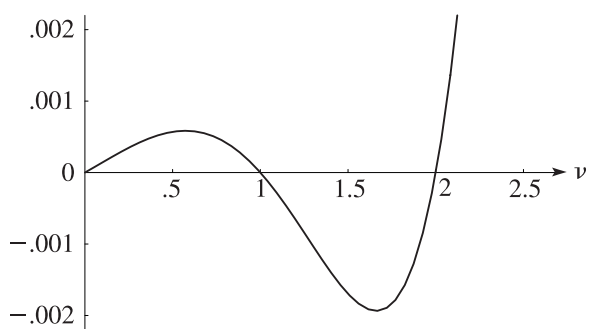


Figure 29.4.2:  $a_\nu^3(0.5) - b_\nu^3(0.5)$  as a function of  $\nu$ .

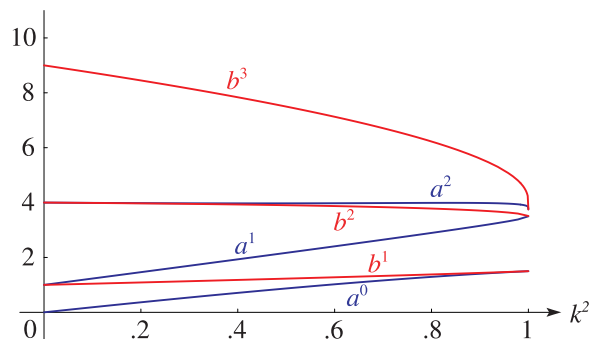


Figure 29.4.3:  $a_{1.5}^m(k^2)$ ,  $b_{1.5}^{m+1}(k^2)$  as functions of  $k^2$  for  $m = 0, 1, 2$ .

For additional graphs see <http://dlmf.nist.gov/29.4.i>.

**29.4(ii) Eigenvalues of Lamé’s Equation: Surfaces**

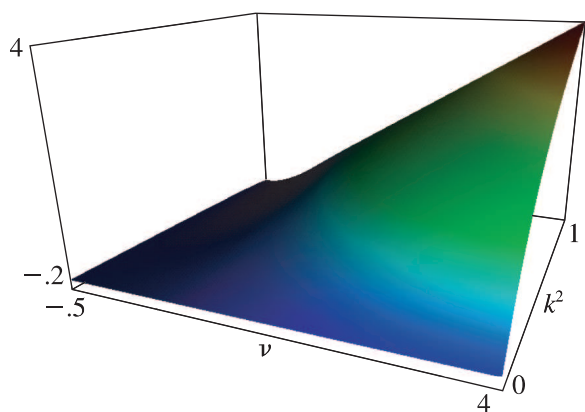


Figure 29.4.9:  $a_\nu^0(k^2)$  as a function of  $\nu$  and  $k^2$ .

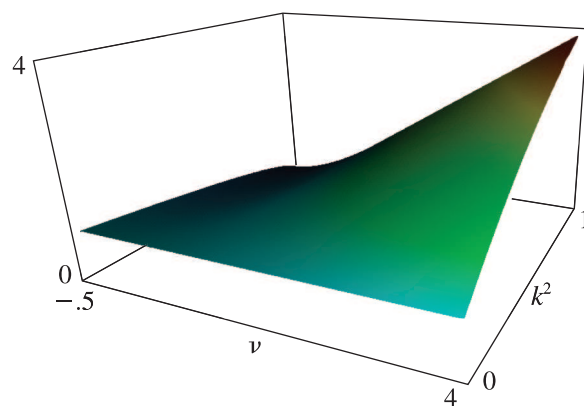


Figure 29.4.10:  $b_\nu^1(k^2)$  as a function of  $\nu$  and  $k^2$ .

For additional surfaces see <http://dlmf.nist.gov/29.4.ii>.

**29.4(iii) Lamé Functions: Line Graphs**

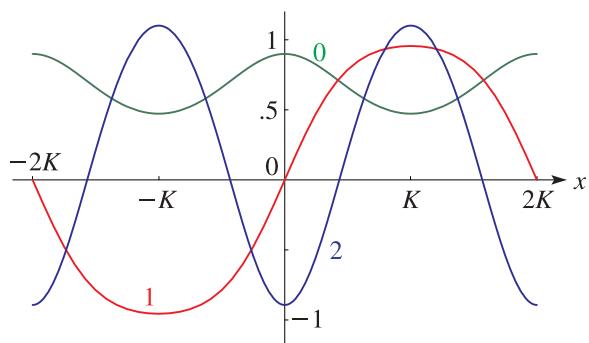


Figure 29.4.13:  $Ec_{1.5}^m(x, 0.5)$  for  $-2K \leq x \leq 2K$ ,  $m = 0, 1, 2$ .  $K = 1.85407\dots$

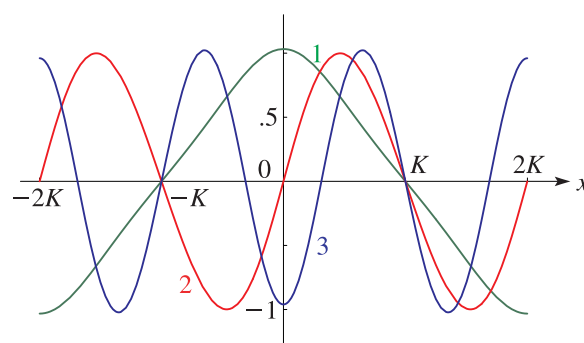


Figure 29.4.14:  $Es_{1.5}^m(x, 0.5)$  for  $-2K \leq x \leq 2K$ ,  $m = 1, 2, 3$ .  $K = 1.85407\dots$

For additional graphs see <http://dlmf.nist.gov/29.4.iii>.



**29.4(iv) Lamé Functions: Surfaces**

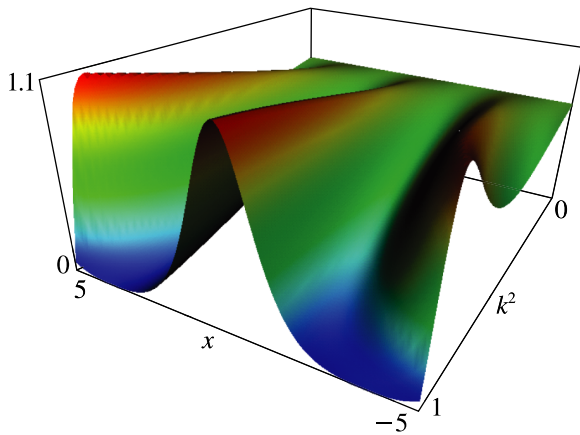


Figure 29.4.25:  $Ec_{1.5}^0(x, k^2)$  as a function of  $x$  and  $k^2$ .

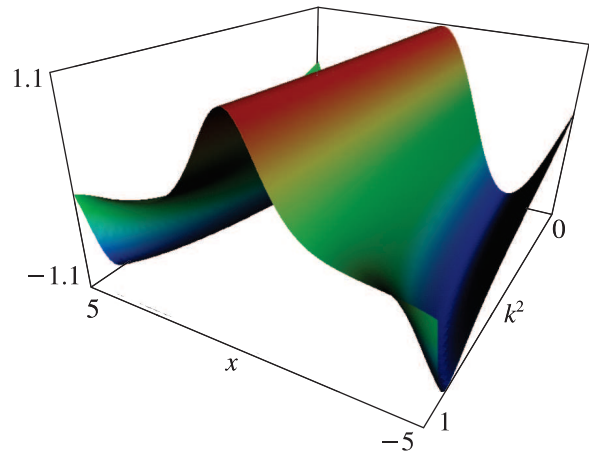


Figure 29.4.26:  $Es_{1.5}^1(x, k^2)$  as a function of  $x$  and  $k^2$ .

For additional surfaces see <http://dlmf.nist.gov/29.4.iv>.

**29.5 Special Cases and Limiting Forms**

**29.5.1**  $a_\nu^m(0) = b_\nu^m(0) = m^2,$

**29.5.2**  $Ec_\nu^0(z, 0) = 2^{-\frac{1}{2}},$

**29.5.3**  $Ec_\nu^m(z, 0) = \cos(m(\frac{1}{2}\pi - z)), \quad m \geq 1,$   
 $Es_\nu^m(z, 0) = \sin(m(\frac{1}{2}\pi - z)), \quad m \geq 1.$

Let  $\mu = \max(\nu - m, 0)$ . Then

**29.5.4**  $\lim_{k \rightarrow 1^-} a_\nu^m(k^2) = \lim_{k \rightarrow 1^-} b_\nu^{m+1}(k^2) = \nu(\nu + 1) - \mu^2,$

**29.5.5**  $\lim_{k \rightarrow 1^-} \frac{Ec_\nu^m(z, k^2)}{Ec_\nu^m(0, k^2)} = \lim_{k \rightarrow 1^-} \frac{Es_\nu^{m+1}(z, k^2)}{Es_\nu^{m+1}(0, k^2)}$   
 $= \frac{1}{(\cosh z)^\mu} F\left(\frac{1}{2}\mu - \frac{1}{2}\nu, \frac{1}{2}\mu + \frac{1}{2}\nu + \frac{1}{2}; \tanh^2 z\right),$   
 $m \text{ even,}$

**29.5.6**  $\lim_{k \rightarrow 1^-} \frac{Ec_\nu^m(z, k^2)}{dEc_\nu^m(z, k^2)/dz|_{z=0}} = \lim_{k \rightarrow 1^-} \frac{Es_\nu^{m+1}(z, k^2)}{dEs_\nu^{m+1}(z, k^2)/dz|_{z=0}}$   
 $= \frac{\tanh z}{(\cosh z)^\mu} F\left(\frac{1}{2}\mu - \frac{1}{2}\nu + \frac{1}{2}, \frac{1}{2}\mu + \frac{1}{2}\nu + 1; \tanh^2 z\right),$   
 $m \text{ odd,}$

where  $F$  is the hypergeometric function; see §15.2(i).

If  $k \rightarrow 0+$  and  $\nu \rightarrow \infty$  in such a way that  $k^2\nu(\nu + 1) = 4\theta$  (a positive constant), then

**29.5.7**  $\lim Ec_\nu^m(z, k^2) = ce_m(\frac{1}{2}\pi - z, \theta),$   
 $\lim Es_\nu^m(z, k^2) = se_m(\frac{1}{2}\pi - z, \theta),$

where  $ce_m(z, \theta)$  and  $se_m(z, \theta)$  are Mathieu functions; see §28.2(vi).

**29.6 Fourier Series**

**29.6(i) Function  $Ec_\nu^{2m}(z, k^2)$**

With  $\phi = \frac{1}{2}\pi - \text{am}(z, k)$ , as in (29.2.5), we have

**29.6.1**  $Ec_\nu^{2m}(z, k^2) = \frac{1}{2}A_0 + \sum_{p=1}^{\infty} A_{2p} \cos(2p\phi).$

Here

**29.6.2**  $H = 2a_\nu^{2m}(k^2) - \nu(\nu + 1)k^2,$

**29.6.3**  $(\beta_0 - H)A_0 + \alpha_0 A_2 = 0,$

**29.6.4**  $\gamma_p A_{2p-2} + (\beta_p - H)A_{2p} + \alpha_p A_{2p+2} = 0, \quad p \geq 1,$   
 with  $\alpha_p, \beta_p,$  and  $\gamma_p$  as in (29.3.11) and (29.3.12), and

**29.6.5**  $\frac{1}{2}A_0^2 + \sum_{p=1}^{\infty} A_{2p}^2 = 1,$

**29.6.6**  $\frac{1}{2}A_0 + \sum_{p=1}^{\infty} A_{2p} > 0.$

When  $\nu \neq 2n$ , where  $n$  is a nonnegative integer, it follows from §2.9(i) that for any value of  $H$  the system (29.6.4)–(29.6.6) has a unique recessive solution  $A_0, A_2, A_4, \dots$ ; furthermore

**29.6.7**

$$\lim_{p \rightarrow \infty} \frac{A_{2p+2}}{A_{2p}} = \frac{k^2}{(1+k')^2}, \quad \nu \neq 2n, \text{ or } \nu = 2n \text{ and } m > n.$$

In addition, if  $H$  satisfies (29.6.2), then (29.6.3) applies.

In the special case  $\nu = 2n, m = 0, 1, \dots, n$ , there is a unique nontrivial solution with the property  $A_{2p} = 0, p = n + 1, n + 2, \dots$ . This solution can be constructed from (29.6.4) by backward recursion, starting with  $A_{2n+2} = 0$  and an arbitrary nonzero value of  $A_{2n}$ , followed by normalization via (29.6.5) and (29.6.6). Consequently,  $Ec_\nu^{2m}(z, k^2)$  reduces to a Lamé polynomial; compare §§29.12(i) and 29.15(i).

An alternative version of the Fourier series expansion (29.6.1) is given by

**29.6.8**

$$Ec_\nu^{2m}(z, k^2) = \operatorname{dn}(z, k) \left( \frac{1}{2}C_0 + \sum_{p=1}^{\infty} C_{2p} \cos(2p\phi) \right).$$

Here  $\operatorname{dn}(z, k)$  is as in §22.2, and

**29.6.9**

$$(\beta_0 - H)C_0 + \alpha_0 C_2 = 0,$$

**29.6.10**

$$\gamma_p C_{2p-2} + (\beta_p - H)C_{2p} + \alpha_p C_{2p+2} = 0, \quad p \geq 1,$$

with  $\alpha_p, \beta_p$ , and  $\gamma_p$  now defined by

$$\begin{aligned} \alpha_p &= \begin{cases} \nu(\nu+1)k^2, & p = 0, \\ \frac{1}{2}(\nu-2p)(\nu+2p+1)k^2, & p \geq 1, \end{cases} \\ \beta_p &= 4p^2(2-k^2), \\ \gamma_p &= \frac{1}{2}(\nu-2p+1)(\nu+2p)k^2, \end{aligned}$$

and

**29.6.12**

$$\left(1 - \frac{1}{2}k^2\right) \left( \frac{1}{2}C_0^2 + \sum_{p=1}^{\infty} C_{2p}^2 \right) - \frac{1}{2}k^2 \sum_{p=0}^{\infty} C_{2p}C_{2p+2} = 1,$$

**29.6.13**

$$\frac{1}{2}C_0 + \sum_{p=1}^{\infty} C_{2p} > 0,$$

**29.6.14**

$$\lim_{p \rightarrow \infty} \frac{C_{2p+2}}{C_{2p}} = \frac{k^2}{(1+k')^2}, \quad \nu \neq 2n+1, \text{ or } \nu = 2n+1 \text{ and } m > n,$$

**29.6.15**

$$\frac{1}{2}A_0C_0 + \sum_{p=1}^{\infty} A_{2p}C_{2p} = \frac{4}{\pi} \int_0^K (Ec_\nu^{2m}(x, k^2))^2 dx.$$

For the corresponding expansions for  $Ec_\nu^{2m+1}(z, k^2), Es_\nu^{2m+1}(z, k^2)$ , and  $Es_\nu^{2m+2}(z, k^2)$  see <http://dlmf.nist.gov/29.6.ii>.

## 29.7 Asymptotic Expansions

### 29.7(i) Eigenvalues

As  $\nu \rightarrow \infty$ ,

$$\mathbf{29.7.1} \quad a_\nu^m(k^2) \sim p\kappa - \tau_0 - \tau_1\kappa^{-1} - \tau_2\kappa^{-2} - \dots,$$

where

$$\mathbf{29.7.2} \quad \kappa = k(\nu(\nu+1))^{1/2}, \quad p = 2m+1,$$

$$\mathbf{29.7.3} \quad \tau_0 = \frac{1}{2^3}(1+k^2)(1+p^2),$$

$$\mathbf{29.7.4} \quad \tau_1 = \frac{p}{2^6}((1+k^2)^2(p^2+3) - 4k^2(p^2+5)).$$

The same Poincaré expansion holds for  $b_\nu^{m+1}(k^2)$ , since

**29.7.5**

$$b_\nu^{m+1}(k^2) - a_\nu^m(k^2) = O\left(\nu^{m+\frac{3}{2}} \left(\frac{1-k}{1+k}\right)^\nu\right), \quad \nu \rightarrow \infty.$$

See also Volkmer (2004b).

For higher terms in (29.7.1) see <http://dlmf.nist.gov/29.7.i>.

### 29.7(ii) Lamé Functions

Müller (1966a,b) found three formal asymptotic expansions for a fundamental system of solutions of (29.2.1) (and (29.11.1)) as  $\nu \rightarrow \infty$ , one in terms of Jacobian elliptic functions and two in terms of Hermite polynomials. In Müller (1966c) it is shown how these expansions lead to asymptotic expansions for the Lamé functions  $Ec_\nu^m(z, k^2)$  and  $Es_\nu^m(z, k^2)$ . Weinstein and Keller (1985) give asymptotics for solutions of Hill's equation (§28.29(i)) that are applicable to the Lamé equation.

## 29.8 Integral Equations

Let  $w(z)$  be any solution of (29.2.1) of period  $4K$ ,  $w_2(z)$  be a linearly independent solution, and  $\mathscr{W}\{w, w_2\}$  denote their Wronskian. Also let  $x$  be defined by

$$\begin{aligned} \mathbf{29.8.1} \quad x &= k^2 \operatorname{sn}(z, k) \operatorname{sn}(z_1, k) \operatorname{sn}(z_2, k) \operatorname{sn}(z_3, k) \\ &\quad - \frac{k^2}{k'^2} \operatorname{cn}(z, k) \operatorname{cn}(z_1, k) \operatorname{cn}(z_2, k) \operatorname{cn}(z_3, k) \\ &\quad + \frac{1}{k'^2} \operatorname{dn}(z, k) \operatorname{dn}(z_1, k) \operatorname{dn}(z_2, k) \operatorname{dn}(z_3, k), \end{aligned}$$

where  $z, z_1, z_2, z_3$  are real, and  $\operatorname{sn}, \operatorname{cn}, \operatorname{dn}$  are the Jacobian elliptic functions (§22.2). Then

$$\mathbf{29.8.2} \quad \mu w(z_1)w(z_2)w(z_3) = \int_{-2K}^{2K} P_\nu(x)w(z) dz,$$

where  $P_\nu(x)$  is the Ferrers function of the first kind (§14.3(i)),

$$\mathbf{29.8.3} \quad \mu = \frac{2\sigma\tau}{\mathscr{W}\{w, w_2\}},$$

and  $\sigma (= \pm 1)$  and  $\tau$  are determined by

**29.8.4** 
$$\begin{aligned} w(z + 2K) &= \sigma w(z), \\ w_2(z + 2K) &= \tau w(z) + \sigma w_2(z). \end{aligned}$$

A special case of (29.8.2) is

**29.8.5** 
$$\begin{aligned} Ec_\nu^{2m}(z_1, k^2) &= \frac{w_2(K) - w_2(-K)}{dw_2(z)/dz|_{z=0}} \\ &= \int_{-K}^K P_\nu(y) Ec_\nu^{2m}(z, k^2) dz, \end{aligned}$$

where

**29.8.6** 
$$y = \frac{1}{k'} \operatorname{dn}(z, k) \operatorname{dn}(z_1, k).$$

For results corresponding to (29.8.5) for  $Ec_\nu^{2m+1}$ ,  $Es_\nu^{2m+1}$ ,  $Es_\nu^{2m+2}$  see <http://dlmf.nist.gov/29.8>.

For further integral equations see Arscott (1964a), Erdélyi *et al.* (1955, §15.5.3), Shail (1980), Sleeman (1968a), and Volkmer (1982, 1983, 1984).

### 29.9 Stability

The Lamé equation (29.2.1) with specified values of  $k, h, \nu$  is called *stable* if all of its solutions are bounded on  $\mathbb{R}$ ; otherwise the equation is called *unstable*. If  $\nu$  is not an integer, then (29.2.1) is unstable iff  $h \leq a_\nu^0(k^2)$  or  $h$  lies in one of the closed intervals with endpoints  $a_\nu^m(k^2)$  and  $b_\nu^m(k^2)$ ,  $m = 1, 2, \dots$ . If  $\nu$  is a nonnegative integer, then (29.2.1) is unstable iff  $h \leq a_\nu^0(k^2)$  or  $h \in [b_\nu^m(k^2), a_\nu^m(k^2)]$  for some  $m = 1, 2, \dots, \nu$ .

### 29.10 Lamé Functions with Imaginary Periods

The substitutions

**29.10.1** 
$$h = \nu(\nu + 1) - h',$$

**29.10.2** 
$$z' = i(z - K - iK'),$$

transform (29.2.1) into

**29.10.3** 
$$\frac{d^2 w}{dz'^2} + (h' - \nu(\nu + 1)k'^2 \operatorname{sn}^2(z', k'))w = 0.$$

In consequence, the functions

**29.10.4** 
$$\begin{aligned} &Ec_\nu^{2m}(i(z - K - iK'), k'^2), \\ &Ec_\nu^{2m+1}(i(z - K - iK'), k'^2), \\ &Es_\nu^{2m+1}(i(z - K - iK'), k'^2), \\ &Es_\nu^{2m+2}(i(z - K - iK'), k'^2), \end{aligned}$$

are solutions of (29.2.1). The first and the fourth functions have period  $2iK'$ ; the second and the third have period  $4iK'$ .

For these results and further information see Erdélyi *et al.* (1955, §15.5.2).

### 29.11 Lamé Wave Equation

The *Lamé* (or *ellipsoidal*) *wave equation* is given by

**29.11.1** 
$$\frac{d^2 w}{dz^2} + (h - \nu(\nu + 1)k^2 \operatorname{sn}^2(z, k) + k^2 \omega^2 \operatorname{sn}^4(z, k))w = 0,$$
 in which  $\omega$  is another parameter. In the case  $\omega = 0$ , (29.11.1) reduces to Lamé's equation (29.2.1).

For properties of the solutions of (29.11.1) see Arscott (1956, 1959), Arscott (1964b, Chapter X), Erdélyi *et al.* (1955, §16.14), Fedoryuk (1989), and Müller (1966a,b,c).

## Lamé Polynomials

### 29.12 Definitions

#### 29.12(i) Elliptic-Function Form

Throughout §§29.12–29.16 the order  $\nu$  in the differential equation (29.2.1) is assumed to be a nonnegative integer.

The Lamé functions  $Ec_\nu^m(z, k^2)$ ,  $m = 0, 1, \dots, \nu$ , and  $Es_\nu^m(z, k^2)$ ,  $m = 1, 2, \dots, \nu$ , are called the *Lamé polynomials*. There are eight types of Lamé polynomials, defined as follows:

- 29.12.1** 
$$uE_{2n}^m(z, k^2) = Ec_{2n}^{2m}(z, k^2),$$
- 29.12.2** 
$$sE_{2n+1}^m(z, k^2) = Ec_{2n+1}^{2m+1}(z, k^2),$$
- 29.12.3** 
$$cE_{2n+1}^m(z, k^2) = Es_{2n+1}^{2m+1}(z, k^2),$$
- 29.12.4** 
$$dE_{2n+1}^m(z, k^2) = Ec_{2n+1}^{2m}(z, k^2),$$
- 29.12.5** 
$$scE_{2n+2}^m(z, k^2) = Es_{2n+2}^{2m+2}(z, k^2),$$
- 29.12.6** 
$$sdE_{2n+2}^m(z, k^2) = Ec_{2n+2}^{2m+1}(z, k^2),$$
- 29.12.7** 
$$cdE_{2n+2}^m(z, k^2) = Es_{2n+2}^{2m+1}(z, k^2),$$
- 29.12.8** 
$$scdE_{2n+3}^m(z, k^2) = Es_{2n+3}^{2m+2}(z, k^2),$$

where  $n = 0, 1, 2, \dots$ ,  $m = 0, 1, 2, \dots, n$ . These functions are polynomials in  $\operatorname{sn}(z, k)$ ,  $\operatorname{cn}(z, k)$ , and  $\operatorname{dn}(z, k)$ . In consequence they are doubly-periodic meromorphic functions of  $z$ .

The superscript  $m$  on the left-hand sides of (29.12.1)–(29.12.8) agrees with the number of  $z$ -zeros of each Lamé polynomial in the interval  $(0, K)$ , while  $n - m$  is the number of  $z$ -zeros in the open line segment from  $K$  to  $K + iK'$ .

The prefixes  $u, s, c, d, sc, sd, cd, scd$  indicate the type of the polynomial form of the Lamé polynomial; compare the 3rd and 4th columns in Table 29.12.1. In the fourth column the variable  $z$  and modulus  $k$  of the Jacobian elliptic functions have been suppressed, and  $P(\operatorname{sn}^2)$  denotes a polynomial of degree  $n$  in  $\operatorname{sn}^2(z, k)$  (different for each type). For the determination of the coefficients of the  $P$ 's see §29.15(ii).

Table 29.12.1: Lamé polynomials.

$\nu$	eigenvalue $h$	eigenfunction $w(z)$	polynomial form	real period	imag. period	parity of $w(z)$	parity of $w(z - K)$	parity of $w(z - K - iK')$
$2n$	$a_\nu^{2m}(k^2)$	$uE_\nu^m(z, k^2)$	$P(\text{sn}^2)$	$2K$	$2iK'$	even	even	even
$2n + 1$	$a_\nu^{2m+1}(k^2)$	$sE_\nu^m(z, k^2)$	$\text{sn } P(\text{sn}^2)$	$4K$	$2iK'$	odd	even	even
$2n + 1$	$b_\nu^{2m+1}(k^2)$	$cE_\nu^m(z, k^2)$	$\text{cn } P(\text{sn}^2)$	$4K$	$4iK'$	even	odd	even
$2n + 1$	$a_\nu^{2m}(k^2)$	$dE_\nu^m(z, k^2)$	$\text{dn } P(\text{sn}^2)$	$2K$	$4iK'$	even	even	odd
$2n + 2$	$b_\nu^{2m+2}(k^2)$	$scE_\nu^m(z, k^2)$	$\text{sn cn } P(\text{sn}^2)$	$2K$	$4iK'$	odd	odd	even
$2n + 2$	$a_\nu^{2m+1}(k^2)$	$sdE_\nu^m(z, k^2)$	$\text{sn dn } P(\text{sn}^2)$	$4K$	$4iK'$	odd	even	odd
$2n + 2$	$b_\nu^{2m+1}(k^2)$	$cdE_\nu^m(z, k^2)$	$\text{cn dn } P(\text{sn}^2)$	$4K$	$2iK'$	even	odd	odd
$2n + 3$	$b_\nu^{2m+2}(k^2)$	$scdE_\nu^m(z, k^2)$	$\text{sn cn dn } P(\text{sn}^2)$	$2K$	$2iK'$	odd	odd	odd

**29.12(ii) Algebraic Form**

With the substitution  $\xi = \text{sn}^2(z, k)$  every Lamé polynomial in Table 29.12.1 can be written in the form

29.12.9  $\xi^\rho(\xi - 1)^\sigma(\xi - k^{-2})^\tau P(\xi),$

where  $\rho, \sigma, \tau$  are either 0 or  $\frac{1}{2}$ . The polynomial  $P(\xi)$  is of degree  $n$  and has  $m$  zeros (all simple) in  $(0, 1)$  and  $n - m$  zeros (all simple) in  $(1, k^{-2})$ . The functions (29.12.9) satisfy (29.2.2).

**29.12(iii) Zeros**

Let  $\xi_1, \xi_2, \dots, \xi_n$  denote the zeros of the polynomial  $P$  in (29.12.9) arranged according to

29.12.10  $0 < \xi_1 < \dots < \xi_m < 1 < \xi_{m+1} < \dots < \xi_n < k^{-2}.$

Then the function

29.12.11  $g(t_1, t_2, \dots, t_n) = \left( \prod_{p=1}^n t_p^{\rho+\frac{1}{4}} |t_p - 1|^{\sigma+\frac{1}{4}} (k^{-2} - t_p)^{\tau+\frac{1}{4}} \right) \prod_{q < r} (t_r - t_q),$

defined for  $(t_1, t_2, \dots, t_n)$  with

29.12.12  $0 \leq t_1 \leq \dots \leq t_m \leq 1 \leq t_{m+1} \leq \dots \leq t_n \leq k^{-2},$  attains its absolute maximum iff  $t_j = \xi_j, j = 1, 2, \dots, n.$  Moreover,

29.12.13  $\frac{\rho + \frac{1}{4}}{\xi_p} + \frac{\sigma + \frac{1}{4}}{\xi_p - 1} + \frac{\tau + \frac{1}{4}}{\xi_p - k^{-2}} + \sum_{\substack{q=1 \\ q \neq p}}^n \frac{1}{\xi_p - \xi_q} = 0,$   
 $p = 1, 2, \dots, n.$

This result admits the following electrostatic interpretation: Given three point masses fixed at  $t = 0,$   $t = 1,$  and  $t = k^{-2}$  with positive charges  $\rho + \frac{1}{4}, \sigma + \frac{1}{4},$

and  $\tau + \frac{1}{4},$  respectively, and  $n$  movable point masses at  $t_1, t_2, \dots, t_n$  arranged according to (29.12.12) with unit positive charges, the equilibrium position is attained when  $t_j = \xi_j$  for  $j = 1, 2, \dots, n.$

**29.13 Graphics**

**29.13(i) Eigenvalues for Lamé Polynomials**

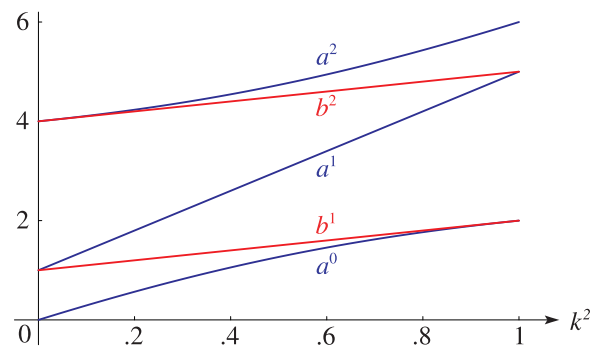


Figure 29.13.1:  $a_2^m(k^2), b_2^m(k^2)$  as functions of  $k^2$  for  $m = 0, 1, 2$  ( $a$ 's),  $m = 1, 2$  ( $b$ 's).

For additional graphs see <http://dlmf.nist.gov/29.13.i>.

**29.13(ii) Lamé Polynomials: Real Variable**

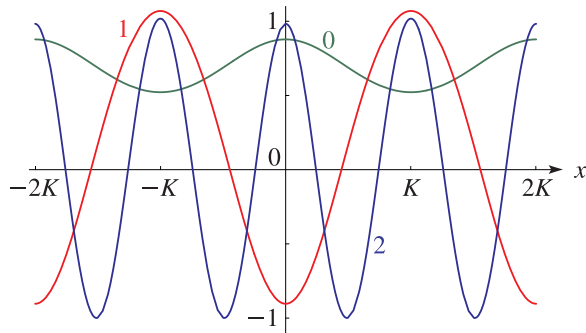


Figure 29.13.5:  $uE_4^m(x, 0.1)$  for  $-2K \leq x \leq 2K$ ,  $m = 0, 1, 2$ .  $K = 1.61244 \dots$

For additional graphs see <http://dlmf.nist.gov/29.13.ii>.

**29.13(iii) Lamé Polynomials: Complex Variable**

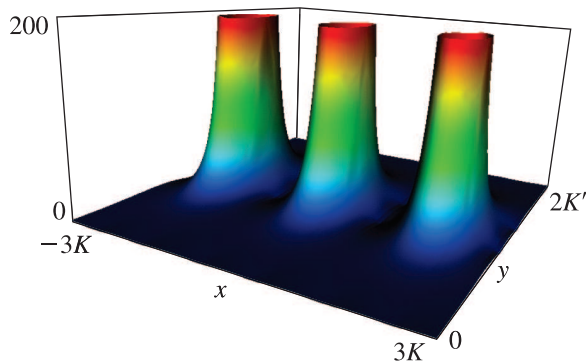


Figure 29.13.21:  $|uE_4^1(x + iy, 0.1)|$  for  $-3K \leq x \leq 3K$ ,  $0 \leq y \leq 2K'$ .  $K = 1.61244 \dots$ ,  $K' = 2.57809 \dots$

For additional graphics see <http://dlmf.nist.gov/29.13.iii>.

**29.14 Orthogonality**

Lamé polynomials are orthogonal in two ways. First, the orthogonality relations (29.3.19) apply; see §29.12(i). Secondly, the system of functions

$$29.14.1 \quad f_n^m(s, t) = uE_{2n}^m(s, k^2) uE_{2n}^m(K + it, k^2),$$

$$n = 0, 1, 2, \dots, m = 0, 1, \dots, n,$$

is orthogonal and complete with respect to the inner product

$$29.14.2 \quad \langle g, h \rangle = \int_0^K \int_0^{K'} w(s, t) g(s, t) h(s, t) dt ds,$$

where

$$29.14.3 \quad w(s, t) = \operatorname{sn}^2(K + it, k) - \operatorname{sn}^2(s, k).$$

For the corresponding results for the other seven types of Lamé polynomials see <http://dlmf.nist.gov/29.14>.

**29.15 Fourier Series and Chebyshev Series**

**29.15(i) Fourier Coefficients**

**Polynomial  $uE_{2n}^m(z, k^2)$**

When  $\nu = 2n$ ,  $m = 0, 1, \dots, n$ , the Fourier series (29.6.1) terminates:

$$29.15.1 \quad uE_{2n}^m(z, k^2) = \frac{1}{2} A_0 + \sum_{p=1}^n A_{2p} \cos(2p\phi).$$

A convenient way of constructing the coefficients, together with the eigenvalues, is as follows. Equations (29.6.4), with  $p = 1, 2, \dots, n$ , (29.6.3), and  $A_{2n+2} = 0$  can be cast as an algebraic eigenvalue problem in the following way. Let

$$29.15.2 \quad \mathbf{M} = \begin{bmatrix} \beta_0 & \alpha_0 & 0 & \cdots & 0 \\ \gamma_1 & \beta_1 & \alpha_1 & \ddots & \vdots \\ 0 & \ddots & \ddots & \ddots & 0 \\ \vdots & \ddots & \gamma_{n-1} & \beta_{n-1} & \alpha_{n-1} \\ 0 & \cdots & 0 & \gamma_n & \beta_n \end{bmatrix}$$

be the tridiagonal matrix with  $\alpha_p, \beta_p, \gamma_p$  as in (29.3.11), (29.3.12). Let the eigenvalues of  $\mathbf{M}$  be  $H_p$  with

$$29.15.3 \quad H_0 < H_1 < \cdots < H_n,$$

and also let

$$29.15.4 \quad [A_0, A_2, \dots, A_{2n}]^T$$

be the eigenvector corresponding to  $H_m$  and normalized so that

$$29.15.5 \quad \frac{1}{2} A_0^2 + \sum_{p=1}^n A_{2p}^2 = 1$$

and

$$29.15.6 \quad \frac{1}{2} A_0 + \sum_{p=1}^n A_{2p} > 0.$$

Then

$$29.15.7 \quad a_\nu^{2m}(k^2) = \frac{1}{2} (H_m + \nu(\nu + 1)k^2),$$

and (29.15.1) applies, with  $\phi$  again defined as in (29.2.5).

For the corresponding formulations for the other seven types of Lamé polynomials see <http://dlmf.nist.gov/29.15.i>.

### 29.15(ii) Chebyshev Series

The Chebyshev polynomial  $T$  of the first kind (§18.3) satisfies  $\cos(p\phi) = T_p(\cos \phi)$ . Since (29.2.5) implies that  $\cos \phi = \operatorname{sn}(z, k)$ , (29.15.1) can be rewritten in the form

$$29.15.43 \quad uE_{2n}^m(z, k^2) = \frac{1}{2}A_0 + \sum_{p=1}^n A_{2p} T_{2p}(\operatorname{sn}(z, k)).$$

This determines the polynomial  $P$  of degree  $n$  for which  $uE_{2n}^m(z, k^2) = P(\operatorname{sn}^2(z, k))$ ; compare Table 29.12.1. The set of coefficients of this polynomial (without normalization) can also be found directly as an eigenvector of an  $(n+1) \times (n+1)$  tridiagonal matrix; see Arscott and Khabaza (1962).

For the corresponding expansions of the other seven types of Lamé polynomials see <http://dlmf.nist.gov/29.15.ii>.

For explicit formulas for Lamé polynomials of low degree, see Arscott (1964b, p. 205).

### 29.16 Asymptotic Expansions

Hargrave and Sleeman (1977) give asymptotic approximations for Lamé polynomials and their eigenvalues, including error bounds. The approximations for Lamé polynomials hold uniformly on the rectangle  $0 \leq \Re z \leq K$ ,  $0 \leq \Im z \leq K'$ , when  $nk$  and  $nk'$  assume large real values. The approximating functions are exponential, trigonometric, and parabolic cylinder functions.

### 29.17 Other Solutions

#### 29.17(i) Second Solution

If (29.2.1) admits a Lamé polynomial solution  $E$ , then a second linearly independent solution  $F$  is given by

$$29.17.1 \quad F(z) = E(z) \int_{iK'}^z \frac{du}{(E(u))^2}.$$

For properties of these solutions see Arscott (1964b, §9.7), Erdélyi *et al.* (1955, §15.5.1), Shail (1980), and Sleeman (1966a).

#### 29.17(ii) Algebraic Lamé Functions

Algebraic Lamé functions are solutions of (29.2.1) when  $\nu$  is half an odd integer. They are algebraic functions of  $\operatorname{sn}(z, k)$ ,  $\operatorname{cn}(z, k)$ , and  $\operatorname{dn}(z, k)$ , and have primitive period  $8K$ . See Erdélyi (1941c), Ince (1940b), and Lambe (1952).

#### 29.17(iii) Lamé–Wangerin Functions

Lamé–Wangerin functions are solutions of (29.2.1) with the property that  $(\operatorname{sn}(z, k))^{1/2}w(z)$  is bounded on the line segment from  $iK'$  to  $2K + iK'$ . See Erdélyi *et al.* (1955, §15.6).

## Applications

### 29.18 Mathematical Applications

#### 29.18(i) Sphero-Conal Coordinates

The wave equation

$$29.18.1 \quad \nabla^2 u + \omega^2 u = 0,$$

when transformed to *sphero-conal coordinates*  $r, \beta, \gamma$ :

29.18.2

$$x = kr \operatorname{sn}(\beta, k) \operatorname{sn}(\gamma, k), \quad y = i \frac{k}{k'} r \operatorname{cn}(\beta, k) \operatorname{cn}(\gamma, k), \\ z = \frac{1}{k'} r \operatorname{dn}(\beta, k) \operatorname{dn}(\gamma, k),$$

with

29.18.3

$$r \geq 0, \quad \beta = K + i\beta', \quad 0 \leq \beta' \leq 2K', \quad 0 \leq \gamma \leq 4K,$$

admits solutions

$$29.18.4 \quad u(r, \beta, \gamma) = u_1(r)u_2(\beta)u_3(\gamma),$$

where  $u_1, u_2, u_3$  satisfy the differential equations

$$29.18.5 \quad \frac{d}{dr} \left( r^2 \frac{du_1}{dr} \right) + (\omega^2 r^2 - \nu(\nu+1))u_1 = 0,$$

$$29.18.6 \quad \frac{d^2 u_2}{d\beta^2} + (h - \nu(\nu+1)k^2 \operatorname{sn}^2(\beta, k))u_2 = 0,$$

$$29.18.7 \quad \frac{d^2 u_3}{d\gamma^2} + (h - \nu(\nu+1)k^2 \operatorname{sn}^2(\gamma, k))u_3 = 0,$$

with *separation constants*  $h$  and  $\nu$ . (29.18.5) is the differential equation of spherical Bessel functions (§10.47(i)), and (29.18.6), (29.18.7) agree with the Lamé equation (29.2.1).

#### 29.18(ii) Ellipsoidal Coordinates

The wave equation (29.18.1), when transformed to *ellipsoidal coordinates*  $\alpha, \beta, \gamma$ :

$$x = k \operatorname{sn}(\alpha, k) \operatorname{sn}(\beta, k) \operatorname{sn}(\gamma, k),$$

$$29.18.8 \quad y = -\frac{k}{k'} \operatorname{cn}(\alpha, k) \operatorname{cn}(\beta, k) \operatorname{cn}(\gamma, k),$$

$$z = \frac{i}{kk'} \operatorname{dn}(\alpha, k) \operatorname{dn}(\beta, k) \operatorname{dn}(\gamma, k),$$

with

29.18.9

$$\alpha = K + iK' - \alpha', \quad 0 \leq \alpha' < K, \\ \beta = K + i\beta', \quad 0 \leq \beta' \leq 2K', \quad 0 \leq \gamma \leq 4K,$$

admits solutions

$$29.18.10 \quad u(\alpha, \beta, \gamma) = u_1(\alpha)u_2(\beta)u_3(\gamma),$$

where  $u_1, u_2, u_3$  each satisfy the Lamé wave equation (29.11.1).

### 29.18(iii) Spherical and Ellipsoidal Harmonics

See Erdélyi *et al.* (1955, §15.7).

### 29.18(iv) Other Applications

Triebel (1965) gives applications of Lamé functions to the theory of conformal mappings. Patera and Winternitz (1973) finds bases for the rotation group.

## 29.19 Physical Applications

### 29.19(i) Lamé Functions

Simply-periodic Lamé functions ( $\nu$  noninteger) can be used to solve boundary-value problems for Laplace's equation in elliptical cones. For applications in antenna research see Jansen (1977). Brack *et al.* (2001) shows that Lamé functions occur at bifurcations in chaotic Hamiltonian systems. Bronski *et al.* (2001) uses Lamé functions in the theory of Bose–Einstein condensates.

### 29.19(ii) Lamé Polynomials

Ward (1987) computes finite-gap potentials associated with the periodic Korteweg–de Vries equation. Shail (1978) treats applications to solutions of elliptic crack and punch problems. Hargrave (1978) studies high frequency solutions of the delta wing equation. Macfadyen and Winternitz (1971) finds expansions for the two-body relativistic scattering amplitudes. Roper (1951) solves the linearized supersonic flow equations. Clarkson (1991) solves nonlinear evolution equations. Strutt (1932) describes various applications and provides an extensive list of references.

See also §29.12(iii).

## Computation

## 29.20 Methods of Computation

### 29.20(i) Lamé Functions

The eigenvalues  $a_\nu^m(k^2)$ ,  $b_\nu^m(k^2)$ , and the Lamé functions  $Ec_\nu^m(z, k^2)$ ,  $Es_\nu^m(z, k^2)$ , can be calculated by direct numerical methods applied to the differential equation (29.2.1); see §3.7. The normalization of Lamé functions given in §29.3(v) can be carried out by quadrature (§3.5).

A second approach is to solve the continued-fraction equations typified by (29.3.10) by Newton's rule or other iterative methods; see §3.8. Initial approximations to the eigenvalues can be found, for example, from

the asymptotic expansions supplied in §29.7(i). Subsequently, formulas typified by (29.6.4) can be applied to compute the coefficients of the Fourier expansions of the corresponding Lamé functions by backward recursion followed by application of formulas typified by (29.6.5) and (29.6.6) to achieve normalization; compare §3.6. (Equation (29.6.3) serves as a check.) The Fourier series may be summed using Clenshaw's algorithm; see §3.11(ii). For further information see Jansen (1977).

A third method is to approximate eigenvalues and Fourier coefficients of Lamé functions by eigenvalues and eigenvectors of finite matrices using the methods of §§3.2(vi) and 3.8(iv). These matrices are the same as those provided in §29.15(i) for the computation of Lamé polynomials with the difference that  $n$  has to be chosen sufficiently large. The approximations converge geometrically (§3.8(i)) to the eigenvalues and coefficients of Lamé functions as  $n \rightarrow \infty$ . The numerical computations described in Jansen (1977) are based in part upon this method.

### 29.20(ii) Lamé Polynomials

The eigenvalues corresponding to Lamé polynomials are computed from eigenvalues of the finite tridiagonal matrices  $\mathbf{M}$  given in §29.15(i), using methods described in §3.2(vi) and Ritter (1998). The corresponding eigenvectors yield the coefficients in the finite Fourier series for Lamé polynomials. §29.15(i) includes formulas for normalizing the eigenvectors.

### 29.20(iii) Zeros

Zeros of Lamé polynomials can be computed by solving the system of equations (29.12.13) by employing Newton's method; see §3.8(ii). Alternatively, the zeros can be found by locating the maximum of function  $g$  in (29.12.11).

## 29.21 Tables

- Ince (1940a) tabulates the eigenvalues  $a_\nu^m(k^2)$ ,  $b_\nu^{m+1}(k^2)$  (with  $a_\nu^{2m+1}$  and  $b_\nu^{2m+1}$  interchanged) for  $k^2 = 0.1, 0.5, 0.9$ ,  $\nu = -\frac{1}{2}, 0(1)25$ , and  $m = 0, 1, 2, 3$ . Precision is 4D.
- Arscott and Khabaza (1962) tabulates the coefficients of the polynomials  $P$  in Table 29.12.1 (normalized so that the numerically largest coefficient is unity, i.e. monic polynomials), and the corresponding eigenvalues  $h$  for  $k^2 = 0.1(.1)0.9$ ,  $n = 1(1)30$ . Equations from §29.6 can be used to transform to the normalization adopted in this chapter. Precision is 6S.

## 29.22 Software

See <http://dlmf.nist.gov/29.22>.

### References

#### General References

The main references used in writing this chapter are Arscott (1964b), Erdélyi *et al.* (1955), Ince (1940b), and Jansen (1977). For additional bibliographic reading see Hobson (1931), Strutt (1932), and Whittaker and Watson (1927).

#### Sources

The following list gives the references or other indications of proofs that were used in constructing the various sections of this chapter. These sources supplement the references that are quoted in the text.

§29.2 Erdélyi *et al.* (1955, §15.2).

§29.3 Erdélyi (1941b), Erdélyi *et al.* (1955, §15.5.1), Ince (1940b), Jansen (1977, §3.1), Magnus and Winkler (1966, §2.1), Volkmer (2004b). For (29.3.19) combine Hochstadt (1964, p. 148) and Table 29.3.2.

§29.4 The graphics were produced at NIST.

§29.5 Erdélyi *et al.* (1955, §15.5.4), Volkmer (2004b).

§29.6 Erdélyi *et al.* (1955, §15.5.1), Ince (1940b), Jansen (1977).

§29.7 Ince (1940a), Müller (1966a). For (29.7.5) see Volkmer (2004b).

§29.8 Erdélyi *et al.* (1955, §15.5.3), Volkmer (1982, 1983).

§29.9 Magnus and Winkler (1966, §2.1).

§29.12 Arscott (1964b, Chapter 9), Whittaker and Watson (1927, Chapter 23).

§29.13 The graphics were produced at NIST.

§29.14 Arscott (1964b, §9.4), Erdélyi *et al.* (1955, §15.7).

§29.15 The method for constructing the Fourier coefficients follows from §29.6. For the Chebyshev coefficients see Arscott (1964b, §9.6.2), Ince (1940a).

§29.18 Arscott (1964b, §9.8.1), Erdélyi *et al.* (1955, §§15.1.2, 15.1.3, 15.7), Hobson (1931, Chapter XI), Jansen (1977).





## Chapter 30

# Spheroidal Wave Functions

H. Volkmer<sup>1</sup>

<b>Notation</b>	<b>698</b>	30.12 Generalized and Coulomb Spheroidal Functions . . . . .	704
30.1 Special Notation . . . . .	698		
<b>Properties</b>	<b>698</b>	<b>Applications</b>	<b>704</b>
30.2 Differential Equations . . . . .	698	30.13 Wave Equation in Prolate Spheroidal Coordinates . . . . .	704
30.3 Eigenvalues . . . . .	698	30.14 Wave Equation in Oblate Spheroidal Coordinates . . . . .	705
30.4 Functions of the First Kind . . . . .	699	30.15 Signal Analysis . . . . .	706
30.5 Functions of the Second Kind . . . . .	700	<b>Computation</b>	<b>707</b>
30.6 Functions of Complex Argument . . . . .	700	30.16 Methods of Computation . . . . .	707
30.7 Graphics . . . . .	700	30.17 Tables . . . . .	708
30.8 Expansions in Series of Ferrers Functions . . . . .	702	30.18 Software . . . . .	708
30.9 Asymptotic Approximations and Expansions . . . . .	702	<b>References</b>	<b>708</b>
30.10 Series and Integrals . . . . .	703		
30.11 Radial Spheroidal Wave Functions . . . . .	703		

<sup>1</sup>Department of Mathematical Sciences, University of Wisconsin-Milwaukee, Milwaukee, Wisconsin.

**Acknowledgments:** This chapter is based in part on Abramowitz and Stegun (1964, Chapter 21) by A. N. Lowan.

**Copyright** © 2009 National Institute of Standards and Technology. All rights reserved.

## Notation

### 30.1 Special Notation

(For other notation see pp. xiv and 873.)

- $x$  real variable. Except in §§30.7(iv), 30.11(ii), 30.13, and 30.14,  $-1 < x < 1$ .  
 $\gamma^2$  real parameter (positive, zero, or negative).  
 $m$  order, a nonnegative integer.  
 $n$  degree, an integer  $n = m, m + 1, m + 2, \dots$ .  
 $k$  integer.  
 $\delta$  arbitrary small positive constant.

The main functions treated in this chapter are the eigenvalues  $\lambda_n^m(\gamma^2)$  and the spheroidal wave functions  $\text{Ps}_n^m(x, \gamma^2)$ ,  $\text{Qs}_n^m(x, \gamma^2)$ ,  $\text{Ps}_n^m(z, \gamma^2)$ ,  $\text{Qs}_n^m(z, \gamma^2)$ , and  $S_n^{m(j)}(z, \gamma)$ ,  $j = 1, 2, 3, 4$ . These notations are similar to those used in Arscott (1964b) and Erdélyi *et al.* (1955). Meixner and Schäfke (1954) use ps, qs, Ps, Qs for Ps, Qs,  $\text{Ps}$ ,  $\text{Qs}$ , respectively.

#### Other Notations

Flammer (1957) and Abramowitz and Stegun (1964) use  $\lambda_{mn}(\gamma)$  for  $\lambda_n^m(\gamma^2) + \gamma^2$ ,  $R_{mn}^{(j)}(\gamma, z)$  for  $S_n^{m(j)}(z, \gamma)$ , and

$$30.1.1 \quad \begin{aligned} S_{mn}^{(1)}(\gamma, x) &= d_{mn}(\gamma) \text{Ps}_n^m(x, \gamma^2), \\ S_{mn}^{(2)}(\gamma, x) &= d_{mn}(\gamma) \text{Qs}_n^m(x, \gamma^2), \end{aligned}$$

where  $d_{mn}(\gamma)$  is a normalization constant determined by

$$30.1.2 \quad \begin{aligned} S_{mn}^{(1)}(\gamma, 0) &= (-1)^m \text{P}_n^m(0), & n - m \text{ even}, \\ \left. \frac{d}{dx} S_{mn}^{(1)}(\gamma, x) \right|_{x=0} &= (-1)^m \left. \frac{d}{dx} \text{P}_n^m(x) \right|_{x=0}, & n - m \text{ odd}. \end{aligned}$$

For older notations see Abramowitz and Stegun (1964, §21.11) and Flammer (1957, pp. 14,15).

## Properties

### 30.2 Differential Equations

#### 30.2(i) Spheroidal Differential Equation

$$30.2.1 \quad \frac{d}{dz} \left( (1 - z^2) \frac{dw}{dz} \right) + \left( \lambda + \gamma^2(1 - z^2) - \frac{\mu^2}{1 - z^2} \right) w = 0.$$

This equation has regular singularities at  $z = \pm 1$  with exponents  $\pm \frac{1}{2}\mu$  and an irregular singularity of rank 1 at  $z = \infty$  (if  $\gamma \neq 0$ ). The equation contains three real parameters  $\lambda$ ,  $\gamma^2$ , and  $\mu$ . In applications involving prolate

spheroidal coordinates  $\gamma^2$  is positive, in applications involving oblate spheroidal coordinates  $\gamma^2$  is negative; see §§30.13, 30.14.

#### 30.2(ii) Other Forms

The *Liouville normal form* of equation (30.2.1) is

$$30.2.2 \quad \frac{d^2 g}{dt^2} + \left( \lambda + \frac{1}{4} + \gamma^2 \sin^2 t - \frac{\mu^2 - \frac{1}{4}}{\sin^2 t} \right) g = 0,$$

$$30.2.3 \quad z = \cos t, \quad w(z) = (1 - z^2)^{-\frac{1}{4}} g(t).$$

With  $\zeta = \gamma z$  Equation (30.2.1) changes to

$$30.2.4 \quad (\zeta^2 - \gamma^2) \frac{d^2 w}{d\zeta^2} + 2\zeta \frac{dw}{d\zeta} + \left( \zeta^2 - \lambda - \gamma^2 - \frac{\gamma^2 \mu^2}{\zeta^2 - \gamma^2} \right) w = 0.$$

#### 30.2(iii) Special Cases

If  $\gamma = 0$ , Equation (30.2.1) is the associated Legendre differential equation; see (14.2.2). If  $\mu^2 = \frac{1}{4}$ , Equation (30.2.2) reduces to the Mathieu equation; see (28.2.1). If  $\gamma = 0$ , Equation (30.2.4) is satisfied by spherical Bessel functions; see (10.47.1).

### 30.3 Eigenvalues

#### 30.3(i) Definition

With  $\mu = m = 0, 1, 2, \dots$ , the spheroidal wave functions  $\text{Ps}_n^m(x, \gamma^2)$  are solutions of Equation (30.2.1) which are bounded on  $(-1, 1)$ , or equivalently, which are of the form  $(1 - x^2)^{\frac{1}{2}m} g(x)$  where  $g(z)$  is an entire function of  $z$ . These solutions exist only for eigenvalues  $\lambda_n^m(\gamma^2)$ ,  $n = m, m + 1, m + 2, \dots$ , of the parameter  $\lambda$ .

#### 30.3(ii) Properties

The eigenvalues  $\lambda_n^m(\gamma^2)$  are analytic functions of the real variable  $\gamma^2$  and satisfy

$$30.3.1 \quad \lambda_m^m(\gamma^2) < \lambda_{m+1}^m(\gamma^2) < \lambda_{m+2}^m(\gamma^2) < \dots,$$

$$30.3.2 \quad \lambda_n^m(\gamma^2) = n(n+1) - \frac{1}{2}\gamma^2 + O(n^{-2}), \quad n \rightarrow \infty,$$

$$30.3.3 \quad \lambda_n^m(0) = n(n+1),$$

$$30.3.4 \quad -1 < \frac{d\lambda_n^m(\gamma^2)}{d(\gamma^2)} < 0.$$

**30.3(iii) Transcendental Equation**

If  $p$  is an even nonnegative integer, then the continued-fraction equation

$$\begin{aligned} 30.3.5 \quad & \beta_p - \lambda - \frac{\alpha_{p-2}\gamma_p}{\beta_{p-2} - \lambda - \frac{\alpha_{p-4}\gamma_{p-2}}{\beta_{p-4} - \lambda - \dots}} \dots \\ & = \frac{\alpha_p\gamma_{p+2}}{\beta_{p+2} - \lambda - \frac{\alpha_{p+2}\gamma_{p+4}}{\beta_{p+4} - \lambda - \dots}}, \end{aligned}$$

where  $\alpha_k, \beta_k, \gamma_k$  are defined by

$$30.3.6 \quad \alpha_k = -(k+1)(k+2), \quad \beta_k = (m+k)(m+k+1) - \gamma^2, \quad \gamma_k = \gamma^2,$$

has the solutions  $\lambda = \lambda_{m+2j}^m(\gamma^2)$ ,  $j = 0, 1, 2, \dots$ . If  $p$  is an odd positive integer, then Equation (30.3.5) has

---


$$30.3.9 \quad \begin{aligned} \ell_0 &= n(n+1), \quad 2\ell_2 = -1 - \frac{(2m-1)(2m+1)}{(2n-1)(2n+3)}, \\ 2\ell_4 &= \frac{(n-m-1)(n-m)(n+m-1)(n+m)}{(2n-3)(2n-1)^3(2n+1)} - \frac{(n-m+1)(n-m+2)(n+m+1)(n+m+2)}{(2n+1)(2n+3)^3(2n+5)}. \end{aligned}$$

For additional coefficients see <http://dlmf.nist.gov/30.3.iv>.

**30.4 Functions of the First Kind****30.4(i) Definitions**

The eigenfunctions of (30.2.1) that correspond to the eigenvalues  $\lambda_n^m(\gamma^2)$  are denoted by  $\text{Ps}_n^m(x, \gamma^2)$ ,  $n = m, m+1, m+2, \dots$ . They are normalized by the condition

$$30.4.1 \quad \int_{-1}^1 (\text{Ps}_n^m(x, \gamma^2))^2 dx = \frac{2}{2n+1} \frac{(n+m)!}{(n-m)!},$$

the sign of  $\text{Ps}_n^m(0, \gamma^2)$  being  $(-1)^{(n+m)/2}$  when  $n-m$  is even, and the sign of  $d\text{Ps}_n^m(x, \gamma^2)/dx|_{x=0}$  being  $(-1)^{(n+m-1)/2}$  when  $n-m$  is odd.

When  $\gamma^2 > 0$   $\text{Ps}_n^m(x, \gamma^2)$  is the *prolate angular spheroidal wave function*, and when  $\gamma^2 < 0$   $\text{Ps}_n^m(x, \gamma^2)$  is the *oblate angular spheroidal wave function*. If  $\gamma = 0$ ,  $\text{Ps}_n^m(x, 0)$  reduces to the Ferrers function  $\text{P}_n^m(x)$ :

$$30.4.2 \quad \text{Ps}_n^m(x, 0) = \text{P}_n^m(x);$$

compare §14.3(i).

**30.4(ii) Elementary Properties**

$$30.4.3 \quad \text{Ps}_n^m(-x, \gamma^2) = (-1)^{n-m} \text{Ps}_n^m(x, \gamma^2).$$

$\text{Ps}_n^m(x, \gamma^2)$  has exactly  $n-m$  zeros in the interval  $-1 < x < 1$ .

**30.4(iii) Power-Series Expansion**

$$30.4.4 \quad \text{Ps}_n^m(x, \gamma^2) = (1-x^2)^{\frac{1}{2}m} \sum_{k=0}^{\infty} g_k x^k, \quad -1 \leq x \leq 1,$$

the solutions  $\lambda = \lambda_{m+2j+1}^m(\gamma^2)$ ,  $j = 0, 1, 2, \dots$ . If  $p = 0$  or  $p = 1$ , the finite continued-fraction on the left-hand side of (30.3.5) equals 0; if  $p > 1$  its last denominator is  $\beta_0 - \lambda$  or  $\beta_1 - \lambda$ .

For a different choice of  $\alpha_p, \beta_p, \gamma_p$  in (30.3.5) see <http://dlmf.nist.gov/30.3.iii>.

**30.3(iv) Power-Series Expansion**

$$30.3.8 \quad \lambda_n^m(\gamma^2) = \sum_{k=0}^{\infty} \ell_{2k} \gamma^{2k}, \quad |\gamma^2| < r_n^m.$$

For values of  $r_n^m$  see Meixner *et al.* (1980, p. 109).

where

$$30.4.5 \quad \alpha_k g_{k+2} + (\beta_k - \lambda_n^m(\gamma^2)) g_k + \gamma_k g_{k-2} = 0$$

with  $\alpha_k, \beta_k, \gamma_k$  from (30.3.6), and  $g_{-1} = g_{-2} = 0$ ,  $g_k = 0$  for even  $k$  if  $n-m$  is odd and  $g_k = 0$  for odd  $k$  if  $n-m$  is even. Normalization of the coefficients  $g_k$  is effected by application of (30.4.1).

**30.4(iv) Orthogonality**

$$30.4.6 \quad \int_{-1}^1 \text{Ps}_k^m(x, \gamma^2) \text{Ps}_n^m(x, \gamma^2) dx = \frac{2}{2n+1} \frac{(n+m)!}{(n-m)!} \delta_{k,n}.$$

If  $f(x)$  is mean-square integrable on  $[-1, 1]$ , then formally

$$30.4.7 \quad f(x) = \sum_{n=m}^{\infty} c_n \text{Ps}_n^m(x, \gamma^2),$$

where

$$30.4.8 \quad c_n = (n + \frac{1}{2}) \frac{(n-m)!}{(n+m)!} \int_{-1}^1 f(t) \text{Ps}_n^m(t, \gamma^2) dt.$$

The expansion (30.4.7) converges in the norm of  $L^2(-1, 1)$ , that is,

$$30.4.9 \quad \lim_{N \rightarrow \infty} \int_{-1}^1 \left| f(x) - \sum_{n=m}^N c_n \text{Ps}_n^m(x, \gamma^2) \right|^2 dx = 0.$$

It is also equiconvergent with its expansion in Ferrers functions (as in (30.4.2)), that is, the difference of corresponding partial sums converges to 0 uniformly for  $-1 \leq x \leq 1$ .

### 30.5 Functions of the Second Kind

Other solutions of (30.2.1) with  $\mu = m$ ,  $\lambda = \lambda_n^m(\gamma^2)$ , and  $z = x$  are

30.5.1 
$$Qs_n^m(x, \gamma^2), \quad n = m, m + 1, m + 2, \dots$$

They satisfy

30.5.2 
$$Qs_n^m(-x, \gamma^2) = (-1)^{n-m+1} Qs_n^m(x, \gamma^2),$$

and

30.5.3 
$$Qs_n^m(x, 0) = Q_n^m(x);$$

compare §14.3(i). Also,

30.5.4 
$$\begin{aligned} & \mathscr{W} \{Ps_n^m(x, \gamma^2), Qs_n^m(x, \gamma^2)\} \\ &= \frac{(n+m)!}{(1-x^2)(n-m)!} A_n^m(\gamma^2) A_n^{-m}(\gamma^2) \quad (\neq 0), \end{aligned}$$

with  $A_n^{\pm m}(\gamma^2)$  as in (30.11.4).

For further properties see Meixner and Schäfke (1954) and §30.8(ii).

### 30.6 Functions of Complex Argument

The solutions

30.6.1 
$$Ps_n^m(z, \gamma^2), \quad Qs_n^m(z, \gamma^2),$$

of (30.2.1) with  $\mu = m$  and  $\lambda = \lambda_n^m(\gamma^2)$  are real when  $z \in (1, \infty)$ , and their principal values (§4.2(i)) are obtained by analytic continuation to  $\mathbb{C} \setminus (-\infty, 1]$ .

#### Relations to Associated Legendre Functions

30.6.2 
$$Ps_n^m(z, 0) = P_n^m(z), \quad Qs_n^m(z, 0) = Q_n^m(z);$$

compare §14.3(ii).

#### Wronskian

30.6.3 
$$\begin{aligned} & \mathscr{W} \{Ps_n^m(z, \gamma^2), Qs_n^m(z, \gamma^2)\} \\ &= \frac{(-1)^m(n+m)!}{(1-z^2)(n-m)!} A_n^m(\gamma^2) A_n^{-m}(\gamma^2), \end{aligned}$$

with  $A_n^{\pm m}(\gamma^2)$  as in (30.11.4).

#### Values on $(-1, 1)$

30.6.4 
$$Ps_n^m(x \pm i0, \gamma^2) = (\mp i)^m Ps_n^m(x, \gamma^2),$$

30.6.5 
$$\begin{aligned} & Qs_n^m(x \pm i0, \gamma^2) \\ &= (\mp i)^m (Qs_n^m(x, \gamma^2) \mp \frac{1}{2}i\pi Ps_n^m(x, \gamma^2)). \end{aligned}$$

For further properties see Arscott (1964b).

For results for Equation (30.2.1) with complex parameters see Meixner and Schäfke (1954).

### 30.7 Graphics

#### 30.7(i) Eigenvalues

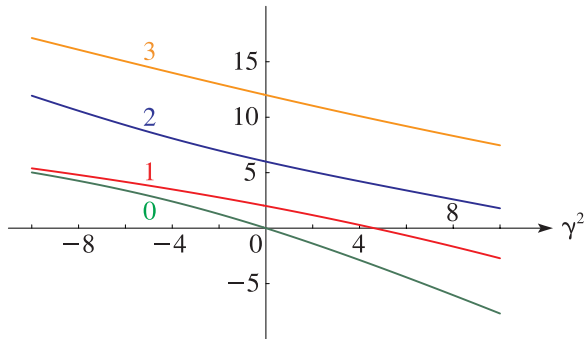


Figure 30.7.1: Eigenvalues  $\lambda_n^0(\gamma^2)$ ,  $n = 0, 1, 2, 3$ ,  $-10 \leq \gamma^2 \leq 10$ .

For additional graphs see <http://dlmf.nist.gov/30.7.i>.

#### 30.7(ii) Functions of the First Kind

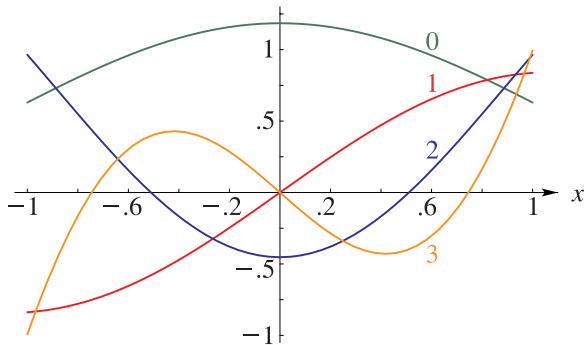


Figure 30.7.5:  $Ps_n^0(x, 4)$ ,  $n = 0, 1, 2, 3$ ,  $-1 \leq x \leq 1$ .

For additional graphs see <http://dlmf.nist.gov/30.7.ii>.

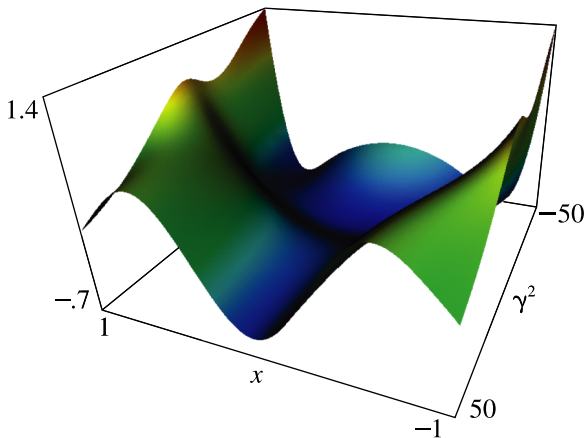


Figure 30.7.9:  $Ps_2^0(x, \gamma^2)$ ,  $-1 \leq x \leq 1$ ,  $-50 \leq \gamma^2 \leq 50$ .

For an additional surface see <http://dlmf.nist.gov/30.7.ii>.

**30.7(iii) Functions of the Second Kind**

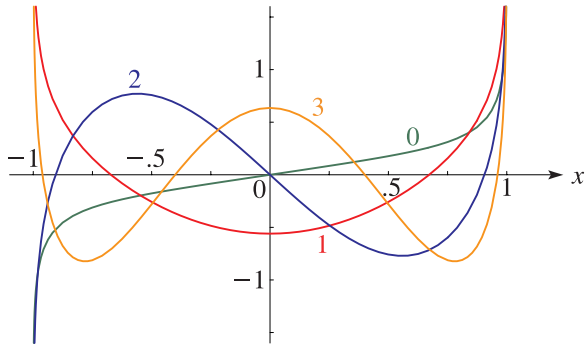


Figure 30.7.11:  $Qs_n^0(x, 4)$ ,  $n = 0, 1, 2, 3$ ,  $-1 < x < 1$ .

For additional graphs see <http://dlmf.nist.gov/30.7.iii>.

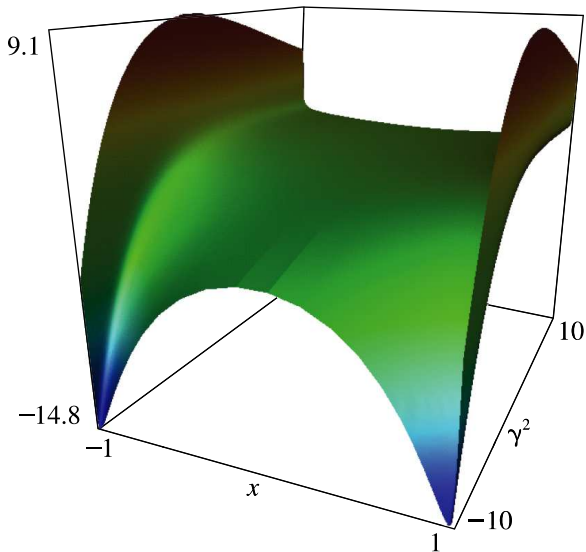


Figure 30.7.15:  $Qs_1^0(x, \gamma^2)$ ,  $-1 < x < 1$ ,  $-10 \leq \gamma^2 \leq 10$ .

**30.7(iv) Functions of Complex Argument**

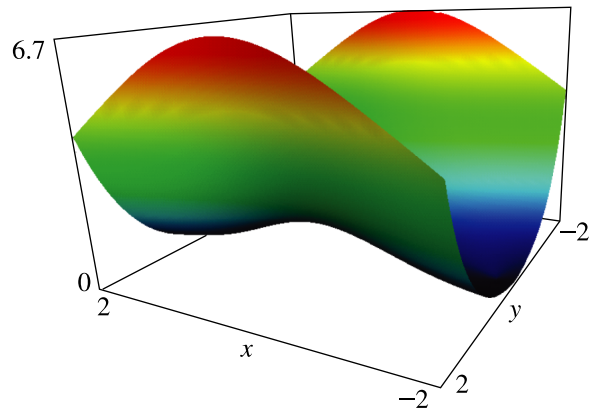


Figure 30.7.16:  $|Ps_0^0(x + iy, 4)|$ ,  $-2 \leq x \leq 2$ ,  $-2 \leq y \leq 2$ .

For additional surfaces see <http://dlmf.nist.gov/30.7.iv>.

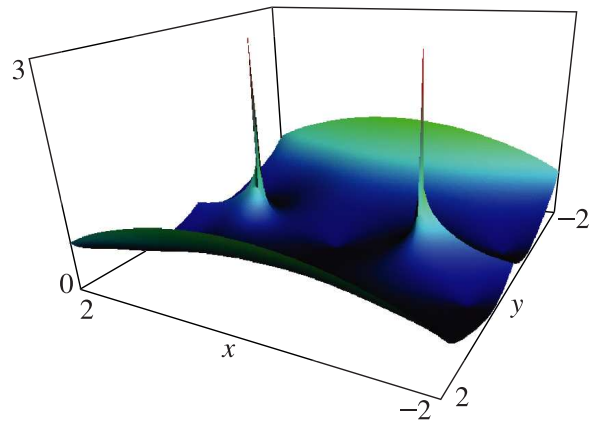


Figure 30.7.20:  $|Qs_0^0(x + iy, 4)|$ ,  $-2 \leq x \leq 2$ ,  $-2 \leq y \leq 2$ .

For an additional surface see <http://dlmf.nist.gov/30.7.iv>.

## 30.8 Expansions in Series of Ferrers Functions

### 30.8(i) Functions of the First Kind

$$30.8.1 \quad \text{Ps}_n^m(x, \gamma^2) = \sum_{k=-R}^{\infty} (-1)^k a_{n,k}^m(\gamma^2) \text{P}_{n+2k}^m(x),$$

where  $\text{P}_{n+2k}^m(x)$  is the Ferrers function of the first kind (§14.3(i)),  $R = \lfloor \frac{1}{2}(n-m) \rfloor$ , and the coefficients  $a_{n,k}^m(\gamma^2)$  are given by

$$30.8.2 \quad a_{n,k}^m(\gamma^2) = (-1)^k (n+2k+\frac{1}{2}) \frac{(n-m+2k)!}{(n+m+2k)!} \\ \times \int_{-1}^1 \text{Ps}_n^m(x, \gamma^2) \text{P}_{n+2k}^m(x) dx.$$

Let

$$30.8.3 \quad A_k = -\gamma^2 \frac{(n-m+2k-1)(n-m+2k)}{(2n+4k-3)(2n+4k-1)}, \\ B_k = (n+2k)(n+2k+1) \\ - 2\gamma^2 \frac{(n+2k)(n+2k+1)-1+m^2}{(2n+4k-1)(2n+4k+3)}, \\ C_k = -\gamma^2 \frac{(n+m+2k+1)(n+m+2k+2)}{(2n+4k+3)(2n+4k+5)}.$$

Then the set of coefficients  $a_{n,k}^m(\gamma^2)$ ,  $k = -R, -R+1, -R+2, \dots$  is the solution of the difference equation

$$30.8.4 \quad A_k f_{k-1} + (B_k - \lambda_n^m(\gamma^2)) f_k + C_k f_{k+1} = 0, \\ \text{(note that } A_{-R} = 0) \text{ that satisfies the normalizing condition}$$

$$30.8.5 \quad \sum_{k=-R}^{\infty} a_{n,k}^m(\gamma^2) a_{n,k}^{-m}(\gamma^2) \frac{1}{2n+4k+1} = \frac{1}{2n+1},$$

with

$$30.8.6 \quad a_{n,k}^{-m}(\gamma^2) = \frac{(n-m)!(n+m+2k)!}{(n+m)!(n-m+2k)!} a_{n,k}^m(\gamma^2).$$

Also, as  $k \rightarrow \infty$ ,

$$30.8.7 \quad \frac{k^2 a_{n,k}^m(\gamma^2)}{a_{n,k-1}^m(\gamma^2)} = \frac{\gamma^2}{16} + O\left(\frac{1}{k}\right),$$

and

$$30.8.8 \quad \frac{\lambda_n^m(\gamma^2) - B_k}{A_k} \frac{a_{n,k}^m(\gamma^2)}{a_{n,k-1}^m(\gamma^2)} = 1 + O\left(\frac{1}{k^4}\right).$$

### 30.8(ii) Functions of the Second Kind

$$30.8.9 \quad \text{Qs}_n^m(x, \gamma^2) = \sum_{k=-\infty}^{-N-1} (-1)^k a_{n,k}^m(\gamma^2) \text{P}_{n+2k}^m(x) \\ + \sum_{k=-N}^{\infty} (-1)^k a_{n,k}^m(\gamma^2) \text{Q}_{n+2k}^m(x),$$

where  $\text{P}_n^m$  and  $\text{Q}_n^m$  are again the Ferrers functions and  $N = \lfloor \frac{1}{2}(n+m) \rfloor$ . The coefficients  $a_{n,k}^m(\gamma^2)$  satisfy (30.8.4) for all  $k$  when we set  $a_{n,k}^m(\gamma^2) = 0$  for  $k < -N$ . For  $k \geq -R$  they agree with the coefficients defined in §30.8(i). For  $k = -N, -N+1, \dots, -R-1$  they are determined from (30.8.4) by forward recursion using  $a_{n,-N-1}^m(\gamma^2) = 0$ . The set of coefficients  $a_{n,k}^m(\gamma^2)$ ,  $k = -N-1, -N-2, \dots$ , is the recessive solution of (30.8.4) as  $k \rightarrow -\infty$  that is normalized by

$$30.8.10 \quad A_{-N-1} a_{n,-N-2}^m(\gamma^2) \\ + (B_{-N-1} - \lambda_n^m(\gamma^2)) a_{n,-N-1}^m(\gamma^2) \\ + C' a_{n,-N}^m(\gamma^2) = 0,$$

with

$$30.8.11 \quad C' = \begin{cases} \frac{\gamma^2}{4m^2-1}, & n-m \text{ even,} \\ -\frac{\gamma^2}{(2m-1)(2m-3)}, & n-m \text{ odd.} \end{cases}$$

It should be noted that if the forward recursion (30.8.4) beginning with  $f_{-N-1} = 0$ ,  $f_{-N} = 1$  leads to  $f_{-R} = 0$ , then  $a_{n,k}^m(\gamma^2)$  is undefined for  $n < -R$  and  $\text{Qs}_n^m(x, \gamma^2)$  does not exist.

## 30.9 Asymptotic Approximations and Expansions

### 30.9(i) Prolate Spheroidal Wave Functions

As  $\gamma^2 \rightarrow +\infty$ , with  $q = 2(n-m) + 1$ ,

$$30.9.1 \quad \lambda_n^m(\gamma^2) \sim -\gamma^2 + \gamma q + \beta_0 + \beta_1 \gamma^{-1} + \beta_2 \gamma^{-2} + \dots,$$

where

$$8\beta_0 = 8m^2 - q^2 - 5, \quad 2^6\beta_1 = -q^3 - 11q + 32m^2q,$$

$$30.9.2 \quad 2^{10}\beta_2 = -5(q^4 + 26q^2 + 21) + 384m^2(q^2 + 1),$$

$$2^{14}\beta_3 = -33q^5 - 1594q^3 - 5621q \\ + 128m^2(37q^3 + 167q) - 2048m^4q.$$

For additional coefficients see <http://dlmf.nist.gov/30.9.i>.

For the eigenfunctions see Meixner and Schäfke (1954, §3.251) and Müller (1963).

For uniform asymptotic expansions in terms of Airy or Bessel functions for real values of the parameters, complex values of the variable, and with explicit error bounds see Dunster (1986). See also Miles (1975).

**30.9(ii) Oblate Spheroidal Wave Functions**

As  $\gamma^2 \rightarrow -\infty$ , with  $q = n + 1$  if  $n - m$  is even, or  $q = n$  if  $n - m$  is odd, we have

**30.9.4**  $\lambda_n^m(\gamma^2) \sim 2q|\gamma| + c_0 + c_1|\gamma|^{-1} + c_2|\gamma|^{-2} + \dots$ ,

where

**30.9.5**

$$\begin{aligned} 2c_0 &= -q^2 - 1 + m^2, & 8c_1 &= -q^3 - q + m^2q, \\ 2^6c_2 &= -5q^4 - 10q^2 - 1 + 2m^2(3q^2 + 1) - m^4, \\ 2^9c_3 &= -33q^5 - 114q^3 - 37q + 2m^2(23q^3 + 25q) - 13m^4q. \end{aligned}$$

For additional coefficients see <http://dlmf.nist.gov/30.9.ii>.

For the eigenfunctions see Meixner and Schäfke (1954, §3.252) and Müller (1962).

For uniform asymptotic expansions in terms of elementary, Airy, or Bessel functions for real values of the parameters, complex values of the variable, and with explicit error bounds see Dunster (1992, 1995). See also Jorna and Springer (1971).

**30.9(iii) Other Approximations and Expansions**

The asymptotic behavior of  $\lambda_n^m(\gamma^2)$  and  $a_{n,k}^m(\gamma^2)$  as  $n \rightarrow \infty$  in descending powers of  $2n + 1$  is derived in Meixner (1944). The cases of large  $m$ , and of large  $m$  and large  $|\gamma|$ , are studied in Abramowitz (1949). The asymptotic behavior of  $\text{Ps}_n^m(x, \gamma^2)$  and  $\text{Qs}_n^m(x, \gamma^2)$  as  $x \rightarrow \pm 1$  is given in Erdélyi *et al.* (1955, p. 151). The behavior of  $\lambda_n^m(\gamma^2)$  for complex  $\gamma^2$  and large  $|\lambda_n^m(\gamma^2)|$  is investigated in Hunter and Guerrieri (1982).

**30.10 Series and Integrals**

Integrals and integral equations for  $\text{Ps}_n^m(x, \gamma^2)$  are given in Arscott (1964b, §8.6), Erdélyi *et al.* (1955, §16.13), Flammer (1957, Chapter 5), and Meixner (1951). For product formulas and convolutions see Connett *et al.* (1993). For an addition theorem, see Meixner and Schäfke (1954, p. 300) and King and Van Buren (1973). For expansions in products of spherical Bessel functions, see Flammer (1957, Chapter 6).

**30.11 Radial Spheroidal Wave Functions**

**30.11(i) Definitions**

Denote

**30.11.1**  $\psi_k^{(j)}(z) = \left(\frac{\pi}{2z}\right)^{\frac{1}{2}} C_{k+\frac{1}{2}}^{(j)}(z), \quad j = 1, 2, 3, 4,$

where

**30.11.2**  $C_\nu^{(1)} = J_\nu, \quad C_\nu^{(2)} = Y_\nu, \quad C_\nu^{(3)} = H_\nu^{(1)}, \quad C_\nu^{(4)} = H_\nu^{(2)},$

with  $J_\nu, Y_\nu, H_\nu^{(1)}$ , and  $H_\nu^{(2)}$  as in §10.2(ii). Then solutions of (30.2.1) with  $\mu = m$  and  $\lambda = \lambda_n^m(\gamma^2)$  are given by

**30.11.3**

$$S_n^{m(j)}(z, \gamma) = \frac{(1 - z^{-2})^{\frac{1}{2}m}}{A_n^{-m}(\gamma^2)} \sum_{2k \geq m-n} a_{n,k}^{-m}(\gamma^2) \psi_{n+2k}^{(j)}(\gamma z).$$

Here  $a_{n,k}^{-m}(\gamma^2)$  is defined by (30.8.2) and (30.8.6), and

**30.11.4**  $A_n^{\pm m}(\gamma^2) = \sum_{2k \geq \mp m-n} (-1)^k a_{n,k}^{\pm m}(\gamma^2) \quad (\neq 0).$

In (30.11.3)  $z \neq 0$  when  $j = 1$ , and  $|z| > 1$  when  $j = 2, 3, 4$ .

**Connection Formulas**

**30.11.5** 
$$\begin{aligned} S_n^{m(3)}(z, \gamma) &= S_n^{m(1)}(z, \gamma) + i S_n^{m(2)}(z, \gamma), \\ S_n^{m(4)}(z, \gamma) &= S_n^{m(1)}(z, \gamma) - i S_n^{m(2)}(z, \gamma). \end{aligned}$$

**30.11(ii) Graphics**

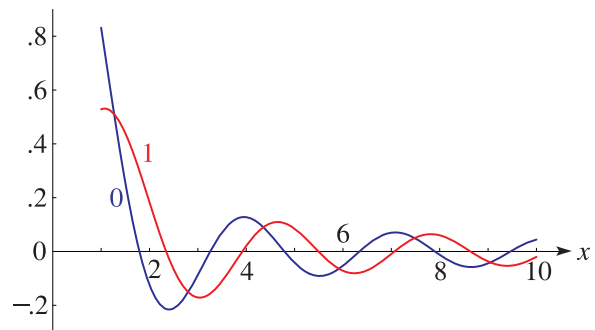


Figure 30.11.1:  $S_n^{0(1)}(x, 2), n = 0, 1, 1 \leq x \leq 10$ .

For additional graphs see <http://dlmf.nist.gov/30.11.ii>.

**30.11(iii) Asymptotic Behavior**

For fixed  $\gamma$ , as  $z \rightarrow \infty$  in the sector  $|\text{ph } z| \leq \pi - \delta (< \pi)$ ,

**30.11.6**

$$S_n^{m(j)}(z, \gamma) = \begin{cases} \psi_n^{(j)}(\gamma z) + O(z^{-2}e^{|\Im z|}), & j = 1, 2, \\ \psi_n^{(j)}(\gamma z) (1 + O(z^{-1})), & j = 3, 4. \end{cases}$$

For asymptotic expansions in negative powers of  $z$  see Meixner and Schäfke (1954, p. 293).

**30.11(iv) Wronskian**

**30.11.7**  $\mathscr{W} \left\{ S_n^{m(1)}(z, \gamma), S_n^{m(2)}(z, \gamma) \right\} = \frac{1}{\gamma(z^2 - 1)}.$



### 30.11(v) Connection with the $P_s$ and $Q_s$ Functions

$$30.11.8 \quad S_n^{m(1)}(z, \gamma) = K_n^m(\gamma) P_s^m(z, \gamma^2),$$

30.11.9

$$S_n^{m(2)}(z, \gamma) = \frac{(n-m)!}{(n+m)!} \frac{(-1)^{m+1} Q_s^m(z, \gamma^2)}{\gamma K_n^m(\gamma) A_n^m(\gamma^2) A_n^{-m}(\gamma^2)},$$

where

30.11.10

$$K_n^m(\gamma) = \frac{\sqrt{\pi}}{2} \left(\frac{\gamma}{2}\right)^m \frac{(-1)^m a_{n, \frac{1}{2}(m-n)}^{-m}(\gamma^2)}{\Gamma(\frac{3}{2} + m) A_n^{-m}(\gamma^2) P_s^m(0, \gamma^2)},$$

$n - m$  even,

or

30.11.11

$$K_n^m(\gamma) = \frac{\sqrt{\pi}}{2} \left(\frac{\gamma}{2}\right)^{m+1} \times \frac{(-1)^m a_{n, \frac{1}{2}(m-n+1)}^{-m}(\gamma^2)}{\Gamma(\frac{5}{2} + m) A_n^{-m}(\gamma^2) (dP_s^m(z, \gamma^2)/dz|_{z=0})},$$

$n - m$  odd.

### 30.11(vi) Integral Representations

When  $z \in \mathbb{C} \setminus (-\infty, 1]$

$$30.11.12 \quad \begin{aligned} & A_n^{-m}(\gamma^2) S_n^{m(1)}(z, \gamma) \\ &= \frac{1}{2} i^{m+n} \gamma^m \frac{(n-m)!}{(n+m)!} z^m (1-z^{-2})^{\frac{1}{2}m} \\ & \times \int_{-1}^1 e^{-i\gamma z t} (1-t^2)^{\frac{1}{2}m} P_s^m(t, \gamma^2) dt. \end{aligned}$$

For further relations see [Arscott \(1964b, §8.6\)](#), [Connett et al. \(1993\)](#), [Erdélyi et al. \(1955, §16.13\)](#), [Meixner and Schäfer \(1954\)](#), and [Meixner et al. \(1980, §3.1\)](#).

### 30.12 Generalized and Coulomb Spheroidal Functions

Generalized spheroidal wave functions and Coulomb spheroidal functions are solutions of the differential equation

$$30.12.1 \quad \begin{aligned} & \frac{d}{dz} \left( (1-z^2) \frac{dw}{dz} \right) \\ & + \left( \lambda + \alpha z + \gamma^2(1-z^2) - \frac{\mu^2}{1-z^2} \right) w = 0, \end{aligned}$$

which reduces to (30.2.1) if  $\alpha = 0$ . Equation (30.12.1) appears in astrophysics and molecular physics. For the theory and computation of solutions of (30.12.1) see [Falloon \(2001\)](#), [Judd \(1975\)](#), [Leaver \(1986\)](#), and [Komarov et al. \(1976\)](#).

Another generalization is provided by the differential equation

$$30.12.2 \quad \begin{aligned} & \frac{d}{dz} \left( (1-z^2) \frac{dw}{dz} \right) + \left( \lambda + \gamma^2(1-z^2) \right. \\ & \left. - \frac{\alpha(\alpha+1)}{z^2} - \frac{\mu^2}{1-z^2} \right) w = 0, \end{aligned}$$

which also reduces to (30.2.1) when  $\alpha = 0$ . See [Leitner and Meixner \(1960\)](#), [Slepian \(1964\)](#) with  $\mu = 0$ , and [Meixner et al. \(1980\)](#).

## Applications

### 30.13 Wave Equation in Prolate Spheroidal Coordinates

#### 30.13(i) Prolate Spheroidal Coordinates

Prolate spheroidal coordinates  $\xi, \eta, \phi$  are related to Cartesian coordinates  $x, y, z$  by

$$30.13.1 \quad \begin{aligned} x &= c\sqrt{(\xi^2-1)(1-\eta^2)} \cos \phi, \\ y &= c\sqrt{(\xi^2-1)(1-\eta^2)} \sin \phi, \quad z = c\xi\eta, \end{aligned}$$

where  $c$  is a positive constant. The  $(x, y, z)$ -space without the  $z$ -axis corresponds to

$$30.13.2 \quad 1 < \xi < \infty, \quad -1 < \eta < 1, \quad 0 \leq \phi < 2\pi.$$

The coordinate surfaces  $\xi = \text{const.}$  are prolate ellipsoids of revolution with foci at  $x = y = 0, z = \pm c$ . The coordinate surfaces  $\eta = \text{const.}$  are sheets of two-sheeted hyperboloids of revolution with the same foci. The focal line is given by  $\xi = 1, -1 \leq \eta \leq 1$ , and the rays  $\pm z \geq c, x = y = 0$  are given by  $\eta = \pm 1, \xi \geq 1$ .

#### 30.13(ii) Metric Coefficients

$$30.13.3 \quad h_\xi^2 = \left(\frac{\partial x}{\partial \xi}\right)^2 + \left(\frac{\partial y}{\partial \xi}\right)^2 + \left(\frac{\partial z}{\partial \xi}\right)^2 = \frac{c^2(\xi^2 - \eta^2)}{\xi^2 - 1},$$

$$30.13.4 \quad h_\eta^2 = \left(\frac{\partial x}{\partial \eta}\right)^2 + \left(\frac{\partial y}{\partial \eta}\right)^2 + \left(\frac{\partial z}{\partial \eta}\right)^2 = \frac{c^2(\xi^2 - \eta^2)}{1 - \eta^2},$$

$$30.13.5 \quad \begin{aligned} h_\phi^2 &= \left(\frac{\partial x}{\partial \phi}\right)^2 + \left(\frac{\partial y}{\partial \phi}\right)^2 + \left(\frac{\partial z}{\partial \phi}\right)^2 \\ &= c^2(\xi^2 - 1)(1 - \eta^2). \end{aligned}$$

**30.13(iii) Laplacian**

30.13.6

$$\begin{aligned}\nabla^2 &= \frac{1}{h_\xi h_\eta h_\phi} \left( \frac{\partial}{\partial \xi} \left( \frac{h_\eta h_\phi}{h_\xi} \frac{\partial}{\partial \xi} \right) + \frac{\partial}{\partial \eta} \left( \frac{h_\xi h_\phi}{h_\eta} \frac{\partial}{\partial \eta} \right) \right. \\ &\quad \left. + \frac{\partial}{\partial \phi} \left( \frac{h_\xi h_\eta}{h_\phi} \frac{\partial}{\partial \phi} \right) \right) \\ &= \frac{1}{c^2(\xi^2 - \eta^2)} \left( \frac{\partial}{\partial \xi} \left( (\xi^2 - 1) \frac{\partial}{\partial \xi} \right) \right. \\ &\quad \left. + \frac{\partial}{\partial \eta} \left( (1 - \eta^2) \frac{\partial}{\partial \eta} \right) + \frac{\xi^2 - \eta^2}{(\xi^2 - 1)(1 - \eta^2)} \frac{\partial^2}{\partial \phi^2} \right).\end{aligned}$$

**30.13(iv) Separation of Variables**

The wave equation

30.13.7 
$$\nabla^2 w + \kappa^2 w = 0,$$

transformed to prolate spheroidal coordinates  $(\xi, \eta, \phi)$ , admits solutions

30.13.8 
$$w(\xi, \eta, \phi) = w_1(\xi)w_2(\eta)w_3(\phi),$$

where  $w_1, w_2, w_3$  satisfy the differential equations

30.13.9

$$\frac{d}{d\xi} \left( (1 - \xi^2) \frac{dw_1}{d\xi} \right) + \left( \lambda + \gamma^2(1 - \xi^2) - \frac{\mu^2}{1 - \xi^2} \right) w_1 = 0,$$

30.13.10

$$\frac{d}{d\eta} \left( (1 - \eta^2) \frac{dw_2}{d\eta} \right) + \left( \lambda + \gamma^2(1 - \eta^2) - \frac{\mu^2}{1 - \eta^2} \right) w_2 = 0,$$

30.13.11

$$\frac{d^2 w_3}{d\phi^2} + \mu^2 w_3 = 0,$$

with  $\gamma^2 = \kappa^2 c^2 \geq 0$  and separation constants  $\lambda$  and  $\mu^2$ . Equations (30.13.9) and (30.13.10) agree with (30.2.1).In most applications the solution  $w$  has to be a single-valued function of  $(x, y, z)$ , which requires  $\mu = m$  (a nonnegative integer) and

30.13.12 
$$w_3(\phi) = a_3 \cos(m\phi) + b_3 \sin(m\phi).$$

Moreover,  $w$  has to be bounded along the  $z$ -axis away from the focal line: this requires  $w_2(\eta)$  to be bounded when  $-1 < \eta < 1$ . Then  $\lambda = \lambda_n^m(\gamma^2)$  for some  $n = m, m + 1, m + 2, \dots$ , and the general solution of (30.13.10) is

30.13.13 
$$w_2(\eta) = a_2 \text{Ps}_n^m(\eta, \gamma^2) + b_2 \text{Qs}_n^m(\eta, \gamma^2).$$

The solution of (30.13.9) with  $\mu = m$  is

30.13.14 
$$w_1(\xi) = a_1 S_n^{m(1)}(\xi, \gamma) + b_1 S_n^{m(2)}(\xi, \gamma).$$

If  $b_1 = b_2 = 0$ , then the function (30.13.8) is a twice-continuously differentiable solution of (30.13.7) in the entire  $(x, y, z)$ -space. If  $b_2 = 0$ , then this property holds outside the focal line.**30.13(v) The Interior Dirichlet Problem for Prolate Ellipsoids**Equation (30.13.7) for  $\xi \leq \xi_0$ , and subject to the boundary condition  $w = 0$  on the ellipsoid given by  $\xi = \xi_0$ , poses an eigenvalue problem with  $\kappa^2$  as spectral parameter. The eigenvalues are given by  $c^2 \kappa^2 = \gamma^2$ , where  $\gamma$  is determined from the condition

30.13.15 
$$S_n^{m(1)}(\xi_0, \gamma) = 0.$$

The corresponding eigenfunctions are given by (30.13.8), (30.13.14), (30.13.13), (30.13.12), with  $b_1 = b_2 = 0$ . For the Dirichlet boundary-value problem of the region  $\xi_1 \leq \xi \leq \xi_2$  between two ellipsoids, the eigenvalues are determined from

30.13.16 
$$w_1(\xi_1) = w_1(\xi_2) = 0,$$

with  $w_1$  as in (30.13.14). The corresponding eigenfunctions are given as before with  $b_2 = 0$ .For further applications see Meixner and Schäfer (1954), Meixner *et al.* (1980) and the references cited therein; also Ong (1986), Müller *et al.* (1994), and Xiao *et al.* (2001).**30.14 Wave Equation in Oblate Spheroidal Coordinates****30.14(i) Oblate Spheroidal Coordinates**Oblate spheroidal coordinates  $\xi, \eta, \phi$  are related to Cartesian coordinates  $x, y, z$  by

30.14.1 
$$\begin{aligned}x &= c\sqrt{(\xi^2 + 1)(1 - \eta^2)} \cos \phi, \\ y &= c\sqrt{(\xi^2 + 1)(1 - \eta^2)} \sin \phi, \quad z = c\xi\eta,\end{aligned}$$

where  $c$  is a positive constant. The  $(x, y, z)$ -space without the  $z$ -axis and the disk  $z = 0, x^2 + y^2 \leq c^2$  corresponds to

30.14.2 
$$0 < \xi < \infty, \quad -1 < \eta < 1, \quad 0 \leq \phi < 2\pi.$$

The coordinate surfaces  $\xi = \text{const.}$  are oblate ellipsoids of revolution with focal circle  $z = 0, x^2 + y^2 = c^2$ . The coordinate surfaces  $\eta = \text{const.}$  are halves of one-sheeted hyperboloids of revolution with the same focal circle. The disk  $z = 0, x^2 + y^2 \leq c^2$  is given by  $\xi = 0, -1 \leq \eta \leq 1$ , and the rays  $\pm z \geq 0, x = y = 0$  are given by  $\eta = \pm 1, \xi \geq 0$ .**30.14(ii) Metric Coefficients**

30.14.3 
$$h_\xi^2 = \frac{c^2(\xi^2 + \eta^2)}{1 + \xi^2},$$

30.14.4 
$$h_\eta^2 = \frac{c^2(\xi^2 + \eta^2)}{1 - \eta^2},$$

30.14.5 
$$h_\phi^2 = c^2(\xi^2 + 1)(1 - \eta^2).$$

**30.14(iii) Laplacian**

30.14.6

$$\nabla^2 = \frac{1}{c^2(\xi^2 + \eta^2)} \left( \frac{\partial}{\partial \xi} \left( (\xi^2 + 1) \frac{\partial}{\partial \xi} \right) + \frac{\partial}{\partial \eta} \left( (1 - \eta^2) \frac{\partial}{\partial \eta} \right) + \frac{\xi^2 + \eta^2}{(\xi^2 + 1)(1 - \eta^2)} \frac{\partial^2}{\partial \phi^2} \right).$$

**30.14(iv) Separation of Variables**

The wave equation (30.13.7), transformed to oblate spheroidal coordinates  $(\xi, \eta, \phi)$ , admits solutions of the form (30.13.8), where  $w_1$  satisfies the differential equation

30.14.7

$$\frac{d}{d\xi} \left( (1 + \xi^2) \frac{dw_1}{d\xi} \right) - \left( \lambda + \gamma^2(1 + \xi^2) - \frac{\mu^2}{1 + \xi^2} \right) w_1 = 0,$$

and  $w_2, w_3$  satisfy (30.13.10) and (30.13.11), respectively, with  $\gamma^2 = -\kappa^2 c^2 \leq 0$  and separation constants  $\lambda$  and  $\mu^2$ . Equation (30.14.7) can be transformed to equation (30.2.1) by the substitution  $z = \pm i\xi$ .

In most applications the solution  $w$  has to be a single-valued function of  $(x, y, z)$ , which requires  $\mu = m$  (a nonnegative integer). Moreover, the solution  $w$  has to be bounded along the  $z$ -axis: this requires  $w_2(\eta)$  to be bounded when  $-1 < \eta < 1$ . Then  $\lambda = \lambda_n^m(\gamma^2)$  for some  $n = m, m + 1, m + 2, \dots$ , and the solution of (30.13.10) is given by (30.13.13). The solution of (30.14.7) is given by

30.14.8  $w_1(\xi) = a_1 S_n^{m(1)}(i\xi, \gamma) + b_1 S_n^{m(2)}(i\xi, \gamma).$

If  $b_1 = b_2 = 0$ , then the function (30.13.8) is a twice-continuously differentiable solution of (30.13.7) in the entire  $(x, y, z)$ -space. If  $b_2 = 0$ , then this property holds outside the focal disk.

**30.14(v) The Interior Dirichlet Problem for Oblate Ellipsoids**

Equation (30.13.7) for  $\xi \leq \xi_0$  together with the boundary condition  $w = 0$  on the ellipsoid given by  $\xi = \xi_0$ , poses an eigenvalue problem with  $\kappa^2$  as spectral parameter. The eigenvalues are given by  $c^2 \kappa^2 = -\gamma^2$ , where  $\gamma^2$  is determined from the condition

30.14.9  $S_n^{m(1)}(i\xi_0, \gamma) = 0.$

The corresponding eigenfunctions are then given by (30.13.8), (30.14.8), (30.13.13), (30.13.12), with  $b_1 = b_2 = 0$ .

For further applications see Meixner and Schäfke (1954), Meixner *et al.* (1980) and the references cited therein; also Kokkorakis and Roumeliotis (1998) and Li *et al.* (1998).

**30.15 Signal Analysis**

**30.15(i) Scaled Spheroidal Wave Functions**

Let  $\tau (> 0)$  and  $\sigma (> 0)$  be given. Set  $\gamma = \tau\sigma$  and define

30.15.1

$$\phi_n(t) = \sqrt{\frac{2n+1}{2\tau}} \sqrt{\Lambda_n} \text{Ps}_n^0\left(\frac{t}{\tau}, \gamma^2\right), \quad n = 0, 1, 2, \dots,$$

30.15.2

$$\Lambda_n = \frac{2\gamma}{\pi} (K_n^0(\gamma) A_n^0(\gamma^2))^2;$$

see §30.11(v).

**30.15(ii) Integral Equation**

30.15.3

$$\int_{-\tau}^{\tau} \frac{\sin \sigma(t-s)}{\pi(t-s)} \phi_n(s) ds = \Lambda_n \phi_n(t).$$

**30.15(iii) Fourier Transform**

30.15.4

$$\int_{-\infty}^{\infty} e^{-it\omega} \phi_n(t) dt = (-i)^n \sqrt{\frac{2\pi\tau}{\sigma\Lambda_n}} \phi_n\left(\frac{\tau}{\sigma}\omega\right) \chi_\sigma(\omega),$$

30.15.5

$$\int_{-\tau}^{\tau} e^{-it\omega} \phi_n(t) dt = (-i)^n \sqrt{\frac{2\pi\tau\Lambda_n}{\sigma}} \phi_n\left(\frac{\tau}{\sigma}\omega\right),$$

where

30.15.6

$$\chi_\sigma(\omega) = \begin{cases} 1, & |\omega| \leq \sigma, \\ 0, & |\omega| > \sigma. \end{cases}$$

Equations (30.15.4) and (30.15.6) show that the functions  $\phi_n$  are  $\sigma$ -bandlimited, that is, their Fourier transform vanishes outside the interval  $[-\sigma, \sigma]$ .

**30.15(iv) Orthogonality**

30.15.7

$$\int_{-\tau}^{\tau} \phi_k(t) \phi_n(t) dt = \Lambda_n \delta_{k,n},$$

30.15.8

$$\int_{-\infty}^{\infty} \phi_k(t) \phi_n(t) dt = \delta_{k,n}.$$

The sequence  $\phi_n, n = 0, 1, 2, \dots$  forms an orthonormal basis in the space of  $\sigma$ -bandlimited functions, and, after normalization, an orthonormal basis in  $L^2(-\tau, \tau)$ .

**30.15(v) Extremal Properties**

The maximum (or least upper bound) B of all numbers

**30.15.9** 
$$\beta = \frac{1}{2\pi} \int_{-\sigma}^{\sigma} \left| \int_{-\infty}^{\infty} e^{-it\omega} f(t) dt \right|^2 d\omega$$

taken over all  $f \in L^2(-\infty, \infty)$  subject to

**30.15.10** 
$$\int_{-\infty}^{\infty} |f(t)|^2 dt = 1, \quad \int_{-\tau}^{\tau} |f(t)|^2 dt = \alpha,$$

for (fixed)  $\Lambda_0 < \alpha \leq 1$ , is given by

**30.15.11** 
$$\arccos \sqrt{\beta} + \arccos \sqrt{\alpha} = \arccos \sqrt{\Lambda_0},$$
  
or equivalently,

**30.15.12** 
$$B = \left( \sqrt{\Lambda_0 \alpha} + \sqrt{1 - \Lambda_0} \sqrt{1 - \alpha} \right)^2.$$

The corresponding function  $f$  is given by

$$f(t) = a\phi_0(t)\chi_{\tau}(t) + b\phi_0(t)(1 - \chi_{\tau}(t)),$$
  
**30.15.13** 
$$a = \sqrt{\frac{\alpha}{\Lambda_0}}, \quad b = \sqrt{\frac{1 - \alpha}{1 - \Lambda_0}}.$$

If  $0 < \alpha \leq \Lambda_0$ , then  $B = 1$ .

For further information see Frieden (1971), Lyman and Edmonson (2001), Papoulis (1977, Chapter 6), Slepian (1983), and Slepian and Pollak (1961).

**Computation**

**30.16 Methods of Computation**

**30.16(i) Eigenvalues**

For small  $|\gamma^2|$  we can use the power-series expansion (30.3.8). Schäfke and Groh (1962) gives corresponding error bounds. If  $|\gamma^2|$  is large we can use the asymptotic expansions in §30.9. Approximations to eigenvalues can be improved by using the continued-fraction equations from §30.3(iii) and §30.8; see Bouwkamp (1947) and Meixner and Schäfke (1954, §3.93).

Another method is as follows. Let  $n - m$  be even. For  $d$  sufficiently large, construct the  $d \times d$  tridiagonal matrix  $\mathbf{A} = [A_{j,k}]$  with nonzero elements

**30.16.1**

$$A_{j,j} = (m + 2j - 2)(m + 2j - 1) - 2\gamma^2 \frac{(m + 2j - 2)(m + 2j - 1) - 1 + m^2}{(2m + 4j - 5)(2m + 4j - 1)},$$

$$A_{j,j+1} = -\gamma^2 \frac{(2m + 2j - 1)(2m + 2j)}{(2m + 4j - 1)(2m + 4j + 1)},$$

$$A_{j,j-1} = -\gamma^2 \frac{(2j - 3)(2j - 2)}{(2m + 4j - 7)(2m + 4j - 5)},$$

and real eigenvalues  $\alpha_{1,d}, \alpha_{2,d}, \dots, \alpha_{d,d}$ , arranged in ascending order of magnitude. Then

**30.16.2** 
$$\alpha_{j,d+1} \leq \alpha_{j,d},$$
  
and

**30.16.3** 
$$\lambda_n^m(\gamma^2) = \lim_{d \rightarrow \infty} \alpha_{p,d}, \quad p = \lfloor \frac{1}{2}(n - m) \rfloor + 1.$$

The eigenvalues of  $\mathbf{A}$  can be computed by methods indicated in §§3.2(vi), 3.2(vii). The error satisfies

$$\alpha_{p,d} - \lambda_n^m(\gamma^2) = O\left(\frac{\gamma^{4d}}{4^{2d+1}((m + 2d - 1)!(m + 2d + 1)!)^2}\right),$$
  
$$d \rightarrow \infty.$$

**Example**

For  $m = 2, n = 4, \gamma^2 = 10$ ,

$$\alpha_{2,2} = 14.18833 \ 246, \quad \alpha_{2,3} = 13.98002 \ 013,$$

**30.16.5** 
$$\alpha_{2,4} = 13.97907 \ 459, \quad \alpha_{2,5} = 13.97907 \ 345,$$
  
$$\alpha_{2,6} = 13.97907 \ 345,$$

which yields  $\lambda_4^2(10) = 13.97907 \ 345$ . If  $n - m$  is odd, then (30.16.1) is replaced by

$$A_{j,j} = (m + 2j - 1)(m + 2j) - 2\gamma^2 \frac{(m + 2j - 1)(m + 2j) - 1 + m^2}{(2m + 4j - 3)(2m + 4j + 1)},$$
  
**30.16.6** 
$$A_{j,j+1} = -\gamma^2 \frac{(2m + 2j)(2m + 2j + 1)}{(2m + 4j + 1)(2m + 4j + 3)},$$
  
$$A_{j,j-1} = -\gamma^2 \frac{(2j - 2)(2j - 1)}{(2m + 4j - 5)(2m + 4j - 3)}.$$

**30.16(ii) Spheroidal Wave Functions of the First Kind**

If  $|\gamma^2|$  is large, then we can use the asymptotic expansions referred to in §30.9 to approximate  $\text{Ps}_n^m(x, \gamma^2)$ .

If  $\lambda_n^m(\gamma^2)$  is known, then we can compute  $\text{Ps}_n^m(x, \gamma^2)$  (not normalized) by solving the differential equation (30.2.1) numerically with initial conditions  $w(0) = 1, w'(0) = 0$  if  $n - m$  is even, or  $w(0) = 0, w'(0) = 1$  if  $n - m$  is odd.

If  $\lambda_n^m(\gamma^2)$  is known, then  $\text{Ps}_n^m(x, \gamma^2)$  can be found by summing (30.8.1). The coefficients  $a_{n,r}^m(\gamma^2)$  are computed as the recessive solution of (30.8.4) (§3.6), and normalized via (30.8.5).

A fourth method, based on the expansion (30.8.1), is as follows. Let  $\mathbf{A}$  be the  $d \times d$  matrix given by (30.16.1) if  $n - m$  is even, or by (30.16.6) if  $n - m$  is odd. Form the eigenvector  $[e_{1,d}, e_{2,d}, \dots, e_{d,d}]^T$  of  $\mathbf{A}$  associated with the eigenvalue  $\alpha_{p,d}, p = \lfloor \frac{1}{2}(n - m) \rfloor + 1$ , normalized according to

**30.16.7** 
$$\sum_{j=1}^d e_{j,d}^2 \frac{(n + m + 2j - 2p)!}{(n - m + 2j - 2p)!} \frac{1}{2n + 4j - 4p + 1} = \frac{(n + m)!}{(n - m)!} \frac{1}{2n + 1}.$$

Then

$$30.16.8 \quad a_{n,k}^m(\gamma^2) = \lim_{d \rightarrow \infty} e_{k+p,d},$$

$$30.16.9 \quad \text{Ps}_n^m(x, \gamma^2) = \lim_{d \rightarrow \infty} \sum_{j=1}^d (-1)^{j-p} e_{j,d} \text{P}_{n+2(j-p)}^m(x).$$

For error estimates see Volkmer (2004a).

### 30.16(iii) Radial Spheroidal Wave Functions

The coefficients  $a_{n,k}^m(\gamma^2)$  calculated in §30.16(ii) can be used to compute  $S_n^{m(j)}(z, \gamma)$ ,  $j = 1, 2, 3, 4$  from (30.11.3) as well as the connection coefficients  $K_n^m(\gamma)$  from (30.11.10) and (30.11.11).

For another method see Van Buren and Boisvert (2002).

### 30.17 Tables

- Stratton *et al.* (1956) tabulates quantities closely related to  $\lambda_n^m(\gamma^2)$  and  $a_{n,k}^m(\gamma^2)$  for  $0 \leq m \leq 8$ ,  $m \leq n \leq 8$ ,  $-64 \leq \gamma^2 \leq 64$ . Precision is 7S.
- Flammer (1957) includes 18 tables of eigenvalues, expansion coefficients, spheroidal wave functions, and other related quantities. Precision varies between 4S and 10S.
- Hanish *et al.* (1970) gives  $\lambda_n^m(\gamma^2)$  and  $S_n^{m(j)}(z, \gamma)$ ,  $j = 1, 2$ , and their first derivatives, for  $0 \leq m \leq 2$ ,  $m \leq n \leq m + 49$ ,  $-1600 \leq \gamma^2 \leq 1600$ . The range of  $z$  is given by  $1 \leq z \leq 10$  if  $\gamma^2 > 0$ , or  $z = -i\xi$ ,  $0 \leq \xi \leq 2$  if  $\gamma^2 < 0$ . Precision is 18S.
- Eraševskaja *et al.* (1973, 1976) gives  $S^{m(j)}(iy, -ic)$ ,  $S^{m(j)}(z, \gamma)$  and their first derivatives for  $j = 1, 2$ ,  $0.5 \leq c \leq 8$ ,  $y = 0, 0.5, 1, 1.5$ ,  $0.5 \leq \gamma \leq 8$ ,  $z = 1.01, 1.1, 1.4, 1.8$ . Precision is 15S.
- Van Buren *et al.* (1975) gives  $\lambda_n^0(\gamma^2)$ ,  $\text{Ps}_n^0(x, \gamma^2)$  for  $0 \leq n \leq 49$ ,  $-1600 \leq \gamma^2 \leq 1600$ ,  $-1 \leq x \leq 1$ . Precision is 8S.
- Zhang and Jin (1996) includes 24 tables of eigenvalues, spheroidal wave functions and their derivatives. Precision varies between 6S and 8S.

Fletcher *et al.* (1962, §22.28) provides additional information on tables prior to 1961.

### 30.18 Software

See <http://dlmf.nist.gov/30.18>.

## References

### General References

The main references used in writing this chapter are Arscott (1964b), Erdélyi *et al.* (1955), Meixner and Schäfke (1954), and Meixner *et al.* (1980). For additional bibliographic reading see Flammer (1957), Komarov *et al.* (1976), and Stratton *et al.* (1956).

### Sources

The following list gives the references or other indications of proofs that were used in constructing the various sections of this chapter. These sources supplement the references that are quoted in the text.

- §30.2 Meixner and Schäfke (1954, §3.1), Arscott (1964b, §8.1).
- §30.3 Meixner and Schäfke (1954, §§3.2, 3.531).
- §30.4 Meixner and Schäfke (1954, §3.2), Arscott (1964b, §8.2).
- §§30.5, 30.6 Meixner and Schäfke (1954, §3.6).
- §30.7 These graphics were produced at NIST with the aid of Maple procedures provided by the author.
- §30.8 Arscott (1964b, §§8.2, 8.5), Meixner and Schäfke (1954, §§3.542, 3.62).
- §30.9 Meixner and Schäfke (1954, §§3.251, 3.252), Müller (1962, 1963).
- §30.11 Arscott (1964b, §8.5), Meixner and Schäfke (1954, §§3.64–3.66, 3.84), Erdélyi *et al.* (1955, §16.11). Figure 30.11.1 was produced at NIST with the aid of Maple procedures provided by the author.
- §30.13 Erdélyi *et al.* (1955, §16.1.2), Meixner and Schäfke (1954, §§1.123, 1.133, Chapter 4).
- §30.14 Erdélyi *et al.* (1955, §16.1.3), Meixner and Schäfke (1954, §§1.124, 1.134, Chapter 4).
- §30.15 Frieden (1971, pp. 321–324, §2.10), Meixner *et al.* (1980, p. 114), Papoulis (1977, pp. 205–210), Slepian (1983).
- §30.16 Meixner and Schäfke (1954, §3.93), Volkmer (2004a), Van Buren *et al.* (1972).

## Chapter 31

# Heun Functions

B. D. Sleeman<sup>1</sup> and V. B. Kuznetsov<sup>2</sup>

<b>Notation</b>	<b>710</b>		
31.1 Special Notation . . . . .	710	31.11 Expansions in Series of Hypergeometric Functions . . . . .	716
<b>Properties</b>	<b>710</b>	31.12 Confluent Forms of Heun's Equation . . .	717
31.2 Differential Equations . . . . .	710	31.13 Asymptotic Approximations . . . . .	718
31.3 Basic Solutions . . . . .	711	31.14 General Fuchsian Equation . . . . .	718
31.4 Solutions Analytic at Two Singularities: Heun Functions . . . . .	712	31.15 Stieltjes Polynomials . . . . .	718
31.5 Solutions Analytic at Three Singularities: Heun Polynomials . . . . .	712	<b>Applications</b>	<b>719</b>
31.6 Path-Multiplicative Solutions . . . . .	712	31.16 Mathematical Applications . . . . .	719
31.7 Relations to Other Functions . . . . .	713	31.17 Physical Applications . . . . .	720
31.8 Solutions via Quadratures . . . . .	713	<b>Computation</b>	<b>720</b>
31.9 Orthogonality . . . . .	714	31.18 Methods of Computation . . . . .	720
31.10 Integral Equations and Representations .	714	<b>References</b>	<b>721</b>

<sup>1</sup>Department of Applied Mathematics, University of Leeds, Leeds, United Kingdom.

<sup>2</sup>Department of Applied Mathematics, University of Leeds, Leeds, United Kingdom.

Copyright © 2009 National Institute of Standards and Technology. All rights reserved.

## Notation

### 31.1 Special Notation

(For other notation see pp. xiv and 873.)

$x, y$	real variables.
$z, \zeta, w, W$	complex variables.
$j, k, \ell, m, n$	nonnegative integers.
$a$	complex parameter, $ a  \geq 1, a \neq 1$ .
$q, \alpha, \beta, \gamma, \delta, \epsilon, \nu$	complex parameters.

The main functions treated in this chapter are  $H\ell(a, q; \alpha, \beta, \gamma, \delta; z)$ ,  $(s_1, s_2)Hf_m(a, q_m; \alpha, \beta, \gamma, \delta; z)$ ,  $(s_1, s_2)Hf_m^\nu(a, q_m; \alpha, \beta, \gamma, \delta; z)$ , and the polynomial  $Hp_{n,m}(a, q_{n,m}; -n, \beta, \gamma, \delta; z)$ . These notations were introduced by Arscott in Ronveaux (1995, pp. 34–44). Sometimes the parameters are suppressed.

## Properties

### 31.2 Differential Equations

#### 31.2(i) Heun's Equation

$$31.2.1 \quad \frac{d^2 w}{dz^2} + \left( \frac{\gamma}{z} + \frac{\delta}{z-1} + \frac{\epsilon}{z-a} \right) \frac{dw}{dz} + \frac{\alpha\beta z - q}{z(z-1)(z-a)} w = 0, \\ \alpha + \beta + 1 = \gamma + \delta + \epsilon.$$

This equation has regular singularities at  $0, 1, a, \infty$ , with corresponding exponents  $\{0, 1-\gamma\}$ ,  $\{0, 1-\delta\}$ ,  $\{0, 1-\epsilon\}$ ,  $\{\alpha, \beta\}$ , respectively (§2.7(i)). All other homogeneous linear differential equations of the second order having four regular singularities in the extended complex plane,  $\mathbb{C} \cup \{\infty\}$ , can be transformed into (31.2.1).

The parameters play different roles:  $a$  is the *singularity parameter*;  $\alpha, \beta, \gamma, \delta, \epsilon$  are *exponent parameters*;  $q$  is the *accessory parameter*. The total number of free parameters is six.

#### 31.2(ii) Normal Form of Heun's Equation

$$31.2.2 \quad w(z) = z^{-\gamma/2} (z-1)^{-\delta/2} (z-a)^{-\epsilon/2} W(z), \\ 31.2.3 \quad \frac{d^2 W}{dz^2} = \left( \frac{A}{z} + \frac{B}{z-1} + \frac{C}{z-a} + \frac{D}{z^2} + \frac{E}{(z-1)^2} + \frac{F}{(z-a)^2} \right) W, \\ A + B + C = 0,$$

#### 31.2.4

$$A = -\frac{\gamma\delta}{2} - \frac{\gamma\epsilon}{2a} + \frac{q}{a}, \quad B = \frac{\gamma\delta}{2} - \frac{\delta\epsilon}{2(a-1)} - \frac{q-\alpha\beta}{a-1}, \\ C = \frac{\gamma\epsilon}{2a} + \frac{\delta\epsilon}{2(a-1)} - \frac{a\alpha\beta - q}{a(a-1)}, \quad D = \frac{1}{2}\gamma(\frac{1}{2}\gamma - 1), \\ E = \frac{1}{2}\delta(\frac{1}{2}\delta - 1), \quad F = \frac{1}{2}\epsilon(\frac{1}{2}\epsilon - 1).$$

#### 31.2(iii) Trigonometric Form

$$31.2.5 \quad z = \sin^2 \theta,$$

$$31.2.6 \quad \frac{d^2 w}{d\theta^2} + \left( (2\gamma - 1) \cot \theta - (2\delta - 1) \tan \theta - \frac{\epsilon \sin(2\theta)}{a - \sin^2 \theta} \right) \frac{dw}{d\theta} + 4 \frac{\alpha\beta \sin^2 \theta - q}{a - \sin^2 \theta} w = 0.$$

#### 31.2(iv) Doubly-Periodic Forms

##### Jacobi's Elliptic Form

With the notation of §22.2 let

$$31.2.7 \quad a = k^{-2}, \quad z = \operatorname{sn}^2(\zeta, k).$$

Then (suppressing the parameter  $k$ )

$$31.2.8 \quad \frac{d^2 w}{d\zeta^2} + \left( (2\gamma - 1) \frac{\operatorname{cn} \zeta \operatorname{dn} \zeta}{\operatorname{sn} \zeta} - (2\delta - 1) \frac{\operatorname{sn} \zeta \operatorname{dn} \zeta}{\operatorname{cn} \zeta} - (2\epsilon - 1) k^2 \frac{\operatorname{sn} \zeta \operatorname{cn} \zeta}{\operatorname{dn} \zeta} \right) \frac{dw}{d\zeta} + 4k^2(\alpha\beta \operatorname{sn}^2 \zeta - q)w = 0.$$

##### Weierstrass's Form

With the notation of §§19.2(ii) and 23.2 let

$$k^2 = (e_2 - e_3)/(e_1 - e_3), \\ 31.2.9 \quad \zeta = iK' + \xi(e_1 - e_3)^{1/2}, \quad e_1 = \wp(\omega_1), \\ e_2 = \wp(\omega_2), \quad e_3 = \wp(\omega_3), \quad e_1 + e_2 + e_3 = 0,$$

where  $2\omega_1$  and  $2\omega_3$  with  $\Im(\omega_3/\omega_1) > 0$  are generators of the lattice  $\mathbb{L}$  for  $\wp(z|\mathbb{L})$ . Then

$$31.2.10 \quad w(\xi) = (\wp(\xi) - e_3)^{(1-2\gamma)/4} (\wp(\xi) - e_2)^{(1-2\delta)/4} \\ \times (\wp(\xi) - e_1)^{(1-2\epsilon)/4} W(\xi),$$

where  $W(\xi)$  satisfies

$$31.2.11 \quad \frac{d^2 W}{d\xi^2} + (H + b_0 \wp(\xi) + b_1 \wp(\xi + \omega_1) + b_2 \wp(\xi + \omega_2) + b_3 \wp(\xi + \omega_3)) W = 0,$$

with

$$b_0 = 4\alpha\beta - (\gamma + \delta + \epsilon - \frac{1}{2})(\gamma + \delta + \epsilon - \frac{3}{2}), \\ b_1 = -(\epsilon - \frac{1}{2})(\epsilon - \frac{3}{2}), \quad b_2 = -(\delta - \frac{1}{2})(\delta - \frac{3}{2}), \\ 31.2.12 \quad b_3 = -(\gamma - \frac{1}{2})(\gamma - \frac{3}{2}), \\ H = e_1(\gamma + \delta - 1)^2 + e_2(\gamma + \epsilon - 1)^2 \\ + e_3(\delta + \epsilon - 1)^2 - 4\alpha\beta e_3 - 4q(e_2 - e_3).$$

### 31.2(v) Heun's Equation Automorphisms

#### *F*-Homotopic Transformations

$w(z) = z^{1-\gamma}w_1(z)$  satisfies (31.2.1) if  $w_1$  is a solution of (31.2.1) with transformed parameters  $q_1 = q + (a\delta + \epsilon)(1 - \gamma)$ ;  $\alpha_1 = \alpha + 1 - \gamma$ ,  $\beta_1 = \beta + 1 - \gamma$ ,  $\gamma_1 = 2 - \gamma$ . Next,  $w(z) = (z - 1)^{1-\delta}w_2(z)$  satisfies (31.2.1) if  $w_2$  is a solution of (31.2.1) with transformed parameters  $q_2 = q + a\gamma(1 - \delta)$ ;  $\alpha_2 = \alpha + 1 - \delta$ ,  $\beta_2 = \beta + 1 - \delta$ ,  $\delta_2 = 2 - \delta$ . Lastly,  $w(z) = (z - a)^{1-\epsilon}w_3(z)$  satisfies (31.2.1) if  $w_3$  is a solution of (31.2.1) with transformed parameters  $q_3 = q + \gamma(1 - \epsilon)$ ;  $\alpha_3 = \alpha + 1 - \epsilon$ ,  $\beta_3 = \beta + 1 - \epsilon$ ,  $\epsilon_3 = 2 - \epsilon$ . By composing these three steps, there result  $2^3 = 8$  possible transformations of the dependent variable (including the identity transformation) that preserve the form of (31.2.1).

#### Homographic Transformations

There are  $4! = 24$  homographies  $\tilde{z}(z) = (Az + B)/(Cz + D)$  that take  $0, 1, a, \infty$  to some permutation of  $0, 1, a', \infty$ , where  $a'$  may differ from  $a$ . If  $\tilde{z} = \tilde{z}(z)$  is one of the  $3! = 6$  homographies that map  $\infty$  to  $\infty$ , then  $w(z) = \tilde{w}(\tilde{z})$  satisfies (31.2.1) if  $\tilde{w}(\tilde{z})$  is a solution of (31.2.1) with  $z$  replaced by  $\tilde{z}$  and appropriately transformed parameters. For example, if  $\tilde{z} = z/a$ , then the parameters are  $\tilde{a} = 1/a$ ,  $\tilde{q} = q/a$ ;  $\tilde{\delta} = \epsilon$ ,  $\tilde{\epsilon} = \delta$ . If  $\tilde{z} = \tilde{z}(z)$  is one of the  $4! - 3! = 18$  homographies that do not map  $\infty$  to  $\infty$ , then an appropriate prefactor must be included on the right-hand side. For example,  $w(z) = (1 - z)^{-\alpha}\tilde{w}(z/(z - 1))$ , which arises from  $\tilde{z} = z/(z - 1)$ , satisfies (31.2.1) if  $\tilde{w}(\tilde{z})$  is a solution of (31.2.1) with  $z$  replaced by  $\tilde{z}$  and transformed parameters  $\tilde{a} = a/(a - 1)$ ,  $\tilde{q} = -(q - a\alpha\gamma)/(a - 1)$ ;  $\tilde{\beta} = \alpha + 1 - \delta$ ,

$$\tilde{\delta} = \alpha + 1 - \beta.$$

#### Composite Transformations

There are  $8 \cdot 24 = 192$  automorphisms of equation (31.2.1) by compositions of *F*-homotopic and homographic transformations. Each is a substitution of dependent and/or independent variables that preserves the form of (31.2.1). Except for the identity automorphism, each alters the parameters.

## 31.3 Basic Solutions

### 31.3(i) Fuchs–Frobenius Solutions at $z = 0$

$H\ell(a, q; \alpha, \beta, \gamma, \delta; z)$  denotes the solution of (31.2.1) that corresponds to the exponent 0 at  $z = 0$  and assumes the value 1 there. If the other exponent is not a positive integer, that is, if  $\gamma \neq 0, -1, -2, \dots$ , then from §2.7(i) it follows that  $H\ell(a, q; \alpha, \beta, \gamma, \delta; z)$  exists, is analytic in the disk  $|z| < 1$ , and has the Maclaurin expansion

$$31.3.1 \quad H\ell(a, q; \alpha, \beta, \gamma, \delta; z) = \sum_{j=0}^{\infty} c_j z^j, \quad |z| < 1,$$

where  $c_0 = 1$ ,

$$31.3.2 \quad a\gamma c_1 - qc_0 = 0,$$

$$31.3.3 \quad R_j c_{j+1} - (Q_j + q)c_j + P_j c_{j-1} = 0, \quad j \geq 1,$$

with

$$P_j = (j - 1 + \alpha)(j - 1 + \beta),$$

$$31.3.4 \quad Q_j = j((j - 1 + \gamma)(1 + a) + a\delta + \epsilon),$$

$$R_j = a(j + 1)(j + \gamma).$$

Similarly, if  $\gamma \neq 1, 2, 3, \dots$ , then the solution of (31.2.1) that corresponds to the exponent  $1 - \gamma$  at  $z = 0$  is

$$31.3.5 \quad z^{1-\gamma} H\ell(a, (a\delta + \epsilon)(1 - \gamma) + q; \alpha + 1 - \gamma, \beta + 1 - \gamma, 2 - \gamma, \delta; z).$$

When  $\gamma \in \mathbb{Z}$ , linearly independent solutions can be constructed as in §2.7(i). In general, one of them has a logarithmic singularity at  $z = 0$ .

### 31.3(ii) Fuchs–Frobenius Solutions at Other Singularities

With similar restrictions to those given in §31.3(i), the following results apply. Solutions of (31.2.1) corresponding to the exponents 0 and  $1 - \delta$  at  $z = 1$  are respectively,

$$31.3.6 \quad H\ell(1 - a, \alpha\beta - q; \alpha, \beta, \delta, \gamma; 1 - z),$$

$$31.3.7 \quad (1 - z)^{1-\delta} H\ell(1 - a, ((1 - a)\gamma + \epsilon)(1 - \delta) + \alpha\beta - q; \alpha + 1 - \delta, \beta + 1 - \delta, 2 - \delta, \gamma; 1 - z).$$

Solutions of (31.2.1) corresponding to the exponents 0 and  $1 - \epsilon$  at  $z = a$  are respectively,

$$31.3.8 \quad H\ell\left(\frac{a}{a - 1}, \frac{\alpha\beta a - q}{a - 1}; \alpha, \beta, \epsilon, \delta; \frac{a - z}{a - 1}\right),$$

$$31.3.9 \quad \left(\frac{a - z}{a - 1}\right)^{1-\epsilon} H\ell\left(\frac{a}{a - 1}, \frac{(a(\delta + \gamma) - \gamma)(1 - \epsilon)}{a - 1} + \frac{\alpha\beta a - q}{a - 1}; \alpha + 1 - \epsilon, \beta + 1 - \epsilon, 2 - \epsilon, \delta; \frac{a - z}{a - 1}\right).$$



Solutions of (31.2.1) corresponding to the exponents  $\alpha$  and  $\beta$  at  $z = \infty$  are respectively,

$$31.3.10 \quad z^{-\alpha} \operatorname{Hl}\left(\frac{1}{a}, \alpha(\beta - \epsilon) + \frac{\alpha}{a}(\beta - \delta) - \frac{q}{a}; \alpha, \alpha - \gamma + 1, \alpha - \beta + 1, \delta; \frac{1}{z}\right),$$

$$31.3.11 \quad z^{-\beta} \operatorname{Hl}\left(\frac{1}{a}, \beta(\alpha - \epsilon) + \frac{\beta}{a}(\alpha - \delta) - \frac{q}{a}; \beta, \beta - \gamma + 1, \beta - \alpha + 1, \delta; \frac{1}{z}\right).$$

**31.3(iii) Equivalent Expressions**

Solutions (31.3.1) and (31.3.5)–(31.3.11) comprise a set of 8 local solutions of (31.2.1): 2 per singular point. Each is related to the solution (31.3.1) by one of the automorphisms of §31.2(v). There are 192 automorphisms in all, so there are  $192/8 = 24$  equivalent expressions for each of the 8. For example,  $\operatorname{Hl}(a, q; \alpha, \beta, \gamma, \delta; z)$  is equal to

$$31.3.12 \quad \operatorname{Hl}(1/a, q/a; \alpha, \beta, \gamma, \alpha + \beta + 1 - \gamma - \delta; z/a),$$

which arises from the homography  $\tilde{z} = z/a$ , and to

$$31.3.13 \quad (1 - z)^{-\alpha} \operatorname{Hl}\left(\frac{a}{a - 1}, -\frac{q - a\alpha\gamma}{a - 1}; \alpha, \alpha + 1 - \delta, \gamma, \alpha + 1 - \beta; \frac{z}{z - 1}\right),$$

which arises from  $\tilde{z} = z/(z - 1)$ , and also to 21 further expressions. The full set of 192 local solutions of (31.2.1), equivalent in 8 sets of 24, resembles Kummer’s set of 24 local solutions of the hypergeometric equation, which are equivalent in 4 sets of 6 solutions (§15.10(ii)); see Maier (2007).

**31.4 Solutions Analytic at Two Singularities: Heun Functions**

For an infinite set of discrete values  $q_m$ ,  $m = 0, 1, 2, \dots$ , of the accessory parameter  $q$ , the function  $\operatorname{Hl}(a, q; \alpha, \beta, \gamma, \delta; z)$  is analytic at  $z = 1$ , and hence also throughout the disk  $|z| < a$ . To emphasize this property this set of functions is denoted by

$$31.4.1 \quad (0, 1)\operatorname{Hf}_m(a, q_m; \alpha, \beta, \gamma, \delta; z), \quad m = 0, 1, 2, \dots$$

The eigenvalues  $q_m$  satisfy the continued-fraction equation

$$31.4.2 \quad q = \frac{a\gamma P_1}{Q_1 + q -} \frac{R_1 P_2}{Q_2 + q -} \frac{R_2 P_3}{Q_3 + q -} \dots,$$

in which  $P_j, Q_j, R_j$  are as in §31.3(i).

More generally,

$$31.4.3 \quad (s_1, s_2)\operatorname{Hf}_m(a, q_m; \alpha, \beta, \gamma, \delta; z), \quad m = 0, 1, 2, \dots,$$

with  $(s_1, s_2) \in \{0, 1, a, \infty\}$ , denotes a set of solutions of (31.2.1), each of which is analytic at  $s_1$  and  $s_2$ . The set  $q_m$  depends on the choice of  $s_1$  and  $s_2$ .

The solutions (31.4.3) are called the *Heun functions*. See Ronveaux (1995, pp. 39–41).

**31.5 Solutions Analytic at Three Singularities: Heun Polynomials**

Let  $\alpha = -n$ ,  $n = 0, 1, 2, \dots$ , and  $q_{n,m}$ ,  $m = 0, 1, \dots, n$ , be the eigenvalues of the tridiagonal matrix

$$31.5.1 \quad \begin{bmatrix} 0 & a\gamma & 0 & \dots & 0 \\ P_1 & -Q_1 & R_1 & \dots & 0 \\ 0 & P_2 & -Q_2 & & \vdots \\ \vdots & \vdots & & \ddots & R_{n-1} \\ 0 & 0 & \dots & P_n & -Q_n \end{bmatrix},$$

where  $P_j, Q_j, R_j$  are again defined as in §31.3(i). Then

$$31.5.2 \quad \operatorname{Hp}_{n,m}(a, q_{n,m}; -n, \beta, \gamma, \delta; z) = \operatorname{Hl}(a, q_{n,m}; -n, \beta, \gamma, \delta; z)$$

is a polynomial of degree  $n$ , and hence a solution of (31.2.1) that is analytic at all three finite singularities  $0, 1, a$ . These solutions are the *Heun polynomials*. Some properties are included as special cases of properties given in §31.15 below.

**31.6 Path-Multiplicative Solutions**

A further extension of the notation (31.4.1) and (31.4.3) is given by

$$31.6.1 \quad (s_1, s_2)\operatorname{Hf}_m^\nu(a, q_m; \alpha, \beta, \gamma, \delta; z), \quad m = 0, 1, 2, \dots,$$

with  $(s_1, s_2) \in \{0, 1, a\}$ , but with another set of  $\{q_m\}$ . This denotes a set of solutions of (31.2.1) with the property that if we pass around a simple closed contour in the  $z$ -plane that encircles  $s_1$  and  $s_2$  once in the positive sense, but not the remaining finite singularity, then the solution is multiplied by a constant factor  $e^{2\nu\pi i}$ . These solutions are called *path-multiplicative*. See Schmidt (1979).

### 31.7 Relations to Other Functions

#### 31.7(i) Reductions to the Gauss Hypergeometric Function

**31.7.1**

$$\begin{aligned} {}_2F_1(\alpha, \beta; \gamma; z) &= Hl(1, \alpha\beta; \alpha, \beta, \gamma, \delta; z) \\ &= Hl(0, 0; \alpha, \beta, \gamma, \alpha + \beta + 1 - \gamma; z) \\ &= Hl(a, a\alpha\beta; \alpha, \beta, \gamma, \alpha + \beta + 1 - \gamma; z). \end{aligned}$$

Other reductions of  $Hl$  to a  ${}_2F_1$ , with at least one free parameter, exist iff the pair  $(a, p)$  takes one of a finite

**31.7.4**

$$\begin{aligned} &Hl\left(\frac{1}{2} + i\frac{\sqrt{3}}{2}, \alpha\beta\left(\frac{1}{2} + i\frac{\sqrt{3}}{6}\right); \alpha, \beta, \frac{1}{3}(\alpha + \beta + 1), \frac{1}{3}(\alpha + \beta + 1); z\right) \\ &= {}_2F_1\left(\frac{1}{3}\alpha, \frac{1}{3}\beta; \frac{1}{3}(\alpha + \beta + 1); 1 - \left(1 - \left(\frac{3}{2} - i\frac{\sqrt{3}}{2}\right)z\right)^3\right). \end{aligned}$$

For additional reductions, see Maier (2005). Joyce (1994) gives a reduction in which the independent variable is transformed not polynomially or rationally, but algebraically.

#### 31.7(ii) Relations to Lamé Functions

With  $z = \text{sn}^2(\zeta, k)$  and

**31.7.5**

$$\begin{aligned} a &= k^{-2}, & q &= -\frac{1}{4}ah, & \alpha &= -\frac{1}{2}\nu, \\ \beta &= \frac{1}{2}(\nu + 1), & \gamma &= \delta = \epsilon = \frac{1}{2}, \end{aligned}$$

equation (31.2.1) becomes Lamé’s equation with independent variable  $\zeta$ ; compare (29.2.1) and (31.2.8). The solutions (31.3.1) and (31.3.5) transform into even and odd solutions of Lamé’s equation, respectively. Similar specializations of formulas in §31.3(ii) yield solutions in the neighborhoods of the singularities  $\zeta = K, K + iK',$  and  $iK',$  where  $K$  and  $K'$  are related to  $k$  as in §19.2(ii).

### 31.8 Solutions via Quadratures

For half-odd-integer values of the exponent parameters:

**31.8.1**

$$\begin{aligned} \beta - \alpha &= m_0 + \frac{1}{2}, & \gamma &= -m_1 + \frac{1}{2}, & \delta &= -m_2 + \frac{1}{2}, \\ \epsilon &= -m_3 + \frac{1}{2}, & m_0, m_1, m_2, m_3 &= 0, 1, 2, \dots, \end{aligned}$$

the Hermite–Darboux method (see Whittaker and Watson (1927, pp. 570–572)) can be applied to construct solutions of (31.2.1) expressed in quadratures, as follows.

Denote  $\mathbf{m} = (m_0, m_1, m_2, m_3)$  and  $\lambda = -4q$ . Then

**31.8.2**

$$\begin{aligned} &w_{\pm}(\mathbf{m}; \lambda; z) \\ &= \sqrt{\Psi_{g,N}(\lambda, z)} \\ &\times \exp\left(\pm \frac{i\nu(\lambda)}{2} \int_{z_0}^z \frac{t^{m_1}(t-1)^{m_2}(t-a)^{m_3} dt}{\Psi_{g,N}(\lambda, t)\sqrt{t(t-1)(t-a)}}\right) \end{aligned}$$

number of values, where  $q = \alpha\beta p$ . Below are three such reductions with three and two parameters. They are analogous to quadratic and cubic hypergeometric transformations (§§15.8(iii)–15.8(v)).

**31.7.2**

$$\begin{aligned} &Hl(2, \alpha\beta; \alpha, \beta, \gamma, \alpha + \beta - 2\gamma + 1; z) \\ &= {}_2F_1\left(\frac{1}{2}\alpha, \frac{1}{2}\beta; \gamma; 1 - (1 - z)^2\right), \end{aligned}$$

**31.7.3**

$$\begin{aligned} &Hl(4, \alpha\beta; \alpha, \beta, \frac{1}{2}, \frac{2}{3}(\alpha + \beta); z) \\ &= {}_2F_1\left(\frac{1}{3}\alpha, \frac{1}{3}\beta; \frac{1}{2}; 1 - (1 - z)^2(1 - \frac{1}{4}z)\right), \end{aligned}$$

are two independent solutions of (31.2.1). Here  $\Psi_{g,N}(\lambda, z)$  is a polynomial of degree  $g$  in  $\lambda$  and of degree  $N = m_0 + m_1 + m_2 + m_3$  in  $z$ , that is a solution of the third-order differential equation satisfied by a product of any two solutions of Heun’s equation. The degree  $g$  is given by

**31.8.3**

$$\begin{aligned} g &= \frac{1}{2} \max\left(2 \max_{0 \leq k \leq 3} m_k, 1 + N \right. \\ &\quad \left. - (1 + (-1)^N) \left(\frac{1}{2} + \min_{0 \leq k \leq 3} m_k\right)\right). \end{aligned}$$

The variables  $\lambda$  and  $\nu$  are two coordinates of the associated hyperelliptic (spectral) curve  $\Gamma : \nu^2 = \prod_{j=1}^{2g+1} (\lambda - \lambda_j)$ . (This  $\nu$  is unrelated to the  $\nu$  in §31.6.) Lastly,  $\lambda_j, j = 1, 2, \dots, 2g + 1,$  are the zeros of the Wronskian of  $w_+(\mathbf{m}; \lambda; z)$  and  $w_-(\mathbf{m}; \lambda; z)$ .

By automorphisms from §31.2(v), similar solutions also exist for  $m_0, m_1, m_2, m_3 \in \mathbb{Z}$ , and  $\Psi_{g,N}(\lambda, z)$  may become a rational function in  $z$ . For instance,

**31.8.4**

$$\begin{aligned} \Psi_{1,2} &= z^2 + \lambda z + a, & \nu^2 &= (\lambda + a + 1)(\lambda^2 - 4a), \\ & & \mathbf{m} &= (1, 1, 0, 0), \end{aligned}$$

and

**31.8.5**

$$\begin{aligned} \Psi_{1,-1} &= (z^3 + (\lambda + 3a + 3)z + a) / z^3, \\ \nu^2 &= (\lambda + 4a + 4)((\lambda + 3a + 3)^2 - 4a), \\ & \mathbf{m} = (1, -2, 0, 0). \end{aligned}$$

For  $\mathbf{m} = (m_0, 0, 0, 0)$ , these solutions reduce to Hermite’s solutions (Whittaker and Watson (1927, §23.7)) of the Lamé equation in its algebraic form. The curve  $\Gamma$  reflects the finite-gap property of Equation (31.2.1) when the exponent parameters satisfy (31.8.1) for  $m_j \in \mathbb{Z}$ . When  $\lambda = -4q$  approaches the ends of the gaps, the solution (31.8.2) becomes the corresponding Heun polynomial. For more details see Smirnov (2002).

The solutions in this section are finite-term Liouvillean solutions which can be constructed via Kovacic's algorithm; see §31.14(ii).

### 31.9 Orthogonality

#### 31.9(i) Single Orthogonality

With

$$31.9.1 \quad w_m(z) = (0, 1)Hf_m(a, q_m; \alpha, \beta, \gamma, \delta; z),$$

we have

$$31.9.2 \quad \int_{\zeta}^{(1+, 0+, 1-, 0-)} t^{\gamma-1}(1-t)^{\delta-1}(t-a)^{\epsilon-1} \times w_m(t)w_k(t) dt = \delta_{m,k}\theta_m.$$

Here  $\zeta$  is an arbitrary point in the interval  $(0, 1)$ . The integration path begins at  $z = \zeta$ , encircles  $z = 1$  once in the positive sense, followed by  $z = 0$  once in the positive sense, and so on, returning finally to  $z = \zeta$ . The integration path is called a *Pochhammer double-loop contour* (compare Figure 5.12.3). The branches of the many-valued functions are continuous on the path, and assume their principal values at the beginning.

The normalization constant  $\theta_m$  is given by

$$31.9.3 \quad \theta_m = (1 - e^{2\pi i \gamma})(1 - e^{2\pi i \delta})\zeta^{\gamma}(1 - \zeta)^{\delta}(\zeta - a)^{\epsilon} \times \frac{f_0(q, \zeta)}{f_1(q, \zeta)} \frac{\partial}{\partial q} \mathscr{W} \{f_0(q, \zeta), f_1(q, \zeta)\} \Big|_{q=q_m},$$

where

$$31.9.4 \quad \begin{aligned} f_0(q_m, z) &= H\ell(a, q_m; \alpha, \beta, \gamma, \delta; z), \\ f_1(q_m, z) &= H\ell(1 - a, \alpha\beta - q_m; \alpha, \beta, \delta, \gamma; 1 - z), \end{aligned}$$

and  $\mathscr{W}$  denotes the Wronskian (§1.13(i)). The right-hand side may be evaluated at any convenient value, or limiting value, of  $\zeta$  in  $(0, 1)$  since it is independent of  $\zeta$ .

For corresponding orthogonality relations for Heun functions (§31.4) and Heun polynomials (§31.5), see Lambe and Ward (1934), Erdélyi (1944), Sleeman (1966b), and Ronveaux (1995, Part A, pp. 59–64).

#### 31.9(ii) Double Orthogonality

Heun polynomials  $w_j = Hp_{n_j, m_j}$ ,  $j = 1, 2$ , satisfy

$$31.9.5 \quad \int_{\mathcal{L}_1} \int_{\mathcal{L}_2} \rho(s, t)w_1(s)w_1(t)w_2(s)w_2(t) ds dt = 0, \quad |n_1 - n_2| + |m_1 - m_2| \neq 0,$$

where

$$31.9.6 \quad \rho(s, t) = (s - t)(st)^{\gamma-1} ((s - 1)(t - 1))^{\delta-1} \times ((s - a)(t - a))^{\epsilon-1},$$

and the integration paths  $\mathcal{L}_1, \mathcal{L}_2$  are Pochhammer double-loop contours encircling distinct pairs of singularities  $\{0, 1\}, \{0, a\}, \{1, a\}$ .

For further information, including normalization constants, see Sleeman (1966b). For bi-orthogonal relations for path-multiplicative solutions see Schmidt (1979, §2.2). For other generalizations see Arscott (1964b, pp. 206–207 and 241).

### 31.10 Integral Equations and Representations

#### 31.10(i) Type I

If  $w(z)$  is a solution of Heun's equation, then another solution  $W(z)$  (possibly a multiple of  $w(z)$ ) can be represented as

$$31.10.1 \quad W(z) = \int_C \mathcal{K}(z, t)w(t)\rho(t) dt$$

for a suitable contour  $C$ . The weight function is given by

$$31.10.2 \quad \rho(t) = t^{\gamma-1}(t - 1)^{\delta-1}(t - a)^{\epsilon-1},$$

and the kernel  $\mathcal{K}(z, t)$  is a solution of the partial differential equation

$$31.10.3 \quad (\mathcal{D}_z - \mathcal{D}_t)\mathcal{K} = 0,$$

where  $\mathcal{D}_z$  is Heun's operator in the variable  $z$ :

$$31.10.4 \quad \mathcal{D}_z = z(z - 1)(z - a)(\partial^2/\partial z^2) + (\gamma(z - 1)(z - a) + \delta z(z - a) + \epsilon z(z - 1))(\partial/\partial z) + \alpha\beta z.$$

The contour  $C$  must be such that

$$31.10.5 \quad p(t) \left( \frac{\partial \mathcal{K}}{\partial t} w(t) - \mathcal{K} \frac{dw(t)}{dt} \right) \Big|_C = 0,$$

where

$$31.10.6 \quad p(t) = t^{\gamma}(t - 1)^{\delta}(t - a)^{\epsilon}.$$

### Kernel Functions

Set

$$31.10.7 \quad \cos \theta = \left( \frac{zt}{a} \right)^{1/2}, \quad \sin \theta \cos \phi = i \left( \frac{(z - a)(t - a)}{a(1 - a)} \right)^{1/2}, \quad \sin \theta \sin \phi = \left( \frac{(z - 1)(t - 1)}{1 - a} \right)^{1/2}.$$

The kernel  $\mathcal{K}$  must satisfy

$$31.10.8 \quad \sin^2 \theta \left( \frac{\partial^2 \mathcal{K}}{\partial \theta^2} + ((1-2\gamma) \tan \theta + 2(\delta + \epsilon - \frac{1}{2}) \cot \theta) \frac{\partial \mathcal{K}}{\partial \theta} - 4\alpha\beta\mathcal{K} \right) + \frac{\partial^2 \mathcal{K}}{\partial \phi^2} + ((1-2\delta) \cot \phi - (1-2\epsilon) \tan \phi) \frac{\partial \mathcal{K}}{\partial \phi} = 0.$$

The solutions of (31.10.8) are given in terms of the Riemann  $P$ -symbol (see §15.11(i)) as

$$31.10.9 \quad \mathcal{K}(\theta, \phi) = P \left\{ \begin{matrix} 0 & 1 & \infty \\ 0 & \frac{1}{2} - \delta - \sigma & \alpha \cos^2 \theta \\ 1 - \gamma & \frac{1}{2} - \epsilon + \sigma & \beta \end{matrix} \right\} P \left\{ \begin{matrix} 0 & 1 & \infty \\ 0 & 0 & -\frac{1}{2} + \delta + \sigma \cos^2 \phi \\ 1 - \epsilon & 1 - \delta & -\frac{1}{2} + \epsilon - \sigma \end{matrix} \right\},$$

where  $\sigma$  is a separation constant. For integral equations satisfied by the Heun polynomial  $Hp_{n,m}(z)$  we have  $\sigma = \frac{1}{2} - \delta - j$ ,  $j = 0, 1, \dots, n$ .

For suitable choices of the branches of the  $P$ -symbols in (31.10.9) and the contour  $C$ , we can obtain both integral equations satisfied by Heun functions, as well as the integral representations of a distinct solution of Heun's equation in terms of a Heun function (polynomial, path-multiplicative solution).

**Example 1**

Let

**31.10.10**

$$\mathcal{K}(z, t) = (zt - a)^{\frac{1}{2} - \delta - \sigma} {}_2F_1 \left( \begin{matrix} \frac{1}{2} - \delta - \sigma + \alpha, \frac{1}{2} - \delta - \sigma + \beta \\ \gamma \end{matrix}; \frac{zt}{a} \right) {}_2F_1 \left( \begin{matrix} -\frac{1}{2} + \delta + \sigma, -\frac{1}{2} + \epsilon - \sigma \\ \delta \end{matrix}; \frac{a(z-1)(t-1)}{(a-1)(zt-a)} \right),$$

where  $\Re\gamma > 0$ ,  $\Re\delta > 0$ , and  $C$  be the Pochhammer double-loop contour about 0 and 1 (as in §31.9(i)). Then the integral equation (31.10.1) is satisfied by  $w(z) = w_m(z)$  and  $W(z) = \kappa_m w_m(z)$ , where  $w_m(z) = (0, 1)Hf_m(a, q_m; \alpha, \beta, \gamma, \delta; z)$  and  $\kappa_m$  is the corresponding eigenvalue.

**Example 2**

Fuchs–Frobenius solutions  $W_m(z) = \tilde{\kappa}_m z^{-\alpha} H\ell(1/a, q_m; \alpha, \alpha - \gamma + 1, \alpha - \beta + 1, \delta; 1/z)$  are represented in terms of Heun functions  $w_m(z) = (0, 1)Hf_m(a, q_m; \alpha, \beta, \gamma, \delta; z)$  by (31.10.1) with  $W(z) = W_m(z)$ ,  $w(z) = w_m(z)$ , and with kernel chosen from

$$31.10.11 \quad \mathcal{K}(z, t) = (zt - a)^{\frac{1}{2} - \delta - \sigma} (zt/a)^{-\frac{1}{2} + \delta + \sigma - \alpha} {}_2F_1 \left( \begin{matrix} \frac{1}{2} - \delta - \sigma + \alpha, \frac{3}{2} - \delta - \sigma + \alpha - \gamma \\ \alpha - \beta + 1 \end{matrix}; \frac{a}{zt} \right) \\ \times P \left\{ \begin{matrix} 0 & 1 & \infty \\ 0 & 0 & -\frac{1}{2} + \delta + \sigma \frac{(z-a)(t-a)}{(1-a)(zt-a)} \\ 1 - \epsilon & 1 - \delta & -\frac{1}{2} + \epsilon - \sigma \end{matrix} \right\}.$$

Here  $\tilde{\kappa}_m$  is a normalization constant and  $C$  is the contour of Example 1.

**31.10(ii) Type II**

If  $w(z)$  is a solution of Heun's equation, then another solution  $W(z)$  (possibly a multiple of  $w(z)$ ) can be represented as

$$31.10.12 \quad W(z) = \int_{C_1} \int_{C_2} \mathcal{K}(z; s, t) w(s) w(t) \rho(s, t) ds dt$$

for suitable contours  $C_1, C_2$ . The weight function is

$$31.10.13 \quad \rho(s, t) = (s-t)(st)^{\gamma-1} ((1-s)(1-t))^{\delta-1} \\ \times ((1-s/a)(1-t/a))^{\epsilon-1},$$

and the kernel  $\mathcal{K}(z; s, t)$  is a solution of the partial differential equation

$$31.10.14 \quad ((t-z)D_s + (z-s)D_t + (s-t)D_z) \mathcal{K} = 0,$$

where  $D_z$  is given by (31.10.4). The contours  $C_1, C_2$  must be chosen so that

$$31.10.15 \quad p(t) \left( \frac{\partial \mathcal{K}}{\partial t} w(t) - \mathcal{K} \frac{dw(t)}{dt} \right) \Big|_{C_1} = 0,$$

and

$$31.10.16 \quad p(s) \left( \frac{\partial \mathcal{K}}{\partial s} w(s) - \mathcal{K} \frac{dw(s)}{ds} \right) \Big|_{C_2} = 0,$$

where  $p(t)$  is given by (31.10.6).

**Kernel Functions**

Set

**31.10.17**

$$u = \frac{(stz)^{1/2}}{a}, \quad v = \left( \frac{(s-1)(t-1)(z-1)}{1-a} \right)^{1/2},$$

$$w = i \left( \frac{(s-a)(t-a)(z-a)}{a(1-a)} \right)^{1/2}.$$

The kernel  $\mathcal{K}$  must satisfy

**31.10.18**

$$\frac{\partial^2 \mathcal{K}}{\partial u^2} + \frac{\partial^2 \mathcal{K}}{\partial v^2} + \frac{\partial^2 \mathcal{K}}{\partial w^2} + \frac{2\gamma - 1}{u} \frac{\partial \mathcal{K}}{\partial u} + \frac{2\delta - 1}{v} \frac{\partial \mathcal{K}}{\partial v} + \frac{2\epsilon - 1}{w} \frac{\partial \mathcal{K}}{\partial w} = 0.$$

This equation can be solved in terms of cylinder functions  $\mathcal{C}_\nu(z)$  (§10.2(ii)):

**31.10.19**

$$\mathcal{K}(u, v, w) = u^{1-\gamma} v^{1-\delta} w^{1-\epsilon} \mathcal{C}_{1-\gamma}(u\sqrt{\sigma_1}) \times \mathcal{C}_{1-\delta}(v\sqrt{\sigma_2}) \mathcal{C}_{1-\epsilon}(iw\sqrt{\sigma_1 + \sigma_2}),$$

where  $\sigma_1$  and  $\sigma_2$  are separation constants.

**Transformation of Independent Variable**

A further change of variables, to spherical coordinates,

**31.10.20**

$$u = r \cos \theta, \quad v = r \sin \theta \sin \phi, \quad w = r \sin \theta \cos \phi,$$

leads to the kernel equation

**31.10.21**

$$\frac{\partial^2 \mathcal{K}}{\partial r^2} + \frac{2(\gamma + \delta + \epsilon) - 1}{r} \frac{\partial \mathcal{K}}{\partial r} + \frac{1}{r^2} \frac{\partial^2 \mathcal{K}}{\partial \theta^2} + \frac{(2(\delta + \epsilon) - 1) \cot \theta - (2\gamma - 1) \tan \theta}{r^2} \frac{\partial \mathcal{K}}{\partial \theta} + \frac{1}{r^2 \sin^2 \theta} \frac{\partial^2 \mathcal{K}}{\partial \phi^2} + \frac{(2\delta - 1) \cot \phi - (2\epsilon - 1) \tan \phi}{r^2 \sin^2 \theta} \frac{\partial \mathcal{K}}{\partial \phi} = 0.$$

This equation can be solved in terms of hypergeometric functions (§15.11(i)):

**31.10.22**

$$\mathcal{K}(r, \theta, \phi) = r^m \sin^{2p} \theta P \left\{ \begin{matrix} 0 & 1 & \infty \\ 0 & 0 & a \\ \frac{1}{2}(3-\gamma) & c & b \end{matrix} \right\} \times P \left\{ \begin{matrix} 0 & 1 & \infty \\ 0 & 0 & a' \\ 1-\epsilon & 1-\delta & b' \end{matrix} \right\},$$

with

$$m^2 + 2(\alpha + \beta)m - \sigma_1 = 0,$$

$$p^2 + (\alpha + \beta - \gamma - \frac{1}{2})p - \frac{1}{4}\sigma_2 = 0,$$

$$a + b = 2(\alpha + \beta + p) - 1,$$

**31.10.23**

$$ab = p^2 - p(1 - \alpha - \beta) - \frac{1}{4}\sigma_1,$$

$$c = \gamma - \frac{1}{2} - 2(\alpha + \beta + p),$$

$$a' + b' = \delta + \epsilon - 1, \quad a'b' = -\frac{1}{4}\sigma_2,$$

and  $\sigma_1$  and  $\sigma_2$  are separation constants.

For integral equations for special confluent Heun functions (§31.12) see Kazakov and Slavyanov (1996).

**31.11 Expansions in Series of Hypergeometric Functions**

**31.11(i) Introduction**

The formulas in this section are given in Svartholm (1939) and Erdélyi (1942a, 1944).

The series of Type I (§31.11(iii)) are useful since they represent the functions in large domains. Series of Type II (§31.11(iv)) are expansions in orthogonal polynomials, which are useful in calculations of normalization integrals for Heun functions; see Erdélyi (1944) and §31.9(i).

For other expansions see §31.16(ii).

**31.11(ii) General Form**

Let  $w(z)$  be any Fuchs–Frobenius solution of Heun’s equation. Expand

**31.11.1**

$$w(z) = \sum_{j=0}^{\infty} c_j P_j,$$

where (§15.11(i))

**31.11.2**

$$P_j = P \left\{ \begin{matrix} 0 & 1 & \infty \\ 0 & 0 & \lambda + j \\ 1 - \gamma & 1 - \delta & \mu - j \end{matrix} \right\} z,$$

with

**31.11.3**

$$\lambda + \mu = \gamma + \delta - 1 = \alpha + \beta - \epsilon.$$

The coefficients  $c_j$  satisfy the equations

**31.11.4**

$$L_0 c_0 + M_0 c_1 = 0,$$

**31.11.5**

$$K_j c_{j-1} + L_j c_j + M_j c_{j+1} = 0, \quad j = 1, 2, \dots,$$

where

**31.11.6**

$$K_j = -\frac{(j + \alpha - \mu - 1)(j + \beta - \mu - 1)(j + \gamma - \mu - 1)(j + \lambda - 1)}{(2j + \lambda - \mu - 1)(2j + \lambda - \mu - 2)},$$

$$L_j = a(\lambda + j)(\mu - j) - q + \frac{(j + \alpha - \mu)(j + \beta - \mu)(j + \gamma - \mu)(j + \lambda)}{(2j + \lambda - \mu)(2j + \lambda - \mu + 1)} \\ + \frac{(j - \alpha + \lambda)(j - \beta + \lambda)(j - \gamma + \lambda)(j - \mu)}{(2j + \lambda - \mu)(2j + \lambda - \mu - 1)},$$

31.11.7

$$M_j = -\frac{(j - \alpha + \lambda + 1)(j - \beta + \lambda + 1)(j - \gamma + \lambda + 1)(j - \mu + 1)}{(2j + \lambda - \mu + 1)(2j + \lambda - \mu + 2)}.$$

31.11.8

$\lambda, \mu$  must also satisfy the condition

$$31.11.9 \quad M_{-1}P_{-1} = 0.$$

### 31.11(iii) Type I

Here

$$31.11.10 \quad \lambda = \alpha, \quad \mu = \beta - \epsilon,$$

or

$$31.11.11 \quad \lambda = \beta, \quad \mu = \alpha - \epsilon.$$

Then condition (31.11.9) is satisfied.

Every Fuchs–Frobenius solution of Heun's equation (31.2.1) can be represented by a series of Type I. For instance, choose (31.11.10). Then the Fuchs–Frobenius solution at  $\infty$  belonging to the exponent  $\alpha$  has the expansion (31.11.1) with

$$31.11.12 \quad P_j = \frac{\Gamma(\alpha + j)\Gamma(1 - \gamma + \alpha + j)}{\Gamma(1 + \alpha - \beta + \epsilon + 2j)} z^{-\alpha-j} \\ \times {}_2F_1\left(\alpha + j, 1 - \gamma + \alpha + j; 1 + \alpha - \beta + \epsilon + 2j; \frac{1}{z}\right),$$

and (31.11.1) converges outside the ellipse  $\mathcal{E}$  in the  $z$ -plane with foci at 0, 1, and passing through the third finite singularity at  $z = a$ .

Every Heun function (§31.4) can be represented by a series of Type I convergent in the whole plane cut along a line joining the two singularities of the Heun function.

For example, consider the Heun function which is analytic at  $z = a$  and has exponent  $\alpha$  at  $\infty$ . The expansion (31.11.1) with (31.11.12) is convergent in the plane cut along the line joining the two singularities  $z = 0$  and  $z = 1$ . In this case the accessory parameter  $q$  is a root of the continued-fraction equation

$$31.11.13 \quad (L_0/M_0) - \frac{K_1/M_1}{L_1/M_1 - \frac{K_2/M_2}{L_2/M_2 - \dots}} = 0.$$

The case  $\alpha = -n$  for nonnegative integer  $n$  corresponds to the Heun polynomial  $Hp_{n,m}(z)$ .

The expansion (31.11.1) for a Heun function that is associated with any branch of (31.11.2)—other than a multiple of the right-hand side of (31.11.12)—is convergent inside the ellipse  $\mathcal{E}$ .

### 31.11(iv) Type II

Here one of the following four pairs of conditions is satisfied:

$$31.11.14 \quad \lambda = \gamma + \delta - 1, \quad \mu = 0,$$

$$31.11.15 \quad \lambda = \gamma, \quad \mu = \delta - 1,$$

$$31.11.16 \quad \lambda = \delta, \quad \mu = \gamma - 1,$$

$$31.11.17 \quad \lambda = 1, \quad \mu = \gamma + \delta - 2.$$

In each case  $P_j$  can be expressed in terms of a Jacobi polynomial (§18.3). Such series diverge for Fuchs–Frobenius solutions. For Heun functions they are convergent inside the ellipse  $\mathcal{E}$ . Every Heun function can be represented by a series of Type II.

### 31.11(v) Doubly-Infinite Series

Schmidt (1979) gives expansions of path-multiplicative solutions (§31.6) in terms of doubly-infinite series of hypergeometric functions.

## 31.12 Confluent Forms of Heun's Equation

Confluent forms of Heun's differential equation (31.2.1) arise when two or more of the regular singularities merge to form an irregular singularity. This is analogous to the derivation of the confluent hypergeometric equation from the hypergeometric equation in §13.2(i). There are four standard forms, as follows:

#### Confluent Heun Equation

$$31.12.1 \quad \frac{d^2w}{dz^2} + \left(\frac{\gamma}{z} + \frac{\delta}{z-1} + \epsilon\right) \frac{dw}{dz} + \frac{\alpha z - q}{z(z-1)} w = 0.$$

This has regular singularities at  $z = 0$  and 1, and an irregular singularity of rank 1 at  $z = \infty$ .

Mathieu functions (Chapter 28), spheroidal wave functions (Chapter 30), and Coulomb spheroidal functions (§30.12) are special cases of solutions of the confluent Heun equation.

#### Doubly-Confluent Heun Equation

$$31.12.2 \quad \frac{d^2w}{dz^2} + \left(\frac{\delta}{z^2} + \frac{\gamma}{z} + 1\right) \frac{dw}{dz} + \frac{\alpha z - q}{z^2} w = 0.$$

This has irregular singularities at  $z = 0$  and  $\infty$ , each of rank 1.

**Biconfluent Heun Equation**

**31.12.3**  $\frac{d^2w}{dz^2} + \left(\frac{\gamma}{z} + \delta + z\right) \frac{dw}{dz} + \frac{\alpha z - q}{z} w = 0.$

This has a regular singularity at  $z = 0$ , and an irregular singularity at  $\infty$  of rank 2.

**Triconfluent Heun Equation**

**31.12.4**  $\frac{d^2w}{dz^2} + (\gamma + z) z \frac{dw}{dz} + (\alpha z - q) w = 0.$

This has one singularity, an irregular singularity of rank 3 at  $z = \infty$ .

For properties of the solutions of (31.12.1)–(31.12.4), including connection formulas, see Bühring (1994), Ronveaux (1995, Parts B,C,D,E), Wolf (1998), Lay and Slavyanov (1998), and Slavyanov and Lay (2000).

**31.13 Asymptotic Approximations**

For asymptotic approximations for the accessory parameter eigenvalues  $q_m$ , see Fedoryuk (1991) and Slavyanov (1996).

For asymptotic approximations of the solutions of Heun’s equation (31.2.1) when two singularities are close together, see Lay and Slavyanov (1999).

For asymptotic approximations of the solutions of confluent forms of Heun’s equation in the neighborhood of irregular singularities, see Komarov *et al.* (1976), Ronveaux (1995, Parts B,C,D,E), Bogush and Otchik (1997), Slavyanov and Veshev (1997), and Lay *et al.* (1998).

**31.14 General Fuchsian Equation**

**31.14(i) Definitions**

The general second-order *Fuchsian equation* with  $N + 1$  regular singularities at  $z = a_j, j = 1, 2, \dots, N$ , and at  $\infty$ , is given by

**31.14.1** 
$$\frac{d^2w}{dz^2} + \left(\sum_{j=1}^N \frac{\gamma_j}{z - a_j}\right) \frac{dw}{dz} + \left(\sum_{j=1}^N \frac{q_j}{z - a_j}\right) w = 0,$$

$$\sum_{j=1}^N q_j = 0.$$

The exponents at the finite singularities  $a_j$  are  $\{0, 1 - \gamma_j\}$  and those at  $\infty$  are  $\{\alpha, \beta\}$ , where

**31.14.2**  $\alpha + \beta + 1 = \sum_{j=1}^N \gamma_j, \quad \alpha\beta = \sum_{j=1}^N a_j q_j.$

The three sets of parameters comprise the *singularity parameters*  $a_j$ , the *exponent parameters*  $\alpha, \beta, \gamma_j$ , and the  $N - 2$  free *accessory parameters*  $q_j$ . With  $a_1 = 0$  and  $a_2 = 1$  the total number of free parameters is  $3N - 3$ . Heun’s equation (31.2.1) corresponds to  $N = 3$ .

**Normal Form**

**31.14.3**  $w(z) = \left(\prod_{j=1}^N (z - a_j)^{-\gamma_j/2}\right) W(z),$

**31.14.4**

$\frac{d^2W}{dz^2} = \sum_{j=1}^N \left(\frac{\tilde{\gamma}_j}{(z - a_j)^2} + \frac{\tilde{q}_j}{z - a_j}\right) W, \quad \sum_{j=1}^N \tilde{q}_j = 0,$

**31.14.5**  $\tilde{q}_j = \frac{1}{2} \sum_{\substack{k=1 \\ k \neq j}}^N \frac{\gamma_j \gamma_k}{a_j - a_k} - q_j, \quad \tilde{\gamma}_j = \frac{\gamma_j}{2} \left(\frac{\gamma_j}{2} - 1\right).$

**31.14(ii) Kovacic’s Algorithm**

An algorithm given in Kovacic (1986) determines if a given (not necessarily Fuchsian) second-order homogeneous linear differential equation with rational coefficients has solutions expressible in finite terms (Liouvillian solutions). The algorithm returns a list of solutions if they exist.

For applications of Kovacic’s algorithm in spatio-temporal dynamics see Rod and Sleeman (1995).

**31.15 Stieltjes Polynomials**

**31.15(i) Definitions**

Stieltjes polynomials are polynomial solutions of the Fuchsian equation (31.14.1). Rewrite (31.14.1) in the form

**31.15.1** 
$$\frac{d^2w}{dz^2} + \left(\sum_{j=1}^N \frac{\gamma_j}{z - a_j}\right) \frac{dw}{dz} + \frac{\Phi(z)}{\prod_{j=1}^N (z - a_j)} w = 0,$$

where  $\Phi(z)$  is a polynomial of degree not exceeding  $N - 2$ . There exist at most  $\binom{n+N-2}{N-2}$  polynomials  $V(z)$  of degree not exceeding  $N - 2$  such that for  $\Phi(z) = V(z)$ , (31.15.1) has a polynomial solution  $w = S(z)$  of degree  $n$ . The  $V(z)$  are called *Van Vleck polynomials* and the corresponding  $S(z)$  *Stieltjes polynomials*.

**31.15(ii) Zeros**

If  $z_1, z_2, \dots, z_n$  are the zeros of an  $n$ th degree Stieltjes polynomial  $S(z)$ , then every zero  $z_k$  is either one of the parameters  $a_j$  or a solution of the system of equations

**31.15.2** 
$$\sum_{j=1}^N \frac{\gamma_j/2}{z_k - a_j} + \sum_{\substack{j=1 \\ j \neq k}}^n \frac{1}{z_k - z_j} = 0, \quad k = 1, 2, \dots, n.$$

If  $t_k$  is a zero of the Van Vleck polynomial  $V(z)$ , corresponding to an  $n$ th degree Stieltjes polynomial  $S(z)$ , and  $z'_1, z'_2, \dots, z'_{n-1}$  are the zeros of  $S'(z)$  (the derivative

of  $S(z)$ ), then  $t_k$  is either a zero of  $S'(z)$  or a solution of the equation

$$31.15.3 \quad \sum_{j=1}^N \frac{\gamma_j}{t_k - a_j} + \sum_{j=1}^{n-1} \frac{1}{t_k - z'_j} = 0.$$

The system (31.15.2) determines the  $z_k$  as the points of equilibrium of  $n$  movable (interacting) particles with unit charges in a field of  $N$  particles with the charges  $\gamma_j/2$  fixed at  $a_j$ . This is the *Stieltjes electrostatic interpretation*.

The zeros  $z_k$ ,  $k = 1, 2, \dots, n$ , of the Stieltjes polynomial  $S(z)$  are the critical points of the function  $G$ , that is, points at which  $\partial G/\partial \zeta_k = 0$ ,  $k = 1, 2, \dots, n$ , where

$$31.15.4 \quad \begin{aligned} &G(\zeta_1, \zeta_2, \dots, \zeta_n) \\ &= \prod_{k=1}^n \prod_{\ell=1}^N (\zeta_k - a_\ell)^{\gamma_\ell/2} \prod_{j=k+1}^n (\zeta_k - \zeta_j). \end{aligned}$$

If the following conditions are satisfied:

$$31.15.5 \quad \gamma_j > 0, \quad a_j \in \mathbb{R}, \quad j = 1, 2, \dots, N,$$

and

$$31.15.6 \quad a_j < a_{j+1}, \quad j = 1, 2, \dots, N - 1,$$

then there are *exactly*  $\binom{n+N-2}{N-2}$  polynomials  $S(z)$ , each of which corresponds to each of the  $\binom{n+N-2}{N-2}$  ways of distributing its  $n$  zeros among  $N - 1$  intervals  $(a_j, a_{j+1})$ ,  $j = 1, 2, \dots, N - 1$ . In this case the accessory parameters  $q_j$  are given by

$$31.15.7 \quad q_j = \gamma_j \sum_{k=1}^n \frac{1}{z_k - a_j}, \quad j = 1, 2, \dots, N.$$

See Marden (1966), Alam (1979), and Al-Rashed and Zaheer (1985) for further results on the location of the zeros of Stieltjes and Van Vleck polynomials.

### 31.15(iii) Products of Stieltjes Polynomials

If the exponent and singularity parameters satisfy (31.15.5)–(31.15.6), then for every multi-index  $\mathbf{m} = (m_1, m_2, \dots, m_{N-1})$ , where each  $m_j$  is a nonnegative integer, there is a unique Stieltjes polynomial with  $m_j$  zeros in the open interval  $(a_j, a_{j+1})$  for each  $j = 1, 2, \dots, N - 1$ . We denote this Stieltjes polynomial by  $S_{\mathbf{m}}(z)$ .

Let  $S_{\mathbf{m}}(z)$  and  $S_{\mathbf{l}}(z)$  be Stieltjes polynomials corresponding to two distinct multi-indices  $\mathbf{m} = (m_1, m_2, \dots, m_{N-1})$  and  $\mathbf{l} = (\ell_1, \ell_2, \dots, \ell_{N-1})$ . The products

$$31.15.8 \quad S_{\mathbf{m}}(z_1)S_{\mathbf{m}}(z_2) \cdots S_{\mathbf{m}}(z_{N-1}), \quad z_j \in (a_j, a_{j+1}),$$

$$31.15.9 \quad S_{\mathbf{l}}(z_1)S_{\mathbf{l}}(z_2) \cdots S_{\mathbf{l}}(z_{N-1}), \quad z_j \in (a_j, a_{j+1}),$$

are mutually orthogonal over the set  $Q$ :

$$31.15.10 \quad Q = (a_1, a_2) \times (a_2, a_3) \times \cdots \times (a_{N-1}, a_N),$$

with respect to the inner product

$$31.15.11 \quad (f, g)_\rho = \int_Q f(z)\bar{g}(z)\rho(z) dz,$$

with weight function

$$31.15.12 \quad \rho(z) = \left( \prod_{j=1}^{N-1} \prod_{k=1}^N |z_j - a_k|^{\gamma_k-1} \right) \left( \prod_{j<k}^{N-1} (z_k - z_j) \right).$$

The normalized system of products (31.15.8) forms an orthonormal basis in the Hilbert space  $L^2_\rho(Q)$ . For further details and for the expansions of analytic functions in this basis see Volkmer (1999).

## Applications

### 31.16 Mathematical Applications

#### 31.16(i) Uniformization Problem for Heun's Equation

The main part of Smirnov (1996) consists of V. I. Smirnov's 1918 M. Sc. thesis "Inversion problem for a second-order linear differential equation with four singular points". It describes the monodromy group of Heun's equation for specific values of the accessory parameter.

#### 31.16(ii) Heun Polynomial Products

Expansions of Heun polynomial products in terms of Jacobi polynomial (§18.3) products are derived in Kalnins and Miller (1991a,b, 1993) from the viewpoint of interrelation between two bases in a Hilbert space:

$$31.16.1 \quad \begin{aligned} &Hp_{n,m}(x)Hp_{n,m}(y) \\ &= \sum_{j=0}^n A_j \sin^{2j} \theta \\ &\quad \times P_{n-j}^{(\gamma+\delta+2j-1, \epsilon-1)}(\cos 2\theta) P_j^{(\delta-1, \gamma-1)}(\cos 2\phi), \end{aligned}$$

where  $n = 0, 1, \dots, m = 0, 1, \dots, n$ , and

$$31.16.2 \quad x = \sin^2 \theta \cos^2 \phi, \quad y = \sin^2 \theta \sin^2 \phi.$$

The coefficients  $A_j$  satisfy the relations:

$$31.16.3 \quad Q_0 A_0 + R_0 A_1 = 0,$$

$$31.16.4 \quad P_j A_{j-1} + Q_j A_j + R_j A_{j+1} = 0, \quad j = 1, 2, \dots, n,$$

where



$$\begin{aligned}
 31.16.5 \quad P_j &= \frac{(\epsilon - j + n)j(\beta + j - 1)(\gamma + \delta + j - 2)}{(\gamma + \delta + 2j - 3)(\gamma + \delta + 2j - 2)}, \\
 31.16.6 \quad Q_j &= -aj(j + \gamma + \delta - 1) - q + \frac{(j - n)(j + \beta)(j + \gamma)(j + \gamma + \delta - 1)}{(2j + \gamma + \delta)(2j + \gamma + \delta - 1)} \\
 &\quad + \frac{(j + n + \gamma + \delta - 1)j(j + \delta - 1)(j - \beta + \gamma + \delta - 1)}{(2j + \gamma + \delta - 1)(2j + \gamma + \delta - 2)}, \\
 31.16.7 \quad R_j &= \frac{(n - j)(j + n + \gamma + \delta)(j + \gamma)(j + \delta)}{(\gamma + \delta + 2j)(\gamma + \delta + 2j + 1)}.
 \end{aligned}$$

By specifying either  $\theta$  or  $\phi$  in (31.16.1) and (31.16.2) we obtain expansions in terms of one variable.

## 31.17 Physical Applications

### 31.17(i) Addition of Three Quantum Spins

The problem of adding three quantum spins  $\mathbf{s}$ ,  $\mathbf{t}$ , and  $\mathbf{u}$  can be solved by the *method of separation of variables*, and the solution is given in terms of a product of two Heun functions. We use vector notation  $[\mathbf{s}, \mathbf{t}, \mathbf{u}]$  (respective scalar  $(s, t, u)$ ) for any one of the three spin operators (respective spin values).

Consider the following spectral problem on the sphere  $S_2$ :  $\mathbf{x}^2 = x_s^2 + x_t^2 + x_u^2 = R^2$ .

#### 31.17.1

$$\begin{aligned}
 \mathbf{J}^2 \Psi(\mathbf{x}) &\equiv (\mathbf{s} + \mathbf{t} + \mathbf{u})^2 \Psi(\mathbf{x}) = j(j + 1) \Psi(\mathbf{x}), \\
 H_s \Psi(\mathbf{x}) &\equiv (-2\mathbf{s} \cdot \mathbf{t} - (2/a)\mathbf{s} \cdot \mathbf{u}) \Psi(\mathbf{x}) = h_s \Psi(\mathbf{x}),
 \end{aligned}$$

for the common eigenfunction  $\Psi(\mathbf{x}) = \Psi(x_s, x_t, x_u)$ , where  $a$  is the coupling parameter of interacting spins. Introduce elliptic coordinates  $z_1$  and  $z_2$  on  $S_2$ . Then

$$31.17.2 \quad \frac{x_s^2}{z_k} + \frac{x_t^2}{z_k - 1} + \frac{x_u^2}{z_k - a} = 0, \quad k = 1, 2,$$

with

$$\begin{aligned}
 31.17.3 \quad x_s^2 &= R^2 \frac{z_1 z_2}{a}, \quad x_t^2 = R^2 \frac{(z_1 - 1)(z_2 - 1)}{1 - a}, \\
 x_u^2 &= R^2 \frac{(z_1 - a)(z_2 - a)}{a(a - 1)}.
 \end{aligned}$$

The operators  $\mathbf{J}^2$  and  $H_s$  admit separation of variables in  $z_1, z_2$ , leading to the following factorization of the eigenfunction  $\Psi(\mathbf{x})$ :

$$31.17.4 \quad \Psi(\mathbf{x}) = (z_1 z_2)^{-s - \frac{1}{4}} ((z_1 - 1)(z_2 - 1))^{-t - \frac{1}{4}} \\
 \times ((z_1 - a)(z_2 - a))^{-u - \frac{1}{4}} w(z_1) w(z_2),$$

where  $w(z)$  satisfies Heun's equation (31.2.1) with  $a$  as in (31.17.1) and the other parameters given by

$$\begin{aligned}
 31.17.5 \quad \alpha &= -s - t - u - j - 1, \quad \beta = j - s - t - u, \quad \gamma = -2s, \\
 \delta &= -2t, \quad \epsilon = -2u; \quad q = ah_s + 2s(at + u).
 \end{aligned}$$

For more details about the method of separation of variables and relation to special functions see Olevskiĭ (1950), Kalnins *et al.* (1976), Miller (1977), and Kalnins (1986).

### 31.17(ii) Other Applications

Heun functions appear in the theory of black holes (Kerr (1963), Teukolsky (1972), Chandrasekhar (1984), Suzuki *et al.* (1998), Kalnins *et al.* (2000)), lattice systems in statistical mechanics (Joyce (1973, 1994)), dislocation theory (Lay and Slavyanov (1999)), and quantum systems (Bay *et al.* (1997), Tolstikhin and Matsuzawa (2001)).

For applications of Heun's equation and functions in astrophysics see Debosscher (1998) where different spectral problems for Heun's equation are also considered. More applications—including those of generalized spheroidal wave functions and confluent Heun functions in mathematical physics, astrophysics, and the two-center problem in molecular quantum mechanics—can be found in Leaver (1986) and Slavyanov and Lay (2000, Chapter 4). For application of biconfluent Heun functions in a model of an equatorially trapped Rossby wave in a shear flow in the ocean or atmosphere see Boyd and Natarov (1998).

## Computation

### 31.18 Methods of Computation

Independent solutions of (31.2.1) can be computed in the neighborhoods of singularities from their Fuchs–Frobenius expansions (§31.3), and elsewhere by numerical integration of (31.2.1). Subsequently, the coefficients in the necessary connection formulas can be calculated numerically by matching the values of solutions and their derivatives at suitably chosen values of  $z$ ; see Laĭ (1994) and Lay *et al.* (1998). Care needs to be taken to choose integration paths in such a way that the wanted solution is growing in magnitude along the path at least as rapidly as all other solutions (§3.7(ii)). The

computation of the accessory parameter for the Heun functions is carried out via the continued-fraction equations (31.4.2) and (31.11.13) in the same way as for the Mathieu, Lamé, and spheroidal wave functions in Chapters 28–30.

## References

### General References

The main references used in writing this chapter are Sleeman (1966b) and Ronveaux (1995). For additional bibliographic reading see Erdélyi *et al.* (1955).

### Sources

The following list gives the references or other indications of proofs that were used in constructing the various sections of this chapter. These sources supplement the references that are quoted in the text.

- §31.2 Erdélyi *et al.* (1955, Chapter XV), Ronveaux (1995, Part A, Chapters 1 and 2).
- §31.3 Snow (1952), Ronveaux (1995, Part A, Chapters 2 and 3).
- §31.4 Erdélyi *et al.* (1955, Chapter XV), Arscott (1964b, Chapter IX).
- §31.5 Erdélyi *et al.* (1955, Chapter XV), Arscott (1964b, Chapter IX).
- §31.7 Ronveaux (1995, Part A, Chapter 1).
- §31.9 Becker (1997).
- §31.10 Lambe and Ward (1934) Erdélyi (1942b), Valent (1986), Sleeman (1969), An error in the last reference is corrected here.
- §31.12 The process of confluence is discussed in Ince (1926, Chapter XX). See Decarreau *et al.* (1978a,b) for the classification of confluent forms.
- §31.14 Ince (1926, Chapter XV).
- §31.15 Marden (1966).
- §31.17 Gaudin (1983), Kuznetsov (1992).



## Chapter 32

# Painlevé Transcendents

P. A. Clarkson<sup>1</sup>

<b>Notation</b>	<b>724</b>		
32.1 Special Notation . . . . .	724		
<b>Properties</b>	<b>724</b>		
32.2 Differential Equations . . . . .	724		
32.3 Graphics . . . . .	726		
32.4 Isomonodromy Problems . . . . .	728		
32.5 Integral Equations . . . . .	729		
32.6 Hamiltonian Structure . . . . .	729		
32.7 Bäcklund Transformations . . . . .	730		
32.8 Rational Solutions . . . . .	732		
32.9 Other Elementary Solutions . . . . .	734		
32.10 Special Function Solutions . . . . .	735		
		32.11 Asymptotic Approximations for Real Variables . . . . .	736
		32.12 Asymptotic Approximations for Complex Variables . . . . .	738
		<b>Applications</b>	<b>738</b>
		32.13 Reductions of Partial Differential Equations	738
		32.14 Combinatorics . . . . .	739
		32.15 Orthogonal Polynomials . . . . .	739
		32.16 Physical . . . . .	739
		<b>Computation</b>	<b>739</b>
		32.17 Methods of Computation . . . . .	740
		<b>References</b>	<b>740</b>

<sup>1</sup>School of Mathematics, Statistics & Actuarial Science, University of Kent, Canterbury, United Kingdom.  
Copyright © 2009 National Institute of Standards and Technology. All rights reserved.

## Notation

### 32.1 Special Notation

(For other notation see pp. xiv and 873.)

- $m, n$  integers.  
 $x$  real variable.  
 $z$  complex variable.  
 $k$  real parameter.

Unless otherwise noted, primes indicate derivatives with respect to the argument.

The functions treated in this chapter are the solutions of the Painlevé equations  $P_I$ – $P_{VI}$ .

## Properties

### 32.2 Differential Equations

#### 32.2(i) Introduction

The six Painlevé equations  $P_I$ – $P_{VI}$  are as follows:

$$32.2.1 \quad \frac{d^2 w}{dz^2} = 6w^2 + z,$$

$$32.2.2 \quad \frac{d^2 w}{dz^2} = 2w^3 + zw + \alpha,$$

$$32.2.3 \quad \frac{d^2 w}{dz^2} = \frac{1}{w} \left( \frac{dw}{dz} \right)^2 - \frac{1}{z} \frac{dw}{dz} + \frac{\alpha w^2 + \beta}{z} + \gamma w^3 + \frac{\delta}{w},$$

---


$$32.2.4 \quad \frac{d^2 w}{dz^2} = \frac{1}{2w} \left( \frac{dw}{dz} \right)^2 + \frac{3}{2} w^3 + 4zw^2 + 2(z^2 - \alpha)w + \frac{\beta}{w},$$

$$32.2.5 \quad \frac{d^2 w}{dz^2} = \left( \frac{1}{2w} + \frac{1}{w-1} \right) \left( \frac{dw}{dz} \right)^2 - \frac{1}{z} \frac{dw}{dz} + \frac{(w-1)^2}{z^2} \left( \alpha w + \frac{\beta}{w} \right) + \frac{\gamma w}{z} + \frac{\delta w(w+1)}{w-1},$$

$$32.2.6 \quad \frac{d^2 w}{dz^2} = \frac{1}{2} \left( \frac{1}{w} + \frac{1}{w-1} + \frac{1}{w-z} \right) \left( \frac{dw}{dz} \right)^2 - \left( \frac{1}{z} + \frac{1}{z-1} + \frac{1}{w-z} \right) \frac{dw}{dz} + \frac{w(w-1)(w-z)}{z^2(z-1)^2} \left( \alpha + \frac{\beta z}{w^2} + \frac{\gamma(z-1)}{(w-1)^2} + \frac{\delta z(z-1)}{(w-z)^2} \right),$$

with  $\alpha, \beta, \gamma,$  and  $\delta$  arbitrary constants. The solutions of  $P_I$ – $P_{VI}$  are called the *Painlevé transcendents*. The six equations are sometimes referred to as the Painlevé transcendents, but in this chapter this term will be used only for their solutions.

Let

$$32.2.7 \quad \frac{d^2 w}{dz^2} = F \left( z, w, \frac{dw}{dz} \right),$$

be a nonlinear second-order differential equation in which  $F$  is a rational function of  $w$  and  $dw/dz$ , and is *locally analytic* in  $z$ , that is, analytic except for isolated singularities in  $\mathbb{C}$ . In general the singularities of the solutions are *movable* in the sense that their location depends on the constants of integration associated with the initial or boundary conditions. An equation is said to have the *Painlevé property* if all its solutions are free from *movable branch points*; the solutions may have movable poles or movable isolated essential singularities (§1.10(iii)), however.

There are fifty equations with the Painlevé property. They are distinct modulo Möbius (bilinear) transformations

$$32.2.8 \quad W(\zeta) = \frac{a(z)w + b(z)}{c(z)w + d(z)}, \quad \zeta = \phi(z),$$

in which  $a(z), b(z), c(z), d(z),$  and  $\phi(z)$  are locally an-

alytic functions. The fifty equations can be reduced to linear equations, solved in terms of elliptic functions (Chapters 22 and 23), or reduced to one of  $P_I$ – $P_{VI}$ .

For arbitrary values of the parameters  $\alpha, \beta, \gamma,$  and  $\delta$ , the general solutions of  $P_I$ – $P_{VI}$  are *transcendental*, that is, they cannot be expressed in closed-form elementary functions. However, for special values of the parameters, equations  $P_{II}$ – $P_{VI}$  have special solutions in terms of elementary functions, or special functions defined elsewhere in this Handbook.

#### 32.2(ii) Renormalizations

If  $\gamma\delta \neq 0$  in  $P_{III}$ , then set  $\gamma = 1$  and  $\delta = -1$ , without loss of generality, by rescaling  $w$  and  $z$  if necessary. If  $\gamma = 0$  and  $\alpha\delta \neq 0$  in  $P_{III}$ , then set  $\alpha = 1$  and  $\delta = -1$ , without loss of generality. Lastly, if  $\delta = 0$  and  $\beta\gamma \neq 0$ , then set  $\beta = -1$  and  $\gamma = 1$ , without loss of generality.

If  $\delta \neq 0$  in  $P_V$ , then set  $\delta = -\frac{1}{2}$ , without loss of generality.

#### 32.2(iii) Alternative Forms

In  $P_{III}$ , if  $w(z) = \zeta^{-1/2}u(\zeta)$  with  $\zeta = z^2$ , then

$$32.2.9 \quad \frac{d^2 u}{d\zeta^2} = \frac{1}{u} \left( \frac{du}{d\zeta} \right)^2 - \frac{1}{\zeta} \frac{du}{d\zeta} + \frac{u^2(\alpha + \gamma u)}{4\zeta^2} + \frac{\beta}{4\zeta} + \frac{\delta}{4u},$$

which is known as  $P'_{III}$ .

In  $P_{III}$ , if  $w(z) = \exp(-iu(z))$ ,  $\beta = -\alpha$ , and  $\delta = -\gamma$ , then

$$32.2.10 \quad \frac{d^2u}{dz^2} + \frac{1}{z} \frac{du}{dz} = \frac{2\alpha}{z} \sin u + 2\gamma \sin(2u).$$

In  $P_{IV}$ , if  $w(z) = 2\sqrt{2}(u(\zeta))^2$  with  $\zeta = \sqrt{2}z$  and  $\alpha = 2\nu + 1$ , then

$$32.2.11 \quad \frac{d^2u}{d\zeta^2} = 3u^5 + 2\zeta u^3 + \left(\frac{1}{4}\zeta^2 - \nu - \frac{1}{2}\right)u + \frac{\beta}{32u^3}.$$

When  $\beta = 0$  this is a nonlinear harmonic oscillator.

In  $P_V$ , if  $w(z) = (\coth u(\zeta))^2$  with  $\zeta = \ln z$ , then

$$32.2.12 \quad \frac{d^2u}{d\zeta^2} = -\frac{\alpha \cosh u}{2(\sinh u)^3} - \frac{\beta \sinh u}{2(\cosh u)^3} - \frac{1}{4}\gamma e^\zeta \sinh(2u) - \frac{1}{8}\delta e^{2\zeta} \sinh(4u).$$

See also Okamoto (1987c), McCoy *et al.* (1977), Bassom *et al.* (1992), Bassom *et al.* (1995), and Takasaki (2001).

### 32.2(iv) Elliptic Form

$P_{VI}$  can be written in the form

32.2.13

$$z(1-z)I \left( \int_\infty^w \frac{dt}{\sqrt{t(t-1)(t-z)}} \right) = \sqrt{w(w-1)(w-z)} \times \left( \alpha + \frac{\beta z}{w^2} + \frac{\gamma(z-1)}{(w-1)^2} + \left(\delta - \frac{1}{2}\right) \frac{z(z-1)}{(w-z)^2} \right),$$

where

$$32.2.14 \quad I = z(1-z) \frac{d^2}{dz^2} + (1-2z) \frac{d}{dz} - \frac{1}{4}.$$

See Fuchs (1907), Painlevé (1906), Gromak *et al.* (2002, §42); also Manin (1998).

### 32.2(v) Symmetric Forms

Let

$$32.2.15 \quad \begin{aligned} \frac{df_1}{dz} + f_1(f_2 - f_3) + 2\mu_1 &= 0, \\ \frac{df_2}{dz} + f_2(f_3 - f_1) + 2\mu_2 &= 0, \\ \frac{df_3}{dz} + f_3(f_1 - f_2) + 2\mu_3 &= 0, \end{aligned}$$

where  $\mu_1, \mu_2, \mu_3$  are constants,  $f_1, f_2, f_3$  are functions of  $z$ , with

$$32.2.16 \quad \mu_1 + \mu_2 + \mu_3 = 1,$$

$$32.2.17 \quad f_1(z) + f_2(z) + f_3(z) + 2z = 0.$$

Then  $w(z) = f_1(z)$  satisfies  $P_{IV}$  with

$$32.2.18 \quad (\alpha, \beta) = (\mu_3 - \mu_2, -2\mu_1^2).$$

See Noumi and Yamada (1998).

Next, let

$$32.2.19 \quad \begin{aligned} z \frac{df_1}{dz} &= f_1 f_3 (f_2 - f_4) + \left(\frac{1}{2} - \mu_3\right) f_1 + \mu_1 f_3, \\ z \frac{df_2}{dz} &= f_2 f_4 (f_3 - f_1) + \left(\frac{1}{2} - \mu_4\right) f_2 + \mu_2 f_4, \\ z \frac{df_3}{dz} &= f_3 f_1 (f_4 - f_2) + \left(\frac{1}{2} - \mu_1\right) f_3 + \mu_3 f_1, \\ z \frac{df_4}{dz} &= f_4 f_2 (f_1 - f_3) + \left(\frac{1}{2} - \mu_2\right) f_4 + \mu_4 f_2, \end{aligned}$$

where  $\mu_1, \mu_2, \mu_3, \mu_4$  are constants,  $f_1, f_2, f_3, f_4$  are functions of  $z$ , with

$$32.2.20 \quad \mu_1 + \mu_2 + \mu_3 + \mu_4 = 1,$$

$$32.2.21 \quad f_1(z) + f_3(z) = \sqrt{z},$$

$$32.2.22 \quad f_2(z) + f_4(z) = \sqrt{z}.$$

Then  $w(z) = 1 - (\sqrt{z}/f_1(z))$  satisfies  $P_V$  with

$$32.2.23 \quad (\alpha, \beta, \gamma, \delta) = \left(\frac{1}{2}\mu_1^2, -\frac{1}{2}\mu_3^2, \mu_4 - \mu_2, -\frac{1}{2}\right).$$

### 32.2(vi) Coalescence Cascade

$P_I$ - $P_V$  are obtained from  $P_{VI}$  by a coalescence cascade:

$$32.2.24 \quad \begin{array}{ccccc} P_{VI} & \longrightarrow & P_V & \longrightarrow & P_{IV} \\ & & \downarrow & & \downarrow \\ & & P_{III} & \longrightarrow & P_{II} & \longrightarrow & P_I \end{array}$$

For example, if in  $P_{II}$

$$32.2.25 \quad w(z; \alpha) = \epsilon W(\zeta) + \frac{1}{\epsilon^5},$$

$$32.2.26 \quad z = \epsilon^2 \zeta - \frac{6}{\epsilon^{10}}, \quad \alpha = \frac{4}{\epsilon^{15}},$$

then

$$32.2.27 \quad \frac{d^2W}{d\zeta^2} = 6W^2 + \zeta + \epsilon^6(2W^3 + \zeta W);$$

thus in the limit as  $\epsilon \rightarrow 0$ ,  $W(\zeta)$  satisfies  $P_I$  with  $z = \zeta$ .

If in  $P_{III}$

$$32.2.28 \quad w(z; \alpha, \beta, \gamma, \delta) = 1 + 2\epsilon W(\zeta; a),$$

$$32.2.29 \quad z = 1 + \epsilon^2 \zeta, \quad \alpha = -\frac{1}{2}\epsilon^{-6},$$

$$\beta = \frac{1}{2}\epsilon^{-6} + 2a\epsilon^{-3}, \quad \gamma = -\delta = \frac{1}{4}\epsilon^{-6},$$

then as  $\epsilon \rightarrow 0$ ,  $W(\zeta; a)$  satisfies  $P_{II}$  with  $z = \zeta$ ,  $\alpha = a$ .

If in  $P_{IV}$

$$32.2.30 \quad w(z; \alpha, \beta) = 2^{2/3}\epsilon^{-1}W(\zeta; a) + \epsilon^{-3},$$

32.2.31

$$z = 2^{-2/3}\epsilon \zeta - \epsilon^{-3}, \quad \alpha = -2a - \frac{1}{2}\epsilon^{-6}, \quad \beta = -\frac{1}{2}\epsilon^{-12},$$

then as  $\epsilon \rightarrow 0$ ,  $W(\zeta; a)$  satisfies  $P_{II}$  with  $z = \zeta$ ,  $\alpha = a$ .

If in  $P_V$

$$32.2.32 \quad w(z; \alpha, \beta, \gamma, \delta) = 1 + \epsilon \zeta W(\zeta; a, b, c, d),$$

$$z = \zeta^2, \quad \alpha = \frac{1}{4}a\epsilon^{-1} + \frac{1}{8}c\epsilon^{-2},$$

$$32.2.33 \quad \beta = -\frac{1}{8}c\epsilon^{-2}, \quad \gamma = \frac{1}{4}eb, \quad \delta = \frac{1}{8}\epsilon^2 d,$$

then as  $\epsilon \rightarrow 0$ ,  $W(\zeta; a, b, c, d)$  satisfies  $P_{III}$  with  $z = \zeta$ ,  $\alpha = a$ ,  $\beta = b$ ,  $\gamma = c$ ,  $\delta = d$ .

If in  $P_V$

$$32.2.34 \quad w(z; \alpha, \beta, \gamma, \delta) = \frac{1}{2}\sqrt{2\epsilon}W(\zeta; a, b),$$

**32.2.35**  $z = 1 + \sqrt{2}\epsilon\zeta, \quad \alpha = \frac{1}{2}\epsilon^{-4}, \quad \beta = \frac{1}{4}b,$   
 $\gamma = -\epsilon^{-4}, \quad \delta = a\epsilon^{-2} - \frac{1}{2}\epsilon^{-4},$

then as  $\epsilon \rightarrow 0$ ,  $W(\zeta; a, b)$  satisfies  $P_{IV}$  with  $z = \zeta$ ,  $\alpha = a$ ,  $\beta = b$ .

Lastly, if in  $P_{VI}$

**32.2.36**  $w(z; \alpha, \beta, \gamma, \delta) = W(\zeta; a, b, c, d),$

**32.2.37**  $z = 1 + \epsilon\zeta, \quad \gamma = c\epsilon^{-1} - d\epsilon^{-2}, \quad \delta = d\epsilon^{-2},$

then as  $\epsilon \rightarrow 0$ ,  $W(\zeta; a, b, c, d)$  satisfies  $P_V$  with  $z = \zeta$ ,  $\alpha = a$ ,  $\beta = b$ ,  $\gamma = c$ ,  $\delta = d$ .

### 32.3 Graphics

#### 32.3(i) First Painlevé Equation

Plots of solutions  $w_k(x)$  of  $P_I$  with  $w_k(0) = 0$  and  $w'_k(0) = k$  for various values of  $k$ , and the parabola  $6w^2 + x = 0$ . For analytical explanation see §32.11(i).

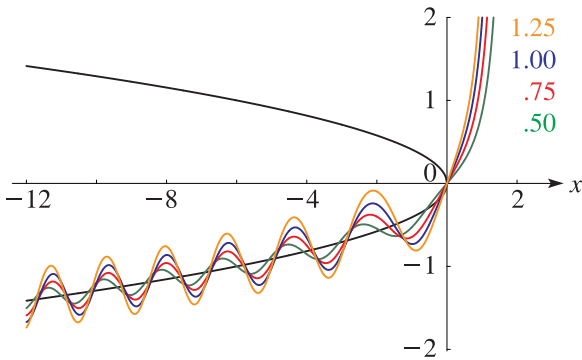


Figure 32.3.1:  $w_k(x)$  for  $-12 \leq x \leq 1.33$  and  $k = 0.5, 0.75, 1, 1.25$ , and the parabola  $6w^2 + x = 0$ , shown in black.

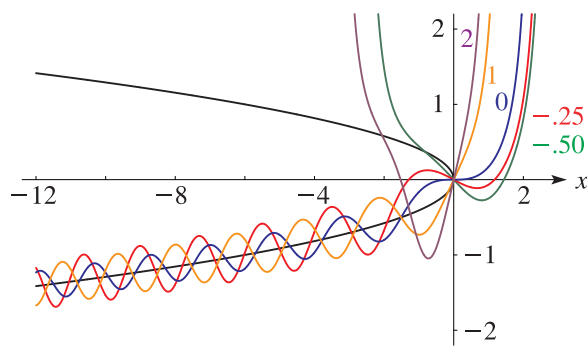


Figure 32.3.2:  $w_k(x)$  for  $-12 \leq x \leq 2.43$  and  $k = -0.5, -0.25, 0, 1, 2$ , and the parabola  $6w^2 + x = 0$ , shown in black.

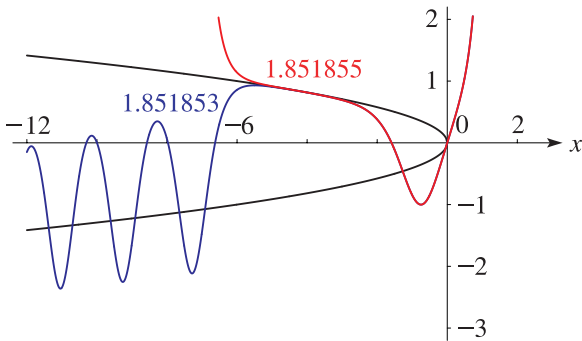


Figure 32.3.3:  $w_k(x)$  for  $-12 \leq x \leq 0.73$  and  $k = 1.851853, 1.851855$ . The two graphs are indistinguishable when  $x$  exceeds  $-5.2$ , approximately. The parabola  $6w^2 + x = 0$  is shown in black.

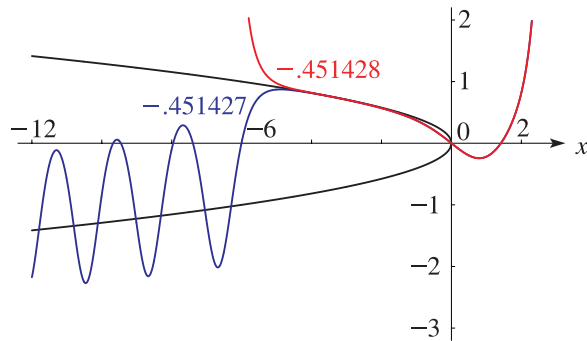


Figure 32.3.4:  $w_k(x)$  for  $-12 \leq x \leq 2.3$  and  $k = -0.451427, -0.451428$ . The two graphs are indistinguishable when  $x$  exceeds  $-4.8$ , approximately. The parabola  $6w^2 + x = 0$  is shown in black.

**32.3(ii) Second Painlevé Equation with  $\alpha = 0$**

Here  $w_k(x)$  is the solution of  $P_{II}$  with  $\alpha = 0$  and such that

**32.3.1**  $w_k(x) \sim k \operatorname{Ai}(x), \quad x \rightarrow +\infty;$   
 compare §32.11(ii).

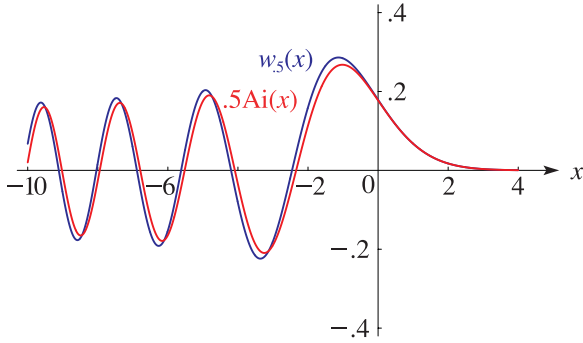


Figure 32.3.5:  $w_k(x)$  and  $k \operatorname{Ai}(x)$  for  $-10 \leq x \leq 4$  with  $k = 0.5$ . The two graphs are indistinguishable when  $x$  exceeds  $-0.4$ , approximately.

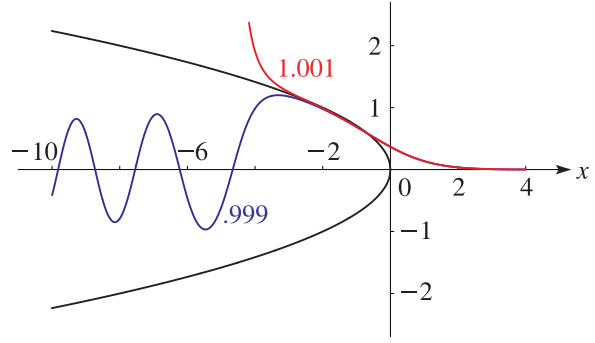


Figure 32.3.6:  $w_k(x)$  for  $-10 \leq x \leq 4$  with  $k = 0.999, 1.001$ . The two graphs are indistinguishable when  $x$  exceeds  $-2.8$ , approximately. The parabola  $2w^2 + x = 0$  is shown in black.

**32.3(iii) Fourth Painlevé Equation with  $\beta = 0$**

Here  $u = u_k(x; \nu)$  is the solution of

**32.3.2** 
$$\frac{d^2 u}{dx^2} = 3u^5 + 2xu^3 + \left(\frac{1}{4}x^2 - \nu - \frac{1}{2}\right)u,$$

such that

**32.3.3**  $u \sim k U\left(-\nu - \frac{1}{2}, x\right), \quad x \rightarrow +\infty.$

The corresponding solution of  $P_{IV}$  is given by

**32.3.4**  $w(x) = 2\sqrt{2}u_k^2(\sqrt{2}x, \nu),$

with  $\beta = 0, \alpha = 2\nu + 1$ , and

**32.3.5**  $w(x) \sim 2\sqrt{2}k^2 U^2\left(-\nu - \frac{1}{2}, \sqrt{2}x\right), \quad x \rightarrow +\infty;$

compare (32.2.11) and §32.11(v). If we set  $d^2u/dx^2 = 0$  in (32.3.2) and solve for  $u$ , then

**32.3.6**  $u^2 = -\frac{1}{3}x \pm \frac{1}{6}\sqrt{x^2 + 12\nu + 6}.$

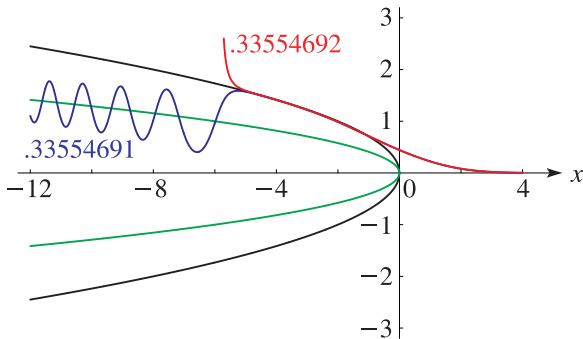


Figure 32.3.7:  $u_k(x; -\frac{1}{2})$  for  $-12 \leq x \leq 4$  with  $k = 0.33554691, 0.33554692$ . The two graphs are indistinguishable when  $x$  exceeds  $-5.0$ , approximately. The parabolas  $u^2 + \frac{1}{2}x = 0, u^2 + \frac{1}{6}x = 0$  are shown in black and green, respectively.

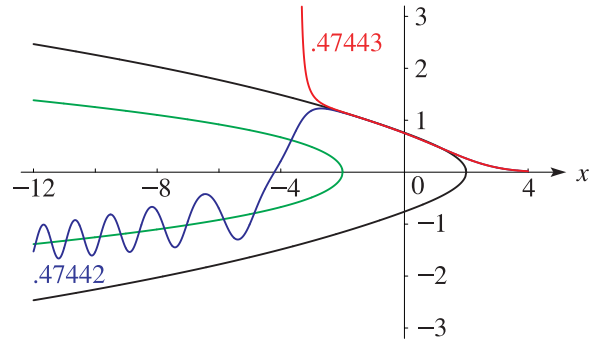


Figure 32.3.8:  $u_k(x; \frac{1}{2})$  for  $-12 \leq x \leq 4$  with  $k = 0.47442, 0.47443$ . The two graphs are indistinguishable when  $x$  exceeds  $-2.2$ , approximately. The curves  $u^2 + \frac{1}{3}x \pm \frac{1}{6}\sqrt{x^2 + 12} = 0$  are shown in green and black, respectively.



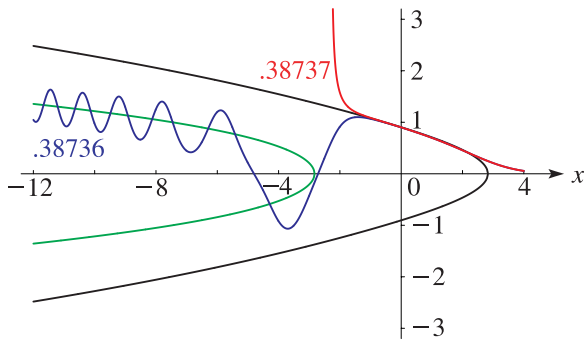


Figure 32.3.9:  $u_k(x; \frac{3}{2})$  for  $-12 \leq x \leq 4$  with  $k = 0.38736, 0.38737$ . The two graphs are indistinguishable when  $x$  exceeds  $-1.0$ , approximately. The curves  $u^2 + \frac{1}{3}x \pm \frac{1}{6}\sqrt{x^2 + 24} = 0$  are shown in green and black, respectively.

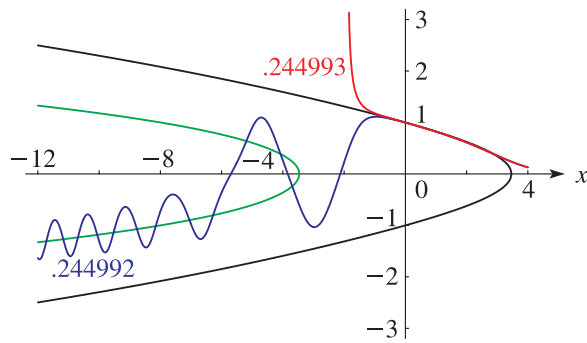


Figure 32.3.10:  $u_k(x; \frac{5}{2})$  for  $-12 \leq x \leq 4$  with  $k = 0.244992, 0.244993$ . The two graphs are indistinguishable when  $x$  exceeds  $-0.6$ , approximately. The curves  $u^2 + \frac{1}{3}x \pm \frac{1}{6}\sqrt{x^2 + 36} = 0$  are shown in green and black, respectively.

### 32.4 Isomonodromy Problems

#### 32.4(i) Definition

$P_I$ – $P_{VI}$  can be expressed as the compatibility condition of a linear system, called an *isomonodromy problem* or *Lax pair*. Suppose

$$32.4.1 \quad \frac{\partial \Psi}{\partial \lambda} = \mathbf{A}(z, \lambda) \Psi, \quad \frac{\partial \Psi}{\partial z} = \mathbf{B}(z, \lambda) \Psi,$$

is a linear system in which  $\mathbf{A}$  and  $\mathbf{B}$  are matrices and  $\lambda$  is independent of  $z$ . Then the equation

$$32.4.2 \quad \frac{\partial^2 \Psi}{\partial z \partial \lambda} = \frac{\partial^2 \Psi}{\partial \lambda \partial z},$$

is satisfied provided that

$$32.4.3 \quad \frac{\partial \mathbf{A}}{\partial z} - \frac{\partial \mathbf{B}}{\partial \lambda} + \mathbf{A}\mathbf{B} - \mathbf{B}\mathbf{A} = 0.$$

(32.4.3) is the *compatibility condition* of (32.4.1). Isomonodromy problems for Painlevé equations are not unique.

#### 32.4(ii) First Painlevé Equation

$P_I$  is the compatibility condition of (32.4.1) with

$$32.4.4 \quad \mathbf{A}(z, \lambda) = (4\lambda^4 + 2w^2 + z) \begin{bmatrix} 1 & 0 \\ 0 & -1 \end{bmatrix} - i(4\lambda^2 w + 2w^2 + z) \begin{bmatrix} 0 & -i \\ i & 0 \end{bmatrix} - \left(2\lambda w' + \frac{1}{2\lambda}\right) \begin{bmatrix} 0 & 1 \\ 1 & 0 \end{bmatrix},$$

$$32.4.5 \quad \mathbf{B}(z, \lambda) = \left(\lambda + \frac{w}{\lambda}\right) \begin{bmatrix} 1 & 0 \\ 0 & -1 \end{bmatrix} - \frac{iw}{\lambda} \begin{bmatrix} 0 & -i \\ i & 0 \end{bmatrix}.$$

#### 32.4(iii) Second Painlevé Equation

$P_{II}$  is the compatibility condition of (32.4.1) with

$$32.4.6 \quad \mathbf{A}(z, \lambda) = -i(4\lambda^2 + 2w^2 + z) \begin{bmatrix} 1 & 0 \\ 0 & -1 \end{bmatrix} - 2w' \begin{bmatrix} 0 & -i \\ i & 0 \end{bmatrix} + \left(4\lambda w - \frac{\alpha}{\lambda}\right) \begin{bmatrix} 0 & 1 \\ 1 & 0 \end{bmatrix},$$

$$32.4.7 \quad \mathbf{B}(z, \lambda) = \begin{bmatrix} -i\lambda & w \\ w & i\lambda \end{bmatrix}.$$

See Flaschka and Newell (1980).

#### 32.4(iv) Third Painlevé Equation

The compatibility condition of (32.4.1) with

$$32.4.8 \quad \mathbf{A}(z, \lambda) = \begin{bmatrix} \frac{1}{4}z & 0 \\ 0 & -\frac{1}{4}z \end{bmatrix} + \begin{bmatrix} -\frac{1}{2}\theta_\infty & u_0 \\ u_1 & \frac{1}{2}\theta_\infty \end{bmatrix} \frac{1}{\lambda} + \begin{bmatrix} v_0 - \frac{1}{4}z & -v_1 v_0 \\ (v_0 - \frac{1}{2}z)/v_1 & \frac{1}{4}z - v_0 \end{bmatrix} \frac{1}{\lambda^2},$$

$$32.4.9 \quad \mathbf{B}(z, \lambda) = \begin{bmatrix} \frac{1}{4} & 0 \\ 0 & -\frac{1}{4} \end{bmatrix} \lambda + \begin{bmatrix} 0 & u_0 \\ u_1 & 0 \end{bmatrix} \frac{1}{z} - \begin{bmatrix} v_0 - \frac{1}{4}z & -v_1 v_0 \\ (v_0 - \frac{1}{2}z)/v_1 & \frac{1}{4}z - v_0 \end{bmatrix} \frac{1}{z\lambda},$$

where  $\theta_\infty$  is an arbitrary constant, is

$$32.4.10 \quad zu'_0 = \theta_\infty u_0 - zv_0 v_1,$$

$$32.4.11 \quad zu'_1 = -\theta_\infty u_1 - (z(2v_0 - z)/(2v_1)),$$

$$32.4.12 \quad zv'_0 = 2v_0 u_1 v_1 + v_0 + (u_0(2v_0 - z)/v_1),$$

$$32.4.13 \quad zv'_1 = 2u_0 - 2u_1 v_1^2 - \theta_\infty v_1.$$

If  $w = -u_0/(v_0 v_1)$ , then

$$32.4.14 \quad zw' = (4v_0 - z)w^2 + (2\theta_\infty - 1)w + z,$$

and  $w$  satisfies  $P_{\text{III}}$  with

$$\mathbf{32.4.15} \quad (\alpha, \beta, \gamma, \delta) = (2\theta_0, 2(1 - \theta_\infty), 1, -1),$$

where

$$\mathbf{32.4.16} \quad \theta_0 = \frac{4v_0}{z} \left( \theta_\infty \left( 1 - \frac{z}{4v_0} \right) + \frac{z - 2v_0}{2v_0v_1} u_0 + u_1v_1 \right).$$

Note that the right-hand side of the last equation is a first integral of the system (32.4.10)–(32.4.13).

### 32.4(v) Other Painlevé Equations

For isomonodromy problems for  $P_{\text{IV}}$ ,  $P_{\text{V}}$ , and  $P_{\text{VI}}$  see Jimbo and Miwa (1981).

## 32.5 Integral Equations

Let  $K(z, \zeta)$  be the solution of

$$\begin{aligned} \mathbf{32.5.1} \quad & K(z, \zeta) \\ &= k \operatorname{Ai} \left( \frac{z + \zeta}{2} \right) \\ &+ \frac{k^2}{4} \int_z^\infty \int_z^\infty K(z, s) \operatorname{Ai} \left( \frac{s + t}{2} \right) \operatorname{Ai} \left( \frac{t + \zeta}{2} \right) ds dt, \end{aligned}$$

where  $k$  is a real constant, and  $\operatorname{Ai}(z)$  is defined in §9.2. Then

$$\mathbf{32.5.2} \quad w(z) = K(z, z),$$

satisfies  $P_{\text{II}}$  with  $\alpha = 0$  and the boundary condition

$$\mathbf{32.5.3} \quad w(z) \sim k \operatorname{Ai}(z), \quad z \rightarrow +\infty.$$

## 32.6 Hamiltonian Structure

### 32.6(i) Introduction

$P_{\text{I}}$ – $P_{\text{VI}}$  can be written as a Hamiltonian system

$$\mathbf{32.6.1} \quad \frac{dq}{dz} = \frac{\partial H}{\partial p}, \quad \frac{dp}{dz} = -\frac{\partial H}{\partial q},$$

for suitable (non-autonomous) Hamiltonian functions  $H(q, p, z)$ .

### 32.6(ii) First Painlevé Equation

The Hamiltonian for  $P_{\text{I}}$  is

$$\mathbf{32.6.2} \quad H_{\text{I}}(q, p, z) = \frac{1}{2}p^2 - 2q^3 - zq,$$

and so

$$\mathbf{32.6.3} \quad q' = p,$$

$$\mathbf{32.6.4} \quad p' = 6q^2 + z.$$

Then  $q = w$  satisfies  $P_{\text{I}}$ . The function

$$\mathbf{32.6.5} \quad \sigma = H_{\text{I}}(q, p, z),$$

defined by (32.6.2) satisfies

$$\mathbf{32.6.6} \quad (\sigma'')^2 + 4(\sigma')^3 + 2z\sigma' - 2\sigma = 0.$$

Conversely, if  $\sigma$  is a solution of (32.6.6), then

$$\mathbf{32.6.7} \quad q = -\sigma',$$

$$\mathbf{32.6.8} \quad p = -\sigma'',$$

are solutions of (32.6.3) and (32.6.4).

### 32.6(iii) Second Painlevé Equation

The Hamiltonian for  $P_{\text{II}}$  is

$$\mathbf{32.6.9} \quad H_{\text{II}}(q, p, z) = \frac{1}{2}p^2 - (q^2 + \frac{1}{2}z)p - (\alpha + \frac{1}{2})q,$$

and so

$$\mathbf{32.6.10} \quad q' = p - q^2 - \frac{1}{2}z,$$

$$\mathbf{32.6.11} \quad p' = 2qp + \alpha + \frac{1}{2}.$$

Then  $q = w$  satisfies  $P_{\text{II}}$  and  $p$  satisfies

$$\mathbf{32.6.12} \quad pp'' = \frac{1}{2}(p')^2 + 2p^3 - zp^2 - \frac{1}{2}(\alpha + \frac{1}{2})^2.$$

The function  $\sigma(z) = H_{\text{II}}(q, p, z)$  defined by (32.6.9) satisfies

$$\mathbf{32.6.13} \quad (\sigma'')^2 + 4(\sigma')^3 + 2\sigma'(z\sigma' - \sigma) = \frac{1}{4}(\alpha + \frac{1}{2})^2.$$

Conversely, if  $\sigma(z)$  is a solution of (32.6.13), then

$$\mathbf{32.6.14} \quad q = (4\sigma'' + 2\alpha + 1)/(8\sigma'),$$

$$\mathbf{32.6.15} \quad p = -2\sigma',$$

are solutions of (32.6.10) and (32.6.11).

### 32.6(iv) Third Painlevé Equation

The Hamiltonian for  $P_{\text{III}}$  is

$$\begin{aligned} \mathbf{32.6.16} \quad & zH_{\text{III}}(q, p, z) = q^2p^2 - (\kappa_\infty zq^2 + (2\theta_0 + 1)q - \kappa_0z)p \\ & + \kappa_\infty(\theta_0 + \theta_\infty)zq, \end{aligned}$$

and so

$$\mathbf{32.6.17} \quad zq' = 2q^2p - \kappa_\infty zq^2 - (2\theta_0 + 1)q + \kappa_0z,$$

$$\mathbf{32.6.18} \quad zp' = -2qp^2 + 2\kappa_\infty zqp + (2\theta_0 + 1)p - \kappa_\infty(\theta_0 + \theta_\infty)z.$$

Then  $q = w$  satisfies  $P_{\text{III}}$  with

$$\mathbf{32.6.19} \quad (\alpha, \beta, \gamma, \delta) = (-2\kappa_\infty\theta_\infty, 2\kappa_0(\theta_0 + 1), \kappa_\infty^2, -\kappa_0^2).$$

The function

$$\mathbf{32.6.20} \quad \sigma = zH_{\text{III}}(q, p, z) + pq + \theta_0^2 - \frac{1}{2}\kappa_0\kappa_\infty z^2$$

defined by (32.6.16) satisfies

$$\begin{aligned} \mathbf{32.6.21} \quad & (z\sigma'' - \sigma')^2 + 2((\sigma')^2 - \kappa_0^2\kappa_\infty^2 z^2)(z\sigma' - 2\sigma) \\ & + 8\kappa_0\kappa_\infty\theta_0\theta_\infty z\sigma' = 4\kappa_0^2\kappa_\infty^2(\theta_0^2 + \theta_\infty^2)z^2. \end{aligned}$$

Conversely, if  $\sigma$  is a solution of (32.6.21), then

$$\mathbf{32.6.22} \quad q = \frac{\kappa_0(z\sigma'' - (2\theta_0 + 1)\sigma' + 2\kappa_0\kappa_\infty\theta_\infty z)}{\kappa_0^2\kappa_\infty^2 z^2 - (\sigma')^2},$$

$$\mathbf{32.6.23} \quad p = (\sigma' + \kappa_0\kappa_\infty z)/(2\kappa_0),$$

are solutions of (32.6.17) and (32.6.18).

The Hamiltonian for  $P'_{\text{III}}$  (§32.2(iii)) is

$$32.6.24 \quad \zeta H_{\text{III}}(q, p, \zeta) = q^2 p^2 - (\eta_\infty q^2 + \theta_0 q - \eta_0 \zeta) p + \frac{1}{2} \eta_\infty (\theta_0 + \theta_\infty) q,$$

and so

$$32.6.25 \quad \zeta q' = 2q^2 p - \eta_\infty q^2 - \theta_0 q + \eta_0 \zeta,$$

$$32.6.26 \quad \zeta p' = -2qp^2 + 2\eta_\infty qp + \theta_0 p - \frac{1}{2} \eta_\infty (\theta_0 + \theta_1).$$

Then  $q = u$  satisfies  $P'_{\text{III}}$  with

$$32.6.27 \quad (\alpha, \beta, \gamma, \delta) = (-4\eta_\infty \theta_\infty, 4\eta_0(\theta_0 + 1), 4\eta_\infty^2, -4\eta_0^2).$$

The function

$$32.6.28 \quad \sigma = \zeta H_{\text{III}}(q, p, \zeta) + \frac{1}{4} \theta_0^2 - \frac{1}{2} \eta_0 \eta_\infty \zeta$$

defined by (32.6.24) satisfies

$$32.6.29 \quad \zeta^2 (\sigma'')^2 + (4(\sigma')^2 - \eta_0^2 \eta_\infty^2) (\zeta \sigma' - \sigma) + \eta_0 \eta_\infty \theta_0 \theta_\infty \sigma' = \frac{1}{4} \eta_0^2 \eta_\infty^2 (\theta_0^2 + \theta_\infty^2).$$

Conversely, if  $\sigma$  is a solution of (32.6.29), then

$$32.6.30 \quad q = \frac{\eta_0 (\zeta \sigma'' - 2\theta_0 \sigma' + \eta_0 \eta_\infty \theta_\infty)}{\eta_0^2 \eta_\infty^2 - 4(\sigma')^2},$$

$$32.6.31 \quad p = (2\sigma' + \eta_0 \eta_\infty \zeta) / (2\eta_0),$$

are solutions of (32.6.25) and (32.6.26).

The Hamiltonian for  $P_{\text{III}}$  with  $\gamma = 0$  is

$$32.6.32 \quad z H_{\text{III}}(q, p, z) = q^2 p^2 + (\theta q - \kappa_0 z) p - \kappa_\infty z q,$$

and so

$$32.6.33 \quad z q' = 2q^2 p + \theta q - \kappa_0 z,$$

$$32.6.34 \quad z p' = -2qp^2 - \theta p + \kappa_\infty z.$$

Then  $q = w$  satisfies  $P_{\text{III}}$  with

$$32.6.35 \quad (\alpha, \beta, \gamma, \delta) = (2\kappa_\infty, \kappa_0(\theta - 1), 0, -\kappa_0^2).$$

The function

$$32.6.36 \quad \sigma = z H_{\text{III}}(q, p, z) + pq + \frac{1}{4} (\theta + 1)^2$$

defined by (32.6.32) satisfies

$$32.6.37 \quad (z\sigma'' - \sigma')^2 + 2(\sigma')^2 (z\sigma' - 2\sigma) - 4\kappa_0 \kappa_\infty (\theta + 1) \theta_\infty z \sigma' = 4\kappa_0^2 \kappa_\infty^2 z^2.$$

Conversely, if  $\sigma$  is a solution of (32.6.37), then

$$32.6.38 \quad q = \kappa_0 (z\sigma'' - \theta\sigma' + 2\kappa_0 \kappa_\infty z) / (\sigma')^2,$$

$$32.6.39 \quad p = \sigma' / (2\kappa_0),$$

are solutions of (32.6.33) and (32.6.34).

### 32.6(v) Other Painlevé Equations

For Hamiltonian structure for  $P_{\text{IV}}$  see Jimbo and Miwa (1981), Okamoto (1986); also Forrester and Witte (2001).

For Hamiltonian structure for  $P_{\text{V}}$  see Jimbo and Miwa (1981), Okamoto (1987b); also Forrester and Witte (2002).

For Hamiltonian structure for  $P_{\text{VI}}$  see Jimbo and Miwa (1981) and Okamoto (1987a); also Forrester and Witte (2004).

## 32.7 Bäcklund Transformations

### 32.7(i) Definition

With the exception of  $P_{\text{I}}$ , a *Bäcklund transformation* relates a Painlevé transcendent of one type either to another of the same type but with different values of the parameters, or to another type.

### 32.7(ii) Second Painlevé Equation

Let  $w = w(z; \alpha)$  be a solution of  $P_{\text{II}}$ . Then the transformations

$$32.7.1 \quad \mathcal{S} : w(z; -\alpha) = -w,$$

and

$$32.7.2 \quad \mathcal{T}^\pm : w(z; \alpha \pm 1) = -w - \frac{2\alpha \pm 1}{2w^2 \pm 2w' + z},$$

furnish solutions of  $P_{\text{II}}$ , provided that  $\alpha \neq \mp \frac{1}{2}$ .  $P_{\text{II}}$  also has the special transformation

$$32.7.3 \quad W(\zeta; \frac{1}{2}\varepsilon) = \frac{2^{-1/3}\varepsilon}{w(z; 0)} \frac{d}{dz} w(z; 0),$$

or equivalently,

32.7.4

$$w^2(z; 0) = 2^{-1/3} \left( W^2(\zeta; \frac{1}{2}\varepsilon) - \varepsilon \frac{d}{d\zeta} W(\zeta; \frac{1}{2}\varepsilon) + \frac{1}{2}\zeta \right),$$

with  $\zeta = -2^{1/3}z$  and  $\varepsilon = \pm 1$ , where  $W(\zeta; \frac{1}{2}\varepsilon)$  satisfies  $P_{\text{II}}$  with  $z = \zeta$ ,  $\alpha = \frac{1}{2}\varepsilon$ , and  $w(z; 0)$  satisfies  $P_{\text{II}}$  with  $\alpha = 0$ .

The solutions  $w_\alpha = w(z; \alpha)$ ,  $w_{\alpha \pm 1} = w(z; \alpha \pm 1)$ , satisfy the nonlinear recurrence relation

$$32.7.5 \quad \frac{\alpha + \frac{1}{2}}{w_{\alpha+1} + w_\alpha} + \frac{\alpha - \frac{1}{2}}{w_\alpha + w_{\alpha-1}} + 2w_\alpha^2 + z = 0.$$

See Fokas *et al.* (1993).

**32.7(iii) Third Painlevé Equation**

Let  $w_j = w(z; \alpha_j, \beta_j, \gamma_j, \delta_j)$ ,  $j = 0, 1, 2$ , be solutions of  $P_{III}$  with

$$32.7.6 \quad (\alpha_1, \beta_1, \gamma_1, \delta_1) = (-\alpha_0, -\beta_0, \gamma_0, \delta_0),$$

$$32.7.7 \quad (\alpha_2, \beta_2, \gamma_2, \delta_2) = (-\beta_0, -\alpha_0, -\delta_0, -\gamma_0).$$

Then

$$32.7.8 \quad \mathcal{S}_1 : w_1 = -w_0,$$

$$32.7.9 \quad \mathcal{S}_2 : w_2 = 1/w_0.$$

Next, let  $W_j = W(z; \alpha_j, \beta_j, 1, -1)$ ,  $j = 0, 1, 2, 3, 4$ , be solutions of  $P_{III}$  with

$$32.7.10 \quad \alpha_1 = \alpha_3 = \alpha_0 + 2, \quad \alpha_2 = \alpha_4 = \alpha_0 - 2, \\ \beta_1 = \beta_2 = \beta_0 + 2, \quad \beta_3 = \beta_4 = \beta_0 - 2.$$

Then

$$32.7.11 \quad \mathcal{T}_1 : W_1 = \frac{zW'_0 + zW_0^2 - \beta W_0 - W_0 + z}{W_0(zW'_0 + zW_0^2 + \alpha W_0 + W_0 + z)},$$

$$32.7.12 \quad \mathcal{T}_2 : W_2 = -\frac{zW'_0 - zW_0^2 - \beta W_0 - W_0 + z}{W_0(zW'_0 - zW_0^2 - \alpha W_0 + W_0 + z)},$$

$$32.7.13 \quad \mathcal{T}_3 : W_3 = -\frac{zW'_0 + zW_0^2 + \beta W_0 - W_0 - z}{W_0(zW'_0 + zW_0^2 + \alpha W_0 + W_0 - z)},$$

$$32.7.14 \quad \mathcal{T}_4 : W_4 = \frac{zW'_0 - zW_0^2 + \beta W_0 - W_0 - z}{W_0(zW'_0 - zW_0^2 - \alpha W_0 + W_0 - z)}.$$

See Milne *et al.* (1997).

If  $\gamma = 0$  and  $\alpha\delta \neq 0$ , then set  $\alpha = 1$  and  $\delta = -1$ , without loss of generality. Let  $u_j = w(z; 1, \beta_j, 0, -1)$ ,  $j = 0, 5, 6$ , be solutions of  $P_{III}$  with

$$32.7.15 \quad \beta_5 = \beta_0 + 2, \quad \beta_6 = \beta_0 - 2.$$

Then

$$32.7.16 \quad \mathcal{T}_5 : u_5 = (zu'_0 + z - (\beta_0 + 1)u_0)/u_0^2,$$

$$32.7.17 \quad \mathcal{T}_6 : u_6 = -(zu'_0 - z + (\beta_0 - 1)u_0)/u_0^2.$$

Similar results hold for  $P_{III}$  with  $\delta = 0$  and  $\beta\gamma \neq 0$ .

Furthermore,

$$32.7.18 \quad w(z; a, b, 0, 0) = W^2(\zeta; 0, 0, a, b), \quad z = \frac{1}{2}\zeta^2.$$

**32.7(iv) Fourth Painlevé Equation**

Let  $w_0 = w(z; \alpha_0, \beta_0)$  and  $w_j^\pm = w(z; \alpha_j^\pm, \beta_j^\pm)$ ,  $j = 1, 2, 3, 4$ , be solutions of  $P_{IV}$  with

$$32.7.19 \quad \alpha_1^\pm = \frac{1}{4} \left( 2 - 2\alpha_0 \pm 3\sqrt{-2\beta_0} \right), \\ \beta_1^\pm = -\frac{1}{2} \left( 1 + \alpha_0 \pm \frac{1}{2}\sqrt{-2\beta_0} \right)^2, \\ \alpha_2^\pm = -\frac{1}{4} \left( 2 + 2\alpha_0 \pm 3\sqrt{-2\beta_0} \right), \\ \beta_2^\pm = -\frac{1}{2} \left( 1 - \alpha_0 \pm \frac{1}{2}\sqrt{-2\beta_0} \right)^2, \\ \alpha_3^\pm = \frac{3}{2} - \frac{1}{2}\alpha_0 \mp \frac{3}{4}\sqrt{-2\beta_0}, \\ \beta_3^\pm = -\frac{1}{2} \left( 1 - \alpha_0 \pm \frac{1}{2}\sqrt{-2\beta_0} \right)^2, \\ \alpha_4^\pm = -\frac{3}{2} - \frac{1}{2}\alpha_0 \mp \frac{3}{4}\sqrt{-2\beta_0}, \\ \beta_4^\pm = -\frac{1}{2} \left( -1 - \alpha_0 \pm \frac{1}{2}\sqrt{-2\beta_0} \right)^2.$$

Then

$$32.7.20 \quad \mathcal{T}_1^\pm : w_1^\pm = \frac{w'_0 - w_0^2 - 2zw_0 \mp \sqrt{-2\beta_0}}{2w_0},$$

$$32.7.21 \quad \mathcal{T}_2^\pm : w_2^\pm = -\frac{w'_0 + w_0^2 + 2zw_0 \mp \sqrt{-2\beta_0}}{2w_0},$$

$$32.7.22 \quad \mathcal{T}_3^\pm : w_3^\pm = w_0 + \frac{2(1 - \alpha_0 \mp \frac{1}{2}\sqrt{-2\beta_0})w_0}{w'_0 \pm \sqrt{-2\beta_0} + 2zw_0 + w_0^2},$$

$$32.7.23 \quad \mathcal{T}_4^\pm : w_4^\pm = w_0 + \frac{2(1 + \alpha_0 \pm \frac{1}{2}\sqrt{-2\beta_0})w_0}{w'_0 \mp \sqrt{-2\beta_0} - 2zw_0 - w_0^2},$$

valid when the denominators are nonzero, and where the upper signs or the lower signs are taken throughout each transformation. See Bassom *et al.* (1995).

**32.7(v) Fifth Painlevé Equation**

Let  $w_j(z_j) = w(z_j; \alpha_j, \beta_j, \gamma_j, \delta_j)$ ,  $j = 0, 1, 2$ , be solutions of  $P_V$  with

$$32.7.24 \quad z_1 = -z_0, \quad z_2 = z_0, \quad (\alpha_1, \beta_1, \gamma_1, \delta_1) = (\alpha_0, \beta_0, -\gamma_0, \delta_0), \\ (\alpha_2, \beta_2, \gamma_2, \delta_2) = (-\beta_0, -\alpha_0, -\gamma_0, \delta_0).$$

Then

$$32.7.25 \quad \mathcal{S}_1 : w_1(z_1) = w(z_0),$$

$$32.7.26 \quad \mathcal{S}_2 : w_2(z_2) = 1/w(z_0).$$

Let  $W_0 = W(z; \alpha_0, \beta_0, \gamma_0, -\frac{1}{2})$  and  $W_1 = W(z; \alpha_1, \beta_1, \gamma_1, -\frac{1}{2})$  be solutions of  $P_V$ , where

$$32.7.27 \quad \alpha_1 = \frac{1}{8} \left( \gamma_0 + \varepsilon_1 \left( 1 - \varepsilon_3 \sqrt{-2\beta_0} - \varepsilon_2 \sqrt{2\alpha_0} \right) \right)^2, \\ \beta_1 = -\frac{1}{8} \left( \gamma_0 - \varepsilon_1 \left( 1 - \varepsilon_3 \sqrt{-2\beta_0} - \varepsilon_2 \sqrt{2\alpha_0} \right) \right)^2, \\ \gamma_1 = \varepsilon_1 \left( \varepsilon_3 \sqrt{-2\beta_0} - \varepsilon_2 \sqrt{2\alpha_0} \right),$$

and  $\varepsilon_j = \pm 1, j = 1, 2, 3$ , independently. Also let

$$\begin{aligned} \Phi &= zW'_0 - \varepsilon_2\sqrt{2\alpha_0}W_0^2 + \varepsilon_3\sqrt{-2\beta_0} \\ 32.7.28 \quad &+ \left( \varepsilon_2\sqrt{2\alpha_0} - \varepsilon_3\sqrt{-2\beta_0} + \varepsilon_1z \right) W_0, \end{aligned}$$

and assume  $\Phi \neq 0$ . Then

$$32.7.29 \quad \mathcal{T}_{\varepsilon_1, \varepsilon_2, \varepsilon_3} : W_1 = (\Phi - 2\varepsilon_1zW_0)/\Phi,$$

provided that the numerator on the right-hand side does not vanish. Again, since  $\varepsilon_j = \pm 1, j = 1, 2, 3$ , independently, there are eight distinct transformations of type  $\mathcal{T}_{\varepsilon_1, \varepsilon_2, \varepsilon_3}$ .

**32.7(vi) Relationship Between the Third and Fifth Painlevé Equations**

Let  $w = w(z; \alpha, \beta, 1, -1)$  be a solution of  $P_{III}$  and

$$32.7.30 \quad v = w' - \varepsilon w^2 + ((1 - \varepsilon\alpha)w/z),$$

with  $\varepsilon = \pm 1$ . Then

$$32.7.31 \quad W(\zeta; \alpha_0, \beta_0, \gamma_0, \delta_0) = \frac{v-1}{v+1}, \quad z = \sqrt{2\zeta},$$

satisfies  $P_V$  with

$$\begin{aligned} 32.7.32 \quad &(\alpha_0, \beta_0, \gamma_0, \delta_0) \\ &= ((\beta - \varepsilon\alpha + 2)^2/32, -(\beta + \varepsilon\alpha - 2)^2/32, -\varepsilon, 0). \end{aligned}$$

**32.7(vii) Sixth Painlevé Equation**

Let  $w_j(z_j) = w_j(z_j; \alpha_j, \beta_j, \gamma_j, \delta_j), j = 0, 1, 2, 3$ , be solutions of  $P_{VI}$  with

$$32.7.33 \quad z_1 = 1/z_0,$$

$$32.7.34 \quad z_2 = 1 - z_0,$$

$$32.7.35 \quad z_3 = 1/z_0,$$

$$32.7.36 \quad (\alpha_1, \beta_1, \gamma_1, \delta_1) = (\alpha_0, \beta_0, -\delta_0 + \frac{1}{2}, -\gamma_0 + \frac{1}{2}),$$

$$32.7.37 \quad (\alpha_2, \beta_2, \gamma_2, \delta_2) = (\alpha_0, -\gamma_0, -\beta_0, \delta_0),$$

$$32.7.38 \quad (\alpha_3, \beta_3, \gamma_3, \delta_3) = (-\beta_0, -\alpha_0, \gamma_0, \delta_0).$$

Then

$$32.7.39 \quad \mathcal{S}_1 : w_1(z_1) = w_0(z_0)/z_0,$$

$$32.7.40 \quad \mathcal{S}_2 : w_2(z_2) = 1 - w_0(z_0),$$

$$32.7.41 \quad \mathcal{S}_3 : w_3(z_3) = 1/w_0(z_0).$$

The transformations  $\mathcal{S}_j$ , for  $j = 1, 2, 3$ , generate a group of order 24. See Iwasaki *et al.* (1991, p. 127).

Let  $w(z; \alpha, \beta, \gamma, \delta)$  and  $W(z; A, B, C, D)$  be solutions of  $P_{VI}$  with

$$32.7.42 \quad (\alpha, \beta, \gamma, \delta) = (\frac{1}{2}(\theta_\infty - 1)^2, -\frac{1}{2}\theta_0^2, \frac{1}{2}\theta_1^2, \frac{1}{2}(1 - \theta_2^2)),$$

**32.7.43**

$$(A, B, C, D) = (\frac{1}{2}(\Theta_\infty - 1)^2, -\frac{1}{2}\Theta_0^2, \frac{1}{2}\Theta_1^2, \frac{1}{2}(1 - \Theta_2^2)),$$

and

$$32.7.44 \quad \theta_j = \Theta_j + \frac{1}{2}\sigma,$$

for  $j = 0, 1, 2, \infty$ , where

**32.7.45**

$$\sigma = \theta_0 + \theta_1 + \theta_2 + \theta_\infty - 1 = 1 - (\Theta_0 + \Theta_1 + \Theta_2 + \Theta_\infty).$$

Then

**32.7.46**

$$\begin{aligned} \frac{\sigma}{w - W} &= \frac{z(z-1)W'}{W(W-1)(W-z)} + \frac{\Theta_0}{W} + \frac{\Theta_1}{W-1} + \frac{\Theta_2-1}{W-z} \\ &= \frac{z(z-1)w'}{w(w-1)(w-z)} + \frac{\theta_0}{w} + \frac{\theta_1}{w-1} + \frac{\theta_2-1}{w-z}. \end{aligned}$$

$P_{VI}$  also has quadratic and quartic transformations. Let  $w = w(z; \alpha, \beta, \gamma, \delta)$  be a solution of  $P_{VI}$ . The quadratic transformation

$$32.7.47 \quad u_1(\zeta_1) = \frac{(1-w)(w-z)}{(1+\sqrt{z})^2w}, \quad \zeta_1 = \left( \frac{1-\sqrt{z}}{1+\sqrt{z}} \right)^2,$$

transforms  $P_{VI}$  with  $\alpha = -\beta$  and  $\gamma = \frac{1}{2} - \delta$  to  $P_{VI}$  with  $(\alpha_1, \beta_1, \gamma_1, \delta_1) = (4\alpha, -4\gamma, 0, \frac{1}{2})$ . The quartic transformation

$$32.7.48 \quad u_2(\zeta_2) = \frac{(w^2 - z)^2}{4w(w-1)(w-z)}, \quad \zeta_2 = z,$$

transforms  $P_{VI}$  with  $\alpha = -\beta = \gamma = \frac{1}{2} - \delta$  to  $P_{VI}$  with  $(\alpha_2, \beta_2, \gamma_2, \delta_2) = (16\alpha, 0, 0, \frac{1}{2})$ . Also,

$$32.7.49 \quad u_3(\zeta_3) = \left( \frac{1 - z^{1/4}}{1 + z^{1/4}} \right)^2 \left( \frac{\sqrt{w} + z^{1/4}}{\sqrt{w} - z^{1/4}} \right)^2,$$

$$32.7.50 \quad \zeta_3 = \left( \frac{1 - z^{1/4}}{1 + z^{1/4}} \right)^4,$$

transforms  $P_{VI}$  with  $\alpha = \beta = 0$  and  $\gamma = \frac{1}{2} - \delta$  to  $P_{VI}$  with  $\alpha_3 = \beta_3$  and  $\gamma_3 = \frac{1}{2} - \delta_3$ .

**32.7(viii) Affine Weyl Groups**

See Okamoto (1986, 1987a,b,c), Sakai (2001), Umemura (2000).

**32.8 Rational Solutions**

**32.8(i) Introduction**

$P_{II}$ – $P_{VI}$  possess hierarchies of rational solutions for special values of the parameters which are generated from “seed solutions” using the Bäcklund transformations and often can be expressed in the form of determinants. See Airault (1979).

### 32.8(ii) Second Painlevé Equation

Rational solutions of  $P_{II}$  exist for  $\alpha = n (\in \mathbb{Z})$  and are generated using the seed solution  $w(z; 0) = 0$  and the Bäcklund transformations (32.7.1) and (32.7.2). The first four are

32.8.1  $w(z; 1) = -1/z,$

32.8.2  $w(z; 2) = \frac{1}{z} - \frac{3z^2}{z^3 + 4},$

32.8.3  $w(z; 3) = \frac{3z^2}{z^3 + 4} - \frac{6z^2(z^3 + 10)}{z^6 + 20z^3 - 80},$

32.8.4  $w(z; 4) = -\frac{1}{z} + \frac{6z^2(z^3 + 10)}{z^6 + 20z^3 - 80} - \frac{9z^5(z^3 + 40)}{z^9 + 60z^6 + 11200}.$

More generally,

32.8.5  $w(z; n) = \frac{d}{dz} \left( \ln \left( \frac{Q_{n-1}(z)}{Q_n(z)} \right) \right),$

where the  $Q_n(z)$  are monic polynomials (coefficient of highest power of  $z$  is 1) satisfying

32.8.6  $Q_{n+1}(z)Q_{n-1}(z) = zQ_n^2(z) + 4(Q'_n(z))^2 - 4Q_n(z)Q''_n(z),$

with  $Q_0(z) = 1, Q_1(z) = z$ . Thus

$$\begin{aligned} Q_2(z) &= z^3 + 4, \\ Q_3(z) &= z^6 + 20z^3 - 80, \\ Q_4(z) &= z^{10} + 60z^7 + 11200z, \\ 32.8.7 \quad Q_5(z) &= z^{15} + 140z^{12} + 2800z^9 + 78400z^6 \\ &\quad - 3\,13600z^3 - 62\,72000, \\ Q_6(z) &= z^{21} + 280z^{18} + 18480z^{15} + 6\,27200z^{12} \\ &\quad - 172\,48000z^9 + 14488\,32000z^6 \\ &\quad + 1\,93177\,60000z^3 - 3\,86355\,20000. \end{aligned}$$

Next, let  $p_m(z)$  be the polynomials defined by  $p_m(z) = 0$  for  $m < 0$ , and

32.8.8  $\sum_{m=0}^{\infty} p_m(z)\lambda^m = \exp(z\lambda - \frac{4}{3}\lambda^3).$

Then for  $n \geq 2$

32.8.9  $w(z; n) = \frac{d}{dz} \left( \ln \left( \frac{\tau_{n-1}(z)}{\tau_n(z)} \right) \right),$

where  $\tau_n(z)$  is the  $n \times n$  determinant

32.8.10 
$$\tau_n(z) = \begin{vmatrix} p_1(z) & p_3(z) & \cdots & p_{2n-1}(z) \\ p'_1(z) & p'_3(z) & \cdots & p'_{2n-1}(z) \\ \vdots & \vdots & \ddots & \vdots \\ p_1^{(n-1)}(z) & p_3^{(n-1)}(z) & \cdots & p_{2n-1}^{(n-1)}(z) \end{vmatrix}.$$

For plots of the zeros of  $Q_n(z)$  see Clarkson and Mansfield (2003).

### 32.8(iii) Third Painlevé Equation

Special rational solutions of  $P_{III}$  are

32.8.11  $w(z; \mu, -\mu\kappa^2, \lambda, -\lambda\kappa^4) = \kappa,$

32.8.12  $w(z; 0, -\mu, 0, \mu\kappa) = \kappa z,$

32.8.13  $w(z; 2\kappa + 3, -2\kappa + 1, 1, -1) = \frac{z + \kappa}{z + \kappa + 1},$

with  $\kappa, \lambda$ , and  $\mu$  arbitrary constants.

In the general case assume  $\gamma\delta \neq 0$ , so that as in §32.2(ii) we may set  $\gamma = 1$  and  $\delta = -1$ . Then  $P_{III}$  has rational solutions iff

32.8.14  $\alpha \pm \beta = 4n,$

with  $n \in \mathbb{Z}$ . These solutions have the form

32.8.15  $w(z) = P_m(z)/Q_m(z),$

where  $P_m(z)$  and  $Q_m(z)$  are polynomials of degree  $m$ , with no common zeros.

For examples and plots see Milne *et al.* (1997); also Clarkson (2003a). For determinantal representations see Kajiwara and Masuda (1999).

### 32.8(iv) Fourth Painlevé Equation

Special rational solutions of  $P_{IV}$  are

32.8.16  $w_1(z; \pm 2, -2) = \pm 1/z,$

32.8.17  $w_2(z; 0, -2) = -2z,$

32.8.18  $w_3(z; 0, -\frac{2}{9}) = -\frac{2}{3}z.$

There are also three families of solutions of  $P_{IV}$  of the form

32.8.19  $w_1(z; \alpha_1, \beta_1) = P_{1,n-1}(z)/Q_{1,n}(z),$

32.8.20  $w_2(z; \alpha_2, \beta_2) = -2z + (P_{2,n-1}(z)/Q_{2,n}(z)),$

32.8.21  $w_3(z; \alpha_3, \beta_3) = -\frac{2}{3}z + (P_{3,n-1}(z)/Q_{3,n}(z)),$

where  $P_{j,n-1}(z)$  and  $Q_{j,n}(z)$  are polynomials of degrees  $n - 1$  and  $n$ , respectively, with no common zeros.

In general,  $P_{IV}$  has rational solutions iff either

32.8.22  $\alpha = m, \quad \beta = -2(1 + 2n - m)^2,$

or

32.8.23  $\alpha = m, \quad \beta = -2(\frac{1}{3} + 2n - m)^2,$

with  $m, n \in \mathbb{Z}$ . The rational solutions when the parameters satisfy (32.8.22) are special cases of §32.10(iv).

For examples and plots see Bassom *et al.* (1995); also Clarkson (2003b). For determinantal representations see Kajiwara and Ohta (1998) and Noumi and Yamada (1999).

### 32.8(v) Fifth Painlevé Equation

Special rational solutions of  $P_V$  are

$$32.8.24 \quad w(z; \frac{1}{2}, -\frac{1}{2}\mu^2, \kappa(2-\mu), -\frac{1}{2}\kappa^2) = \kappa z + \mu,$$

$$32.8.25 \quad w(z; \frac{1}{2}, \kappa^2\mu, 2\kappa\mu, \mu) = \kappa/(z + \kappa),$$

$$32.8.26 \quad w(z; \frac{1}{8}, -\frac{1}{8}, -\kappa\mu, \mu) = (\kappa + z)/(\kappa - z),$$

with  $\kappa$  and  $\mu$  arbitrary constants.

In the general case assume  $\delta \neq 0$ , so that as in §32.2(ii) we may set  $\delta = -\frac{1}{2}$ . Then  $P_V$  has a rational solution iff one of the following holds with  $m, n \in \mathbb{Z}$  and  $\varepsilon = \pm 1$ :

- (a)  $\alpha = \frac{1}{2}(m + \varepsilon\gamma)^2$  and  $\beta = -\frac{1}{2}n^2$ , where  $n > 0$ ,  $m + n$  is odd, and  $\alpha \neq 0$  when  $|m| < n$ .
- (b)  $\alpha = \frac{1}{2}n^2$  and  $\beta = -\frac{1}{2}(m + \varepsilon\gamma)^2$ , where  $n > 0$ ,  $m + n$  is odd, and  $\beta \neq 0$  when  $|m| < n$ .
- (c)  $\alpha = \frac{1}{2}a^2$ ,  $\beta = -\frac{1}{2}(a + n)^2$ , and  $\gamma = m$ , with  $m + n$  even.
- (d)  $\alpha = \frac{1}{2}(b + n)^2$ ,  $\beta = -\frac{1}{2}b^2$ , and  $\gamma = m$ , with  $m + n$  even.
- (e)  $\alpha = \frac{1}{8}(2m + 1)^2$ ,  $\beta = -\frac{1}{8}(2n + 1)^2$ , and  $\gamma \notin \mathbb{Z}$ .

These rational solutions have the form

$$32.8.27 \quad w(z) = \lambda z + \mu + (P_{n-1}(z)/Q_n(z)),$$

where  $\lambda, \mu$  are constants, and  $P_{n-1}(z), Q_n(z)$  are polynomials of degrees  $n - 1$  and  $n$ , respectively, with no common zeros. Cases (a) and (b) are special cases of §32.10(v).

For examples and plots see Clarkson (2005). For determinantal representations see Masuda *et al.* (2002). For the case  $\delta = 0$  see Airault (1979) and Lukašević (1968).

### 32.8(vi) Sixth Painlevé Equation

Special rational solutions of  $P_{VI}$  are

$$32.8.28 \quad w(z; \mu, -\mu\kappa^2, \frac{1}{2}, \frac{1}{2} - \mu(\kappa - 1)^2) = \kappa z,$$

$$32.8.29 \quad w(z; 0, 0, 2, 0) = \kappa z^2,$$

$$32.8.30 \quad w(z; 0, 0, \frac{1}{2}, -\frac{3}{2}) = \kappa/z,$$

$$32.8.31 \quad w(z; 0, 0, 2, -4) = \kappa/z^2,$$

$$32.8.32 \quad w(z; \frac{1}{2}(\kappa + \mu)^2, -\frac{1}{2}, \frac{1}{2}(\mu - 1)^2, \frac{1}{2}\kappa(2 - \kappa)) = \frac{z}{\kappa + \mu z},$$

with  $\kappa$  and  $\mu$  arbitrary constants.

In the general case,  $P_{VI}$  has rational solutions if

$$32.8.33 \quad a + b + c + d = 2n + 1,$$

where  $n \in \mathbb{Z}$ ,  $a = \varepsilon_1\sqrt{2\alpha}$ ,  $b = \varepsilon_2\sqrt{-2\beta}$ ,  $c = \varepsilon_3\sqrt{2\gamma}$ , and  $d = \varepsilon_4\sqrt{1 - 2\delta}$ , with  $\varepsilon_j = \pm 1$ ,  $j = 1, 2, 3, 4$ , independently, and at least one of  $a, b, c$  or  $d$  is an integer. These are special cases of §32.10(vi).

## 32.9 Other Elementary Solutions

### 32.9(i) Third Painlevé Equation

Elementary nonrational solutions of  $P_{III}$  are

$$32.9.1 \quad w(z; \mu, 0, 0, -\mu\kappa^3) = \kappa z^{1/3},$$

$$32.9.2 \quad w(z; 0, -2\kappa, 0, 4\kappa\mu - \lambda^2) = z(\kappa(\ln z)^2 + \lambda \ln z + \mu),$$

$$32.9.3 \quad w(z; -\nu^2\lambda, 0, \nu^2(\lambda^2 - 4\kappa\mu), 0) = \frac{z^{\nu-1}}{\kappa z^{2\nu} + \lambda z^\nu + \mu},$$

with  $\kappa, \lambda, \mu$ , and  $\nu$  arbitrary constants.

In the case  $\gamma = 0$  and  $\alpha\delta \neq 0$  we assume, as in §32.2(ii),  $\alpha = 1$  and  $\delta = -1$ . Then  $P_{III}$  has algebraic solutions iff

$$32.9.4 \quad \beta = 2n,$$

with  $n \in \mathbb{Z}$ . These are rational solutions in  $\zeta = z^{1/3}$  of the form

$$32.9.5 \quad w(z) = P_{n^2+1}(\zeta)/Q_{n^2}(\zeta),$$

where  $P_{n^2+1}(\zeta)$  and  $Q_{n^2}(\zeta)$  are polynomials of degrees  $n^2 + 1$  and  $n^2$ , respectively, with no common zeros. For examples and plots see Clarkson (2003a) and Milne *et al.* (1997). Similar results hold when  $\delta = 0$  and  $\beta\gamma \neq 0$ .

$P_{III}$  with  $\beta = \delta = 0$  has a first integral

$$32.9.6 \quad z^2(w')^2 + 2zww' = (C + 2\alpha zw + \gamma z^2 w^2)w^2,$$

with  $C$  an arbitrary constant, which is solvable by quadrature. A similar result holds when  $\alpha = \gamma = 0$ .  $P_{III}$  with  $\alpha = \beta = \gamma = \delta = 0$ , has the general solution  $w(z) = Cz^\mu$ , with  $C$  and  $\mu$  arbitrary constants.

### 32.9(ii) Fifth Painlevé Equation

Elementary nonrational solutions of  $P_V$  are

$$32.9.7 \quad w(z; \mu, -\frac{1}{8}, -\mu\kappa^2, 0) = 1 + \kappa z^{1/2},$$

$$32.9.8 \quad w(z; 0, 0, \mu, -\frac{1}{2}\mu^2) = \kappa \exp(\mu z),$$

with  $\kappa$  and  $\mu$  arbitrary constants.

$P_V$ , with  $\delta = 0$ , has algebraic solutions if either

$$32.9.9 \quad (\alpha, \beta, \gamma) = (\frac{1}{2}\mu^2, -\frac{1}{8}(2n - 1)^2, -1),$$

or

$$32.9.10 \quad (\alpha, \beta, \gamma) = (\frac{1}{8}(2n - 1)^2, -\frac{1}{2}\mu^2, 1),$$

with  $n \in \mathbb{Z}$  and  $\mu$  arbitrary. These are rational solutions in  $\zeta = z^{1/2}$  of the form

$$32.9.11 \quad w(z) = P_{n^2-n+1}(\zeta)/Q_{n^2-n}(\zeta),$$

where  $P_{n^2-n+1}(\zeta)$  and  $Q_{n^2-n}(\zeta)$  are polynomials of degrees  $n^2 - n + 1$  and  $n^2 - n$ , respectively, with no common zeros.

$P_V$ , with  $\gamma = \delta = 0$ , has a first integral

$$32.9.12 \quad z^2(w')^2 = (w - 1)^2(2\alpha w^2 + Cw - 2\beta),$$

with  $C$  an arbitrary constant, which is solvable by quadrature. For examples and plots see Clarkson (2005).  $P_V$ , with  $\alpha = \beta = 0$  and  $\gamma^2 + 2\delta = 0$ , has solutions  $w(z) = C \exp(\pm\sqrt{-2\delta}z)$ , with  $C$  an arbitrary constant.

### 32.9(iii) Sixth Painlevé Equation

An elementary algebraic solution of  $P_{VI}$  is

$$32.9.13 \quad w(z; \frac{1}{2}\kappa^2, -\frac{1}{2}\kappa^2, \frac{1}{2}\mu^2, \frac{1}{2}(1 - \mu^2)) = z^{1/2},$$

with  $\kappa$  and  $\mu$  arbitrary constants.

Dubrovin and Mazzocco (2000) classifies all algebraic solutions for the special case of  $P_{VI}$  with  $\beta = \gamma = 0$ ,  $\delta = \frac{1}{2}$ . For further examples of algebraic solutions see Andreev and Kitaev (2002), Boalch (2005, 2006), Gromak *et al.* (2002, §48), Hitchin (2003), Masuda (2003), and Mazzocco (2001b).

## 32.10 Special Function Solutions

### 32.10(i) Introduction

For certain combinations of the parameters,  $P_{II}$ – $P_{VI}$  have particular solutions expressible in terms of the solution of a Riccati differential equation, which can be solved in terms of special functions defined in other chapters. All solutions of  $P_{II}$ – $P_{VI}$  that are expressible in terms of special functions satisfy a first-order equation of the form

$$32.10.1 \quad (w')^n + \sum_{j=0}^{n-1} F_j(w, z)(w')^j = 0,$$

where  $F_j(w, z)$  is polynomial in  $w$  with coefficients that are rational functions of  $z$ .

### 32.10(ii) Second Painlevé Equation

$P_{II}$  has solutions expressible in terms of Airy functions (§9.2) iff

$$32.10.2 \quad \alpha = n + \frac{1}{2},$$

with  $n \in \mathbb{Z}$ . For example, if  $\alpha = \frac{1}{2}\varepsilon$ , with  $\varepsilon = \pm 1$ , then the Riccati equation is

$$32.10.3 \quad \varepsilon w' = w^2 + \frac{1}{2}z,$$

with solution

$$32.10.4 \quad w(z; \frac{1}{2}\varepsilon) = -\varepsilon\phi'(z)/\phi(z),$$

where

$$32.10.5 \quad \phi(z) = C_1 \text{Ai}(-2^{-1/3}z) + C_2 \text{Bi}(-2^{-1/3}z),$$

with  $C_1, C_2$  arbitrary constants.

Solutions for other values of  $\alpha$  are derived from  $w(z; \pm\frac{1}{2})$  by application of the Bäcklund transformations (32.7.1) and (32.7.2). For example,

$$32.10.6 \quad w(z; \frac{3}{2}) = \Phi - \frac{1}{2\Phi^2 + z},$$

$$32.10.7 \quad w(z; \frac{5}{2}) = \frac{1}{2\Phi^2 + z} + \frac{2z\Phi^2 + \Phi + z^2}{4\Phi^3 + 2z\Phi - 1},$$

where  $\Phi = \phi'(z)/\phi(z)$ , with  $\phi(z)$  given by (32.10.5).

More generally, if  $n = 1, 2, 3, \dots$ , then

$$32.10.8 \quad w(z; n + \frac{1}{2}) = \frac{d}{dz} \left( \ln \left( \frac{\tau_n(z)}{\tau_{n+1}(z)} \right) \right),$$

where  $\tau_n(z)$  is the  $n \times n$  determinant

$$32.10.9 \quad \tau_n(z) = \begin{vmatrix} \phi(z) & \phi'(z) & \cdots & \phi^{(n-1)}(z) \\ \phi'(z) & \phi''(z) & \cdots & \phi^{(n)}(z) \\ \vdots & \vdots & \ddots & \vdots \\ \phi^{(n-1)}(z) & \phi^{(n)}(z) & \cdots & \phi^{(2n-2)}(z) \end{vmatrix},$$

and

$$32.10.10 \quad w(z; -n - \frac{1}{2}) = -w(z; n + \frac{1}{2}).$$

### 32.10(iii) Third Painlevé Equation

If  $\gamma\delta \neq 0$ , then as in §32.2(ii) we may set  $\gamma = 1$  and  $\delta = -1$ .  $P_{III}$  then has solutions expressible in terms of Bessel functions (§10.2) iff

$$32.10.11 \quad \varepsilon_1\alpha + \varepsilon_2\beta = 4n + 2,$$

with  $n \in \mathbb{Z}$ , and  $\varepsilon_1 = \pm 1$ ,  $\varepsilon_2 = \pm 1$ , independently. In the case  $\varepsilon_1\alpha + \varepsilon_2\beta = 2$ , the Riccati equation is

$$32.10.12 \quad zw' = \varepsilon_1zw^2 + (\alpha\varepsilon_1 - 1)w + \varepsilon_2z.$$

If  $\alpha \neq \varepsilon_1$ , then (32.10.12) has the solution

$$32.10.13 \quad w(z) = -\varepsilon_1\phi'(z)/\phi(z),$$

where

$$32.10.14 \quad \phi(z) = z^\nu (C_1 J_\nu(\zeta) + C_2 Y_\nu(\zeta)),$$

with  $\zeta = \sqrt{\varepsilon_1\varepsilon_2}z$ ,  $\nu = \frac{1}{2}\alpha\varepsilon_1$ , and  $C_1, C_2$  arbitrary constants.

For examples and plots see Milne *et al.* (1997). For determinantal representations see Forrester and Witte (2002) and Okamoto (1987c).

### 32.10(iv) Fourth Painlevé Equation

$P_{IV}$  has solutions expressible in terms of parabolic cylinder functions (§12.2) iff either

$$32.10.15 \quad \beta = -2(2n + 1 + \varepsilon\alpha)^2,$$

or

$$32.10.16 \quad \beta = -2n^2,$$

with  $n \in \mathbb{Z}$  and  $\varepsilon = \pm 1$ . In the case when  $n = 0$  in (32.10.15), the Riccati equation is

$$32.10.17 \quad w' = \varepsilon(w^2 + 2zw) - 2(1 + \varepsilon\alpha),$$

which has the solution

$$32.10.18 \quad w(z) = -\varepsilon\phi'(z)/\phi(z),$$



where

**32.10.19**

$$\phi(z) = \left( C_1 U(a, \sqrt{2z}) + C_2 V(a, \sqrt{2z}) \right) \exp\left(\frac{1}{2}\varepsilon z^2\right),$$

with  $a = \alpha + \frac{1}{2}\varepsilon$ , and  $C_1, C_2$  arbitrary constants. When  $a + \frac{1}{2}$  is zero or a negative integer the  $U$  parabolic cylinder functions reduce to Hermite polynomials (§18.3) times an exponential function; thus

**32.10.20**

$$w(z; -m, -2(m-1)^2) = -\frac{H'_{m-1}(z)}{H_{m-1}(z)}, \quad m = 1, 2, 3, \dots,$$

and

**32.10.21**

$$w(z; -m, -2(m+1)^2) = -2z + \frac{H'_m(z)}{H_m(z)}, \quad m = 0, 1, 2, \dots$$

If  $1 + \varepsilon\alpha = 0$ , then (32.10.17) has solutions

$$32.10.22 \quad w(z) = \begin{cases} \frac{2 \exp(z^2)}{\sqrt{\pi}(C - i \operatorname{erfc}(iz))}, & \varepsilon = 1, \\ \frac{2 \exp(-z^2)}{\sqrt{\pi}(C - \operatorname{erfc}(z))}, & \varepsilon = -1, \end{cases}$$

where  $C$  is an arbitrary constant and  $\operatorname{erfc}$  is the complementary error function (§7.2(i)).

For examples and plots see Bassom *et al.* (1995). For determinantal representations see Forrester and Witte (2001) and Okamoto (1986).

**32.10(v) Fifth Painlevé Equation**

If  $\delta \neq 0$ , then as in §32.2(ii) we may set  $\delta = -\frac{1}{2}$ .  $P_{\text{V}}$  then has solutions expressible in terms of Whittaker functions (§13.14(i)), iff

**32.10.23**  $a + b + \varepsilon_3\gamma = 2n + 1,$

or

**32.10.24**  $(a - n)(b - n) = 0,$

where  $n \in \mathbb{Z}$ ,  $a = \varepsilon_1\sqrt{2\alpha}$ , and  $b = \varepsilon_2\sqrt{-2\beta}$ , with  $\varepsilon_j = \pm 1$ ,  $j = 1, 2, 3$ , independently. In the case when  $n = 0$  in (32.10.23), the Riccati equation is

**32.10.25**  $zw' = aw^2 + (b - a + \varepsilon_3z)w - b.$

If  $a \neq 0$ , then (32.10.25) has the solution

**32.10.26**  $w(z) = -z\phi'(z)/(a\phi(z)),$

where

**32.10.27**  $\phi(z) = \frac{C_1 M_{\kappa,\mu}(\zeta) + C_2 W_{\kappa,\mu}(\zeta)}{\zeta^{(a-b+1)/2}} \exp\left(\frac{1}{2}\zeta\right),$

with  $\zeta = \varepsilon_3z$ ,  $\kappa = \frac{1}{2}(a - b + 1)$ ,  $\mu = \frac{1}{2}(a + b)$ , and  $C_1, C_2$  arbitrary constants.

For determinantal representations see Forrester and Witte (2002), Masuda (2004), and Okamoto (1987b).

**32.10(vi) Sixth Painlevé Equation**

$P_{\text{VI}}$  has solutions expressible in terms of hypergeometric functions (§15.2(i)) iff

**32.10.28**  $a + b + c + d = 2n + 1,$

where  $n \in \mathbb{Z}$ ,  $a = \varepsilon_1\sqrt{2\alpha}$ ,  $b = \varepsilon_2\sqrt{-2\beta}$ ,  $c = \varepsilon_3\sqrt{2\gamma}$ , and  $d = \varepsilon_4\sqrt{1 - 2\delta}$ , with  $\varepsilon_j = \pm 1$ ,  $j = 1, 2, 3, 4$ , independently. If  $n = 1$ , then the Riccati equation is

**32.10.29**  $w' = \frac{aw^2}{z(z-1)} + \frac{(b+c)z - a - c}{z(z-1)}w - \frac{b}{z-1}.$

If  $a \neq 0$ , then (32.10.29) has the solution

**32.10.30**  $w(z) = \frac{\zeta - 1}{a\phi(\zeta)} \frac{d\phi}{d\zeta}, \quad \zeta = \frac{1}{1-z},$

where

**32.10.31**

$$\phi(\zeta) = C_1 F(b, -a; b + c; \zeta) + C_2 \zeta^{-b+1-c} \times F(-a - b - c + 1, -c + 1; 2 - b - c; \zeta),$$

with  $C_1, C_2$  arbitrary constants.

Next, let  $\Lambda = \Lambda(u, z)$  be the elliptic function (§§22.15(ii), 23.2(iii)) defined by

**32.10.32**  $u = \int_0^\Lambda \frac{dt}{\sqrt{t(t-1)(t-z)}},$

where the fundamental periods  $2\phi_1$  and  $2\phi_2$  are linearly independent functions satisfying the hypergeometric equation

**32.10.33**  $z(1-z)\frac{d^2\phi}{dz^2} + (1-2z)\frac{d\phi}{dz} - \frac{1}{4}\phi = 0.$

Then  $P_{\text{VI}}$ , with  $\alpha = \beta = \gamma = 0$  and  $\delta = \frac{1}{2}$ , has the general solution

**32.10.34**  $w(z; 0, 0, 0, \frac{1}{2}) = \Lambda(C_1\phi_1 + C_2\phi_2, z),$

with  $C_1, C_2$  arbitrary constants. The solution (32.10.34) is an essentially transcendental function of both constants of integration since  $P_{\text{VI}}$  with  $\alpha = \beta = \gamma = 0$  and  $\delta = \frac{1}{2}$  does not admit an algebraic first integral of the form  $P(z, w, w', C) = 0$ , with  $C$  a constant.

For determinantal representations see Forrester and Witte (2004) and Masuda (2004).

**32.11 Asymptotic Approximations for Real Variables**

**32.11(i) First Painlevé Equation**

There are solutions of (32.2.1) such that

**32.11.1**  $w(x) = -\sqrt{\frac{1}{6}|x| + d|x|^{-1/8}} \sin(\phi(x) - \theta_0) + o(|x|^{-1/8}), \quad x \rightarrow -\infty,$

where

**32.11.2**  $\phi(x) = (24)^{1/4} \left( \frac{4}{3}|x|^{5/4} - \frac{5}{8}d^2 \ln|x| \right),$

and  $d$  and  $\theta_0$  are constants.

There are also solutions of (32.2.1) such that

**32.11.3** 
$$w(x) \sim \sqrt{\frac{1}{6}|x|}, \quad x \rightarrow -\infty.$$

Next, for given initial conditions  $w(0) = 0$  and  $w'(0) = k$ , with  $k$  real,  $w(x)$  has at least one pole on the real axis. There are two special values of  $k$ ,  $k_1$  and  $k_2$ , with the properties  $-0.45142\ 8 < k_1 < -0.45142\ 7$ ,  $1.85185\ 3 < k_2 < 1.85185\ 5$ , and such that:

- (a) If  $k < k_1$ , then  $w(x) > 0$  for  $x_0 < x < 0$ , where  $x_0$  is the first pole on the negative real axis.
- (b) If  $k_1 < k < k_2$ , then  $w(x)$  oscillates about, and is asymptotic to,  $-\sqrt{\frac{1}{6}|x|}$  as  $x \rightarrow -\infty$ .
- (c) If  $k_2 < k$ , then  $w(x)$  changes sign once, from positive to negative, as  $x$  passes from  $x_0$  to 0.

For illustration see Figures 32.3.1 to 32.3.4, and for further information see Joshi and Kitaev (2005), Joshi and Kruskal (1992), Kapaev (1988), Kapaev and Kitaev (1993), and Kitaev (1994).

**32.11(ii) Second Painlevé Equation**

Consider the special case of  $P_{II}$  with  $\alpha = 0$ :

**32.11.4** 
$$w'' = 2w^3 + xw,$$

with boundary condition

**32.11.5** 
$$w(x) \rightarrow 0, \quad x \rightarrow +\infty.$$

Any nontrivial real solution of (32.11.4) that satisfies (32.11.5) is asymptotic to  $k \text{Ai}(x)$ , for some nonzero real  $k$ , where  $\text{Ai}$  denotes the Airy function (§9.2). Conversely, for any nonzero real  $k$ , there is a unique solution  $w_k(x)$  of (32.11.4) that is asymptotic to  $k \text{Ai}(x)$  as  $x \rightarrow +\infty$ .

If  $|k| < 1$ , then  $w_k(x)$  exists for all sufficiently large  $|x|$  as  $x \rightarrow -\infty$ , and

**32.11.6** 
$$w_k(x) = d|x|^{-1/4} \sin(\phi(x) - \theta_0) + o(|x|^{-1/4}),$$

where

**32.11.7** 
$$\phi(x) = \frac{2}{3}|x|^{3/2} - \frac{3}{4}d^2 \ln|x|,$$

and  $d (\neq 0)$ ,  $\theta_0$  are real constants. Connection formulas for  $d$  and  $\theta_0$  are given by

**32.11.8** 
$$d^2 = -\pi^{-1} \ln(1 - k^2),$$

**32.11.9**

$$\theta_0 = \frac{3}{2}d^2 \ln 2 + \text{ph} \Gamma(1 - \frac{1}{2}id^2) + \frac{1}{4}\pi(1 - 2 \text{sign}(k)),$$

where  $\Gamma$  is the gamma function (§5.2(i)), and the branch of the  $\text{ph}$  function is immaterial.

If  $|k| = 1$ , then

**32.11.10** 
$$w_k(x) \sim \text{sign}(k)\sqrt{\frac{1}{2}|x|}, \quad x \rightarrow -\infty.$$

If  $|k| > 1$ , then  $w_k(x)$  has a pole at a finite point  $x = c_0$ , dependent on  $k$ , and

**32.11.11** 
$$w_k(x) \sim \text{sign}(k)(x - c_0)^{-1}, \quad x \rightarrow c_0+.$$

For illustration see Figures 32.3.5 and 32.3.6, and for further information see Ablowitz and Clarkson (1991), Bassom *et al.* (1998), Clarkson and McLeod (1988), Deift and Zhou (1995), Segur and Ablowitz (1981), and Suleĭmanov (1987). For numerical studies see Miles (1978, 1980) and Rosales (1978).

**32.11(iii) Modified Second Painlevé Equation**

Replacement of  $w$  by  $iw$  in (32.11.4) gives

**32.11.12** 
$$w'' = -2w^3 + xw.$$

Any nontrivial real solution of (32.11.12) satisfies

**32.11.13** 
$$w(x) = d|x|^{-1/4} \sin(\phi(x) - \chi) + O(|x|^{-5/4} \ln|x|), \quad x \rightarrow -\infty,$$

where

**32.11.14** 
$$\phi(x) = \frac{2}{3}|x|^{3/2} + \frac{3}{4}d^2 \ln|x|,$$

with  $d (\neq 0)$  and  $\chi$  arbitrary real constants.

In the case when

**32.11.15** 
$$\chi + \frac{3}{2}d^2 \ln 2 - \frac{1}{4}\pi - \text{ph} \Gamma(\frac{1}{2}id^2) = n\pi,$$

with  $n \in \mathbb{Z}$ , we have

**32.11.16** 
$$w(x) \sim k \text{Ai}(x), \quad x \rightarrow +\infty,$$

where  $k$  is a nonzero real constant. The connection formulas for  $k$  are

**32.11.17** 
$$d^2 = \pi^{-1} \ln(1 + k^2), \quad \text{sign}(k) = (-1)^n.$$

In the generic case

**32.11.18** 
$$\chi + \frac{3}{2}d^2 \ln 2 - \frac{1}{4}\pi - \text{ph} \Gamma(\frac{1}{2}id^2) \neq n\pi,$$

we have

**32.11.19** 
$$w(x) = \sigma\sqrt{\frac{1}{2}x} + \sigma\rho(2x)^{-1/4} \cos(\psi(x) + \theta) + O(x^{-1}), \quad x \rightarrow +\infty,$$

where  $\sigma, \rho (> 0)$ , and  $\theta$  are real constants, and

**32.11.20** 
$$\psi(x) = \frac{2}{3}\sqrt{2}x^{3/2} - \frac{3}{2}\rho^2 \ln x.$$

The connection formulas for  $\sigma, \rho$ , and  $\theta$  are

**32.11.21** 
$$\sigma = -\text{sign}(\Im s),$$

**32.11.22** 
$$\rho^2 = \pi^{-1} \ln((1 + |s|^2)/|2\Im s|),$$

**32.11.23** 
$$\theta = -\frac{3}{4}\pi - \frac{7}{2}\rho^2 \ln 2 + \text{ph}(1 + s^2) + \text{ph} \Gamma(i\rho^2),$$

where

**32.11.24**

$$s = (\exp(\pi d^2) - 1)^{1/2} \times \exp(i(\frac{3}{2}d^2 \ln 2 - \frac{1}{4}\pi + \chi - \text{ph} \Gamma(\frac{1}{2}id^2))).$$

### 32.11(iv) Third Painlevé Equation

For  $P_{III}$ , with  $\alpha = -\beta = 2\nu \in \mathbb{R}$  and  $\gamma = -\delta = 1$ ,

#### 32.11.25

$w(x) - 1 \sim -\lambda \Gamma(\nu + \frac{1}{2}) 2^{-2\nu} x^{-\nu-(1/2)} e^{-2x}$ ,  $x \rightarrow +\infty$ , where  $\lambda$  is an arbitrary constant such that  $-1/\pi < \lambda < 1/\pi$ , and

$$32.11.26 \quad w(x) \sim Bx^\sigma, \quad x \rightarrow 0,$$

where  $B$  and  $\sigma$  are arbitrary constants such that  $B \neq 0$  and  $|\Re \sigma| < 1$ . The connection formulas relating (32.11.25) and (32.11.26) are

$$32.11.27 \quad \sigma = (2/\pi) \arcsin(\pi\lambda),$$

$$32.11.28 \quad B = 2^{-2\sigma} \frac{\Gamma^2(\frac{1}{2}(1-\sigma)) \Gamma(\frac{1}{2}(1+\sigma) + \nu)}{\Gamma^2(\frac{1}{2}(1+\sigma)) \Gamma(\frac{1}{2}(1-\sigma) + \nu)}.$$

See also Abdullaev (1985), Novokshënov (1985), Its and Novokshënov (1986), Kitaev (1987), Bobenko (1991), Bobenko and Its (1995), Tracy and Widom (1997), and Kitaev and Vartanian (2004).

### 32.11(v) Fourth Painlevé Equation

Consider  $P_{IV}$  with  $\alpha = 2\nu + 1 \in \mathbb{R}$  and  $\beta = 0$ , that is,

$$32.11.29 \quad w'' = \frac{(w')^2}{2w} + \frac{3}{2}w^3 + 4xw^2 + 2(x^2 - 2\nu - 1)w,$$

and with boundary condition

$$32.11.30 \quad w(x) \rightarrow 0, \quad x \rightarrow +\infty.$$

Any nontrivial solution of (32.11.29) that satisfies (32.11.30) is asymptotic to  $hU^2(-\nu - \frac{1}{2}, \sqrt{2}x)$  as  $x \rightarrow +\infty$ , where  $h (\neq 0)$  is a constant. Conversely, for any  $h (\neq 0)$  there is a unique solution  $w_h(x)$  of (32.11.29) that is asymptotic to  $hU^2(-\nu - \frac{1}{2}, \sqrt{2}x)$  as  $x \rightarrow +\infty$ . Here  $U$  denotes the parabolic cylinder function (§12.2).

Now suppose  $x \rightarrow -\infty$ . If  $0 \leq h < h^*$ , where

$$32.11.31 \quad h^* = 1 / \left( \pi^{1/2} \Gamma(\nu + 1) \right),$$

then  $w_h(x)$  has no poles on the real axis. Furthermore, if  $\nu = n = 0, 1, 2, \dots$ , then

$$32.11.32 \quad w_h(x) \sim h2^n x^{2n} \exp(-x^2), \quad x \rightarrow -\infty.$$

Alternatively, if  $\nu$  is not zero or a positive integer, then

$$32.11.33 \quad w_h(x) = -\frac{2}{3}x + \frac{4}{3}d\sqrt{3} \sin(\phi(x) - \theta_0) + O(x^{-1}),$$

$x \rightarrow -\infty,$

where

$$32.11.34 \quad \phi(x) = \frac{1}{3}\sqrt{3}x^2 - \frac{4}{3}d^2\sqrt{3} \ln(\sqrt{2}|x|),$$

and  $d (> 0)$  and  $\theta_0$  are real constants. Connection formulas for  $d$  and  $\theta_0$  are given by

$$32.11.35 \quad d^2 = -\frac{1}{4}\sqrt{3}\pi^{-1} \ln(1 - |\mu|^2),$$

$$32.11.36 \quad \theta_0 = \frac{1}{3}d^2\sqrt{3} \ln 3 + \frac{2}{3}\pi\nu + \frac{7}{12}\pi + \text{ph } \mu + \text{ph } \Gamma\left(-\frac{2}{3}i\sqrt{3}d^2\right),$$

where

$$32.11.37 \quad \mu = 1 + \left( 2ih\pi^{3/2} \exp(-i\pi\nu) / \Gamma(-\nu) \right),$$

and the branch of the ph function is immaterial.

Next if  $h = h^*$ , then

$$32.11.38 \quad w_{h^*}(x) \sim -2x, \quad x \rightarrow -\infty,$$

and  $w_{h^*}(x)$  has no poles on the real axis.

Lastly if  $h > h^*$ , then  $w_h(x)$  has a simple pole on the real axis, whose location is dependent on  $h$ .

For illustration see Figures 32.3.7–32.3.10. In terms of the parameter  $k$  that is used in these figures  $h = 2^{3/2}k^2$ .

## 32.12 Asymptotic Approximations for Complex Variables

### 32.12(i) First Painlevé Equation

See Boutroux (1913), Kapaev and Kitaev (1993), Takei (1995), Costin (1999), Joshi and Kitaev (2001), Kapaev (2004), and Olde Daalhuis (2005b).

### 32.12(ii) Second Painlevé Equation

See Boutroux (1913), Novokshënov (1990), Kapaev (1991), Joshi and Kruskal (1992), Kitaev (1994), Its and Kapaev (2003), and Fokas *et al.* (2006, Chapter 7).

### 32.12(iii) Third Painlevé Equation

See Fokas *et al.* (2006, Chapter 16).

## Applications

## 32.13 Reductions of Partial Differential Equations

### 32.13(i) Korteweg–de Vries and Modified Korteweg–de Vries Equations

The *modified Korteweg–de Vries* (mKdV) equation

$$32.13.1 \quad v_t - 6v^2v_x + v_{xxx} = 0,$$

has the scaling reduction

$$32.13.2 \quad z = x(3t)^{-1/3}, \quad v(x, t) = (3t)^{-1/3}w(z),$$

where  $w(z)$  satisfies  $P_{II}$  with  $\alpha$  a constant of integration.

The *Korteweg–de Vries* (KdV) equation

$$32.13.3 \quad u_t + 6uu_x + u_{xxx} = 0,$$

has the scaling reduction

$$32.13.4 \quad z = x(3t)^{-1/3}, \quad u(x, t) = -(3t)^{-2/3}(w' + w^2),$$

where  $w(z)$  satisfies  $P_{II}$ .

Equation (32.13.3) also has the similarity reduction

$$32.13.5 \quad z = x + 3\lambda t^2, \quad u(x, t) = W(z) - \lambda t,$$

where  $\lambda$  is an arbitrary constant and  $W(z)$  is expressible in terms of solutions of  $P_I$ . See Fokas and Ablowitz (1982) and P. J. Olver (1993b, p. 194).

### 32.13(ii) Sine-Gordon Equation

The *sine-Gordon* equation

$$32.13.6 \quad u_{xt} = \sin u,$$

has the scaling reduction

$$32.13.7 \quad z = xt, \quad u(x, t) = v(z),$$

where  $v(z)$  satisfies (32.2.10) with  $\alpha = \frac{1}{2}$  and  $\gamma = 0$ . In consequence if  $w = \exp(-iv)$ , then  $w(z)$  satisfies  $P_{III}$  with  $\alpha = -\beta = \frac{1}{2}$  and  $\gamma = \delta = 0$ .

### 32.13(iii) Boussinesq Equation

The *Boussinesq* equation

$$32.13.8 \quad u_{tt} = u_{xx} - 6(u^2)_{xx} + u_{xxxx},$$

has the traveling wave solution

$$32.13.9 \quad z = x - ct, \quad u(x, t) = v(z),$$

where  $c$  is an arbitrary constant and  $v(z)$  satisfies

$$32.13.10 \quad v'' = 6v^2 + (c^2 - 1)v + Az + B,$$

with  $A$  and  $B$  constants of integration. Depending whether  $A = 0$  or  $A \neq 0$ ,  $v(z)$  is expressible in terms of the Weierstrass elliptic function (§23.2) or solutions of  $P_I$ , respectively.

## 32.14 Combinatorics

Let  $S_N$  be the group of permutations  $\pi$  of the numbers  $1, 2, \dots, N$  (§26.2). With  $1 \leq m_1 < \dots < m_n \leq N$ ,  $\pi(m_1), \pi(m_2), \dots, \pi(m_n)$  is said to be an *increasing subsequence* of  $\pi$  of *length*  $n$  when  $\pi(m_1) < \pi(m_2) < \dots < \pi(m_n)$ . Let  $\ell_N(\pi)$  be the length of the longest increasing subsequence of  $\pi$ . Then

$$32.14.1 \quad \lim_{N \rightarrow \infty} \text{Prob} \left( \frac{\ell_N(\pi) - 2\sqrt{N}}{N^{1/6}} \leq s \right) = F(s),$$

where the *distribution function*  $F(s)$  is defined here by

$$32.14.2 \quad F(s) = \exp \left( - \int_s^\infty (x - s)w^2(x) dx \right),$$

and  $w(x)$  satisfies  $P_{II}$  with  $\alpha = 0$  and boundary conditions

$$32.14.3 \quad w(x) \sim \text{Ai}(x), \quad x \rightarrow +\infty,$$

$$32.14.4 \quad w(x) \sim \sqrt{-\frac{1}{2}x}, \quad x \rightarrow -\infty,$$

where  $\text{Ai}$  denotes the Airy function (§9.2).

The distribution function  $F(s)$  given by (32.14.2) arises in random matrix theory where it gives the limiting distribution for the normalized largest eigenvalue in the Gaussian Unitary Ensemble of  $n \times n$  Hermitian matrices; see Tracy and Widom (1994).

See Forrester and Witte (2001, 2002) for other instances of Painlevé equations in random matrix theory.

## 32.15 Orthogonal Polynomials

Let  $p_n(\xi)$ ,  $n = 0, 1, \dots$ , be the orthonormal set of polynomials defined by

$$32.15.1 \quad \int_{-\infty}^\infty \exp(-\frac{1}{4}\xi^4 - z\xi^2) p_m(\xi) p_n(\xi) d\xi = \delta_{m,n},$$

with recurrence relation

$$32.15.2 \quad a_{n+1}(z)p_{n+1}(\xi) = \xi p_n(\xi) - a_n(z)p_{n-1}(\xi),$$

for  $n = 1, 2, \dots$ ; compare §18.2. Then  $u_n(z) = (a_n(z))^2$  satisfies the nonlinear recurrence relation

$$32.15.3 \quad (u_{n+1} + u_n + u_{n-1})u_n = n - 2zu_n,$$

for  $n = 1, 2, \dots$ , and also  $P_{IV}$  with  $\alpha = -\frac{1}{2}n$  and  $\beta = -\frac{1}{2}n^2$ .

For this result and applications see Fokas *et al.* (1991): in this reference, on the right-hand side of Eq. (1.10),  $(n + \gamma)^2$  should be replaced by  $n + \gamma$  at its first appearance. See also Freud (1976), Brézin *et al.* (1978), Fokas *et al.* (1992), and Magnus (1995).

## 32.16 Physical

### Statistical Physics

Statistical physics, especially classical and quantum spin models, has proved to be a major area for research problems in the modern theory of Painlevé transcendents. For a survey see McCoy (1992). See also McCoy *et al.* (1977), Jimbo *et al.* (1980), Essler *et al.* (1996), and Kanzieper (2002).

### Integrable Continuous Dynamical Systems

See Bountis *et al.* (1982) and Grammaticos *et al.* (1991).

### Other Applications

For the Ising model see Barouch *et al.* (1973).

For applications in 2D quantum gravity and related aspects of the enumerative topology see Di Francesco *et al.* (1995). For applications in string theory see Seiberg and Shih (2005).

## Computation

### 32.17 Methods of Computation

The Painlevé equations can be integrated by Runge–Kutta methods for ordinary differential equations; see §3.7(v), Butcher (2003), and Hairer *et al.* (2000). For numerical studies of  $P_I$  see Holmes and Spence (1984) and Noonburg (1995). For numerical studies of  $P_{II}$  see Kashevarov (1998, 2004), Miles (1978, 1980), and Rosales (1978). For numerical studies of  $P_{IV}$  see Bassom *et al.* (1993).

## References

### General Reference

The survey article Clarkson (2006) covers all topics treated in this chapter.

### Sources

The following list gives the references or other indications of proofs that were used in constructing the various sections of this chapter. These sources supplement the references that are quoted in the text.

§32.2 Adler (1994), Hille (1976, pp. 439–444), Ince (1926, Chapter XIV), Kruskal and Clarkson (1992), Iwasaki *et al.* (1991, pp. 119–126), Noumi (2004, pp. 13–23).

§32.3 The graphs were produced at NIST. See also Bassom *et al.* (1993).

§32.4 Jimbo and Miwa (1981), Fokas *et al.* (2006, Chapter 5), Its and Novokshënov (1986).

§32.5 Ablowitz and Clarkson (1991), Ablowitz and Segur (1977, 1981).

§32.6 Forrester and Witte (2002), Jimbo and Miwa (1981), Okamoto (1981, 1986, 1987c).

§32.7 Cosgrove (2006), Fokas and Ablowitz (1982), Gambier (1910), Gromak (1975, 1976, 1978, 1987), Gromak *et al.* (2002, §§25,34,39,42,47), Lukaševič (1967a, 1971), Okamoto (1987a).

§32.8 Flaschka and Newell (1980), Gromak (1987), Gromak *et al.* (2002, §§20,26,35,40), Gromak and Lukaševič (1982), Kajiwara and Ohta (1996), Kitaev *et al.* (1994), Lukaševič (1967a,b), Mazzocco (2001a), Murata (1985, 1995), Vorob'ev (1965), Yablonskiĭ (1959).

§32.9 Gromak *et al.* (2002, §§33,38), Gromak and Lukaševič (1982), Hitchin (1995), Lukaševič (1965, 1967b).

§32.10 Airault (1979), Albrecht *et al.* (1996), Flaschka and Newell (1980), Fokas and Yortsos (1981), Gambier (1910), Gromak (1978, 1987), Gromak *et al.* (2002, Chapter 6, §§35,40,44), Gromak and Lukaševič (1982), Lukaševič (1965, 1967a,b, 1968), Lukaševič and Yablonskiĭ (1967), Mansfield and Webster (1998), Okamoto (1986, 1987a), Umemura and Watanabe (1998), Watanabe (1995).

§32.11 Ablowitz and Segur (1977), Bassom *et al.* (1992), Bender and Orszag (1978, pp. 158–166), Deift and Zhou (1995), Fokas *et al.* (2006, Chapters 9, 10, 14), Hastings and McLeod (1980), Holmes and Spence (1984), Its *et al.* (1994), Its and Kapaev (1987, 1998), McCoy *et al.* (1977). For (32.11.2) see Qin and Lu (2008).

§32.13 Ablowitz and Segur (1977).

§32.14 Baik *et al.* (1999).

## Chapter 33

# Coulomb Functions

I. J. Thompson<sup>1</sup>

<b>Notation</b>	<b>742</b>		
33.1 Special Notation . . . . .	742	33.15 Graphics . . . . .	749
<b>Variables <math>\rho, \eta</math></b>	<b>742</b>	33.16 Connection Formulas . . . . .	751
33.2 Definitions and Basic Properties . . . . .	742	33.17 Recurrence Relations and Derivatives . . . . .	752
33.3 Graphics . . . . .	743	33.18 Limiting Forms for Large $\ell$ . . . . .	752
33.4 Recurrence Relations and Derivatives . . . . .	744	33.19 Power-Series Expansions in $r$ . . . . .	752
33.5 Limiting Forms for Small $\rho$ , Small $ \eta $ , or Large $\ell$ . . . . .	744	33.20 Expansions for Small $ \epsilon $ . . . . .	752
33.6 Power-Series Expansions in $\rho$ . . . . .	745	33.21 Asymptotic Approximations for Large $ r $ . . . . .	753
33.7 Integral Representations . . . . .	745	<b>Physical Applications</b>	<b>753</b>
33.8 Continued Fractions . . . . .	745	33.22 Particle Scattering and Atomic and Molecular Spectra . . . . .	753
33.9 Expansions in Series of Bessel Functions . . . . .	745	<b>Computation</b>	<b>755</b>
33.10 Limiting Forms for Large $\rho$ or Large $ \eta $ . . . . .	746	33.23 Methods of Computation . . . . .	755
33.11 Asymptotic Expansions for Large $\rho$ . . . . .	747	33.24 Tables . . . . .	755
33.12 Asymptotic Expansions for Large $\eta$ . . . . .	747	33.25 Approximations . . . . .	756
33.13 Complex Variable and Parameters . . . . .	748	33.26 Software . . . . .	756
<b>Variables <math>r, \epsilon</math></b>	<b>748</b>	<b>References</b>	<b>756</b>
33.14 Definitions and Basic Properties . . . . .	748		

<sup>1</sup>Lawrence Livermore National Laboratory, Livermore, California.

**Acknowledgments:** This chapter is based in part on Abramowitz and Stegun (1964, Chapter 14) by M. Abramowitz.  
**Copyright** © 2009 National Institute of Standards and Technology. All rights reserved.

## Notation

### 33.1 Special Notation

(For other notation see pp. xiv and 873.)

- $k, \ell$  nonnegative integers.
- $r, x$  real variables.
- $\rho$  nonnegative real variable.
- $\epsilon, \eta$  real parameters.
- $\psi(x)$  logarithmic derivative of  $\Gamma(x)$ ; see §5.2(i).
- $\delta(x)$  Dirac delta; see §1.17.
- primes derivatives with respect to the variable.

The main functions treated in this chapter are first the Coulomb radial functions  $F_\ell(\eta, \rho)$ ,  $G_\ell(\eta, \rho)$ ,  $H_\ell^\pm(\eta, \rho)$  (Sommerfeld (1928)), which are used in the case of repulsive Coulomb interactions, and secondly the functions  $f(\epsilon, \ell; r)$ ,  $h(\epsilon, \ell; r)$ ,  $s(\epsilon, \ell; r)$ ,  $c(\epsilon, \ell; r)$  (Seaton (1982, 2002)), which are used in the case of attractive Coulomb interactions.

#### Alternative Notations

Curtis (1964a):  $P_\ell(\epsilon, r) = (2\ell + 1)! f(\epsilon, \ell; r)/2^{\ell+1}$ ,  
 $Q_\ell(\epsilon, r) = -(2\ell + 1)! h(\epsilon, \ell; r)/(2^{\ell+1} A(\epsilon, \ell))$ .

Greene *et al.* (1979):  $f^{(0)}(\epsilon, \ell; r) = f(\epsilon, \ell; r)$ ,  
 $f(\epsilon, \ell; r) = s(\epsilon, \ell; r)$ ,  $g(\epsilon, \ell; r) = c(\epsilon, \ell; r)$ .

## Variables $\rho, \eta$

### 33.2 Definitions and Basic Properties

#### 33.2(i) Coulomb Wave Equation

33.2.1 
$$\frac{d^2 w}{d\rho^2} + \left(1 - \frac{2\eta}{\rho} - \frac{\ell(\ell + 1)}{\rho^2}\right) w = 0, \quad \ell = 0, 1, 2, \dots$$

This differential equation has a regular singularity at  $\rho = 0$  with indices  $\ell + 1$  and  $-\ell$ , and an irregular singularity of rank 1 at  $\rho = \infty$  (§§2.7(i), 2.7(ii)). There are two turning points, that is, points at which  $d^2 w/d\rho^2 = 0$  (§2.8(i)). The outer one is given by

33.2.2 
$$\rho_{\text{tp}}(\eta, \ell) = \eta + (\eta^2 + \ell(\ell + 1))^{1/2}.$$

#### 33.2(ii) Regular Solution $F_\ell(\eta, \rho)$

The function  $F_\ell(\eta, \rho)$  is recessive (§2.7(iii)) at  $\rho = 0$ , and is defined by

33.2.3 
$$F_\ell(\eta, \rho) = C_\ell(\eta) 2^{-\ell-1} (\mp i)^{\ell+1} M_{\pm i\eta, \ell + \frac{1}{2}}(\pm 2i\rho),$$
  
 or equivalently

33.2.4 
$$F_\ell(\eta, \rho) = C_\ell(\eta) \rho^{\ell+1} e^{\mp i\rho} M(\ell + 1 \mp i\eta, 2\ell + 2, \pm 2i\rho),$$

where  $M_{\kappa, \mu}(z)$  and  $M(a, b, z)$  are defined in §§13.14(i) and 13.2(i), and

33.2.5 
$$C_\ell(\eta) = \frac{2^\ell e^{-\pi\eta/2} |\Gamma(\ell + 1 + i\eta)|}{(2\ell + 1)!}.$$

The choice of ambiguous signs in (33.2.3) and (33.2.4) is immaterial, provided that either all upper signs are taken, or all lower signs are taken. This is a consequence of Kummer's transformation (§13.2(vii)).

$F_\ell(\eta, \rho)$  is a real and analytic function of  $\rho$  on the open interval  $0 < \rho < \infty$ , and also an analytic function of  $\eta$  when  $-\infty < \eta < \infty$ .

The normalizing constant  $C_\ell(\eta)$  is always positive, and has the alternative form

33.2.6 
$$C_\ell(\eta) = \frac{2^\ell \left( (2\pi\eta / (e^{2\pi\eta} - 1)) \prod_{k=1}^\ell (\eta^2 + k^2) \right)^{1/2}}{(2\ell + 1)!}.$$

#### 33.2(iii) Irregular Solutions $G_\ell(\eta, \rho)$ , $H_\ell^\pm(\eta, \rho)$

The functions  $H_\ell^\pm(\eta, \rho)$  are defined by

33.2.7 
$$H_\ell^\pm(\eta, \rho) = (\mp i)^\ell e^{(\pi\eta/2) \pm i\sigma_\ell(\eta)} W_{\mp i\eta, \ell + \frac{1}{2}}(\mp 2i\rho),$$
  
 or equivalently

33.2.8 
$$H_\ell^\pm(\eta, \rho) = e^{\pm i\theta_\ell(\eta, \rho)} (\mp 2i\rho)^{\ell+1 \pm i\eta} U(\ell + 1 \pm i\eta, 2\ell + 2, \mp 2i\rho),$$

where  $W_{\kappa, \mu}(z)$ ,  $U(a, b, z)$  are defined in §§13.14(i) and 13.2(i),

33.2.9 
$$\theta_\ell(\eta, \rho) = \rho - \eta \ln(2\rho) - \frac{1}{2}\ell\pi + \sigma_\ell(\eta),$$

and

33.2.10 
$$\sigma_\ell(\eta) = \text{ph } \Gamma(\ell + 1 + i\eta),$$

the branch of the phase in (33.2.10) being zero when  $\eta = 0$  and continuous elsewhere.  $\sigma_\ell(\eta)$  is the Coulomb phase shift.

$H_\ell^+(\eta, \rho)$  and  $H_\ell^-(\eta, \rho)$  are complex conjugates, and their real and imaginary parts are given by

33.2.11 
$$H_\ell^+(\eta, \rho) = G_\ell(\eta, \rho) + iF_\ell(\eta, \rho),$$
  

$$H_\ell^-(\eta, \rho) = G_\ell(\eta, \rho) - iF_\ell(\eta, \rho).$$

As in the case of  $F_\ell(\eta, \rho)$ , the solutions  $H_\ell^\pm(\eta, \rho)$  and  $G_\ell(\eta, \rho)$  are analytic functions of  $\rho$  when  $0 < \rho < \infty$ . Also,  $e^{\mp i\sigma_\ell(\eta)} H_\ell^\pm(\eta, \rho)$  are analytic functions of  $\eta$  when  $-\infty < \eta < \infty$ .

#### 33.2(iv) Wronskians and Cross-Product

With arguments  $\eta, \rho$  suppressed,

33.2.12 
$$\mathscr{W} \{G_\ell, F_\ell\} = \mathscr{W} \{H_\ell^\pm, F_\ell\} = 1.$$

33.2.13 
$$F_{\ell-1} G_\ell - F_\ell G_{\ell-1} = \ell / (\ell^2 + \eta^2)^{1/2}, \quad \ell \geq 1.$$

### 33.3 Graphics

#### 33.3(i) Line Graphs of the Coulomb Radial Functions $F_\ell(\eta, \rho)$ and $G_\ell(\eta, \rho)$

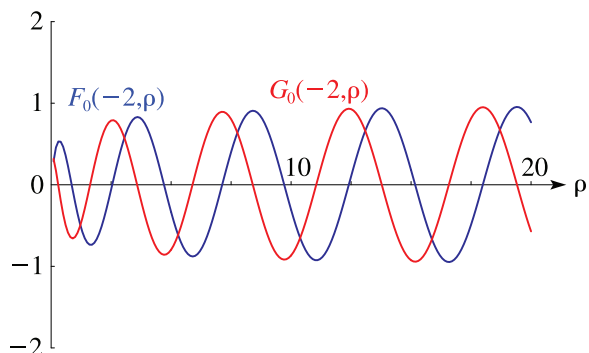


Figure 33.3.1:  $F_\ell(\eta, \rho), G_\ell(\eta, \rho)$  with  $\ell = 0, \eta = -2$ .

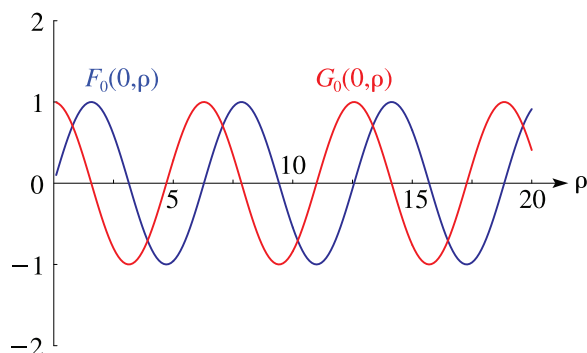


Figure 33.3.2:  $F_\ell(\eta, \rho), G_\ell(\eta, \rho)$  with  $\ell = 0, \eta = 0$ .

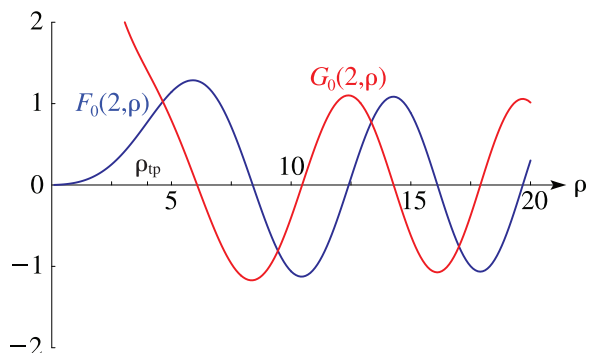


Figure 33.3.3:  $F_\ell(\eta, \rho), G_\ell(\eta, \rho)$  with  $\ell = 0, \eta = 2$ . The turning point is at  $\rho_{\text{tp}}(2, 0) = 4$ .

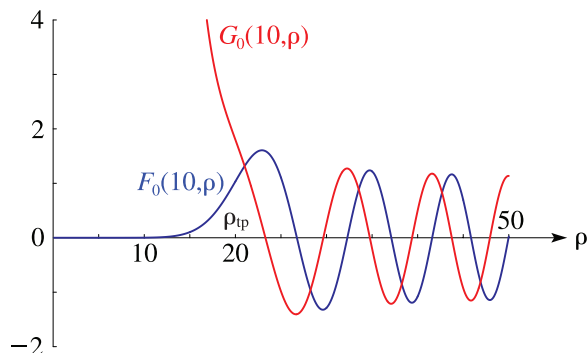


Figure 33.3.4:  $F_\ell(\eta, \rho), G_\ell(\eta, \rho)$  with  $\ell = 0, \eta = 10$ . The turning point is at  $\rho_{\text{tp}}(10, 0) = 20$ .

In Figures 33.3.5 and 33.3.6

33.3.1 
$$M_\ell(\eta, \rho) = (F_\ell^2(\eta, \rho) + G_\ell^2(\eta, \rho))^{1/2} = |H_\ell^\pm(\eta, \rho)|.$$

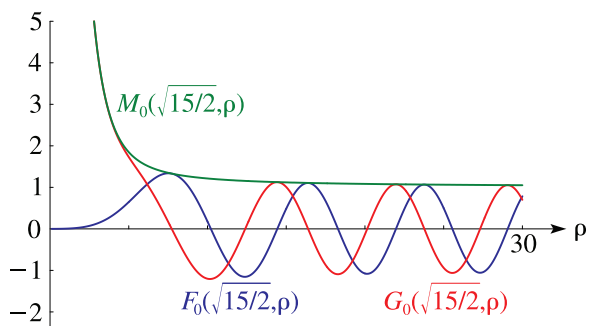


Figure 33.3.5:  $F_\ell(\eta, \rho), G_\ell(\eta, \rho)$ , and  $M_\ell(\eta, \rho)$  with  $\ell = 0, \eta = \sqrt{15/2}$ . The turning point is at  $\rho_{\text{tp}}(\sqrt{15/2}, 0) = \sqrt{30} = 5.47 \dots$

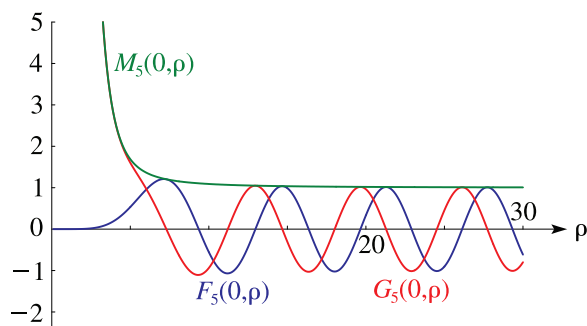
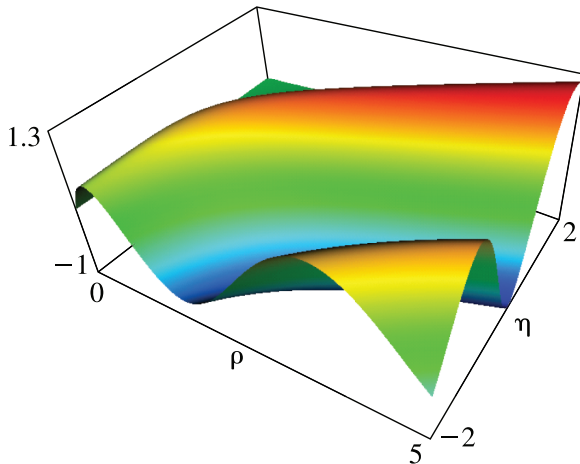
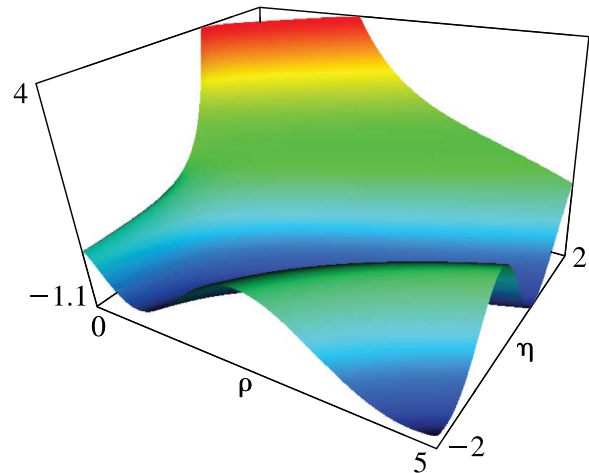


Figure 33.3.6:  $F_\ell(\eta, \rho), G_\ell(\eta, \rho)$ , and  $M_\ell(\eta, \rho)$  with  $\ell = 5, \eta = 0$ . The turning point is at  $\rho_{\text{tp}}(0, 5) = \sqrt{30}$  (as in Figure 33.3.5).



### 33.3(ii) Surfaces of the Coulomb Radial Functions $F_0(\eta, \rho)$ and $G_0(\eta, \rho)$

Figure 33.3.7:  $F_0(\eta, \rho)$ ,  $-2 \leq \eta \leq 2$ ,  $0 \leq \rho \leq 5$ .Figure 33.3.8:  $G_0(\eta, \rho)$ ,  $-2 \leq \eta \leq 2$ ,  $0 < \rho \leq 5$ .

### 33.4 Recurrence Relations and Derivatives

For  $\ell = 1, 2, 3, \dots$ , let

$$33.4.1 \quad R_\ell = \sqrt{1 + \frac{\eta^2}{\ell^2}}, \quad S_\ell = \frac{\ell}{\rho} + \frac{\eta}{\ell}, \quad T_\ell = S_\ell + S_{\ell+1}.$$

Then, with  $X_\ell$  denoting any of  $F_\ell(\eta, \rho)$ ,  $G_\ell(\eta, \rho)$ , or  $H_\ell^\pm(\eta, \rho)$ ,

$$33.4.2 \quad R_\ell X_{\ell-1} - T_\ell X_\ell + R_{\ell+1} X_{\ell+1} = 0, \quad \ell \geq 1,$$

$$33.4.3 \quad X'_\ell = R_\ell X_{\ell-1} - S_\ell X_\ell, \quad \ell \geq 1,$$

$$33.4.4 \quad X'_\ell = S_{\ell+1} X_\ell - R_{\ell+1} X_{\ell+1}, \quad \ell \geq 0.$$

### 33.5 Limiting Forms for Small $\rho$ , Small $|\eta|$ , or Large $\ell$

#### 33.5(i) Small $\rho$

As  $\rho \rightarrow 0$  with  $\eta$  fixed,

$$33.5.1 \quad F_\ell(\eta, \rho) \sim C_\ell(\eta) \rho^{\ell+1}, \quad F'_\ell(\eta, \rho) \sim (\ell+1) C_\ell(\eta) \rho^\ell.$$

$$33.5.2 \quad G_\ell(\eta, \rho) \sim \frac{\rho^{-\ell}}{(2\ell+1) C_\ell(\eta)}, \quad \ell = 0, 1, 2, \dots,$$

$$G'_\ell(\eta, \rho) \sim -\frac{\ell \rho^{-\ell-1}}{(2\ell+1) C_\ell(\eta)}, \quad \ell = 1, 2, 3, \dots$$

#### 33.5(ii) $\eta = 0$

$$33.5.3 \quad F_\ell(0, \rho) = \rho j_\ell(\rho), \quad G_\ell(0, \rho) = -\rho y_\ell(\rho).$$

Equivalently,

$$33.5.4 \quad F_\ell(0, \rho) = (\pi\rho/2)^{1/2} J_{\ell+\frac{1}{2}}(\rho),$$

$$G_\ell(0, \rho) = -(\pi\rho/2)^{1/2} Y_{\ell+\frac{1}{2}}(\rho).$$

For the functions  $j$ ,  $y$ ,  $J$ ,  $Y$  see §§10.47(ii), 10.2(ii).

#### 33.5.5

$$F_0(0, \rho) = \sin \rho, \quad G_0(0, \rho) = \cos \rho, \quad H_0^\pm(0, \rho) = e^{\pm i\rho}.$$

$$33.5.6 \quad C_\ell(0) = \frac{2^\ell \ell!}{(2\ell+1)!} = \frac{1}{(2\ell+1)!!}.$$

#### 33.5(iii) Small $|\eta|$

$$33.5.7 \quad \sigma_0(\eta) \sim -\gamma\eta, \quad \eta \rightarrow 0,$$

where  $\gamma$  is Euler's constant (§5.2(ii)).

#### 33.5(iv) Large $\ell$

As  $\ell \rightarrow \infty$  with  $\eta$  and  $\rho (\neq 0)$  fixed,

#### 33.5.8

$$F_\ell(\eta, \rho) \sim C_\ell(\eta) \rho^{\ell+1}, \quad G_\ell(\eta, \rho) \sim \frac{\rho^{-\ell}}{(2\ell+1) C_\ell(\eta)},$$

$$33.5.9 \quad C_\ell(\eta) \sim \frac{e^{-\pi\eta/2}}{(2\ell+1)!!} \sim e^{-\pi\eta/2} \frac{e^\ell}{\sqrt{2}(2\ell)^{\ell+1}}.$$

### 33.6 Power-Series Expansions in $\rho$

$$33.6.1 \quad F_\ell(\eta, \rho) = C_\ell(\eta) \sum_{k=\ell+1}^{\infty} A_k^\ell(\eta) \rho^k,$$

$$33.6.2 \quad F'_\ell(\eta, \rho) = C_\ell(\eta) \sum_{k=\ell+1}^{\infty} k A_k^\ell(\eta) \rho^{k-1},$$

---


$$33.6.5 \quad H_\ell^\pm(\eta, \rho) = \frac{e^{\pm i \theta_\ell(\eta, \rho)}}{(2\ell + 1)! \Gamma(-\ell + i\eta)} \left( \sum_{k=0}^{\infty} \frac{(a)_k}{(2\ell + 2)_k k!} (\mp 2i\rho)^{a+k} (\ln(\mp 2i\rho) + \psi(a+k) - \psi(1+k) - \psi(2\ell + 2 + k)) \right. \\ \left. - \sum_{k=1}^{2\ell+1} \frac{(2\ell + 1)!(k-1)!}{(2\ell + 1 - k)!(1-a)_k} (\mp 2i\rho)^{a-k} \right),$$


---

where  $a = 1 + \ell \pm i\eta$  and  $\psi(x) = \Gamma'(x)/\Gamma(x)$  (§5.2(i)).

The series (33.6.1), (33.6.2), and (33.6.5) converge for all finite values of  $\rho$ . Corresponding expansions for  $H_\ell^{\pm'}(\eta, \rho)$  can be obtained by combining (33.6.5) with (33.4.3) or (33.4.4).

### 33.7 Integral Representations

$$33.7.1 \quad F_\ell(\eta, \rho) = \frac{\rho^{\ell+1} 2^\ell e^{i\rho - (\pi\eta/2)}}{|\Gamma(\ell + 1 + i\eta)|} \int_0^1 e^{-2i\rho t} t^{\ell+i\eta} (1-t)^{\ell-i\eta} dt,$$

$$33.7.2 \quad H_\ell^-(\eta, \rho) = \frac{e^{-i\rho} \rho^{-\ell}}{(2\ell + 1)! C_\ell(\eta)} \int_0^\infty e^{-t} t^{\ell-i\eta} (t + 2i\rho)^{\ell+i\eta} dt,$$

$$33.7.3 \quad H_\ell^-(\eta, \rho) = \frac{-ie^{-\pi\eta} \rho^{\ell+1}}{(2\ell + 1)! C_\ell(\eta)} \int_0^\infty \left( \frac{\exp(-i(\rho \tanh t - 2\eta t))}{(\cosh t)^{2\ell+2}} + i(1+t^2)^\ell \exp(-\rho t + 2\eta \arctan t) \right) dt,$$

$$33.7.4 \quad H_\ell^+(\eta, \rho) = \frac{ie^{-\pi\eta} \rho^{\ell+1}}{(2\ell + 1)! C_\ell(\eta)} \int_{-1}^{-i\infty} e^{-i\rho t} (1-t)^{\ell-i\eta} (1+t)^{\ell+i\eta} dt.$$

Noninteger powers in (33.7.1)–(33.7.4) and the arc-tangent assume their principal values (§§4.2(i), 4.2(iv), 4.23(ii)).

where  $A_{\ell+1}^\ell = 1$ ,  $A_{\ell+2}^\ell = \eta/(\ell + 1)$ , and

$$33.6.3 \quad (k + \ell)(k - \ell - 1)A_k^\ell = 2\eta A_{k-1}^\ell - A_{k-2}^\ell, \\ k = \ell + 3, \ell + 4, \dots,$$

or in terms of the hypergeometric function (§§15.1, 15.2(i)),

$$33.6.4 \quad A_k^\ell(\eta) = \frac{(-i)^{k-\ell-1}}{(k - \ell - 1)!} {}_2F_1(\ell + 1 - k, \ell + 1 - i\eta; 2\ell + 2; 2).$$

### 33.8 Continued Fractions

With arguments  $\eta, \rho$  suppressed,

$$33.8.1 \quad \frac{F'_\ell}{F_\ell} = S_{\ell+1} - \frac{R_{\ell+1}^2}{T_{\ell+1} -} \frac{R_{\ell+2}^2}{T_{\ell+2} -} \dots$$

For  $R, S$ , and  $T$  see (33.4.1).

$$33.8.2 \quad \frac{H_\ell^{\pm'}}{H_\ell^\pm} = c \pm \frac{i}{\rho} \frac{ab}{2(\rho - \eta \pm i) +} \frac{(a+1)(b+1)}{2(\rho - \eta \pm 2i) +} \dots,$$

where

$$33.8.3 \quad a = 1 + \ell \pm i\eta, \quad b = -\ell \pm i\eta, \quad c = \pm i(1 - (\eta/\rho)).$$

The continued fraction (33.8.1) converges for all finite values of  $\rho$ , and (33.8.2) converges for all  $\rho \neq 0$ .

If we denote  $u = F'_\ell/F_\ell$  and  $p + iq = H_\ell^{\pm'}/H_\ell^\pm$ , then

$$33.8.4 \quad F_\ell = \pm(q^{-1}(u - p)^2 + q)^{-1/2}, \quad F'_\ell = u F_\ell,$$

$$33.8.5 \quad G_\ell = q^{-1}(u - p) F_\ell, \quad G'_\ell = q^{-1}(up - p^2 - q^2) F_\ell.$$

The ambiguous sign in (33.8.4) has to agree with that of the final denominator in (33.8.1) when the continued fraction has converged to the required precision. For proofs and further information see Barnett *et al.* (1974) and Barnett (1996).

### 33.9 Expansions in Series of Bessel Functions

#### 33.9(i) Spherical Bessel Functions

$$33.9.1 \quad F_\ell(\eta, \rho) = \rho \sum_{k=0}^{\infty} a_k j_{\ell+k}(\rho),$$

where the function  $j$  is as in §10.47(ii),  $a_{-1} = 0$ ,  $a_0 = (2\ell + 1)!! C_\ell(\eta)$ , and

$$33.9.2 \quad \frac{k(k+2\ell+1)}{2k+2\ell+1} a_k - 2\eta a_{k-1} + \frac{(k-2)(k+2\ell-1)}{2k+2\ell-3} a_{k-2} = 0, \quad k = 1, 2, \dots$$

The series (33.9.1) converges for all finite values of  $\eta$  and  $\rho$ .

**33.9(ii) Bessel Functions and Modified Bessel Functions**

In this subsection the functions  $J$ ,  $I$ , and  $K$  are as in §§10.2(ii) and 10.25(ii).

With  $t = 2|\eta|\rho$ ,

$$33.9.3 \quad F_\ell(\eta, \rho) = C_\ell(\eta) \frac{(2\ell+1)!}{(2\eta)^{2\ell+1}} \rho^{-\ell} \sum_{k=2\ell+1}^{\infty} b_k t^{k/2} I_k(2\sqrt{t}), \quad \eta > 0,$$

$$33.9.4 \quad F_\ell(\eta, \rho) = C_\ell(\eta) \frac{(2\ell+1)!}{(2|\eta|)^{2\ell+1}} \rho^{-\ell} \sum_{k=2\ell+1}^{\infty} b_k t^{k/2} J_k(2\sqrt{t}), \quad \eta < 0.$$

Here  $b_{2\ell} = b_{2\ell+2} = 0$ ,  $b_{2\ell+1} = 1$ , and

$$33.9.5 \quad 4\eta^2(k-2\ell)b_{k+1} + kb_{k-1} + b_{k-2} = 0, \quad k = 2\ell+2, 2\ell+3, \dots$$

The series (33.9.3) and (33.9.4) converge for all finite positive values of  $|\eta|$  and  $\rho$ .

Next, as  $\eta \rightarrow +\infty$  with  $\rho (> 0)$  fixed,

$$33.9.6 \quad G_\ell(\eta, \rho) \sim \frac{\rho^{-\ell}}{(\ell + \frac{1}{2})\lambda_\ell(\eta) C_\ell(\eta)} \sum_{k=2\ell+1}^{\infty} (-1)^k b_k t^{k/2} K_k(2\sqrt{t}),$$

where

$$33.9.7 \quad \lambda_\ell(\eta) \sim \sum_{k=2\ell+1}^{\infty} (-1)^k (k-1)! b_k.$$

For other asymptotic expansions of  $G_\ell(\eta, \rho)$  see Fröberg (1955, §8) and Humblet (1985).

**33.10 Limiting Forms for Large  $\rho$  or Large  $|\eta|$**

**33.10(i) Large  $\rho$**

As  $\rho \rightarrow \infty$  with  $\eta$  fixed,

$$33.10.1 \quad \begin{aligned} F_\ell(\eta, \rho) &= \sin(\theta_\ell(\eta, \rho)) + o(1), \\ G_\ell(\eta, \rho) &= \cos(\theta_\ell(\eta, \rho)) + o(1), \end{aligned}$$

$$33.10.2 \quad H_\ell^\pm(\eta, \rho) \sim \exp(\pm i \theta_\ell(\eta, \rho)),$$

where  $\theta_\ell(\eta, \rho)$  is defined by (33.2.9).

**33.10(ii) Large Positive  $\eta$**

As  $\eta \rightarrow \infty$  with  $\rho$  fixed,

$$33.10.3 \quad \begin{aligned} F_\ell(\eta, \rho) &\sim \frac{(2\ell+1)! C_\ell(\eta)}{(2\eta)^{\ell+1}} (2\eta\rho)^{1/2} I_{2\ell+1}((8\eta\rho)^{1/2}), \\ G_\ell(\eta, \rho) &\sim \frac{2(2\eta)^\ell}{(2\ell+1)! C_\ell(\eta)} (2\eta\rho)^{1/2} K_{2\ell+1}((8\eta\rho)^{1/2}). \end{aligned}$$

In particular, for  $\ell = 0$ ,

$$33.10.4 \quad \begin{aligned} F_0(\eta, \rho) &\sim e^{-\pi\eta} (\pi\rho)^{1/2} I_1((8\eta\rho)^{1/2}), \\ G_0(\eta, \rho) &\sim 2e^{\pi\eta} (\rho/\pi)^{1/2} K_1((8\eta\rho)^{1/2}), \end{aligned}$$

$$33.10.5 \quad \begin{aligned} F'_0(\eta, \rho) &\sim e^{-\pi\eta} (2\pi\eta)^{1/2} I_0((8\eta\rho)^{1/2}), \\ G'_0(\eta, \rho) &\sim -2e^{\pi\eta} (2\eta/\pi)^{1/2} K_0((8\eta\rho)^{1/2}). \end{aligned}$$

Also,

$$33.10.6 \quad \begin{aligned} \sigma_0(\eta) &= \eta(\ln \eta - 1) + \frac{1}{4}\pi + o(1), \\ C_0(\eta) &\sim (2\pi\eta)^{1/2} e^{-\pi\eta}. \end{aligned}$$

**33.10(iii) Large Negative  $\eta$**

As  $\eta \rightarrow -\infty$  with  $\rho$  fixed,

$$33.10.7 \quad \begin{aligned} F_\ell(\eta, \rho) &= \frac{(2\ell+1)! C_\ell(\eta)}{(-2\eta)^{\ell+1}} \left( (-2\eta\rho)^{1/2} \right. \\ &\quad \left. \times J_{2\ell+1}((-8\eta\rho)^{1/2}) + o(|\eta|^{1/4}) \right), \\ G_\ell(\eta, \rho) &= -\frac{\pi(-2\eta)^\ell}{(2\ell+1)! C_\ell(\eta)} \left( (-2\eta\rho)^{1/2} \right. \\ &\quad \left. \times Y_{2\ell+1}((-8\eta\rho)^{1/2}) + o(|\eta|^{1/4}) \right). \end{aligned}$$

In particular, for  $\ell = 0$ ,

$$33.10.8 \quad \begin{aligned} F_0(\eta, \rho) &= (\pi\rho)^{1/2} J_1((-8\eta\rho)^{1/2}) + o(|\eta|^{-1/4}), \\ G_0(\eta, \rho) &= -(\pi\rho)^{1/2} Y_1((-8\eta\rho)^{1/2}) + o(|\eta|^{-1/4}). \end{aligned}$$

**33.10.9**

$$\begin{aligned} F'_0(\eta, \rho) &= (-2\pi\eta)^{1/2} J_0((-8\eta\rho)^{1/2}) + o(|\eta|^{1/4}), \\ G'_0(\eta, \rho) &= -(-2\pi\eta)^{1/2} Y_0((-8\eta\rho)^{1/2}) + o(|\eta|^{1/4}). \end{aligned}$$

Also,

$$33.10.10 \quad \sigma_0(\eta) = \eta(\ln(-\eta) - 1) - \frac{1}{4}\pi + o(1), \quad C_0(\eta) \sim (-2\pi\eta)^{1/2}.$$

### 33.11 Asymptotic Expansions for Large $\rho$

For large  $\rho$ , with  $\ell$  and  $\eta$  fixed,

$$33.11.1 \quad H_\ell^\pm(\eta, \rho) = e^{\pm i\theta_\ell(\eta, \rho)} \sum_{k=0}^{\infty} \frac{(a)_k (b)_k}{k! (\mp 2i\rho)^k},$$

where  $\theta_\ell(\eta, \rho)$  is defined by (33.2.9), and  $a$  and  $b$  are defined by (33.8.3).

With arguments  $(\eta, \rho)$  suppressed, an equivalent formulation is given by

$$33.11.2 \quad F_\ell = g \cos \theta_\ell + f \sin \theta_\ell, \quad G_\ell = f \cos \theta_\ell - g \sin \theta_\ell,$$

$$33.11.3 \quad F'_\ell = \widehat{g} \cos \theta_\ell + \widehat{f} \sin \theta_\ell, \quad G'_\ell = \widehat{f} \cos \theta_\ell - \widehat{g} \sin \theta_\ell,$$

$$33.11.4 \quad H_\ell^\pm = e^{\pm i\theta_\ell} (f \pm ig),$$

where

$$33.11.5 \quad f \sim \sum_{k=0}^{\infty} f_k, \quad g \sim \sum_{k=0}^{\infty} g_k,$$

$$33.11.6 \quad \widehat{f} \sim \sum_{k=0}^{\infty} \widehat{f}_k, \quad \widehat{g} \sim \sum_{k=0}^{\infty} \widehat{g}_k,$$

$$33.11.7 \quad g\widehat{f} - f\widehat{g} = 1.$$

Here  $f_0 = 1, g_0 = 0, \widehat{f}_0 = 0, \widehat{g}_0 = 1 - (\eta/\rho)$ , and for  $k = 0, 1, 2, \dots$ ,

$$33.11.8 \quad \begin{aligned} f_{k+1} &= \lambda_k f_k - \mu_k g_k, \\ g_{k+1} &= \lambda_k g_k + \mu_k f_k, \\ \widehat{f}_{k+1} &= \lambda_k \widehat{f}_k - \mu_k \widehat{g}_k - (f_{k+1}/\rho), \\ \widehat{g}_{k+1} &= \lambda_k \widehat{g}_k + \mu_k \widehat{f}_k - (g_{k+1}/\rho), \end{aligned}$$

where

$$33.11.9 \quad \lambda_k = \frac{(2k+1)\eta}{(2k+2)\rho}, \quad \mu_k = \frac{\ell(\ell+1) - k(k+1) + \eta^2}{(2k+2)\rho}.$$

### 33.12 Asymptotic Expansions for Large $\eta$

#### 33.12(i) Transition Region

When  $\ell = 0$  and  $\eta > 0$ , the outer turning point is given by  $\rho_{\text{tp}}(\eta, 0) = 2\eta$ ; compare (33.2.2). Define

$$33.12.1 \quad x = (2\eta - \rho)/(2\eta)^{1/3}, \quad \mu = (2\eta)^{2/3}.$$

Then as  $\eta \rightarrow \infty$ ,

$$33.12.2 \quad \frac{F_0(\eta, \rho)}{G_0(\eta, \rho)} \sim \pi^{1/2} (2\eta)^{1/6} \left\{ \frac{\text{Ai}(x)}{\text{Bi}(x)} \left( 1 + \frac{B_1}{\mu} + \frac{B_2}{\mu^2} + \dots \right) + \frac{\text{Ai}'(x)}{\text{Bi}'(x)} \left( \frac{A_1}{\mu} + \frac{A_2}{\mu^2} + \dots \right) \right\},$$

$$33.12.3 \quad \frac{F'_0(\eta, \rho)}{G'_0(\eta, \rho)} \sim -\pi^{1/2} (2\eta)^{-1/6} \left\{ \frac{\text{Ai}(x)}{\text{Bi}(x)} \left( \frac{B'_1 + xA_1}{\mu} + \frac{B'_2 + xA_2}{\mu^2} + \dots \right) + \frac{\text{Ai}'(x)}{\text{Bi}'(x)} \left( \frac{B_1 + A'_1}{\mu} + \frac{B_2 + A'_2}{\mu^2} + \dots \right) \right\},$$

uniformly for bounded values of  $|(\rho - 2\eta)/\eta^{1/3}|$ . Here Ai and Bi are the Airy functions (§9.2), and

$$33.12.4 \quad A_1 = \frac{1}{5}x^2, \quad A_2 = \frac{1}{35}(2x^3 + 6), \quad A_3 = \frac{1}{15750}(21x^7 + 370x^4 + 580x),$$

$$33.12.5 \quad B_1 = -\frac{1}{5}x, \quad B_2 = \frac{1}{350}(7x^5 - 30x^2), \quad B_3 = \frac{1}{15750}(264x^6 - 290x^3 - 560).$$

In particular,

$$33.12.6 \quad 3^{-1/2} \frac{F_0(\eta, 2\eta)}{G_0(\eta, 2\eta)} \sim \frac{\Gamma(\frac{1}{3})\omega^{1/2}}{2\sqrt{\pi}} \left( 1 \mp \frac{2}{35} \frac{\Gamma(\frac{2}{3})}{\Gamma(\frac{1}{3})} \frac{1}{\omega^4} - \frac{8}{2025} \frac{1}{\omega^6} \mp \frac{5792}{46\,068\,75} \frac{\Gamma(\frac{2}{3})}{\Gamma(\frac{1}{3})} \frac{1}{\omega^{10}} - \dots \right),$$

$$33.12.7 \quad 3^{-1/2} \frac{F'_0(\eta, 2\eta)}{G'_0(\eta, 2\eta)} \sim \frac{\Gamma(\frac{2}{3})}{2\sqrt{\pi}\omega^{1/2}} \left( \pm 1 + \frac{1}{15} \frac{\Gamma(\frac{1}{3})}{\Gamma(\frac{2}{3})} \frac{1}{\omega^2} \pm \frac{2}{141\,75} \frac{1}{\omega^6} + \frac{1436}{23\,388\,75} \frac{\Gamma(\frac{1}{3})}{\Gamma(\frac{2}{3})} \frac{1}{\omega^8} \pm \dots \right),$$

where  $\omega = (\frac{2}{3}\eta)^{1/3}$ .

For derivations and additional terms in the expansions in this subsection see Abramowitz and Rabinowitz (1954) and Fröberg (1955).

#### 33.12(ii) Uniform Expansions

With the substitution  $\rho = 2\eta z$ , Equation (33.2.1) becomes

$$33.12.8 \quad \frac{d^2 w}{dz^2} = \left( 4\eta^2 \left( \frac{1-z}{z} \right) + \frac{\ell(\ell+1)}{z^2} \right) w.$$

Then, by application of the results given in §§2.8(iii) and 2.8(iv), two sets of asymptotic expansions can be constructed for  $F_\ell(\eta, \rho)$  and  $G_\ell(\eta, \rho)$  when  $\eta \rightarrow \infty$ .

The first set is in terms of Airy functions and the expansions are uniform for fixed  $\ell$  and  $\delta \leq z < \infty$ , where  $\delta$  is an arbitrary small positive constant. They would include the results of §33.12(i) as a special case.

The second set is in terms of Bessel functions of orders  $2\ell + 1$  and  $2\ell + 2$ , and they are uniform for fixed  $\ell$

and  $0 \leq z \leq 1 - \delta$ , where  $\delta$  again denotes an arbitrary small positive constant.

Compare also §33.20(iv).

### 33.13 Complex Variable and Parameters

The functions  $F_\ell(\eta, \rho)$ ,  $G_\ell(\eta, \rho)$ , and  $H_\ell^\pm(\eta, \rho)$  may be extended to noninteger values of  $\ell$  by generalizing  $(2\ell + 1)! = \Gamma(2\ell + 2)$ , and supplementing (33.6.5) by a formula derived from (33.2.8) with  $U(a, b, z)$  expanded via (13.2.42).

These functions may also be continued analytically to complex values of  $\rho$ ,  $\eta$ , and  $\ell$ . The quantities  $C_\ell(\eta)$ ,  $\sigma_\ell(\eta)$ , and  $R_\ell$ , given by (33.2.6), (33.2.10), and (33.4.1), respectively, must be defined consistently so that

**33.13.1**

$$C_\ell(\eta) = 2^\ell e^{i\sigma_\ell(\eta) - (\pi\eta/2)} \Gamma(\ell + 1 - i\eta) / \Gamma(2\ell + 2),$$

and

**33.13.2** 
$$R_\ell = (2\ell + 1) C_\ell(\eta) / C_{\ell-1}(\eta).$$

For further information see Dzieciol *et al.* (1999), Thompson and Barnett (1986), and Humblet (1984).

## Variables $r, \epsilon$

### 33.14 Definitions and Basic Properties

#### 33.14(i) Coulomb Wave Equation

Another parametrization of (33.2.1) is given by

**33.14.1** 
$$\frac{d^2 w}{dr^2} + \left( \epsilon + \frac{2}{r} - \frac{\ell(\ell + 1)}{r^2} \right) w = 0,$$

where

**33.14.2** 
$$r = -\eta\rho, \quad \epsilon = 1/\eta^2.$$

Again, there is a regular singularity at  $r = 0$  with indices  $\ell + 1$  and  $-\ell$ , and an irregular singularity of rank 1 at  $r = \infty$ . When  $\epsilon > 0$  the outer turning point is given by

**33.14.3** 
$$r_{\text{tp}}(\epsilon, \ell) = \left( \sqrt{1 + \epsilon\ell(\ell + 1)} - 1 \right) / \epsilon;$$

compare (33.2.2).

#### 33.14(ii) Regular Solution $f(\epsilon, \ell; r)$

The function  $f(\epsilon, \ell; r)$  is recessive (§2.7(iii)) at  $r = 0$ , and is defined by

**33.14.4** 
$$f(\epsilon, \ell; r) = \kappa^{\ell+1} M_{\kappa, \ell+\frac{1}{2}}(2r/\kappa) / (2\ell + 1)!,$$

or equivalently

**33.14.5**

$$f(\epsilon, \ell; r) = (2r)^{\ell+1} e^{-r/\kappa} M(\ell + 1 - \kappa, 2\ell + 2, 2r/\kappa) / (2\ell + 1)!,$$

where  $M_{\kappa, \mu}(z)$  and  $M(a, b, z)$  are defined in §§13.14(i) and 13.2(i), and

**33.14.6** 
$$\kappa = \begin{cases} (-\epsilon)^{-1/2}, & \epsilon < 0, r > 0, \\ -(-\epsilon)^{-1/2}, & \epsilon < 0, r < 0, \\ \pm i\epsilon^{-1/2}, & \epsilon > 0. \end{cases}$$

The choice of sign in the last line of (33.14.6) is immaterial: the same function  $f(\epsilon, \ell; r)$  is obtained. This is a consequence of Kummer's transformation (§13.2(vii)).

$f(\epsilon, \ell; r)$  is real and an analytic function of  $r$  in the interval  $-\infty < r < \infty$ , and it is also an analytic function of  $\epsilon$  when  $-\infty < \epsilon < \infty$ . This includes  $\epsilon = 0$ , hence  $f(\epsilon, \ell; r)$  can be expanded in a convergent power series in  $\epsilon$  in a neighborhood of  $\epsilon = 0$  (§33.20(ii)).

#### 33.14(iii) Irregular Solution $h(\epsilon, \ell; r)$

For nonzero values of  $\epsilon$  and  $r$  the function  $h(\epsilon, \ell; r)$  is defined by

**33.14.7**

$$h(\epsilon, \ell; r) = \frac{\Gamma(\ell + 1 - \kappa)}{\pi\kappa^\ell} \left( W_{\kappa, \ell+\frac{1}{2}}(2r/\kappa) + (-1)^\ell S(\epsilon, r) \frac{\Gamma(\ell + 1 + \kappa)}{2(2\ell + 1)!} M_{\kappa, \ell+\frac{1}{2}}(2r/\kappa) \right),$$

where  $\kappa$  is given by (33.14.6) and

**33.14.8** 
$$S(\epsilon, r) = \begin{cases} 2 \cos(\pi|\epsilon|^{-1/2}), & \epsilon < 0, r > 0, \\ 0, & \epsilon < 0, r < 0, \\ e^{\pi\epsilon^{-1/2}}, & \epsilon > 0, r > 0, \\ e^{-\pi\epsilon^{-1/2}}, & \epsilon > 0, r < 0. \end{cases}$$

(Again, the choice of the ambiguous sign in the last line of (33.14.6) is immaterial.)

$h(\epsilon, \ell; r)$  is real and an analytic function of each of  $r$  and  $\epsilon$  in the intervals  $-\infty < r < \infty$  and  $-\infty < \epsilon < \infty$ , except when  $r = 0$  or  $\epsilon = 0$ .

#### 33.14(iv) Solutions $s(\epsilon, \ell; r)$ and $c(\epsilon, \ell; r)$

The functions  $s(\epsilon, \ell; r)$  and  $c(\epsilon, \ell; r)$  are defined by

**33.14.9** 
$$\begin{aligned} s(\epsilon, \ell; r) &= (B(\epsilon, \ell)/2)^{1/2} f(\epsilon, \ell; r), \\ c(\epsilon, \ell; r) &= (2B(\epsilon, \ell))^{-1/2} h(\epsilon, \ell; r), \end{aligned}$$

provided that  $\ell < (-\epsilon)^{-1/2}$  when  $\epsilon < 0$ , where

**33.14.10**

$$B(\epsilon, \ell) = \begin{cases} A(\epsilon, \ell) (1 - \exp(-2\pi/\epsilon^{1/2}))^{-1}, & \epsilon > 0, \\ A(\epsilon, \ell), & \epsilon \leq 0, \end{cases}$$

and

**33.14.11** 
$$A(\epsilon, \ell) = \prod_{k=0}^{\ell} (1 + \epsilon k^2).$$

An alternative formula for  $A(\epsilon, \ell)$  is

**33.14.12** 
$$A(\epsilon, \ell) = \frac{\Gamma(1 + \ell + \kappa)}{\Gamma(\kappa - \ell)} \kappa^{-2\ell-1},$$

the choice of sign in the last line of (33.14.6) again being immaterial.

When  $\epsilon < 0$  and  $\ell > (-\epsilon)^{-1/2}$  the quantity  $A(\epsilon, \ell)$  may be negative, causing  $s(\epsilon, \ell; r)$  and  $c(\epsilon, \ell; r)$  to become imaginary.

The function  $s(\epsilon, \ell; r)$  has the following properties:

33.14.13 
$$\int_0^\infty s(\epsilon_1, \ell; r) s(\epsilon_2, \ell; r) dr = \delta(\epsilon_1 - \epsilon_2),$$

where the right-hand side is the Dirac delta (§1.17). When  $\epsilon = -1/n^2$ ,  $n = \ell + 1, \ell + 2, \dots$ ,  $s(\epsilon, \ell; r)$  is  $\exp(-r/n)$  times a polynomial in  $r$ , and

33.14.14 
$$\phi_{n,\ell}(r) = (-1)^{\ell+1+n} (2/n^3)^{1/2} s(-1/n^2, \ell; r)$$

satisfies

33.14.15 
$$\int_0^\infty \phi_{n,\ell}^2(r) dr = 1.$$

**33.14(v) Wronskians**

With arguments  $\epsilon, \ell, r$  suppressed,

33.14.16 
$$\mathscr{W}\{h, f\} = 2/\pi, \quad \mathscr{W}\{c, s\} = 1/\pi.$$

**33.15 Graphics**

**33.15(i) Line Graphs of the Coulomb Functions  $f(\epsilon, \ell; r)$  and  $h(\epsilon, \ell; r)$**

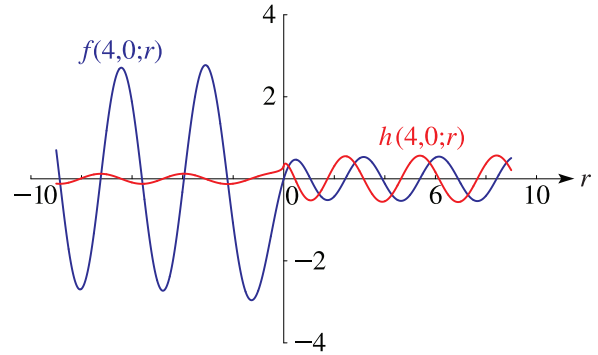


Figure 33.15.1:  $f(\epsilon, \ell; r), h(\epsilon, \ell; r)$  with  $\ell = 0, \epsilon = 4$ .

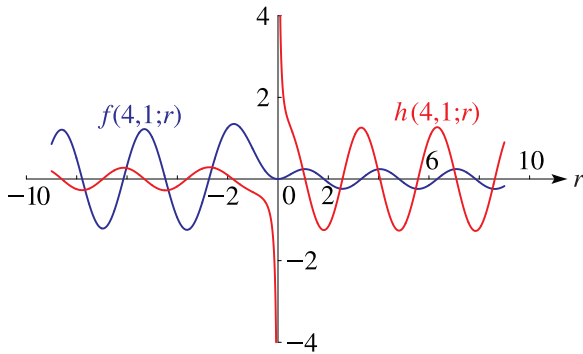


Figure 33.15.2:  $f(\epsilon, \ell; r), h(\epsilon, \ell; r)$  with  $\ell = 1, \epsilon = 4$ .

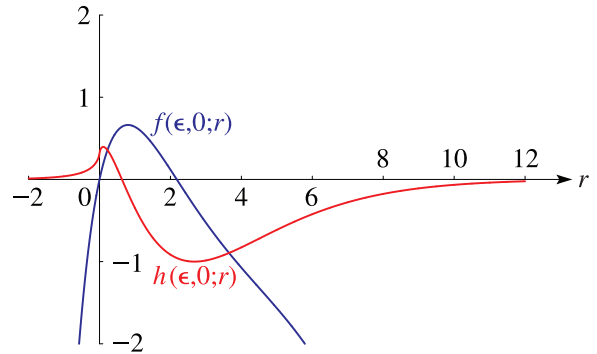


Figure 33.15.3:  $f(\epsilon, \ell; r), h(\epsilon, \ell; r)$  with  $\ell = 0, \epsilon = -1/\nu^2, \nu = 1.5$ .

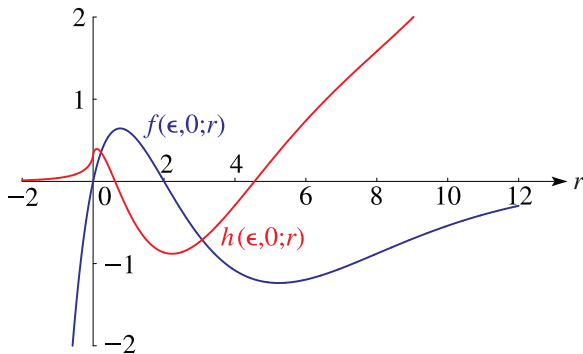


Figure 33.15.4:  $f(\epsilon, \ell; r), h(\epsilon, \ell; r)$  with  $\ell = 0, \epsilon = -1/\nu^2, \nu = 2$ .

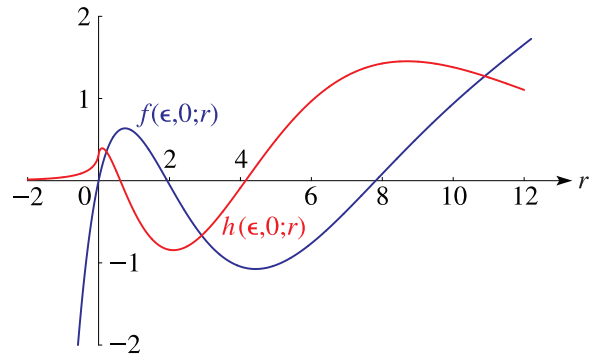


Figure 33.15.5:  $f(\epsilon, \ell; r), h(\epsilon, \ell; r)$  with  $\ell = 0, \epsilon = -1/\nu^2, \nu = 2.5$ .

33.15(ii) Surfaces of the Coulomb Functions  $f(\epsilon, \ell; r)$ ,  $h(\epsilon, \ell; r)$ ,  $s(\epsilon, \ell; r)$ , and  $c(\epsilon, \ell; r)$

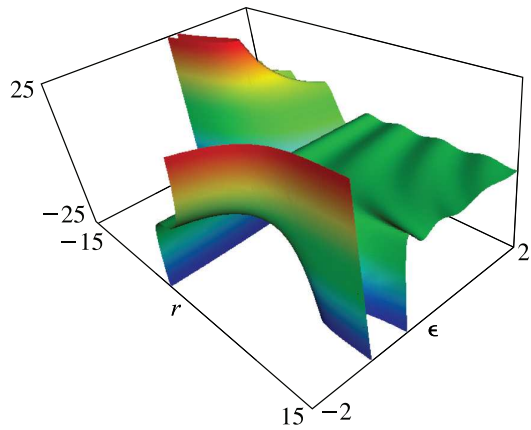


Figure 33.15.6:  $f(\epsilon, \ell; r)$  with  $\ell = 0, -2 < \epsilon < 2, -15 < r < 15$ .

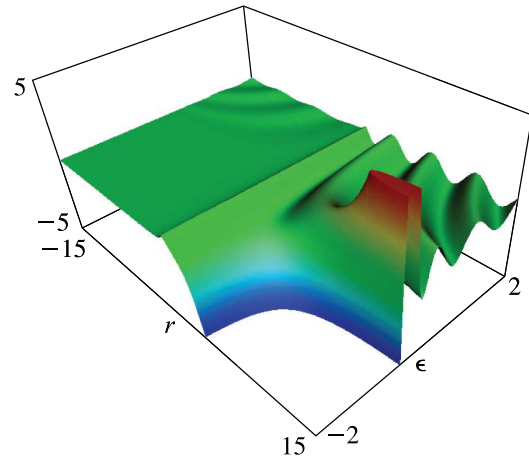


Figure 33.15.7:  $h(\epsilon, \ell; r)$  with  $\ell = 0, -2 < \epsilon < 2, -15 < r < 15$ .

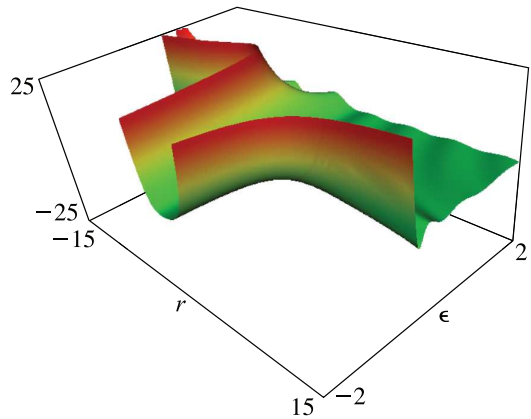


Figure 33.15.8:  $f(\epsilon, \ell; r)$  with  $\ell = 1, -2 < \epsilon < 2, -15 < r < 15$ .

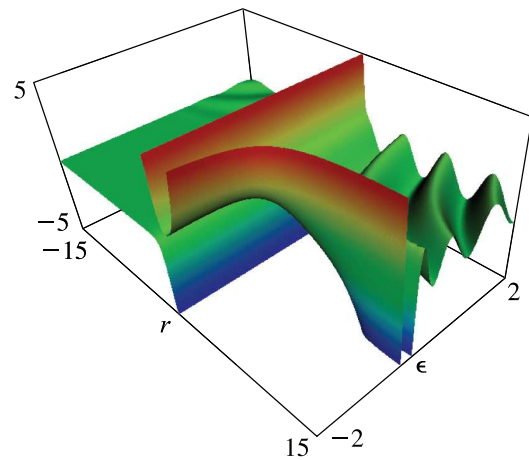


Figure 33.15.9:  $h(\epsilon, \ell; r)$  with  $\ell = 1, -2 < \epsilon < 2, -15 < r < 15$ .

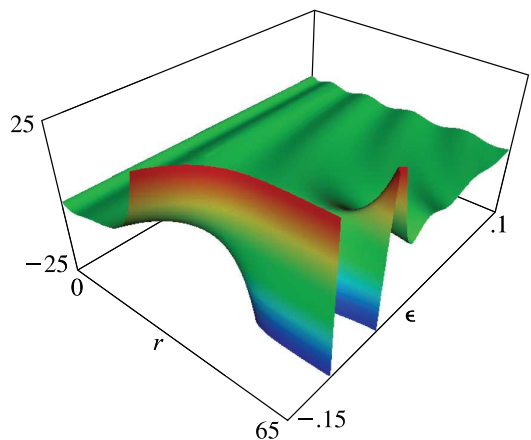


Figure 33.15.10:  $s(\epsilon, \ell; r)$  with  $\ell = 0, -0.15 < \epsilon < 0.10, 0 < r < 65$ .

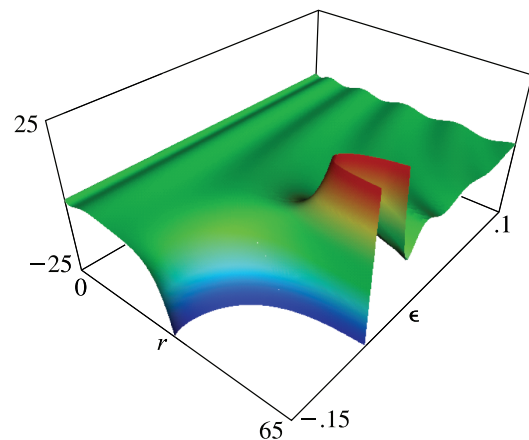


Figure 33.15.11:  $c(\epsilon, \ell; r)$  with  $\ell = 0, -0.15 < \epsilon < 0.10, 0 < r < 65$ .

### 33.16 Connection Formulas

#### 33.16(i) $F_\ell$ and $G_\ell$ in Terms of $f$ and $h$

$$33.16.1 \quad F_\ell(\eta, \rho) = \frac{(2\ell+1)! C_\ell(\eta)}{(-2\eta)^{\ell+1}} f(1/\eta^2, \ell; -\eta\rho),$$

$$33.16.2 \quad G_\ell(\eta, \rho) = \frac{\pi(-2\eta)^\ell}{(2\ell+1)! C_\ell(\eta)} h(1/\eta^2, \ell; -\eta\rho),$$

where  $C_\ell(\eta)$  is given by (33.2.5) or (33.2.6).

#### 33.16(ii) $f$ and $h$ in Terms of $F_\ell$ and $G_\ell$ when $\epsilon > 0$

When  $\epsilon > 0$  denote

$$33.16.3 \quad \tau = \epsilon^{1/2} (> 0),$$

and again define  $A(\epsilon, \ell)$  by (33.14.11) or (33.14.12). Then for  $r > 0$

$$33.16.4 \quad f(\epsilon, \ell; r) = \left( \frac{2}{\pi\tau} \frac{1 - e^{-2\pi/\tau}}{A(\epsilon, \ell)} \right)^{1/2} F_\ell(-1/\tau, \tau r),$$

$$33.16.5 \quad h(\epsilon, \ell; r) = \left( \frac{2}{\pi\tau} \frac{A(\epsilon, \ell)}{1 - e^{-2\pi/\tau}} \right)^{1/2} G_\ell(-1/\tau, \tau r).$$

Alternatively, for  $r < 0$

$$33.16.6 \quad f(\epsilon, \ell; r) = (-1)^{\ell+1} \left( \frac{2}{\pi\tau} \frac{e^{2\pi/\tau} - 1}{A(\epsilon, \ell)} \right)^{1/2} F_\ell(1/\tau, -\tau r),$$

$$33.16.7 \quad h(\epsilon, \ell; r) = (-1)^\ell \left( \frac{2}{\pi\tau} \frac{A(\epsilon, \ell)}{e^{2\pi/\tau} - 1} \right)^{1/2} G_\ell(1/\tau, -\tau r).$$

#### 33.16(iii) $f$ and $h$ in Terms of $W_{\kappa, \mu}(z)$ when $\epsilon < 0$

When  $\epsilon < 0$  denote

$$33.16.8 \quad \nu = 1/(-\epsilon)^{1/2} (> 0),$$

$$\zeta_\ell(\nu, r) = W_{\nu, \ell + \frac{1}{2}}(2r/\nu),$$

$$33.16.9 \quad \xi_\ell(\nu, r) = \Re \left( e^{i\pi\nu} W_{-\nu, \ell + \frac{1}{2}}(e^{i\pi} 2r/\nu) \right),$$

and again define  $A(\epsilon, \ell)$  by (33.14.11) or (33.14.12). Then for  $r > 0$

$$33.16.10 \quad f(\epsilon, \ell; r) = (-1)^\ell \nu^{\ell+1} \left( -\frac{\cos(\pi\nu)\zeta_\ell(\nu, r)}{\Gamma(\ell+1+\nu)} + \frac{\sin(\pi\nu)\Gamma(\nu-\ell)\xi_\ell(\nu, r)}{\pi} \right),$$

$$33.16.11 \quad h(\epsilon, \ell; r) = (-1)^\ell \nu^{\ell+1} A(\epsilon, \ell) \left( \frac{\sin(\pi\nu)\zeta_\ell(\nu, r)}{\Gamma(\ell+1+\nu)} + \frac{\cos(\pi\nu)\Gamma(\nu-\ell)\xi_\ell(\nu, r)}{\pi} \right).$$

Alternatively, for  $r < 0$

33.16.12

$$f(\epsilon, \ell; r) = \frac{(-1)^\ell \nu^{\ell+1}}{\pi} \left( -\frac{\pi \xi_\ell(-\nu, r)}{\Gamma(\ell+1+\nu)} + \sin(\pi\nu) \cos(\pi\nu) \Gamma(\nu-\ell) \zeta_\ell(-\nu, r) \right),$$

33.16.13

$$h(\epsilon, \ell; r) = (-1)^\ell \nu^{\ell+1} A(\epsilon, \ell) \Gamma(\nu-\ell) \zeta_\ell(-\nu, r) / \pi.$$

#### 33.16(iv) $s$ and $c$ in Terms of $F_\ell$ and $G_\ell$ when $\epsilon > 0$

When  $\epsilon > 0$ , again denote  $\tau$  by (33.16.3). Then for  $r > 0$

$$33.16.14 \quad s(\epsilon, \ell; r) = (\pi\tau)^{-1/2} F_\ell(-1/\tau, \tau r),$$

$$c(\epsilon, \ell; r) = (\pi\tau)^{-1/2} G_\ell(-1/\tau, \tau r).$$

Alternatively, for  $r < 0$

$$33.16.15 \quad s(\epsilon, \ell; r) = (\pi\tau)^{-1/2} F_\ell(1/\tau, -\tau r),$$

$$c(\epsilon, \ell; r) = (\pi\tau)^{-1/2} G_\ell(1/\tau, -\tau r).$$

#### 33.16(v) $s$ and $c$ in Terms of $W_{\kappa, \mu}(z)$ when $\epsilon < 0$

When  $\epsilon < 0$  denote  $\nu$ ,  $\zeta_\ell(\nu, r)$ , and  $\xi_\ell(\nu, r)$  by (33.16.8) and (33.16.9). Also denote

$$33.16.16 \quad K(\nu, \ell) = (\nu^2 \Gamma(\nu + \ell + 1) \Gamma(\nu - \ell))^{-1/2}.$$

Then for  $r > 0$

$$s(\epsilon, \ell; r) = \frac{(-1)^\ell}{2\nu^{1/2}} \left( \frac{\sin(\pi\nu)}{\pi K(\nu, \ell)} \xi_\ell(\nu, r) - \cos(\pi\nu) \nu^2 K(\nu, \ell) \zeta_\ell(\nu, r) \right),$$

33.16.17

$$c(\epsilon, \ell; r) = \frac{(-1)^\ell}{2\nu^{1/2}} \left( \frac{\cos(\pi\nu)}{\pi K(\nu, \ell)} \xi_\ell(\nu, r) + \sin(\pi\nu) \nu^2 K(\nu, \ell) \zeta_\ell(\nu, r) \right).$$

Alternatively, for  $r < 0$

33.16.18

$$s(\epsilon, \ell; r) = \frac{(-1)^{\ell+1}}{2^{1/2}} \left( \frac{\nu^{3/2}}{K(\nu, \ell)} \xi_\ell(-\nu, r) - \frac{\sin(\pi\nu) \cos(\pi\nu)}{\pi \nu^{1/2}} K(\nu, \ell) \zeta_\ell(-\nu, r) \right),$$

$$c(\epsilon, \ell; r) = \frac{(-1)^\ell}{\pi(2\nu)^{1/2}} K(\nu, \ell) \zeta_\ell(-\nu, r).$$



### 33.17 Recurrence Relations and Derivatives

- 33.17.1  $(\ell + 1)r f(\epsilon, \ell - 1; r) - (2\ell + 1)(\ell(\ell + 1) - r) f(\epsilon, \ell; r) + \ell(1 + (\ell + 1)^2\epsilon) r f(\epsilon, \ell + 1; r) = 0,$
- 33.17.2  $(\ell + 1)(1 + \ell^2\epsilon) r h(\epsilon, \ell - 1; r) - (2\ell + 1)(\ell(\ell + 1) - r) h(\epsilon, \ell; r) + \ell r h(\epsilon, \ell + 1; r) = 0,$
- 33.17.3  $(\ell + 1)r f'(\epsilon, \ell; r) = ((\ell + 1)^2 - r) f(\epsilon, \ell; r) - (1 + (\ell + 1)^2\epsilon) r f(\epsilon, \ell + 1; r),$
- 33.17.4  $(\ell + 1)r h'(\epsilon, \ell; r) = ((\ell + 1)^2 - r) h(\epsilon, \ell; r) - r h(\epsilon, \ell + 1; r).$

### 33.18 Limiting Forms for Large $\ell$

As  $\ell \rightarrow \infty$  with  $\epsilon$  and  $r (\neq 0)$  fixed,

33.18.1  $f(\epsilon, \ell; r) \sim \frac{(2r)^{\ell+1}}{(2\ell + 1)!}, \quad h(\epsilon, \ell; r) \sim \frac{(2\ell)!}{\pi(2r)^\ell}.$

### 33.19 Power-Series Expansions in $r$

33.19.1  $f(\epsilon, \ell; r) = r^{\ell+1} \sum_{k=0}^{\infty} \alpha_k r^k,$

where

33.19.2  $\alpha_0 = 2^{\ell+1}/(2\ell + 1)!, \quad \alpha_1 = -\alpha_0/(\ell + 1),$   
 $k(k + 2\ell + 1)\alpha_k + 2\alpha_{k-1} + \epsilon\alpha_{k-2} = 0, \quad k = 2, 3, \dots$

33.19.3

$$2\pi h(\epsilon, \ell; r) = \sum_{k=0}^{2\ell} \frac{(2\ell - k)! \gamma_k}{k!} (2r)^{k-\ell} - \sum_{k=0}^{\infty} \delta_k r^{k+\ell+1} - A(\epsilon, \ell) (2 \ln |2r/\kappa| + \Re\psi(\ell + 1 + \kappa) + \Re\psi(-\ell + \kappa)) f(\epsilon, \ell; r), \quad r \neq 0.$$

Here  $\kappa$  is defined by (33.14.6),  $A(\epsilon, \ell)$  is defined by (33.14.11) or (33.14.12),  $\gamma_0 = 1, \gamma_1 = 1,$  and

33.19.4

$\gamma_k - \gamma_{k-1} + \frac{1}{4}(k-1)(k-2\ell-2)\epsilon\gamma_{k-2} = 0, \quad k = 2, 3, \dots$

Also,

33.19.5  $\delta_0 = (\beta_{2\ell+1} - 2(\psi(2\ell + 2) + \psi(1))A(\epsilon, \ell)) \alpha_0,$   
 $\delta_1 = (\beta_{2\ell+2} - 2(\psi(2\ell + 3) + \psi(2))A(\epsilon, \ell)) \alpha_1,$

33.19.6  $k(k + 2\ell + 1)\delta_k + 2\delta_{k-1} + \epsilon\delta_{k-2} + 2(2k + 2\ell + 1)A(\epsilon, \ell)\alpha_k = 0, \quad k = 2, 3, \dots,$

with  $\beta_0 = \beta_1 = 0,$  and

33.19.7  $\beta_k - \beta_{k-1} + \frac{1}{4}(k-1)(k-2\ell-2)\epsilon\beta_{k-2} + \frac{1}{2}(k-1)\epsilon\gamma_{k-2} = 0,$   
 $k = 2, 3, \dots$

The expansions (33.19.1) and (33.19.3) converge for all finite values of  $r,$  except  $r = 0$  in the case of (33.19.3).

### 33.20 Expansions for Small $|\epsilon|$

#### 33.20(i) Case $\epsilon = 0$

33.20.1  $f(0, \ell; r) = (2r)^{1/2} J_{2\ell+1}(\sqrt{8r}),$   
 $h(0, \ell; r) = -(2r)^{1/2} Y_{2\ell+1}(\sqrt{8r}), \quad r > 0,$

33.20.2  $f(0, \ell; r) = (-1)^{\ell+1}(2|r|)^{1/2} I_{2\ell+1}(\sqrt{8|r|}),$   
 $h(0, \ell; r) = (-1)^\ell(2/\pi)(2|r|)^{1/2} K_{2\ell+1}(\sqrt{8|r|}), \quad r < 0.$

For the functions  $J, Y, I,$  and  $K$  see §§10.2(ii), 10.25(ii).

#### 33.20(ii) Power-Series in $\epsilon$ for the Regular Solution

33.20.3  $f(\epsilon, \ell; r) = \sum_{k=0}^{\infty} \epsilon^k F_k(\ell; r),$

where

33.20.4

$F_k(\ell; r) = \sum_{p=2k}^{3k} (2r)^{(p+1)/2} C_{k,p} J_{2\ell+1+p}(\sqrt{8r}), \quad r > 0,$

33.20.5

$F_k(\ell; r) = \sum_{p=2k}^{3k} (-1)^{\ell+1+p} (2|r|)^{(p+1)/2} C_{k,p} I_{2\ell+1+p}(\sqrt{8|r|}), \quad r < 0.$

The functions  $J$  and  $I$  are as in §§10.2(ii), 10.25(ii), and the coefficients  $C_{k,p}$  are given by  $C_{0,0} = 1, C_{1,0} = 0,$  and

$C_{k,p} = 0, \quad p < 2k \text{ or } p > 3k,$   
 33.20.6  $C_{k,p} = (-(2\ell + p)C_{k-1,p-2} + C_{k-1,p-3})/(4p), \quad k > 0, 2k \leq p \leq 3k.$

The series (33.20.3) converges for all  $r$  and  $\epsilon.$

### 33.20(iii) Asymptotic Expansion for the Irregular Solution

As  $\epsilon \rightarrow 0$  with  $\ell$  and  $r$  fixed,

$$33.20.7 \quad h(\epsilon, \ell; r) \sim -A(\epsilon, \ell) \sum_{k=0}^{\infty} \epsilon^k H_k(\ell; r),$$

where  $A(\epsilon, \ell)$  is given by (33.14.11), (33.14.12), and

33.20.8

$$H_k(\ell; r) = \sum_{p=2k}^{3k} (2r)^{(p+1)/2} C_{k,p} Y_{2\ell+1+p}(\sqrt{8r}), \quad r > 0,$$

33.20.9

$$H_k(\ell; r) = (-1)^{\ell+1} \frac{2}{\pi} \sum_{p=2k}^{3k} (2|r|)^{(p+1)/2} C_{k,p} K_{2\ell+1+p}(\sqrt{8|r|}),$$

$r < 0.$

The functions  $Y$  and  $K$  are as in §§10.2(ii), 10.25(ii), and the coefficients  $C_{k,p}$  are given by (33.20.6).

### 33.20(iv) Uniform Asymptotic Expansions

For a comprehensive collection of asymptotic expansions that cover  $f(\epsilon, \ell; r)$  and  $h(\epsilon, \ell; r)$  as  $\epsilon \rightarrow 0_{\pm}$  and are uniform in  $r$ , including unbounded values, see Curtis (1964a, §7). These expansions are in terms of elementary functions, Airy functions, and Bessel functions of orders  $2\ell + 1$  and  $2\ell + 2$ .

## 33.21 Asymptotic Approximations for Large $|r|$

### 33.21(i) Limiting Forms

We indicate here how to obtain the limiting forms of  $f(\epsilon, \ell; r)$ ,  $h(\epsilon, \ell; r)$ ,  $s(\epsilon, \ell; r)$ , and  $c(\epsilon, \ell; r)$  as  $r \rightarrow \pm\infty$ , with  $\epsilon$  and  $\ell$  fixed, in the following cases:

(a) When  $r \rightarrow \pm\infty$  with  $\epsilon > 0$ , Equations (33.16.4)–(33.16.7) are combined with (33.10.1).

(b) When  $r \rightarrow \pm\infty$  with  $\epsilon < 0$ , Equations (33.16.10)–(33.16.13) are combined with

$$33.21.1 \quad \begin{aligned} \zeta_{\ell}(\nu, r) &\sim e^{-r/\nu} (2r/\nu)^{\nu}, \\ \xi_{\ell}(\nu, r) &\sim e^{r/\nu} (2r/\nu)^{-\nu}, \end{aligned} \quad r \rightarrow \infty,$$

$$33.21.2 \quad \begin{aligned} \zeta_{\ell}(-\nu, r) &\sim e^{r/\nu} (-2r/\nu)^{-\nu}, \\ \xi_{\ell}(-\nu, r) &\sim e^{-r/\nu} (-2r/\nu)^{\nu}, \end{aligned} \quad r \rightarrow -\infty.$$

Corresponding approximations for  $s(\epsilon, \ell; r)$  and  $c(\epsilon, \ell; r)$  as  $r \rightarrow \infty$  can be obtained via (33.16.17), and as  $r \rightarrow -\infty$  via (33.16.18).

(c) When  $r \rightarrow \pm\infty$  with  $\epsilon = 0$ , combine (33.20.1), (33.20.2) with §§10.7(ii), 10.30(ii).

### 33.21(ii) Asymptotic Expansions

For asymptotic expansions of  $f(\epsilon, \ell; r)$  and  $h(\epsilon, \ell; r)$  as  $r \rightarrow \pm\infty$  with  $\epsilon$  and  $\ell$  fixed, see Curtis (1964a, §6).

## Physical Applications

### 33.22 Particle Scattering and Atomic and Molecular Spectra

#### 33.22(i) Schrödinger Equation

With  $e$  denoting here the elementary charge, the Coulomb potential between two point particles with charges  $Z_1e, Z_2e$  and masses  $m_1, m_2$  separated by a distance  $s$  is  $V(s) = Z_1Z_2e^2/(4\pi\epsilon_0s) = Z_1Z_2\alpha\hbar c/s$ , where  $Z_j$  are atomic numbers,  $\epsilon_0$  is the electric constant,  $\alpha$  is the fine structure constant, and  $\hbar$  is the reduced Planck's constant. The reduced mass is  $m = m_1m_2/(m_1 + m_2)$ , and at energy of relative motion  $E$  with relative orbital angular momentum  $\ell\hbar$ , the Schrödinger equation for the radial wave function  $w(s)$  is given by

33.22.1

$$\left( -\frac{\hbar^2}{2m} \left( \frac{d^2}{ds^2} - \frac{\ell(\ell+1)}{s^2} \right) + \frac{Z_1Z_2\alpha\hbar c}{s} \right) w = Ew,$$

With the substitutions

$$33.22.2 \quad k = (2mE/\hbar^2)^{1/2}, \quad Z = mZ_1Z_2\alpha c/\hbar, \quad x = s,$$

(33.22.1) becomes

$$33.22.3 \quad \frac{d^2w}{dx^2} + \left( k^2 - \frac{2Z}{x} - \frac{\ell(\ell+1)}{x^2} \right) w = 0.$$

#### 33.22(ii) Definitions of Variables

##### k Scaling

The  $k$ -scaled variables  $\rho$  and  $\eta$  of §33.2 are given by

$$33.22.4 \quad \rho = s(2mE/\hbar^2)^{1/2}, \quad \eta = Z_1Z_2\alpha c(m/(2E))^{1/2}.$$

At positive energies  $E > 0$ ,  $\rho \geq 0$ , and:

$$\begin{aligned} \text{Attractive potentials:} & \quad Z_1Z_2 < 0, \eta < 0. \\ \text{Zero potential (} V = 0 \text{):} & \quad Z_1Z_2 = 0, \eta = 0. \\ \text{Repulsive potentials:} & \quad Z_1Z_2 > 0, \eta > 0. \end{aligned}$$

Positive-energy functions correspond to processes such as Rutherford scattering and Coulomb excitation of nuclei (Alder *et al.* (1956)), and atomic photo-ionization and electron-ion collisions (Bethe and Salpeter (1977)).

At negative energies  $E < 0$  and both  $\rho$  and  $\eta$  are purely imaginary. The negative-energy functions are widely used in the description of atomic and molecular spectra; see Bethe and Salpeter (1977), Seaton (1983), and Aymar *et al.* (1996). In these applications, the  $Z$ -scaled variables  $r$  and  $\epsilon$  are more convenient.

**Z Scaling**

The  $Z$ -scaled variables  $r$  and  $\epsilon$  of §33.14 are given by

$$33.22.5 \quad r = -Z_1 Z_2 (m c \alpha / \hbar) s, \quad \epsilon = E / (Z_1^2 Z_2^2 m c^2 \alpha^2 / 2).$$

For  $Z_1 Z_2 = -1$  and  $m = m_e$ , the electron mass, the scaling factors in (33.22.5) reduce to the Bohr radius,  $a_0 = \hbar / (m_e c \alpha)$ , and to a multiple of the Rydberg constant,

$$R_\infty = m_e c \alpha^2 / (2 \hbar).$$

$$\text{Attractive potentials:} \quad Z_1 Z_2 < 0, \quad r > 0.$$

$$\text{Zero potential } (V = 0): \quad Z_1 Z_2 = 0, \quad r = 0.$$

$$\text{Repulsive potentials:} \quad Z_1 Z_2 > 0, \quad r < 0.$$

**ik Scaling**

The  $ik$ -scaled variables  $z$  and  $\kappa$  of §13.2 are given by

$$33.22.6 \quad z = 2is(2mE/\hbar^2)^{1/2}, \quad \kappa = iZ_1 Z_2 \alpha c (m/(2E))^{1/2}.$$

$$\text{Attractive potentials:} \quad Z_1 Z_2 < 0, \quad \Im \kappa < 0.$$

$$\text{Zero potential } (V = 0): \quad Z_1 Z_2 = 0, \quad \kappa = 0.$$

$$\text{Repulsive potentials:} \quad Z_1 Z_2 > 0, \quad \Im \kappa > 0.$$

Customary variables are  $(\epsilon, r)$  in atomic physics and  $(\eta, \rho)$  in atomic and nuclear physics. Both variable sets may be used for attractive and repulsive potentials: the  $(\epsilon, r)$  set cannot be used for a zero potential because this would imply  $r = 0$  for all  $s$ , and the  $(\eta, \rho)$  set cannot be used for zero energy  $E$  because this would imply  $\rho = 0$  always.

**33.22(iii) Conversions Between Variables**

$$33.22.7 \quad r = -\eta \rho, \quad \epsilon = 1/\eta^2, \quad Z \text{ from } k.$$

$$33.22.8 \quad z = 2i\rho, \quad \kappa = i\eta, \quad ik \text{ from } k.$$

$$33.22.9 \quad \rho = z/(2i), \quad \eta = \kappa/i, \quad k \text{ from } ik.$$

$$33.22.10 \quad r = \kappa z/2, \quad \epsilon = -1/\kappa^2, \quad Z \text{ from } ik.$$

$$33.22.11 \quad \eta = \pm \epsilon^{-1/2}, \quad \rho = -r/\eta, \quad k \text{ from } Z.$$

33.22.12  $\kappa = \pm(-\epsilon)^{-1/2}$ ,  $z = 2r/\kappa$ ,  $ik$  from  $Z$ . Resolution of the ambiguous signs in (33.22.11), (33.22.12) depends on the sign of  $Z/k$  in (33.22.3). See also §§33.14(ii), 33.14(iii), 33.22(i), and 33.22(ii).

**33.22(iv) Klein–Gordon and Dirac Equations**

The relativistic motion of spinless particles in a Coulomb field, as encountered in pionic atoms and pion-nucleon scattering (Backenstoss (1970)) is described by a Klein–Gordon equation equivalent to (33.2.1); see Barnett (1981a). The motion of a relativistic electron in a Coulomb field, which arises in the theory of the electronic structure of heavy elements (Johnson (2007)), is described by a Dirac equation. The solutions to this equation are closely related to the Coulomb functions; see Greiner *et al.* (1985).

**33.22(v) Asymptotic Solutions**

The Coulomb solutions of the Schrödinger and Klein–Gordon equations are almost always used in the external region, outside the range of any non-Coulomb forces or couplings.

For scattering problems, the interior solution is then matched to a linear combination of a pair of Coulomb functions,  $F_\ell(\eta, \rho)$  and  $G_\ell(\eta, \rho)$ , or  $f(\epsilon, \ell; r)$  and  $h(\epsilon, \ell; r)$ , to determine the scattering  $S$ -matrix and also the correct normalization of the interior wave solutions; see Bloch *et al.* (1951).

For bound-state problems only the exponentially decaying solution is required, usually taken to be the Whittaker function  $W_{-\eta, \ell + \frac{1}{2}}(2\rho)$ . The functions  $\phi_{n, \ell}(r)$  defined by (33.14.14) are the hydrogenic bound states in attractive Coulomb potentials; their polynomial components are often called *associated Laguerre functions*; see Christy and Duck (1961) and Bethe and Salpeter (1977).

**33.22(vi) Solutions Inside the Turning Point**

The penetrability of repulsive Coulomb potential barriers is normally expressed in terms of the quantity  $\rho / (F_\ell^2(\eta, \rho) + G_\ell^2(\eta, \rho))$  (Mott and Massey (1956, pp. 63–65)). The WKB approximations of §33.23(vii) may also be used to estimate the penetrability.

**33.22(vii) Complex Variables and Parameters**

The Coulomb functions given in this chapter are most commonly evaluated for real values of  $\rho$ ,  $r$ ,  $\eta$ ,  $\epsilon$  and nonnegative integer values of  $\ell$ , but they may be continued analytically to complex arguments and order  $\ell$  as indicated in §33.13.

Examples of applications to noninteger and/or complex variables are as follows.

- Scattering at complex energies. See for example McDonald and Nuttall (1969).
- Searches for resonances as poles of the  $S$ -matrix in the complex half-plane  $\Im k < 0$ . See for example Csóto and Hale (1997).
- Regge poles at complex values of  $\ell$ . See for example Takemasa *et al.* (1979).
- Eigenstates using complex-rotated coordinates  $r \rightarrow r e^{i\theta}$ , so that resonances have square-integrable eigenfunctions. See for example Halley *et al.* (1993).
- Solution of relativistic Coulomb equations. See for example Cooper *et al.* (1979) and Barnett (1981b).

- Gravitational radiation. See for example Berti and Cardoso (2006).

For further examples see Humblet (1984).

## Computation

### 33.23 Methods of Computation

#### 33.23(i) Methods for the Confluent Hypergeometric Functions

The methods used for computing the Coulomb functions described below are similar to those in §13.29.

#### 33.23(ii) Series Solutions

The power-series expansions of §§33.6 and 33.19 converge for all finite values of the radii  $\rho$  and  $r$ , respectively, and may be used to compute the regular and irregular solutions. Cancellation errors increase with increases in  $\rho$  and  $|r|$ , and may be estimated by comparing the final sum of the series with the largest partial sum. Use of extended-precision arithmetic increases the radial range that yields accurate results, but eventually other methods must be employed, for example, the asymptotic expansions of §§33.11 and 33.21.

#### 33.23(iii) Integration of Defining Differential Equations

When numerical values of the Coulomb functions are available for some radii, their values for other radii may be obtained by direct numerical integration of equations (33.2.1) or (33.14.1), provided that the integration is carried out in a stable direction (§3.7). Thus the regular solutions can be computed from the power-series expansions (§§33.6, 33.19) for small values of the radii and then integrated in the direction of increasing values of the radii. On the other hand, the irregular solutions of §§33.2(iii) and 33.14(iii) need to be integrated in the direction of decreasing radii beginning, for example, with values obtained from asymptotic expansions (§§33.11 and 33.21).

#### 33.23(iv) Recurrence Relations

In a similar manner to §33.23(iii) the recurrence relations of §§33.4 or 33.17 can be used for a range of values of the integer  $\ell$ , provided that the recurrence is carried out in a stable direction (§3.6). This implies decreasing  $\ell$  for the regular solutions and increasing  $\ell$  for the irregular solutions of §§33.2(iii) and 33.14(iii).

#### 33.23(v) Continued Fractions

§33.8 supplies continued fractions for  $F'_\ell/F_\ell$  and  $H_\ell^{\pm'}/H_\ell^\pm$ . Combined with the Wronskians (33.2.12), the values of  $F_\ell$ ,  $G_\ell$ , and their derivatives can be extracted. Inside the turning points, that is, when  $\rho < \rho_{\text{tp}}(\eta, \ell)$ , there can be a loss of precision by a factor of approximately  $|G_\ell|^2$ .

#### 33.23(vi) Other Numerical Methods

Curtis (1964a, §10) describes the use of series, radial integration, and other methods to generate the tables listed in §33.24.

Bardin *et al.* (1972) describes ten different methods for the calculation of  $F_\ell$  and  $G_\ell$ , valid in different regions of the  $(\eta, \rho)$ -plane.

Thompson and Barnett (1985, 1986) and Thompson (2004) use combinations of series, continued fractions, and Padé-accelerated asymptotic expansions (§3.11(iv)) for the analytic continuations of Coulomb functions.

Noble (2004) obtains double-precision accuracy for  $W_{-\eta, \mu}(2\rho)$  for a wide range of parameters using a combination of recurrence techniques, power-series expansions, and numerical quadrature; compare (33.2.7).

#### 33.23(vii) WKBJ Approximations

WKBJ approximations (§2.7(iii)) for  $\rho > \rho_{\text{tp}}(\eta, \ell)$  are presented in Hull and Breit (1959) and Seaton and Peach (1962: in Eq. (12)  $(\rho-c)/c$  should be  $(\rho-c)/\rho$ ). A set of consistent second-order WKBJ formulas is given by Burgess (1963: in Eq. (16)  $3\kappa^2+2$  should be  $3\kappa^2c+2$ ). Seaton (1984) estimates the accuracies of these approximations.

Hull and Breit (1959) and Barnett (1981b) give WKBJ approximations for  $F_0$  and  $G_0$  in the region inside the turning point:  $\rho < \rho_{\text{tp}}(\eta, \ell)$ .

### 33.24 Tables

- Abramowitz and Stegun (1964, Chapter 14) tabulates  $F_0(\eta, \rho)$ ,  $G_0(\eta, \rho)$ ,  $F'_0(\eta, \rho)$ , and  $G'_0(\eta, \rho)$  for  $\eta = 0.5(.5)20$  and  $\rho = 1(1)20, 5\text{S}$ ;  $C_0(\eta)$  for  $\eta = 0(.05)3, 6\text{S}$ .
- Curtis (1964a) tabulates  $P_\ell(\epsilon, r)$ ,  $Q_\ell(\epsilon, r)$  (§33.1), and related functions for  $\ell = 0, 1, 2$  and  $\epsilon = -2(.2)2$ , with  $x = 0(.1)4$  for  $\epsilon < 0$  and  $x = 0(.1)10$  for  $\epsilon \geq 0$ ; 6D.

For earlier tables see Hull and Breit (1959) and Fletcher *et al.* (1962, §22.59).

### 33.25 Approximations

Cody and Hillstrom (1970) provides rational approximations of the phase shift  $\sigma_0(\eta) = \text{ph}\Gamma(1+i\eta)$  (see (33.2.10)) for the ranges  $0 \leq \eta \leq 2$ ,  $2 \leq \eta \leq 4$ , and  $4 \leq \eta \leq \infty$ . Maximum relative errors range from  $1.09 \times 10^{-20}$  to  $4.24 \times 10^{-19}$ .

### 33.26 Software

See <http://dlmf.nist.gov/33.26>.

## References

### General References

The main references used in writing this chapter are Hull and Breit (1959), Thompson and Barnett (1986), and Seaton (2002). For additional bibliographic reading see also the General References in Chapter 13.

### Sources

The following list gives the references or other indications of proofs that were used in constructing the various sections of this chapter. These sources supplement the references that are quoted in the text.

- §33.2** Yost *et al.* (1936), Hull and Breit (1959, pp. 409–410).
- §33.3** These graphics were produced at NIST.
- §33.4** Powell (1947).
- §33.5** Yost *et al.* (1936), Hull and Breit (1959, pp. 435–436), Wheeler (1937), Biedenharn *et al.* (1955). For (33.5.9) combine the second formula in (5.4.2) with (5.11.7).
- §33.6** For (33.6.5) use the definition (33.2.8) with  $U(a, b, z)$  expanded as in (13.2.9). For (33.6.4) use (33.2.4) with Eq. (1.12) of Buchholz (1969).
- §33.7** Hull and Breit (1959, pp. 413–416). For (33.7.1) see also Lowan and Horenstein (1942), with change of variable  $\xi = 1 - t$  in the integral that follows Eq. (8). For (33.7.2) see also Hoisington and Breit (1938). For (33.7.3) see also Bloch *et al.* (1950). For (33.7.4) see also Newton (1952).
- §33.9** The convergence of (33.9.1) follows from the asymptotic forms, for large  $k$ , of  $a_k$  (obtained by application of §2.9(i)) and  $j_{\ell+k}(\rho)$  (obtained from (10.19.1) and (10.47.3)). For (33.9.3) see Yost *et al.* (1936), Abramowitz (1954), and Humblet (1985). For (33.9.4) see Curtis (1964a, §5.1). For (33.9.6) see Yost *et al.* (1936) and Abramowitz (1954).
- §33.10** Yost *et al.* (1936), Fröberg (1955), Humblet (1984), Humblet (1985, Eqs. 2.10a,b and 4.7a,b). For (33.10.6) and (33.10.10) use (33.2.5), (33.2.10), and §5.11(i).
- §33.11** Fröberg (1955).
- §33.14** Curtis (1964a, pp. ix–xxv), Seaton (1983), Seaton (2002, Eqs. 3, 4, 7, 9, 14, 22, 47, 49, 51, 109, 113–116, 122–125, 131, and §2.3). For (33.14.11) and (33.14.12) see Humblet (1985, Eqs. 1.4a,b), Seaton (1982, Eq. 2.4.4).
- §33.15** These graphics were produced at NIST.
- §33.16** Seaton (2002, Eqs. 104–109, 119–121, 130, 131). (33.16.3)–(33.16.7) are generalizations of Seaton (2002, Eqs. 88, 90, 93, 95). For (33.16.14) and (33.16.15) combine (33.14.9) with (33.16.4)–(33.16.7). For (33.16.17) and (33.16.18) combine (33.14.6), (33.14.9)–(33.14.12), (33.16.10)–(33.16.13), and (33.16.16).
- §33.17** Seaton (2002, Eqs. 77, 78, 82).
- §33.18** Combine (33.5.8) and (33.16.1), (33.16.2). For  $f(\epsilon, \ell; r)$  (33.19.1) can also be used.
- §33.19** Seaton (2002, Eqs. 15–17, 31–48).
- §33.20** Seaton (2002, Eqs. 58, 59, 64, 67–70, 96, 98, 100, 102 (corrected)).
- §33.21** Seaton (2002, Eqs. 104, 107), or apply (13.14.21) to (33.16.9).
- §33.23** Stable integration directions for the differential equations are determined by comparison of the asymptotic behavior of the solutions as the radii tend to infinity and also as the radii tend to zero (§§33.11, 33.21; §§33.6, 33.19). Stable recurrence directions for §33.4 are determined by the asymptotic form of  $F_\ell(\eta, \rho)/G_\ell(\eta, \rho)$  as  $\ell \rightarrow \infty$ ; see (33.5.8) and (33.5.9). For §33.17 see §33.18.

## Chapter 34

# $3j, 6j, 9j$ Symbols

L. C. Maximon<sup>1</sup>

<b>Notation</b>	<b>758</b>	34.10 Zeros . . . . .	765
34.1 Special Notation . . . . .	758	34.11 Higher-Order $3nj$ Symbols . . . . .	765
<b>Properties</b>	<b>758</b>	<b>Applications</b>	<b>765</b>
34.2 Definition: $3j$ Symbol . . . . .	758	34.12 Physical Applications . . . . .	765
34.3 Basic Properties: $3j$ Symbol . . . . .	759	<b>Computation</b>	<b>765</b>
34.4 Definition: $6j$ Symbol . . . . .	761	34.13 Methods of Computation . . . . .	765
34.5 Basic Properties: $6j$ Symbol . . . . .	762	34.14 Tables . . . . .	765
34.6 Definition: $9j$ Symbol . . . . .	763	34.15 Software . . . . .	766
34.7 Basic Properties: $9j$ Symbol . . . . .	764	<b>References</b>	<b>766</b>
34.8 Approximations for Large Parameters . .	764		
34.9 Graphical Method . . . . .	765		

<sup>1</sup>Center for Nuclear Studies, Department of Physics, The George Washington University, Washington, D.C.  
Copyright © 2009 National Institute of Standards and Technology. All rights reserved.

## Notation

### 34.1 Special Notation

(For other notation see pp. xiv and 873.)

$2j_1, 2j_2, 2j_3, 2l_1, 2l_2, 2l_3$  nonnegative integers.  
 $r, s, t$  nonnegative integers.

The main functions treated in this chapter are the Wigner  $3j, 6j, 9j$  symbols, respectively,

$$\begin{pmatrix} j_1 & j_2 & j_3 \\ m_1 & m_2 & m_3 \end{pmatrix}, \quad \left\{ \begin{matrix} j_1 & j_2 & j_3 \\ l_1 & l_2 & l_3 \end{matrix} \right\}, \quad \begin{Bmatrix} j_{11} & j_{12} & j_{13} \\ j_{21} & j_{22} & j_{23} \\ j_{31} & j_{32} & j_{33} \end{Bmatrix}.$$

The most commonly used alternative notation for the  $3j$  symbol is the Clebsch–Gordan coefficient

$$\begin{aligned} & (j_1 \ m_1 \ j_2 \ m_2 | j_3 \ m_3) \\ & = (-1)^{j_1 - j_2 - m_3} (2j_3 + 1)^{\frac{1}{2}} \begin{pmatrix} j_1 & j_2 & j_3 \\ m_1 & m_2 & m_3 \end{pmatrix}; \end{aligned}$$

see Condon and Shortley (1935). For other notations see Edmonds (1974, pp. 52, 97, 104–105) and Varshalovich *et al.* (1988, §§8.11, 9.10, 10.10).

## Properties

### 34.2 Definition: 3j Symbol

The quantities  $j_1, j_2, j_3$  in the  $3j$  symbol are called *angular momenta*. Either all of them are nonnegative integers, or one is a nonnegative integer and the other

two are half-odd positive integers. They must form the sides of a triangle (possibly degenerate). They therefore satisfy the *triangle conditions*

$$34.2.1 \quad |j_r - j_s| \leq j_t \leq j_r + j_s,$$

where  $r, s, t$  is any permutation of 1, 2, 3. The corresponding *projective quantum numbers*  $m_1, m_2, m_3$  are given by

$$34.2.2 \quad m_r = -j_r, -j_r + 1, \dots, j_r - 1, j_r, \quad r = 1, 2, 3,$$

and satisfy

$$34.2.3 \quad m_1 + m_2 + m_3 = 0.$$

See Figure 34.2.1 for a schematic representation.

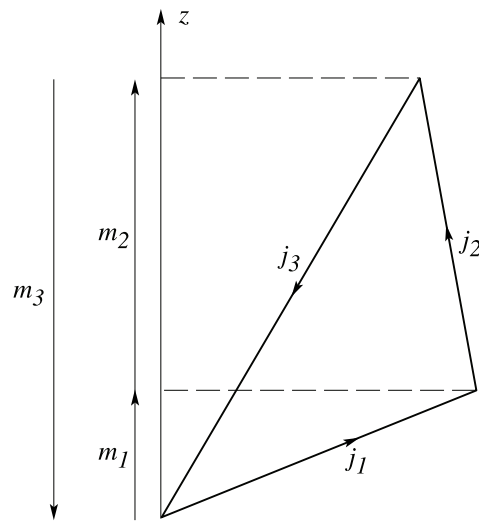


Figure 34.2.1: Angular momenta  $j_r$  and projective quantum numbers  $m_r, r = 1, 2, 3$ .

If either of the conditions (34.2.1) or (34.2.3) is not satisfied, then the  $3j$  symbol is zero. When both conditions are satisfied the  $3j$  symbol can be expressed as the finite sum

$$\begin{aligned} 34.2.4 \quad \begin{pmatrix} j_1 & j_2 & j_3 \\ m_1 & m_2 & m_3 \end{pmatrix} & = (-1)^{j_1 - j_2 - m_3} \Delta(j_1 j_2 j_3) ((j_1 + m_1)! (j_1 - m_1)! (j_2 + m_2)! (j_2 - m_2)! (j_3 + m_3)! (j_3 - m_3)!)^{\frac{1}{2}} \\ & \times \sum_s \frac{(-1)^s}{s! (j_1 + j_2 - j_3 - s)! (j_1 - m_1 - s)! (j_2 + m_2 - s)! (j_3 - j_2 + m_1 + s)! (j_3 - j_1 - m_2 + s)!}, \end{aligned}$$

where

$$34.2.5 \quad \Delta(j_1 j_2 j_3) = \left( \frac{(j_1 + j_2 - j_3)! (j_1 - j_2 + j_3)! (-j_1 + j_2 + j_3)!}{(j_1 + j_2 + j_3 + 1)!} \right)^{\frac{1}{2}},$$

and the summation is over all nonnegative integers  $s$  such that the arguments in the factorials are nonnegative.

Equivalently,

$$\begin{aligned} 34.2.6 \quad \begin{pmatrix} j_1 & j_2 & j_3 \\ m_1 & m_2 & m_3 \end{pmatrix} & = (-1)^{j_2 - m_1 + m_3} \frac{(j_1 + j_2 + m_3)! (j_2 + j_3 - m_1)!}{\Delta(j_1 j_2 j_3) (j_1 + j_2 + j_3 + 1)!} \left( \frac{(j_1 + m_1)! (j_3 - m_3)!}{(j_1 - m_1)! (j_2 + m_2)! (j_2 - m_2)! (j_3 + m_3)!} \right)^{\frac{1}{2}} \\ & \times {}_3F_2(-j_1 - j_2 - j_3 - 1, -j_1 + m_1, -j_3 - m_3; -j_1 - j_2 - m_3, -j_2 - j_3 + m_1; 1), \end{aligned}$$

where  ${}_3F_2$  is defined as in §16.2.

For alternative expressions for the  $3j$  symbol, written either as a finite sum or as other terminating generalized hypergeometric series  ${}_3F_2$  of unit argument, see Varshalovich *et al.* (1988, §§8.21, 8.24–8.26).

### 34.3 Basic Properties: $3j$ Symbol

#### 34.3(i) Special Cases

When any one of  $j_1, j_2, j_3$  is equal to 0,  $\frac{1}{2}$ , or 1, the  $3j$  symbol has a simple algebraic form. Examples are provided by

$$34.3.1 \quad \begin{pmatrix} j & j & 0 \\ m & -m & 0 \end{pmatrix} = \frac{(-1)^{j-m}}{(2j+1)^{\frac{1}{2}}},$$

$$34.3.2 \quad \begin{pmatrix} j & j & 1 \\ m & -m & 0 \end{pmatrix} = (-1)^{j-m} \frac{2m}{(2j(2j+1)(2j+2))^{\frac{1}{2}}}, \quad j \geq \frac{1}{2},$$

$$34.3.3 \quad \begin{pmatrix} j & j & 1 \\ m & -m-1 & 1 \end{pmatrix} = (-1)^{j-m} \left( \frac{2(j-m)(j+m+1)}{2j(2j+1)(2j+2)} \right)^{\frac{1}{2}}, \quad j \geq \frac{1}{2}.$$

For these and other results, and also cases in which any one of  $j_1, j_2, j_3$  is  $\frac{3}{2}$  or 2, see Edmonds (1974, pp. 125–127).

Next define

$$34.3.4 \quad J = j_1 + j_2 + j_3.$$

Then assuming the triangle conditions are satisfied

$$34.3.5 \quad \begin{pmatrix} j_1 & j_2 & j_3 \\ 0 & 0 & 0 \end{pmatrix} = \begin{cases} 0, & J \text{ odd,} \\ (-1)^{\frac{1}{2}J} \left( \frac{(J-2j_1)!(J-2j_2)!(J-2j_3)!}{(J+1)!} \right)^{\frac{1}{2}} \frac{(\frac{1}{2}J)!}{(\frac{1}{2}J-j_1)!(\frac{1}{2}J-j_2)!(\frac{1}{2}J-j_3)!}, & J \text{ even.} \end{cases}$$

Lastly,

$$34.3.6 \quad \begin{pmatrix} j_1 & j_2 & j_1+j_2 \\ m_1 & m_2 & -m_1-m_2 \end{pmatrix} = (-1)^{j_1-j_2+m_1+m_2} \left( \frac{(2j_1)!(2j_2)!(j_1+j_2+m_1+m_2)!(j_1+j_2-m_1-m_2)!}{(2j_1+2j_2+1)!(j_1+m_1)!(j_1-m_1)!(j_2+m_2)!(j_2-m_2)!} \right)^{\frac{1}{2}},$$

$$34.3.7 \quad \begin{pmatrix} j_1 & j_2 & j_3 \\ j_1 & -j_1-m_3 & m_3 \end{pmatrix} = (-1)^{-j_2+j_3+m_3} \left( \frac{(2j_1)!(-j_1+j_2+j_3)!(j_1+j_2+m_3)!(j_3-m_3)!}{(j_1+j_2+j_3+1)!(j_1-j_2+j_3)!(j_1+j_2-j_3)!(-j_1+j_2-m_3)!(j_3+m_3)!} \right)^{\frac{1}{2}}.$$

Again it is assumed that in (34.3.7) the triangle conditions are satisfied.

#### 34.3(ii) Symmetry

Even permutations of columns of a  $3j$  symbol leave it unchanged; odd permutations of columns produce a phase factor  $(-1)^{j_1+j_2+j_3}$ , for example,

$$34.3.8 \quad \begin{pmatrix} j_1 & j_2 & j_3 \\ m_1 & m_2 & m_3 \end{pmatrix} = \begin{pmatrix} j_2 & j_3 & j_1 \\ m_2 & m_3 & m_1 \end{pmatrix} = \begin{pmatrix} j_3 & j_1 & j_2 \\ m_3 & m_1 & m_2 \end{pmatrix},$$

$$34.3.9 \quad \begin{pmatrix} j_1 & j_2 & j_3 \\ m_1 & m_2 & m_3 \end{pmatrix} = (-1)^{j_1+j_2+j_3} \begin{pmatrix} j_2 & j_1 & j_3 \\ m_2 & m_1 & m_3 \end{pmatrix}.$$

Next,

$$34.3.10 \quad \begin{pmatrix} j_1 & j_2 & j_3 \\ m_1 & m_2 & m_3 \end{pmatrix} = (-1)^{j_1+j_2+j_3} \begin{pmatrix} j_1 & j_2 & j_3 \\ -m_1 & -m_2 & -m_3 \end{pmatrix},$$

$$34.3.11 \quad \begin{pmatrix} j_1 & j_2 & j_3 \\ m_1 & m_2 & m_3 \end{pmatrix} = \begin{pmatrix} j_1 & \frac{1}{2}(j_2+j_3+m_1) & \frac{1}{2}(j_2+j_3-m_1) \\ j_2-j_3 & \frac{1}{2}(j_3-j_2+m_1)+m_2 & \frac{1}{2}(j_3-j_2+m_1)+m_3 \end{pmatrix},$$

$$34.3.12 \quad \begin{pmatrix} j_1 & j_2 & j_3 \\ m_1 & m_2 & m_3 \end{pmatrix} = \begin{pmatrix} \frac{1}{2}(j_1+j_2-m_3) & \frac{1}{2}(j_2+j_3-m_1) & \frac{1}{2}(j_1+j_3-m_2) \\ j_3-\frac{1}{2}(j_1+j_2+m_3) & j_1-\frac{1}{2}(j_2+j_3+m_1) & j_2-\frac{1}{2}(j_1+j_3+m_2) \end{pmatrix}.$$

Equations (34.3.11) and (34.3.12) are called *Regge symmetries*. Additional symmetries are obtained by applying (34.3.8)–(34.3.10) to (34.3.11) and (34.3.12). See Srinivasa Rao and Rajeswari (1993, pp. 44–47) and references given there.



### 34.3(iii) Recursion Relations

In the following three equations it is assumed that the triangle conditions are satisfied by each 3j symbol.

$$34.3.13 \quad ((j_1 + j_2 + j_3 + 1)(-j_1 + j_2 + j_3))^{\frac{1}{2}} \begin{pmatrix} j_1 & j_2 & j_3 \\ m_1 & m_2 & m_3 \end{pmatrix} = ((j_2 + m_2)(j_3 - m_3))^{\frac{1}{2}} \begin{pmatrix} j_1 & j_2 - \frac{1}{2} & j_3 - \frac{1}{2} \\ m_1 & m_2 - \frac{1}{2} & m_3 + \frac{1}{2} \end{pmatrix} \\ - ((j_2 - m_2)(j_3 + m_3))^{\frac{1}{2}} \begin{pmatrix} j_1 & j_2 - \frac{1}{2} & j_3 - \frac{1}{2} \\ m_1 & m_2 + \frac{1}{2} & m_3 - \frac{1}{2} \end{pmatrix},$$

$$34.3.14 \quad (j_1(j_1 + 1) - j_2(j_2 + 1) - j_3(j_3 + 1) - 2m_2m_3) \begin{pmatrix} j_1 & j_2 & j_3 \\ m_1 & m_2 & m_3 \end{pmatrix} \\ = ((j_2 - m_2)(j_2 + m_2 + 1)(j_3 - m_3 + 1)(j_3 + m_3))^{\frac{1}{2}} \begin{pmatrix} j_1 & j_2 & j_3 \\ m_1 & m_2 + 1 & m_3 - 1 \end{pmatrix} \\ + ((j_2 - m_2 + 1)(j_2 + m_2)(j_3 - m_3)(j_3 + m_3 + 1))^{\frac{1}{2}} \begin{pmatrix} j_1 & j_2 & j_3 \\ m_1 & m_2 - 1 & m_3 + 1 \end{pmatrix},$$

$$34.3.15 \quad (2j_1 + 1)((j_2(j_2 + 1) - j_3(j_3 + 1))m_1 - j_1(j_1 + 1)(m_3 - m_2)) \begin{pmatrix} j_1 & j_2 & j_3 \\ m_1 & m_2 & m_3 \end{pmatrix} \\ = (j_1 + 1)(j_1^2 - (j_2 - j_3)^2)^{\frac{1}{2}} ((j_2 + j_3 + 1)^2 - j_1^2)^{\frac{1}{2}} (j_1^2 - m_1^2)^{\frac{1}{2}} \begin{pmatrix} j_1 - 1 & j_2 & j_3 \\ m_1 & m_2 & m_3 \end{pmatrix} \\ + j_1((j_1 + 1)^2 - (j_2 - j_3)^2)^{\frac{1}{2}} ((j_2 + j_3 + 1)^2 - (j_1 + 1)^2)^{\frac{1}{2}} ((j_1 + 1)^2 - m_1^2)^{\frac{1}{2}} \begin{pmatrix} j_1 + 1 & j_2 & j_3 \\ m_1 & m_2 & m_3 \end{pmatrix}.$$

For these and other recursion relations see Varshalovich *et al.* (1988, §8.6). See also Micu (1968), Louck (1958), Schulten and Gordon (1975a), Srinivasa Rao and Rajeswari (1993, pp. 220–225), and Luscombe and Luban (1998).

### 34.3(iv) Orthogonality

$$34.3.16 \quad \sum_{m_1 m_2} (2j_3 + 1) \begin{pmatrix} j_1 & j_2 & j_3 \\ m_1 & m_2 & m_3 \end{pmatrix} \begin{pmatrix} j_1 & j_2 & j'_3 \\ m_1 & m_2 & m'_3 \end{pmatrix} = \delta_{j_3, j'_3} \delta_{m_3, m'_3},$$

$$34.3.17 \quad \sum_{j_3 m_3} (2j_3 + 1) \begin{pmatrix} j_1 & j_2 & j_3 \\ m_1 & m_2 & m_3 \end{pmatrix} \begin{pmatrix} j_1 & j_2 & j_3 \\ m'_1 & m'_2 & m_3 \end{pmatrix} = \delta_{m_1, m'_1} \delta_{m_2, m'_2},$$

$$34.3.18 \quad \sum_{m_1 m_2 m_3} \begin{pmatrix} j_1 & j_2 & j_3 \\ m_1 & m_2 & m_3 \end{pmatrix} \begin{pmatrix} j_1 & j_2 & j_3 \\ m_1 & m_2 & m_3 \end{pmatrix} = 1.$$

In the summations (34.3.16)–(34.3.18) the summation variables range over all values that satisfy the conditions given in (34.2.1)–(34.2.3). *Similar conventions apply to all subsequent summations in this chapter.*

### 34.3(v) Generating Functions

For generating functions for the 3j symbol see Biedenharn and van Dam (1965, p. 245, Eq. (3.42) and p. 247, Eq. (3.55)).

### 34.3(vi) Sums

For sums of products of 3j symbols, see Varshalovich *et al.* (1988, pp. 259–262).

### 34.3(vii) Relations to Legendre Polynomials and Spherical Harmonics

For the polynomials  $P_l$  see §18.3, and for the functions  $Y_{l,m}$  and  $Y_{l,m}^*$  see §14.30.

$$34.3.19 \quad P_{l_1}(\cos \theta) P_{l_2}(\cos \theta) = \sum_l (2l + 1) \begin{pmatrix} l_1 & l_2 & l \\ 0 & 0 & 0 \end{pmatrix}^2 P_l(\cos \theta),$$

$$34.3.20 \quad Y_{l_1, m_1}(\theta, \phi) Y_{l_2, m_2}(\theta, \phi) = \sum_{l, m} \left( \frac{(2l_1 + 1)(2l_2 + 1)(2l + 1)}{4\pi} \right)^{\frac{1}{2}} \begin{pmatrix} l_1 & l_2 & l \\ m_1 & m_2 & m \end{pmatrix} Y_{l, m}^*(\theta, \phi) \begin{pmatrix} l_1 & l_2 & l \\ 0 & 0 & 0 \end{pmatrix},$$

$$34.3.21 \quad \int_0^\pi P_{l_1}(\cos \theta) P_{l_2}(\cos \theta) P_{l_3}(\cos \theta) \sin \theta \, d\theta = 2 \begin{pmatrix} l_1 & l_2 & l_3 \\ 0 & 0 & 0 \end{pmatrix}^2,$$

$$34.3.22 \quad \int_0^{2\pi} \int_0^\pi Y_{l_1, m_1}(\theta, \phi) Y_{l_2, m_2}(\theta, \phi) Y_{l_3, m_3}(\theta, \phi) \sin \theta \, d\theta \, d\phi \\ = \left( \frac{(2l_1 + 1)(2l_2 + 1)(2l_3 + 1)}{4\pi} \right)^{\frac{1}{2}} \begin{pmatrix} l_1 & l_2 & l_3 \\ 0 & 0 & 0 \end{pmatrix} \begin{pmatrix} l_1 & l_2 & l_3 \\ m_1 & m_2 & m_3 \end{pmatrix}.$$

Equations (34.3.19)–(34.3.22) are particular cases of more general results that relate rotation matrices to  $3j$  symbols, for which see Edmonds (1974, Chapter 4). The left- and right-hand sides of (34.3.22) are known, respectively, as *Gaunt’s integral* and the *Gaunt coefficient* (Gaunt (1929)).

### 34.4 Definition: $6j$ Symbol

The  $6j$  symbol is defined by the following double sum of products of  $3j$  symbols:

$$34.4.1 \quad \left\{ \begin{matrix} j_1 & j_2 & j_3 \\ l_1 & l_2 & l_3 \end{matrix} \right\} = \sum_{m_r, m'_s} (-1)^{l_1 + m'_1 + l_2 + m'_2 + l_3 + m'_3} \\ \times \begin{pmatrix} j_1 & j_2 & j_3 \\ m_1 & m_2 & m_3 \end{pmatrix} \begin{pmatrix} j_1 & l_2 & l_3 \\ m_1 & m'_2 & -m'_3 \end{pmatrix} \begin{pmatrix} l_1 & j_2 & l_3 \\ -m'_1 & m_2 & m'_3 \end{pmatrix} \begin{pmatrix} l_1 & l_2 & j_3 \\ m'_1 & -m'_2 & m_3 \end{pmatrix},$$

where the summation is taken over all admissible values of the  $m$ ’s and  $m$ ’s for each of the four  $3j$  symbols; compare (34.2.2) and (34.2.3).

Except in degenerate cases the combination of the triangle inequalities for the four  $3j$  symbols in (34.4.1) is equivalent to the existence of a tetrahedron (possibly degenerate) with edges of lengths  $j_1, j_2, j_3, l_1, l_2, l_3$ ; see Figure 34.4.1.

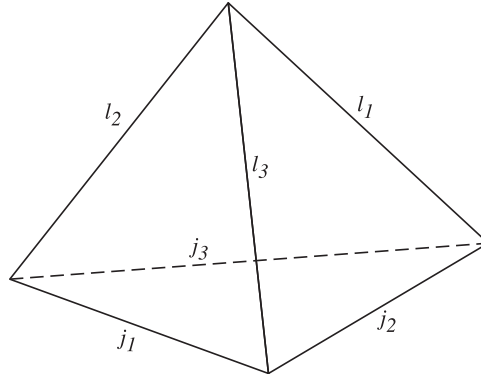


Figure 34.4.1: Tetrahedron corresponding to  $6j$  symbol.

The  $6j$  symbol can be expressed as the finite sum

$$34.4.2 \quad \left\{ \begin{matrix} j_1 & j_2 & j_3 \\ l_1 & l_2 & l_3 \end{matrix} \right\} = \sum_s \frac{(-1)^s (s+1)!}{(s-j_1-j_2-j_3)!(s-j_1-l_2-l_3)!(s-l_1-j_2-l_3)!(s-l_1-l_2-j_3)!} \\ \times \frac{1}{(j_1+j_2+l_1+l_2-s)!(j_2+j_3+l_2+l_3-s)!(j_3+j_1+l_3+l_1-s)!},$$

where the summation is over all nonnegative integers  $s$  such that the arguments in the factorials are nonnegative.

Equivalently,

$$34.4.3 \quad \left\{ \begin{matrix} j_1 & j_2 & j_3 \\ l_1 & l_2 & l_3 \end{matrix} \right\} = (-1)^{j_1 + j_3 + l_1 + l_3} \frac{\Delta(j_1 j_2 j_3) \Delta(j_2 l_1 l_3) (j_1 - j_2 + l_1 + l_2)! (-j_2 + j_3 + l_2 + l_3)! (j_1 + j_3 + l_1 + l_3 + 1)!}{\Delta(j_1 l_2 l_3) \Delta(j_3 l_1 l_2) (j_1 - j_2 + j_3)! (-j_2 + l_1 + l_3)! (j_1 + l_2 + l_3 + 1)! (j_3 + l_1 + l_2 + 1)!} \\ \times {}_4F_3 \left( \begin{matrix} -j_1 + j_2 - j_3, j_2 - l_1 - l_3, -j_1 - l_2 - l_3 - 1, -j_3 - l_1 - l_2 - 1 \\ -j_1 + j_2 - l_1 - l_2, j_2 - j_3 - l_2 - l_3, -j_1 - j_3 - l_1 - l_3 - 1 \end{matrix} ; 1 \right),$$

where  ${}_4F_3$  is defined as in §16.2.

For alternative expressions for the  $6j$  symbol, written either as a finite sum or as other terminating generalized hypergeometric series  ${}_4F_3$  of unit argument, see Varshalovich *et al.* (1988, §§9.2.1, 9.2.3).

### 34.5 Basic Properties: 6j Symbol

#### 34.5(i) Special Cases

In the following equations it is assumed that the triangle inequalities are satisfied and that  $J$  is again defined by (34.3.4).

If any lower argument in a  $6j$  symbol is 0,  $\frac{1}{2}$ , or 1, then the  $6j$  symbol has a simple algebraic form. Examples are provided by:

$$34.5.1 \quad \left\{ \begin{matrix} j_1 & j_2 & j_3 \\ 0 & j_3 & j_2 \end{matrix} \right\} = \frac{(-1)^J}{((2j_2 + 1)(2j_3 + 1))^{\frac{1}{2}}},$$

$$34.5.2 \quad \left\{ \begin{matrix} j_1 & j_2 & j_3 \\ \frac{1}{2} & j_3 - \frac{1}{2} & j_2 + \frac{1}{2} \end{matrix} \right\} = (-1)^J \left( \frac{(j_1 + j_3 - j_2)(j_1 + j_2 - j_3 + 1)}{(2j_2 + 1)(2j_2 + 2)2j_3(2j_3 + 1)} \right)^{\frac{1}{2}},$$

$$34.5.3 \quad \left\{ \begin{matrix} j_1 & j_2 & j_3 \\ \frac{1}{2} & j_3 - \frac{1}{2} & j_2 - \frac{1}{2} \end{matrix} \right\} = (-1)^J \left( \frac{(j_2 + j_3 - j_1)(j_1 + j_2 + j_3 + 1)}{2j_2(2j_2 + 1)2j_3(2j_3 + 1)} \right)^{\frac{1}{2}},$$

$$34.5.4 \quad \left\{ \begin{matrix} j_1 & j_2 & j_3 \\ 1 & j_3 - 1 & j_2 - 1 \end{matrix} \right\} = (-1)^J \left( \frac{J(J + 1)(J - 2j_1)(J - 2j_1 - 1)}{(2j_2 - 1)2j_2(2j_2 + 1)(2j_3 - 1)2j_3(2j_3 + 1)} \right)^{\frac{1}{2}},$$

$$34.5.5 \quad \left\{ \begin{matrix} j_1 & j_2 & j_3 \\ 1 & j_3 - 1 & j_2 \end{matrix} \right\} = (-1)^J \left( \frac{2(J + 1)(J - 2j_1)(J - 2j_2)(J - 2j_3 + 1)}{2j_2(2j_2 + 1)(2j_2 + 2)(2j_3 - 1)2j_3(2j_3 + 1)} \right)^{\frac{1}{2}},$$

$$34.5.6 \quad \left\{ \begin{matrix} j_1 & j_2 & j_3 \\ 1 & j_3 - 1 & j_2 + 1 \end{matrix} \right\} = (-1)^J \left( \frac{(J - 2j_2 - 1)(J - 2j_2)(J - 2j_3 + 1)(J - 2j_3 + 2)}{(2j_2 + 1)(2j_2 + 2)(2j_2 + 3)(2j_3 - 1)2j_3(2j_3 + 1)} \right)^{\frac{1}{2}},$$

$$34.5.7 \quad \left\{ \begin{matrix} j_1 & j_2 & j_3 \\ 1 & j_3 & j_2 \end{matrix} \right\} = (-1)^{J+1} \frac{2(j_2(j_2 + 1) + j_3(j_3 + 1) - j_1(j_1 + 1))}{(2j_2(2j_2 + 1)(2j_2 + 2)2j_3(2j_3 + 1)(2j_3 + 2))^{\frac{1}{2}}}.$$

#### 34.5(ii) Symmetry

The  $6j$  symbol is invariant under interchange of any two columns and also under interchange of the upper and lower arguments in each of any two columns, for example,

$$34.5.8 \quad \left\{ \begin{matrix} j_1 & j_2 & j_3 \\ l_1 & l_2 & l_3 \end{matrix} \right\} = \left\{ \begin{matrix} j_2 & j_1 & j_3 \\ l_2 & l_1 & l_3 \end{matrix} \right\} = \left\{ \begin{matrix} j_1 & l_2 & l_3 \\ l_1 & j_2 & j_3 \end{matrix} \right\}.$$

Next,

$$34.5.9 \quad \left\{ \begin{matrix} j_1 & j_2 & j_3 \\ l_1 & l_2 & l_3 \end{matrix} \right\} = \left\{ \begin{matrix} j_1 & \frac{1}{2}(j_2 + l_2 + j_3 - l_3) & \frac{1}{2}(j_2 - l_2 + j_3 + l_3) \\ l_1 & \frac{1}{2}(j_2 + l_2 - j_3 + l_3) & \frac{1}{2}(-j_2 + l_2 + j_3 + l_3) \end{matrix} \right\},$$

$$34.5.10 \quad \left\{ \begin{matrix} j_1 & j_2 & j_3 \\ l_1 & l_2 & l_3 \end{matrix} \right\} = \left\{ \begin{matrix} \frac{1}{2}(j_2 + l_2 + j_3 - l_3) & \frac{1}{2}(j_1 - l_1 + j_3 + l_3) & \frac{1}{2}(j_1 + l_1 + j_2 - l_2) \\ \frac{1}{2}(j_2 + l_2 - j_3 + l_3) & \frac{1}{2}(-j_1 + l_1 + j_3 + l_3) & \frac{1}{2}(j_1 + l_1 - j_2 + l_2) \end{matrix} \right\}.$$

Equations (34.5.9) and (34.5.10) are called *Regge symmetries*. Additional symmetries are obtained by applying (34.5.8) to (34.5.9) and (34.5.10). See Srinivasa Rao and Rajeswari (1993, pp. 102–103) and references given there.

#### 34.5(iii) Recursion Relations

In the following equation it is assumed that the triangle conditions are satisfied.

$$34.5.11 \quad (2j_1 + 1)((J_3 + J_2 - J_1)(L_3 + L_2 - J_1) - 2(J_3L_3 + J_2L_2 - J_1L_1)) \left\{ \begin{matrix} j_1 & j_2 & j_3 \\ l_1 & l_2 & l_3 \end{matrix} \right\} \\ = j_1 E(j_1 + 1) \left\{ \begin{matrix} j_1 + 1 & j_2 & j_3 \\ l_1 & l_2 & l_3 \end{matrix} \right\} + (j_1 + 1) E(j_1) \left\{ \begin{matrix} j_1 - 1 & j_2 & j_3 \\ l_1 & l_2 & l_3 \end{matrix} \right\},$$

where

$$34.5.12 \quad J_r = j_r(j_r + 1), \quad L_r = l_r(l_r + 1),$$

$$34.5.13 \quad E(j) = ((j^2 - (j_2 - j_3)^2)((j_2 + j_3 + 1)^2 - j^2)(j^2 - (l_2 - l_3)^2)((l_2 + l_3 + 1)^2 - j^2))^{\frac{1}{2}}.$$

For further recursion relations see Varshalovich *et al.* (1988, §9.6) and Edmonds (1974, pp. 98–99).

**34.5(iv) Orthogonality**

$$34.5.14 \quad \sum_{j_3} (2j_3 + 1)(2l_3 + 1) \begin{Bmatrix} j_1 & j_2 & j_3 \\ l_1 & l_2 & l_3 \end{Bmatrix} \begin{Bmatrix} j_1 & j_2 & j_3 \\ l_1 & l_2 & l'_3 \end{Bmatrix} = \delta_{l_3, l'_3}.$$

**34.5(v) Generating Functions**

For generating functions for the  $6j$  symbol see Biedenharn and van Dam (1965, p. 255, eq. (4.18)).

**34.5(vi) Sums**

$$34.5.15 \quad \sum_j (-1)^{j+j'+j''} (2j+1) \begin{Bmatrix} j_1 & j_2 & j \\ j_3 & j_4 & j' \end{Bmatrix} \begin{Bmatrix} j_1 & j_2 & j \\ j_4 & j_3 & j'' \end{Bmatrix} = \begin{Bmatrix} j_1 & j_4 & j' \\ j_2 & j_3 & j'' \end{Bmatrix},$$

$$34.5.16 \quad (-1)^{j_1+j_2+j_3+j'_1+j'_2+l_1+l_2} \begin{Bmatrix} j_1 & j_2 & j_3 \\ l_1 & l_2 & l_3 \end{Bmatrix} \begin{Bmatrix} j'_1 & j'_2 & j_3 \\ l_1 & l_2 & l'_3 \end{Bmatrix} \\ = \sum_j (-1)^{l_3+l'_3+j} (2j+1) \begin{Bmatrix} j_1 & j'_1 & j \\ j'_2 & j_2 & j_3 \end{Bmatrix} \begin{Bmatrix} l_3 & l'_3 & j \\ j'_1 & j_1 & l_2 \end{Bmatrix} \begin{Bmatrix} l_3 & l'_3 & j \\ j'_2 & j_2 & l_1 \end{Bmatrix}.$$

Equations (34.5.15) and (34.5.16) are the *sum rules*. They constitute addition theorems for the  $6j$  symbol.

$$34.5.17 \quad \sum_j (2j+1) \begin{Bmatrix} j_1 & j_2 & j \\ j_1 & j_2 & j' \end{Bmatrix} = (-1)^{2(j_1+j_2)},$$

$$34.5.18 \quad \sum_j (-1)^{j_1+j_2+j} (2j+1) \begin{Bmatrix} j_1 & j_2 & j \\ j_2 & j_1 & j' \end{Bmatrix} = \sqrt{(2j_1+1)(2j_2+1)} \delta_{j',0},$$

$$34.5.19 \quad \sum_l \begin{Bmatrix} j_1 & j_2 & l \\ j_2 & j_1 & j \end{Bmatrix} = 0, \quad 2\mu - j \text{ odd, } \mu = \min(j_1, j_2),$$

$$34.5.20 \quad \sum_l (-1)^{l+j} \begin{Bmatrix} j_1 & j_2 & l \\ j_1 & j_2 & j \end{Bmatrix} = \frac{(-1)^{2\mu}}{2j+1}, \quad \mu = \min(j_1, j_2),$$

$$34.5.21 \quad \sum_l (-1)^{l+j+j_1+j_2} \begin{Bmatrix} j_1 & j_2 & l \\ j_2 & j_1 & j \end{Bmatrix} = \frac{1}{2j+1} \left( \frac{(2j_1-j)!(2j_2+j+1)!}{(2j_2-j)!(2j_1+j+1)!} \right)^{\frac{1}{2}}, \quad j_2 \leq j_1,$$

$$34.5.22 \quad \sum_l (-1)^{l+j+j_1+j_2} \frac{1}{l(l+1)} \begin{Bmatrix} j_1 & j_2 & l \\ j_2 & j_1 & j \end{Bmatrix} = \frac{1}{j_1(j_1+1) - j_2(j_2+1)} \left( \frac{(2j_1-j)!(2j_2+j+1)!}{(2j_2-j)!(2j_1+j+1)!} \right)^{\frac{1}{2}}, \quad j_2 < j_1.$$

$$34.5.23 \quad \begin{pmatrix} j_1 & j_2 & j_3 \\ m_1 & m_2 & m_3 \end{pmatrix} \begin{Bmatrix} j_1 & j_2 & j_3 \\ l_1 & l_2 & l_3 \end{Bmatrix} \\ = \sum_{m'_1 m'_2 m'_3} (-1)^{l_1+l_2+l_3+m'_1+m'_2+m'_3} \begin{pmatrix} j_1 & l_2 & l_3 \\ m_1 & m'_2 & -m'_3 \end{pmatrix} \begin{pmatrix} l_1 & j_2 & l_3 \\ -m'_1 & m_2 & m'_3 \end{pmatrix} \begin{pmatrix} l_1 & l_2 & j_3 \\ m'_1 & -m'_2 & m_3 \end{pmatrix}.$$

Equation (34.5.23) can be regarded as an alternative definition of the  $6j$  symbol.

For other sums see Ginocchio (1991).

**34.6 Definition:  $9j$  Symbol**

The  $9j$  symbol may be defined either in terms of  $3j$  symbols or equivalently in terms of  $6j$  symbols:

$$34.6.1 \quad \begin{Bmatrix} j_{11} & j_{12} & j_{13} \\ j_{21} & j_{22} & j_{23} \\ j_{31} & j_{32} & j_{33} \end{Bmatrix} = \sum_{\text{all } m_{rs}} \begin{pmatrix} j_{11} & j_{12} & j_{13} \\ m_{11} & m_{12} & m_{13} \end{pmatrix} \begin{pmatrix} j_{21} & j_{22} & j_{23} \\ m_{21} & m_{22} & m_{23} \end{pmatrix} \begin{pmatrix} j_{31} & j_{32} & j_{33} \\ m_{31} & m_{32} & m_{33} \end{pmatrix} \\ \times \begin{pmatrix} j_{11} & j_{21} & j_{31} \\ m_{11} & m_{21} & m_{31} \end{pmatrix} \begin{pmatrix} j_{12} & j_{22} & j_{32} \\ m_{12} & m_{22} & m_{32} \end{pmatrix} \begin{pmatrix} j_{13} & j_{23} & j_{33} \\ m_{13} & m_{23} & m_{33} \end{pmatrix},$$

$$34.6.2 \quad \begin{Bmatrix} j_{11} & j_{12} & j_{13} \\ j_{21} & j_{22} & j_{23} \\ j_{31} & j_{32} & j_{33} \end{Bmatrix} = \sum_j (-1)^{2j} (2j+1) \begin{Bmatrix} j_{11} & j_{21} & j_{31} \\ j_{32} & j_{33} & j \end{Bmatrix} \begin{Bmatrix} j_{12} & j_{22} & j_{32} \\ j_{21} & j & j_{23} \end{Bmatrix} \begin{Bmatrix} j_{13} & j_{23} & j_{33} \\ j & j_{11} & j_{12} \end{Bmatrix}.$$

The 9j symbol may also be written as a finite triple sum equivalent to a terminating generalized hypergeometric series of three variables with unit arguments. See Srinivasa Rao and Rajeswari (1993, pp. 7 and 125–132) and Rosengren (1999).

### 34.7 Basic Properties: 9j Symbol

#### 34.7(i) Special Case

$$34.7.1 \quad \begin{Bmatrix} j_{11} & j_{12} & j_{13} \\ j_{21} & j_{22} & j_{13} \\ j_{31} & j_{31} & 0 \end{Bmatrix} = \frac{(-1)^{j_{12}+j_{21}+j_{13}+j_{31}}}{((2j_{13} + 1)(2j_{31} + 1))^{\frac{1}{2}}} \begin{Bmatrix} j_{11} & j_{12} & j_{13} \\ j_{22} & j_{21} & j_{31} \end{Bmatrix}.$$

#### 34.7(ii) Symmetry

The 9j symbol has symmetry properties with respect to permutation of columns, permutation of rows, and transposition of rows and columns; these relate 72 independent 9j symbols. Even (cyclic) permutations of either columns or rows, as well as transpositions, leave the 9j symbol unchanged. Odd permutations of columns or rows introduce a phase factor  $(-1)^R$ , where  $R$  is the sum of all arguments of the 9j symbol.

For further symmetry properties of the 9j symbol see Edmonds (1974, pp. 102–103) and Varshalovich *et al.* (1988, §10.4.1).

#### 34.7(iii) Recursion Relations

For recursion relations see Varshalovich *et al.* (1988, §10.5).

#### 34.7(iv) Orthogonality

$$34.7.2 \quad \sum_{j_{12} j_{34}} (2j_{12} + 1)(2j_{34} + 1)(2j_{13} + 1)(2j_{24} + 1) \begin{Bmatrix} j_1 & j_2 & j_{12} \\ j_3 & j_4 & j_{34} \\ j_{13} & j_{24} & j \end{Bmatrix} \begin{Bmatrix} j_1 & j_2 & j_{12} \\ j_3 & j_4 & j_{34} \\ j'_{13} & j'_{24} & j \end{Bmatrix} = \delta_{j_{13}, j'_{13}} \delta_{j_{24}, j'_{24}}.$$

#### 34.7(v) Generating Functions

For generating functions for the 9j symbol see Biedenharn and van Dam (1965, p. 258, eq. (4.37)).

#### 34.7(vi) Sums

$$34.7.3 \quad \sum_{j_{13} j_{24}} (-1)^{2j_2+j_{24}+j_{23}-j_{34}} (2j_{13} + 1)(2j_{24} + 1) \begin{Bmatrix} j_1 & j_2 & j_{12} \\ j_3 & j_4 & j_{34} \\ j_{13} & j_{24} & j \end{Bmatrix} \begin{Bmatrix} j_1 & j_3 & j_{13} \\ j_4 & j_2 & j_{24} \\ j_{14} & j_{23} & j \end{Bmatrix} = \begin{Bmatrix} j_1 & j_2 & j_{12} \\ j_4 & j_3 & j_{34} \\ j_{14} & j_{23} & j \end{Bmatrix}.$$

This equation is the *sum rule*. It constitutes an addition theorem for the 9j symbol.

$$34.7.4 \quad \begin{pmatrix} j_{13} & j_{23} & j_{33} \\ m_{13} & m_{23} & m_{33} \end{pmatrix} \begin{Bmatrix} j_{11} & j_{12} & j_{13} \\ j_{21} & j_{22} & j_{23} \\ j_{31} & j_{32} & j_{33} \end{Bmatrix} = \sum_{m_{r1}, m_{r2}, r=1,2,3} \begin{pmatrix} j_{11} & j_{12} & j_{13} \\ m_{11} & m_{12} & m_{13} \end{pmatrix} \begin{pmatrix} j_{21} & j_{22} & j_{23} \\ m_{21} & m_{22} & m_{23} \end{pmatrix} \\ \times \begin{pmatrix} j_{31} & j_{32} & j_{33} \\ m_{13} & m_{23} & m_{33} \end{pmatrix} \begin{pmatrix} j_{11} & j_{21} & j_{31} \\ m_{11} & m_{21} & m_{31} \end{pmatrix} \begin{pmatrix} j_{12} & j_{22} & j_{32} \\ m_{12} & m_{22} & m_{32} \end{pmatrix}.$$

$$34.7.5 \quad \sum_{j'} (2j' + 1) \begin{Bmatrix} j_{11} & j_{12} & j' \\ j_{21} & j_{22} & j_{23} \\ j_{31} & j_{32} & j_{33} \end{Bmatrix} \begin{Bmatrix} j_{11} & j_{12} & j' \\ j_{23} & j_{33} & j \end{Bmatrix} = (-1)^{2j} \begin{Bmatrix} j_{21} & j_{22} & j_{23} \\ j_{12} & j & j_{32} \end{Bmatrix} \begin{Bmatrix} j_{31} & j_{32} & j_{33} \\ j & j_{11} & j_{21} \end{Bmatrix}.$$

### 34.8 Approximations for Large Parameters

For large values of the parameters in the 3j, 6j, and 9j symbols, different asymptotic forms are obtained depending on which parameters are large. For example,

$$34.8.1 \quad \begin{Bmatrix} j_1 & j_2 & j_3 \\ j_2 & j_1 & l_3 \end{Bmatrix} = (-1)^{j_1+j_2+j_3+l_3} \left( \frac{4}{\pi(2j_1 + 1)(2j_2 + 1)(2l_3 + 1) \sin \theta} \right)^{\frac{1}{2}} \left( \cos \left( (l_3 + \frac{1}{2})\theta - \frac{1}{4}\pi \right) + o(1) \right), \\ j_1, j_2, j_3 \gg l_3 \gg 1,$$

where

$$34.8.2 \quad \cos \theta = \frac{j_1(j_1 + 1) + j_2(j_2 + 1) - j_3(j_3 + 1)}{2\sqrt{j_1(j_1 + 1)j_2(j_2 + 1)}},$$

and the symbol  $o(1)$  denotes a quantity that tends to zero as the parameters tend to infinity, as in §2.1(i).

Semiclassical (WKBJ) approximations in terms of trigonometric or exponential functions are given in Varshalovich *et al.* (1988, §§8.9, 9.9, 10.7). Uniform approximations in terms of Airy functions for the  $3j$  and  $6j$  symbols are given in Schulten and Gordon (1975b). For approximations for the  $3j$ ,  $6j$ , and  $9j$  symbols with error bounds see Flude (1998), Chen *et al.* (1999), and Watson (1999): these references also cite earlier work.

### 34.9 Graphical Method

The graphical method establishes a one-to-one correspondence between an analytic expression and a diagram by assigning a graphical symbol to each function and operation of the analytic expression. Thus, any analytic expression in the theory, for example equations (34.3.16), (34.4.1), (34.5.15), and (34.7.3), may be represented by a diagram; conversely, any diagram represents an analytic equation. For an account of this method see Brink and Satchler (1993, Chapter VII). For specific examples of the graphical method of representing sums involving the  $3j$ ,  $6j$ , and  $9j$  symbols, see Varshalovich *et al.* (1988, Chapters 11, 12) and Lehman and O'Connell (1973, §3.3).

#### 34.10 Zeros

In a  $3j$  symbol, if the three angular momenta  $j_1, j_2, j_3$  do not satisfy the triangle conditions (34.2.1), or if the projective quantum numbers do not satisfy (34.2.3), then the  $3j$  symbol is zero. Similarly the  $6j$  symbol (34.4.1) vanishes when the triangle conditions are not satisfied by any of the four  $3j$  symbols in the summation. Such zeros are called *trivial zeros*. However, the  $3j$  and  $6j$  symbols may vanish for certain combinations of the angular momenta and projective quantum numbers even when the triangle conditions are fulfilled. Such zeros are called *nontrivial zeros*.

For further information, including examples of nontrivial zeros and extensions to  $9j$  symbols, see Srinivasa Rao and Rajeswari (1993, pp. 133–215, 294–295, 299–310).

#### 34.11 Higher-Order $3nj$ Symbols

For information on  $12j, 15j, \dots$ , symbols, see Varshalovich *et al.* (1988, §10.12) and Yutsis *et al.* (1962, pp. 62–65 and 122–153).

## Applications

### 34.12 Physical Applications

The angular momentum coupling coefficients ( $3j$ ,  $6j$ , and  $9j$  symbols) are essential in the fields of nuclear, atomic, and molecular physics. For applications in nuclear structure, see de Shalit and Talmi (1963); in atomic spectroscopy, see Biedenharn and van Dam (1965, pp. 134–200), Judd (1998), Sobelman (1992, Chapter 4), Shore and Menzel (1968, pp. 268–303), and Wigner (1959); in molecular spectroscopy and chemical reactions, see Burshtein and Temkin (1994, Chapter 5), and Judd (1975).  $3j$ ,  $6j$ , and  $9j$  symbols are also found in multipole expansions of solutions of the Laplace and Helmholtz equations; see Carlson and Rushbrooke (1950) and Judd (1976).

## Computation

### 34.13 Methods of Computation

Methods of computation for  $3j$  and  $6j$  symbols include recursion relations, see Schulten and Gordon (1975a), Luscombe and Luban (1998), and Edmonds (1974, pp. 42–45, 48–51, 97–99); summation of single-sum expressions for these symbols, see Varshalovich *et al.* (1988, §§8.2.6, 9.2.1) and Fang and Shriner (1992); evaluation of the generalized hypergeometric functions of unit argument that represent these symbols, see Srinivasa Rao and Venkatesh (1978) and Srinivasa Rao (1981).

For  $9j$  symbols, methods include evaluation of the single-sum series (34.6.2), see Fang and Shriner (1992); evaluation of triple-sum series, see Varshalovich *et al.* (1988, §10.2.1) and Srinivasa Rao *et al.* (1989). A review of methods of computation is given in Srinivasa Rao and Rajeswari (1993, Chapter VII, pp. 235–265). See also Roothaan and Lai (1997) and references given there.

#### 34.14 Tables

Tables of exact values of the squares of the  $3j$  and  $6j$  symbols in which all parameters are  $\leq 8$  are given in Rotenberg *et al.* (1959), together with a bibliography of earlier tables of  $3j$ ,  $6j$ , and  $9j$  symbols on pp. 33–36.

Tables of  $3j$  and  $6j$  symbols in which all parameters are  $\leq 17/2$  are given in Appel (1968) to 6D. Some selected  $9j$  symbols are also given. Other tabulations for  $3j$  symbols are listed on pp. 11–12; for  $6j$  symbols on pp. 16–17; for  $9j$  symbols on p. 21.

Biedenharn and Louck (1981) give tables of algebraic expressions for Clebsch–Gordan coefficients and  $6j$  symbols, together with a bibliography of tables produced prior to 1975. In Varshalovich *et al.* (1988) algebraic expressions for the Clebsch–Gordan coefficients with all parameters  $\leq 5$  and numerical values for all parameters  $\leq 3$  are given on pp. 270–289; similar tables for the  $6j$  symbols are given on pp. 310–332, and for the  $9j$  symbols on pp. 359, 360, 372–411. Earlier tables are listed on p. 513.

### 34.15 Software

See <http://dlmf.nist.gov/34.15>.

## References

### General References

The main references used in writing this chapter are Edmonds (1974), Varshalovich *et al.* (1988), and de Shalit and Talmi (1963).

### Sources

The following list gives the references or other indications of proofs that were used in constructing the various sections of this chapter. These sources supplement the references that are quoted in the text.

§34.2 Edmonds (1974, pp. 44–45).

§34.3 Edmonds (1974, pp. 46–50, 63), de Shalit and Talmi (1963, pp. 515, 519), Thompson (1994, p. 288).

§34.4 Varshalovich *et al.* (1988, §9.2.4), de Shalit and Talmi (1963, p. 131).

§34.5 Edmonds (1974, pp. 94–98, 130–132), de Shalit and Talmi (1963, pp. 517–518, 520), Varshalovich *et al.* (1988, §9.8), Dunlap and Judd (1975).

§34.6 Edmonds (1974, p. 101), de Shalit and Talmi (1963, p. 516).

§34.7 Edmonds (1974, pp. 103–106), de Shalit and Talmi (1963, pp. 127, 517–518).

§34.8 Watson (1999), Chen *et al.* (1999).

## Chapter 35

# Functions of Matrix Argument

D. St. P. Richards<sup>1</sup>

<b>Notation</b>	<b>768</b>	35.8 Generalized Hypergeometric Functions of Matrix Argument . . . . .	772
35.1 Special Notation . . . . .	768	<b>Applications</b>	<b>773</b>
<b>Properties</b>	<b>768</b>	35.9 Applications . . . . .	773
35.2 Laplace Transform . . . . .	768	<b>Computation</b>	<b>773</b>
35.3 Multivariate Gamma and Beta Functions	768	35.10 Methods of Computation . . . . .	773
35.4 Partitions and Zonal Polynomials . . . . .	769	35.11 Tables . . . . .	773
35.5 Bessel Functions of Matrix Argument . .	769	35.12 Software . . . . .	773
35.6 Confluent Hypergeometric Functions of Matrix Argument . . . . .	770	<b>References</b>	<b>773</b>
35.7 Gaussian Hypergeometric Function of Matrix Argument . . . . .	771		

<sup>1</sup>Department of Statistics, Pennsylvania State University.

**Acknowledgments:** With deep gratitude to Ingram Olkin for advice and support regarding the final version of this material.  
**Copyright** © 2009 National Institute of Standards and Technology. All rights reserved.



## Notation

### 35.1 Special Notation

(For other notation see pp. xiv and 873.)

All matrices are of order  $m \times m$ , unless specified otherwise. All fractional or complex powers are principal values.

$a, b$	complex variables.
$j, k$	nonnegative integers.
$m$	positive integer.
$[a]_{\kappa}$	partitioned shifted factorial (§35.4(i)).
$\mathbf{0}$	zero matrix.
$\mathbf{I}$	identity matrix.
$\mathcal{S}$	space of all real symmetric matrices.
$\mathbf{S}, \mathbf{T}, \mathbf{X}$	real symmetric matrices.
$\text{tr } \mathbf{X}$	trace of $\mathbf{X}$ .
$\text{etr}(\mathbf{X})$	$\exp(\text{tr } \mathbf{X})$ .
$ \mathbf{X} $	determinant of $\mathbf{X}$ (except when $m = 1$ where it means either determinant or absolute value, depending on the context).
$ (\mathbf{X})_j $	$j$ th principal minor of $\mathbf{X}$ .
$x_{j,k}$	$(j, k)$ th element of $\mathbf{X}$ .
$d\mathbf{X}$	$\prod_{1 \leq j < k \leq m} dx_{j,k}$ .
$\Omega$	space of positive-definite real symmetric matrices.
$t_1, \dots, t_m$	eigenvalues of $\mathbf{T}$ .
$\ \mathbf{T}\ $	spectral norm of $\mathbf{T}$ .
$\mathbf{X} > \mathbf{T}$	$\mathbf{X} - \mathbf{T}$ is positive definite.
$\mathbf{Z}$	complex symmetric matrix.
$\mathbf{U}, \mathbf{V}$	real and complex parts of $\mathbf{Z}$ .
$f(\mathbf{X})$	complex-valued function with $\mathbf{X} \in \Omega$ .
$\mathbf{O}(m)$	space of orthogonal matrices.
$\mathbf{H}$	orthogonal matrix.
$d\mathbf{H}$	normalized Haar measure on $\mathbf{O}(m)$ .
$Z_{\kappa}(\mathbf{T})$	zonal polynomials.

The main functions treated in this chapter are the multivariate gamma and beta functions, respectively  $\Gamma_m(a)$  and  $B_m(a, b)$ , and the special functions of matrix argument: Bessel (of the first kind)  $A_{\nu}(\mathbf{T})$  and (of the second kind)  $B_{\nu}(\mathbf{T})$ ; confluent hypergeometric (of the first kind)  ${}_1F_1(a; b; \mathbf{T})$  or  ${}_1F_1\left(\begin{smallmatrix} a \\ b \end{smallmatrix}; \mathbf{T}\right)$  and (of the second kind)  $\Psi(a; b; \mathbf{T})$ ; Gaussian hypergeometric  ${}_2F_1(a_1, a_2; b; \mathbf{T})$  or  ${}_2F_1\left(\begin{smallmatrix} a_1, a_2 \\ b \end{smallmatrix}; \mathbf{T}\right)$ ; generalized hypergeometric  ${}_pF_q(a_1, \dots, a_p; b_1, \dots, b_q; \mathbf{T})$  or  ${}_pF_q\left(\begin{smallmatrix} a_1, \dots, a_p \\ b_1, \dots, b_q \end{smallmatrix}; \mathbf{T}\right)$ .

An alternative notation for the multivariate gamma function is  $\Pi_m(a) = \Gamma_m(a + \frac{1}{2}(m+1))$  (Herz (1955, p. 480)). Related notations for the Bessel functions are  $\mathcal{J}_{\nu+\frac{1}{2}(m+1)}(\mathbf{T}) = A_{\nu}(\mathbf{T})/A_{\nu}(\mathbf{0})$  (Faraut and

Korányi (1994, pp. 320–329)),  $K_m(0, \dots, 0, \nu; \mathbf{S}, \mathbf{T}) = |\mathbf{T}|^{\nu} B_{\nu}(\mathbf{S}\mathbf{T})$  (Terras (1988, pp. 49–64)), and  $\mathcal{K}_{\nu}(\mathbf{T}) = |\mathbf{T}|^{\nu} B_{\nu}(\mathbf{S}\mathbf{T})$  (Faraut and Korányi (1994, pp. 357–358)).

## Properties

### 35.2 Laplace Transform

#### Definition

For any complex symmetric matrix  $\mathbf{Z}$ ,

$$35.2.1 \quad g(\mathbf{Z}) = \int_{\Omega} \text{etr}(-\mathbf{Z}\mathbf{X}) f(\mathbf{X}) d\mathbf{X},$$

where the integration variable  $\mathbf{X}$  ranges over the space  $\Omega$ .

Suppose there exists a constant  $\mathbf{X}_0 \in \Omega$  such that  $|f(\mathbf{X})| < \text{etr}(-\mathbf{X}_0\mathbf{X})$  for all  $\mathbf{X} \in \Omega$ . Then (35.2.1) converges absolutely on the region  $\Re(\mathbf{Z}) > \mathbf{X}_0$ , and  $g(\mathbf{Z})$  is a complex analytic function of all elements  $z_{j,k}$  of  $\mathbf{Z}$ .

#### Inversion Formula

Assume that  $\int_{\mathcal{S}} |g(\mathbf{Z})| d\mathbf{V}$  converges, and also that  $\lim_{\mathbf{U} \rightarrow \infty} \int_{\mathcal{S}} |g(\mathbf{Z})| d\mathbf{V} = 0$ . Then

$$35.2.2 \quad f(\mathbf{X}) = \frac{1}{(2\pi i)^{m(m+1)/2}} \int \text{etr}(\mathbf{Z}\mathbf{X}) g(\mathbf{Z}) d\mathbf{Z},$$

where the integral is taken over all  $\mathbf{Z} = \mathbf{U} + i\mathbf{V}$  such that  $\mathbf{U} > \mathbf{X}_0$  and  $\mathbf{V}$  ranges over  $\mathcal{S}$ .

#### Convolution Theorem

If  $g_j$  is the Laplace transform of  $f_j$ ,  $j = 1, 2$ , then  $g_1 g_2$  is the Laplace transform of the convolution  $f_1 * f_2$ , where

$$35.2.3 \quad f_1 * f_2(\mathbf{T}) = \int_{\mathbf{0} < \mathbf{X} < \mathbf{T}} f_1(\mathbf{T} - \mathbf{X}) f_2(\mathbf{X}) d\mathbf{X}.$$

### 35.3 Multivariate Gamma and Beta Functions

#### 35.3(i) Definitions

$$35.3.1 \quad \Gamma_m(a) = \int_{\Omega} \text{etr}(-\mathbf{X}) |\mathbf{X}|^{a-\frac{1}{2}(m+1)} d\mathbf{X},$$

$$\Re(a) > \frac{1}{2}(m-1).$$

$$35.3.2 \quad \Gamma_m(s_1, \dots, s_m)$$

$$= \int_{\Omega} \text{etr}(-\mathbf{X}) |\mathbf{X}|^{s_m-\frac{1}{2}(m+1)} \prod_{j=1}^{m-1} |(\mathbf{X})_j|^{s_j-s_{j+1}} d\mathbf{X},$$

$$s_j \in \mathbb{C}, \Re(s_j) > \frac{1}{2}(j-1), j = 1, \dots, m.$$

$$35.3.3 \quad B_m(a, b) = \int_{\mathbf{0} < \mathbf{X} < \mathbf{I}} |\mathbf{X}|^{a-\frac{1}{2}(m+1)} |\mathbf{I} - \mathbf{X}|^{b-\frac{1}{2}(m+1)} d\mathbf{X},$$

$$\Re(a), \Re(b) > \frac{1}{2}(m-1).$$

**35.3(ii) Properties**

35.3.4  $\Gamma_m(a) = \pi^{m(m-1)/4} \prod_{j=1}^m \Gamma(a - \frac{1}{2}(j-1)).$

35.3.5

$$\Gamma_m(s_1, \dots, s_m) = \pi^{m(m-1)/4} \prod_{j=1}^m \Gamma(s_j - \frac{1}{2}(j-1)).$$

35.3.6  $\Gamma_m(a, \dots, a) = \Gamma_m(a).$

35.3.7  $B_m(a, b) = \frac{\Gamma_m(a) \Gamma_m(b)}{\Gamma_m(a+b)}.$

35.3.8  $B_m(a, b) = \int_{\Omega} |\mathbf{X}|^{a-\frac{1}{2}(m+1)} |\mathbf{I} + \mathbf{X}|^{-(a+b)} d\mathbf{X},$   
 $\Re(a), \Re(b) > \frac{1}{2}(m-1).$

**35.4 Partitions and Zonal Polynomials**

**35.4(i) Definitions**

A *partition*  $\kappa = (k_1, \dots, k_m)$  is a vector of nonnegative integers, listed in nonincreasing order. Also,  $|\kappa|$  denotes  $k_1 + \dots + k_m$ , the *weight* of  $\kappa$ ;  $\ell(\kappa)$  denotes the number of nonzero  $k_j$ ;  $a + \kappa$  denotes the vector  $(a + k_1, \dots, a + k_m)$ .

The *partitional shifted factorial* is given by

35.4.1  $[a]_{\kappa} = \frac{\Gamma_m(a + \kappa)}{\Gamma_m(a)} = \prod_{j=1}^m (a - \frac{1}{2}(j-1))_{k_j},$

where  $(a)_k = a(a+1) \dots (a+k-1)$ .

For any partition  $\kappa$ , the *zonal polynomial*  $Z_{\kappa} : \mathcal{S} \rightarrow \mathbb{R}$  is defined by the properties

35.4.2

$$Z_{\kappa}(\mathbf{I}) = |\kappa|! 2^{2|\kappa|} [m/2]_{\kappa} \frac{\prod_{1 \leq j < l \leq \ell(\kappa)} (2k_j - 2k_l - j + l)}{\prod_{j=1}^{\ell(\kappa)} (2k_j + \ell(\kappa) - j)!}$$

and

35.4.3

$$Z_{\kappa}(\mathbf{T}) = Z_{\kappa}(\mathbf{I}) |\mathbf{T}|^{k_m} \int_{\mathbf{O}(m)} \prod_{j=1}^{m-1} |(\mathbf{HTH}^{-1})_j|^{k_j - k_{j+1}} d\mathbf{H},$$

$\mathbf{T} \in \mathcal{S}.$

See Muirhead (1982, pp. 68–72) for the definition and properties of the *Haar measure*  $d\mathbf{H}$ . See Hua (1963, p. 30), Constantine (1963), James (1964), and Macdonald (1995, pp. 425–431) for further information on (35.4.2) and (35.4.3). Alternative notations for the zonal polynomials are  $C_{\kappa}(\mathbf{T})$  (Muirhead (1982, pp. 227–239)),  $\mathcal{Y}_{\kappa}(\mathbf{T})$  (Takemura (1984, p. 22)), and  $\Phi_{\kappa}(\mathbf{T})$  (Farraut and Korányi (1994, pp. 228–236)).

**35.4(ii) Properties**

**Normalization**

35.4.4  $Z_{\kappa}(\mathbf{0}) = \begin{cases} 1, & \kappa = (0, \dots, 0), \\ 0, & \kappa \neq (0, \dots, 0). \end{cases}$

**Orthogonal Invariance**

35.4.5  $Z_{\kappa}(\mathbf{HTH}^{-1}) = Z_{\kappa}(\mathbf{T}), \quad \mathbf{H} \in \mathbf{O}(m).$

Therefore  $Z_{\kappa}(\mathbf{T})$  is a symmetric polynomial in the eigenvalues of  $\mathbf{T}$ .

**Summation**

For  $k = 0, 1, 2, \dots,$

35.4.6  $\sum_{|\kappa|=k} Z_{\kappa}(\mathbf{T}) = (\text{tr } \mathbf{T})^k.$

**Mean-Value**

35.4.7  $\int_{\mathbf{O}(m)} Z_{\kappa}(\mathbf{SHTH}^{-1}) d\mathbf{H} = \frac{Z_{\kappa}(\mathbf{S}) Z_{\kappa}(\mathbf{T})}{Z_{\kappa}(\mathbf{I})}.$

**Laplace and Beta Integrals**

For  $\mathbf{T} \in \Omega$  and  $\Re(a), \Re(b) > \frac{1}{2}(m-1),$

35.4.8  $\int_{\Omega} \text{etr}(-\mathbf{TX}) |\mathbf{X}|^{a-\frac{1}{2}(m+1)} Z_{\kappa}(\mathbf{X}) d\mathbf{X}$   
 $= \Gamma_m(a + \kappa) |\mathbf{T}|^{-a} Z_{\kappa}(\mathbf{T}^{-1}),$

35.4.9  $\int_{0 < \mathbf{X} < \mathbf{I}} |\mathbf{X}|^{a-\frac{1}{2}(m+1)} |\mathbf{I} - \mathbf{X}|^{b-\frac{1}{2}(m+1)} Z_{\kappa}(\mathbf{TX}) d\mathbf{X}$   
 $= \frac{[a]_{\kappa}}{[a+b]_{\kappa}} B_m(a, b) Z_{\kappa}(\mathbf{T}).$

**35.5 Bessel Functions of Matrix Argument**

**35.5(i) Definitions**

35.5.1  $A_{\nu}(\mathbf{0}) = \frac{1}{\Gamma_m(\nu + \frac{1}{2}(m+1))}, \quad \nu \in \mathbb{C}.$

35.5.2

$$A_{\nu}(\mathbf{T}) = A_{\nu}(\mathbf{0}) \sum_{k=0}^{\infty} \frac{(-1)^k}{k!} \sum_{|\kappa|=k} \frac{1}{[\nu + \frac{1}{2}(m+1)]_{\kappa}} Z_{\kappa}(\mathbf{T}),$$

$\nu \in \mathbb{C}, \mathbf{T} \in \mathcal{S}.$

35.5.3

$$B_{\nu}(\mathbf{T}) = \int_{\Omega} \text{etr}(-(\mathbf{TX} + \mathbf{X}^{-1})) |\mathbf{X}|^{\nu-\frac{1}{2}(m+1)} d\mathbf{X},$$

$\nu \in \mathbb{C}, \mathbf{T} \in \Omega.$

**35.5(ii) Properties**

35.5.4  $\int_{\Omega} \text{etr}(-\mathbf{TX}) |\mathbf{X}|^{\nu} A_{\nu}(\mathbf{SX}) d\mathbf{X}$   
 $= \text{etr}(-\mathbf{ST}^{-1}) |\mathbf{T}|^{-\nu-\frac{1}{2}(m+1)},$   
 $\mathbf{S} \in \mathcal{S}, \mathbf{T} \in \Omega; \Re(\nu) > -1.$

$$35.5.5 \int_{\mathbf{0} < \mathbf{X} < \mathbf{T}} A_{\nu_1}(\mathbf{S}_1 \mathbf{X}) |\mathbf{X}|^{\nu_1} A_{\nu_2}(\mathbf{S}_2(\mathbf{T} - \mathbf{X})) |\mathbf{T} - \mathbf{X}|^{\nu_2} d\mathbf{X} = |\mathbf{T}|^{\nu_1 + \nu_2 + \frac{1}{2}(m+1)} A_{\nu_1 + \nu_2 + \frac{1}{2}(m+1)}((\mathbf{S}_1 + \mathbf{S}_2)\mathbf{T}),$$

$$\nu_j \in \mathbb{C}, \Re(\nu_j) > -1, j = 1, 2; \mathbf{S}_1, \mathbf{S}_2 \in \mathbf{S}; \mathbf{T} \in \Omega.$$

$$35.5.6 B_\nu(\mathbf{T}) = |\mathbf{T}|^{-\nu} B_{-\nu}(\mathbf{T}), \quad \nu \in \mathbb{C}, \mathbf{T} \in \Omega.$$

$$35.5.7 \int_{\Omega} A_{\nu_1}(\mathbf{T}\mathbf{X}) B_{-\nu_2}(\mathbf{S}\mathbf{X}) |\mathbf{X}|^{\nu_1} d\mathbf{X} = \frac{1}{A_{\nu_1 + \nu_2}(\mathbf{0})} |\mathbf{S}|^{\nu_2} |\mathbf{T} + \mathbf{S}|^{-(\nu_1 + \nu_2 + \frac{1}{2}(m+1))}, \quad \Re(\nu_1 + \nu_2) > -1; \mathbf{S}, \mathbf{T} \in \Omega.$$

$$35.5.8 \int_{\mathbf{O}(m)} \text{etr}(\mathbf{S}\mathbf{H}) d\mathbf{H} = \frac{A_{-1/2}(-\frac{1}{4}\mathbf{S}\mathbf{S}^T)}{A_{-1/2}(\mathbf{0})}, \quad \mathbf{S} \text{ arbitrary.}$$

**35.5(iii) Asymptotic Approximations**

For asymptotic approximations for Bessel functions of matrix argument, see Herz (1955) and Butler and Wood (2003).

**35.6 Confluent Hypergeometric Functions of Matrix Argument**

**35.6(i) Definitions**

$$35.6.1 {}_1F_1\left(\begin{matrix} a \\ b \end{matrix}; \mathbf{T}\right) = \sum_{k=0}^{\infty} \frac{1}{k!} \sum_{|\kappa|=k} \frac{[a]_{\kappa}}{[b]_{\kappa}} Z_{\kappa}(\mathbf{T}).$$

$$35.6.2 \Psi(a; b; \mathbf{T}) = \frac{1}{\Gamma_m(a)} \int_{\Omega} \text{etr}(-\mathbf{T}\mathbf{X}) |\mathbf{X}|^{a - \frac{1}{2}(m+1)} |\mathbf{I} + \mathbf{X}|^{b - a - \frac{1}{2}(m+1)} d\mathbf{X}, \quad \Re(a) > \frac{1}{2}(m-1), \mathbf{T} \in \Omega.$$

**Laguerre Form**

$$35.6.3 L_{\nu}^{(\gamma)}(\mathbf{T}) = \frac{\Gamma_m(\gamma + \nu + \frac{1}{2}(m+1))}{\Gamma_m(\gamma + \frac{1}{2}(m+1))} {}_1F_1\left(\begin{matrix} -\nu \\ \gamma + \frac{1}{2}(m+1) \end{matrix}; \mathbf{T}\right), \quad \Re(\gamma), \Re(\gamma + \nu) > -1.$$

**35.6(ii) Properties**

$$35.6.4 {}_1F_1\left(\begin{matrix} a \\ b \end{matrix}; \mathbf{T}\right) = \frac{1}{B_m(a, b-a)} \int_{\mathbf{0} < \mathbf{X} < \mathbf{I}} \text{etr}(\mathbf{T}\mathbf{X}) |\mathbf{X}|^{a - \frac{1}{2}(m+1)} |\mathbf{I} - \mathbf{X}|^{b - a - \frac{1}{2}(m+1)} d\mathbf{X}, \quad \Re(a), \Re(b-a) > \frac{1}{2}(m-1).$$

$$35.6.5 \int_{\Omega} \text{etr}(-\mathbf{T}\mathbf{X}) |\mathbf{X}|^{b - \frac{1}{2}(m+1)} {}_1F_1\left(\begin{matrix} a \\ b \end{matrix}; \mathbf{S}\mathbf{X}\right) d\mathbf{X} = \Gamma_m(b) |\mathbf{I} - \mathbf{S}\mathbf{T}^{-1}|^{-a} |\mathbf{T}|^{-b}, \quad \mathbf{T} > \mathbf{S}, \Re(b) > \frac{1}{2}(m-1).$$

$$35.6.6 B_m(b_1, b_2) |\mathbf{T}|^{b_1 + b_2 - \frac{1}{2}(m+1)} {}_1F_1\left(\begin{matrix} a_1 + a_2 \\ b_1 + b_2 \end{matrix}; \mathbf{T}\right) \\ = \int_{\mathbf{0} < \mathbf{X} < \mathbf{T}} |\mathbf{X}|^{b_1 - \frac{1}{2}(m+1)} {}_1F_1\left(\begin{matrix} a_1 \\ b_1 \end{matrix}; \mathbf{X}\right) |\mathbf{T} - \mathbf{X}|^{b_2 - \frac{1}{2}(m+1)} {}_1F_1\left(\begin{matrix} a_2 \\ b_2 \end{matrix}; \mathbf{T} - \mathbf{X}\right) d\mathbf{X}, \quad \Re(b_1), \Re(b_2) > \frac{1}{2}(m-1).$$

$$35.6.7 {}_1F_1\left(\begin{matrix} a \\ b \end{matrix}; \mathbf{T}\right) = \text{etr}(\mathbf{T}) {}_1F_1\left(\begin{matrix} b-a \\ b \end{matrix}; -\mathbf{T}\right).$$

$$35.6.8 \int_{\Omega} |\mathbf{T}|^{c - \frac{1}{2}(m+1)} \Psi(a; b; \mathbf{T}) d\mathbf{T} = \frac{\Gamma_m(c) \Gamma_m(a-c) \Gamma_m(c-b + \frac{1}{2}(m+1))}{\Gamma_m(a) \Gamma_m(a-b + \frac{1}{2}(m+1))},$$

$$\Re(a) > \Re(c) + \frac{1}{2}(m-1) > m-1, \Re(c-b) > -1.$$

**35.6(iii) Relations to Bessel Functions of Matrix Argument**

$$35.6.9 \lim_{a \rightarrow \infty} {}_1F_1\left(\begin{matrix} a \\ \nu + \frac{1}{2}(m+1) \end{matrix}; -a^{-1}\mathbf{T}\right) = \frac{A_{\nu}(\mathbf{T})}{A_{\nu}(\mathbf{0})}.$$

$$35.6.10 \lim_{a \rightarrow \infty} \Gamma_m(a) \Psi(a + \nu; \nu + \frac{1}{2}(m+1); a^{-1}\mathbf{T}) = B_{\nu}(\mathbf{T}).$$

**35.6(iv) Asymptotic Approximations**

For asymptotic approximations for confluent hypergeometric functions of matrix argument, see Herz (1955) and Butler and Wood (2002).

**35.7 Gaussian Hypergeometric Function of Matrix Argument****35.7(i) Definition**

$$35.7.1 \quad {}_2F_1\left(\begin{matrix} a, b \\ c \end{matrix}; \mathbf{T}\right) = \sum_{k=0}^{\infty} \frac{1}{k!} \sum_{|\kappa|=k} \frac{[a]_{\kappa} [b]_{\kappa}}{[c]_{\kappa}} Z_{\kappa}(\mathbf{T}), \quad -c + \frac{1}{2}(j+1) \notin \mathbb{N}, \quad 1 \leq j \leq m; \quad \|\mathbf{T}\| < 1.$$

**Jacobi Form**

$$35.7.2 \quad P_{\nu}^{(\gamma, \delta)}(\mathbf{T}) = \frac{\Gamma_m(\gamma + \nu + \frac{1}{2}(m+1))}{\Gamma_m(\gamma + \frac{1}{2}(m+1))} {}_2F_1\left(\begin{matrix} -\nu, \gamma + \delta + \nu + \frac{1}{2}(m+1) \\ \gamma + \frac{1}{2}(m+1) \end{matrix}; \mathbf{T}\right), \quad \mathbf{0} < \mathbf{T} < \mathbf{I}; \quad \gamma, \delta, \nu \in \mathbb{C}; \quad \Re(\gamma) > -1.$$

**35.7(ii) Basic Properties****Case  $m = 2$** 

$$35.7.3 \quad {}_2F_1\left(\begin{matrix} a, b \\ c \end{matrix}; \begin{pmatrix} t_1 & 0 \\ 0 & t_2 \end{pmatrix}\right) = \sum_{k=0}^{\infty} \frac{(a)_k (c-a)_k (b)_k (c-b)_k}{k! (c)_{2k} (c-\frac{1}{2})_k} (t_1 t_2)^k {}_2F_1\left(\begin{matrix} a+k, b+k \\ c+2k \end{matrix}; t_1 + t_2 - t_1 t_2\right).$$

**Confluent Form**

$$35.7.4 \quad \lim_{c \rightarrow \infty} {}_2F_1\left(\begin{matrix} a, b \\ c \end{matrix}; \mathbf{I} - c\mathbf{T}^{-1}\right) = |\mathbf{T}|^b \Psi\left(b; b-a + \frac{1}{2}(m+1); \mathbf{T}\right).$$

**Integral Representation**

$$35.7.5 \quad {}_2F_1\left(\begin{matrix} a, b \\ c \end{matrix}; \mathbf{T}\right) = \frac{1}{B_m(a, c-a)} \int_{\mathbf{0} < \mathbf{X} < \mathbf{I}} |\mathbf{X}|^{a-\frac{1}{2}(m+1)} |\mathbf{I} - \mathbf{X}|^{c-a-\frac{1}{2}(m+1)} |\mathbf{I} - \mathbf{T}\mathbf{X}|^{-b} d\mathbf{X},$$

$$\Re(a), \Re(c-a) > \frac{1}{2}(m-1), \quad \mathbf{0} < \mathbf{T} < \mathbf{I}.$$

**Transformations of Parameters**

$$35.7.6 \quad {}_2F_1\left(\begin{matrix} a, b \\ c \end{matrix}; \mathbf{T}\right) = |\mathbf{I} - \mathbf{T}|^{c-a-b} {}_2F_1\left(\begin{matrix} c-a, c-b \\ c \end{matrix}; \mathbf{T}\right) = |\mathbf{I} - \mathbf{T}|^{-a} {}_2F_1\left(\begin{matrix} a, c-b \\ c \end{matrix}; -\mathbf{T}(\mathbf{I} - \mathbf{T})^{-1}\right)$$

$$= |\mathbf{I} - \mathbf{T}|^{-b} {}_2F_1\left(\begin{matrix} c-a, b \\ c \end{matrix}; -\mathbf{T}(\mathbf{I} - \mathbf{T})^{-1}\right).$$

**Gauss Formula**

$$35.7.7 \quad {}_2F_1\left(\begin{matrix} a, b \\ c \end{matrix}; \mathbf{I}\right) = \frac{\Gamma_m(c) \Gamma_m(c-a-b)}{\Gamma_m(c-a) \Gamma_m(c-b)}, \quad \Re(c), \Re(c-a-b) > \frac{1}{2}(m-1).$$

**Reflection Formula**

$$35.7.8 \quad {}_2F_1\left(\begin{matrix} a, b \\ c \end{matrix}; \mathbf{T}\right) = \frac{\Gamma_m(c) \Gamma_m(c-a-b)}{\Gamma_m(c-a) \Gamma_m(c-b)} {}_2F_1\left(\begin{matrix} a, b \\ a+b-c + \frac{1}{2}(m+1) \end{matrix}; \mathbf{I} - \mathbf{T}\right), \quad \Re(c), \Re(c-a-b) > \frac{1}{2}(m-1).$$

**35.7(iii) Partial Differential Equations**

Let  $f: \Omega \rightarrow \mathbb{C}$  (a) be *orthogonally invariant*, so that  $f(\mathbf{T})$  is a symmetric function of  $t_1, \dots, t_m$ , the eigenvalues of the matrix argument  $\mathbf{T} \in \Omega$ ; (b) be analytic in  $t_1, \dots, t_m$  in a neighborhood of  $\mathbf{T} = \mathbf{0}$ ; (c) satisfy  $f(\mathbf{0}) = 1$ . Subject to the conditions (a)–(c), the function  $f(\mathbf{T}) = {}_2F_1(a, b; c; \mathbf{T})$  is the unique solution of each partial differential equation

$$35.7.9 \quad t_j(1-t_j) \frac{\partial^2 F}{\partial t_j^2} - \frac{1}{2} \sum_{\substack{k=1 \\ k \neq j}}^m \frac{t_k(1-t_k)}{t_j - t_k} \frac{\partial F}{\partial t_k} + \left( c - \frac{1}{2}(m-1) - (a+b - \frac{1}{2}(m-3)) t_j + \frac{1}{2} \sum_{\substack{k=1 \\ k \neq j}}^m \frac{t_j(1-t_j)}{t_j - t_k} \right) \frac{\partial F}{\partial t_j} = abF,$$

for  $j = 1, \dots, m$ .

Systems of partial differential equations for the  ${}_0F_1$  (defined in §35.8) and  ${}_1F_1$  functions of matrix argument can be obtained by applying (35.8.9) and (35.8.10) to (35.7.9).

**35.7(iv) Asymptotic Approximations**

Butler and Wood (2002) applies Laplace’s method (§2.3(iii)) to (35.7.5) to derive uniform asymptotic approximations for the functions

$$35.7.10 \quad {}_2F_1\left(\begin{matrix} \alpha a, \alpha b \\ \alpha c \end{matrix}; \mathbf{T}\right)$$

and

$$35.7.11 \quad {}_2F_1\left(\begin{matrix} a, b \\ c \end{matrix}; \mathbf{I} - \alpha^{-1}\mathbf{T}\right)$$

as  $\alpha \rightarrow \infty$ . These approximations are in terms of elementary functions.

For other asymptotic approximations for Gaussian hypergeometric functions of matrix argument, see Herz (1955), Muirhead (1982, pp. 264–281, 290, 472, 563), and Butler and Wood (2002).

**35.8 Generalized Hypergeometric Functions of Matrix Argument**

**35.8(i) Definition**

Let  $p$  and  $q$  be nonnegative integers;  $a_1, \dots, a_p \in \mathbb{C}$ ;  $b_1, \dots, b_q \in \mathbb{C}$ ;  $-b_j + \frac{1}{2}(k+1) \notin \mathbb{N}$ ,  $1 \leq j \leq q$ ,  $1 \leq k \leq m$ . The generalized hypergeometric function  ${}_pF_q$  with matrix argument  $\mathbf{T} \in \mathcal{S}$ , numerator parameters  $a_1, \dots, a_p$ , and denominator parameters  $b_1, \dots, b_q$  is

$$35.8.1 \quad {}_pF_q\left(\begin{matrix} a_1, \dots, a_p \\ b_1, \dots, b_q \end{matrix}; \mathbf{T}\right) = \sum_{k=0}^{\infty} \frac{1}{k!} \sum_{|\kappa|=k} \frac{[a_1]_{\kappa} \cdots [a_p]_{\kappa}}{[b_1]_{\kappa} \cdots [b_q]_{\kappa}} Z_{\kappa}(\mathbf{T}).$$

**Convergence Properties**

If  $-a_j + \frac{1}{2}(k+1) \in \mathbb{N}$  for some  $j, k$  satisfying  $1 \leq j \leq p$ ,  $1 \leq k \leq m$ , then the series expansion (35.8.1) terminates.

If  $p \leq q$ , then (35.8.1) converges for all  $\mathbf{T}$ .

If  $p = q + 1$ , then (35.8.1) converges absolutely for  $\|\mathbf{T}\| < 1$  and diverges for  $\|\mathbf{T}\| > 1$ .

If  $p > q + 1$ , then (35.8.1) diverges unless it terminates.

**35.8(ii) Relations to Other Functions**

$$35.8.2 \quad {}_0F_0\left(\begin{matrix} - \\ - \end{matrix}; \mathbf{T}\right) = \text{etr}(\mathbf{T}), \quad \mathbf{T} \in \mathcal{S}.$$

$$35.8.3 \quad {}_2F_1\left(\begin{matrix} a, b \\ b \end{matrix}; \mathbf{T}\right) = {}_1F_0\left(\begin{matrix} a \\ - \end{matrix}; \mathbf{T}\right) = |\mathbf{I} - \mathbf{T}|^{-a}, \quad \mathbf{0} < \mathbf{T} < \mathbf{I}.$$

**35.8.4**

$$A_{\nu}(\mathbf{T}) = \frac{1}{\Gamma_m(\nu + \frac{1}{2}(m+1))} {}_0F_1\left(\begin{matrix} - \\ \nu + \frac{1}{2}(m+1) \end{matrix}; -\mathbf{T}\right), \quad \mathbf{T} \in \mathcal{S}.$$

**35.8(iii)  ${}_3F_2$  Case**

**Kummer Transformation**

Let  $c = b_1 + b_2 - a_1 - a_2 - a_3$ . Then

$$35.8.5 \quad {}_3F_2\left(\begin{matrix} a_1, a_2, a_3 \\ b_1, b_2 \end{matrix}; \mathbf{I}\right) = \frac{\Gamma_m(b_2) \Gamma_m(c)}{\Gamma_m(b_2 - a_3) \Gamma_m(c + a_3)} \times {}_3F_2\left(\begin{matrix} b_1 - a_1, b_1 - a_2, a_3 \\ b_1, c + a_3 \end{matrix}; \mathbf{I}\right),$$

$$\Re(b_2), \Re(c) > \frac{1}{2}(m-1).$$

**Pfaff–Saalschutz Formula**

Let  $a_1 + a_2 + a_3 + \frac{1}{2}(m+1) = b_1 + b_2$ ; one of the  $a_j$  be a negative integer;  $\Re(b_1 - a_1), \Re(b_1 - a_2), \Re(b_1 - a_3), \Re(b_1 - a_1 - a_2 - a_3) > \frac{1}{2}(m-1)$ . Then

$$35.8.6 \quad {}_3F_2\left(\begin{matrix} a_1, a_2, a_3 \\ b_1, b_2 \end{matrix}; \mathbf{I}\right) = \frac{\Gamma_m(b_1 - a_1) \Gamma_m(b_1 - a_2)}{\Gamma_m(b_1) \Gamma_m(b_1 - a_1 - a_2)} \times \frac{\Gamma_m(b_1 - a_3) \Gamma_m(b_1 - a_1 - a_2 - a_3)}{\Gamma_m(b_1 - a_1 - a_3) \Gamma_m(b_1 - a_2 - a_3)}.$$

**Thomae Transformation**

Again, let  $c = b_1 + b_2 - a_1 - a_2 - a_3$ . Then

$$35.8.7 \quad {}_3F_2\left(\begin{matrix} a_1, a_2, a_3 \\ b_1, b_2 \end{matrix}; \mathbf{I}\right) = \frac{\Gamma_m(b_1) \Gamma_m(b_2) \Gamma(c)}{\Gamma_m(a_1) \Gamma_m(c + a_2) \Gamma(c + a_3)} \times {}_3F_2\left(\begin{matrix} b_1 - a_1, b_2 - a_2, c \\ c + a_2, c + a_3 \end{matrix}; \mathbf{I}\right),$$

$$\Re(b_1), \Re(b_2), \Re(c) > \frac{1}{2}(m-1).$$

**35.8(iv) General Properties**

**Value at  $\mathbf{T} = \mathbf{0}$**

$$35.8.8 \quad {}_pF_q\left(\begin{matrix} a_1, \dots, a_p \\ b_1, \dots, b_q \end{matrix}; \mathbf{0}\right) = 1.$$

**Confluence**

$$35.8.9 \quad \lim_{\gamma \rightarrow \infty} {}_{p+1}F_q\left(\begin{matrix} a_1, \dots, a_p, \gamma \\ b_1, \dots, b_q \end{matrix}; \gamma^{-1}\mathbf{T}\right) = {}_pF_q\left(\begin{matrix} a_1, \dots, a_p \\ b_1, \dots, b_q \end{matrix}; \mathbf{T}\right),$$

**35.8.10**

$$\lim_{\gamma \rightarrow \infty} {}_pF_{q+1}\left(\begin{matrix} a_1, \dots, a_p \\ b_1, \dots, b_q, \gamma \end{matrix}; \gamma\mathbf{T}\right) = {}_pF_q\left(\begin{matrix} a_1, \dots, a_p \\ b_1, \dots, b_q \end{matrix}; \mathbf{T}\right).$$

**Invariance**

**35.8.11**

$${}_pF_q\left(\begin{matrix} a_1, \dots, a_p \\ b_1, \dots, b_q \end{matrix}; \mathbf{H}\mathbf{T}\mathbf{H}^{-1}\right) = {}_pF_q\left(\begin{matrix} a_1, \dots, a_p \\ b_1, \dots, b_q \end{matrix}; \mathbf{T}\right),$$

$\mathbf{H} \in \mathbf{O}(m).$

**Laplace Transform**

**35.8.12**

$$\int_{\Omega} \text{etr}(-\mathbf{T}\mathbf{X})|\mathbf{X}|^{\gamma-\frac{1}{2}(m+1)} {}_pF_q\left(\begin{matrix} a_1, \dots, a_p \\ b_1, \dots, b_q \end{matrix}; -\mathbf{X}\right) d\mathbf{X}$$

$$= \Gamma_m(\gamma)|\mathbf{T}|^{-\gamma} {}_{p+1}F_q\left(\begin{matrix} a_1, \dots, a_p, \gamma \\ b_1, \dots, b_q \end{matrix}; -\mathbf{T}^{-1}\right),$$

$\Re(\gamma) > \frac{1}{2}(m-1).$

**Euler Integral**

**35.8.13**

$$\int_{\mathbf{0} < \mathbf{X} < \mathbf{I}} |\mathbf{X}|^{a_1-\frac{1}{2}(m+1)} |\mathbf{I}-\mathbf{X}|^{b_1-a_1-\frac{1}{2}(m+1)}$$

$$\times {}_pF_q\left(\begin{matrix} a_2, \dots, a_{p+1} \\ b_2, \dots, b_{q+1} \end{matrix}; \mathbf{T}\mathbf{X}\right) d\mathbf{X}$$

$$= \frac{1}{B_m(b_1-a_1, a_1)} {}_{p+1}F_{q+1}\left(\begin{matrix} a_1, \dots, a_{p+1} \\ b_1, \dots, b_{q+1} \end{matrix}; \mathbf{T}\right),$$

$\Re(b_1-a_1), \Re(a_1) > \frac{1}{2}(m-1).$

**35.8(v) Mellin–Barnes Integrals**

Multidimensional Mellin–Barnes integrals are established in Ding *et al.* (1996) for the functions  ${}_pF_q$  and  ${}_{p+1}F_p$  of matrix argument. A similar result for the  ${}_0F_1$  function of matrix argument is given in Faraut and Korányi (1994, p. 346). These multidimensional integrals reduce to the classical Mellin–Barnes integrals (§5.19(ii)) in the special case  $m = 1$ .

See also Faraut and Korányi (1994, pp. 318–340).

**Applications**

**35.9 Applications**

In multivariate statistical analysis based on the multivariate normal distribution, the probability density functions of many random matrices are expressible in terms of generalized hypergeometric functions of matrix argument  ${}_pF_q$ , with  $p \leq 2$  and  $q \leq 1$ . See James (1964), Muirhead (1982), Takemura (1984), Farrell (1985), and Chikuse (2003) for extensive treatments.

For other statistical applications of  ${}_pF_q$  functions of matrix argument see Perlman and Olkin (1980), Groeneboom and Truax (2000), Bhaumik and Sarkar (2002), Richards (2004) (monotonicity of power functions of multivariate statistical test criteria), Bingham

*et al.* (1992) (Procrustes analysis), and Phillips (1986) (exact distributions of statistical test criteria). These references all use results related to the integral formulas (35.4.7) and (35.5.8).

For applications of the integral representation (35.5.3) see McFarland and Richards (2001, 2002) (statistical estimation of misclassification probabilities for discriminating between multivariate normal populations). The asymptotic approximations of §35.7(iv) are applied in numerous statistical contexts in Butler and Wood (2002).

In chemistry, Wei and Eichinger (1993) expresses the probability density functions of macromolecules in terms of generalized hypergeometric functions of matrix argument, and develop asymptotic approximations for these density functions.

In the nascent area of applications of zonal polynomials to the limiting probability distributions of symmetric random matrices, one of the most comprehensive accounts is Rains (1998).

**Computation**

**35.10 Methods of Computation**

For small values of  $\|\mathbf{T}\|$  the zonal polynomial expansion given by (35.8.1) can be summed numerically. For large  $\|\mathbf{T}\|$  the asymptotic approximations referred to in §35.7(iv) are available.

Other methods include numerical quadrature applied to double and multiple integral representations. See Yan (1992) for the  ${}_1F_1$  and  ${}_2F_1$  functions of matrix argument in the case  $m = 2$ , and Bingham *et al.* (1992) for Monte Carlo simulation on  $\mathbf{O}(m)$  applied to a generalization of the integral (35.5.8).

Koev and Edelman (2006) utilizes combinatorial identities for the zonal polynomials to develop computational algorithms for approximating the series expansion (35.8.1). These algorithms are extremely efficient, converge rapidly even for large values of  $m$ , and have complexity linear in  $m$ .

**35.11 Tables**

Tables of zonal polynomials are given in James (1964) for  $|\kappa| \leq 6$ , Parkhurst and James (1974) for  $|\kappa| \leq 12$ , and Muirhead (1982, p. 238) for  $|\kappa| \leq 5$ . Each table expresses the zonal polynomials as linear combinations of monomial symmetric functions.

**35.12 Software**

See <http://dlmf.nist.gov/35.12>.

## References

### General References

The main references used in writing this chapter are Herz (1955), James (1964), Muirhead (1982), Gross and Richards (1987), and Richards (1992). For additional bibliographic reading see Vilenkin and Klimyk (1992) and Faraut and Korányi (1994).

### Sources

The following list gives the references or other indications of proofs that were used in constructing the various sections in this chapter. These sources supplement the references that are quoted in the text.

- §35.2** Gårding (1947), Herz (1955, p. 479), Muirhead (1982, p. 252). See also Siegel (1935), Bochner and Martin (1948, pp. 90–92, 113–132).
- §35.3** Wishart (1928), Ingham (1933), Gindikin (1964), Gårding (1947), Herz (1955), Olkin (1959).
- §35.4** James (1964), Muirhead (1982, Chapter 7), Macdonald (1995, p. 425). See also Constantine (1963), Maass (1971, pp. 64–71), Macdonald (1995, pp. 388–439).
- §35.5** Herz (1955). See also Bochner (1952), Gross and Kunze (1976), Terras (1988, pp. 49–63), Butler and Wood (2003).
- §35.6** Koecher (1954), Muirhead (1978), Muirhead (1982, pp. 264–266, 472–473), Herz (1955). For (35.6.6) apply (35.2.3) and (35.6.5). See also Shimura (1982).
- §35.7** Herz (1955), Muirhead (1982, pp. 264–281, 290, 472), Faraut and Korányi (1994, pp. 337–340). For (35.7.8) see Zheng (1997). See also Macdonald (1990), Ding *et al.* (1996), Koornwinder and Sprinkhuizen-Kuyper (1978), Gross and Richards (1991).
- §35.8** Gross and Richards (1987, 1991), Faraut and Korányi (1994, pp. 318–340), Herz (1955), Muirhead (1982, pp. 259–262), Macdonald (1990), James (1964), Ding *et al.* (1996).

## Chapter 36

# Integrals with Coalescing Saddles

M. V. Berry<sup>1</sup> and C. J. Howls<sup>2</sup>

<b>Notation</b>	<b>776</b>	36.10 Differential Equations . . . . .	788
36.1 Special Notation . . . . .	776	36.11 Leading-Order Asymptotics . . . . .	789
<b>Properties</b>	<b>776</b>	<b>Applications</b>	<b>789</b>
36.2 Catastrophes and Canonical Integrals . . .	776	36.12 Uniform Approximation of Integrals . . . . .	789
36.3 Visualizations of Canonical Integrals . . .	778	36.13 Kelvin's Ship-Wave Pattern . . . . .	790
36.4 Bifurcation Sets . . . . .	781	36.14 Other Physical Applications . . . . .	791
36.5 Stokes Sets . . . . .	782	<b>Computation</b>	<b>792</b>
36.6 Scaling Relations . . . . .	785	36.15 Methods of Computation . . . . .	792
36.7 Zeros . . . . .	785	<b>References</b>	<b>792</b>
36.8 Convergent Series Expansions . . . . .	787		
36.9 Integral Identities . . . . .	787		

<sup>1</sup>H H Wills Physics Laboratory, Bristol, United Kingdom.

<sup>2</sup>School of Mathematics, University of Southampton, Southampton, United Kingdom.

Copyright © 2009 National Institute of Standards and Technology. All rights reserved.



**Notation**

**36.1 Special Notation**

(For other notation see pp. xiv and 873.)

- $l, m, n$  integers.
- $k, t, s$  real or complex variables.
- $K$  codimension.
- $\mathbf{x}$   $\{x_1, x_2, \dots, x_K\}$ , where  $x_1, x_2, \dots, x_K$  are real parameters; also  $x_1 = x, x_2 = y, x_3 = z$  when  $K \leq 3$ .
- Ai, Bi Airy functions (§9.2).
- \* complex conjugate.

The main functions covered in this chapter are cuspid catastrophes  $\Phi_K(t; \mathbf{x})$ ; umbilic catastrophes with codimension three  $\Phi^{(E)}(s, t; \mathbf{x}), \Phi^{(H)}(s, t; \mathbf{x})$ ; canonical integrals  $\Psi_K(\mathbf{x}), \Psi^{(E)}(\mathbf{x}), \Psi^{(H)}(\mathbf{x})$ ; diffraction catastrophes  $\Psi_K(\mathbf{x}; k), \Psi^{(E)}(\mathbf{x}; k), \Psi^{(H)}(\mathbf{x}; k)$  generated by the catastrophes. (There is no standard nomenclature for these functions.)

**Properties**

**36.2 Catastrophes and Canonical Integrals**

**36.2(i) Definitions**

**Normal Forms Associated with Canonical Integrals:  
Cuspid Catastrophe with Codimension  $K$**

**36.2.1** 
$$\Phi_K(t; \mathbf{x}) = t^{K+2} + \sum_{m=1}^K x_m t^m.$$

Special cases:  $K = 1$ , *fold catastrophe*;  $K = 2$ , *cuspid catastrophe*;  $K = 3$ , *swallowtail catastrophe*.

**Normal Forms for Umbilic Catastrophes with Codimension  $K = 3$**

**36.2.2** 
$$\Phi^{(E)}(s, t; \mathbf{x}) = s^3 - 3st^2 + z(s^2 + t^2) + yt + xs,$$
  

$$\mathbf{x} = \{x, y, z\},$$

(elliptic umbilic).

**36.2.3** 
$$\Phi^{(H)}(s, t; \mathbf{x}) = s^3 + t^3 + zst + yt + xs,$$
  

$$\mathbf{x} = \{x, y, z\},$$

(hyperbolic umbilic).

**Canonical Integrals**

**36.2.4** 
$$\Psi_K(\mathbf{x}) = \int_{-\infty}^{\infty} \exp(i \Phi_K(t; \mathbf{x})) dt.$$

**36.2.5** 
$$\Psi^{(U)}(\mathbf{x}) = \int_{-\infty}^{\infty} \int_{-\infty}^{\infty} \exp(i \Phi^{(U)}(s, t; \mathbf{x})) ds dt, \quad U = E, H.$$

**36.2.6** 
$$\Psi^{(E)}(\mathbf{x}) = 2\sqrt{\pi/3} \exp(i(\frac{4}{27}z^3 + \frac{1}{3}xz - \frac{1}{4}\pi)) \int_{\infty \exp(-7\pi i/12)}^{\infty \exp(\pi i/12)} \exp\left(i\left(u^6 + 2zu^4 + (z^2 + x)u^2 + \frac{y^2}{12u^2}\right)\right) du,$$

with the contour passing to the lower right of  $u = 0$ .

**36.2.7** 
$$\Psi^{(E)}(\mathbf{x}) = \frac{4\pi}{3^{1/3}} \exp(i(\frac{2}{27}z^3 - \frac{1}{3}xz)) \left( \exp(-i\frac{\pi}{6})F_+(\mathbf{x}) + \exp(i\frac{\pi}{6})F_-(\mathbf{x}) \right),$$
  

$$F_{\pm}(\mathbf{x}) = \int_0^{\infty} \cos\left(ry \exp(\pm i\frac{\pi}{6})\right) \exp\left(2ir^2z \exp(\pm i\frac{\pi}{3})\right) \text{Ai}\left(3^{2/3}r^2 + 3^{-1/3} \exp(\mp i\frac{\pi}{3})\left(\frac{1}{3}z^2 - x\right)\right) dr.$$

**36.2.8** 
$$\Psi^{(H)}(\mathbf{x}) = 4\sqrt{\pi/6} \exp(i(\frac{1}{27}z^3 + \frac{1}{6}z(y+x) + \frac{1}{4}\pi))$$
  

$$\times \int_{\infty \exp(5\pi i/12)}^{\infty \exp(\pi i/12)} \exp\left(i\left(2u^6 + 2zu^4 + (\frac{1}{2}z^2 + x + y)u^2 - \frac{(y-x)^2}{24u^2}\right)\right) du,$$

with the contour passing to the upper right of  $u = 0$ .

**36.2.9** 
$$\Psi^{(H)}(\mathbf{x}) = \frac{2\pi}{3^{1/3}} \int_{\infty \exp(5\pi i/6)}^{\infty \exp(\pi i/6)} \exp(i(s^3 + xs)) \text{Ai}\left(\frac{zs + y}{3^{1/3}}\right) ds.$$

**Diffraction Catastrophes**

**36.2.10**

$$\Psi_K(\mathbf{x}; k) = \sqrt{k} \int_{-\infty}^{\infty} \exp(ik \Phi_K(t; \mathbf{x})) dt, \quad k > 0.$$

**36.2.11**

$$\Psi^{(U)}(\mathbf{x}; k) = k \int_{-\infty}^{\infty} \int_{-\infty}^{\infty} \exp(ik \Phi^{(U)}(s, t; \mathbf{x})) ds dt,$$

$U = E, H; k > 0.$

For more extensive lists of normal forms of catastrophes (umbilic and beyond) involving two variables (“corank two”) see Arnol’d (1972, 1974, 1975).

**36.2(ii) Special Cases**

**36.2.12**  $\Psi_0 = \sqrt{\pi} \exp\left(i\frac{\pi}{4}\right).$

$\Psi_1$  is related to the Airy function (§9.2):

**36.2.13**  $\Psi_1(x) = \frac{2\pi}{3^{1/3}} \text{Ai}\left(\frac{x}{3^{1/3}}\right).$

$\Psi_2$  is the Pearcey integral (Pearcey (1946)):

**36.2.14**

$$\Psi_2(\mathbf{x}) = P(x_2, x_1) = \int_{-\infty}^{\infty} \exp(i(t^4 + x_2 t^2 + x_1 t)) dt.$$

(Other notations also appear in the literature.)

**36.2.15**

$$\Psi_K(\mathbf{0}) = \frac{2}{K+2} \Gamma\left(\frac{1}{K+2}\right) \begin{cases} \exp\left(i\frac{\pi}{2(K+2)}\right), & K \text{ even,} \\ \cos\left(\frac{\pi}{2(K+2)}\right), & K \text{ odd.} \end{cases}$$

**36.2.16**

$$\begin{aligned} \Psi_1(\mathbf{0}) &= 1.54669, & \Psi_2(\mathbf{0}) &= 1.67481 + i 0.69373 \\ \Psi_3(\mathbf{0}) &= 1.74646, & \Psi_4(\mathbf{0}) &= 1.79222 + i 0.48022. \end{aligned}$$

$$\frac{\partial^p}{\partial x_1^p} \Psi_K(\mathbf{0}) = \frac{2}{K+2} \Gamma\left(\frac{p+1}{K+2}\right) \cos\left(\frac{\pi}{2} \left(\frac{p+1}{K+2} + p\right)\right), \quad K \text{ odd,}$$

**36.2.17**

$$\frac{\partial^{2q+1}}{\partial x_1^{2q+1}} \Psi_K(\mathbf{0}) = 0, \quad K \text{ even,}$$

$$\frac{\partial^{2q}}{\partial x_1^{2q}} \Psi_K(\mathbf{0}) = \frac{2}{K+2} \Gamma\left(\frac{2q+1}{K+2}\right) \exp\left(i\frac{\pi}{2} \left(\frac{2q+1}{K+2} + 2q\right)\right), \quad K \text{ even.}$$

**36.2.18**  $\Psi^{(E)}(\mathbf{0}) = \frac{1}{3} \sqrt{\pi} \Gamma\left(\frac{1}{6}\right) = 3.28868,$

$\Psi^{(H)}(\mathbf{0}) = \frac{1}{3} \Gamma^2\left(\frac{1}{3}\right) = 2.39224.$

**36.2.19**

$$\begin{aligned} \Psi_2(0, y) &= \frac{\pi}{2} \sqrt{\frac{|y|}{2}} \exp\left(-i\frac{y^2}{8}\right) \left( \exp\left(i\frac{\pi}{8}\right) J_{-1/4}\left(\frac{y^2}{8}\right) \right. \\ &\quad \left. - \text{sign}(y) \exp\left(-i\frac{\pi}{8}\right) J_{1/4}\left(\frac{y^2}{8}\right) \right). \end{aligned}$$

For the Bessel function  $J$  see §10.2(ii).

**36.2.20**

$$\Psi^{(E)}(x, y, 0) = 2\pi^2 \left(\frac{2}{3}\right)^{2/3} \Re\left(\text{Ai}\left(\frac{x+iy}{12^{1/3}}\right) \text{Bi}\left(\frac{x-iy}{12^{1/3}}\right)\right),$$

**36.2.21**  $\Psi^{(H)}(x, y, 0) = \frac{4\pi^2}{3^{2/3}} \text{Ai}\left(\frac{x}{3^{1/3}}\right) \text{Ai}\left(\frac{y}{3^{1/3}}\right).$

**36.2(iii) Symmetries**

**36.2.22**

$$\Psi_{2K}(\mathbf{x}') = \Psi_{2K}(\mathbf{x}), \quad x'_{2m+1} = -x_{2m+1}, \quad x'_{2m} = x_{2m}.$$

**36.2.23**

$$\Psi_{2K+1}(\mathbf{x}') = \Psi_{2K+1}^*(\mathbf{x}), \quad x'_{2m+1} = x_{2m+1}, \quad x'_{2m} = -x_{2m}.$$

**36.2.24**

$$\Psi^{(U)}(x, y, z) = \Psi^{*(U)}(x, y, -z), \quad U = E, H.$$

**36.2.25**

$$\Psi^{(E)}(x, -y, z) = \Psi^{(E)}(x, y, z).$$

**36.2.26**

$$\Psi^{(E)}\left(-\frac{1}{2}x \mp \frac{\sqrt{3}}{2}y, \pm \frac{\sqrt{3}}{2}x - \frac{1}{2}y, z\right) = \Psi^{(E)}(x, y, z),$$

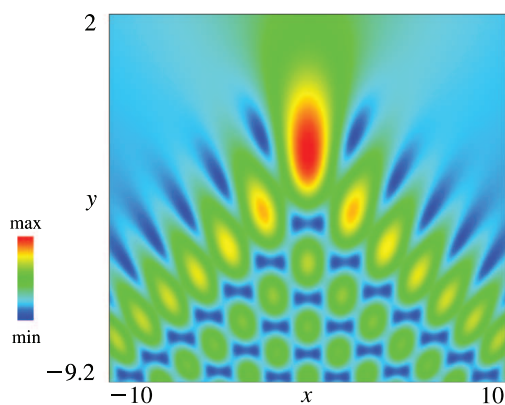
(rotation by  $\pm \frac{2}{3}\pi$  in  $x, y$  plane).

**36.2.27**

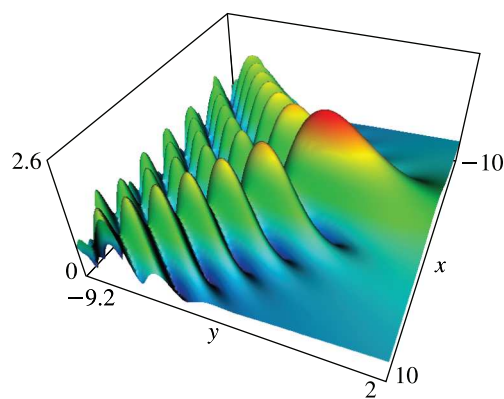
$$\Psi^{(H)}(x, y, z) = \Psi^{(H)}(y, x, z).$$

### 36.3 Visualizations of Canonical Integrals

#### 36.3(i) Canonical Integrals: Modulus



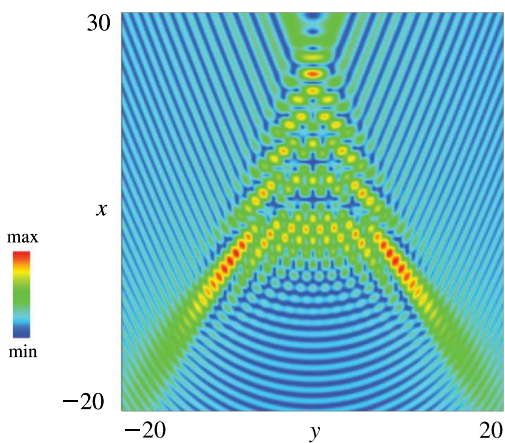
(a) Density plot.



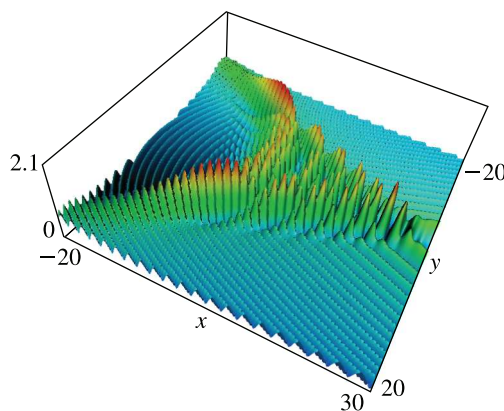
(b) 3D plot.

Figure 36.3.1: Modulus of Pearcey integral  $|\Psi_2(x, y)|$ .

For additional figures see <http://dlmf.nist.gov/36.3.i>.



(a) Density plot.



(b) 3D plot.

Figure 36.3.5: Modulus of swallowtail canonical integral function  $|\Psi_3(x, y, -7.5)|$ .

For additional figures see <http://dlmf.nist.gov/36.3.i>.

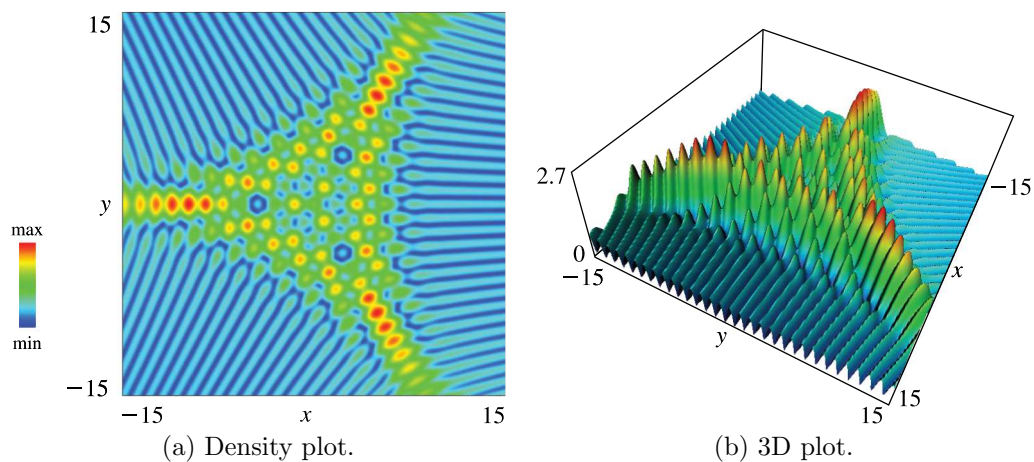


Figure 36.3.8: Modulus of elliptic umbilic canonical integral function  $|\Psi^{(E)}(x, y, 4)|$ .

For additional figures see <http://dlmf.nist.gov/36.3.i>.

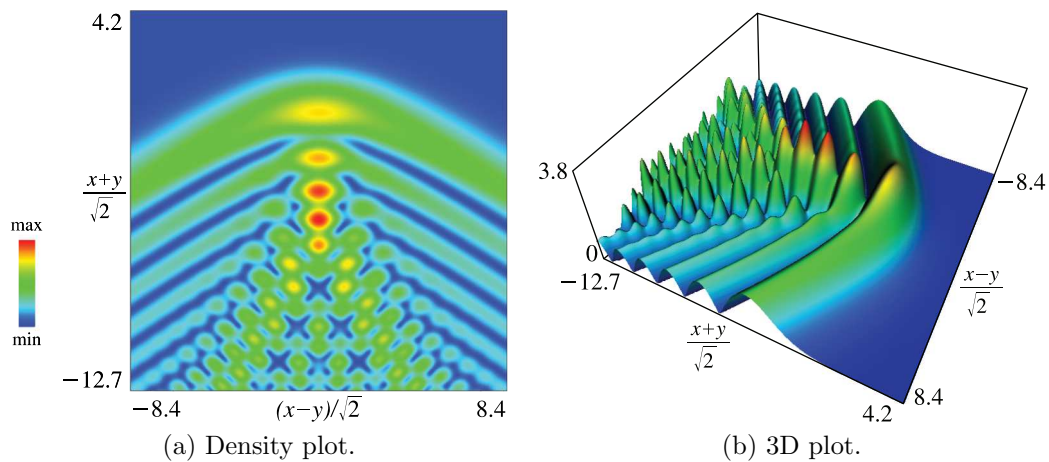


Figure 36.3.12: Modulus of hyperbolic umbilic canonical integral function  $|\Psi^{(H)}(x, y, 3)|$ .

### 36.3(ii) Canonical Integrals: Phase

In Figure 36.3.13(a) points of confluence of phase contours are zeros of  $\Psi_2(x, y)$ ; similarly for other contour plots in this subsection. In Figure 36.3.13(b) points of confluence of all colors are zeros of  $\Psi_2(x, y)$ ; similarly for other density plots in this subsection.

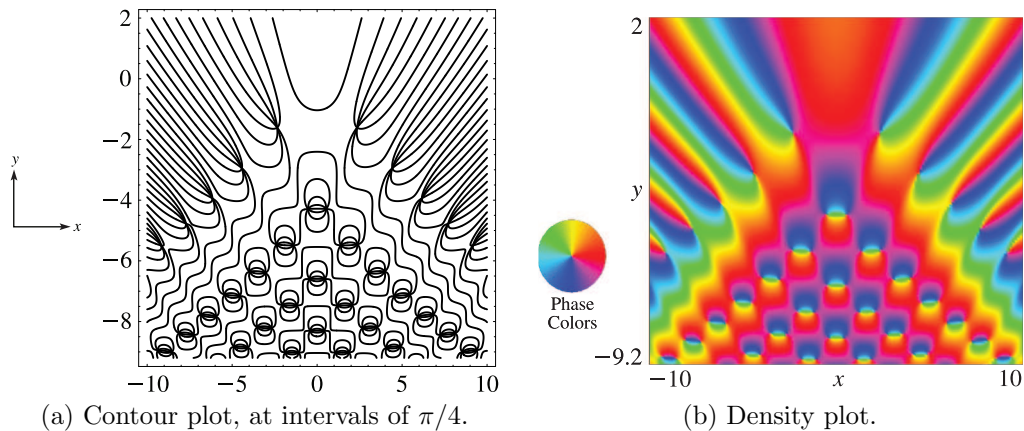


Figure 36.3.13: Phase of Pearcey integral  $\text{ph } \Psi_2(x, y)$ .

For additional figures see <http://dlmf.nist.gov/36.3.ii>.

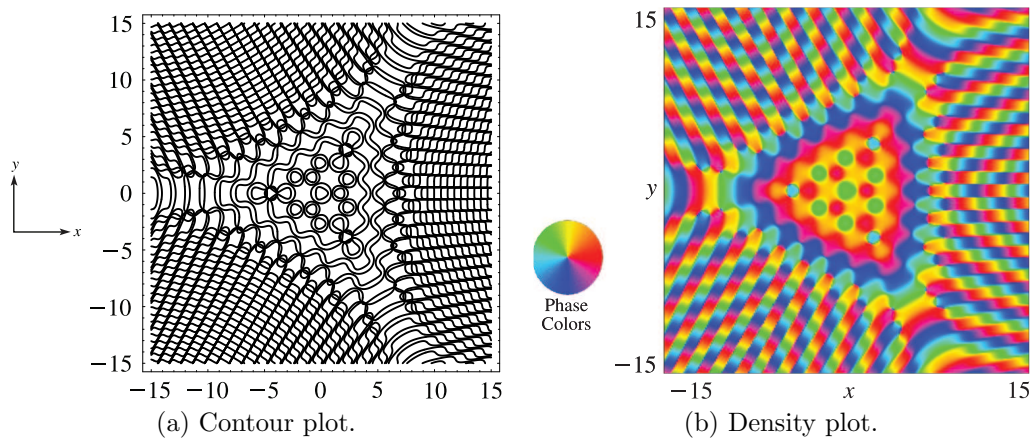


Figure 36.3.17: Phase of elliptic umbilic canonical integral  $\text{ph } \Psi^{(E)}(x, y, 4)$ .

For additional figures see <http://dlmf.nist.gov/36.3.ii>.

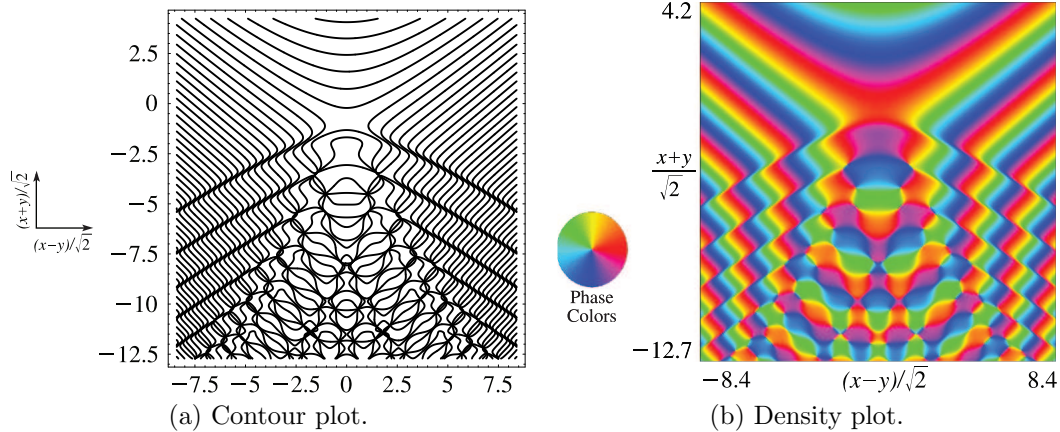


Figure 36.3.21: Phase of hyperbolic umbilic canonical integral  $\text{ph } \Psi^{(H)}(x, y, 3)$ .

### 36.4 Bifurcation Sets

#### 36.4(i) Formulas

##### Critical Points for Cuspoids

These are real solutions  $t_j(\mathbf{x})$ ,  $1 \leq j \leq j_{\max}(\mathbf{x}) \leq K + 1$ , of

$$36.4.1 \quad \frac{\partial}{\partial t} \Phi_K(t_j(\mathbf{x}); \mathbf{x}) = 0.$$

##### Critical Points for Umbilics

These are real solutions  $\{s_j(\mathbf{x}), t_j(\mathbf{x})\}$ ,  $1 \leq j \leq j_{\max}(\mathbf{x}) \leq 4$ , of

$$36.4.2 \quad \begin{aligned} \frac{\partial}{\partial s} \Phi^{(U)}(s_j(\mathbf{x}), t_j(\mathbf{x}); \mathbf{x}) &= 0, \\ \frac{\partial}{\partial t} \Phi^{(U)}(s_j(\mathbf{x}), t_j(\mathbf{x}); \mathbf{x}) &= 0. \end{aligned}$$

##### Bifurcation (Catastrophe) Set for Cuspoids

This is the codimension-one surface in  $\mathbf{x}$  space where critical points coalesce, satisfying (36.4.1) and

$$36.4.3 \quad \frac{\partial^2}{\partial t^2} \Phi_K(t; \mathbf{x}) = 0.$$

##### Bifurcation (Catastrophe) Set for Umbilics

This is the codimension-one surface in  $\mathbf{x}$  space where critical points coalesce, satisfying (36.4.2) and

$$36.4.4 \quad \begin{aligned} \frac{\partial^2}{\partial s^2} \Phi^{(U)}(s, t; \mathbf{x}) \frac{\partial^2}{\partial t^2} \Phi^{(U)}(s, t; \mathbf{x}) \\ - \left( \frac{\partial^2}{\partial s \partial t} \Phi^{(U)}(s, t; \mathbf{x}) \right)^2 = 0. \end{aligned}$$

##### Special Cases

$K = 1$ , fold bifurcation set:

$$36.4.5 \quad x = 0.$$

$K = 2$ , cusp bifurcation set:

$$36.4.6 \quad 27x^2 = -8y^3.$$

$K = 3$ , swallowtail bifurcation set:

$$36.4.7 \quad x = 3t^2(z + 5t^2), \quad y = -t(3z + 10t^2), \quad -\infty < t < \infty.$$

Swallowtail self-intersection line:

$$36.4.8 \quad y = 0, \quad z \leq 0, \quad x = \frac{9}{20}z^2.$$

Swallowtail cusp lines (ribs):

$$36.4.9 \quad z \leq 0, \quad x = -\frac{3}{20}z^2, \quad 10y^2 = -4z^3.$$

Elliptic umbilic bifurcation set (codimension three): for fixed  $z$ , the section of the bifurcation set is a three-cusped astroid

$$36.4.10 \quad \begin{aligned} x &= \frac{1}{3}z^2(-\cos(2\phi) - 2\cos\phi), \\ y &= \frac{1}{3}z^2(\sin(2\phi) - 2\sin\phi), \quad 0 \leq \phi \leq 2\pi. \end{aligned}$$

Elliptic umbilic cusp lines (ribs):

$$36.4.11 \quad x + iy = -z^2 \exp\left(\frac{2}{3}i\pi m\right), \quad m = 0, 1, 2.$$

Hyperbolic umbilic bifurcation set (codimension three):

$$36.4.12 \quad \begin{aligned} x &= -\frac{1}{12}z^2(\exp(2\tau) \pm 2\exp(-\tau)), \\ y &= -\frac{1}{12}z^2(\exp(-2\tau) \pm 2\exp(\tau)), \quad -\infty \leq \tau < \infty. \end{aligned}$$

The + sign labels the cusped sheet; the - sign labels the sheet that is smooth for  $z \neq 0$  (see Figure 36.4.4).

Hyperbolic umbilic cusp line (rib):

$$36.4.13 \quad x = y = -\frac{1}{4}z^2.$$

For derivations of the results in this subsection see Poston and Stewart (1978, Chapter 9).

36.4(ii) Visualizations

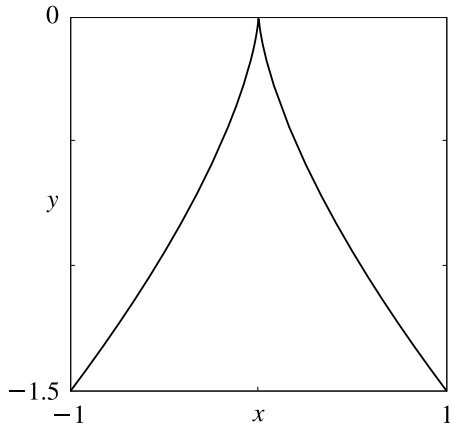


Figure 36.4.1: Bifurcation set of cusp catastrophe.

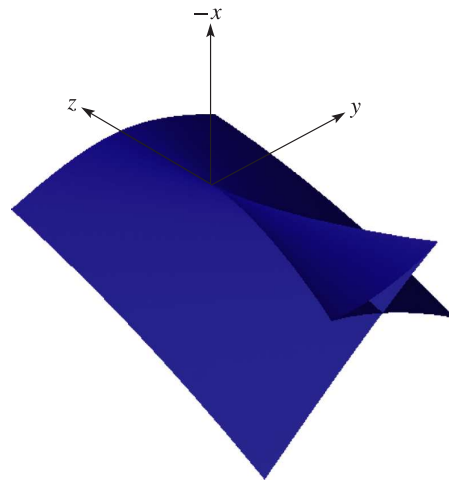


Figure 36.4.2: Bifurcation set of swallowtail catastrophe.

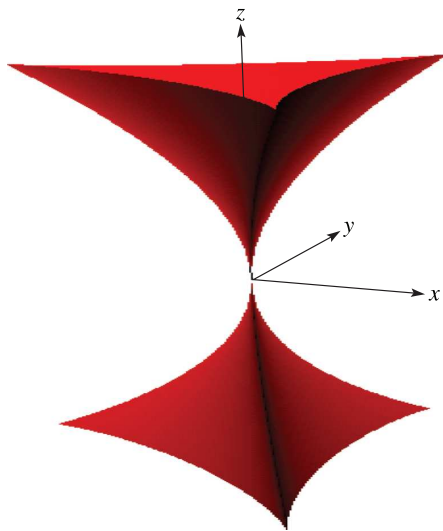


Figure 36.4.3: Bifurcation set of elliptic umbilic catastrophe.

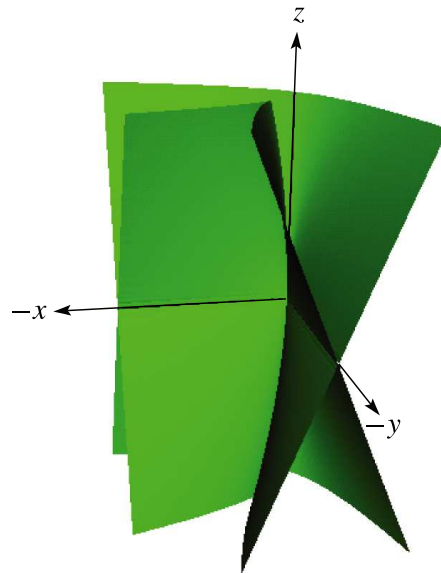


Figure 36.4.4: Bifurcation set of hyperbolic umbilic catastrophe.

36.5 Stokes Sets

36.5(i) Definitions

Stokes sets are surfaces (codimension one) in  $\mathbf{x}$  space, across which  $\Psi_K(\mathbf{x}; k)$  or  $\Psi^{(U)}(\mathbf{x}; k)$  acquires an exponentially-small asymptotic contribution (in  $k$ ), associated with a complex critical point of  $\Phi_K$  or  $\Phi^{(U)}$ . The Stokes sets are defined by the exponential domi-

nance condition:

36.5.1

$$\Re(\Phi_K(t_j(\mathbf{x}); \mathbf{x}) - \Phi_K(t_\mu(\mathbf{x}); \mathbf{x})) = 0,$$

$$\Re(\Phi^{(U)}(s_j(\mathbf{x}), t_j(\mathbf{x}); \mathbf{x}) - \Phi^{(U)}(s_\mu(\mathbf{x}), t_\mu(\mathbf{x}); \mathbf{x})) = 0,$$

where  $j$  denotes a real critical point (36.4.1) or (36.4.2), and  $\mu$  denotes a critical point with complex  $t$  or  $s, t$ , connected with  $j$  by a steepest-descent path (that is, a path where  $\Re\Phi = \text{constant}$ ) in complex  $t$  or  $(s, t)$  space.

In the following subsections, only Stokes sets involving at least one real saddle are included unless stated otherwise.

### 36.5(ii) Cuspoids

#### $K = 1$ . Airy Function

The Stokes set consists of the rays  $\text{ph } x = \pm 2\pi/3$  in the complex  $x$ -plane.

#### $K = 2$ . Cusp

The Stokes set is itself a cusped curve, connected to the cusp of the bifurcation set:

$$36.5.2 \quad y^3 = \frac{27}{4} \left( \sqrt{27} - 5 \right) x^2 = 1.32403x^2.$$

#### $K = 3$ . Swallowtail

The Stokes set takes different forms for  $z = 0$ ,  $z < 0$ , and  $z > 0$ .

For  $z = 0$ , the set consists of the two curves

$$36.5.3 \quad x = B_{\pm} |y|^{4/3}, \quad B_{\pm} = 10^{-1/3} \left( 2x_{\pm}^{4/3} - \frac{1}{2}x_{\pm}^{-2/3} \right),$$

where  $x_{\pm}$  are the two smallest positive roots of the equation

$$36.5.4 \quad 80x^5 - 40x^4 - 55x^3 + 5x^2 + 20x - 1 = 0,$$

and

$$36.5.5 \quad B_- = -1.69916, \quad B_+ = 0.33912.$$

For  $z \neq 0$ , the Stokes set is expressed in terms of scaled coordinates

$$36.5.6 \quad X = x/z^2, \quad Y = y/|z|^{3/2},$$

by

$$36.5.7 \quad X = \frac{9}{20} + 20u^4 - \frac{Y^2}{20u^2} + 6u^2 \text{sign}(z),$$

where  $u$  satisfies the equation

$$36.5.8 \quad 16u^5 - \frac{Y^2}{10u} + 4u^3 \text{sign}(z) - \frac{3}{10}|Y| \text{sign}(z) + 4t^5 + 2t^3 \text{sign}(z) + |Y|t^2 = 0,$$

in which

$$36.5.9 \quad t = -u + \left( \frac{|Y|}{10u} - u^2 - \frac{3}{10} \text{sign}(z) \right)^{1/2}.$$

For  $z < 0$ , there are two solutions  $u$ , provided that  $|Y| > (\frac{2}{5})^{1/2}$ . They generate a pair of cusp-edged sheets connected to the cusped sheets of the swallowtail bifurcation set (§36.4).

For  $z > 0$  the Stokes set has two sheets. The first sheet corresponds to  $x < 0$  and is generated as a solution of Equations (36.5.6)–(36.5.9). The second sheet corresponds to  $x > 0$  and it intersects the bifurcation set (§36.4) smoothly along the line generated by  $X = X_1 = 6.95643$ ,  $|Y| = |Y_1| = 6.81337$ . For  $|Y| > Y_1$  the second sheet is generated by a second solution of (36.5.6)–(36.5.9), and for  $|Y| < Y_1$  it is generated by the roots of the polynomial equation

$$36.5.10 \quad 160u^6 + 40u^4 = Y^2.$$

### 36.5(iii) Umbilics

#### Elliptic Umbilic Stokes Set (Codimension three)

This consists of three separate cusp-edged sheets connected to the cusp-edged sheets of the bifurcation set, and related by rotation about the  $z$ -axis by  $2\pi/3$ . One of the sheets is symmetrical under reflection in the plane  $y = 0$ , and is given by

$$36.5.11 \quad \frac{x}{z^2} = -1 - 12u^2 + 8u - \left| \frac{y}{z^2} \right| \frac{\frac{1}{3} - u}{\left( u \left( \frac{2}{3} - u \right) \right)^{1/2}}.$$

Here  $u$  is the root of the equation

#### 36.5.12

$$8u^3 - 4u^2 - \left| \frac{y}{3z^2} \right| \left( \frac{u}{\frac{2}{3} - u} \right)^{1/2} = \frac{y^2}{6wz^4} - 2w^3 - 2w^2,$$

with

$$36.5.13 \quad w = u - \frac{2}{3} + \left( \left( \frac{2}{3} - u \right)^2 + \left| \frac{y}{6z^2} \right| \left( \frac{\frac{2}{3} - u}{u} \right)^{1/2} \right)^{1/2},$$

and such that

$$36.5.14 \quad 0 < u < \frac{1}{6}.$$

#### Hyperbolic Umbilic Stokes Set (Codimension three)

This consists of a cusp-edged sheet connected to the cusp-edged sheet of the bifurcation set and intersecting the smooth sheet of the bifurcation set. With coordinates

$$36.5.15 \quad X = (x - y)/z^2, \quad Y = \frac{1}{2} + ((x + y)/z^2),$$

the intersection lines with the bifurcation set are generated by  $|X| = X_2 = 0.45148$ ,  $Y = Y_2 = 0.59693$ . Define

$$Y(u, X) = 8u - 24u^2 + X \frac{u - \frac{1}{6}}{\left( u \left( u - \frac{1}{3} \right) \right)^{1/2}},$$

#### 36.5.16

$$f(u, X) = 16u^3 - 4u^2 - \frac{1}{6}|X| \left( \frac{u}{u - \frac{1}{3}} \right)^{1/2}.$$

When  $|X| > X_2$  the Stokes set  $Y_S(X)$  is given by

$$36.5.17 \quad Y_S(X) = Y(u, |X|),$$

where  $u$  is the root of the equation

$$36.5.18 \quad f(u, X) = f\left(-u + \frac{1}{3}, X\right),$$

such that  $u > \frac{1}{3}$ . This part of the Stokes set connects two complex saddles.

Alternatively, when  $|X| < X_2$

$$36.5.19 \quad Y_S(X) = Y(-u, -|X|),$$

where  $u$  is the positive root of the equation

$$36.5.20 \quad f(-u, X) = \frac{X^2}{12w} + 4w^3 - 2w^2,$$

in which

$$36.5.21 \quad w = \left( \frac{1}{3} + u \right) \left( 1 - \left( 1 - \frac{|X|}{12u^{1/2} \left( \frac{1}{3} + u \right)^{3/2}} \right)^{1/2} \right).$$



**36.5(iv) Visualizations**

In Figures 36.5.1–36.5.6 the plane is divided into regions by the dashed curves (Stokes sets) and the continuous curves (bifurcation sets). **Red** and **blue** numbers in each region correspond, respectively, to the numbers of **real** and **complex** critical points that contribute to the asymptotics of the canonical integral away from the bifurcation sets. In Figure 36.5.4 the part of the Stokes surface inside the bifurcation set connects two complex saddles. The distribution of real and complex critical points in Figures 36.5.5 and 36.5.6 follows from consistency with Figure 36.5.1 and the fact that there are four real saddles in the inner regions.

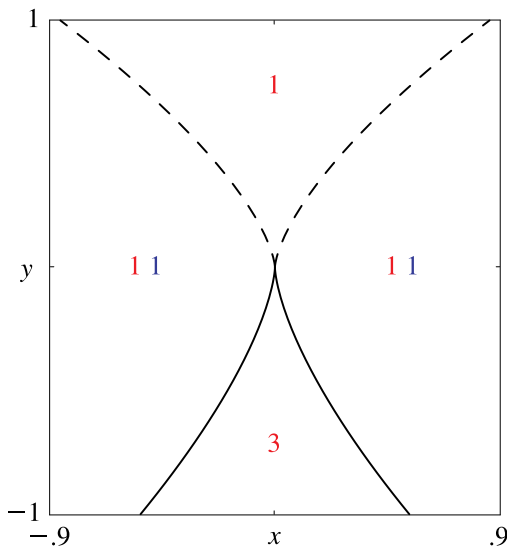


Figure 36.5.1: Cusp catastrophe.

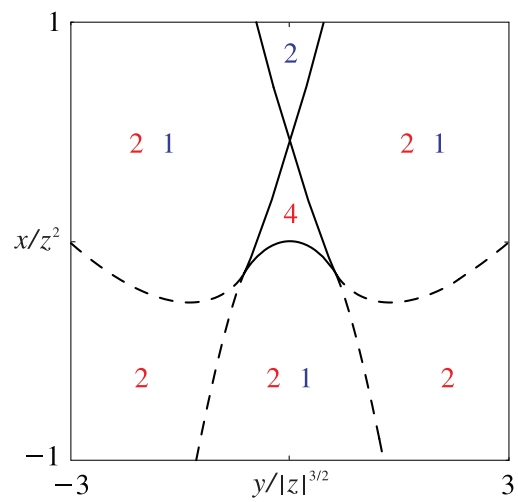


Figure 36.5.2: Swallowtail catastrophe with  $z < 0$ .

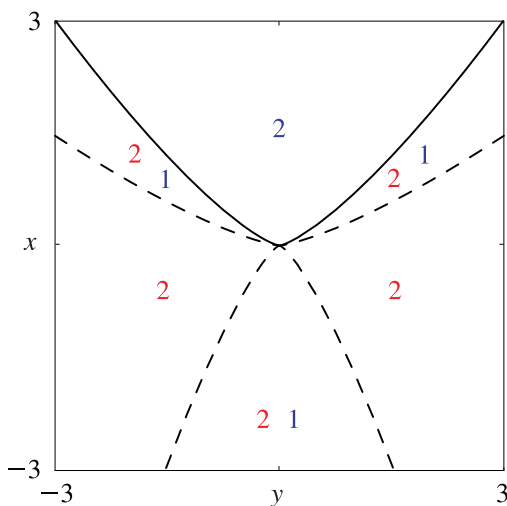


Figure 36.5.3: Swallowtail catastrophe with  $z = 0$ .

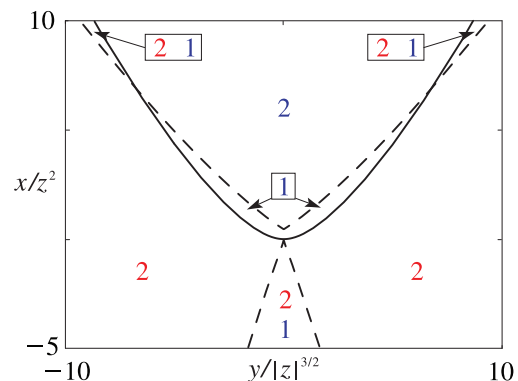


Figure 36.5.4: Swallowtail catastrophe with  $z > 0$ .

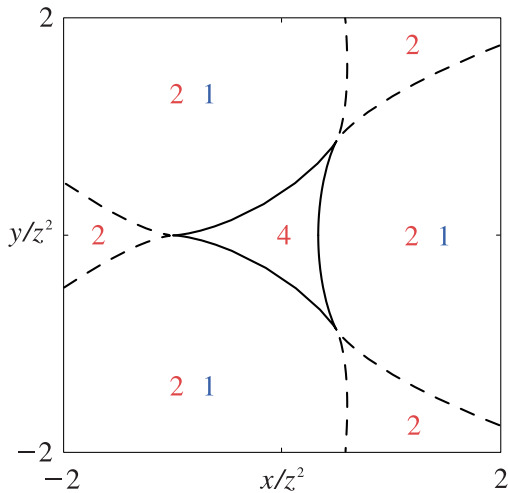


Figure 36.5.5: Elliptic umbilic catastrophe with  $z =$  constant.

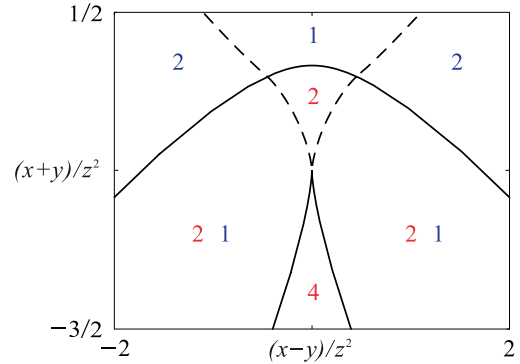


Figure 36.5.6: Hyperbolic umbilic catastrophe with  $z =$  constant.

For additional figures see <http://dlmf.nist.gov/36.5.iv>.

### 36.6 Scaling Relations

#### Diffraction Catastrophe Scaling

36.6.1 
$$\Psi_K(\mathbf{x}; k) = k^{\beta_K} \Psi_K(\mathbf{y}(k)),$$

$$\Psi^{(U)}(\mathbf{x}; k) = k^{\beta^{(U)}} \Psi^{(U)}(\mathbf{y}^{(U)}(k)),$$

where

36.6.2 cuspoids:  $\mathbf{y}(k) = (x_1 k^{\gamma_{1K}}, x_2 k^{\gamma_{2K}}, \dots, x_K k^{\gamma_{KK}}),$   
 umbilics:  $\mathbf{y}^{(U)}(k) = (x k^{2/3}, y k^{2/3}, z k^{1/3}).$

#### Indices for $k$ -Scaling of Magnitude of $\Psi_K$ or $\Psi^{(U)}$ (Singularity Index)

36.6.3 cuspoids:  $\beta_K = \frac{K}{2(K+2)},$  umbilics:  $\beta^{(U)} = \frac{1}{3}.$

#### Indices for $k$ -Scaling of Coordinates $x_m$

36.6.4 cuspoids:  $\gamma_{mK} = 1 - \frac{m}{K+2},$   
 umbilics:  $\gamma_x^{(U)} = \frac{2}{3}, \gamma_y^{(U)} = \frac{2}{3}, \gamma_z^{(U)} = \frac{1}{3}.$

#### Indices for $k$ -Scaling of $x$ Hypervolume

36.6.5 cuspoids:  $\gamma_K = \sum_{m=1}^K \gamma_{mK} = \frac{K(K+3)}{2(K+2)},$   
 umbilics:  $\gamma^{(U)} = \sum_{m=1}^3 \gamma_m^{(U)} = \frac{5}{3}.$

Table 36.6.1: Special cases of scaling exponents for cuspooids.

singularity	$K$	$\beta_K$	$\gamma_{1K}$	$\gamma_{2K}$	$\gamma_{3K}$	$\gamma_K$
fold	1	$\frac{1}{6}$	$\frac{2}{3}$	—	—	$\frac{2}{3}$
cuspid	2	$\frac{1}{4}$	$\frac{3}{4}$	$\frac{1}{2}$	—	$\frac{5}{4}$
swallowtail	3	$\frac{3}{10}$	$\frac{4}{5}$	$\frac{3}{5}$	$\frac{2}{5}$	$\frac{9}{5}$

For the results in this section and more extensive lists of exponents see Berry (1977) and Varčenko (1976).

### 36.7 Zeros

#### 36.7(i) Fold Canonical Integral

This is the Airy function  $\text{Ai}$  (§9.2).

#### 36.7(ii) Cusp Canonical Integral

This is (36.2.4) and (36.2.1) with  $K = 2.$

The zeros in Table 36.7.1 are points in the  $\mathbf{x} = (x, y)$  plane, where  $\text{ph } \Psi_2(\mathbf{x})$  is undetermined. All zeros have  $y < 0,$  and fall into two classes. Inside the cusp, that is, for  $x^2 < 8|y|^3/27,$  the zeros form pairs lying in curved rows. Close to the  $y$ -axis the approximate location of these zeros is given by

36.7.1 
$$y_m = -\sqrt{2\pi(2m+1)}, \quad m = 1, 2, 3, \dots,$$

$$x_{m,n}^{\pm} = \sqrt{\frac{2}{-y_m}} \left( 2n + \frac{1}{2} + (-1)^m \frac{1}{2} \pm \frac{1}{4} \right) \pi,$$

$$m = 1, 2, 3, \dots, n = 0, \pm 1, \pm 2, \dots$$

Table 36.7.1: Zeros of cusp diffraction catastrophe to 5D.

Zeros $\left\{ \begin{smallmatrix} x \\ y \end{smallmatrix} \right\}$ inside, and zeros $\left[ \begin{smallmatrix} x \\ y \end{smallmatrix} \right]$ outside, the cusp $x^2 = \frac{8}{27} y ^3$ .					
$\left\{ \begin{smallmatrix} \pm 0.52768 \\ -4.37804 \end{smallmatrix} \right\}$	$\left[ \begin{smallmatrix} \pm 2.35218 \\ -1.74360 \end{smallmatrix} \right]$				
$\left\{ \begin{smallmatrix} \pm 1.41101 \\ -5.55470 \end{smallmatrix} \right\}$	$\left\{ \begin{smallmatrix} \pm 2.36094 \\ -5.52321 \end{smallmatrix} \right\}$	$\left[ \begin{smallmatrix} \pm 4.42707 \\ -3.05791 \end{smallmatrix} \right]$			
$\left\{ \begin{smallmatrix} \pm 0.43039 \\ -6.64285 \end{smallmatrix} \right\}$	$\left\{ \begin{smallmatrix} \pm 3.06389 \\ -6.44624 \end{smallmatrix} \right\}$	$\left\{ \begin{smallmatrix} \pm 3.95806 \\ -6.40312 \end{smallmatrix} \right\}$	$\left[ \begin{smallmatrix} \pm 6.16185 \\ -4.03551 \end{smallmatrix} \right]$		
$\left\{ \begin{smallmatrix} \pm 1.21605 \\ -7.49906 \end{smallmatrix} \right\}$	$\left\{ \begin{smallmatrix} \pm 2.02922 \\ -7.48629 \end{smallmatrix} \right\}$	$\left\{ \begin{smallmatrix} \pm 4.56537 \\ -7.19629 \end{smallmatrix} \right\}$	$\left\{ \begin{smallmatrix} \pm 5.42206 \\ -7.14718 \end{smallmatrix} \right\}$	$\left[ \begin{smallmatrix} \pm 7.72352 \\ -4.84817 \end{smallmatrix} \right]$	
$\left\{ \begin{smallmatrix} \pm 0.38488 \\ -8.31916 \end{smallmatrix} \right\}$	$\left\{ \begin{smallmatrix} \pm 2.71193 \\ -8.22315 \end{smallmatrix} \right\}$	$\left\{ \begin{smallmatrix} \pm 3.49286 \\ -8.20326 \end{smallmatrix} \right\}$	$\left\{ \begin{smallmatrix} \pm 5.96669 \\ -7.85723 \end{smallmatrix} \right\}$	$\left\{ \begin{smallmatrix} \pm 6.79538 \\ -7.80456 \end{smallmatrix} \right\}$	$\left[ \begin{smallmatrix} \pm 9.17308 \\ -5.55831 \end{smallmatrix} \right]$

More general asymptotic formulas are given in Kaminski and Paris (1999). Just outside the cusp, that is, for  $x^2 > 8|y|^3/27$ , there is a single row of zeros on each side. With  $n = 0, 1, 2, \dots$ , they are located approximately at

36.7.2 
$$x_n = \pm \left(\frac{8}{27}\right)^{1/2} |y_n|^{3/2} (1 + \xi_n),$$

$$y_n = - \left(\frac{3\pi(8n+5)}{9+8\xi_n}\right)^{1/2},$$

where  $\xi_n$  is the real solution of

36.7.3 
$$\frac{3\pi(8n+5)}{9+8\xi_n} \xi_n^{3/2} = \frac{27}{16} \left(\frac{3}{2}\right)^{1/2} \left(\ln\left(\frac{1}{\xi_n}\right) + 3\ln\left(\frac{3}{2}\right)\right).$$

For a more extensive asymptotic analysis and further tabulations, see Kaminski and Paris (1999).

**36.7(iii) Elliptic Umbilic Canonical Integral**

This is (36.2.5) with (36.2.2). The zeros are lines in  $\mathbf{x} = (x, y, z)$  space where  $\text{ph } \Psi^{(E)}(\mathbf{x})$  is undetermined. Deep inside the bifurcation set, that is, inside the three-cusped astroid (36.4.10) and close to the part of the  $z$ -axis that is far from the origin, the zero contours form an array of rings close to the planes

36.7.4 
$$z_n = \pm 3\left(\frac{1}{4}\pi(2n - \frac{1}{2})\right)^{1/3}$$

$$= 3.48734(n - \frac{1}{4})^{1/3}, \quad n = 1, 2, 3, \dots$$

Near  $z = z_n$ , and for small  $x$  and  $y$ , the modulus  $|\Psi^{(E)}(\mathbf{x})|$  has the symmetry of a lattice with a rhombohedral unit cell that has a mirror plane and an inverse

threefold axis whose  $z$  and  $x$  repeat distances are given by

36.7.5 
$$\Delta z = \frac{9\pi}{2z_n^2}, \quad \Delta x = \frac{6\pi}{z_n}.$$

The zeros are approximated by solutions of the equation

36.7.6 
$$\exp\left(-2\pi i \left(\frac{z - z_n}{\Delta z} + \frac{2x}{\Delta x}\right)\right)$$

$$\times \left(2 \exp\left(\frac{-6\pi i x}{\Delta x}\right) \cos\left(\frac{2\sqrt{3}\pi y}{\Delta x}\right) + 1\right)$$

$$= \sqrt{3}.$$

The rings are almost circular (radii close to  $(\Delta x)/9$  and varying by less than 1%), and almost flat (deviating from the planes  $z_n$  by at most  $(\Delta z)/36$ ). Away from the  $z$ -axis and approaching the cusp lines (ribs) (36.4.11), the lattice becomes distorted and the rings are deformed, eventually joining to form “hairpins” whose arms become the pairs of zeros (36.7.1) of the cusp canonical integral. In the symmetry planes (e.g.,  $y = 0$ ), the number of rings in the  $m$ th row, measured from the origin and before the transition to hairpins, is given by

36.7.7 
$$n_{\max}(m) = \lfloor \frac{256}{13}m - \frac{269}{52} \rfloor.$$

Outside the bifurcation set (36.4.10), each rib is flanked by a series of zero lines in the form of curly “antelope horns” related to the “outside” zeros (36.7.2) of the cusp canonical integral. There are also three sets of zero lines in the plane  $z = 0$  related by  $2\pi/3$  rotation; these are zeros of (36.2.20), whose asymptotic form in polar coordinates ( $x = r \cos \theta$ ,  $y = r \sin \theta$ ) is given by

36.7.8 
$$r = 3 \left(\frac{(2n-1)\pi}{4|\sin(\frac{3}{2}\theta)|}\right)^{2/3} (1 + O(n^{-1})), \quad n \rightarrow \infty.$$

**36.7(iv) Swallowtail and Hyperbolic Umbilic Canonical Integrals**

The zeros of these functions are curves in  $\mathbf{x} = (x, y, z)$  space; see Nye (2007) for  $\Phi_3$  and Nye (2006) for  $\Phi^{(H)}$ .

**36.8 Convergent Series Expansions**

$$\begin{aligned}
 \Psi_K(\mathbf{x}) &= \frac{2}{K+2} \sum_{n=0}^{\infty} \exp\left(i \frac{\pi(2n+1)}{2(K+2)}\right) \Gamma\left(\frac{2n+1}{K+2}\right) a_{2n}(\mathbf{x}), & K \text{ even,} \\
 \Psi_K(\mathbf{x}) &= \frac{2}{K+2} \sum_{n=0}^{\infty} i^n \cos\left(\frac{\pi(n(K+1)-1)}{2(K+2)}\right) \Gamma\left(\frac{n+1}{K+2}\right) a_n(\mathbf{x}), & K \text{ odd,}
 \end{aligned}$$

where

$$36.8.2 \quad a_0(\mathbf{x}) = 1, \quad a_{n+1}(\mathbf{x}) = \frac{i}{n+1} \sum_{p=0}^{\min(n, K-1)} (p+1)x_{p+1}a_{n-p}(\mathbf{x}), \quad n = 0, 1, 2, \dots$$

For multinomial power series for  $\Psi_K(\mathbf{x})$ , see Connor and Curtis (1982).

$$\begin{aligned}
 36.8.3 \quad \frac{3^{2/3}}{4\pi^2} \Psi^{(H)}\left(3^{1/3}\mathbf{x}\right) &= \text{Ai}(x) \text{Ai}(y) \sum_{n=0}^{\infty} (-3^{-1/3}iz)^n \frac{c_n(x)c_n(y)}{n!} + \text{Ai}(x) \text{Ai}'(y) \sum_{n=2}^{\infty} (-3^{-1/3}iz)^n \frac{c_n(x)d_n(y)}{n!} \\
 &+ \text{Ai}'(x) \text{Ai}(y) \sum_{n=2}^{\infty} (-3^{-1/3}iz)^n \frac{d_n(x)c_n(y)}{n!} + \text{Ai}'(x) \text{Ai}'(y) \sum_{n=1}^{\infty} (-3^{-1/3}iz)^n \frac{d_n(x)d_n(y)}{n!},
 \end{aligned}$$

and

$$36.8.4 \quad \Psi^{(E)}(\mathbf{x}) = 2\pi^2 \left(\frac{2}{3}\right)^{2/3} \sum_{n=0}^{\infty} \frac{(-i(2/3)^{2/3}z)^n}{n!} \Re\left(f_n\left(\frac{x+iy}{12^{1/3}}, \frac{x-iy}{12^{1/3}}\right)\right),$$

where

$$\begin{aligned}
 36.8.5 \quad f_n(\zeta, \zeta^*) &= c_n(\zeta)c_n(\zeta^*) \text{Ai}(\zeta) \text{Bi}(\zeta^*) + c_n(\zeta)d_n(\zeta^*) \text{Ai}(\zeta) \text{Bi}'(\zeta^*) + d_n(\zeta)c_n(\zeta^*) \text{Ai}'(\zeta) \text{Bi}(\zeta^*) + d_n(\zeta)d_n(\zeta^*) \text{Ai}'(\zeta) \text{Bi}'(\zeta^*),
 \end{aligned}$$

with asterisks denoting complex conjugates, and

$$36.8.6 \quad c_0(t) = 1, \quad d_0(t) = 0, \quad c_{n+1}(t) = c'_n(t) + td_n(t), \quad d_{n+1}(t) = c_n(t) + d'_n(t).$$

**36.9 Integral Identities**

$$36.9.1 \quad |\Psi_1(x)|^2 = 2^{5/3} \int_0^{\infty} \Psi_1\left(2^{2/3}(3u^2 + x)\right) du;$$

equivalently,

$$36.9.2 \quad (\text{Ai}(x))^2 = \frac{2^{2/3}}{\pi} \int_0^{\infty} \text{Ai}\left(2^{2/3}(u^2 + x)\right) du.$$

$$36.9.3 \quad |\Psi_1(x)|^2 = \sqrt{\frac{8\pi}{3}} \int_0^{\infty} u^{-1/2} \cos\left(2u(x + u^2) + \frac{1}{4}\pi\right) du.$$

$$36.9.4 \quad |\Psi_2(x, y)|^2 = \int_0^{\infty} \left(\Psi_1\left(\frac{4u^3 + 2uy + x}{u^{1/3}}\right) + \Psi_1\left(\frac{4u^3 + 2uy - x}{u^{1/3}}\right)\right) \frac{du}{u^{1/3}}.$$

$$36.9.5 \quad |\Psi_2(x, y)|^2 = 2 \int_0^{\infty} \cos(2xu) \Psi_1\left(2u^{2/3}(y + 2u^2)\right) \frac{du}{u^{1/3}}.$$

$$36.9.6 \quad |\Psi_3(x, y, z)|^2 = 2^{4/5} \int_{-\infty}^{\infty} \Psi_3\left(2^{4/5}(x + 2uy + 3u^2z + 5u^4), 0, 2^{2/5}(z + 10u^2)\right) du.$$

$$36.9.7 \quad |\Psi_3(x, y, z)|^2 = \frac{2^{7/4}}{5^{1/4}} \int_0^{\infty} \Re\left(e^{2iu(u^4 + zu^2 + x)} \Psi_2\left(\frac{2^{7/4}}{5^{1/4}}yu^{3/4}, \sqrt{\frac{2u}{5}}(3z + 10u^2)\right)\right) \frac{du}{u^{1/4}}.$$

$$36.9.8 \quad \left| \Psi^{(H)}(x, y, z) \right|^2 = 8\pi^2 \left( \frac{2}{9} \right)^{1/3} \int_{-\infty}^{\infty} \int_{-\infty}^{\infty} \text{Ai} \left( \left( \frac{4}{3} \right)^{1/3} (x + zv + 3u^2) \right) \text{Ai} \left( \left( \frac{4}{3} \right)^{1/3} (y + zu + 3v^2) \right) du dv.$$

$$36.9.9 \quad \left| \Psi^{(E)}(x, y, z) \right|^2 = \frac{8\pi^2}{3^{2/3}} \int_0^{\infty} \int_0^{2\pi} \Re \left( \text{Ai} \left( \frac{1}{3^{1/3}} (x + iy + 2zu \exp(i\theta) + 3u^2 \exp(-2i\theta)) \right) \right) \times \text{Bi} \left( \frac{1}{3^{1/3}} (x - iy + 2zu \exp(-i\theta) + 3u^2 \exp(2i\theta)) \right) u du d\theta.$$

For these results and also integrals over doubly-infinite intervals see [Berry and Wright \(1980\)](#). This reference also provides a physical interpretation in terms of Lagrangian manifolds and Wigner functions in phase space.

### 36.10 Differential Equations

#### 36.10(i) Equations for $\Psi_K(\mathbf{x})$

In terms of the normal form (36.2.1) the  $\Psi_K(\mathbf{x})$  satisfy the operator equation

$$36.10.1 \quad \Phi'_K \left( -i \frac{\partial}{\partial x_1}; \mathbf{x} \right) \Psi_K(\mathbf{x}) = 0,$$

or explicitly,

$$36.10.2 \quad \frac{\partial^{K+1} \Psi_K(\mathbf{x})}{\partial x_1^{K+1}} + \sum_{m=1}^K (-i)^{m-K-2} \left( \frac{m x_m}{K+2} \right) \frac{\partial^{m-1} \Psi_K(\mathbf{x})}{\partial x_1^{m-1}} = 0.$$

#### Special Cases

$K = 1$ , fold: (36.10.1) becomes Airy's equation (§9.2(i))

$$36.10.3 \quad \frac{\partial^2 \Psi_1}{\partial x^2} - \frac{x}{3} \Psi_1 = 0.$$

$K = 2$ , cusp:

$$36.10.4 \quad \frac{\partial^3 \Psi_2}{\partial x^3} - \frac{1}{2} y \frac{\partial \Psi_2}{\partial x} - \frac{i}{4} x \Psi_2 = 0.$$

$K = 3$ , swallowtail:

$$36.10.5 \quad \frac{\partial^4 \Psi_3}{\partial x^4} - \frac{3}{5} z \frac{\partial^2 \Psi_3}{\partial x^2} - \frac{2i}{5} y \frac{\partial \Psi_3}{\partial x} + \frac{1}{5} x \Psi_3 = 0.$$

#### 36.10(ii) Partial Derivatives with Respect to the $x_n$

$$36.10.6 \quad \frac{\partial^{ln} \Psi_K}{\partial x_m^{ln}} = i^{n(l-m)} \frac{\partial^{mn} \Psi_K}{\partial x_l^{mn}}, \quad 1 \leq m \leq K, 1 \leq l \leq K.$$

#### Special Cases

$K = 1$ , fold: (36.10.6) is an identity.

$K = 2$ , cusp:

$$36.10.7 \quad \frac{\partial^{2n} \Psi_2}{\partial x^{2n}} = i^n \frac{\partial^n \Psi_2}{\partial y^n}.$$

$K = 3$ , swallowtail:

$$36.10.8 \quad \frac{\partial^{2n} \Psi_3}{\partial x^{2n}} = i^n \frac{\partial^n \Psi_3}{\partial y^n},$$

$$36.10.9 \quad \frac{\partial^{3n} \Psi_3}{\partial x^{3n}} = (-1)^n \frac{\partial^n \Psi_3}{\partial z^n},$$

$$36.10.10 \quad \frac{\partial^{3n} \Psi_3}{\partial y^{3n}} = i^n \frac{\partial^{2n} \Psi_3}{\partial z^{2n}}.$$

#### 36.10(iii) Operator Equations

In terms of the normal forms (36.2.2) and (36.2.3), the  $\Psi^{(U)}(\mathbf{x})$  satisfy the following operator equations

$$36.10.11 \quad \Phi_s^{(U)} \left( -i \frac{\partial}{\partial x}, -i \frac{\partial}{\partial y}; \mathbf{x} \right) \Psi^{(U)}(\mathbf{x}) = 0,$$

$$36.10.11 \quad \Phi_t^{(U)} \left( -i \frac{\partial}{\partial x}, -i \frac{\partial}{\partial y}; \mathbf{x} \right) \Psi^{(U)}(\mathbf{x}) = 0,$$

where

$$36.10.12 \quad \Phi_s^{(U)}(s, t; \mathbf{x}) = \frac{\partial}{\partial s} \Phi^{(U)}(s, t; \mathbf{x}),$$

$$36.10.12 \quad \Phi_t^{(U)}(s, t; \mathbf{x}) = \frac{\partial}{\partial t} \Phi^{(U)}(s, t; \mathbf{x}).$$

Explicitly,

$$36.10.13 \quad 6 \frac{\partial^2 \Psi^{(E)}}{\partial x \partial y} - 2iz \frac{\partial \Psi^{(E)}}{\partial y} + y \Psi^{(E)} = 0,$$

$$36.10.14 \quad 3 \left( \frac{\partial^2 \Psi^{(E)}}{\partial x^2} - \frac{\partial^2 \Psi^{(E)}}{\partial y^2} \right) + 2iz \frac{\partial \Psi^{(H)}}{\partial x} - x \Psi^{(E)} = 0.$$

$$36.10.15 \quad 3 \frac{\partial^2 \Psi^{(H)}}{\partial x^2} + iz \frac{\partial \Psi^{(H)}}{\partial y} - x \Psi^{(H)} = 0,$$

$$36.10.16 \quad 3 \frac{\partial^2 \Psi^{(H)}}{\partial y^2} + iz \frac{\partial \Psi^{(H)}}{\partial x} - y \Psi^{(H)} = 0.$$

#### 36.10(iv) Partial $z$ -Derivatives

$$36.10.17 \quad i \frac{\partial \Psi^{(E)}}{\partial z} = \frac{\partial^2 \Psi^{(E)}}{\partial x^2} + \frac{\partial^2 \Psi^{(E)}}{\partial y^2},$$

$$36.10.18 \quad i \frac{\partial \Psi^{(H)}}{\partial z} = \frac{\partial^2 \Psi^{(H)}}{\partial x \partial y}.$$

Equation (36.10.17) is the *paraxial wave equation*.

### 36.11 Leading-Order Asymptotics

With real critical points (36.4.1) ordered so that

$$36.11.1 \quad t_1(\mathbf{x}) < t_2(\mathbf{x}) < \dots < t_{j_{\max}}(\mathbf{x}),$$

and far from the bifurcation set, the cuspid canonical integrals are approximated by

$$36.11.2 \quad \Psi_K(\mathbf{x}) = \sqrt{2\pi} \sum_{j=1}^{j_{\max}(\mathbf{x})} \exp(i(\Phi_K(t_j(\mathbf{x}); \mathbf{x}) + \frac{1}{4}\pi(-1)^{j+K+1})) \left| \frac{\partial^2 \Phi_K(t_j(\mathbf{x}); \mathbf{x})}{\partial t^2} \right|^{-1/2} (1 + o(1)).$$

#### Asymptotics along Symmetry Lines

$$36.11.3 \quad \Psi_2(0, y) = \begin{cases} \sqrt{\pi/y} (\exp(\frac{1}{4}i\pi) + o(1)), & y \rightarrow +\infty, \\ \sqrt{\pi/|y|} \exp(-\frac{1}{4}i\pi) (1 + i\sqrt{2} \exp(-\frac{1}{4}iy^2) + o(1)), & y \rightarrow -\infty. \end{cases}$$

$$36.11.4 \quad \Psi_3(x, 0, 0) = \frac{\sqrt{2\pi}}{(5|x|^3)^{1/8}} \begin{cases} \exp(-2\sqrt{2}(x/5)^{5/4}) (\cos(2\sqrt{2}(x/5)^{5/4} - \frac{1}{8}\pi) + o(1)), & x \rightarrow +\infty, \\ \cos(4(|x|/5)^{5/4} - \frac{1}{4}\pi) + o(1), & x \rightarrow -\infty. \end{cases}$$

$$36.11.5 \quad \Psi_3(0, y, 0) = \Psi_3^*(0, -y, 0) = \exp(\frac{1}{4}i\pi) \sqrt{\pi/y} \left( 1 - (i/\sqrt{3}) \exp(\frac{3}{2}i(2y/5)^{5/3}) + o(1) \right), \quad y \rightarrow +\infty.$$

$$36.11.6 \quad \Psi_3(0, 0, z) = \frac{\Gamma(\frac{1}{3})}{|z|^{1/3}\sqrt{3}} + \begin{cases} o(1), & z \rightarrow +\infty, \\ \frac{2\sqrt{\pi}5^{1/4}}{(3|z|)^{3/4}} \left( \cos\left(\frac{2}{3}\left(\frac{3|z|}{5}\right)^{5/2} - \frac{1}{4}\pi\right) + o(1) \right), & z \rightarrow -\infty. \end{cases}$$

$$36.11.7 \quad \Psi^{(E)}(0, 0, z) = \frac{\pi}{z} \left( i + \sqrt{3} \exp\left(\frac{4}{27}iz^3\right) + o(1) \right), \quad z \rightarrow \pm\infty,$$

$$36.11.8 \quad \Psi^{(H)}(0, 0, z) = \frac{2\pi}{z} \left( 1 - \frac{i}{\sqrt{3}} \exp\left(\frac{1}{27}iz^3\right) + o(1) \right), \quad z \rightarrow \pm\infty.$$

## Applications

### 36.12 Uniform Approximation of Integrals

#### 36.12(i) General Theory for Cuspoids

The canonical integrals (36.2.4) provide a basis for uniform asymptotic approximations of oscillatory integrals. In the cuspid case (one integration variable)

$$36.12.1 \quad I(\mathbf{y}, k) = \int_{-\infty}^{\infty} \exp(ikf(u; \mathbf{y}))g(u, \mathbf{y}) du,$$

where  $k$  is a large real parameter and  $\mathbf{y} = \{y_1, y_2, \dots\}$  is a set of additional (nonasymptotic) parameters. As  $\mathbf{y}$

varies as many as  $K + 1$  (real or complex) critical points of the smooth phase function  $f$  can coalesce in clusters of two or more. The function  $g$  has a smooth amplitude. Also,  $f$  is real analytic, and  $\partial^{K+2}f/\partial u^{K+2} > 0$  for all  $\mathbf{y}$  such that all  $K + 1$  critical points coincide. If  $\partial^{K+2}f/\partial u^{K+2} < 0$ , then we may evaluate the complex conjugate of  $I$  for real values of  $\mathbf{y}$  and  $g$ , and obtain  $I$  by conjugation and analytic continuation. The critical points  $u_j(\mathbf{y})$ ,  $1 \leq j \leq K + 1$ , are defined by

$$36.12.2 \quad \frac{\partial}{\partial u} f(u_j(\mathbf{y}); \mathbf{y}) = 0.$$

The leading-order uniform asymptotic approximation is given by

$$36.12.3 \quad I(\mathbf{y}, k) = \frac{\exp(ikA(\mathbf{y}))}{k^{1/(K+2)}} \sum_{m=0}^K \frac{a_m(\mathbf{y})}{k^{m/(K+2)}} \left( \delta_{m,0} - (1 - \delta_{m,0}) i \frac{\partial}{\partial z_m} \right) \Psi_K(\mathbf{z}(\mathbf{y}; k)) \left( 1 + O\left(\frac{1}{k}\right) \right),$$

where  $A(\mathbf{y})$ ,  $\mathbf{z}(\mathbf{y}, k)$ ,  $a_m(\mathbf{y})$  are as follows. Define a mapping  $u(t; \mathbf{y})$  by relating  $f(u; \mathbf{y})$  to the normal form (36.2.1) of  $\Phi_K(t; \mathbf{x})$  in the following way:

**36.12.4**  $f(u(t, \mathbf{y}); \mathbf{y}) = A(\mathbf{y}) + \Phi_K(t; \mathbf{x}(\mathbf{y})),$

with the  $K + 1$  functions  $A(\mathbf{y})$  and  $\mathbf{x}(\mathbf{y})$  determined by correspondence of the  $K + 1$  critical points of  $f$  and  $\Phi_K$ . Then

**36.12.5**  $f(u_j(\mathbf{y}); \mathbf{y}) = A(\mathbf{y}) + \Phi_K(t_j(\mathbf{x}(\mathbf{y})); \mathbf{x}(\mathbf{y})),$

where  $t_j(\mathbf{x})$ ,  $1 \leq j \leq K + 1$ , are the critical points of  $\Phi_K$ , that is, the solutions (real and complex) of (36.4.1). Correspondence between the  $u_j(\mathbf{y})$  and the  $t_j(\mathbf{x})$  is established by the order of critical points along the real axis when  $\mathbf{y}$  and  $\mathbf{x}$  are such that these critical points are all real, and by continuation when some or all of the critical points are complex. The branch for  $\mathbf{x}(\mathbf{y})$  is such that  $\mathbf{x}$  is real when  $\mathbf{y}$  is real. In consequence,

**36.12.6**  $A(\mathbf{y}) = f(u(0, \mathbf{y}); \mathbf{y}),$

**36.12.7**  $\mathbf{z}(\mathbf{y}; k) = \{z_1(\mathbf{y}; k), z_2(\mathbf{y}; k), \dots, z_K(\mathbf{y}; k)\},$   
 $z_m(\mathbf{y}; k) = x_m(\mathbf{y})k^{1-(m/(K+2))},$

**36.12.8**

$$a_m(\mathbf{y}) = \sum_{n=1}^{K+1} \frac{P_{mn}(\mathbf{y})G_n(\mathbf{y})}{(t_n(\mathbf{x}(\mathbf{y})))^{m+1} \prod_{\substack{l=1 \\ l \neq n}}^{K+1} (t_n(\mathbf{x}(\mathbf{y})) - t_l(\mathbf{x}(\mathbf{y})))},$$

where

**36.12.9**  $P_{mn}(\mathbf{y}) = (t_n(\mathbf{x}(\mathbf{y})))^{K+1}$   
 $+ \sum_{l=m+2}^K \frac{l}{K+2} x_l(\mathbf{y})(t_n(\mathbf{x}(\mathbf{y})))^{l-1},$

and

**36.12.10**

$$G_n(\mathbf{y}) = g(t_n(\mathbf{y}), \mathbf{y}) \sqrt{\frac{\partial^2 \Phi_K(t_n(\mathbf{x}(\mathbf{y})); \mathbf{x}(\mathbf{y}))/\partial t^2}{\partial^2 f(u_n(\mathbf{y}))/\partial u^2}}.$$

In (36.12.10), both second derivatives vanish when critical points coalesce, but their ratio remains finite. The square roots are real and positive when  $\mathbf{y}$  is such that all the critical points are real, and are defined by analytic continuation elsewhere. The quantities  $a_m(\mathbf{y})$  are real for real  $\mathbf{y}$  when  $g$  is real analytic.

This technique can be applied to generate a hierarchy of approximations for the diffraction catastrophes  $\Psi_K(\mathbf{x}; k)$  in (36.2.10) away from  $\mathbf{x} = 0$ , in terms of canonical integrals  $\Psi_J(\xi(\mathbf{x}; k))$  for  $J < K$ . For example, the diffraction catastrophe  $\Psi_2(x, y; k)$  defined by (36.2.10), and corresponding to the Pearcey integral (36.2.14), can be approximated by the Airy function  $\Psi_1(\xi(x, y; k))$  when  $k$  is large, provided that  $x$  and  $y$  are not small. For details of this example, see Paris (1991).

For further information see Berry and Howls (1993).

**36.12(ii) Special Case**

For  $K = 1$ , with a single parameter  $y$ , let the two critical points of  $f(u; y)$  be denoted by  $u_{\pm}(y)$ , with  $u_+ > u_-$  for those values of  $y$  for which these critical points are real. Then

**36.12.11** 
$$I(y, k) = \frac{\Delta^{1/4} \pi \sqrt{2}}{k^{1/3}} \exp(ik\tilde{f}) \left( \left( \frac{g_+}{\sqrt{f''_+}} + \frac{g_-}{\sqrt{-f''_-}} \right) \text{Ai}(-k^{2/3}\Delta) \left( 1 + O\left(\frac{1}{k}\right) \right) \right.$$
  

$$\left. - i \left( \frac{g_+}{\sqrt{f''_+}} - \frac{g_-}{\sqrt{-f''_-}} \right) \frac{\text{Ai}'(-k^{2/3}\Delta)}{k^{1/3} \Delta^{1/2}} \left( 1 + O\left(\frac{1}{k}\right) \right) \right),$$

where

$$\tilde{f} = \frac{1}{2}(f(u_+(y), y) + f(u_-(y), y)),$$
  
**36.12.12** 
$$g_{\pm} = g(u_{\pm}(y), y), \quad f''_{\pm} = \frac{\partial^2}{\partial u^2} f(u_{\pm}(y), y),$$
  

$$\Delta = \left( \frac{3}{4}(f(u_-(y), y) - f(u_+(y), y)) \right)^{2/3}.$$

For Ai and Ai' see §9.2. Branches are chosen so that  $\Delta$  is real and positive if the critical points are real, or real and negative if they are complex. The coefficients of Ai and Ai' are real if  $y$  is real and  $g$  is real analytic. Also,  $\Delta^{1/4}/\sqrt{f''_+}$  and  $\Delta^{1/4}/\sqrt{-f''_-}$  are chosen to be positive real when  $y$  is such that both critical points are real,

and by analytic continuation otherwise.

**36.12(iii) Additional References**

For further information concerning integrals with several coalescing saddle points see Arnol'd *et al.* (1988), Berry and Howls (1993, 1994), Bleistein (1967), Duijstermaat (1974), Ludwig (1966), Olde Daalhuis (2000), and Ursell (1972, 1980).

**36.13 Kelvin's Ship-Wave Pattern**

A ship moving with constant speed  $V$  on deep water generates a surface gravity wave. In a reference frame

where the ship is at rest we use polar coordinates  $r$  and  $\phi$  with  $\phi = 0$  in the direction of the velocity of the water relative to the ship. Then with  $g$  denoting the acceleration due to gravity, the wave height is approximately given by

$$36.13.1 \quad z(\phi, \rho) = \int_{-\pi/2}^{\pi/2} \cos\left(\rho \frac{\cos(\theta + \phi)}{\cos^2 \theta}\right) d\theta,$$

where

$$36.13.2 \quad \rho = gr/V^2.$$

The integral is of the form of the real part of (36.12.1) with  $y = \phi$ ,  $u = \theta$ ,  $g = 1$ ,  $k = \rho$ , and

$$36.13.3 \quad f(\theta, \phi) = -\frac{\cos(\theta + \phi)}{\cos^2 \theta}.$$

When  $\rho > 1$ , that is, everywhere except close to the ship, the integrand oscillates rapidly. There are two stationary points, given by

$$36.13.4 \quad \begin{aligned} \theta_+(\phi) &= \frac{1}{2}(\arcsin(3 \sin \phi) - \phi), \\ \theta_-(\phi) &= \frac{1}{2}(\pi - \phi - \arcsin(3 \sin \phi)). \end{aligned}$$

These coalesce when

$$36.13.5 \quad |\phi| = \phi_c = \arcsin\left(\frac{1}{3}\right) = 19^\circ.47122.$$

This is the angle of the familiar V-shaped wake. The wake is a caustic of the “rays” defined by the dispersion relation (“Hamiltonian”) giving the frequency  $\omega$  as a function of wavevector  $\mathbf{k}$ :

$$36.13.6 \quad \omega(\mathbf{k}) = \sqrt{gk} + \mathbf{V} \cdot \mathbf{k}.$$

Here  $k = |\mathbf{k}|$ , and  $\mathbf{V}$  is the ship velocity (so that  $\mathbf{V} = |\mathbf{V}|$ ).

The disturbance  $z(\rho, \phi)$  can be approximated by the method of uniform asymptotic approximation for the case of two coalescing stationary points (36.12.11), using the fact that  $\theta_{\pm}(\phi)$  are real for  $|\phi| < \phi_c$  and complex for  $|\phi| > \phi_c$ . (See also §2.4(v).) Then with the definitions (36.12.12), and the real functions

$$36.13.7 \quad \begin{aligned} u(\phi) &= \sqrt{\frac{\Delta^{1/2}(\phi)}{2}} \left( \frac{1}{\sqrt{f'_+(\phi)}} + \frac{1}{\sqrt{-f'_-(\phi)}} \right), \\ v(\phi) &= \sqrt{\frac{1}{2\Delta^{1/2}(\phi)}} \left( \frac{1}{\sqrt{f'_+(\phi)}} - \frac{1}{\sqrt{-f'_-(\phi)}} \right), \end{aligned}$$

the disturbance is

$$36.13.8 \quad \begin{aligned} z(\rho, \phi) &= 2\pi \left( \rho^{-1/3} u(\phi) \cos(\rho \tilde{f}(\phi)) \text{Ai}\left(-\rho^{2/3} \Delta(\phi)\right) \right. \\ &\quad \times (1 + O(1/\rho)) \\ &\quad \left. + \rho^{-2/3} v(\phi) \sin(\rho \tilde{f}(\phi)) \text{Ai}'\left(-\rho^{2/3} \Delta(\phi)\right) \right. \\ &\quad \left. \times (1 + O(1/\rho)) \right), \quad \rho \rightarrow \infty. \end{aligned}$$

See Figure 36.13.1.

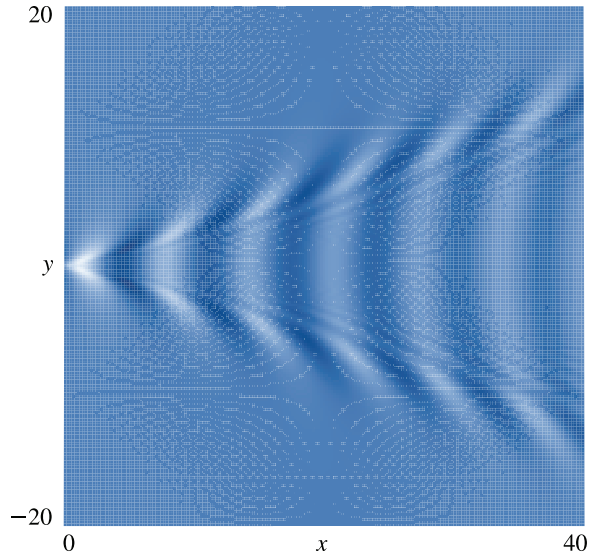


Figure 36.13.1: Kelvin’s ship wave pattern, computed from the uniform asymptotic approximation (36.13.8), as a function of  $x = \rho \cos \phi$ ,  $y = \rho \sin \phi$ .

For further information see Lord Kelvin (1891, 1905) and Ursell (1960, 1994).

## 36.14 Other Physical Applications

### 36.14(i) Caustics

The physical manifestations of bifurcation sets are caustics. These are the structurally stable focal singularities (envelopes) of families of rays, on which the intensities of the geometrical (ray) theory diverge. Diffraction catastrophes describe the (linear) wave amplitudes that smooth the geometrical caustic singularities and decorate them with interference patterns. See Berry (1969, 1976, 1980, 1981), Kravtsov (1964, 1988), and Ludwig (1966).

### 36.14(ii) Optics

Diffraction catastrophes describe the connection between ray optics and wave optics. Applications include twinkling starlight, focusing of sunlight by rippling water (e.g., swimming-pool patterns), and water-droplet “lenses” (e.g., rainbows). See Adler *et al.* (1997), Berry and Upstill (1980), Marston (1992, 1999), Nye (1999), Walker (1983, 1988, 1989).

### 36.14(iii) Quantum Mechanics

Diffraction catastrophes describe the “semiclassical” connections between classical orbits and quantum wavefunctions, for integrable (non-chaotic) systems. Applications include scattering of elementary particles, atoms



and molecules from particles and surfaces, and chemical reactions. See Berry (1966, 1975), Connor (1974, 1976), Connor and Farrelly (1981), Trinkaus and Drepper (1977), and Uzer *et al.* (1983).

### 36.14(iv) Acoustics

Applications include the reflection of ultrasound pulses, and acoustical waveguides. See Chapman (1999), Frederickson and Marston (1992, 1994), and Kravtsov (1968).

## Computation

### 36.15 Methods of Computation

#### 36.15(i) Convergent Series

Close to the origin  $\mathbf{x} = 0$  of parameter space, the series in §36.8 can be used.

#### 36.15(ii) Asymptotics

Far from the bifurcation set, the leading-order asymptotic formulas of §36.11 reproduce accurately the form of the function, including the geometry of the zeros described in §36.7. Close to the bifurcation set but far from  $\mathbf{x} = 0$ , the uniform asymptotic approximations of §36.12 can be used.

#### 36.15(iii) Integration along Deformed Contour

Direct numerical evaluation can be carried out along a contour that runs along the segment of the real  $t$ -axis containing all real critical points of  $\Phi$  and is deformed outside this range so as to reach infinity along the asymptotic valleys of  $\exp(i\Phi)$ . (For the umbilics, representations as one-dimensional integrals (§36.2) are used.) For details, see Connor and Curtis (1982) and Kirk *et al.* (2000). There is considerable freedom in the choice of deformations.

#### 36.15(iv) Integration along Finite Contour

This can be carried out by direct numerical evaluation of canonical integrals along a finite segment of the real axis including all real critical points of  $\Phi$ , with contributions from the contour outside this range approximated by the first terms of an asymptotic series associated with the endpoints. See Berry *et al.* (1979).

#### 36.15(v) Differential Equations

For numerical solution of partial differential equations satisfied by the canonical integrals see Connor *et al.* (1983).

## References

### General References

There is no single source covering the material in this chapter. An overview of some of the mathematical analysis is given in Arnol'd (1975, 1986). Many physical applications can be found in Poston and Stewart (1978). For applications to wave physics, especially optics, see Berry and Upstill (1980).

### Sources

The following list gives the references or other indications of proofs that were used in constructing the various sections of this chapter. These sources supplement the references that are quoted in the text.

§36.2 The convergence of the oscillatory integrals (36.2.4)–(36.2.11) can be confirmed by rotating the integration paths in the complex plane. For (36.2.6) see Berry *et al.* (1979). For (36.2.7) shift the  $s$  variable in (36.2.5) (with (36.2.2)) to remove the quadratic term, integrate, and then deform the contour of the remaining  $t$  integration. For (36.2.8) see Berry and Howls (1990). For (36.2.9) integrate (36.2.5) (with (36.2.3)) with respect to  $t$ . For (36.2.12) and (36.2.13) use (4.10.11) and (9.5.4), respectively. For (36.2.15) and (36.2.17) use (5.9.1). For (36.2.18) combine (36.2.6), (36.2.8), and (5.9.1). For (36.2.19) use (12.5.1) and (12.14.13). For (36.2.20) see Trinkaus and Drepper (1977). For (36.2.21) use (36.2.9). Eqs. (36.2.22)–(36.2.27) follow from the definitions given in §36.2(i).

§§36.3, 36.4 The graphics were generated by the authors.

§36.5 Wright (1980) and Berry and Howls (1990). The common strategy employed in deriving the formulas in this section involves using the critical-point condition (36.4.1) to reduce the order of the catastrophe polynomials in (36.2.1), then solving (36.5.1) for the imaginary part of the complex critical point in terms of the value of the real critical point, which is itself determined by (36.4.1) and then used to generate the Stokes sets parametrically. For (36.5.11)–(36.5.21) we also use the exponents in the representations (36.2.6) and (36.2.8). The graphics were generated by the authors. For Figures 36.5.2–36.5.6, Eqs. (36.5.11)–(36.5.21) were used in parametric form  $x = x(y)$ , and checked against the numerical computations

in Berry and Howls (1990) (which were based directly on the definitions given in §36.5(i)).

**§36.7** Berry *et al.* (1979). (36.7.2) and (36.7.3) may be derived by setting to zero the stationary-phase approximation (§2.3(iv)) of the Pearcey integral  $\Psi_2(x, y)$  just outside the caustic; this involves one real saddle and one complex saddle. Table 36.7.1 was computed by the authors.

**§36.8** Connor (1973) and Connor *et al.* (1983). For (36.8.1), in the integral (36.2.4) retain the highest power of  $t$  in (36.2.1) in the exponent, expand the rest of the exponential as a power series in  $t$ , and evaluate the resulting integrals in terms of gamma functions. For (36.8.3), in the integral (36.2.5) with the polynomial (36.2.3) expand the  $z$ -dependent part of the exponential in powers of  $z$ , and then repeatedly use the differential equation (9.2.1) to express higher derivatives of the Airy function in terms of  $\text{Ai}$  and  $\text{Ai}'$ . For (36.8.4), in

the integral (36.2.5) with the polynomial (36.2.2) expand the  $z$ -dependent part of the exponential in powers of  $z$ , and then repeatedly use (9.2.1), and (36.2.20).

**§36.10** For (36.10.1) to (36.10.10) see Connor *et al.* (1983). (36.10.11) to (36.10.18) are derived by repeated differentiations with respect to  $x$ ,  $y$ , or  $z$ , in combinations that generate exact derivatives of the exponents in (36.2.5).

**§36.11** The formulas in this section are derived by the method of stationary phase, applied to the real critical points of the integral representations in §36.2. See §2.3(iv) and also Berry and Howls (1991). For (36.11.4) the integral is exponentially small when  $x > 0$  and the dominant contribution is from a critical point off the real axis.

**§36.12** Berry and Howls (1993).

**§36.13** The figure was generated by the authors.



# Bibliography

- A. S. Abdullaev (1985). *Asymptotics of solutions of the generalized sine-Gordon equation, the third Painlevé equation and the d'Alembert equation*. Dokl. Akad. Nauk SSSR **280**(2), pp. 265–268. English translation: Soviet Math. Dokl. **31**(1985), no. 1, pp. 45–47.
- M. J. Ablowitz and P. A. Clarkson (1991). *Solitons, Nonlinear Evolution Equations and Inverse Scattering*, Volume 149 of *London Mathematical Society Lecture Note Series*. Cambridge: Cambridge University Press.
- M. J. Ablowitz and H. Segur (1977). *Exact linearization of a Painlevé transcendent*. Phys. Rev. Lett. **38**(20), pp. 1103–1106.
- M. J. Ablowitz and H. Segur (1981). *Solitons and the Inverse Scattering Transform*, Volume 4 of *SIAM Studies in Applied Mathematics*. Philadelphia, PA: Society for Industrial and Applied Mathematics (SIAM).
- A. Abramov (1960). *Tables of  $\ln\Gamma(z)$  for Complex Argument*. New York: Pergamon Press.
- M. Abramowitz (1949). *Asymptotic expansions of spheroidal wave functions*. J. Math. Phys. Mass. Inst. Tech. **28**, pp. 195–199.
- M. Abramowitz (1954). *Regular and irregular Coulomb wave functions expressed in terms of Bessel-Clifford functions*. J. Math. Physics **33**, pp. 111–116.
- M. Abramowitz and P. Rabinowitz (1954). *Evaluation of Coulomb wave functions along the transition line*. Physical Rev. (2) **96**, pp. 77–79.
- M. Abramowitz and I. A. Stegun (Eds.) (1964). *Handbook of Mathematical Functions with Formulas, Graphs, and Mathematical Tables*. Number 55 in National Bureau of Standards Applied Mathematics Series. U.S. Government Printing Office, Washington, D.C. Corrections appeared in later printings up to the 10th Printing, December, 1972. Reproductions by other publishers, in whole or in part, have been available since 1965.
- J.-J. Achenbach (1986). *Numerik: Implementierung von Zylinderfunktionen*. Elektrotechnik. Braunschweig-Wiesbaden: Friedr. Vieweg & Sohn.
- F. S. Acton (1974). *Recurrence relations for the Fresnel integral  $\int_0^\infty \frac{\exp(-ct) dt}{\sqrt{t(1+t^2)}}$  and similar integrals*. Comm. ACM **17**(8), pp. 480–481.
- V. S. Adamchik (1998). *Polygamma functions of negative order*. J. Comput. Appl. Math. **100**(2), pp. 191–199.
- V. S. Adamchik and H. M. Srivastava (1998). *Some series of the zeta and related functions*. Analysis (Munich) **18**(2), pp. 131–144.
- A. Adelberg (1992). *On the degrees of irreducible factors of higher order Bernoulli polynomials*. Acta Arith. **62**(4), pp. 329–342.
- A. Adelberg (1996). *Congruences of  $p$ -adic integer order Bernoulli numbers*. J. Number Theory **59**(2), pp. 374–388.
- C. Adiga, B. C. Berndt, S. Bhargava, and G. N. Watson (1985). *Chapter 16 of Ramanujan's second notebook: Theta-functions and  $q$ -series*. Mem. Amer. Math. Soc. **53**(315), pp. v+85.
- C. L. Adler, J. A. Lock, B. R. Stone, and C. J. Garcia (1997). *High-order interior caustics produced in scattering of a diagonally incident plane wave by a circular cylinder*. J. Opt. Soc. Amer. A **14**(6), pp. 1305–1315.
- V. È. Adler (1994). *Nonlinear chains and Painlevé equations*. Phys. D **73**(4), pp. 335–351.
- P. Adrian (1959). *Die Bezeichnungsweise der Bernoullischen Zahlen*. Mitt. Verein. Schweiz. Versicherungsmath. **59**, pp. 199–206.
- M. M. Agrest, S. I. Labakhua, M. M. Rikenglaz, and T. S. Chachibaya (1982). *Tablitsy funktsii Struve i integralov ot nikh*. Moscow: "Nauka". Translated title: *Tables of Struve Functions and their Integrals*.
- M. M. Agrest and M. S. Maksimov (1971). *Theory of Incomplete Cylindrical Functions and Their Applications*. Berlin: Springer-Verlag. Translated from the Russian by H. E. Fettis, J. W. Goresh and D. A. Lee, Die Grundlehren der mathematischen Wissenschaften, Band 160.
- L. V. Ahlfors (1966). *Complex Analysis: An Introduction of the Theory of Analytic Functions of One Complex Variable* (2nd ed.). New York: McGraw-Hill Book Co. A third edition was published in 1978 by McGraw-Hill, New York.
- A. R. Ahmadi and S. E. Widnall (1985). *Unsteady lifting-line theory as a singular-perturbation problem*. J. Fluid Mech **153**, pp. 59–81.
- S. Ahmed and M. E. Muldoon (1980). *On the zeros of confluent hypergeometric functions. III. Characterization by means of nonlinear equations*. Lett. Nuovo Cimento (2) **29**(11), pp. 353–358.

- S.-H. Ahn, H.-W. Lee, and H. M. Lee (2001). *Lyx line formation in starbursting galaxies. I. Moderately thick, dustless, and static H I media*. *Astrophysical J.* **554**, pp. 604–614.
- H. Airault (1979). *Rational solutions of Painlevé equations*. *Stud. Appl. Math.* **61**(1), pp. 31–53.
- H. Airault, H. P. McKean, and J. Moser (1977). *Rational and elliptic solutions of the Korteweg-de Vries equation and a related many-body problem*. *Comm. Pure Appl. Math.* **30**(1), pp. 95–148.
- G. B. Airy (1838). *On the intensity of light in the neighbourhood of a caustic*. *Trans. Camb. Phil. Soc.* **6**, pp. 379–402.
- G. B. Airy (1849). *Supplement to a paper “On the intensity of light in the neighbourhood of a caustic”*. *Trans. Camb. Phil. Soc.* **8**, pp. 595–599.
- N. I. Akhiezer (1988). *Lectures on Integral Transforms*, Volume 70 of *Translations of Mathematical Monographs*. Providence, RI: American Mathematical Society. Translated from the Russian by H. H. McFaden.
- N. I. Akhiezer (1990). *Elements of the Theory of Elliptic Functions*, Volume 79 of *Translations of Mathematical Monographs*. Providence, RI: American Mathematical Society. Translated from the second Russian edition by H. H. McFaden.
- A. M. Al-Rashed and N. Zaheer (1985). *Zeros of Stieltjes and Van Vleck polynomials and applications*. *J. Math. Anal. Appl.* **110**(2), pp. 327–339.
- W. A. Al-Salam and L. Carlitz (1959). *Some determinants of Bernoulli, Euler and related numbers*. *Portugal. Math.* **18**, pp. 91–99.
- W. A. Al-Salam and L. Carlitz (1965). *Some orthogonal  $q$ -polynomials*. *Math. Nachr.* **30**, pp. 47–61.
- W. A. Al-Salam and M. E. H. Ismail (1994). *A  $q$ -beta integral on the unit circle and some biorthogonal rational functions*. *Proc. Amer. Math. Soc.* **121**(2), pp. 553–561.
- M. Alam (1979). *Zeros of Stieltjes and Van Vleck polynomials*. *Trans. Amer. Math. Soc.* **252**, pp. 197–204.
- D. W. Albrecht, E. L. Mansfield, and A. E. Milne (1996). *Algorithms for special integrals of ordinary differential equations*. *J. Phys. A* **29**(5), pp. 973–991.
- J. R. Albright (1977). *Integrals of products of Airy functions*. *J. Phys. A* **10**(4), pp. 485–490.
- J. R. Albright and E. P. Gavathas (1986). *Integrals involving Airy functions*. *J. Phys. A* **19**(13), pp. 2663–2665.
- K. Alder, A. Bohr, T. Huus, B. Mottelson, and A. Winther (1956). *Study of nuclear structure by electromagnetic excitation with accelerated ions*. *Rev. Mod. Phys.* **28**, pp. 432–542.
- G. Alefeld and J. Herzberger (1983). *Introduction to Interval Computations*. Computer Science and Applied Mathematics. New York: Academic Press Inc. Translated from the German by Jon Rokne.
- W. R. Alford, A. Granville, and C. Pomerance (1994). *There are infinitely many Carmichael numbers*. *Ann. of Math. (2)* **139**(3), pp. 703–722.
- F. Alhargan and S. Judah (1992). *Frequency response characteristics of the multiport planar elliptic patch*. *IEEE Trans. Microwave Theory Tech.* **40**(8), pp. 1726–1730.
- F. Alhargan and S. Judah (1995). *A general mode theory for the elliptic disk microstrip antenna*. *IEEE Trans. Antennas and Propagation* **43**(6), pp. 560–568.
- G. Allasia and R. Besenghi (1987a). *Numerical calculation of incomplete gamma functions by the trapezoidal rule*. *Numer. Math.* **50**(4), pp. 419–428.
- G. Allasia and R. Besenghi (1987b). *Numerical computation of Tricomi’s psi function by the trapezoidal rule*. *Computing* **39**(3), pp. 271–279.
- G. Allasia and R. Besenghi (1989). *Numerical Calculation of the Riemann Zeta Function and Generalizations by Means of the Trapezoidal Rule*. In C. Brezinski (Ed.), *Numerical and Applied Mathematics, Part II (Paris, 1988)*, Volume 1 of *IMACS Ann. Comput. Appl. Math.*, pp. 467–472. Basel: Baltzer.
- G. Allasia and R. Besenghi (1991). *Numerical evaluation of the Kummer function with complex argument by the trapezoidal rule*. *Rend. Sem. Mat. Univ. Politec. Torino* **49**(3), pp. 315–327.
- G. Almkvist and B. Berndt (1988). *Gauss, Landen, Ramanujan, the arithmetic-geometric mean, ellipses,  $\pi$ , and the Ladies Diary*. *Amer. Math. Monthly* **95**(7), pp. 585–608.
- Z. Altaç (1996). *Integrals involving Bickley and Bessel functions in radiative transfer, and generalized exponential integral functions*. *J. Heat Transfer* **118**(3), pp. 789–792.
- H. H. Aly, H. J. W. Müller-Kirsten, and N. Vahedi-Faridi (1975). *Scattering by singular potentials with a perturbation – Theoretical introduction to Mathieu functions*. *J. Mathematical Phys.* **16**, pp. 961–970. Erratum: same journal **17** (1975), no. 7, p. 1361.
- H. Alzer (1997a). *A harmonic mean inequality for the gamma function*. *J. Comput. Appl. Math.* **87**(2), pp. 195–198. For corrigendum see same journal v. 90 (1998), no. 2, p. 265.
- H. Alzer (1997b). *On some inequalities for the incomplete gamma function*. *Math. Comp.* **66**(218), pp. 771–778.
- H. Alzer (2000). *Sharp bounds for the Bernoulli numbers*. *Arch. Math. (Basel)* **74**(3), pp. 207–211.

- H. Alzer and S.-L. Qiu (2004). *Monotonicity theorems and inequalities for the complete elliptic integrals*. J. Comput. Appl. Math. **172**(2), pp. 289–312.
- D. E. Amos (1974). *Computation of modified Bessel functions and their ratios*. Math. Comp. **28**(125), pp. 239–251.
- D. E. Amos (1980). *Computation of exponential integrals*. ACM Trans. Math. Software **6**(3), pp. 365–377.
- D. E. Amos (1983). *Uniform asymptotic expansions for exponential integrals  $E_n(x)$  and Bickley functions  $Ki_n(x)$* . ACM Trans. Math. Software **9**(4), pp. 467–479.
- D. E. Amos (1985). *A subroutine package for Bessel functions of a complex argument and nonnegative order*. Technical Report SAND85-1018, Sandia National Laboratories, Albuquerque, NM.
- D. E. Amos (1989). *Repeated integrals and derivatives of  $K$  Bessel functions*. SIAM J. Math. Anal. **20**(1), pp. 169–175.
- G. D. Anderson, S.-L. Qiu, M. K. Vamanamurthy, and M. Vuorinen (2000). *Generalized elliptic integrals and modular equations*. Pacific J. Math. **192**(1), pp. 1–37.
- G. D. Anderson and M. K. Vamanamurthy (1985). *Inequalities for elliptic integrals*. Publ. Inst. Math. (Beograd) (N.S.) **37**(51), pp. 61–63.
- G. D. Anderson, M. K. Vamanamurthy, and M. Vuorinen (1990). *Functional inequalities for complete elliptic integrals and their ratios*. SIAM J. Math. Anal. **21**(2), pp. 536–549.
- G. D. Anderson, M. K. Vamanamurthy, and M. Vuorinen (1992a). *Functional inequalities for hypergeometric functions and complete elliptic integrals*. SIAM J. Math. Anal. **23**(2), pp. 512–524.
- G. D. Anderson, M. K. Vamanamurthy, and M. Vuorinen (1992b). *Hypergeometric Functions and Elliptic Integrals*. In H. M. Srivastava and S. Owa (Eds.), *Current Topics in Analytic Function Theory*, pp. 48–85. River Edge, NJ: World Sci. Publishing.
- G. D. Anderson, M. K. Vamanamurthy, and M. K. Vuorinen (1997). *Conformal Invariants, Inequalities, and Quasiconformal Maps*. New York: John Wiley & Sons Inc. With PC diskette, a Wiley-Interscience Publication.
- F. V. Andreev and A. V. Kitaev (2002). *Transformations  $RS_4^2(3)$  of the ranks  $\leq 4$  and algebraic solutions of the sixth Painlevé equation*. Comm. Math. Phys. **228**(1), pp. 151–176.
- G. E. Andrews (1966a). *On basic hypergeometric series, mock theta functions, and partitions. II*. Quart. J. Math. Oxford Ser. (2) **17**, pp. 132–143.
- G. E. Andrews (1966b).  *$q$ -identities of Auluck, Carlitz, and Rogers*. Duke Math. J. **33**(3), pp. 575–581.
- G. E. Andrews (1972). *Summations and transformations for basic Appell series*. J. London Math. Soc. (2) **4**, pp. 618–622.
- G. E. Andrews (1974). *Applications of basic hypergeometric functions*. SIAM Rev. **16**(4), pp. 441–484.
- G. E. Andrews (1976). *The Theory of Partitions*, Volume 2 of *Encyclopedia of Mathematics and its Applications*. Reading, MA-London-Amsterdam: Addison-Wesley Publishing Co. Reprinted by Cambridge University Press, Cambridge, 1998.
- G. E. Andrews (1979). *Plane partitions. III. The weak Macdonald conjecture*. Invent. Math. **53**(3), pp. 193–225.
- G. E. Andrews (1984). *Multiple series Rogers-Ramanujan type identities*. Pacific J. Math. **114**(2), pp. 267–283.
- G. E. Andrews (1986).  *$q$ -Series: Their Development and Application in Analysis, Number Theory, Combinatorics, Physics, and Computer Algebra*, Volume 66 of *CBMS Regional Conference Series in Mathematics*. Providence, RI: Amer. Math. Soc.
- G. E. Andrews (1996). *Pfaff's method II: Diverse applications*. J. Comput. Appl. Math. **68**(1-2), pp. 15–23.
- G. E. Andrews (2000). *Umbral calculus, Bailey chains, and pentagonal number theorems*. J. Combin. Theory Ser. A **91**(1-2), pp. 464–475. In memory of Gian-Carlo Rota.
- G. E. Andrews (2001). *Bailey's Transform, Lemma, Chains and Tree*. In J. Bustoz, M. E. H. Ismail, and S. K. Suslov (Eds.), *Special Functions 2000: Current Perspective and Future Directions (Tempe, AZ)*, Volume 30 of *NATO Sci. Ser. II Math. Phys. Chem.*, pp. 1–22. Dordrecht: Kluwer Acad. Publ.
- G. E. Andrews, R. Askey, and R. Roy (1999). *Special Functions*, Volume 71 of *Encyclopedia of Mathematics and its Applications*. Cambridge: Cambridge University Press.
- G. E. Andrews, R. A. Askey, B. C. Berndt, and R. A. Rankin (Eds.) (1988). *Ramanujan Revisited*, Boston, MA. Academic Press Inc.
- G. E. Andrews and A. Berkovich (1998). *A trinomial analogue of Bailey's lemma and  $N = 2$  superconformal invariance*. Comm. Math. Phys. **192**(2), pp. 245–260.
- G. E. Andrews and D. Foata (1980). *Congruences for the  $q$ -secant numbers*. European J. Combin. **1**(4), pp. 283–287.
- G. E. Andrews, I. P. Goulden, and D. M. Jackson (1986). *Shanks' convergence acceleration transform, Padé approximants and partitions*. J. Combin. Theory Ser. A **43**(1), pp. 70–84.
- H. M. Antia (1993). *Rational function approximations for Fermi-Dirac integrals*. The Astrophysical Journal Supplement Series **84**, pp. 101–108. Double-precision Fortran, maximum precision 8D.

- M. A. Anuta, D. W. Lozier, and P. R. Turner (1996). *The MasPar MP-1 as a computer arithmetic laboratory*. J. Res. Nat. Inst. Stand. Technol. **101**(2), pp. 165–174.
- K. Aomoto (1987). *Special value of the hypergeometric function  ${}_3F_2$  and connection formulae among asymptotic expansions*. J. Indian Math. Soc. (N.S.) **51**, pp. 161–221.
- A. Apelblat (1983). *Table of Definite and Infinite Integrals*, Volume 13 of *Physical Sciences Data*. Amsterdam: Elsevier Scientific Publishing Co. Table errata: Math. Comp. v. 65 (1996), no. 215, p. 1386.
- A. Apelblat (1989). *Derivatives and integrals with respect to the order of the Struve functions  $\mathbf{H}_\nu(x)$  and  $\mathbf{L}_\nu(x)$* . J. Math. Anal. Appl. **137**(1), pp. 17–36.
- A. Apelblat (1991). *Integral representation of Kelvin functions and their derivatives with respect to the order*. Z. Angew. Math. Phys. **42**(5), pp. 708–714.
- T. M. Apostol (1952). *Theorems on generalized Dedekind sums*. Pacific J. Math. **2**(1), pp. 1–9.
- T. M. Apostol (1976). *Introduction to Analytic Number Theory*. New York: Springer-Verlag. Undergraduate Texts in Mathematics.
- T. M. Apostol (1983). *A proof that Euler missed: Evaluating  $\zeta(2)$  the easy way*. Math. Intelligencer **5**(3), pp. 59–60.
- T. M. Apostol (1985a). *Formulas for higher derivatives of the Riemann zeta function*. Math. Comp. **44**(169), pp. 223–232.
- T. M. Apostol (1985b). *Note on the trivial zeros of Dirichlet  $L$ -functions*. Proc. Amer. Math. Soc. **94**(1), pp. 29–30.
- T. M. Apostol (1990). *Modular Functions and Dirichlet Series in Number Theory* (2nd ed.), Volume 41 of *Graduate Texts in Mathematics*. New York: Springer-Verlag.
- T. M. Apostol (2000). *A Centennial History of the Prime Number Theorem*. In *Number Theory*, Trends Math., pp. 1–14. Basel: Birkhäuser.
- T. M. Apostol (2006). *Bernoulli's power-sum formulas revisited*. Math. Gaz. **90**(518), pp. 276–279.
- T. M. Apostol (2008). *A primer on Bernoulli numbers and polynomials*. Math. Mag. **81**(3), pp. 178–190.
- T. M. Apostol and I. Niven (1994). *Number Theory*. In *The New Encyclopaedia Britannica* (15th ed.), Volume 25, pp. 14–37.
- T. M. Apostol and T. H. Vu (1984). *Dirichlet series related to the Riemann zeta function*. J. Number Theory **19**(1), pp. 85–102.
- T. M. Apostol and H. S. Zuckerman (1951). *On magic squares constructed by the uniform step method*. Proc. Amer. Math. Soc. **2**(4), pp. 557–565.
- H. Appel (1968). *Numerical Tables for Angular Correlation Computations in  $\alpha$ -,  $\beta$ - and  $\gamma$ -Spectroscopy:  $3j$ -,  $6j$ -,  $9j$ -Symbols,  $F$ - and  $\Gamma$ -Coefficients*. Landolt-Börnstein Numerical Data and Functional Relationships in Science and Technology. Springer-Verlag.
- G. B. Arfken and H. J. Weber (2005). *Mathematical Methods for Physicists* (6th ed.). Oxford: Elsevier.
- J. V. Armitage (1989). *The Riemann Hypothesis and the Hamiltonian of a Quantum Mechanical System*. In M. M. Dodson and J. A. G. Vickers (Eds.), *Number Theory and Dynamical Systems (York, 1987)*, Volume 134 of *London Math. Soc. Lecture Note Ser.*, pp. 153–172. Cambridge: Cambridge University Press.
- B. H. Armstrong (1967). *Spectrum line profiles: The Voigt function*. J. Quant. Spectrosc. Radiat. Transfer **7**, pp. 61–88.
- V. I. Arnol'd (1972). *Normal forms of functions near degenerate critical points, the Weyl groups  $A_k, D_k, E_k$  and Lagrangian singularities*. Funkcional. Anal. i Priložen. **6**(4), pp. 3–25. In Russian. English translation: Functional Anal. Appl., **6**(1973), pp. 254–272.
- V. I. Arnol'd (1974). *Normal forms of functions in the neighborhood of degenerate critical points*. Uspehi Mat. Nauk **29**(2(176)), pp. 11–49. Collection of articles dedicated to the memory of Ivan Georgievič Petrovskii (1901–1973), I. In Russian. English translation: Russian Math. Surveys, **29**(1974), no. 2, pp. 10–50.
- V. I. Arnol'd (1975). *Critical points of smooth functions, and their normal forms*. Uspehi Mat. Nauk **30**(5(185)), pp. 3–65. In Russian. English translation: Russian Math. Surveys, **30**(1975), no. 5, pp. 1–75.
- V. I. Arnol'd (1986). *Catastrophe Theory* (2nd ed.). Berlin: Springer-Verlag. Translated from the Russian by G. S. Wassermann, based on a translation by R. K. Thomas. See also Arnol'd (1992).
- V. I. Arnol'd (1992). *Catastrophe Theory* (3rd ed.). Berlin: Springer-Verlag. Translated from the Russian by G. S. Wassermann, Based on a translation by R. K. Thomas.
- V. I. Arnol'd (1997). *Mathematical Methods of Classical Mechanics*, Volume 60 of *Graduate Texts in Mathematics*. New York: Springer-Verlag. Translated from the 1974 Russian original by K. Vogtmann and A. Weinstein, Corrected reprint of the second (1989) edition.
- V. I. Arnol'd, S. M. Gusein-Zade, and A. N. Varchenko (1988). *Singularities of Differentiable Maps. Vol. II*. Boston-Berlin: Birkhäuser. Monodromy and asymptotics of integrals, Translated from the Russian by Hugh Porteous, Translation revised by the authors and James Montaldi.
- F. M. Arscott (1956). *Perturbation solutions of the ellipsoidal wave equation*. Quart. J. Math. Oxford Ser. (2) **7**, pp. 161–174.

- F. M. Arscott (1959). *A new treatment of the ellipsoidal wave equation*. Proc. London Math. Soc. (3) **9**, pp. 21–50.
- F. M. Arscott (1964a). *Integral equations and relations for Lamé functions*. Quart. J. Math. Oxford Ser. (2) **15**, pp. 103–115.
- F. M. Arscott (1964b). *Periodic Differential Equations. An Introduction to Mathieu, Lamé, and Allied Functions*. International Series of Monographs in Pure and Applied Mathematics, Vol. 66. New York: Pergamon Press, The Macmillan Co.
- F. M. Arscott (1967). *The Whittaker-Hill equation and the wave equation in paraboloidal co-ordinates*. Proc. Roy. Soc. Edinburgh Sect. A **67**, pp. 265–276.
- F. M. Arscott and I. M. Khabaza (1962). *Tables of Lamé Polynomials*. New York: Pergamon Press, The Macmillan Co.
- G. Arutyunov and M. Staudacher (2004). *Matching higher conserved charges for strings and spins*. J. High Energy Phys. (electronic only, article id. JHEP03(2004)004, 32 pp.).
- U. M. Ascher, R. M. M. Mattheij, and R. D. Russell (1995). *Numerical Solution of Boundary Value Problems for Ordinary Differential Equations*, Volume 13 of *Classics in Applied Mathematics*. Philadelphia, PA: Society for Industrial and Applied Mathematics (SIAM). Corrected reprint of the 1988 original.
- U. M. Ascher and L. R. Petzold (1998). *Computer Methods for Ordinary Differential Equations and Differential-Algebraic Equations*. Philadelphia, PA: Society for Industrial and Applied Mathematics (SIAM).
- R. Askey (1974). *Jacobi polynomials. I. New proofs of Koornwinder's Laplace type integral representation and Bateman's bilinear sum*. SIAM J. Math. Anal. **5**, pp. 119–124.
- R. Askey (1975). *Orthogonal Polynomials and Special Functions*, Volume 21 of *CBMS-NSF Regional Conference Series in Applied Mathematics*. Philadelphia, PA: Society for Industrial and Applied Mathematics.
- R. Askey (1980). *Some basic hypergeometric extensions of integrals of Selberg and Andrews*. SIAM J. Math. Anal. **11**(6), pp. 938–951.
- R. Askey (1982). *Commentary on the Paper "Beiträge zur Theorie der Toeplitzschen Form"*. In *Gábor Szegő, Collected Papers. Vol. 1*, Contemporary Mathematicians, pp. 303–305. MA: Birkhäuser Boston.
- R. Askey (1985). *Continuous Hahn polynomials*. J. Phys. A **18**(16), pp. L1017–L1019.
- R. Askey (1989). *Continuous  $q$ -Hermite Polynomials when  $q > 1$* . In  *$q$ -series and Partitions (Minneapolis, MN, 1988)*, Volume 18 of *IMA Vol. Math. Appl.*, pp. 151–158. New York: Springer.
- R. Askey (1990). *Graphs as an Aid to Understanding Special Functions*. In R. Wong (Ed.), *Asymptotic and Computational Analysis*, Volume 124 of *Lecture Notes in Pure and Appl. Math.*, pp. 3–33. New York: Dekker.
- R. Askey and J. Fitch (1969). *Integral representations for Jacobi polynomials and some applications*. J. Math. Anal. Appl. **26**(2), pp. 411–437.
- R. Askey and G. Gasper (1976). *Positive Jacobi polynomial sums. II*. Amer. J. Math. **98**(3), pp. 709–737.
- R. Askey and M. E. H. Ismail (1984). *Recurrence relations, continued fractions, and orthogonal polynomials*. Mem. Amer. Math. Soc. **49**(300), pp. iv+108.
- R. Askey, T. H. Koornwinder, and M. Rahman (1986). *An integral of products of ultraspherical functions and a  $q$ -extension*. J. London Math. Soc. (2) **33**(1), pp. 133–148.
- R. Askey and B. Razban (1972). *An integral for Jacobi polynomials*. Simon Stevin **46**, pp. 165–169.
- R. Askey and J. Wilson (1985). *Some basic hypergeometric orthogonal polynomials that generalize Jacobi polynomials*. Mem. Amer. Math. Soc. **54**(319), pp. iv+55.
- D. Atkinson and P. W. Johnson (1988). *Chiral-symmetry breaking in QCD. I. The infrared domain*. Phys. Rev. D (3) **37**(8), pp. 2290–2295.
- K. E. Atkinson (1989). *An Introduction to Numerical Analysis* (2nd ed.). New York: John Wiley & Sons Inc.
- M. Audin (1999). *Spinning Tops: A Course on Integrable Systems*, Volume 51 of *Cambridge Studies in Advanced Mathematics*. Cambridge: Cambridge University Press.
- M. Aymar, C. H. Greene, and E. Luc-Koenig (1996). *Multi-channel Rydberg spectroscopy of complex atoms*. Reviews of Modern Physics **68**, pp. 1015–1123.
- A. W. Babister (1967). *Transcendental Functions Satisfying Nonhomogeneous Linear Differential Equations*. New York: The Macmillan Co.
- L. V. Babushkina, M. K. Kerimov, and A. I. Nikitin (1997). *New tables of Bessel functions of complex argument*. Comput. Math. Math. Phys. **37**(12), pp. 1480–1482. Russian original in Zh. Vychisl. Mat. i Mat. Fiz. **37**(1997), no. 12, 1526–1528.
- G. Backenstoss (1970). *Pionic atoms*. Annual Review of Nuclear and Particle Science **20**, pp. 467–508.
- J. Baik, P. Deift, and K. Johansson (1999). *On the distribution of the length of the longest increasing subsequence of random permutations*. J. Amer. Math. Soc. **12**(4), pp. 1119–1178.
- W. N. Bailey (1928). *Products of generalized hypergeometric series*. Proc. London Math. Soc. (2) **28**(2), pp. 242–254.



- W. N. Bailey (1929). *Transformations of generalized hypergeometric series*. Proc. London Math. Soc. (2) **29**(2), pp. 495–502.
- W. N. Bailey (1935). *Generalized Hypergeometric Series*. Cambridge: Cambridge University Press. Reissued by Hafner, New York, 1972.
- W. N. Bailey (1964). *Generalized Hypergeometric Series*. New York: Stechert-Hafner, Inc.
- G. A. Baker, Jr. and P. Graves-Morris (1996). *Padé Approximants* (2nd ed.), Volume 59 of *Encyclopedia of Mathematics and its Applications*. Cambridge: Cambridge University Press.
- H. F. Baker (1995). *Abelian Functions: Abel's Theorem and the Allied Theory of Theta Functions*. Cambridge: Cambridge University Press. Reprint of the 1897 original, with a foreword by Igor Krichever.
- P. Baldwin (1985). *Zeros of generalized Airy functions*. Mathematika **32**(1), pp. 104–117.
- P. Baldwin (1991). *Coefficient functions for an inhomogeneous turning-point problem*. Mathematika **38**(2), pp. 217–238.
- J. S. Ball (2000). *Automatic computation of zeros of Bessel functions and other special functions*. SIAM J. Sci. Comput. **21**(4), pp. 1458–1464.
- L. E. Ballentine and S. M. McRae (1998). *Moment equations for probability distributions in classical and quantum mechanics*. Phys. Rev. A **58**(3), pp. 1799–1809.
- C. B. Balogh (1967). *Asymptotic expansions of the modified Bessel function of the third kind of imaginary order*. SIAM J. Appl. Math. **15**, pp. 1315–1323.
- E. Bannai (1990). *Orthogonal Polynomials in Coding Theory and Algebraic Combinatorics*. In *Orthogonal Polynomials (Columbus, OH, 1989)*, Volume 294 of *NATO Adv. Sci. Inst. Ser. C Math. Phys. Sci.*, pp. 25–53. Dordrecht: Kluwer Acad. Publ.
- R. Barakat (1961). *Evaluation of the incomplete gamma function of imaginary argument by Chebyshev polynomials*. Math. Comp. **15**(73), pp. 7–11.
- R. Barakat and E. Parshall (1996). *Numerical evaluation of the zero-order Hankel transform using Filon quadrature philosophy*. Appl. Math. Lett. **9**(5), pp. 21–26.
- P. Baratella and L. Gatteschi (1988). *The Bounds for the Error Term of an Asymptotic Approximation of Jacobi Polynomials*. In *Orthogonal Polynomials and Their Applications (Segovia, 1986)*, Volume 1329 of *Lecture Notes in Math.*, pp. 203–221. Berlin: Springer.
- M. N. Barber and B. W. Ninham (1970). *Random and Restricted Walks: Theory and Applications*. New York: Gordon and Breach.
- C. Bardin, Y. Dandeu, L. Gauthier, J. Guillermin, T. Lena, J. M. Pernet, H. H. Wolter, and T. Tamura (1972). *Coulomb functions in entire  $(\eta, \rho)$ -plane*. Comput. Phys. Comm. **3**(2), pp. 73–87.
- R. W. Barnard, K. Pearce, and K. C. Richards (2000). *A monotonicity property involving  ${}_3F_2$  and comparisons of the classical approximations of elliptical arc length*. SIAM J. Math. Anal. **32**(2), pp. 403–419.
- R. W. Barnard, K. Pearce, and L. Schovanec (2001). *Inequalities for the perimeter of an ellipse*. J. Math. Anal. Appl. **260**(2), pp. 295–306.
- A. R. Barnett (1981a). *An algorithm for regular and irregular Coulomb and Bessel functions of real order to machine accuracy*. Comput. Phys. Comm. **21**(3), pp. 297–314.
- A. R. Barnett (1981b). *KLEIN: Coulomb functions for real  $\lambda$  and positive energy to high accuracy*. Comput. Phys. Comm. **24**(2), pp. 141–159. Double-precision Fortran code for positive energies.
- A. R. Barnett (1996). *The Calculation of Spherical Bessel Functions and Coulomb Functions*. In K. Bartschat and J. Hinze (Eds.), *Computational Atomic Physics: Electron and Positron Collisions with Atoms and Ions*, pp. 181–202. Berlin: Springer. Includes program disk. Double-precision Fortran code for positive energies. Maximum accuracy: 15D.
- A. R. Barnett, D. H. Feng, J. W. Steed, and L. J. B. Goldfarb (1974). *Coulomb wave functions for all real  $\eta$  and  $\rho$* . Comput. Phys. Comm. **8**(5), pp. 377–395. Single-precision Fortran code for positive energies. For modification see same journal, **11**(1976), p. 141.
- E. Barouch, B. M. McCoy, and T. T. Wu (1973). *Zero-field susceptibility of the two-dimensional Ising model near  $T_c$* . Phys. Rev. Lett. **31**, pp. 1409–1411.
- G. E. Barr (1968). *A note on integrals involving parabolic cylinder functions*. SIAM J. Appl. Math. **16**(1), pp. 71–74.
- R. F. Barrett (1964). *Tables of modified Struve functions of orders zero and unity*. Part of the Unpublished Mathematical Tables. Reviewed in Math. Comp., v. 18 (1964), no. 86, p. 332.
- W. Barrett (1981). *Mathieu functions of general order: Connection formulae, base functions and asymptotic formulae*. I–V. Philos. Trans. Roy. Soc. London Ser. A **301**, pp. 75–162.
- P. Barrucand and D. Dickinson (1968). *On the Associated Legendre Polynomials*. In *Orthogonal Expansions and their Continuous Analogues (Proc. Conf., Edwardsville, Ill., 1967)*, pp. 43–50. Carbondale, Ill.: Southern Illinois Univ. Press.
- D. A. Barry, P. J. Culligan-Hensley, and S. J. Barry (1995). *Real values of the  $W$ -function*. ACM Trans. Math. Software **21**(2), pp. 161–171.

- W. Bartky (1938). *Numerical calculation of a generalized complete elliptic integral*. Rev. Mod. Phys. **10**, pp. 264–269.
- A. O. Barut and L. Girardello (1971). *New “coherent” states associated with non-compact groups*. Comm. Math. Phys. **21**(1), pp. 41–55.
- A. P. Bassom, P. A. Clarkson, and A. C. Hicks (1993). *Numerical studies of the fourth Painlevé equation*. IMA J. Appl. Math. **50**(2), pp. 167–193.
- A. P. Bassom, P. A. Clarkson, and A. C. Hicks (1995). *Bäcklund transformations and solution hierarchies for the fourth Painlevé equation*. Stud. Appl. Math. **95**(1), pp. 1–71.
- A. P. Bassom, P. A. Clarkson, A. C. Hicks, and J. B. McLeod (1992). *Integral equations and exact solutions for the fourth Painlevé equation*. Proc. Roy. Soc. London Ser. A **437**, pp. 1–24.
- A. P. Bassom, P. A. Clarkson, C. K. Law, and J. B. McLeod (1998). *Application of uniform asymptotics to the second Painlevé transcendent*. Arch. Rational Mech. Anal. **143**(3), pp. 241–271.
- A. Basu and T. M. Apostol (2000). *A new method for investigating Euler sums*. Ramanujan J. **4**(4), pp. 397–419.
- P. M. Batchelder (1967). *An Introduction to Linear Difference Equations*. New York: Dover Publications Inc. Unaltered republication of the original 1927 Harvard University edition.
- H. Bateman (1905). *A generalisation of the Legendre polynomial*. Proc. London Math. Soc. (2) **3**(3), pp. 111–123. Reviewed in JFM 36.0512.01.
- H. Bateman and R. C. Archibald (1944). *A guide to tables of Bessel functions*. Mathematical Tables and Other Aids to Computation (now Mathematics of Computation) **1**(7), pp. 205–308.
- F. L. Bauer, H. Rutishauser, and E. Stiefel (1963). *New Aspects in Numerical Quadrature*. In *Proc. Sympos. Appl. Math., Vol. XV*, pp. 199–218. Providence, RI: American Mathematical Society.
- G. Baxter (1961). *Polynomials defined by a difference system*. J. Math. Anal. Appl. **2**(2), pp. 223–263.
- R. J. Baxter (1981). *Rogers-Ramanujan identities in the hard hexagon model*. J. Statist. Phys. **26**(3), pp. 427–452.
- R. J. Baxter (1982). *Exactly Solved Models in Statistical Mechanics*. London-New York: Academic Press Inc. Reprinted in 1989.
- K. Bay, W. Lay, and A. Akopyan (1997). *Avoided crossings of the quartic oscillator*. J. Phys. A **30**(9), pp. 3057–3067.
- C. Bays and R. H. Hudson (2000). *A new bound for the smallest  $x$  with  $\pi(x) > \text{li}(x)$* . Math. Comp. **69**(231), pp. 1285–1296.
- L. P. Bayvel and A. R. Jones (1981). *Electromagnetic Scattering and its Applications*. London: Applied Science Publishers.
- E. F. Beckenbach (Ed.) (1981). *Applied Combinatorial Mathematics*. Malabar, FL: Robert E. Krieger.
- P. A. Becker (1997). *Normalization integrals of orthogonal Heun functions*. J. Math. Phys. **38**(7), pp. 3692–3699.
- R. Becker and F. Sauter (1964). *Electromagnetic Fields and Interactions*, Volume I. New York: Blaisdell. Replaces Abraham & Becker, Classical Theory of Electricity and Magnetism.
- P. Beckmann and A. Spizzichino (1963). *The Scattering of Electromagnetic Waves from Rough Surfaces*. New York: Pergamon Press. Reprinted in 1987 by Artech House Publishers, Norwood, Massachusetts.
- V. M. Beliakov, R. I. Kravtsova, and M. G. Rappoport (1962). *Tablitsy Ellipticheskikh Integralov. Tom I*. Mathematical tables of the Computing Center of the Academy of Sciences of the USSR]. Moscow: Izdat. Akad. Nauk SSSR. Reviewed in Math. Comp. v. 18(1964), pp. 676–677.
- R. Bellman (1961). *A Brief Introduction to Theta Functions*. Athena Series: Selected Topics in Mathematics. New York: Holt, Rinehart and Winston.
- E. D. Belokolos, A. I. Bobenko, V. Z. Enol’skii, A. R. Its, and V. B. Matveev (1994). *Algebro-geometric Approach to Nonlinear Integrable Problems*. Springer Series in Nonlinear Dynamics. Berlin: Springer-Verlag.
- S. L. Belousov (1962). *Tables of Normalized Associated Legendre Polynomials*. Oxford-New York: Pergamon Press, The Macmillan Co.
- C. M. Bender and S. A. Orszag (1978). *Advanced Mathematical Methods for Scientists and Engineers*. New York: McGraw-Hill Book Co. Reprinted by Springer-Verlag, New York, 1999.
- C. M. Bender and T. T. Wu (1973). *Anharmonic oscillator. II. A study of perturbation theory in large order*. Phys. Rev. D **7**, pp. 1620–1636.
- E. A. Bender (1974). *Asymptotic methods in enumeration*. SIAM Rev. **16**(4), pp. 485–515.
- P. Berglund, P. Candelas, X. de la Ossa, and et al. (1994). *Periods for Calabi-Yau and Landau-Ginzburg vacua*. Nuclear Phys. B **419**(2), pp. 352–403.
- A. Berkovich and B. M. McCoy (1998). *Rogers-Ramanujan Identities: A Century of Progress from Mathematics to Physics*. In *Proceedings of the International Congress of Mathematicians, Vol. III (Berlin, 1998)*, pp. 163–172.

- G. D. Bernard and A. Ishimaru (1962). *Tables of the Anger and Lommel-Weber Functions*. Technical Report 53 and AFCRL 796, University Washington Press, Seattle. Reviewed in *Math. Comp.*, v. 17 (1963), pp.315–317.
- B. C. Berndt (1972). *On the Hurwitz zeta-function*. *Rocky Mountain J. Math.* **2**(1), pp. 151–157.
- B. C. Berndt (1975a). *Character analogues of the Poisson and Euler-MacLaurin summation formulas with applications*. *J. Number Theory* **7**(4), pp. 413–445.
- B. C. Berndt (1975b). *Periodic Bernoulli numbers, summation formulas and applications*. In *Theory and Application of Special Functions (Proc. Advanced Sem., Math. Res. Center, Univ. Wisconsin, Madison, Wis., 1975)*, pp. 143–189. New York: Academic Press.
- B. C. Berndt (1989). *Ramanujan's Notebooks. Part II*. New York: Springer-Verlag.
- B. C. Berndt (1991). *Ramanujan's Notebooks. Part III*. Berlin-New York: Springer-Verlag.
- B. C. Berndt, S. Bhargava, and F. G. Garvan (1995). *Ramanujan's theories of elliptic functions to alternative bases*. *Trans. Amer. Math. Soc.* **347**(11), pp. 4163–4244.
- B. C. Berndt and R. J. Evans (1984). *Chapter 13 of Ramanujan's second notebook: Integrals and asymptotic expansions*. *Expo. Math.* **2**(4), pp. 289–347.
- M. V. Berry (1966). *Uniform approximation for potential scattering involving a rainbow*. *Proc. Phys. Soc.* **89**(3), pp. 479–490.
- M. V. Berry (1969). *Uniform approximation: A new concept in wave theory*. *Science Progress (Oxford)* **57**, pp. 43–64.
- M. V. Berry (1975). *Cusped rainbows and incoherence effects in the rippling-mirror model for particle scattering from surfaces*. *J. Phys. A* **8**(4), pp. 566–584.
- M. V. Berry (1976). *Waves and Thom's theorem*. *Advances in Physics* **25**(1), pp. 1–26.
- M. V. Berry (1977). *Focusing and twinkling: Critical exponents from catastrophes in non-Gaussian random short waves*. *J. Phys. A* **10**(12), pp. 2061–2081.
- M. V. Berry (1980). *Some Geometric Aspects of Wave Motion: Wavefront Dislocations, Diffraction Catastrophes, Diffractals*. In *Geometry of the Laplace Operator (Proc. Sympos. Pure Math., Univ. Hawaii, Honolulu, Hawaii, 1979)*, Volume 36, pp. 13–28. Providence, R.I.: Amer. Math. Soc.
- M. V. Berry (1981). *Singularities in Waves and Rays*. In R. Balian, M. Kléman, and J.-P. Poirier (Eds.), *Les Houches Lecture Series Session XXXV*, Volume 35, pp. 453–543. Amsterdam: North-Holland.
- M. V. Berry (1989). *Uniform asymptotic smoothing of Stokes's discontinuities*. *Proc. Roy. Soc. London Ser. A* **422**, pp. 7–21.
- M. V. Berry (1991). *Infinitely many Stokes smoothings in the gamma function*. *Proc. Roy. Soc. London Ser. A* **434**, pp. 465–472.
- M. V. Berry (1995). *The Riemann-Siegel expansion for the zeta function: High orders and remainders*. *Proc. Roy. Soc. London Ser. A* **450**, pp. 439–462.
- M. V. Berry and C. J. Howls (1990). *Stokes surfaces of diffraction catastrophes with codimension three*. *Nonlinearity* **3**(2), pp. 281–291.
- M. V. Berry and C. J. Howls (1991). *Hyperasymptotics for integrals with saddles*. *Proc. Roy. Soc. London Ser. A* **434**, pp. 657–675.
- M. V. Berry and C. J. Howls (1993). *Unfolding the high orders of asymptotic expansions with coalescing saddles: Singularity theory, crossover and duality*. *Proc. Roy. Soc. London Ser. A* **443**, pp. 107–126.
- M. V. Berry and C. J. Howls (1994). *Overlapping Stokes smoothings: Survival of the error function and canonical catastrophe integrals*. *Proc. Roy. Soc. London Ser. A* **444**, pp. 201–216.
- M. V. Berry and J. P. Keating (1992). *A new asymptotic representation for  $\zeta(\frac{1}{2} + it)$  and quantum spectral determinants*. *Proc. Roy. Soc. London Ser. A* **437**, pp. 151–173.
- M. V. Berry and J. P. Keating (1998).  *$H = xp$  and the Riemann Zeros*. In I. V. Lerner, J. P. Keating, and D. E. Khmel'nitskii (Eds.), *Supersymmetry and Trace Formulae: Chaos and Disorder*, pp. 355–367. New York: Plenum.
- M. V. Berry and J. P. Keating (1999). *The Riemann zeros and eigenvalue asymptotics*. *SIAM Rev.* **41**(2), pp. 236–266.
- M. V. Berry, J. F. Nye, and F. J. Wright (1979). *The elliptic umbilic diffraction catastrophe*. *Phil. Trans. Roy. Soc. Ser. A* **291**(1382), pp. 453–484.
- M. V. Berry and C. Upstill (1980). *Catastrophe optics: Morphologies of caustics and their diffraction patterns*. In E. Wolf (Ed.), *Progress in Optics*, Volume 18, pp. 257–346. Amsterdam: North-Holland.
- M. V. Berry and F. J. Wright (1980). *Phase-space projection identities for diffraction catastrophes*. *J. Phys. A* **13**(1), pp. 149–160.
- E. Berti and V. Cardoso (2006). *Quasinormal ringing of Kerr black holes: The excitation factors*. *Phys. Rev. D* **74**(104020), pp. 1–27.
- H. A. Bethe and E. E. Salpeter (1977). *Quantum Mechanics of One- and Two-electron Atoms* (Rosetta ed.). New York: Plenum Publishing Corp. Reprint (with corrections) of the original edition published in 1957 by Springer and Academic Press.

- F. Bethuel (1998). *Vortices in Ginzburg-Landau Equations*. In *Proceedings of the International Congress of Mathematicians, Vol. III (Berlin, 1998)*, pp. 11–19.
- V. Bezvoda, R. Farzan, K. Segeth, and G. Takó (1986). *On numerical evaluation of integrals involving Bessel functions*. *Apl. Mat.* **31**(5), pp. 396–410.
- A. Bhattacharjie and E. C. G. Sudarshan (1962). *A class of solvable potentials*. *Nuovo Cimento* (10) **25**, pp. 864–879.
- A. Bhattacharyya and L. Shafai (1988). *Theoretical and experimental investigation of the elliptical annular ring antenna*. *IEEE Trans. Antennas and Propagation* **36**(11), pp. 1526–1530.
- D. K. Bhaumik and S. K. Sarkar (2002). *On the power function of the likelihood ratio test for MANOVA*. *J. Multivariate Anal.* **82**(2), pp. 416–421.
- W. G. Bickley (1935). *Some solutions of the problem of forced convection*. *Philos. Mag. Series 7* **20**, pp. 322–343.
- W. G. Bickley, L. J. Comrie, J. C. P. Miller, D. H. Sadler, and A. J. Thompson (1952). *Bessel Functions. Part II: Functions of Positive Integer Order*. British Association for the Advancement of Science, Mathematical Tables, Volume 10. Cambridge: Cambridge University Press. Reprinted, with corrections, in 1960.
- W. G. Bickley and J. Nayler (1935). *A short table of the functions  $Ki_n(x)$ , from  $n = 1$  to  $n = 16$* . *Phil. Mag. Series 7* **20**, pp. 343–347.
- L. C. Biedenharn, R. L. Gluckstern, M. H. Hull, Jr., and G. Breit (1955). *Coulomb functions for large charges and small velocities*. *Phys. Rev. (2)* **97**(2), pp. 542–554.
- L. C. Biedenharn and J. D. Louck (1981). *Angular Momentum in Quantum Physics: Theory and Application*, Volume 8 of *Encyclopedia of Mathematics and its Applications*. Reading, MA.: Addison-Wesley Publishing Co.
- L. C. Biedenharn and H. van Dam (Eds.) (1965). *Quantum Theory of Angular Momentum. A Collection of Reprints and Original Papers*. New York: Academic Press.
- D. Bierens de Haan (1867). *Nouvelles Tables d'Intégrales Définies*. Leide: P. Engels. Corrected edition printed by Hafner Press, 1965.
- D. Bierens de Haan (1939). *Nouvelles Tables d'Intégrales Définies*. New York: G.E. Stechert & Co.
- L. J. Billera, C. Greene, R. Simion, and R. P. Stanley (Eds.) (1996). *Formal Power Series and Algebraic Combinatorics*, Volume 24 of *DIMACS Series in Discrete Mathematics and Theoretical Computer Science*. Providence, RI: American Mathematical Society.
- C. Bingham, T. Chang, and D. Richards (1992). *Approximating the matrix Fisher and Bingham distributions: Applications to spherical regression and Procrustes analysis*. *J. Multivariate Anal.* **41**(2), pp. 314–337.
- Å. Björck (1996). *Numerical Methods for Least Squares Problems*. Philadelphia, PA: Society for Industrial and Applied Mathematics (SIAM).
- J. M. Blair, C. A. Edwards, and J. H. Johnson (1976). *Rational Chebyshev approximations for the inverse of the error function*. *Math. Comp.* **30**(136), pp. 827–830.
- J. M. Blair, C. A. Edwards, and J. H. Johnson (1978). *Rational Chebyshev approximations for the Bickley functions  $Ki_n(x)$* . *Math. Comp.* **32**(143), pp. 876–886.
- G. Blanch (1964). *Numerical evaluation of continued fractions*. *SIAM Rev.* **6**(4), pp. 383–421.
- G. Blanch (1966). *Numerical aspects of Mathieu eigenvalues*. *Rend. Circ. Mat. Palermo* (2) **15**, pp. 51–97.
- G. Blanch and D. S. Clemm (1962). *Tables Relating to the Radial Mathieu Functions. Vol. 1: Functions of the First Kind*. Washington, D.C.: U.S. Government Printing Office.
- G. Blanch and D. S. Clemm (1965). *Tables Relating to the Radial Mathieu Functions. Vol. 2: Functions of the Second Kind*. Washington, D.C.: U.S. Government Printing Office.
- G. Blanch and D. S. Clemm (1969). *Mathieu's Equation for Complex Parameters. Tables of Characteristic Values*. Washington, D.C.: U.S. Government Printing Office.
- G. Blanch and I. Rhodes (1955). *Table of characteristic values of Mathieu's equation for large values of the parameter*. *J. Washington Acad. Sci.* **45**(6), pp. 166–196.
- W. E. Bleick and P. C. C. Wang (1974). *Asymptotics of Stirling numbers of the second kind*. *Proc. Amer. Math. Soc.* **42**(2), pp. 575–580. Erratum: same journal v. 48 (1975), p. 518.
- N. Bleistein (1966). *Uniform asymptotic expansions of integrals with stationary point near algebraic singularity*. *Comm. Pure Appl. Math.* **19**, pp. 353–370.
- N. Bleistein (1967). *Uniform asymptotic expansions of integrals with many nearby stationary points and algebraic singularities*. *J. Math. Mech.* **17**, pp. 533–559.
- N. Bleistein and R. A. Handelsman (1975). *Asymptotic Expansions of Integrals*. New York: Holt, Rinehart, and Winston. Reprinted with corrections by Dover Publications Inc., New York, 1986.
- I. Bloch, M. H. Hull, Jr., A. A. Broyles, W. G. Bouricius, B. E. Freeman, and G. Breit (1950). *Methods of calculation of radial wave functions and new tables of Coulomb functions*. *Physical Rev. (2)* **80**, pp. 553–560.
- I. Bloch, M. H. Hull, Jr., A. A. Broyles, W. G. Bouricius, B. E. Freeman, and G. Breit (1951). *Coulomb functions for reactions of protons and alpha-particles with the lighter nuclei*. *Rev. Modern Physics* **23**(2), pp. 147–182.

- R. Bo and R. Wong (1994). *Uniform asymptotic expansion of Charlier polynomials*. *Methods Appl. Anal.* **1**(3), pp. 294–313.
- R. Bo and R. Wong (1996). *Asymptotic behavior of the Polaczek polynomials and their zeros*. *Stud. Appl. Math.* **96**, pp. 307–338.
- R. Bo and R. Wong (1999). *A uniform asymptotic formula for orthogonal polynomials associated with  $\exp(-x^4)$* . *J. Approx. Theory* **98**, pp. 146–166.
- P. Boalch (2005). *From Klein to Painlevé via Fourier, Laplace and Jimbo*. *Proc. London Math. Soc.* (3) **90**(1), pp. 167–208.
- P. Boalch (2006). *The fifty-two icosahedral solutions to Painlevé VI*. *J. Reine Angew. Math.* **596**, pp. 183–214.
- A. Bobenko and A. Its (1995). *The Painlevé III equation and the Iwasawa decomposition*. *Manuscripta Math.* **87**(3), pp. 369–377.
- A. I. Bobenko (1991). *Constant mean curvature surfaces and integrable equations*. *Uspekhi Mat. Nauk* **46**(4(280)), pp. 3–42, 192. In Russian. English translation: *Russian Math. Surveys*, **46**(1991), no. 4, pp. 1–45.
- S. Bochner (1952). *Bessel functions and modular relations of higher type and hyperbolic differential equations*. *Comm. Sémin. Math. Univ. Lund [Medd. Lunds Univ. Mat. Sem.]* **1952**(Tome Supplémentaire), pp. 12–20.
- S. Bochner and W. T. Martin (1948). *Several Complex Variables*, Volume 10 of *Princeton Mathematical Series*. Princeton, N. J.: Princeton University Press.
- A. A. Bogush and V. S. Otchik (1997). *Problem of two Coulomb centres at large intercentre separation: Asymptotic expansions from analytical solutions of the Heun equation*. *J. Phys. A* **30**(2), pp. 559–571.
- M. Born and E. Wolf (1999). *Principles of Optics: Electromagnetic Theory of Propagation, Interference and Diffraction of Light* (7th ed.). Cambridge: Cambridge University Press.
- J. M. Borwein and P. B. Borwein (1987). *Pi and the AGM, A Study in Analytic Number Theory and Computational Complexity*. Canadian Mathematical Society Series of Monographs and Advanced Texts. New York: John Wiley & Sons Inc.
- J. M. Borwein and P. B. Borwein (1991). *A cubic counterpart of Jacobi's identity and the AGM*. *Trans. Amer. Math. Soc.* **323**(2), pp. 691–701.
- J. M. Borwein, D. M. Bradley, and R. E. Crandall (2000). *Computational strategies for the Riemann zeta function*. *J. Comput. Appl. Math.* **121**(1-2), pp. 247–296.
- J. M. Borwein and R. M. Corless (1999). *Emerging tools for experimental mathematics*. *Amer. Math. Monthly* **106**(10), pp. 889–909.
- J. M. Borwein and I. J. Zucker (1992). *Fast evaluation of the gamma function for small rational fractions using complete elliptic integrals of the first kind*. *IMA J. Numer. Anal.* **12**(4), pp. 519–526.
- D. L. Bosley (1996). *A technique for the numerical verification of asymptotic expansions*. *SIAM Rev.* **38**(1), pp. 128–135.
- W. Bosma and M.-P. van der Hulst (1990). *Faster Primality Testing*. In J.-J. Quisquater and J. Vandewalle (Eds.), *Advances in Cryptology—EUROCRYPT '89 Proceedings*, Volume 434 of *Lecture Notes in Computer Science*, New York, pp. 652–656. Springer-Verlag.
- T. Bountis, H. Segur, and F. Vivaldi (1982). *Integrable Hamiltonian systems and the Painlevé property*. *Phys. Rev. A* (3) **25**(3), pp. 1257–1264.
- P. Boutroux (1913). *Recherches sur les transcendentes de M. Painlevé et l'étude asymptotique des équations différentielles du second ordre*. *Ann. Sci. École Norm. Sup.* (3) **30**, pp. 255–375.
- C. J. Bouwkamp (1947). *On spheroidal wave functions of order zero*. *J. Math. Phys. Mass. Inst. Tech.* **26**, pp. 79–92.
- C. J. Bouwkamp (1948). *A note on Mathieu functions*. *Proc. Nederl. Akad. Wetensch.* **51**(7), pp. 891–893=*Indagationes Math.* **10**, 319–321 (1948).
- F. Bowman (1953). *Introduction to Elliptic Functions with Applications*. London: English Universities Press, Ltd. Reprinted by Dover Publications Inc., New York, 1961.
- F. Bowman (1958). *Introduction to Bessel Functions*. New York: Dover Publications Inc. Unaltered republication of the 1938 edition, published by Longmans, Green and Co., London-New York.
- J. P. Boyd (1998). *Weakly Nonlocal Solitary Waves and Beyond-All-Orders Asymptotics*, Volume 442 of *Mathematics and its Applications*. Boston-Dordrecht: Kluwer Academic Publishers.
- J. P. Boyd and A. Natarov (1998). *A Sturm-Liouville eigenproblem of the fourth kind: A critical latitude with equatorial trapping*. *Stud. Appl. Math.* **101**(4), pp. 433–455.
- W. G. C. Boyd (1973). *The asymptotic analysis of canonical problems in high-frequency scattering theory. II. The circular and parabolic cylinders*. *Proc. Cambridge Philos. Soc.* **74**, pp. 313–332.
- W. G. C. Boyd (1987). *Asymptotic expansions for the coefficient functions that arise in turning-point problems*. *Proc. Roy. Soc. London Ser. A* **410**, pp. 35–60.

- W. G. C. Boyd (1990a). *Asymptotic Expansions for the Coefficient Functions Associated with Linear Second-order Differential Equations: The Simple Pole Case*. In R. Wong (Ed.), *Asymptotic and Computational Analysis (Winnipeg, MB, 1989)*, Volume 124 of *Lecture Notes in Pure and Applied Mathematics*, pp. 53–73. New York: Dekker.
- W. G. C. Boyd (1990b). *Stieltjes transforms and the Stokes phenomenon*. *Proc. Roy. Soc. London Ser. A* **429**, pp. 227–246.
- W. G. C. Boyd (1993). *Error bounds for the method of steepest descents*. *Proc. Roy. Soc. London Ser. A* **440**, pp. 493–518.
- W. G. C. Boyd (1994). *Gamma function asymptotics by an extension of the method of steepest descents*. *Proc. Roy. Soc. London Ser. A* **447**, pp. 609–630.
- W. G. C. Boyd (1995). *Approximations for the late coefficients in asymptotic expansions arising in the method of steepest descents*. *Methods Appl. Anal.* **2**(4), pp. 475–489.
- W. G. C. Boyd and T. M. Dunster (1986). *Uniform asymptotic solutions of a class of second-order linear differential equations having a turning point and a regular singularity, with an application to Legendre functions*. *SIAM J. Math. Anal.* **17**(2), pp. 422–450.
- T. H. Boyer (1969). *Concerning the zeros of some functions related to Bessel functions*. *J. Mathematical Phys.* **10**(9), pp. 1729–1744.
- B. L. J. Braaksma and B. Meulenbeld (1967). *Integral transforms with generalized Legendre functions as kernels*. *Compositio Math.* **18**, pp. 235–287.
- M. Brack, M. Mehta, and K. Tanaka (2001). *Occurrence of periodic Lamé functions at bifurcations in chaotic Hamiltonian systems*. *J. Phys. A* **34**(40), pp. 8199–8220.
- N. Brazel, F. Lawless, and A. Wood (1992). *Exponential asymptotics for an eigenvalue of a problem involving parabolic cylinder functions*. *Proc. Amer. Math. Soc.* **114**(4), pp. 1025–1032.
- R. P. Brent (1976). *Fast multiple-precision evaluation of elementary functions*. *J. Assoc. Comput. Mach.* **23**(2), pp. 242–251.
- D. Bressoud and S. Wagon (2000). *A Course in Computational Number Theory*. Emeryville, CA: Key College Publishing. With 1 CD-ROM (Windows, Macintosh and UNIX) containing a collection of Mathematica programs for computations in number theory.
- D. M. Bressoud (1989). *Factorization and Primality Testing*. New York: Springer-Verlag.
- D. M. Bressoud (1999). *Proofs and Confirmations: The Story of the Alternating Sign Matrix Conjecture*. Cambridge: Cambridge University Press.
- E. Brézin, C. Itzykson, G. Parisi, and J. B. Zuber (1978). *Planar diagrams*. *Comm. Math. Phys.* **59**(1), pp. 35–51.
- C. Brezinski (1980). *Padé-type Approximation and General Orthogonal Polynomials*, Volume 50 of *International Series of Numerical Mathematics*. Basel: Birkhäuser Verlag.
- C. Brezinski (1999). *Error estimates for the solution of linear systems*. *SIAM J. Sci. Comput.* **21**(2), pp. 764–781.
- C. Brezinski and M. Redivo Zaglia (1991). *Extrapolation Methods. Theory and Practice*, Volume 2 of *Studies in Computational Mathematics*. Amsterdam: North-Holland Publishing Co. With 1 IBM-PC floppy disk (5.25 inch).
- E. Brieskorn and H. Knörrer (1986). *Plane Algebraic Curves*. Basel: Birkhäuser Verlag. Translated from the German by John Stillwell.
- J. Brillhart (1969). *On the Euler and Bernoulli polynomials*. *J. Reine Angew. Math.* **234**, pp. 45–64.
- D. M. Brink and G. R. Satchler (1993). *Angular Momentum* (3rd ed.). Oxford: Oxford University Press.
- British Association for the Advancement of Science (1937). *Bessel Functions. Part I: Functions of Orders Zero and Unity*. *Mathematical Tables*, Volume 6. Cambridge: Cambridge University Press.
- J. C. Bronski, L. D. Carr, B. Deconinck, J. N. Kutz, and K. Promislow (2001). *Stability of repulsive Bose-Einstein condensates in a periodic potential*. *Phys. Rev. E* (3) **63**(036612), pp. 1–11.
- J. Brüning (1984). *On the asymptotic expansion of some integrals*. *Arch. Math. (Basel)* **42**(3), pp. 253–259.
- Yu. A. Brychkov and K. O. Geddes (2005). *On the derivatives of the Bessel and Struve functions with respect to the order*. *Integral Transforms Spec. Funct.* **16**(3), pp. 187–198.
- H. Buchholz (1969). *The Confluent Hypergeometric Function with Special Emphasis on Its Applications*. New York: Springer-Verlag. Translated from the German by H. Lichtbau and K. Wetzel.
- J. D. Buckholtz (1963). *Concerning an approximation of Copson*. *Proc. Amer. Math. Soc.* **14**(4), pp. 564–568.
- J. Buhler, R. Crandall, R. Ernvall, T. Metsänkylä, and M. A. Shokrollahi (2001). *Irregular primes and cyclotomic invariants to 12 million*. *J. Symbolic Comput.* **31**(1-2), pp. 89–96. *Computational algebra and number theory (Milwaukee, WI, 1996)*.
- J. P. Buhler, R. E. Crandall, and R. W. Sompolski (1992). *Irregular primes to one million*. *Math. Comp.* **59**(200), pp. 717–722.
- W. Bühring (1987a). *An analytic continuation of the hypergeometric series*. *SIAM J. Math. Anal.* **18**(3), pp. 884–889.

- W. Bühring (1987b). *The behavior at unit argument of the hypergeometric function  ${}_3F_2$* . SIAM J. Math. Anal. **18**(5), pp. 1227–1234.
- W. Bühring (1988). *An analytic continuation formula for the generalized hypergeometric function*. SIAM J. Math. Anal. **19**(5), pp. 1249–1251.
- W. Bühring (1992). *Generalized hypergeometric functions at unit argument*. Proc. Amer. Math. Soc. **114**(1), pp. 145–153.
- W. Bühring (1994). *The double confluent Heun equation: Characteristic exponent and connection formulae*. Methods Appl. Anal. **1**(3), pp. 348–370.
- R. Bulirsch (1965a). *Numerical calculation of elliptic integrals and elliptic functions*. Numer. Math. **7**(1), pp. 78–90. Algol 60 programs are included for real and complex elliptic integrals, and for Jacobian elliptic functions of real argument.
- R. Bulirsch (1965b). *Numerical calculation of elliptic integrals and elliptic functions. II*. Numer. Math. **7**(4), pp. 353–354. An improved Algol 60 program for the complete elliptic integral of the third kind is included, but superseded by a program in Bulirsch (1969b).
- R. Bulirsch (1967). *Numerical calculation of the sine, cosine and Fresnel integrals*. Numer. Math. **9**(5), pp. 380–385. Algol 60 procedures for sine, cosine, and 2 Fresnel integrals are included.
- R. Bulirsch (1969a). *An extension of the Bartky-transformation to incomplete elliptic integrals of the third kind*. Numer. Math. **13**(3), pp. 266–284.
- R. Bulirsch (1969b). *Numerical calculation of elliptic integrals and elliptic functions. III*. Numer. Math. **13**(4), pp. 305–315. Algol 60 programs for the incomplete elliptic integral of the third kind, and for a general complete elliptic integral, are included.
- R. Bulirsch and H. Rutishauser (1968). *Interpolation und genäherte Quadratur*. In R. Sauer and I. Szabó (Eds.), *Mathematische Hilfsmittel des Ingenieurs. Teil III*, Volume 141 of *Die Grundlehren der mathematischen Wissenschaften in Einzeldarstellungen*, pp. 232–319. Berlin: Springer-Verlag.
- R. Bulirsch and J. Stoer (1968). *II. Darstellung von Funktionen in Rechenautomaten*. In R. Sauer and I. Szabó (Eds.), *Mathematische Hilfsmittel des Ingenieurs. Teil III*. Berlin-New York: Springer-Verlag.
- P. S. Bullen (1998). *A Dictionary of Inequalities*, Volume 97 of *Pitman Monographs and Surveys in Pure and Applied Mathematics*. Harlow: Longman.
- J. L. Burchnall and T. W. Chaundy (1940). *Expansions of Appell's double hypergeometric functions*. Quart. J. Math., Oxford Ser. **11**, pp. 249–270.
- J. L. Burchnall and T. W. Chaundy (1941). *Expansions of Appell's double hypergeometric functions. II*. Quart. J. Math., Oxford Ser. **12**, pp. 112–128.
- J. L. Burchnall and T. W. Chaundy (1948). *The hypergeometric identities of Cayley, Orr, and Bailey*. Proc. London Math. Soc. (2) **50**, pp. 56–74.
- A. Burgess (1963). *The determination of phases and amplitudes of wave functions*. Proc. Phys. Soc. **81**(3), pp. 442–452.
- T. W. Burkhardt and T. Xue (1991). *Density profiles in confined critical systems and conformal invariance*. Phys. Rev. Lett. **66**(7), pp. 895–898.
- W. S. Burnside and A. W. Panton (1960). *The Theory of Equations: With an Introduction to the Theory of Binary Algebraic Forms*. New York: Dover Publications. Two volumes. A reproduction of the seventh edition [vol. 1, Longmans, Green, London 1912; vol. 2, Longmans, Green, London 1928].
- A. I. Burshtein and S. I. Temkin (1994). *Spectroscopy of Molecular Rotation in Gases and Liquids*. Cambridge: Cambridge University Press.
- N. M. Burunova (1960). *A Guide to Mathematical Tables: Supplement No. 1*. New York: Pergamon Press. Supplement to “A Guide to Mathematical Tables” by A. V. Lebedev and R. M. Fedorova.
- T. Busch, B.-G. Englert, K. Rzażewski, and M. Wilkens (1998). *Two cold atoms in a harmonic trap*. Found. Phys. **28**(4), pp. 549–559.
- P. J. Bushell (1987). *On a generalization of Barton's integral and related integrals of complete elliptic integrals*. Math. Proc. Cambridge Philos. Soc. **101**(1), pp. 1–5.
- J. C. Butcher (1987). *The Numerical Analysis of Ordinary Differential Equations. Runge-Kutta and General Linear Methods*. Chichester: John Wiley & Sons Ltd.
- J. C. Butcher (2003). *Numerical Methods for Ordinary Differential Equations*. Chichester: John Wiley & Sons Ltd.
- R. W. Butler and A. T. A. Wood (2002). *Laplace approximations for hypergeometric functions with matrix argument*. Ann. Statist. **30**(4), pp. 1155–1177.
- R. W. Butler and A. T. A. Wood (2003). *Laplace approximation for Bessel functions of matrix argument*. J. Comput. Appl. Math. **155**(2), pp. 359–382.
- P. L. Butzer, S. Flocke, and M. Hauss (1994). *Euler functions  $E_\alpha(z)$  with complex  $\alpha$  and applications*. In G. Anastassiou and S. T. Rachev (Eds.), *Approximation, probability, and related fields (Santa Barbara, CA, 1993)*, pp. 127–150. New York: Plenum Press.
- P. L. Butzer and M. Hauss (1992). *Riemann zeta function: Rapidly converging series and integral representations*. Appl. Math. Lett. **5**(2), pp. 83–88.

- P. L. Butzer, M. Hauss, and M. Leclerc (1992). *Bernoulli numbers and polynomials of arbitrary complex indices*. Appl. Math. Lett. **5**(6), pp. 83–88.
- J. G. Byatt-Smith (2000). *The Borel transform and its use in the summation of asymptotic expansions*. Stud. Appl. Math. **105**(2), pp. 83–113.
- W. E. Byerly (1888). *Elements of the Integral Calculus* (2nd ed.). Boston: Ginn & Co. Reprinted by G. E. Stechert, New York, 1926.
- P. F. Byrd and M. D. Friedman (1971). *Handbook of Elliptic Integrals for Engineers and Scientists* (2nd ed.). Die Grundlehren der mathematischen Wissenschaften, Band 67. New York: Springer-Verlag. Table errata: Math. Comp. v. 66 (1997), no. 220, p. 1767, v. 36 (1981), no. 153, p. 317,319, v. 26 (1972), no. 118, p. 597.
- L. G. Cabral-Rosetti and M. A. Sanchis-Lozano (2000). *Generalized hypergeometric functions and the evaluation of scalar one-loop integrals in Feynman diagrams*. J. Comput. Appl. Math. **115**(1-2), pp. 93–99.
- F. Cajori (1929). *A History of Mathematical Notations, Volume II*. Chicago: Open Court Publishing Company. Reprinted by Cosimo in 2007.
- F. Calogero (1978). *Asymptotic behaviour of the zeros of the (generalized) Laguerre polynomial  $L_n^\alpha(x)$  as the index  $\alpha \rightarrow \infty$  and limiting formula relating Laguerre polynomials of large index and large argument to Hermite polynomials*. Lett. Nuovo Cimento (2) **23**(3), pp. 101–102.
- J. Camacho, R. Guimerà, and L. A. N. Amaral (2002). *Analytical solution of a model for complex food webs*. Phys. Rev. E **65**(3), pp. (030901–1)–(030901–4).
- P. J. Cameron (1994). *Combinatorics: Topics, Techniques, Algorithms*. Cambridge: Cambridge University Press.
- J. B. Campbell (1980). *On Temme’s algorithm for the modified Bessel function of the third kind*. ACM Trans. Math. Software **6**(4), pp. 581–586.
- R. Campbell (1955). *Théorie Générale de L’Équation de Mathieu et de quelques autres Équations différentielles de la mécanique*. Paris: Masson et Cie.
- R. G. Campos (1995). *A quadrature formula for the Hankel transform*. Numer. Algorithms **9**(2), pp. 343–354.
- S. M. Candel (1981). *An algorithm for the Fourier-Bessel transform*. Comput. Phys. Comm. **23**(4), pp. 343–353.
- L. Carlitz (1953). *Some congruences for the Bernoulli numbers*. Amer. J. Math. **75**(1), pp. 163–172.
- L. Carlitz (1954a). *A note on Euler numbers and polynomials*. Nagoya Math. J. **7**, pp. 35–43.
- L. Carlitz (1954b).  *$q$ -Bernoulli and Eulerian numbers*. Trans. Amer. Math. Soc. **76**(2), pp. 332–350.
- L. Carlitz (1958). *Expansions of  $q$ -Bernoulli numbers*. Duke Math. J. **25**(2), pp. 355–364.
- L. Carlitz (1960). *Note on Nörlund’s polynomial  $B_n^{(z)}$* . Proc. Amer. Math. Soc. **11**(3), pp. 452–455.
- L. Carlitz (1961a). *A recurrence formula for  $\zeta(2n)$* . Proc. Amer. Math. Soc. **12**(6), pp. 991–992.
- L. Carlitz (1961b). *The Staudt-Clausen theorem*. Math. Mag. **34**, pp. 131–146.
- L. Carlitz (1963). *The inverse of the error function*. Pacific J. Math. **13**(2), pp. 459–470.
- R. D. Carlitz (1972, June). *Hadronic matter at high density*. Phys. Rev. D **5**(12), pp. 3231–3242.
- B. C. Carlson (1961a). *Ellipsoidal distributions of charge or mass*. J. Mathematical Phys. **2**, pp. 441–450.
- B. C. Carlson (1961b). *Some series and bounds for incomplete elliptic integrals*. J. Math. and Phys. **40**, pp. 125–134.
- B. C. Carlson (1963). *Lauricella’s hypergeometric function  $F_D$* . J. Math. Anal. Appl. **7**(3), pp. 452–470.
- B. C. Carlson (1964). *Normal elliptic integrals of the first and second kinds*. Duke Math. J. **31**(3), pp. 405–419.
- B. C. Carlson (1965). *On computing elliptic integrals and functions*. J. Math. and Phys. **44**, pp. 36–51.
- B. C. Carlson (1966). *Some inequalities for hypergeometric functions*. Proc. Amer. Math. Soc. **17**(1), pp. 32–39.
- B. C. Carlson (1970). *Inequalities for a symmetric elliptic integral*. Proc. Amer. Math. Soc. **25**(3), pp. 698–703.
- B. C. Carlson (1971). *New proof of the addition theorem for Gegenbauer polynomials*. SIAM J. Math. Anal. **2**, pp. 347–351.
- B. C. Carlson (1972a). *An algorithm for computing logarithms and arctangents*. Math. Comp. **26**(118), pp. 543–549.
- B. C. Carlson (1972b). *Intégrales à deux formes quadratiques*. C. R. Acad. Sci. Paris Sér. A–B **274** (15 May, 1972, Sér. A), pp. 1458–1461.
- B. C. Carlson (1976). *Quadratic transformations of Appell functions*. SIAM J. Math. Anal. **7**(2), pp. 291–304.
- B. C. Carlson (1977a). *Elliptic integrals of the first kind*. SIAM J. Math. Anal. **8**(2), pp. 231–242.
- B. C. Carlson (1977b). *Special Functions of Applied Mathematics*. New York: Academic Press.
- B. C. Carlson (1978). *Short proofs of three theorems on elliptic integrals*. SIAM J. Math. Anal. **9**(3), pp. 524–528.
- B. C. Carlson (1979). *Computing elliptic integrals by duplication*. Numer. Math. **33**(1), pp. 1–16.



- B. C. Carlson (1985). *The hypergeometric function and the R-function near their branch points*. Rend. Sem. Mat. Univ. Politec. Torino (Fascicolo Speciale), pp. 63–89.
- B. C. Carlson (1987). *A table of elliptic integrals of the second kind*. Math. Comp. **49**(180), pp. 595–606, S13–S17.
- B. C. Carlson (1988). *A table of elliptic integrals of the third kind*. Math. Comp. **51**(183), pp. 267–280, S1–S5.
- B. C. Carlson (1990). *Landen Transformations of Integrals*. In R. Wong (Ed.), *Asymptotic and Computational Analysis (Winnipeg, MB, 1989)*, Volume 124 of *Lecture Notes in Pure and Appl. Math.*, pp. 75–94. New York-Basel: Marcel Dekker.
- B. C. Carlson (1995). *Numerical computation of real or complex elliptic integrals*. Numer. Algorithms **10**(1-2), pp. 13–26.
- B. C. Carlson (1998). *Elliptic Integrals: Symmetry and Symbolic Integration*. In *Tricomi's Ideas and Contemporary Applied Mathematics (Rome/Turin, 1997)*, Volume 147 of *Atti dei Convegni Lincei*, pp. 161–181. Rome: Accad. Naz. Lincei.
- B. C. Carlson (1999). *Toward symbolic integration of elliptic integrals*. J. Symbolic Comput. **28**(6), pp. 739–753.
- B. C. Carlson (2002). *Three improvements in reduction and computation of elliptic integrals*. J. Res. Nat. Inst. Standards Tech. **107**(5), pp. 413–418.
- B. C. Carlson (2004). *Symmetry in  $c$ ,  $d$ ,  $n$  of Jacobian elliptic functions*. J. Math. Anal. Appl. **299**(1), pp. 242–253.
- B. C. Carlson (2005). *Jacobian elliptic functions as inverses of an integral*. J. Comput. Appl. Math. **174**(2), pp. 355–359.
- B. C. Carlson (2006a). *Some reformulated properties of Jacobian elliptic functions*. J. Math. Anal. Appl. **323**(1), pp. 522–529.
- B. C. Carlson (2006b). *Table of integrals of squared Jacobian elliptic functions and reductions of related hypergeometric R-functions*. Math. Comp. **75**(255), pp. 1309–1318.
- B. C. Carlson (2008). *Power series for inverse Jacobian elliptic functions*. Math. Comp. **77**(263), pp. 1615–1621.
- B. C. Carlson and J. FitzSimons (2000). *Reduction theorems for elliptic integrands with the square root of two quadratic factors*. J. Comput. Appl. Math. **118**(1-2), pp. 71–85.
- B. C. Carlson and J. L. Gustafson (1985). *Asymptotic expansion of the first elliptic integral*. SIAM J. Math. Anal. **16**(5), pp. 1072–1092.
- B. C. Carlson and J. L. Gustafson (1994). *Asymptotic approximations for symmetric elliptic integrals*. SIAM J. Math. Anal. **25**(2), pp. 288–303.
- B. C. Carlson and G. S. Rushbrooke (1950). *On the expansion of a Coulomb potential in spherical harmonics*. Proc. Cambridge Philos. Soc. **46**, pp. 626–633.
- L. D. Carr, C. W. Clark, and W. P. Reinhardt (2000). *Stationary solutions of the one-dimensional nonlinear Schrödinger equation. I. Case of repulsive nonlinearity*. Phys. Rev. A **62**(063610), pp. 1–10.
- H. S. Carslaw (1930). *Introduction to the Theory of Fourier's Series and Integrals* (3rd ed.). London: Macmillan. Reprinted by Dover, New York, 1950.
- H. S. Carslaw and J. C. Jaeger (1959). *Conduction of Heat in Solids* (2nd ed.). Oxford: Clarendon Press.
- J. R. Cash and R. V. M. Zahar (1994). *A Unified Approach to Recurrence Algorithms*. In R. V. M. Zahar (Ed.), *Approximation and Computation (West Lafayette, IN, 1993)*, Volume 119 of *International Series of Computational Mathematics*, pp. 97–120. Boston, MA: Birkhäuser Boston.
- A. Cayley (1895). *An Elementary Treatise on Elliptic Functions*. London: George Bell and Sons. Republished by Dover Publications, Inc., New York, 1961. Table erratum: Math. Comp. v. 29 (1975), no. 130, p. 670.
- R. Cazenave (1969). *Intégrales et Fonctions Elliptiques en Vue des Applications*. Préface de Henri Villat. Publications Scientifiques et Techniques du Ministère de l'Air, No. 452. Paris: Centre de Documentation de l'Armement.
- H. H. Chan (1998). *On Ramanujan's cubic transformation formula for  ${}_2F_1\left(\frac{1}{3}, \frac{2}{3}; 1; z\right)$* . Math. Proc. Cambridge Philos. Soc. **124**(2), pp. 193–204.
- S. Chandrasekhar (1984). *The Mathematical Theory of Black Holes*. In *General Relativity and Gravitation (Padova, 1983)*, pp. 5–26. Dordrecht: Reidel.
- F. Chapeau-Blondeau and A. Monir (2002). *Numerical evaluation of the Lambert W function and application to generation of generalized Gaussian noise with exponent 1/2*. IEEE Trans. Signal Process. **50**(9), pp. 2160–2165.
- C. J. Chapman (1999). *Caustics in cylindrical ducts*. Proc. Roy. Soc. London Ser. A **455**, pp. 2529–2548.
- B. W. Char (1980). *On Stieltjes' continued fraction for the gamma function*. Math. Comp. **34**(150), pp. 547–551.
- M. A. Chaudhry, N. M. Temme, and E. J. M. Veling (1996). *Asymptotics and closed form of a generalized incomplete gamma function*. J. Comput. Appl. Math. **67**(2), pp. 371–379.
- M. A. Chaudhry and S. M. Zubair (1994). *Generalized incomplete gamma functions with applications*. J. Comput. Appl. Math. **55**(1), pp. 99–124.
- M. A. Chaudhry and S. M. Zubair (2001). *On a Class of Incomplete Gamma Functions with Applications*. Boca Raton, FL: Chapman & Hall/CRC.
- T. W. Chaundy (1969). *Elementary Differential Equations*. Oxford: Clarendon Press.

- P. L. Chebyshev (1851). *Sur la fonction qui détermine la totalité des nombres premiers inférieurs à une limite donnée*. Mem. Ac. Sc. St. Pétersbourg **6**, pp. 141–157.
- M. Chellali (1988). *Accélération de calcul de nombres de Bernoulli*. J. Number Theory **28**(3), pp. 347–362.
- R. Chelluri, L. B. Richmond, and N. M. Temme (2000). *Asymptotic estimates for generalized Stirling numbers*. Analysis (Munich) **20**(1), pp. 1–13.
- J.-r. Chen (1966). *On the representation of a large even integer as the sum of a prime and the product of at most two primes*. Kexue Tongbao (Foreign Lang. Ed.) **17**, pp. 385–386.
- L.-C. Chen, M. E. H. Ismail, and P. Simeonov (1999). *Asymptotics of Racah coefficients and polynomials*. J. Phys. A **32**(3), pp. 537–553.
- Y. Chen and M. E. H. Ismail (1998). *Asymptotics of the largest zeros of some orthogonal polynomials*. J. Phys. A **31**(25), pp. 5525–5544.
- E. W. Cheney (1982). *Introduction to Approximation Theory* (2nd ed.). New York: Chelsea Publishing Co. Reprinted by AMS Chelsea Publishing, Providence, RI, 1998.
- I. Cherednik (1995). *Macdonald's evaluation conjectures and difference Fourier transform*. Invent. Math. **122**(1), pp. 119–145. Erratum: see same journal **125**(1996), no. 2, p. 391.
- T. M. Cherry (1948). *Expansions in terms of parabolic cylinder functions*. Proc. Edinburgh Math. Soc. (2) **8**, pp. 50–65.
- C. Chester, B. Friedman, and F. Ursell (1957). *An extension of the method of steepest descents*. Proc. Cambridge Philos. Soc. **53**, pp. 599–611.
- C. Chiccoli, S. Lorenzutta, and G. Maino (1987). *A numerical method for generalized exponential integrals*. Comput. Math. Appl. **14**(4), pp. 261–268.
- C. Chiccoli, S. Lorenzutta, and G. Maino (1988). *On the evaluation of generalized exponential integrals  $E_\nu(x)$* . J. Comput. Phys. **78**(2), pp. 278–287.
- C. Chiccoli, S. Lorenzutta, and G. Maino (1990). *An algorithm for exponential integrals of real order*. Computing **45**(3), pp. 269–276. Includes Fortran code.
- L. Chihara (1987). *On the zeros of the Askey-Wilson polynomials, with applications to coding theory*. SIAM J. Math. Anal. **18**(1), pp. 191–207.
- T. S. Chihara (1978). *An Introduction to Orthogonal Polynomials*, Volume 13 of *Mathematics and its Applications*. New York: Gordon and Breach Science Publishers.
- T. S. Chihara and M. E. H. Ismail (1993). *Extremal measures for a system of orthogonal polynomials*. Constr. Approx. **9**, pp. 111–119.
- Y. Chikuse (2003). *Statistics on Special Manifolds*, Volume 174 of *Lecture Notes in Statistics*. New York: Springer-Verlag.
- R. C. Y. Chin and G. W. Hedstrom (1978). *A dispersion analysis for difference schemes: Tables of generalized Airy functions*. Math. Comp. **32**(144), pp. 1163–1170.
- B. K. Choudhury (1995). *The Riemann zeta-function and its derivatives*. Proc. Roy. Soc. London Ser. A **450**, pp. 477–499.
- Y. Chow, L. Gatteschi, and R. Wong (1994). *A Bernstein-type inequality for the Jacobi polynomial*. Proc. Amer. Math. Soc. **121**(3), pp. 703–709.
- N. B. Christensen (1990). *Optimized fast Hankel transform filters*. Geophysical Prospecting **38**(5), pp. 545–568.
- J. S. Christiansen and M. E. H. Ismail (2006). *A moment problem and a family of integral evaluations*. Trans. Amer. Math. Soc. **358**(9), pp. 4071–4097.
- R. F. Christy and I. Duck (1961).  *$\gamma$  rays from an extranuclear direct capture process*. Nuclear Physics **24**(1), pp. 89–101.
- G. Chrystal (1959). *Algebra: An Elementary Textbook for the Higher Classes of Secondary Schools and for Colleges* (6th ed.), Volume 1. New York: Chelsea Publishing Co. A seventh edition (reprinting of the sixth edition) was published by AMS Chelsea Publishing Series, American Mathematical Society, 1964.
- D. V. Chudnovsky and G. V. Chudnovsky (1988). *Approximations and Complex Multiplication According to Ramanujan*. In G. E. Andrews, R. A. Askey, B. C. Bernd, K. G. Ramanathan, and R. A. Rankin (Eds.), *Ramanujan Revisited (Urbana-Champaign, Ill., 1987)*, pp. 375–472. Boston, MA: Academic Press.
- C. K. Chui (1988). *Multivariate Splines*, Volume 54 of *CBMS-NSF Regional Conference Series in Applied Mathematics*. Philadelphia, PA: Society for Industrial and Applied Mathematics (SIAM). With an appendix by Harvey Diamond.
- A. Ciarkowski (1989). *Uniform asymptotic expansion of an integral with a saddle point, a pole and a branch point*. Proc. Roy. Soc. London Ser. A **426**, pp. 273–286.
- R. Cicchetti and A. Faraone (2004). *Incomplete Hankel and modified Bessel functions: A class of special functions for electromagnetics*. IEEE Trans. Antennas and Propagation **52**(12), pp. 3373–3389.
- G. M. Cicuta and E. Montaldi (1975). *Remarks on the full asymptotic expansion of Feynman parametrized integrals*. Lett. Nuovo Cimento (2) **13**(8), pp. 310–312.
- C. W. Clark (1979). *Coulomb phase shift*. American Journal of Physics **47**(8), pp. 683–684.

- F. Clarke (1989). *The universal von Staudt theorems*. Trans. Amer. Math. Soc. **315**(2), pp. 591–603.
- P. A. Clarkson (1991). *Nonclassical Symmetry Reductions and Exact Solutions for Physically Significant Nonlinear Evolution Equations*. In W. Rozmus and J. A. Tuszynski (Eds.), *Nonlinear and Chaotic Phenomena in Plasmas, Solids and Fluids (Edmonton, AB, 1990)*, pp. 72–79. Singapore: World Scientific Publishing.
- P. A. Clarkson (2003a). *The third Painlevé equation and associated special polynomials*. J. Phys. A **36**(36), pp. 9507–9532.
- P. A. Clarkson (2003b). *The fourth Painlevé equation and associated special polynomials*. J. Math. Phys. **44**(11), pp. 5350–5374.
- P. A. Clarkson (2005). *Special polynomials associated with rational solutions of the fifth Painlevé equation*. J. Comput. Appl. Math. **178**(1-2), pp. 111–129.
- P. A. Clarkson (2006). *Painlevé Equations—Nonlinear Special Functions: Computation and Application*. In F. Marcellàn and W. van Assche (Eds.), *Orthogonal Polynomials and Special Functions*, Volume 1883 of *Lecture Notes in Math.*, pp. 331–411. Berlin: Springer.
- P. A. Clarkson and E. L. Mansfield (2003). *The second Painlevé equation, its hierarchy and associated special polynomials*. Nonlinearity **16**(3), pp. R1–R26.
- P. A. Clarkson and J. B. McLeod (1988). *A connection formula for the second Painlevé transcendent*. Arch. Rational Mech. Anal. **103**(2), pp. 97–138.
- T. Clausen (1828). *Über die Fälle, wenn die Reihe von der Form  $y = 1 + \frac{\alpha}{1} \cdot \frac{\beta}{\gamma} x + \frac{\alpha \cdot \alpha + 1}{1 \cdot 2} \cdot \frac{\beta \cdot \beta + 1}{\gamma \cdot \gamma + 1} x^2 + \text{etc.}$  ein Quadrat von der Form  $z = 1 + \frac{\alpha'}{1} \cdot \frac{\beta'}{\gamma'} \cdot \frac{\delta'}{\epsilon'} x + \frac{\alpha' \cdot \alpha' + 1}{1 \cdot 2} \cdot \frac{\beta' \cdot \beta' + 1}{\gamma' \cdot \gamma' + 1} \cdot \frac{\delta' \cdot \delta' + 1}{\epsilon' \cdot \epsilon' + 1} x^2 + \text{etc.}$  hat*. J. Reine Angew. Math. **3**, pp. 89–91.
- W. W. Clendenin (1966). *A method for numerical calculation of Fourier integrals*. Numer. Math. **8**(5), pp. 422–436.
- C. W. Clenshaw (1955). *A note on the summation of Chebyshev series*. Math. Tables Aids Comput. **9**(51), pp. 118–120.
- C. W. Clenshaw (1957). *The numerical solution of linear differential equations in Chebyshev series*. Proc. Cambridge Philos. Soc. **53**(1), pp. 134–149.
- C. W. Clenshaw (1962). *Chebyshev Series for Mathematical Functions*. National Physical Laboratory Mathematical Tables, Vol. 5. Department of Scientific and Industrial Research. London: Her Majesty's Stationery Office.
- C. W. Clenshaw and A. R. Curtis (1960). *A method for numerical integration on an automatic computer*. Numer. Math. **2**(4), pp. 197–205.
- C. W. Clenshaw, D. W. Lozier, F. W. J. Olver, and P. R. Turner (1986). *Generalized exponential and logarithmic functions*. Comput. Math. Appl. Part B **12**(5-6), pp. 1091–1101.
- C. W. Clenshaw and F. W. J. Olver (1984). *Beyond floating point*. J. Assoc. Comput. Mach. **31**(2), pp. 319–328.
- C. W. Clenshaw, F. W. J. Olver, and P. R. Turner (1989). *Level-Index Arithmetic: An Introductory Survey*. In P. R. Turner (Ed.), *Numerical Analysis and Parallel Processing (Lancaster, 1987)*, Volume 1397 of *Lecture Notes in Math.*, pp. 95–168. Berlin-Heidelberg: Springer.
- L. D. Cloutman (1989). *Numerical evaluation of the Fermi-Dirac integrals*. The Astrophysical Journal Supplement Series **71**, pp. 677–699. Double-precision Fortran, maximum precision 12D.
- J. A. Cochran (1963). *Further formulas for calculating approximate values of the zeros of certain combinations of Bessel functions*. IEEE Trans. Microwave Theory Tech. **11**(6), pp. 546–547.
- J. A. Cochran (1964). *Remarks on the zeros of cross-product Bessel functions*. J. Soc. Indust. Appl. Math. **12**(3), pp. 580–587.
- J. A. Cochran (1965). *The zeros of Hankel functions as functions of their order*. Numer. Math. **7**(3), pp. 238–250.
- J. A. Cochran (1966a). *The analyticity of cross-product Bessel function zeros*. Proc. Cambridge Philos. Soc. **62**, pp. 215–226.
- J. A. Cochran (1966b). *The asymptotic nature of zeros of cross-product Bessel functions*. Quart. J. Mech. Appl. Math. **19**(4), pp. 511–522.
- J. A. Cochran and J. N. Hoffspiegel (1970). *Numerical techniques for finding  $\nu$ -zeros of Hankel functions*. Math. Comp. **24**(110), pp. 413–422.
- W. J. Cody (1965a). *Chebyshev approximations for the complete elliptic integrals  $K$  and  $E$* . Math. Comp. **19**(89), pp. 105–112.
- W. J. Cody (1965b). *Chebyshev polynomial expansions of complete elliptic integrals*. Math. Comp. **19**(90), pp. 249–259.
- W. J. Cody (1968). *Chebyshev approximations for the Fresnel integrals*. Math. Comp. **22**(102), pp. 450–453. with Microfiche Supplement.
- W. J. Cody (1969). *Rational Chebyshev approximations for the error function*. Math. Comp. **23**(107), pp. 631–637.
- W. J. Cody (1970). *A survey of practical rational and polynomial approximation of functions*. SIAM Rev. **12**(3), pp. 400–423.
- W. J. Cody and K. E. Hillstrom (1967). *Chebyshev approximations for the natural logarithm of the gamma function*. Math. Comp. **21**(98), pp. 198–203.

- W. J. Cody and K. E. Hillstrom (1970). *Chebyshev approximations for the Coulomb phase shift*. Math. Comp. **24**(111), pp. 671–677. Corrigendum: same journal, **26**(1972), p. 1031.
- W. J. Cody, K. E. Hillstrom, and H. C. Thacher, Jr. (1971). *Chebyshev approximations for the Riemann zeta function*. Math. Comp. **25**(115), pp. 537–547.
- W. J. Cody, K. A. Paciorek, and H. C. Thacher, Jr. (1970). *Chebyshev approximations for Dawson's integral*. Math. Comp. **24**(109), pp. 171–178.
- W. J. Cody, A. J. Strecok, and H. C. Thacher, Jr. (1973). *Chebyshev approximations for the psi function*. Math. Comp. **27**(121), pp. 123–127.
- W. J. Cody and H. C. Thacher, Jr. (1968). *Rational Chebyshev approximations for the exponential integral  $E_1(x)$* . Math. Comp. **22**(103), pp. 641–649.
- W. J. Cody and H. C. Thacher, Jr. (1969). *Chebyshev approximations for the exponential integral  $Ei(x)$* . Math. Comp. **23**(106), pp. 289–303.
- W. J. Cody and W. Waite (1980). *Software Manual for the Elementary Functions*. Englewood Cliffs: Prentice-Hall.
- H. Cohen (1993). *A Course in Computational Algebraic Number Theory*. Berlin-New York: Springer-Verlag.
- J. P. Coleman (1987). *Polynomial approximations in the complex plane*. J. Comput. Appl. Math. **18**(2), pp. 193–211.
- J. P. Coleman and A. J. Monaghan (1983). *Chebyshev expansions for the Bessel function  $J_n(z)$  in the complex plane*. Math. Comp. **40**(161), pp. 343–366.
- L. Collatz (1960). *The Numerical Treatment of Differential Equations* (3rd ed.), Volume 60 of *Die Grundlehren der Mathematischen Wissenschaften*. Berlin: Springer. Translated by P. G. Williams from a supplemented version of the 2d German edition.
- D. Colton and R. Kress (1998). *Inverse Acoustic and Electromagnetic Scattering Theory* (2nd ed.), Volume 93 of *Applied Mathematical Sciences*. Berlin: Springer-Verlag.
- L. Comtet (1974). *Advanced Combinatorics: The Art of Finite and Infinite Expansions* (enlarged ed.). Dordrecht: D. Reidel Publishing Co. Revised and enlarged English translation by D. Reidel of *Analyse Combinatoire*, Tomes I, II, Presses Universitaires de France, Paris, 1970.
- S. Conde and S. L. Kalla (1979). *The  $\nu$ -zeros of  $J_{-\nu}(x)$* . Math. Comp. **33**(145), pp. 423–426.
- S. Conde and S. L. Kalla (1981). *On zeros of the hypergeometric function*. Serdica **7**(3), pp. 243–249.
- E. U. Condon and G. H. Shortley (1935). *The Theory of Atomic Spectra*. Cambridge: Cambridge University Press. Reprinted with corrections in 1991. Transferred to digital reprinting, 1999.
- W. C. Connett, C. Markett, and A. L. Schwartz (1993). *Product formulas and convolutions for angular and radial spheroidal wave functions*. Trans. Amer. Math. Soc. **338**(2), pp. 695–710.
- J. N. L. Connor (1973). *Evaluation of multidimensional canonical integrals in semiclassical collision theory*. Molecular Phys. **26**(6), pp. 1371–1377.
- J. N. L. Connor (1974). *Semiclassical theory of molecular collisions: Many nearly coincident classical trajectories*. Molecular Phys. **27**(4), pp. 853–866.
- J. N. L. Connor (1976). *Catastrophes and molecular collisions*. Molecular Phys. **31**(1), pp. 33–55.
- J. N. L. Connor and P. R. Curtis (1982). *A method for the numerical evaluation of the oscillatory integrals associated with the cuspid catastrophes: Application to Pearcey's integral and its derivatives*. J. Phys. A **15**(4), pp. 1179–1190.
- J. N. L. Connor, P. R. Curtis, and D. Farrelly (1983). *A differential equation method for the numerical evaluation of the Airy, Pearcey and swallowtail canonical integrals and their derivatives*. Molecular Phys. **48**(6), pp. 1305–1330.
- J. N. L. Connor and D. Farrelly (1981). *Molecular collisions and cusp catastrophes: Three methods for the calculation of Pearcey's integral and its derivatives*. Chem. Phys. Lett. **81**(2), pp. 306–310.
- J. N. L. Connor and D. C. Mackay (1979). *Calculation of angular distributions in complex angular momentum theories of elastic scattering*. Molecular Physics **37**(6), pp. 1703–1712.
- A. G. Constantine (1963). *Some non-central distribution problems in multivariate analysis*. Ann. Math. Statist. **34**(4), pp. 1270–1285.
- E. D. Constantinides and R. J. Marhefka (1993). *Efficient and accurate computation of the incomplete Airy functions*. Radio Science **28**(4), pp. 441–457.
- J. W. Cooley and J. W. Tukey (1965). *An algorithm for the machine calculation of complex Fourier series*. Math. Comp. **19**(90), pp. 297–301.
- R. Cools (2003). *An encyclopaedia of cubature formulas*. J. Complexity **19**(3), pp. 445–453. Numerical integration and its complexity (Oberwolfach, 2001).
- F. Cooper, A. Khare, and A. Saxena (2006). *Exact elliptic compactons in generalized Korteweg-de Vries equations*. Complexity **11**(6), pp. 30–34.

- M. D. Cooper, R. H. Jeppesen, and M. B. Johnson (1979). *Coulomb effects in the Klein-Gordon equation for pions*. Phys. Rev. C **20**(2), pp. 696–704.
- R. B. Cooper (1981). *Introduction to Queueing Theory* (2nd ed.). New York: North-Holland Publishing Co.
- E. T. Copson (1933). *An approximation connected with  $e^{-x}$* . Proc. Edinburgh Math. Soc. (2) **3**, pp. 201–206.
- E. T. Copson (1935). *An Introduction to the Theory of Functions of a Complex Variable*. Oxford: Oxford University Press.
- E. T. Copson (1963). *On the asymptotic expansion of Airy's integral*. Proc. Glasgow Math. Assoc. **6**, pp. 113–115.
- E. T. Copson (1965). *Asymptotic Expansions*. Number 55 in Cambridge Tracts in Mathematics and Mathematical Physics. New York: Cambridge University Press.
- R. M. Corless, G. H. Gonnet, D. E. G. Hare, D. J. Jeffrey, and D. E. Knuth (1996). *On the Lambert W function*. Adv. Comput. Math. **5**(4), pp. 329–359.
- R. M. Corless, D. J. Jeffrey, and H. Rasmussen (1992). *Numerical evaluation of Airy functions with complex arguments*. J. Comput. Phys. **99**(1), pp. 106–114.
- G. Cornell, J. H. Silverman, and G. Stevens (Eds.) (1997). *Modular Forms and Fermat's Last Theorem*. New York: Springer-Verlag.
- H. Cornille and A. Martin (1972). *Constraints on the phase of scattering amplitudes due to positivity*. Nuclear Phys. B **49**, pp. 413–440.
- H. Cornille and A. Martin (1974). *Constraints on the phases of helicity amplitudes due to positivity*. Nuclear Phys. B **77**, pp. 141–162.
- P. Cornille (1972). *Computation of Hankel transforms*. SIAM Rev. **14**(2), pp. 278–285.
- M. S. Corrington (1961). *Applications of the complex exponential integral*. Math. Comp. **15**(73), pp. 1–6.
- C. M. Cosgrove (2006). *Chazy's second-degree Painlevé equations*. J. Phys. A **39**(39), pp. 11955–11971.
- O. Costin (1999). *Correlation between pole location and asymptotic behavior for Painlevé I solutions*. Comm. Pure Appl. Math. **52**(4), pp. 461–478.
- D. A. Cox (1984). *The arithmetic-geometric mean of Gauss*. Enseign. Math. (2) **30**(3-4), pp. 275–330.
- D. A. Cox (1985). *Gauss and the arithmetic-geometric mean*. Notices Amer. Math. Soc. **32**(2), pp. 147–151.
- R. Crandall and C. Pomerance (2005). *Prime Numbers: A Computational Perspective* (2nd ed.). New York: Springer-Verlag.
- R. E. Crandall (1996). *Topics in Advanced Scientific Computation*. New York: TELOS/Springer-Verlag.
- J. E. Cremona (1997). *Algorithms for Modular Elliptic Curves* (2nd ed.). Cambridge: Cambridge University Press.
- J. Crisóstomo, S. Lepe, and J. Saavedra (2004). *Quasinormal modes of the extremal BTZ black hole*. Classical Quantum Gravity **21**(12), pp. 2801–2809.
- D. C. Cronmeyer (1991). *Demagnetization factors for general ellipsoids*. J. Appl. Phys. **70**(6), pp. 2911–2914. For an erratum concerning availability of tables, see J. Appl. Phys. **70**(1991)7660.
- B. Crstici and G. Tudor (1975). *Compléments au traité de D. S. Mitrinović. VII. Sur une inégalité de D. S. Mitrinović*. Univ. Beograd. Publ. Elektrotehn. Fak. Ser. Mat. Fiz. (498-541), pp. 153–154.
- A. Cruz, J. Esparza, and J. Sesma (1991). *Zeros of the Hankel function of real order out of the principal Riemann sheet*. J. Comput. Appl. Math. **37**(1-3), pp. 89–99.
- A. Cruz and J. Sesma (1982). *Zeros of the Hankel function of real order and of its derivative*. Math. Comp. **39**(160), pp. 639–645.
- A. Csóto and G. M. Hale (1997). *S-matrix and R-matrix determination of the low-energy  $^5\text{He}$  and  $^5\text{Li}$  resonance parameters*. Phys. Rev. C **55**(1), pp. 536–539.
- A. R. Curtis (1964a). *Coulomb Wave Functions*, Volume 11 of *Roy. Soc. Math. Tables*. Cambridge: Cambridge University Press.
- A. R. Curtis (1964b). *Tables of Jacobian Elliptic Functions Whose Arguments are Rational Fractions of the Quarter Period*, Volume 7 of *National Physical Laboratory Mathematical Tables*. London: Her Majesty's Stationery Office.
- A. Cuyt, V. B. Petersen, B. Verdonk, H. Waadeland, and W. B. Jones (2008). *Handbook of Continued Fractions for Special Functions*. New York: Springer.
- D. Cvijović and J. Klinowski (1994). *On the integration of incomplete elliptic integrals*. Proc. Roy. Soc. London Ser. A **444**, pp. 525–532.
- D. Cvijović and J. Klinowski (1999). *Integrals involving complete elliptic integrals*. J. Comput. Appl. Math. **106**(1), pp. 169–175.
- G. M. D'Ariano, C. Macchiavello, and M. G. A. Paris (1994). *Detection of the density matrix through optical homodyne tomography without filtered back projection*. Phys. Rev. A **50**(5), pp. 4298–4302.
- H. Davenport (2000). *Multiplicative Number Theory* (3rd ed.), Volume 74 of *Graduate Texts in Mathematics*. New York: Springer-Verlag. Revised and with a preface by Hugh L. Montgomery.

- B. Davies (1973). *Complex zeros of linear combinations of spherical Bessel functions and their derivatives*. SIAM J. Math. Anal. **4**(1), pp. 128–133.
- B. Davies (1984). *Integral Transforms and their Applications* (2nd ed.), Volume 25 of *Applied Mathematical Sciences*. New York: Springer-Verlag.
- H. F. Davis and A. D. Snider (1987). *Introduction to Vector Analysis* (5th ed.). Boston, MA: Allyn and Bacon Inc. Seventh edition printed by WCB/McGraw-Hill, 1995.
- H. T. Davis (1933). *Tables of Higher Mathematical Functions I*. Bloomington, Indiana: Principia Press.
- P. J. Davis (1975). *Interpolation and Approximation*. New York: Dover Publications Inc. Republication of the original 1963 edition (Blaisdell Publishing Co.), with minor corrections and a new preface and bibliography.
- P. J. Davis and P. Rabinowitz (1984). *Methods of Numerical Integration* (2nd ed.). Computer Science and Applied Mathematics. Orlando, FL: Academic Press Inc.
- S. D. Daymond (1955). *The principal frequencies of vibrating systems with elliptic boundaries*. Quart. J. Mech. Appl. Math. **8**(3), pp. 361–372.
- C. de Boor (2001). *A Practical Guide to Splines* (Revised ed.), Volume 27 of *Applied Mathematical Sciences*. New York: Springer-Verlag.
- L. de Branges (1985). *A proof of the Bieberbach conjecture*. Acta Math. **154**(1-2), pp. 137–152.
- N. G. de Bruijn (1937). *Integralen voor de  $\zeta$ -functie van Riemann*. Mathematica (Zutphen) **B5**, pp. 170–180. In Dutch.
- N. G. de Bruijn (1961). *Asymptotic Methods in Analysis* (2nd ed.). Bibliotheca Mathematica, Vol. IV. Amsterdam: North-Holland Publishing Co.
- N. G. de Bruijn (1981). *Pólya's Theory of Counting*. In E. F. Beckenbach (Ed.), *Applied Combinatorial Mathematics*, pp. 144–184. Malabar, FL: Robert E. Krieger.
- M. G. de Bruin, E. B. Saff, and R. S. Varga (1981a). *On the zeros of generalized Bessel polynomials. I*. Nederl. Akad. Wetensch. Indag. Math. **84**(1), pp. 1–13.
- M. G. de Bruin, E. B. Saff, and R. S. Varga (1981b). *On the zeros of generalized Bessel polynomials. II*. Nederl. Akad. Wetensch. Indag. Math. **84**(1), pp. 14–25.
- C.-J. de la Vallée Poussin (1896a). *Recherches analytiques sur la théorie des nombres premiers. Première partie. La fonction  $\zeta(s)$  de Riemann et les nombres premiers en général, suivi d'un Appendice sur des réflexions applicables à une formule donnée par Riemann*. Ann. Soc. Sci. Bruxelles **20**, pp. 183–256. Reprinted in Collected works/Oeuvres scientifiques, Vol. I, pp. 223–296 Académie Royale de Belgique, Brussels, 2000.
- C.-J. de la Vallée Poussin (1896b). *Recherches analytiques sur la théorie des nombres premiers. Deuxième partie. Les fonctions de Dirichlet et les nombres premiers de la forme linéaire  $Mx+N$* . Ann. Soc. Sci. Bruxelles **20**, pp. 281–397. Reprinted in Collected works/Oeuvres scientifiques, Vol. I, pp. 309–425, Académie Royale de Belgique, Brussels, 2000.
- A. de Shalit and I. Talmi (1963). *Nuclear Shell Theory*. Pure and Applied Physics, Vol. 14. New York: Academic Press. Reprinted by Dover Publications Inc., New York, 2004.
- P. Dean (1966). *The constrained quantum mechanical harmonic oscillator*. Proc. Cambridge Philos. Soc. **62**, pp. 277–286.
- S. R. Deans (1983). *The Radon Transform and Some of Its Applications*. A Wiley-Interscience Publication. New York: John Wiley & Sons Inc. Reprinted by Dover in 2007.
- A. Debosscher (1998). *Unification of one-dimensional Fokker-Planck equations beyond hypergeometrics: Factorizer solution method and eigenvalue schemes*. Phys. Rev. E (3) **57**(1), pp. 252–275.
- A. Decarreau, M.-C. Dumont-Lepage, P. Maroni, A. Robert, and A. Ronveaux (1978a). *Formes canoniques des équations confluentes de l'équation de Heun*. Ann. Soc. Sci. Bruxelles Sér. I **92**(1-2), pp. 53–78.
- A. Decarreau, P. Maroni, and A. Robert (1978b). *Sur les équations confluentes de l'équation de Heun*. Ann. Soc. Sci. Bruxelles Sér. I **92**(3), pp. 151–189.
- B. Deconinck, M. Heil, A. Bobenko, M. van Hoeij, and M. Schmies (2004). *Computing Riemann theta functions*. Math. Comp. **73**(247), pp. 1417–1442.
- B. Deconinck and J. N. Kutz (2006). *Computing spectra of linear operators using the Floquet-Fourier-Hill method*. J. Comput. Phys. **219**(1), pp. 296–321.
- B. Deconinck and H. Segur (1998). *The KP equation with quasiperiodic initial data*. Phys. D **123**(1-4), pp. 123–152. Nonlinear waves and solitons in physical systems (Los Alamos, NM, 1997).
- B. Deconinck and H. Segur (2000). *Pole dynamics for elliptic solutions of the Korteweg-de Vries equation*. Math. Phys. Anal. Geom. **3**(1), pp. 49–74.
- B. Deconinck and M. van Hoeij (2001). *Computing Riemann matrices of algebraic curves*. Phys. D **152/153**, pp. 28–46.
- P. A. Deift (1998). *Orthogonal Polynomials and Random Matrices: A Riemann-Hilbert Approach*, Volume 3 of *Courant Lecture Notes in Mathematics*. New York: New York University Courant Institute of Mathematical Sciences.
- P. A. Deift and X. Zhou (1995). *Asymptotics for the Painlevé II equation*. Comm. Pure Appl. Math. **48**(3), pp. 277–337.

- L. Dekar, L. Chetouani, and T. F. Hammann (1999). *Wave function for smooth potential and mass step*. Phys. Rev. A **59**(1), pp. 107–112.
- K. Dekker and J. G. Verwer (1984). *Stability of Runge-Kutta Methods for Stiff Nonlinear Differential Equations*, Volume 2 of *CWI Monographs*. Amsterdam: North-Holland Publishing Co.
- H. Delange (1987). *Sur les zéros imaginaires des polynômes de Bernoulli*. C. R. Acad. Sci. Paris Sér. I Math. **304**(6), pp. 147–150.
- H. Delange (1988). *On the real roots of Euler polynomials*. Monatsh. Math. **106**(2), pp. 115–138.
- H. Delange (1991). *Sur les zéros réels des polynômes de Bernoulli*. Ann. Inst. Fourier (Grenoble) **41**(2), pp. 267–309.
- M. Deléglise and J. Rivat (1996). *Computing  $\pi(x)$ : The Meissel, Lehmer, Lagarias, Miller, Odlyzko method*. Math. Comp. **65**(213), pp. 235–245.
- G. Delic (1979). *Chebyshev series for the spherical Bessel function  $j_i(r)$* . Comput. Phys. Comm. **18**(1), pp. 73–86.
- P. Deligne, P. Etingof, D. S. Freed, D. Kazhdan, J. W. Morgan, and D. R. Morrison (Eds.) (1999). *Quantum Fields and Strings: A Course for Mathematicians. Vol. 1, 2*. Providence, RI: American Mathematical Society. Material from the Special Year on Quantum Field Theory held at the Institute for Advanced Study, Princeton, NJ, 1996–1997.
- J. B. Dence and T. P. Dence (1999). *Elements of the Theory of Numbers*. San Diego, CA: Harcourt/Academic Press.
- R. L. Devaney (1986). *An Introduction to Chaotic Dynamical Systems*. Menlo Park, CA: The Benjamin/Cummings Publishing Co. Inc.
- J. Dexter and E. Agol (2009). *A fast new public code for computing photon orbits in a Kerr spacetime*. The Astrophysical Journal **696**, pp. 1616–1629.
- S. C. Dhar (1940). *Note on the addition theorem of parabolic cylinder functions*. J. Indian Math. Soc. (N. S.) **4**, pp. 29–30.
- P. Di Francesco, P. Ginsparg, and J. Zinn-Justin (1995). *2D gravity and random matrices*. Phys. Rep. **254**(1-2), pp. 1–133.
- L. E. Dickson (1919). *History of the Theory of Numbers (3 volumes)*. Washington, DC: Carnegie Institution of Washington. Reprinted by Chelsea Publishing Co., New York, 1966.
- A. R. DiDonato (1978). *An approximation for  $\int_x^\infty e^{-t^2/2} t^p dt$ ,  $x > 0$ ,  $p$  real*. Math. Comp. **32**(141), pp. 271–275.
- A. R. DiDonato and A. H. Morris (1986). *Computation of the incomplete gamma function ratios and their inverses*. ACM Trans. Math. Software **12**(4), pp. 377–393.
- P. Dienes (1931). *The Taylor Series*. Oxford: Oxford University Press. Reprinted by Dover Publications Inc., New York, 1957.
- A. Dienstfrey and J. Huang (2006). *Integral representations for elliptic functions*. J. Math. Anal. Appl. **316**(1), pp. 142–160.
- K. Dilcher (1987a). *Asymptotic behaviour of Bernoulli, Euler, and generalized Bernoulli polynomials*. J. Approx. Theory **49**(4), pp. 321–330.
- K. Dilcher (1987b). *Irreducibility of certain generalized Bernoulli polynomials belonging to quadratic residue class characters*. J. Number Theory **25**(1), pp. 72–80.
- K. Dilcher (1988). *Zeros of Bernoulli, generalized Bernoulli and Euler polynomials*. Mem. Amer. Math. Soc. **73**(386), pp. iv+94.
- K. Dilcher (1996). *Sums of products of Bernoulli numbers*. J. Number Theory **60**(1), pp. 23–41.
- K. Dilcher (2002). *Bernoulli Numbers and Confluent Hypergeometric Functions*. In *Number Theory for the Millennium, I (Urbana, IL, 2000)*, pp. 343–363. Natick, MA: A. K. Peters.
- K. Dilcher (2008). *On multiple zeros of Bernoulli polynomials*. Acta Arith. **134**(2), pp. 149–155.
- K. Dilcher, L. Skula, and I. Sh. Slavutskii (1991). *Bernoulli Numbers. Bibliography (1713–1990)*, Volume 87 of *Queen's Papers in Pure and Applied Mathematics*. Kingston, ON: Queen's University.
- A. M. Din (1981). *A simple sum formula for Clebsch-Gordan coefficients*. Lett. Math. Phys. **5**(3), pp. 207–211.
- D. Ding (2000). *A simplified algorithm for the second-order sound fields*. J. Acoust. Soc. Amer. **108**(6), pp. 2759–2764.
- H. Ding, K. I. Gross, and D. St. P. Richards (1996). *Ramanujan's master theorem for symmetric cones*. Pacific J. Math. **175**(2), pp. 447–490.
- R. B. Dingle (1973). *Asymptotic Expansions: Their Derivation and Interpretation*. London-New York: Academic Press.
- P. G. L. Dirichlet (1837). *Beweis des Satzes, dass jede unbegrenzte arithmetische Progression, deren erstes Glied und Differenz ganze Zahlen ohne gemeinschaftlichen Factor sind, unendlich viele Primzahlen enthält*. Abhandlungen der Königlich Preussischen Akademie der Wissenschaften von 1837, pp. 45–81. Reprinted in G. Lejeune Dirichlet's Werke, Band I, pp. 313–342, Reimer, Berlin, 1889 and with corrections in G. Lejeune Dirichlet's Werke, AMS Chelsea Publishing Series, Providence, RI, 1969.

- P. G. L. Dirichlet (1849). *Über die Bestimmung der mittleren Werthe in der Zahlentheorie*. Abhandlungen der Königlich Preussischen Akademie der Wissenschaften von 1849, pp. 69–83. Reprinted in G. Lejeune Dirichlet's Werke, Band II, pp. 49–66, Reimer, Berlin, 1897 and with corrections in G. Lejeune Dirichlet's Werke, AMS Chelsea Publishing Series, Providence, RI, 1969.
- A. L. Dixon and W. L. Ferrar (1930). *Infinite integrals in the theory of Bessel functions*. Quart. J. Math., Oxford Ser. **1**(1), pp. 122–145.
- M. D'Ocagne (1904). *Sur une classe de nombres rationnels réductibles aux nombres de Bernoulli*. Bull. Sci. Math. (2) **28**, pp. 29–32.
- G. Doetsch (1955). *Handbuch der Laplace-Transformation. Bd. II. Anwendungen der Laplace-Transformation. 1. Abteilung*. Basel und Stuttgart: Birkhäuser Verlag.
- G. C. Donovan, J. S. Geronimo, and D. P. Hardin (1999). *Orthogonal polynomials and the construction of piecewise polynomial smooth wavelets*. SIAM J. Math. Anal. **30**(5), pp. 1029–1056.
- B. Döring (1966). *Complex zeros of cylinder functions*. Math. Comp. **20**(94), pp. 215–222. For a numerical error in one of the zeros see Amos (1985).
- B. Döring (1971). *Über die Doppelnullstellen der Ableitung der Besselfunktion*. Angewandte Informatik **13**, pp. 402–406.
- J. Dougall (1907). *On Vandermonde's theorem, and some more general expansions*. Proc. Edinburgh Math. Soc. **25**, pp. 114–132.
- P. G. Drazin and R. S. Johnson (1993). *Solitons: An Introduction*. Cambridge Texts in Applied Mathematics. Cambridge: Cambridge University Press.
- P. G. Drazin and W. H. Reid (1981). *Hydrodynamic Stability*. Cambridge: Cambridge University Press. Cambridge Monographs on Mechanics and Applied Mathematics.
- B. Dubrovin and M. Mazzocco (2000). *Monodromy of certain Painlevé-VI transcendents and reflection groups*. Invent. Math. **141**(1), pp. 55–147.
- B. A. Dubrovin (1981). *Theta functions and non-linear equations*. Uspekhi Mat. Nauk **36**(2(218)), pp. 11–80. With an appendix by I. M. Krichever. In Russian. English translation: Russian Math. Surveys **36**(1981), no. 2, pp. 11–92 (1982).
- J. J. Duistermaat (1974). *Oscillatory integrals, Lagrange immersions and unfolding of singularities*. Comm. Pure Appl. Math. **27**, pp. 207–281.
- D. S. Dummit and R. M. Foote (1999). *Abstract Algebra* (2nd ed.). Englewood Cliffs, NJ: Prentice Hall Inc.
- D. Dumont and G. Viennot (1980). *A combinatorial interpretation of the Seidel generation of Genocchi numbers*. Ann. Discrete Math. **6**, pp. 77–87. Combinatorial mathematics, optimal designs and their applications (Proc. Sympos. Combin. Math. and Optimal Design, Colorado State Univ., Fort Collins, Colo., 1978).
- C. F. Dunkl and Y. Xu (2001). *Orthogonal Polynomials of Several Variables*, Volume 81 of *Encyclopedia of Mathematics and its Applications*. Cambridge: Cambridge University Press.
- B. I. Dunlap and B. R. Judd (1975). *Novel identities for simple  $n$ - $j$  symbols*. J. Mathematical Phys. **16**, pp. 318–319.
- G. V. Dunne and K. Rao (2000). *Lamé instantons*. J. High Energy Phys. (electronic only, article id. JHEP01(2000)019, 8 pp.).
- T. M. Dunster (1986). *Uniform asymptotic expansions for prolate spheroidal functions with large parameters*. SIAM J. Math. Anal. **17**(6), pp. 1495–1524.
- T. M. Dunster (1989). *Uniform asymptotic expansions for Whittaker's confluent hypergeometric functions*. SIAM J. Math. Anal. **20**(3), pp. 744–760. (This reference has several typographical errors.).
- T. M. Dunster (1990a). *Bessel functions of purely imaginary order, with an application to second-order linear differential equations having a large parameter*. SIAM J. Math. Anal. **21**(4), pp. 995–1018. Errata: In eq. (2.8) replace  $(x^2/4)^2$  by  $(x^2/4)^s$ . In the second line of eq. (4.7) insert an external factor  $e^{-2\pi ij/3}$  and change the upper limit of the sum to  $n - 1$ .
- T. M. Dunster (1990b). *Uniform asymptotic solutions of second-order linear differential equations having a double pole with complex exponent and a coalescing turning point*. SIAM J. Math. Anal. **21**(6), pp. 1594–1618.
- T. M. Dunster (1991). *Conical functions with one or both parameters large*. Proc. Roy. Soc. Edinburgh Sect. A **119**(3-4), pp. 311–327.
- T. M. Dunster (1992). *Uniform asymptotic expansions for oblate spheroidal functions I: Positive separation parameter  $\lambda$* . Proc. Roy. Soc. Edinburgh Sect. A **121**(3-4), pp. 303–320.
- T. M. Dunster (1994a). *Uniform asymptotic approximation of Mathieu functions*. Methods Appl. Anal. **1**(2), pp. 143–168.
- T. M. Dunster (1994b). *Uniform asymptotic solutions of second-order linear differential equations having a simple pole and a coalescing turning point in the complex plane*. SIAM J. Math. Anal. **25**(2), pp. 322–353.
- T. M. Dunster (1995). *Uniform asymptotic expansions for oblate spheroidal functions II: Negative separation parameter  $\lambda$* . Proc. Roy. Soc. Edinburgh Sect. A **125**(4), pp. 719–737.



- T. M. Dunster (1996a). *Asymptotic solutions of second-order linear differential equations having almost coalescent turning points, with an application to the incomplete gamma function*. Proc. Roy. Soc. London Ser. A **452**, pp. 1331–1349.
- T. M. Dunster (1996b). *Asymptotics of the generalized exponential integral, and error bounds in the uniform asymptotic smoothing of its Stokes discontinuities*. Proc. Roy. Soc. London Ser. A **452**, pp. 1351–1367.
- T. M. Dunster (1996c). *Error bounds for exponentially improved asymptotic solutions of ordinary differential equations having irregular singularities of rank one*. Methods Appl. Anal. **3**(1), pp. 109–134.
- T. M. Dunster (1997). *Error analysis in a uniform asymptotic expansion for the generalised exponential integral*. J. Comput. Appl. Math. **80**(1), pp. 127–161.
- T. M. Dunster (1999). *Asymptotic approximations for the Jacobi and ultraspherical polynomials, and related functions*. Methods Appl. Anal. **6**(3), pp. 21–56.
- T. M. Dunster (2001a). *Convergent expansions for solutions of linear ordinary differential equations having a simple turning point, with an application to Bessel functions*. Stud. Appl. Math. **107**(3), pp. 293–323.
- T. M. Dunster (2001b). *Uniform asymptotic expansions for Charlier polynomials*. J. Approx. Theory **112**(1), pp. 93–133.
- T. M. Dunster (2001c). *Uniform asymptotic expansions for the reverse generalized Bessel polynomials, and related functions*. SIAM J. Math. Anal. **32**(5), pp. 987–1013.
- T. M. Dunster (2003a). *Uniform asymptotic approximations for the Whittaker functions  $M_{\kappa, i\mu}(z)$  and  $W_{\kappa, i\mu}(z)$* . Anal. Appl. (Singap.) **1**(2), pp. 199–212.
- T. M. Dunster (2003b). *Uniform asymptotic expansions for associated Legendre functions of large order*. Proc. Roy. Soc. Edinburgh Sect. A **133**(4), pp. 807–827.
- T. M. Dunster (2004). *Convergent expansions for solutions of linear ordinary differential equations having a simple pole, with an application to associated Legendre functions*. Stud. Appl. Math. **113**(3), pp. 245–270.
- T. M. Dunster (2006). *Uniform asymptotic approximations for incomplete Riemann zeta functions*. J. Comput. Appl. Math. **190**(1-2), pp. 339–353.
- T. M. Dunster, D. A. Lutz, and R. Schäfke (1993). *Convergent Liouville-Green expansions for second-order linear differential equations, with an application to Bessel functions*. Proc. Roy. Soc. London Ser. A **440**, pp. 37–54.
- T. M. Dunster, R. B. Paris, and S. Cang (1998). *On the high-order coefficients in the uniform asymptotic expansion for the incomplete gamma function*. Methods Appl. Anal. **5**(3), pp. 223–247.
- A. J. Durán (1993). *Functions with given moments and weight functions for orthogonal polynomials*. Rocky Mountain J. Math. **23**, pp. 87–104.
- A. J. Durán and F. A. Grünbaum (2005). *A survey on orthogonal matrix polynomials satisfying second order differential equations*. J. Comput. Appl. Math. **178**(1-2), pp. 169–190.
- L. Durand (1975). *Nicholson-type Integrals for Products of Gegenbauer Functions and Related Topics*. In R. A. Askey (Ed.), *Theory and Application of Special Functions (Proc. Advanced Sem., Math. Res. Center, Univ. Wisconsin, Madison, Wis., 1975)*, pp. 353–374. Math. Res. Center, Univ. Wisconsin, Publ. No. 35. New York: Academic Press.
- L. Durand (1978). *Product formulas and Nicholson-type integrals for Jacobi functions. I. Summary of results*. SIAM J. Math. Anal. **9**(1), pp. 76–86.
- P. L. Duren (1991). *The Legendre Relation for Elliptic Integrals*. In J. H. Ewing and F. W. Gehring (Eds.), *Paul Halmos: Celebrating 50 Years of Mathematics*, pp. 305–315. New York: Springer-Verlag.
- J. Dutka (1981). *The incomplete beta function—a historical profile*. Arch. Hist. Exact Sci. **24**(1), pp. 11–29.
- A. Dzieciol, S. Yngve, and P. O. Fröman (1999). *Coulomb wave functions with complex values of the variable and the parameters*. J. Math. Phys. **40**(12), pp. 6145–6166.
- J. Écalle (1981a). *Les fonctions réurgentes. Tome I*. Orsay: Université de Paris-Sud Département de Mathématique.
- J. Écalle (1981b). *Les fonctions réurgentes. Tome II*. Orsay: Université de Paris-Sud Département de Mathématique.
- C. Eckart (1930). *The penetration of a potential barrier by electrons*. Phys. Rev. **35**(11), pp. 1303–1309.
- A. R. Edmonds (1974). *Angular Momentum in Quantum Mechanics* (3rd printing, with corrections, 2nd ed.). Princeton, NJ: Princeton University Press. Reprinted in 1996.
- H. M. Edwards (1974). *Riemann's Zeta Function*. New York-London: Academic Press. Pure and Applied Mathematics, Vol. 58. Reprinted by Dover Publications Inc., Mineola, NY, 2001.
- J. Edwards (1954). *A Treatise on the Integral Calculus*, Volume 1-2. New York: Chelsea Publishing Co. Originally published by Macmillan, 1921-1930.
- M. Edwards, D. A. Griggs, P. L. Holman, C. W. Clark, S. L. Rolston, and W. D. Phillips (1999). *Properties of a Raman atom-laser output coupler*. J. Phys. B **32**(12), pp. 2935–2950.

- G. P. Egorychev (1984). *Integral Representation and the Computation of Combinatorial Sums*, Volume 59 of *Translations of Mathematical Monographs*. Providence, RI: American Mathematical Society. Translated from the Russian by H. H. McFadden, Translation edited by Lev J. Leifman.
- U. T. Ehrenmark (1995). *The numerical inversion of two classes of Kontorovich-Lebedev transform by direct quadrature*. *J. Comput. Appl. Math.* **61**(1), pp. 43–72.
- M. Eichler and D. Zagier (1982). *On the zeros of the Weierstrass  $\wp$ -function*. *Math. Ann.* **258**(4), pp. 399–407.
- Á. Elbert (2001). *Some recent results on the zeros of Bessel functions and orthogonal polynomials*. *J. Comput. Appl. Math.* **133**(1-2), pp. 65–83.
- Á. Elbert and A. Laforgia (1994). *Interlacing properties of the zeros of Bessel functions*. *Atti Sem. Mat. Fis. Univ. Modena* **XLII**(2), pp. 525–529.
- Á. Elbert and A. Laforgia (1997). *An upper bound for the zeros of the derivative of Bessel functions*. *Rend. Circ. Mat. Palermo* (2) **46**(1), pp. 123–130.
- Á. Elbert and A. Laforgia (2000). *Further results on McMahon's asymptotic approximations*. *J. Phys. A* **33**(36), pp. 6333–6341.
- E. Elizalde (1986). *An asymptotic expansion for the first derivative of the generalized Riemann zeta function*. *Math. Comp.* **47**(175), pp. 347–350.
- E. Elizalde (1995). *Ten Physical Applications of Spectral Zeta Functions*, Volume 35 of *Lecture Notes in Physics. New Series m: Monographs*. Berlin: Springer-Verlag.
- D. Elliott (1971). *Uniform asymptotic expansions of the Jacobi polynomials and an associated function*. *Math. Comp.* **25**(114), pp. 309–315.
- D. Elliott (1998). *The Euler-Maclaurin formula revisited*. *J. Austral. Math. Soc. Ser. B* **40**(E), pp. E27–E76 (electronic).
- E. B. Elliott (1903). *A formula including Legendre's  $EK' + KE' - KK' = \frac{1}{2}\pi$* . *Messenger of Math.* **33**, pp. 31–32. Errata on p. 45 of the same volume.
- W. J. Ellison (1971). *Waring's problem*. *Amer. Math. Monthly* **78**(1), pp. 10–36.
- S. P. Eraševskaja, E. A. Ivanov, A. A. Pal'cev, and N. D. Sokolova (1973). *Tablicy sferoidal'nyh volnovykh funkci i ih pervykh proizvodnyh. Tom I*. Minsk: Izdat. "Nauka i Tehnika". Translated title: *Tables of Spheroidal Wave Functions and Their First Derivatives*.
- S. P. Eraševskaja, E. A. Ivanov, A. A. Pal'cev, and N. D. Sokolova (1976). *Tablicy sferoidal'nyh volnovykh funkci ih pervykh proizvodnyh. Tom II*. Minsk: Izdat. "Nauka i Tehnika". Edited by V. I. Krylov. Translated title: *Tables of Spheroidal Wave Functions and Their First Derivatives*.
- N. Ercolani and A. Sinha (1989). *Monopoles and Baker functions*. *Comm. Math. Phys.* **125**(3), pp. 385–416.
- A. Erdélyi (1941a). *Generating functions of certain continuous orthogonal systems*. *Proc. Roy. Soc. Edinburgh. Sect. A.* **61**, pp. 61–70.
- A. Erdélyi (1941b). *On Lamé functions*. *Philos. Mag. (7)* **31**, pp. 123–130.
- A. Erdélyi (1941c). *On algebraic Lamé functions*. *Philos. Mag. (7)* **32**, pp. 348–350.
- A. Erdélyi (1942a). *The Fuchsian equation of second order with four singularities*. *Duke Math. J.* **9**(1), pp. 48–58.
- A. Erdélyi (1942b). *Integral equations for Heun functions*. *Quart. J. Math., Oxford Ser.* **13**, pp. 107–112.
- A. Erdélyi (1944). *Certain expansions of solutions of the Heun equation*. *Quart. J. Math., Oxford Ser.* **15**, pp. 62–69.
- A. Erdélyi (1956). *Asymptotic Expansions*. New York: Dover Publications Inc.
- A. Erdélyi, W. Magnus, F. Oberhettinger, and F. G. Tricomi (1953a). *Higher Transcendental Functions. Vol. I*. New York-Toronto-London: McGraw-Hill Book Company, Inc. Reprinted by Robert E. Krieger Publishing Co. Inc., 1981. Table errata: *Math. Comp.* v. 65 (1996), no. 215, p. 1385, v. 41 (1983), no. 164, p. 778, v. 30 (1976), no. 135, p. 675, v. 25 (1971), no. 115, p. 635, v. 25 (1971), no. 113, p. 199, v. 24 (1970), no. 112, p. 999, v. 24 (1970), no. 110, p. 504.
- A. Erdélyi, W. Magnus, F. Oberhettinger, and F. G. Tricomi (1953b). *Higher Transcendental Functions. Vol. II*. New York-Toronto-London: McGraw-Hill Book Company, Inc. Reprinted by Robert E. Krieger Publishing Co. Inc., 1981. Table errata: *Math. Comp.* v. 41 (1983), no. 164, p. 778, v. 36 (1981), no. 153, p. 315, v. 30 (1976), no. 135, p. 675, v. 29 (1975), no. 130, p. 670, v. 26 (1972), no. 118, p. 598, v. 25 (1971), no. 113, p. 199, v. 24 (1970), no. 109, p. 239.
- A. Erdélyi, W. Magnus, F. Oberhettinger, and F. G. Tricomi (1954a). *Tables of Integral Transforms. Vol. I*. New York-Toronto-London: McGraw-Hill Book Company, Inc. Table errata: *Math. Comp.* v. 66 (1997), no. 220, p. 1766–1767, v. 65 (1996), no. 215, p. 1384, v. 50 (1988), no. 182, p. 653, v. 41 (1983), no. 164, p. 778–779, v. 27 (1973), no. 122, p. 451, v. 26 (1972), no. 118, p. 599, v. 25 (1971), no. 113, p. 199, v. 24 (1970), no. 109, p. 239–240.
- A. Erdélyi, W. Magnus, F. Oberhettinger, and F. G. Tricomi (1954b). *Tables of Integral Transforms. Vol. II*. New York-Toronto-London: McGraw-Hill Book Company, Inc. Table errata: *Math. Comp.* v. 65 (1996), no. 215, p. 1385, v. 41 (1983), no. 164, pp. 779–780, v. 31 (1977), no. 138, p. 614, v. 31 (1977), no. 137, pp. 328–329, v. 26 (1972), no. 118, p. 599, v. 25 (1971), no. 113, p. 199, v. 23 (1969), no. 106, p. 468.

- A. Erdélyi, W. Magnus, F. Oberhettinger, and F. G. Tricomi (1955). *Higher Transcendental Functions. Vol. III*. New York-Toronto-London: McGraw-Hill Book Company, Inc. Reprinted by Robert E. Krieger Publishing Co. Inc., 1981. Table errata: *Math. Comp.* v. 41 (1983), no. 164, p. 778.
- R. Ernvall (1979). *Generalized Bernoulli numbers, generalized irregular primes, and class number*. *Ann. Univ. Turku. Ser. A I* **178**, pp. 1–72.
- F. H. L. Essler, H. Frahm, A. R. Its, and V. E. Korepin (1996). *Painlevé transcendent describes quantum correlation function of the XXZ antiferromagnet away from the free-fermion point*. *J. Phys. A* **29**(17), pp. 5619–5626.
- T. Estermann (1959). *On the representations of a number as a sum of three squares*. *Proc. London Math. Soc.* (3) **9**, pp. 575–594.
- Euclid (1908). *The Thirteen Books of Euclid's Elements*. Cambridge: Cambridge University Press. Translated from the text of Heiberg, with introduction and commentary by Thomas L. Heath. Reprint of the Cambridge University second edition by Dover Publications, Inc., New York, 1956.
- L. Euler (1768). *Institutiones Calculi Integralis*, Volume 11 of *Opera Omnia* (1), pp. 110–113. Leipzig-Berlin: B. G. Teubner.
- G. A. Evans and J. R. Webster (1999). *A comparison of some methods for the evaluation of highly oscillatory integrals*. *J. Comput. Appl. Math.* **112**(1-2), pp. 55–69.
- W. D. Evans, W. N. Everitt, K. H. Kwon, and L. L. Littlejohn (1993). *Real orthogonalizing weights for Bessel polynomials*. *J. Comput. Appl. Math.* **49**(1-3), pp. 51–57.
- W. N. Everitt and D. S. Jones (1977). *On an integral inequality*. *Proc. Roy. Soc. London Ser. A* **357**, pp. 271–288.
- J. A. Ewell (1990). *A new series representation for  $\zeta(3)$* . *Amer. Math. Monthly* **97**(3), pp. 219–220.
- H. Exton (1983). *The asymptotic behaviour of the inhomogeneous Airy function  $\text{Hi}(z)$* . *Math. Chronicle* **12**, pp. 99–104.
- B. R. Fabijonas, D. W. Lozier, and F. W. J. Olver (2004). *Computation of complex Airy functions and their zeros using asymptotics and the differential equation*. *ACM Trans. Math. Software* **30**(4), pp. 471–490.
- B. R. Fabijonas and F. W. J. Olver (1999). *On the reversion of an asymptotic expansion and the zeros of the Airy functions*. *SIAM Rev.* **41**(4), pp. 762–773.
- V. N. Faddeeva and N. M. Terent'ev (1954). *Tablicy značenií funkcií  $w(z) = e^{-z^2} (1 + \frac{2i}{\sqrt{\pi}} \int_0^z e^{t^2} dt)$  ot kompleksnogo argumenta*. Moscow: Gosudarstv. Izdat. Tehn.-Teor. Lit. In Russian. English translation, see Faddeyeva and Terent'ev (1961).
- V. N. Faddeyeva and N. M. Terent'ev (1961). *Tables of Values of the Function  $w(z) = e^{-z^2} (1 + 2i\pi^{-1/2} \int_0^z e^{t^2} dt)$  for Complex Argument*. Edited by V. A. Fok; translated from the Russian by D. G. Fry. *Mathematical Tables Series*, Vol. 11. Oxford: Pergamon Press.
- M. Fairman (1992). *Generalized parabolic cylinder functions*. *Asymptotic Anal.* **5**(6), pp. 517–531.
- P. Falloon (2001). *Theory and Computation of Spheroidal Harmonics with General Arguments*. Master's thesis, The University of Western Australia, Department of Physics. Contains Mathematica package for spheroidal wave functions of complex arguments with complex parameters.
- D. F. Fang and J. F. Shriner, Jr. (1992). *A computer program for the calculation of angular-momentum coupling coefficients*. *Comput. Phys. Comm.* **70**(1), pp. 147–153. Fortran for exact calculation using integers.
- J. Faraut and A. Korányi (1994). *Analysis on Symmetric Cones*. *Oxford Mathematical Monographs*. Oxford-New York: The Clarendon Press, Oxford University Press.
- R. H. Farrell (1985). *Multivariate Calculation. Use of the Continuous Groups*. *Springer Series in Statistics*. New York: Springer-Verlag.
- J. D. Fay (1973). *Theta Functions on Riemann Surfaces*. Berlin: Springer-Verlag. *Lecture Notes in Mathematics*, Vol. 352.
- M. V. Fedoryuk (1989). *The Lamé wave equation*. *Uspekhi Mat. Nauk* **44**(1(265)), pp. 123–144, 248. In Russian. English translation: *Russian Math. Surveys*, **44**(1989), no. 1, pp. 153–180.
- M. V. Fedoryuk (1991). *Asymptotics of the spectrum of the Heun equation and of Heun functions*. *Izv. Akad. Nauk SSSR Ser. Mat.* **55**(3), pp. 631–646. In Russian. English translation: *Math. USSR-Izv.*, **38**(1992), no. 3, pp. 621–635 (1992).
- S. Fempl (1960). *Sur certaines sommes des intégral-cosinus*. *Bull. Soc. Math. Phys. Serbie* **12**, pp. 13–20.
- C. Ferreira and J. L. López (2001). *An asymptotic expansion of the double gamma function*. *J. Approx. Theory* **111**(2), pp. 298–314.
- C. Ferreira, J. L. López, and E. Pérez Sinusía (2005). *Incomplete gamma functions for large values of their variables*. *Adv. in Appl. Math.* **34**(3), pp. 467–485.
- H. E. Fettis (1965). *Calculation of elliptic integrals of the third kind by means of Gauss' transformation*. *Math. Comp.* **19**(89), pp. 97–104.
- H. E. Fettis (1970). *On the reciprocal modulus relation for elliptic integrals*. *SIAM J. Math. Anal.* **1**(4), pp. 524–526.
- H. E. Fettis (1976). *Complex roots of  $\sin z = az$ ,  $\cos z = az$ , and  $\cosh z = az$* . *Math. Comp.* **30**(135), pp. 541–545.

- H. E. Fettis and J. C. Caslin (1964, December). *Tables of Elliptic Integrals of the First, Second, and Third Kind*. Technical Report ARL 64-232, Aerospace Research Laboratories, Wright-Patterson Air Force Base, Ohio. Reviewed in *Math. Comp.* v. 1919(1965)509. Table erratum: *Math. Comp.* v. 20 (1966), no. 96, pp. 639-640.
- H. E. Fettis and J. C. Caslin (1969, November). *A Table of the Complete Elliptic Integral of the First Kind for Complex Values of the Modulus. Part I*. Technical Report ARL 69-0172, Aerospace Research Laboratories, Office of Aerospace Research, Wright-Patterson Air Force Base, Ohio. Table erratum: *Math. Comp.* v. 36 (1981), no. 153, p. 318. Part II of this report, with the same date but numbered ARL 69-0173, again puts  $k = R \exp(i\theta)$  but with  $R$  as parameter and  $\theta$  as variable instead of the other way around. Part III, dated May 1970 and numbered ARL 70-0081, contains tables of auxiliary functions to help interpolation.
- H. E. Fettis and J. C. Caslin (1973). *Table errata; Complex zeros of Fresnel integrals*. *Math. Comp.* **27**(121), p. 219. Errata in Abramowitz and Stegun (1964).
- H. E. Fettis, J. C. Caslin, and K. R. Cramer (1973). *Complex zeros of the error function and of the complementary error function*. *Math. Comp.* **27**(122), pp. 401-407.
- J. L. Fields (1965). *Asymptotic expansions of a class of hypergeometric polynomials with respect to the order. III*. *J. Math. Anal. Appl.* **12**(3), pp. 593-601.
- J. L. Fields (1973). *Uniform asymptotic expansions of certain classes of Meijer G-functions for a large parameter*. *SIAM J. Math. Anal.* **4**(3), pp. 482-507.
- J. L. Fields (1983). *Uniform asymptotic expansions of a class of Meijer G-functions for a large parameter*. *SIAM J. Math. Anal.* **14**(6), pp. 1204-1253.
- J. L. Fields and Y. L. Luke (1963a). *Asymptotic expansions of a class of hypergeometric polynomials with respect to the order*. *J. Math. Anal. Appl.* **6**(3), pp. 394-403.
- J. L. Fields and Y. L. Luke (1963b). *Asymptotic expansions of a class of hypergeometric polynomials with respect to the order. II*. *J. Math. Anal. Appl.* **7**(3), pp. 440-451.
- J. L. Fields and J. Wimp (1961). *Expansions of hypergeometric functions in hypergeometric functions*. *Math. Comp.* **15**(76), pp. 390-395.
- S. Fillebrown (1992). *Faster computation of Bernoulli numbers*. *J. Algorithms* **13**(3), pp. 431-445.
- S. R. Finch (2003). *Mathematical Constants*, Volume 94 of *Encyclopedia of Mathematics and its Applications*. Cambridge: Cambridge University Press.
- N. J. Fine (1988). *Basic Hypergeometric Series and Applications*, Volume 27 of *Mathematical Surveys and Monographs*. Providence, RI: American Mathematical Society. With a foreword by George E. Andrews.
- G. D. Finn and D. Mugglestone (1965). *Tables of the line broadening function  $H(a, v)$* . *Monthly Notices Roy. Astronom. Soc.* **129**, pp. 221-235.
- P. Flajolet and A. Odlyzko (1990). *Singularity analysis of generating functions*. *SIAM J. Discrete Math.* **3**(2), pp. 216-240.
- P. Flajolet and B. Salvy (1998). *Euler sums and contour integral representations*. *Experiment. Math.* **7**(1), pp. 15-35.
- C. Flammer (1957). *Spheroidal Wave Functions*. Stanford, CA: Stanford University Press.
- H. Flaschka and A. C. Newell (1980). *Monodromy- and spectrum-preserving deformations. I*. *Comm. Math. Phys.* **76**(1), pp. 65-116.
- A. Fletcher (1948). *Guide to tables of elliptic functions*. *Math. Tables and Other Aids to Computation* **3**(24), pp. 229-281.
- A. Fletcher, J. C. P. Miller, L. Rosenhead, and L. J. Comrie (1962). *An Index of Mathematical Tables. Vols. I, II* (2nd ed.). Reading, MA: Published for Scientific Computing Service Ltd., London, by Addison-Wesley Publishing Co., Inc. Table errata: *Math. Comp.* v.27 (1973), p. 1009.
- N. Fleury and A. Turbiner (1994). *Polynomial relations in the Heisenberg algebra*. *J. Math. Phys.* **35**(11), pp. 6144-6149.
- J. P. M. Flude (1998). *The Edmonds asymptotic formulas for the  $3j$  and  $6j$  symbols*. *J. Math. Phys.* **39**(7), pp. 3906-3915.
- V. Fock (1945). *Diffraction of radio waves around the earth's surface*. *Acad. Sci. USSR. J. Phys.* **9**, pp. 255-266.
- V. A. Fock (1965). *Electromagnetic Diffraction and Propagation Problems*. International Series of Monographs on Electromagnetic Waves, Vol. 1. Oxford: Pergamon Press.
- A. S. Fokas and M. J. Ablowitz (1982). *On a unified approach to transformations and elementary solutions of Painlevé equations*. *J. Math. Phys.* **23**(11), pp. 2033-2042.
- A. S. Fokas, B. Grammaticos, and A. Ramani (1993). *From continuous to discrete Painlevé equations*. *J. Math. Anal. Appl.* **180**(2), pp. 342-360.
- A. S. Fokas, A. R. Its, A. A. Kapaev, and V. Y. Novokshenov (2006). *Painlevé Transcendents: The Riemann-Hilbert Approach*, Volume 128 of *Mathematical Surveys and Monographs*. Providence, RI: American Mathematical Society.
- A. S. Fokas, A. R. Its, and A. V. Kitaev (1991). *Discrete Painlevé equations and their appearance in quantum gravity*. *Comm. Math. Phys.* **142**(2), pp. 313-344.

- A. S. Fokas, A. R. Its, and X. Zhou (1992). *Continuous and Discrete Painlevé Equations*. In D. Levi and P. Winternitz (Eds.), *Painlevé Transcendents: Their Asymptotics and Physical Applications*, Volume 278 of *NATO Adv. Sci. Inst. Ser. B Phys.*, pp. 33–47. New York: Plenum. Proc. NATO Adv. Res. Workshop, Sainte-Adèle, Canada, 1990.
- A. S. Fokas and Y. C. Yortsos (1981). *The transformation properties of the sixth Painlevé equation and one-parameter families of solutions*. *Lett. Nuovo Cimento* (2) **30**(17), pp. 539–544.
- K. W. Ford and J. A. Wheeler (1959a). *Semiclassical description of scattering*. *Ann. Physics* **7**(3), pp. 259–286.
- K. W. Ford and J. A. Wheeler (1959b). *Application of semiclassical scattering analysis*. *Ann. Physics* **7**(3), pp. 287–322.
- W. B. Ford (1960). *Studies on Divergent Series and Summability & The Asymptotic Developments of Functions Defined by Maclaurin Series*. New York: Chelsea Publishing Co. Reprint with corrections of two books published originally in 1916 and 1936.
- P. J. Forrester and N. S. Witte (2001). *Application of the  $\tau$ -function theory of Painlevé equations to random matrices: PIV, PII and the GUE*. *Comm. Math. Phys.* **219**(2), pp. 357–398.
- P. J. Forrester and N. S. Witte (2002). *Application of the  $\tau$ -function theory of Painlevé equations to random matrices: P<sub>V</sub>, P<sub>III</sub>, the LUE, JUE, and CUE*. *Comm. Pure Appl. Math.* **55**(6), pp. 679–727.
- P. J. Forrester and N. S. Witte (2004). *Application of the  $\tau$ -function theory of Painlevé equations to random matrices: P<sub>VI</sub>, the JUE, CyUE, cJUE and scaled limits*. *Nagoya Math. J.* **174**, pp. 29–114.
- R. C. Forrey (1997). *Computing the hypergeometric function*. *J. Comput. Phys.* **137**(1), pp. 79–100. Double-precision Fortran.
- T. Fort (1948). *Finite Differences and Difference Equations in the Real Domain*. Oxford: Clarendon Press.
- L. Fox (1960). *Tables of Weber Parabolic Cylinder Functions and Other Functions for Large Arguments*. National Physical Laboratory Mathematical Tables, Vol. 4. Department of Scientific and Industrial Research. London: Her Majesty's Stationery Office.
- L. Fox and I. B. Parker (1968). *Chebyshev Polynomials in Numerical Analysis*. London: Oxford University Press. Reprinted in 1972 with corrections.
- C. H. Franke (1965). *Numerical evaluation of the elliptic integral of the third kind*. *Math. Comp.* **19**(91), pp. 494–496.
- C. K. Frederickson and P. L. Marston (1992). *Transverse cusp diffraction catastrophes produced by the reflection of ultrasonic tone bursts from a curved surface in water*. *J. Acoust. Soc. Amer.* **92**(5), pp. 2869–2877.
- C. K. Frederickson and P. L. Marston (1994). *Travel time surface of a transverse cusp caustic produced by reflection of acoustical transients from a curved metal surface*. *J. Acoust. Soc. Amer.* **95**(2), pp. 650–660.
- C. L. Frenzen (1990). *Error bounds for a uniform asymptotic expansion of the Legendre function  $Q_n^{-m}(\cosh z)$* . *SIAM J. Math. Anal.* **21**(2), pp. 523–535.
- C. L. Frenzen and R. Wong (1985). *A note on asymptotic evaluation of some Hankel transforms*. *Math. Comp.* **45**(172), pp. 537–548.
- C. L. Frenzen and R. Wong (1986). *Asymptotic expansions of the Lebesgue constants for Jacobi series*. *Pacific J. Math.* **122**(2), pp. 391–415.
- C. L. Frenzen and R. Wong (1988). *Uniform asymptotic expansions of Laguerre polynomials*. *SIAM J. Math. Anal.* **19**(5), pp. 1232–1248.
- A. Fresnel (1818). *Mémoire sur la diffraction de la lumière*. *Mém. de l'Académie des Sciences*, pp. 247–382. Œuvres Complètes d'Augustin Fresnel, Paris, 1866.
- G. Freud (1976). *On the coefficients in the recursion formulae of orthogonal polynomials*. *Proc. Roy. Irish Acad. Sect. A* **76**(1), pp. 1–6.
- B. D. Fried and S. D. Conte (1961). *The Plasma Dispersion Function: The Hilbert Transform of the Gaussian*. London-New York: Academic Press. Erratum: *Math. Comp.* v. 26 (1972), no. 119, p. 814.
- B. R. Frieden (1971). *Evaluation, design and extrapolation methods for optical signals, based on use of the prolate functions*. In E. Wolf (Ed.), *Progress in Optics*, Volume 9, pp. 311–407. Amsterdam: North-Holland.
- F. G. Friedlander (1958). *Sound Pulses*. Cambridge-New York: Cambridge University Press.
- C.-E. Fröberg (1955). *Numerical treatment of Coulomb wave functions*. *Rev. Mod. Phys.* **27**(4), pp. 399–411.
- R. Fuchs (1907). *Über lineare homogene Differentialgleichungen zweiter Ordnung mit drei im Endlichen gelegenen wesentlich singulären Stellen*. *Math. Ann.* **63**(3), pp. 301–321.
- Y. Fukui and T. Horiguchi (1992). *Characteristic values of the integral equation satisfied by the Mathieu functions and its application to a system with chirality-pair interaction on a one-dimensional lattice*. *Phys. A* **190**(3-4), pp. 346–362.

- Y. V. Fyodorov (2005). *Introduction to the Random Matrix Theory: Gaussian Unitary Ensemble and Beyond*. In *Recent Perspectives in Random Matrix Theory and Number Theory*, Volume 322 of *London Math. Soc. Lecture Note Ser.*, pp. 31–78. Cambridge: Cambridge Univ. Press.
- B. Gabutti (1979). *On high precision methods for computing integrals involving Bessel functions*. *Math. Comp.* **33**(147), pp. 1049–1057.
- B. Gabutti (1980). *On the generalization of a method for computing Bessel function integrals*. *J. Comput. Appl. Math.* **6**(2), pp. 167–168.
- B. Gabutti and B. Minetti (1981). *A new application of the discrete Laguerre polynomials in the numerical evaluation of the Hankel transform of a strongly decreasing even function*. *J. Comput. Phys.* **42**(2), pp. 277–287.
- B. Gambier (1910). *Sur les équations différentielles du second ordre et du premier degré dont l'intégrale générale est a points critiques fixes*. *Acta Math.* **33**(1), pp. 1–55.
- L. Gårding (1947). *The solution of Cauchy's problem for two totally hyperbolic linear differential equations by means of Riesz integrals*. *Ann. of Math. (2)* **48**(4), pp. 785–826.
- I. Gargantini and P. Henrici (1967). *A continued fraction algorithm for the computation of higher transcendental functions in the complex plane*. *Math. Comp.* **21**(97), pp. 18–29.
- G. Gasper (1972). *An inequality of Turán type for Jacobi polynomials*. *Proc. Amer. Math. Soc.* **32**, pp. 435–439.
- G. Gasper (1975). *Formulas of the Dirichlet-Mehler Type*. In B. Ross (Ed.), *Fractional Calculus and its Applications*, Volume 457 of *Lecture Notes in Math.*, pp. 207–215. Berlin: Springer.
- G. Gasper (1981). *Orthogonality of certain functions with respect to complex valued weights*. *Canad. J. Math.* **33**(5), pp. 1261–1270.
- G. Gasper and M. Rahman (2004). *Basic Hypergeometric Series* (Second ed.), Volume 96 of *Encyclopedia of Mathematics and its Applications*. Cambridge: Cambridge University Press. With a foreword by Richard Askey.
- L. Gatteschi (1987). *New inequalities for the zeros of Jacobi polynomials*. *SIAM J. Math. Anal.* **18**(6), pp. 1549–1562.
- L. Gatteschi (1990). *New inequalities for the zeros of confluent hypergeometric functions*. In *Asymptotic and computational analysis (Winnipeg, MB, 1989)*, pp. 175–192. New York: Dekker.
- L. Gatteschi (2002). *Asymptotics and bounds for the zeros of Laguerre polynomials: A survey*. *J. Comput. Appl. Math.* **144**(1-2), pp. 7–27.
- M. Gaudin (1983). *La fonction d'onde de Bethe*. Paris: Masson.
- J. A. Gaunt (1929). *The triplets of helium*. *Philos. Trans. Roy. Soc. London Ser. A* **228**, pp. 151–196.
- C. F. Gauss (1863). *Werke. Band II*, pp. 436–447. Königlichen Gesellschaft der Wissenschaften zu Göttingen. Reprinted by Georg Olms Verlag, Hildesheim, 1973.
- W. Gautschi (1959a). *Exponential integral  $\int_1^\infty e^{-xt}t^{-n}dt$  for large values of  $n$* . *J. Res. Nat. Bur. Standards* **62**, pp. 123–125.
- W. Gautschi (1959b). *Some elementary inequalities relating to the gamma and incomplete gamma function*. *J. Math. Phys.* **38**(1), pp. 77–81.
- W. Gautschi (1961). *Recursive computation of the repeated integrals of the error function*. *Math. Comp.* **15**(75), pp. 227–232.
- W. Gautschi (1967). *Computational aspects of three-term recurrence relations*. *SIAM Rev.* **9**(1), pp. 24–82.
- W. Gautschi (1970). *Efficient computation of the complex error function*. *SIAM J. Numer. Anal.* **7**(1), pp. 187–198.
- W. Gautschi (1974). *A harmonic mean inequality for the gamma function*. *SIAM J. Math. Anal.* **5**(2), pp. 278–281.
- W. Gautschi (1975). *Computational Methods in Special Functions – A Survey*. In R. A. Askey (Ed.), *Theory and Application of Special Functions (Proc. Advanced Sem., Math. Res. Center, Univ. Wisconsin, Madison, Wis., 1975)*, pp. 1–98. Math. Res. Center, Univ. Wisconsin Publ., No. 35. New York: Academic Press.
- W. Gautschi (1977a). *Evaluation of the repeated integrals of the coerror function*. *ACM Trans. Math. Software* **3**, pp. 240–252. For software see Gautschi (1977b).
- W. Gautschi (1977b). *Algorithm 521: Repeated integrals of the coerror function*. *ACM Trans. Math. Software* **3**, pp. 301–302. Single-precision Fortran, maximum accuracy 14D.
- W. Gautschi (1979a). *A computational procedure for incomplete gamma functions*. *ACM Trans. Math. Software* **5**(4), pp. 466–481.
- W. Gautschi (1979b). *Un procedimento di calcolo per le funzioni gamma incomplete*. *Rend. Sem. Mat. Univ. Politec. Torino* **37**(1), pp. 1–9.
- W. Gautschi (1983). *How and how not to check Gaussian quadrature formulae*. *BIT* **23**(2), pp. 209–216.
- W. Gautschi (1984). *Questions of Numerical Condition Related to Polynomials*. In G. H. Golub (Ed.), *Studies in Numerical Analysis*, pp. 140–177. Washington, DC: Mathematical Association of America.
- W. Gautschi (1993). *On the computation of generalized Fermi-Dirac and Bose-Einstein integrals*. *Comput. Phys. Comm.* **74**(2), pp. 233–238.

- W. Gautschi (1994). *Algorithm 726: ORTHPOL — a package of routines for generating orthogonal polynomials and Gauss-type quadrature rules*. ACM Trans. Math. Software **20**(1), pp. 21–62. For remark see same journal **24**(1998), p. 355.
- W. Gautschi (1996). *Orthogonal Polynomials: Applications and Computation*. In A. Iserles (Ed.), *Acta Numerica, 1996*, Volume 5 of *Acta Numerica*, pp. 45–119. Cambridge: Cambridge Univ. Press.
- W. Gautschi (1997a). *The Computation of Special Functions by Linear Difference Equations*. In S. Elaydi, I. Györi, and G. Ladas (Eds.), *Advances in Difference Equations (Veszprém, 1995)*, pp. 213–243. Amsterdam: Gordon and Breach.
- W. Gautschi (1997b). *Numerical Analysis. An Introduction*. Boston, MA: Birkhäuser Boston Inc.
- W. Gautschi (1998). *The incomplete gamma functions since Tricomi*. In *Tricomi's Ideas and Contemporary Applied Mathematics (Rome/Turin, 1997)*, Volume 147 of *Atti Convegna Lincei*, pp. 203–237. Rome: Accad. Naz. Lincei.
- W. Gautschi (1999). *A note on the recursive calculation of incomplete gamma functions*. ACM Trans. Math. Software **25**(1), pp. 101–107.
- W. Gautschi (2002a). *Computation of Bessel and Airy functions and of related Gaussian quadrature formulae*. BIT **42**(1), pp. 110–118.
- W. Gautschi (2002b). *Gauss quadrature approximations to hypergeometric and confluent hypergeometric functions*. J. Comput. Appl. Math. **139**(1), pp. 173–187.
- W. Gautschi (2004). *Orthogonal Polynomials: Computation and Approximation*. Numerical Mathematics and Scientific Computation. New York: Oxford University Press.
- W. Gautschi and J. Slavik (1978). *On the computation of modified Bessel function ratios*. Math. Comp. **32**(143), pp. 865–875.
- M. Gavrila (1967). *Elastic scattering of photons by a hydrogen atom*. Phys. Rev. **163**(1), pp. 147–155.
- I. M. Gel'fand and G. E. Shilov (1964). *Generalized Functions. Vol. 1: Properties and Operations*. New York: Academic Press. Translated from the Russian by Eugene Saletan. A paperbound reprinting by the same publisher appeared in 1977.
- M. Geller and E. W. Ng (1969). *A table of integrals of the exponential integral*. J. Res. Nat. Bur. Standards Sect. B **73B**, pp. 191–210.
- M. Geller and E. W. Ng (1971). *A table of integrals of the error function. II. Additions and corrections*. J. Res. Nat. Bur. Standards Sect. B **75B**, pp. 149–163. See for the first part same journal, Sect. B 73, 1-20 (1969).
- K. Germeij (1964). *Die Beugung einer ebenen elektromagnetischen Welle an zwei parallelen unendlich langen idealleitenden Zylindern von elliptischem Querschnitt*. Ann. Physik (7) **468**, pp. 237–251.
- A. Gervois and H. Navelet (1984). *Some integrals involving three Bessel functions when their arguments satisfy the triangle inequalities*. J. Math. Phys. **25**(11), pp. 3350–3356.
- A. Gervois and H. Navelet (1985a). *Integrals of three Bessel functions and Legendre functions. I*. J. Math. Phys. **26**(4), pp. 633–644.
- A. Gervois and H. Navelet (1985b). *Integrals of three Bessel functions and Legendre functions. II*. J. Math. Phys. **26**(4), pp. 645–655.
- A. Gervois and H. Navelet (1986a). *Some integrals involving three modified Bessel functions. I*. J. Math. Phys. **27**(3), pp. 682–687.
- A. Gervois and H. Navelet (1986b). *Some integrals involving three modified Bessel functions. II*. J. Math. Phys. **27**(3), pp. 688–695.
- I. M. Gessel (2003). *Applications of the classical umbral calculus*. Algebra Universalis **49**(4), pp. 397–434.
- P. Gianni, M. Seppälä, R. Silhol, and B. Trager (1998). *Riemann surfaces, plane algebraic curves and their period matrices*. J. Symbolic Comput. **26**(6), pp. 789–803.
- A. G. Gibbs (1973). *Problem 72-21, Laplace transforms of Airy functions*. SIAM Rev. **15**(4), pp. 796–798. Problem proposed by P. Smith.
- A. Gil and J. Segura (2000). *Evaluation of toroidal harmonics*. Comput. Phys. Comm. **124**(1), pp. 104–122.
- A. Gil and J. Segura (2003). *Computing the zeros and turning points of solutions of second order homogeneous linear ODEs*. SIAM J. Numer. Anal. **41**(3), pp. 827–855.
- A. Gil, J. Segura, and N. M. Temme (2000). *Computing toroidal functions for wide ranges of the parameters*. J. Comput. Phys. **161**(1), pp. 204–217.
- A. Gil, J. Segura, and N. M. Temme (2001). *On nonoscillating integrals for computing inhomogeneous Airy functions*. Math. Comp. **70**(235), pp. 1183–1194.
- A. Gil, J. Segura, and N. M. Temme (2002a). *Computing complex Airy functions by numerical quadrature*. Numer. Algorithms **30**(1), pp. 11–23.
- A. Gil, J. Segura, and N. M. Temme (2002b). *Evaluation of the modified Bessel function of the third kind of imaginary orders*. J. Comput. Phys. **175**(2), pp. 398–411.
- A. Gil, J. Segura, and N. M. Temme (2003a). *Computation of the modified Bessel function of the third kind of imaginary orders: Uniform Airy-type asymptotic expansion*. J. Comput. Appl. Math. **153**(1-2), pp. 225–234.

- A. Gil, J. Segura, and N. M. Temme (2003b). *Computing special functions by using quadrature rules*. Numer. Algorithms **33**(1-4), pp. 265–275. International Conference on Numerical Algorithms, Vol. I (Marrakesh, 2001).
- A. Gil, J. Segura, and N. M. Temme (2003c). *On the zeros of the Scorer functions*. J. Approx. Theory **120**(2), pp. 253–266.
- A. Gil, J. Segura, and N. M. Temme (2004a). *Computing solutions of the modified Bessel differential equation for imaginary orders and positive arguments*. ACM Trans. Math. Software **30**(2), pp. 145–158.
- A. Gil, J. Segura, and N. M. Temme (2004b). *Integral representations for computing real parabolic cylinder functions*. Numer. Math. **98**(1), pp. 105–134.
- A. Gil, J. Segura, and N. M. Temme (2006a). *The ABC of hyper recursions*. J. Comput. Appl. Math. **190**(1-2), pp. 270–286.
- A. Gil, J. Segura, and N. M. Temme (2006b). *Computing the real parabolic cylinder functions  $U(a, x)$ ,  $V(a, x)$* . ACM Trans. Math. Software **32**(1), pp. 70–101.
- A. Gil, J. Segura, and N. M. Temme (2006c). *Algorithm 850: Real parabolic cylinder functions  $U(a, x)$ ,  $V(a, x)$* . ACM Trans. Math. Software **32**(1), pp. 102–112.
- A. Gil, J. Segura, and N. M. Temme (2007a). *Numerical Methods for Special Functions*. Philadelphia, PA: Society for Industrial and Applied Mathematics (SIAM).
- A. Gil, J. Segura, and N. M. Temme (2007b). *Numerically satisfactory solutions of hypergeometric recursions*. Math. Comp. **76**(259), pp. 1449–1468.
- S. G. Gindikin (1964). *Analysis in homogeneous domains*. Uspehi Mat. Nauk **19**(4 (118)), pp. 3–92. In Russian. English translation: Russian Math. Surveys, **19**(1964), no. 4, pp. 1–89.
- J. N. Ginocchio (1991). *A new identity for some six- $j$  symbols*. J. Math. Phys. **32**(6), pp. 1430–1432.
- K. Girstmair (1990a). *Dirichlet convolution of cotangent numbers and relative class number formulas*. Monatsh. Math. **110**(3-4), pp. 231–256.
- K. Girstmair (1990b). *A theorem on the numerators of the Bernoulli numbers*. Amer. Math. Monthly **97**(2), pp. 136–138.
- J. W. L. Glaisher (1940). *Number-Divisor Tables*. British Association Mathematical Tables, Vol. VIII. Cambridge, England: Cambridge University Press.
- M. L. Glasser (1976). *Definite integrals of the complete elliptic integral  $K$* . J. Res. Nat. Bur. Standards Sect. B **80B**(2), pp. 313–323.
- M. L. Glasser (1979). *A method for evaluating certain Bessel integrals*. Z. Angew. Math. Phys. **30**(4), pp. 722–723.
- C. D. Godsil, M. Grötschel, and D. J. A. Welsh (1995). *Combinatorics in Statistical Physics*. In R. L. Graham, M. Grötschel, and L. Lovász (Eds.), *Handbook of Combinatorics, Vol. 2*, pp. 1925–1954. Amsterdam: Elsevier.
- W. M. Y. Goh (1998). *Plancherel-Rotach asymptotics for the Charlier polynomials*. Constr. Approx. **14**(2), pp. 151–168.
- D. Goldberg (1991). *What every computer scientist should know about floating-point arithmetic*. ACM Computing Surveys **23**(1), pp. 5–48.
- K. Goldberg, F. T. Leighton, M. Newman, and S. L. Zuckerman (1976). *Tables of binomial coefficients and Stirling numbers*. J. Res. Nat. Bur. Standards Sect. B **80B**(1), pp. 99–171.
- S. Goldstein (1927). *Mathieu functions*. Trans. Camb. Philos. Soc. **23**, pp. 303–336.
- G. H. Golub and C. F. Van Loan (1996). *Matrix Computations* (3rd ed.). Baltimore, MD: Johns Hopkins University Press.
- G. H. Golub and J. H. Welsch (1969). *Calculation of Gauss quadrature rules*. Math. Comp. **23**(106), pp. 221–230. Loose microfiche suppl. A1–A10.
- V. V. Golubev (1960). *Lectures on Integration of the Equations of Motion of a Rigid Body About a Fixed Point*. Translated from the Russian by J. Shorr-Kon. Washington, D. C.: Office of Technical Services, U. S. Department of Commerce. Published for the National Science Foundation by the Israel Program for Scientific Translations, 1960.
- E. T. Goodwin (1949a). *The evaluation of integrals of the form  $\int_{-\infty}^{\infty} f(x)e^{-x^2} dx$* . Proc. Cambridge Philos. Soc. **45**(2), pp. 241–245.
- E. T. Goodwin (1949b). *Recurrence relations for cross-products of Bessel functions*. Quart. J. Mech. Appl. Math. **2**(1), pp. 72–74.
- E. T. Goodwin and J. Staton (1948). *Table of  $\int_0^{\infty} \frac{e^{-u^2}}{u+x} du$* . Quart. J. Mech. Appl. Math. **1**(1), pp. 319–326.
- R. G. Gordon (1969). *New method for constructing wavefunctions for bound states and scattering*. J. Chem. Phys. **51**, pp. 14–25.
- R. G. Gordon (1970). *Constructing wavefunctions for non-local potentials*. J. Chem. Phys. **52**, pp. 6211–6217.
- D. Goss (1978). *Von Staudt for  $\mathbf{F}_q[T]$* . Duke Math. J. **45**(4), pp. 885–910.
- D. Gottlieb and S. A. Orszag (1977). *Numerical Analysis of Spectral Methods: Theory and Applications*. Philadelphia, PA: Society for Industrial and Applied Mathematics. CBMS-NSF Regional Conference Series in Applied Mathematics, No. 26.



- H. P. W. Gottlieb (1985). *On the exceptional zeros of cross-products of derivatives of spherical Bessel functions*. *Z. Angew. Math. Phys.* **36**(3), pp. 491–494.
- H. W. Gould (1960). *Stirling number representation problems*. *Proc. Amer. Math. Soc.* **11**(3), pp. 447–451.
- H. W. Gould (1972). *Explicit formulas for Bernoulli numbers*. *Amer. Math. Monthly* **79**, pp. 44–51.
- É. Goursat (1881). *Sur l'équation différentielle linéaire, qui admet pour intégrale la série hypergéométrique*. *Ann. Sci. École Norm. Sup. (2)* **10**, pp. 3–142.
- É. Goursat (1883). *Mémoire sur les fonctions hypergéométriques d'ordre supérieur*. *Ann. Sci. École Norm. Sup. (2)* **12**, pp. 261–286, 395–430.
- J. Grad and E. Zakrajšek (1973). *Method for evaluation of zeros of Bessel functions*. *J. Inst. Math. Appl.* **11**, pp. 57–72.
- I. S. Gradshteyn and I. M. Ryzhik (2000). *Table of Integrals, Series, and Products* (6th ed.). San Diego, CA: Academic Press Inc. Translated from the Russian. Translation edited and with a preface by Alan Jeffrey and Daniel Zwillinger. For a review of the fourth edition (1980), with errata list, see *Math. Comp.* v. 36 (1981), pp. 310–314. For a review of the fifth edition (1994) see *Math. Comp.* v. 64 (1995), pp. 439–441.
- R. L. Graham, M. Grötschel, and L. Lovász (Eds.) (1995). *Handbook of Combinatorics. Vols. 1, 2*. Amsterdam: Elsevier Science B.V.
- R. L. Graham, D. E. Knuth, and O. Patashnik (1994). *Concrete Mathematics: A Foundation for Computer Science* (2nd ed.). Reading, MA: Addison-Wesley Publishing Company.
- B. Grammaticos, A. Ramani, and V. Papageorgiou (1991). *Do integrable mappings have the Painlevé property?* *Phys. Rev. Lett.* **67**(14), pp. 1825–1828.
- T. V. Gramtcheff (1981). *An application of Airy functions to the Tricomi problem*. *Math. Nachr.* **102**(1), pp. 169–181.
- A. Gray, G. B. Mathews, and T. M. MacRobert (1922). *A Treatise on Bessel Functions and their Applications to Physics* (2nd ed.). London: Macmillan and Co. Table errata: *Math. Comp.* v. 24 (1970), p. 240, v. 31 (1978), pp. 806 and 1046, and v. 32 (1978), pp. 318. Reprinted by Dover Publications Inc., New York, 1966.
- J. J. Gray (2000). *Linear Differential Equations and Group Theory from Riemann to Poincaré* (2nd ed.). Boston, MA: Birkhäuser Boston Inc.
- N. Gray (2002). *Automatic reduction of elliptic integrals using Carlson's relations*. *Math. Comp.* **71**(237), pp. 311–318.
- M. B. Green, J. H. Schwarz, and E. Witten (1988a). *Superstring Theory: Introduction, Vol. 1* (2nd ed.). Cambridge Monographs on Mathematical Physics. Cambridge: Cambridge University Press.
- M. B. Green, J. H. Schwarz, and E. Witten (1988b). *Superstring Theory: Loop Amplitudes, Anomalies and Phenomenology, Vol. 2*. (2nd ed.). Cambridge Monographs on Mathematical Physics. Cambridge: Cambridge University Press.
- C. H. Greene, U. Fano, and G. Strinati (1979). *General form of the quantum-defect theory*. *Phys. Rev. A* **19**(4), pp. 1485–1509.
- D. H. Greene and D. E. Knuth (1982). *Mathematics for the Analysis of Algorithms*, Volume 1 of *Progress in Computer Science*. Boston, MA: Birkhäuser Boston.
- A. G. Greenhill (1892). *The Applications of Elliptic Functions*. London: MacMillan. Reprinted by Dover Publications Inc., New York, 1959.
- A. G. Greenhill (1959). *The Applications of Elliptic Functions*. New York: Dover Publications Inc. Reprint of Macmillan, London edition, 1892.
- W. Greiner, B. Müller, and J. Rafelski (1985). *Quantum Electrodynamics of Strong Fields: With an Introduction into Modern Relativistic Quantum Mechanics*. Texts and Monographs in Physics. Springer.
- W. Gröbner and N. Hofreiter (1949). *Integraltafel. Erster Teil. Unbestimmte Integrale*. Vienna: Springer-Verlag. Reprintings with corrections appeared in 1961 and 1965.
- W. Gröbner and N. Hofreiter (1950). *Integraltafel. Zweiter Teil. Bestimmte Integrale*. Vienna and Innsbruck: Springer-Verlag. Reprintings with corrections appeared in 1958 and 1961.
- P. Groeneboom and D. R. Truax (2000). *A monotonicity property of the power function of multivariate tests*. *Indag. Math. (N.S.)* **11**(2), pp. 209–218.
- V. I. Gromak (1975). *Theory of Painlevé's equations*. *Differ. Uravn.* **11**(11), pp. 373–376. In Russian. English translation: *Differential Equations* **11**(11), pp. 285–287.
- V. I. Gromak (1976). *The solutions of Painlevé's fifth equation*. *Differ. Uravn.* **12**(4), pp. 740–742. In Russian. English translation: *Differential Equations* **12**(4), pp. 519–521 (1977).
- V. I. Gromak (1978). *One-parameter systems of solutions of Painlevé equations*. *Differ. Uravn.* **14**(12), pp. 2131–2135. In Russian. English translation: *Differential Equations* **14**(12), pp. 1510–1513 (1979).
- V. I. Gromak (1987). *Theory of the fourth Painlevé equation*. *Differ. Uravn.* **23**(5), pp. 760–768, 914. In Russian. English translation: *Differential Equations* **23**(5), pp. 506–513.

- V. I. Gromak, I. Laine, and S. Shimomura (2002). *Painlevé Differential Equations in the Complex Plane*, Volume 28 of *Studies in Mathematics*. Berlin-New York: Walter de Gruyter & Co.
- V. I. Gromak and N. A. Lukaševič (1982). *Special classes of solutions of Painlevé equations*. *Differ. Uravn.* **18**(3), pp. 419–429. In Russian. English translation: *Differential Equations* **18**(3), pp. 317–326.
- K. I. Gross and R. A. Kunze (1976). *Bessel functions and representation theory. I*. *J. Functional Analysis* **22**(2), pp. 73–105.
- K. I. Gross and D. St. P. Richards (1987). *Special functions of matrix argument. I. Algebraic induction, zonal polynomials, and hypergeometric functions*. *Trans. Amer. Math. Soc.* **301**(2), pp. 781–811.
- K. I. Gross and D. St. P. Richards (1991). *Hypergeometric functions on complex matrix space*. *Bull. Amer. Math. Soc. (N.S.)* **24**(2), pp. 349–355.
- E. Grosswald (1978). *Bessel Polynomials*, Volume 698 of *Lecture Notes in Mathematics*. Berlin-New York: Springer.
- E. Grosswald (1985). *Representations of Integers as Sums of Squares*. New York: Springer-Verlag.
- F. W. Grover (1946). *Inductance Calculations*. New York: Van Nostrand. Reprinted by Dover, New York, 1962 and 2004.
- B.-Y. Guo (1998). *Spectral Methods and Their Applications*. River Edge, NJ-Singapore: World Scientific Publishing Co. Inc.
- B. N. Gupta (1970). *On Mill's ratio*. *Proc. Cambridge Philos. Soc.* **67**, pp. 363–364.
- D. P. Gupta and M. E. Muldoon (2000). *Riccati equations and convolution formulae for functions of Rayleigh type*. *J. Phys. A* **33**(7), pp. 1363–1368.
- H. Gupta (1935). *A table of partitions*. *Proc. London Math. Soc. (2)* **39**, pp. 142–149.
- H. Gupta (1937). *A table of partitions*. *Proc. London Math. Soc. (2)* **42**, pp. 546–549.
- H. Gupta, C. E. Gwyther, and J. C. P. Miller (1958). *Tables of Partitions*, Volume 4 of *Royal Society Math. Tables*. Cambridge University Press.
- R. A. Gustafson (1987). *Multilateral summation theorems for ordinary and basic hypergeometric series in  $U(n)$* . *SIAM J. Math. Anal.* **18**(6), pp. 1576–1596.
- A. Guthmann (1991). *Asymptotische Entwicklungen für unvollständige Gammafunktionen*. *Forum Math.* **3**(2), pp. 105–141. Translated title: *Asymptotic expansions for incomplete gamma functions*.
- J. C. Gutiérrez-Vega, R. M. Rodríguez-Dagnino, M. A. Meneses-Nava, and S. Chávez-Cerda (2003). *Mathieu functions, a visual approach*. *Amer. J. Phys.* **71**(3), pp. 233–242.
- A. J. Guttman and T. Prellberg (1993). *Staircase polygons, elliptic integrals, Heun functions, and lattice Green functions*. *Phys. Rev. E* **47**(4), pp. R2233–R2236.
- L. Habsieger (1986). *La  $q$ -conjecture de Macdonald-Morris pour  $G_2$* . *C. R. Acad. Sci. Paris Sér. I Math.* **303**(6), pp. 211–213.
- L. Habsieger (1988). *Une  $q$ -intégrale de Selberg et Askey*. *SIAM J. Math. Anal.* **19**(6), pp. 1475–1489.
- J. Hadamard (1896). *Sur la distribution des zéros de la fonction  $\zeta(s)$  et ses conséquences arithmétiques*. *Bull. Soc. Math. France* **24**, pp. 199–220. Reprinted in *Oeuvres de Jacques Hadamard*. Tomes I, pp. 189–210, Éditions du Centre National de la Recherche Scientifique, Paris, 1968.
- P. I. Hadži (1968). *Computation of certain integrals that contain a probability function*. *Bul. Akad. Štiince RSS Moldoven* **1968**(2), pp. 81–104. (errata insert).
- P. I. Hadži (1969). *Certain integrals that contain a probability function and degenerate hypergeometric functions*. *Bul. Akad. Štiince RSS Moldoven* **1969**(2), pp. 40–47.
- P. I. Hadži (1970). *Some integrals that contain a probability function and hypergeometric functions*. *Bul. Akad. Štiince RSS Moldoven* **1970**(1), pp. 49–62.
- P. I. Hadži (1972). *Certain sums that contain cylindrical functions*. *Bul. Akad. Štiince RSS Moldoven*. **1972**(3), pp. 75–77, 94.
- P. I. Hadži (1973). *The Laplace transform for expressions that contain a probability function*. *Bul. Akad. Štiince RSS Moldoven*. **1973**(2), pp. 78–80, 93.
- P. I. Hadži (1975a). *Certain integrals that contain a probability function*. *Bul. Akad. Štiince RSS Moldoven*. **1975**(2), pp. 86–88, 95.
- P. I. Hadži (1975b). *Integrals containing the Fresnel functions  $S(x)$  and  $C(x)$* . *Bul. Akad. Štiince RSS Moldoven*. **1975**(3), pp. 48–60, 93.
- P. I. Hadži (1976a). *Expansions for the probability function in series of Čebyšev polynomials and Bessel functions*. *Bul. Akad. Štiince RSS Moldoven*. **1976**(1), pp. 77–80, 96.
- P. I. Hadži (1976b). *Integrals that contain a probability function of complicated arguments*. *Bul. Akad. Štiince RSS Moldoven*. **1976**(1), pp. 80–84, 96.
- P. I. Hadži (1978). *Sums with cylindrical functions that reduce to the probability function and to related functions*. *Bul. Akad. Štiintse RSS Moldoven*. **1978**(3), pp. 80–84, 95.
- E. Hahn (1980). *Asymptotik bei Jacobi-Polynomen und Jacobi-Funktionen*. *Math. Z.* **171**(3), pp. 201–226.

- W. Hahn (1949). *Über Orthogonalpolynome, die  $q$ -Differenzgleichungen genügen*. Math. Nachr. **2**, pp. 4–34.
- E. Hairer, S. P. Nørsett, and G. Wanner (1993). *Solving Ordinary Differential Equations. I. Nonstiff Problems* (2nd ed.), Volume 8 of *Springer Series in Computational Mathematics*. Berlin: Springer-Verlag. A reprinting with corrections appeared in 2000.
- E. Hairer, S. P. Nørsett, and G. Wanner (2000). *Solving Ordinary Differential Equations. I. Nonstiff Problems* (2nd ed.). Berlin: Springer-Verlag.
- E. Hairer and G. Wanner (1996). *Solving Ordinary Differential Equations. II. Stiff and Differential-Algebraic Problems* (2nd ed.), Volume 14 of *Springer Series in Computational Mathematics*. Berlin: Springer-Verlag.
- M. H. Halley, D. Delande, and K. T. Taylor (1993). *The combination of  $R$ -matrix and complex coordinate methods: Application to the diamagnetic Rydberg spectra of Ba and Sr*. J. Phys. B **26**(12), pp. 1775–1790.
- A. J. S. Hamilton (2001). *Formulae for growth factors in expanding universes containing matter and a cosmological constant*. Monthly Notices Roy. Astronom. Soc. **322**(2), pp. 419–425.
- J. Hammack, D. McCallister, N. Scheffner, and H. Segur (1995). *Two-dimensional periodic waves in shallow water. II. Asymmetric waves*. J. Fluid Mech. **285**, pp. 95–122.
- J. Hammack, N. Scheffner, and H. Segur (1989). *Two-dimensional periodic waves in shallow water*. J. Fluid Mech. **209**, pp. 567–589.
- H. Hancock (1958). *Elliptic Integrals*. New York: Dover Publications Inc. Unaltered reprint of original edition published by Wiley, New York, 1917.
- R. A. Handelsman and J. S. Lew (1970). *Asymptotic expansion of Laplace transforms near the origin*. SIAM J. Math. Anal. **1**(1), pp. 118–130.
- R. A. Handelsman and J. S. Lew (1971). *Asymptotic expansion of a class of integral transforms with algebraically dominated kernels*. J. Math. Anal. Appl. **35**(2), pp. 405–433.
- S. Hanish, R. V. Baier, A. L. Van Buren, and B. J. King (1970). *Tables of Radial Spheroidal Wave Functions, Vols. 1-3, Prolate,  $m = 0, 1, 2$ ; Vols. 4-6, Oblate,  $m = 0, 1, 2$* . Technical report, Naval Research Laboratory, Washington, D.C. NRL Reports 7088-7093.
- E. R. Hansen (1975). *A Table of Series and Products*. Englewood Cliffs, NJ: Prentice-Hall. Table erratum: Math. Comp. v.47 (1986), no. 176, p. 767.
- E. W. Hansen (1985). *Fast Hankel transform algorithm*. IEEE Trans. Acoust. Speech Signal Process. **32**(3), pp. 666–671.
- J. Happel and H. Brenner (1973). *Low Reynolds Number Hydrodynamics with Special Applications to Particulate Media* (2nd ed.). Leyden: Noordhoff International Publishing. The first edition was published in 1965 by Prentice-Hall. The 2nd edition was reissued in 1983 by Springer, and in 1986 by Martinus Nijhoff Publishers (Kluwer Academic Publishers Group).
- G. H. Hardy (1912). *Note on Dr. Vacca's series for  $\gamma$* . Quart. J. Math. **43**, pp. 215–216.
- G. H. Hardy (1940). *Ramanujan. Twelve Lectures on Subjects Suggested by His Life and Work*. Cambridge, England: Cambridge University Press. Reprinted by Chelsea Publishing Company, New York, 1959.
- G. H. Hardy (1949). *Divergent Series*. Oxford: Clarendon Press. Reprinted by the American Mathematical Society in 2000.
- G. H. Hardy (1952). *A Course of Pure Mathematics* (10th ed.). Cambridge University Press. Numerous reprintings exist, including the Centenary Edition with Foreword by T. W. Körner (Cambridge University Press, 2008).
- G. H. Hardy and J. E. Littlewood (1925). *Some problems of "Partitio Numerorum" (VI): Further researches in Waring's Problem*. Math. Z. **23**, pp. 1–37. Reprinted in *Collected Papers of G. H. Hardy (Including Joint papers with J. E. Littlewood and others)*, Vol. I, pp. 469–505, Clarendon Press, Oxford, 1966.
- G. H. Hardy, J. E. Littlewood, and G. Pólya (1967). *Inequalities* (2nd ed.). Cambridge Mathematical Library. Cambridge: Cambridge University Press. Reprint of the 1952 edition and reprinted in 1988.
- G. H. Hardy and S. Ramanujan (1918). *Asymptotic formulae in combinatory analysis*. Proc. London Math. Soc. (2) **17**, pp. 75–115. Reprinted in *Ramanujan* (1962, pp. 276–309).
- G. H. Hardy and E. M. Wright (1979). *An Introduction to the Theory of Numbers* (5th ed.). New York-Oxford: The Clarendon Press Oxford University Press.
- B. A. Hargrave (1978). *High frequency solutions of the delta wing equations*. Proc. Roy. Soc. Edinburgh Sect. A **81**(3-4), pp. 299–316.
- B. A. Hargrave and B. D. Sleeman (1977). *Lamé polynomials of large order*. SIAM J. Math. Anal. **8**(5), pp. 800–842.
- F. E. Harris (2000). *Spherical Bessel expansions of sine, cosine, and exponential integrals*. Appl. Numer. Math. **34**(1), pp. 95–98.
- F. E. Harris (2002). *Analytic evaluation of two-center STO electron repulsion integrals via ellipsoidal expansion*. Internat. J. Quantum Chem. **88**(6), pp. 701–734.
- J. F. Hart, E. W. Cheney, C. L. Lawson, H. J. Maehly, C. K. Mesztenyi, J. R. Rice, H. G. Thacher, Jr., and C. Witzgall (1968). *Computer Approximations*. SIAM Ser. in Appl. Math. New York: John Wiley & Sons Inc. Reprinted by Krieger Publishing Company, 1978.

- D. R. Hartree (1936). *Some properties and applications of the repeated integrals of the error function*. Proc. Manchester Lit. Philos. Soc. **80**, pp. 85–102.
- Harvard (1945). Harvard University. *Tables of the Modified Hankel Functions of Order One-Third and of their Derivatives*. Cambridge, MA: Harvard University Press.
- A. Hasegawa (1989). *Optical Solitons in Fibers*. Berlin, Germany: Springer-Verlag.
- C. B. Haselgrove and J. C. P. Miller (1960). *Tables of the Riemann Zeta Function*. Royal Society Mathematical Tables, Vol. 6. New York: Cambridge University Press.
- C. Hastings, Jr. (1955). *Approximations for Digital Computers*. Princeton, N. J.: Princeton University Press. Assisted by Jeanne T. Hayward and James P. Wong, Jr.
- S. P. Hastings and J. B. McLeod (1980). *A boundary value problem associated with the second Painlevé transcendent and the Korteweg-de Vries equation*. Arch. Rational Mech. Anal. **73**(1), pp. 31–51.
- M. Hauss (1997). *An Euler-Maclaurin-type formula involving conjugate Bernoulli polynomials and an application to  $\zeta(2m+1)$* . Commun. Appl. Anal. **1**(1), pp. 15–32.
- M. Hauss (1998). *A Boole-type Formula involving Conjugate Euler Polynomials*. In P. Butzer, H. T. Jongen, and W. Oberschelp (Eds.), *Charlemagne and his Heritage. 1200 Years of Civilization and Science in Europe, Vol. 2 (Aachen, 1995)*, pp. 361–375. Turnhout: Brepols Publishers.
- B. Hayes (2009). *The higher arithmetic*. American Scientist **97**, pp. 364–368.
- V. B. Headley and V. K. Barwell (1975). *On the distribution of the zeros of generalized Airy functions*. Math. Comp. **29**(131), pp. 863–877.
- G. J. Heckman (1991). *An elementary approach to the hypergeometric shift operators of Opdam*. Invent. Math. **103**(2), pp. 341–350.
- M. Heil (1995). *Numerical Tools for the Study of Finite Gap Solutions of Integrable Systems*. Ph. D. thesis, Technischen Universität Berlin. (All relevant material, plus corrections, are included in Deconinck *et al.* (2004).)
- R. S. Heller (1976). *25D Table of the First One Hundred Values of  $j_{0,s}, J_1(j_{0,s}), j_{1,s}, J_0(j_{1,s}) = J_0(j'_{0,s+1}), j'_{1,s}, J_1(j'_{1,s})$* . Technical report, Department of Physics, Worcester Polytechnic Institute, Worcester, MA. Ms. of six pages deposited in the UMT file.
- E. Hendriksen and H. van Rossum (1986). *Orthogonal Laurent polynomials*. Nederl. Akad. Wetensch. Indag. Math. **48**(1), pp. 17–36.
- P. Henrici (1974). *Applied and Computational Complex Analysis. Vol. 1: Power Series—Integration—Conformal Mapping—Location of Zeros*. Pure and Applied Mathematics. New York: Wiley-Interscience [John Wiley & Sons]. Reprinted in 1988.
- P. Henrici (1977). *Applied and Computational Complex Analysis. Vol. 2: Special Functions—Integral Transforms—Asymptotics—Continued Fractions*. New York: Wiley-Interscience [John Wiley & Sons]. Reprinted in 1991.
- P. Henrici (1986). *Applied and Computational Complex Analysis. Vol. 3: Discrete Fourier Analysis—Cauchy Integrals—Construction of Conformal Maps—Univalent Functions*. Pure and Applied Mathematics. New York: Wiley-Interscience [John Wiley & Sons Inc.]. Reprinted in 1993.
- D. R. Herrick and S. O'Connor (1998). *Inverse virial symmetry of diatomic potential curves*. J. Chem. Phys. **109**(1), pp. 11–19.
- C. S. Herz (1955). *Bessel functions of matrix argument*. Ann. of Math. (2) **61**(3), pp. 474–523.
- H. W. Hethcote (1970). *Error bounds for asymptotic approximations of zeros of Hankel functions occurring in diffraction problems*. J. Mathematical Phys. **11**(8), pp. 2501–2504.
- D. Hilbert (1909). *Beweis für die Darstellbarkeit der ganzen Zahlen durch eine feste Anzahl  $n^{\text{ter}}$  Potenzen (Waringsches Problem)*. Nachrichten von der Gesellschaft der Wissenschaften zu Göttingen, Mathematisch-Physikalische Klasse, pp. 17–36. Also in Math. Annalen (1909), v. 67, pp. 281–300.
- F. B. Hildebrand (1974). *Introduction to Numerical Analysis* (2nd ed.). New York: McGraw-Hill Book Co. Reprinted by Dover Publications Inc., New York, 1987.
- C. J. Hill (1828). *Über die Integration logarithmischer-rationaler Differentiale*. J. Reine Angew. Math. **3**, pp. 101–159.
- E. Hille (1929). *Note on some hypergeometric series of higher order*. J. London Math. Soc. **4**, pp. 50–54.
- E. Hille (1976). *Ordinary Differential Equations in the Complex Domain*. Pure and Applied Mathematics. New York: Wiley-Interscience [John Wiley & Sons]. Reprinted by Dover Publications Inc., New York, 1997.
- P. Hillion (1997). *Diffraction and Weber functions*. SIAM J. Appl. Math. **57**(6), pp. 1702–1715.
- M. H. Hirata (1975). *Flow near the bow of a steadily turning ship*. J. Fluid Mech. **71**(2), pp. 283–291.
- N. J. Hitchin (1995). *Poncelet Polygons and the Painlevé Equations*. In Ramanan (Ed.), *Geometry and Analysis (Bombay, 1992)*, pp. 151–185. Bombay: Tata Inst. Fund. Res.

- N. J. Hitchin (2003). *A lecture on the octahedron*. Bull. London Math. Soc. **35**(5), pp. 577–600.
- E. W. Hobson (1928). *A Treatise on Plane and Advanced Trigonometry* (7th ed.). Cambridge University Press. Reprinted by Dover Publications Inc., New York, 2004.
- E. W. Hobson (1931). *The Theory of Spherical and Ellipsoidal Harmonics*. London-New York: Cambridge University Press. Reprinted by Chelsea Publishing Company, New York, 1955 and 1965.
- H. Hochstadt (1963). *Estimates of the stability intervals for Hill's equation*. Proc. Amer. Math. Soc. **14**(6), pp. 930–932.
- H. Hochstadt (1964). *Differential Equations: A Modern Approach*. New York: Holt, Rinehart and Winston. Reprinted by Dover in 1975.
- H. Hochstadt (1971). *The Functions of Mathematical Physics*. New York-London-Sydney: Wiley-Interscience [John Wiley & Sons, Inc.]. Pure and Applied Mathematics, Vol. XXIII. Reprinted with corrections by Dover Publications Inc., New York, 1986.
- L. E. Hoisington and G. Breit (1938). *Calculation of Coulomb wave functions for high energies*. Phys. Rev. **54**(8), pp. 627–628.
- P. Holmes and D. Spence (1984). *On a Painlevé-type boundary-value problem*. Quart. J. Mech. Appl. Math. **37**(4), pp. 525–538.
- E. Hopf (1934). *Mathematical Problems of Radiative Equilibrium*. Cambridge Tracts in Mathematics and Mathematical Physics No. 31. Cambridge: Cambridge University Press. Reprinted by Stechert-Hafner, Inc., New York, 1964.
- K. Horata (1989). *An explicit formula for Bernoulli numbers*. Rep. Fac. Sci. Technol. Meijo Univ. **29**, pp. 1–6.
- K. Horata (1991). *On congruences involving Bernoulli numbers and irregular primes. II*. Rep. Fac. Sci. Technol. Meijo Univ. **31**, pp. 1–8.
- F. T. Howard (1976). *Roots of the Euler polynomials*. Pacific J. Math. **64**(1), pp. 181–191.
- F. T. Howard (1996a). *Explicit formulas for degenerate Bernoulli numbers*. Discrete Math. **162**(1-3), pp. 175–185.
- F. T. Howard (1996b). *Sums of powers of integers via generating functions*. Fibonacci Quart. **34**(3), pp. 244–256.
- C. J. Howls (1992). *Hyperasymptotics for integrals with finite endpoints*. Proc. Roy. Soc. London Ser. A **439**, pp. 373–396.
- C. J. Howls, P. J. Langman, and A. B. Olde Daalhuis (2004). *On the higher-order Stokes phenomenon*. Proc. Roy. Soc. London Ser. A **460**, pp. 2285–2303.
- C. J. Howls and A. B. Olde Daalhuis (1999). *On the resurgence properties of the uniform asymptotic expansion of Bessel functions of large order*. Proc. Roy. Soc. London Ser. A **455**, pp. 3917–3930.
- M. Hoyles, S. Kuyucak, and S.-H. Chung (1998). *Solutions of Poisson's equation in channel-like geometries*. Comput. Phys. Comm. **115**(1), pp. 45–68.
- L. K. Hua (1963). *Harmonic Analysis of Functions of Several Complex Variables in the Classical Domains*, Volume 6 of *Translations of Mathematical Monographs*. Providence, RI: American Mathematical Society. Reprinted in 1979.
- I.-C. Huang and S.-Y. Huang (1999). *Bernoulli numbers and polynomials via residues*. J. Number Theory **76**(2), pp. 178–193.
- J. H. Hubbard and B. B. Hubbard (2002). *Vector Calculus, Linear Algebra, and Differential Forms: A Unified Approach* (2nd ed.). Upper Saddle River, NJ: Prentice Hall Inc.
- M. H. Hull, Jr. and G. Breit (1959). *Coulomb Wave Functions*. In S. Flügge (Ed.), *Handbuch der Physik, Bd. 41/1*, pp. 408–465. Berlin: Springer.
- P. Humbert (1920). *Sur les fonctions hypercylindriques*. C. R. Acad. Sci. Paris Sér. I Math. **171**, pp. 490–492.
- J. Humblet (1984). *Analytical structure and properties of Coulomb wave functions for real and complex energies*. Ann. Physics **155**(2), pp. 461–493.
- J. Humblet (1985). *Bessel function expansions of Coulomb wave functions*. J. Math. Phys. **26**(4), pp. 656–659.
- C. Hunter (1981). *Two Parametric Eigenvalue Problems of Differential Equations*. In *Spectral Theory of Differential Operators (Birmingham, AL, 1981)*, Volume 55 of *North-Holland Math. Stud.*, pp. 233–241. Amsterdam: North-Holland.
- C. Hunter and B. Guerrieri (1981). *The eigenvalues of Mathieu's equation and their branch points*. Stud. Appl. Math. **64**(2), pp. 113–141.
- C. Hunter and B. Guerrieri (1982). *The eigenvalues of the angular spheroidal wave equation*. Stud. Appl. Math. **66**(3), pp. 217–240.
- G. Hunter and M. Kuriyan (1976). *Asymptotic expansions of Mathieu functions in wave mechanics*. J. Comput. Phys. **21**(3), pp. 319–325.
- A. Hurwitz (1882). *Einige Eigenschaften der Dirichletschen Functionen  $F(s) = \sum (\frac{D}{n}) \cdot \frac{1}{n}$ , die bei der Bestimmung der Klassenanzahlen binärer quadratischer Formen auftreten*. Zeitschrift für Math. u. Physik **27**, pp. 86–101.
- IEEE (1985). *IEEE Standard for Binary Floating-Point Arithmetic*. The Institute of Electrical and Electronics Engineers. ANSI/IEEE Std 754-1985. Reprinted in *ACM SIGPLAN Notices* v. 22, no. 2 (1987), pp. 9–25.

- J.-I. Igusa (1972). *Theta Functions*. New York: Springer-Verlag. Die Grundlehren der mathematischen Wissenschaften, Band 194.
- Y. Ikebe (1975). *The zeros of regular Coulomb wave functions and of their derivatives*. Math. Comp. **29**, pp. 878–887.
- Y. Ikebe, Y. Kikuchi, and I. Fujishiro (1991). *Computing zeros and orders of Bessel functions*. J. Comput. Appl. Math. **38**(1-3), pp. 169–184.
- Y. Ikebe, Y. Kikuchi, I. Fujishiro, N. Asai, K. Takashi, and M. Harada (1993). *The eigenvalue problem for infinite compact complex symmetric matrices with application to the numerical computation of complex zeros of  $J_0(z) - iJ_1(z)$  and of Bessel functions  $J_m(z)$  of any real order  $m$* . Linear Algebra Appl. **194**, pp. 35–70.
- M. Ikononou, P. Köhler, and A. F. Jacob (1995). *Computation of integrals over the half-line involving products of Bessel functions, with application to microwave transmission lines*. Z. Angew. Math. Mech. **75**(12), pp. 917–926.
- E. L. Ince (1926). *Ordinary Differential Equations*. London: Longmans, Green and Co. Reprinted by Dover Publications, New York, 1944, 1956.
- E. L. Ince (1932). *Tables of the elliptic cylinder functions*. Proc. Roy. Soc. Edinburgh Sect. A **52**, pp. 355–433.
- E. L. Ince (1940a). *The periodic Lamé functions*. Proc. Roy. Soc. Edinburgh **60**, pp. 47–63.
- E. L. Ince (1940b). *Further investigations into the periodic Lamé functions*. Proc. Roy. Soc. Edinburgh **60**, pp. 83–99.
- A. E. Ingham (1932). *The Distribution of Prime Numbers*. Cambridge Tracts in Mathematics and Mathematical Physics, No. 30. Cambridge: Cambridge University Press. Reissued with a foreword by R. C. Vaughan in the Cambridge Mathematical Library series, 1990.
- A. E. Ingham (1933). *An integral which occurs in statistics*. Proceedings of the Cambridge Philosophical Society **29**, pp. 271–276.
- K. Inkeri (1959). *The real roots of Bernoulli polynomials*. Ann. Univ. Turku. Ser. A I **37**, pp. 1–20.
- K. Ireland and M. Rosen (1990). *A Classical Introduction to Modern Number Theory* (2nd ed.). New York: Springer-Verlag.
- A. Iserles (1996). *A First Course in the Numerical Analysis of Differential Equations*. Cambridge Texts in Applied Mathematics, No. 15. Cambridge: Cambridge University Press.
- A. Iserles, P. E. Koch, S. P. Nørsett, and J. M. Sanz-Serna (1991). *On polynomials orthogonal with respect to certain Sobolev inner products*. J. Approx. Theory **65**(2), pp. 151–175.
- A. Iserles, S. P. Nørsett, and S. Olver (2006). *Highly Oscillatory Quadrature: The Story So Far*. In A. Bermudez de Castro et al. (Eds.), *Numerical Mathematics and Advanced Applications*, pp. 97–118. Berlin: Springer-Verlag. Proceedings of ENuMath, Santiago de Compostela (2005).
- M. E. H. Ismail (1986). *Asymptotics of the Askey-Wilson and  $q$ -Jacobi polynomials*. SIAM J. Math. Anal. **17**(6), pp. 1475–1482.
- M. E. H. Ismail (2000a). *An electrostatics model for zeros of general orthogonal polynomials*. Pacific J. Math. **193**(2), pp. 355–369.
- M. E. H. Ismail (2000b). *More on electrostatic models for zeros of orthogonal polynomials*. Numer. Funct. Anal. Optim. **21**(1-2), pp. 191–204.
- M. E. H. Ismail (2005). *Classical and Quantum Orthogonal Polynomials in One Variable*, Volume 98 of *Encyclopedia of Mathematics and its Applications*. Cambridge: Cambridge University Press.
- M. E. H. Ismail, J. Letessier, G. Valent, and J. Wimp (1990). *Two families of associated Wilson polynomials*. Canad. J. Math. **42**(4), pp. 659–695.
- M. E. H. Ismail and X. Li (1992). *Bound on the extreme zeros of orthogonal polynomials*. Proc. Amer. Math. Soc. **115**(1), pp. 131–140.
- M. E. H. Ismail and D. R. Masson (1991). *Two families of orthogonal polynomials related to Jacobi polynomials*. Rocky Mountain J. Math. **21**(1), pp. 359–375.
- M. E. H. Ismail and D. R. Masson (1994).  *$q$ -Hermite polynomials, biorthogonal rational functions, and  $q$ -beta integrals*. Trans. Amer. Math. Soc. **346**(1), pp. 63–116.
- M. E. H. Ismail and M. E. Muldoon (1995). *Bounds for the small real and purely imaginary zeros of Bessel and related functions*. Methods Appl. Anal. **2**(1), pp. 1–21.
- A. R. Its, A. S. Fokas, and A. A. Kapaev (1994). *On the asymptotic analysis of the Painlevé equations via the isomonodromy method*. Nonlinearity **7**(5), pp. 1291–1325.
- A. R. Its and A. A. Kapaev (1987). *The method of isomonodromic deformations and relation formulas for the second Painlevé transcendent*. Izv. Akad. Nauk SSSR Ser. Mat. **51**(4), pp. 878–892, 912. In Russian. English translation: Math. USSR-Izv. **31**(1988), no. 1, pp. 193–207.
- A. R. Its and A. A. Kapaev (1998). *Connection formulae for the fourth Painlevé transcendent; Clarkson-McLeod solution*. J. Phys. A **31**(17), pp. 4073–4113.
- A. R. Its and A. A. Kapaev (2003). *Quasi-linear Stokes phenomenon for the second Painlevé transcendent*. Nonlinearity **16**(1), pp. 363–386.

- A. R. Its and V. Y. Novokshënov (1986). *The Isomonodromic Deformation Method in the Theory of Painlevé Equations*, Volume 1191 of *Lecture Notes in Mathematics*. Berlin: Springer-Verlag.
- C. Itzykson and J.-M. Drouffe (1989). *Statistical Field Theory: Strong Coupling, Monte Carlo Methods, Conformal Field Theory, and Random Systems*, Volume 2. Cambridge: Cambridge University Press.
- C. Itzykson and J. B. Zuber (1980). *Quantum Field Theory*. International Series in Pure and Applied Physics. New York: McGraw-Hill International Book Co. Reprinted by Dover, 2006.
- A. Ivić (1985). *The Riemann Zeta-Function*. A Wiley-Interscience Publication. New York: John Wiley & Sons Inc. Reprinted by Dover, 2003.
- K. Iwasaki, H. Kimura, S. Shimomura, and M. Yoshida (1991). *From Gauss to Painlevé: A Modern Theory of Special Functions*, Volume 16 of *Aspects of Mathematics E*. Braunschweig, Germany: Friedr. Vieweg & Sohn.
- J. D. Jackson (1999). *Classical Electrodynamics* (3rd ed.). New York: John Wiley & Sons Inc.
- C. G. J. Jacobi (1829). *Fundamenta Nova Theoriae Functionum Ellipticarum*. Regiomonti, Sumptibus fratrum Bornträger. Reprinted in *Werke*, Vol. I, pp. 49–239, Herausgegeben von C. W. Borchardt, Berlin, Verlag von G. Reimer, 1881.
- D. Jacobs and F. Lambert (1972). *On the numerical calculation of polylogarithms*. *Nordisk Tidskr. Informationsbehandling (BIT)* **12**(4), pp. 581–585.
- L. Jacobsen, W. B. Jones, and H. Waadeland (1986). *Further results on the computation of incomplete gamma functions*. In W. J. Thron (Ed.), *Analytic Theory of Continued Fractions, II (Pitlochry/Aviemore, 1985)*, Lecture Notes in Math. 1199, pp. 67–89. Berlin: Springer-Verlag.
- L. Jager (1997). *Fonctions de Mathieu et polynômes de Klein-Gordon*. *C. R. Acad. Sci. Paris Sér. I Math.* **325**(7), pp. 713–716. Translated title: *Mathieu functions and Klein-Gordon polynomials*.
- L. Jager (1998). *Fonctions de Mathieu et fonctions propres de l'oscillateur relativiste*. *Ann. Fac. Sci. Toulouse Math.* (6) **7**(3), pp. 465–495. Translated title: *Mathieu functions and eigenfunctions of the relativistic oscillator*.
- D. L. Jagerman (1974). *Some properties of the Erlang loss function*. *Bell System Tech. J.* **53**, pp. 525–551.
- E. Jahnke and F. Emde (1945). *Tables of Functions with Formulae and Curves* (4th ed.). New York: Dover Publications. Contains corrections and enlargements of earlier editions. Originally published by B. G. Teubner, Leipzig, in 1933. In German and English.
- E. Jahnke, F. Emde, and F. Lösch (1966). *Tafeln höherer Funktionen (Tables of Higher Functions)* (7th ed.). Stuttgart: B. G. Teubner. Reprint of sixth edition (McGraw-Hill, New York, 1960) with corrections and updated bibliography. The sixth edition is a completely revised and enlarged version of Jahnke and Emde (1945). In German and English.
- A. T. James (1964). *Distributions of matrix variates and latent roots derived from normal samples*. *Ann. Math. Statist.* **35**(2), pp. 475–501.
- J. K. M. Jansen (1977). *Simple-periodic and Non-periodic Lamé Functions*. Mathematical Centre Tracts, No. 72. Amsterdam: Mathematisch Centrum.
- S. Janson, D. E. Knuth, T. Łuczak, and B. Pittel (1993). *The birth of the giant component*. *Random Structures Algorithms* **4**(3), pp. 231–358. With an introduction by the editors.
- H. Jeffreys (1928). *The effect on Love waves of heterogeneity in the lower layer*. *Monthly Notices Roy. Astronom. Soc. Geophysical Supplement* **2**, pp. 101–111.
- H. Jeffreys and B. S. Jeffreys (1956). *Methods of Mathematical Physics* (3rd ed.). Cambridge: Cambridge University Press. Reprinted in 1999.
- A. J. Jerri (1982). *A note on sampling expansion for a transform with parabolic cylinder kernel*. *Inform. Sci.* **26**(2), pp. 155–158.
- M. Jimbo and T. Miwa (1981). *Monodromy preserving deformation of linear ordinary differential equations with rational coefficients. II*. *Phys. D* **2**(3), pp. 407–448.
- M. Jimbo, T. Miwa, Y. Mōri, and M. Sato (1980). *Density matrix of an impenetrable Bose gas and the fifth Painlevé transcendent*. *Phys. D* **1**(1), pp. 80–158.
- X.-S. Jin and R. Wong (1998). *Uniform asymptotic expansions for Meixner polynomials*. *Constr. Approx.* **14**(1), pp. 113–150.
- X.-S. Jin and R. Wong (1999). *Asymptotic formulas for the zeros of the Meixner polynomials*. *J. Approx. Theory* **96**(2), pp. 281–300.
- H. K. Johansen and K. Sørensen (1979). *Fast Hankel transforms*. *Geophysical Prospecting* **27**(4), pp. 876–901.
- J. H. Johnson and J. M. Blair (1973). *REMES2 — a Fortran program to calculate rational minimax approximations to a given function*. Technical Report AECL-4210, Atomic Energy of Canada Limited. Chalk River Nuclear Laboratories, Chalk River, Ontario.
- N. L. Johnson, S. Kotz, and N. Balakrishnan (1994). *Continuous Univariate Distributions* (2nd ed.), Volume I. New York: John Wiley & Sons Inc.
- N. L. Johnson, S. Kotz, and N. Balakrishnan (1995). *Continuous Univariate Distributions* (2nd ed.), Volume II. New York: John Wiley & Sons Inc.

- W. R. Johnson (2007). *Atomic Structure Theory: Lectures on Atomic Physics*. Berlin and Heidelberg: Springer.
- D. S. Jones (1964). *The Theory of Electromagnetism*. International Series of Monographs on Pure and Applied Mathematics, Vol. 47. A Pergamon Press Book. New York: The Macmillan Co.
- D. S. Jones (1972). *Asymptotic behavior of integrals*. SIAM Rev. **14**(2), pp. 286–317.
- D. S. Jones (1986). *Acoustic and Electromagnetic Waves*. Oxford Science Publications. New York: The Clarendon Press Oxford University Press.
- D. S. Jones (1997). *Introduction to Asymptotics: A Treatment Using Nonstandard Analysis*. River Edge, NJ: World Scientific Publishing Co. Inc.
- D. S. Jones (2001). *Asymptotics of the hypergeometric function*. Math. Methods Appl. Sci. **24**(6), pp. 369–389.
- D. S. Jones (2006). *Parabolic cylinder functions of large order*. J. Comput. Appl. Math. **190**(1-2), pp. 453–469.
- W. B. Jones and W. J. Thron (1974). *Numerical stability in evaluating continued fractions*. Math. Comp. **28**(127), pp. 795–810.
- W. B. Jones and W. J. Thron (1980). *Continued Fractions: Analytic Theory and Applications*, Volume 11 of *Encyclopedia of Mathematics and its Applications*. Reading, MA: Addison-Wesley Publishing Co.
- W. B. Jones and W. J. Thron (1985). *On the computation of incomplete gamma functions in the complex domain*. J. Comput. Appl. Math. **12/13**, pp. 401–417.
- A. Jonquière (1889). *Note sur la série  $\sum_{n=1}^{\infty} x^n/n^s$* . Bull. Soc. Math. France **17**, pp. 142–152.
- C. Jordan (1939). *Calculus of Finite Differences*. Budapest: Hungarian Agent Eggenberger Book-Shop. Third edition published in 1965 by Chelsea Publishing Co., New York, and American Mathematical Society, AMS Chelsea Book Series, Providence, RI.
- C. Jordan (1965). *Calculus of Finite Differences* (3rd ed.). Providence, RI: AMS Chelsea.
- S. Jorna and C. Springer (1971). *Derivation of Green-type, transitional and uniform asymptotic expansions from differential equations. V. Angular oblate spheroidal wavefunctions  $\overline{p}s_n^r(\eta, h)$  and  $\overline{q}s_n^r(\eta, h)$  for large  $h$* . Proc. Roy. Soc. London Ser. A **321**, pp. 545–555.
- N. Joshi and A. V. Kitaev (2001). *On Boutroux's tritronquée solutions of the first Painlevé equation*. Stud. Appl. Math. **107**(3), pp. 253–291.
- N. Joshi and A. V. Kitaev (2005). *The Dirichlet boundary value problem for real solutions of the first Painlevé equation on segments in non-positive semi-axis*. J. Reine Angew. Math. **583**, pp. 29–86.
- N. Joshi and M. D. Kruskal (1992). *The Painlevé connection problem: An asymptotic approach. I*. Stud. Appl. Math. **86**(4), pp. 315–376.
- G. S. Joyce (1973). *On the simple cubic lattice Green function*. Philos. Trans. Roy. Soc. London Ser. A **273**, pp. 583–610.
- G. S. Joyce (1994). *On the cubic lattice Green functions*. Proc. Roy. Soc. London Ser. A **445**, pp. 463–477.
- B. R. Judd (1975). *Angular Momentum Theory for Diatomic Molecules*. New York: Academic Press.
- B. R. Judd (1976). *Modifications of Coulombic interactions by polarizable atoms*. Math. Proc. Cambridge Philos. Soc. **80**(3), pp. 535–539.
- B. R. Judd (1998). *Operator Techniques in Atomic Spectroscopy*. Princeton, NJ: Princeton University Press.
- G. Julia (1918). *Memoire sur l'itération des fonctions rationnelles*. J. Math. Pures Appl. **8**(1), pp. 47–245.
- V. Kac and P. Cheung (2002). *Quantum Calculus*. Universitext. New York: Springer-Verlag.
- K. W. J. Kadell (1988). *A proof of Askey's conjectured  $q$ -analogue of Selberg's integral and a conjecture of Morris*. SIAM J. Math. Anal. **19**(4), pp. 969–986.
- K. W. J. Kadell (1994). *A proof of the  $q$ -Macdonald-Morris conjecture for  $BC_n$* . Mem. Amer. Math. Soc. **108**(516), pp. vi+80.
- W. Kahan (1987). *Branch Cuts for Complex Elementary Functions or Much Ado About Nothing's Sign Bit*. In A. Iserles and M. J. D. Powell (Eds.), *The State of the Art in Numerical Analysis (Birmingham, 1986)*, Volume 9 of *Inst. Math. Appl. Conf. Ser. New Ser.*, pp. 165–211. New York: Oxford Univ. Press.
- K. Kajiwara and T. Masuda (1999). *On the Umemura polynomials for the Painlevé III equation*. Phys. Lett. A **260**(6), pp. 462–467.
- K. Kajiwara and Y. Ohta (1996). *Determinant structure of the rational solutions for the Painlevé II equation*. J. Math. Phys. **37**(9), pp. 4693–4704.
- K. Kajiwara and Y. Ohta (1998). *Determinant structure of the rational solutions for the Painlevé IV equation*. J. Phys. A **31**(10), pp. 2431–2446.
- A. Kalähne (1907). *Über die Wurzeln einiger Zylinderfunktionen und gewisser aus ihnen gebildeter Gleichungen*. Zeitschrift für Mathematik und Physik **54**, pp. 55–86.
- S. L. Kalla (1992). *On the evaluation of the Gauss hypergeometric function*. C. R. Acad. Bulgare Sci. **45**(6), pp. 35–36.
- E. G. Kalnins (1986). *Separation of Variables for Riemannian Spaces of Constant Curvature*. Harlow: Longman Scientific & Technical.



- E. G. Kalnins and W. Miller, Jr. (1991a). *Hypergeometric expansions of Heun polynomials*. SIAM J. Math. Anal. **22**(5), pp. 1450–1459.
- E. G. Kalnins and W. Miller, Jr. (1991b). *Addendum: “Hypergeometric expansions of Heun polynomials”*. SIAM J. Math. Anal. **22**(6), p. 1803.
- E. G. Kalnins and W. Miller, Jr. (1993). *Orthogonal Polynomials on  $n$ -spheres: Gegenbauer, Jacobi and Heun*. In *Topics in Polynomials of One and Several Variables and their Applications*, pp. 299–322. River Edge, NJ: World Sci. Publishing.
- E. G. Kalnins, W. Miller, Jr., G. F. Torres del Castillo, and G. C. Williams (2000). *Special Functions and Perturbations of Black Holes*. In *Special Functions (Hong Kong, 1999)*, pp. 140–151. River Edge, NJ: World Sci. Publishing.
- E. G. Kalnins, W. Miller, Jr., and P. Winternitz (1976). *The group  $O(4)$ , separation of variables and the hydrogen atom*. SIAM J. Appl. Math. **30**(4), pp. 630–664.
- J. Kamimoto (1998). *On an integral of Hardy and Littlewood*. Kyushu J. Math. **52**(1), pp. 249–263.
- D. Kaminski and R. B. Paris (1999). *On the zeroes of the Pearcey integral*. J. Comput. Appl. Math. **107**(1), pp. 31–52.
- E. Kamke (1977). *Differentialgleichungen: Lösungsmethoden und Lösungen. Teil I*. Stuttgart: B. G. Teubner.
- M. Kaneko (1997). *Poly-Bernoulli numbers*. J. Théor. Nombres Bordeaux **9**(1), pp. 221–228.
- E. Kanzieper (2002). *Replica field theories, Painlevé transcendents, and exact correlation functions*. Phys. Rev. Lett. **89**(25), pp. (250201–1)–(250201–4).
- A. A. Kapaev (1988). *Asymptotic behavior of the solutions of the Painlevé equation of the first kind*. Differ. Uravn. **24**(10), pp. 1684–1695. In Russian. English translation: Differential Equations **24**(1988), no. 10, pp. 1107–1115 (1989).
- A. A. Kapaev (1991). *Essential singularity of the Painlevé function of the second kind and the nonlinear Stokes phenomenon*. Zap. Nauchn. Sem. Leningrad. Otdel. Mat. Inst. Steklov. (LOMI) **187**, pp. 139–170. English translation: J. Math. Sci. **73**(1995), no. 4, pp. 500–517.
- A. A. Kapaev (2004). *Quasi-linear Stokes phenomenon for the Painlevé first equation*. J. Phys. A **37**(46), pp. 11149–11167.
- A. A. Kapaev and A. V. Kitaev (1993). *Connection formulae for the first Painlevé transcendent in the complex domain*. Lett. Math. Phys. **27**(4), pp. 243–252.
- N. S. Kapany and J. J. Burke (1972). *Optical Waveguides*. Quantum Electronics - Principles and Applications. New York: Academic Press.
- P. L. Kapitsa (1951a). *The computation of the sums of negative even powers of roots of Bessel functions*. Doklady Akad. Nauk SSSR (N.S.) **77**, pp. 561–564.
- P. L. Kapitsa (1951b). *Heat conduction and diffusion in a fluid medium with a periodic flow. I. Determination of the wave transfer coefficient in a tube, slot, and canal*. Akad. Nauk SSSR. Zhurnal Eksper. Teoret. Fiz. **21**, pp. 964–978.
- E. L. Kaplan (1948). *Auxiliary table for the incomplete elliptic integrals*. J. Math. Physics **27**, pp. 11–36.
- A. A. Karatsuba and S. M. Voronin (1992). *The Riemann Zeta-Function*, Volume 5 of *de Gruyter Expositions in Mathematics*. Berlin: Walter de Gruyter & Co. Translated from the Russian by Neal Koblitz.
- S. Karlin and J. L. McGregor (1961). *The Hahn polynomials, formulas and an application*. Scripta Math. **26**, pp. 33–46.
- D. Karp, A. Savenkova, and S. M. Sitnik (2007). *Series expansions for the third incomplete elliptic integral via partial fraction decompositions*. J. Comput. Appl. Math. **207**(2), pp. 331–337.
- D. Karp and S. M. Sitnik (2007). *Asymptotic approximations for the first incomplete elliptic integral near logarithmic singularity*. J. Comput. Appl. Math. **205**(1), pp. 186–206.
- K. A. Karpov and È. A. Čistova (1964). *Tablitsy funktsii Vebra. Tom II*. Moscow: Vičisl. Centr Akad. Nauk SSSR.
- K. A. Karpov and È. A. Čistova (1968). *Tablitsy funktsii Vebra. Tom III*. Moscow: Vyčisl. Centr Akad. Nauk SSSR.
- A. V. Kashevarov (1998). *The second Painlevé equation in electric probe theory. Some numerical solutions*. Zh. Vyčisl. Mat. Mat. Fiz. **38**(6), pp. 992–1000. In Russian. English translation: Comput. Math. Math. Phys. **38**(1998), no. 6, pp. 950–958.
- A. V. Kashevarov (2004). *The second Painlevé equation in the electrostatic probe theory: Numerical solutions for the partial absorption of charged particles by the surface*. Technical Physics **49**(1), pp. 1–7.
- C. Kassel (1995). *Quantum Groups*, Volume 155 of *Graduate Texts in Mathematics*. New York: Springer-Verlag.
- N. M. Katz (1975). *The congruences of Clausen-von Staudt and Kummer for Bernoulli-Hurwitz numbers*. Math. Ann. **216**(1), pp. 1–4.
- E. H. Kaufman, Jr. and T. D. Lenker (1986). *Linear convergence and the bisection algorithm*. Amer. Math. Monthly **93**(1), pp. 48–51.
- A. Ya. Kazakov and S. Yu. Slavyanov (1996). *Integral equations for special functions of Heun class*. Methods Appl. Anal. **3**(4), pp. 447–456.

- N. D. Kazarinoff (1988). *Special functions and the Bieberbach conjecture*. Amer. Math. Monthly **95**(8), pp. 689–696.
- J. Keating (1993). *The Riemann Zeta-Function and Quantum Chaology*. In *Quantum Chaos (Varenna, 1991)*, Proc. Internat. School of Phys. Enrico Fermi, CXIX, pp. 145–185. Amsterdam: North-Holland.
- J. P. Keating (1999). *Periodic Orbits, Spectral Statistics, and the Riemann Zeros*. In J. P. Keating, D. E. Khmelnitskii, and I. V. Lerner (Eds.), *Supersymmetry and Trace Formulae: Chaos and Disorder*, pp. 1–15. New York: Springer-Verlag.
- R. P. Kelisky (1957). *On formulas involving both the Bernoulli and Fibonacci numbers*. Scripta Math. **23**, pp. 27–35.
- M. K. Kerimov (1980). *Methods of computing the Riemann zeta-function and some generalizations of it*. USSR Comput. Math. and Math. Phys. **20**(6), pp. 212–230.
- M. K. Kerimov (1999). *The Rayleigh function: Theory and computational methods*. Zh. Vychisl. Mat. Mat. Fiz. **39**(12), pp. 1962–2006. Translation in Comput. Math. Math. Phys. **39** (1999), No. 12, pp. 1883–1925.
- M. K. Kerimov and S. L. Skorokhodov (1984a). *Calculation of modified Bessel functions in a complex domain*. Zh. Vychisl. Mat. i Mat. Fiz. **24**(5), pp. 650–664. English translation in U.S.S.R. Computational Math. and Math. Phys. **24**(3), pp. 15–24.
- M. K. Kerimov and S. L. Skorokhodov (1984b). *Calculation of the complex zeros of the modified Bessel function of the second kind and its derivatives*. Zh. Vychisl. Mat. i Mat. Fiz. **24**(8), pp. 1150–1163. English translation in U.S.S.R. Computational Math. and Math. Phys. **24**(4), pp. 115–123.
- M. K. Kerimov and S. L. Skorokhodov (1984c). *Evaluation of complex zeros of Bessel functions  $J_\nu(z)$  and  $I_\nu(z)$  and their derivatives*. Zh. Vychisl. Mat. i Mat. Fiz. **24**(10), pp. 1497–1513. English translation in U.S.S.R. Computational Math. and Math. Phys. **24**(5), pp. 131–141.
- M. K. Kerimov and S. L. Skorokhodov (1985a). *Calculation of the complex zeros of a Bessel function of the second kind and its derivatives*. Zh. Vychisl. Mat. i Mat. Fiz. **25**(10), pp. 1457–1473, 1581. In Russian. English translation: USSR Comput. Math. Math. Phys., **25**(1985), no. 5, pp. 117–128.
- M. K. Kerimov and S. L. Skorokhodov (1985b). *Calculation of the complex zeros of Hankel functions and their derivatives*. Zh. Vychisl. Mat. i Mat. Fiz. **25**(11), pp. 1628–1643, 1741. English translation in U.S.S.R. Computational Math. and Math. Phys. **25**(6), pp. 26–36.
- M. K. Kerimov and S. L. Skorokhodov (1985c). *Calculation of the multiple zeros of the derivatives of the cylindrical Bessel functions  $J_\nu(z)$  and  $Y_\nu(z)$* . Zh. Vychisl. Mat. i Mat. Fiz. **25**(12), pp. 1749–1760, 1918. English translation in U.S.S.R. Computational Math. and Math. Phys. **25**(6), pp. 101–107.
- M. K. Kerimov and S. L. Skorokhodov (1986). *On multiple zeros of derivatives of Bessel's cylindrical functions*. Dokl. Akad. Nauk SSSR **288**(2), pp. 285–288. In Russian. English translation: Soviet Math. Dokl. **33**(3), 650–653, (1986).
- M. K. Kerimov and S. L. Skorokhodov (1987). *On the calculation of the multiple complex roots of the derivatives of cylindrical Bessel functions*. Zh. Vychisl. Mat. i Mat. Fiz. **27**(11), pp. 1628–1639, 1758. English translation in U.S.S.R. Computational Math. and Math. Phys. **27**(6), pp. 18–25.
- M. K. Kerimov and S. L. Skorokhodov (1988). *Multiple complex zeros of derivatives of the cylindrical Bessel functions*. Dokl. Akad. Nauk SSSR **299**(3), pp. 614–618. In Russian. English translation: Soviet Phys. Dokl. **33**(3), 196–198, (1988).
- M. Kerker (1969). *The Scattering of Light and Other Electromagnetic Radiation*. New York: Academic Press.
- A. D. Kerr (1978). *An indirect method for evaluating certain infinite integrals*. Z. Angew. Math. Phys. **29**(3), pp. 380–386.
- R. P. Kerr (1963). *Gravitational field of a spinning mass as an example of algebraically special metrics*. Phys. Rev. Lett. **11**(5), pp. 237–238.
- D. Kershaw (1983). *Some extensions of W. Gautschi's inequalities for the gamma function*. Math. Comp. **41**(164), pp. 607–611.
- S. Kesavan and A. S. Vasudevamurthy (1985). *On some boundary element methods for the heat equation*. Numer. Math. **46**(1), pp. 101–120.
- S. H. Khamis (1965). *Tables of the Incomplete Gamma Function Ratio: The Chi-square Integral, the Poisson Distribution*. Darmstadt: Justus von Liebig Verlag. In cooperation with W. Rudert.
- A. Khare, A. Lakshminarayan, and U. Sukhatme (2003). *Cyclic identities for Jacobi elliptic and related functions*. J. Math. Phys. **44**(4), pp. 1822–1841.
- A. Khare and U. Sukhatme (2002). *Cyclic identities involving Jacobi elliptic functions*. J. Math. Phys. **43**(7), pp. 3798–3806.
- A. Khare and U. Sukhatme (2004). *Connecting Jacobi elliptic functions with different modulus parameters*. Pragma **63**(5), pp. 921–936.
- A. I. Kheyfits (2004). *Closed-form representations of the Lambert W function*. Fract. Calc. Appl. Anal. **7**(2), pp. 177–190.

- H. Ki and Y.-O. Kim (2000). *On the zeros of some generalized hypergeometric functions*. J. Math. Anal. Appl. **243**(2), pp. 249–260.
- S. Kida (1981). *A vortex filament moving without change of form*. J. Fluid Mech. **112**, pp. 397–409.
- S. K. Kim (1972). *The asymptotic expansion of a hypergeometric function  ${}_2F_2(1, \alpha; \rho_1, \rho_2; z)$* . Math. Comp. **26**(120), p. 963.
- T. Kim and H. S. Kim (1999). *Remark on  $p$ -adic  $q$ -Bernoulli numbers*. Adv. Stud. Contemp. Math. (Pusan) **1**, pp. 127–136. Algebraic number theory (Hapcheon/Saga, 1996).
- N. Kimura (1988). *On the degree of an irreducible factor of the Bernoulli polynomials*. Acta Arith. **50**(3), pp. 243–249.
- B. J. King and A. L. Van Buren (1973). *A general addition theorem for spheroidal wave functions*. SIAM J. Math. Anal. **4**(1), pp. 149–160.
- I. Y. Kireyeva and K. A. Karpov (1961). *Tables of Weber functions. Vol. I*, Volume 15 of *Mathematical Tables Series*. London-New York: Pergamon Press. Translated by Prasenjit Basu.
- A. N. Kirillov (1995). *Dilogarithm identities*. Progr. Theoret. Phys. Suppl. (118), pp. 61–142.
- N. P. Kirk, J. N. L. Connor, and C. A. Hobbs (2000). *An adaptive contour code for the numerical evaluation of the oscillatory cuspid canonical integrals and their derivatives*. Computer Physics Comm. **132**(1-2), pp. 142–165.
- E. T. Kirkpatrick (1960). *Tables of values of the modified Mathieu functions*. Math. Comp. **14**, pp. 118–129.
- A. V. Kitaev (1987). *The method of isomonodromic deformations and the asymptotics of the solutions of the “complete” third Painlevé equation*. Mat. Sb. (N.S.) **134**(176)(3), pp. 421–444, 448. In Russian. English translation: Math. USSR-Sb. **62**(1989), no. 2, pp. 421–444.
- A. V. Kitaev (1994). *Elliptic asymptotics of the first and second Painlevé transcendents*. Uspekhi Mat. Nauk **49**(1(295)), pp. 77–140. In Russian. English translation: Russian Math. Surveys **49**(1994), no. 1, pp. 81–150.
- A. V. Kitaev, C. K. Law, and J. B. McLeod (1994). *Rational solutions of the fifth Painlevé equation*. Differential Integral Equations **7**(3-4), pp. 967–1000.
- A. V. Kitaev and A. H. Vartanian (2004). *Connection formulae for asymptotics of solutions of the degenerate third Painlevé equation. I*. Inverse Problems **20**(4), pp. 1165–1206.
- Y. Kivshar and B. Luther-Davies (1998). *Dark optical solitons: Physics and applications*. Physics Reports **298**(2-3), pp. 81–197.
- F. Klein (1894). *Vorlesungen über die hypergeometrische Funktion*. Göttingen. Reprint by Springer-Verlag, Berlin, 1981, of the 1933 original.
- A. Kneser (1927). *Neue Untersuchungen einer Reihe aus der Theorie der elliptischen Funktionen*. Journal für die Reine und Angewandte Mathematik **158**, pp. 209–218.
- H. Kneser (1950). *Reelle analytische Lösungen der Gleichung  $\varphi(\varphi(x)) = e^x$  und verwandter Funktionalgleichungen*. J. Reine Angew. Math. **187**, pp. 56–67.
- K. Knopp (1948). *Theory and Application of Infinite Series* (2nd ed.). New York: Hafner. R. C. Young, translator.
- K. Knopp (1964). *Theorie und Anwendung der unendlichen Reihen* (4th ed.). Die Grundlehren der mathematischen Wissenschaften, Band 2. Berlin-Heidelberg: Springer-Verlag. A translation by R. C. Young appeared in 1928, *Theory and Application of Infinite Series*, Blackie, 571pp.
- U. J. Knottnerus (1960). *Approximation Formulae for Generalized Hypergeometric Functions for Large Values of the Parameters*. Groningen: J. B. Wolters.
- D. E. Knuth (1968). *The Art of Computer Programming. Vol. 1: Fundamental Algorithms* (1st ed.). Reading, MA-London-Don Mills, Ont: Addison-Wesley Publishing Co. Second printing of second edition by Addison-Wesley Publishing Co., Reading, MA-London-Amsterdam, 1975.
- D. E. Knuth (1986). *METAFONT: The Program*, Volume D of *Computers and Typesetting*. Reading, MA: Addison-Wesley.
- D. E. Knuth (1992). *Two notes on notation*. Amer. Math. Monthly **99**(5), pp. 403–422.
- D. E. Knuth and T. J. Buckholtz (1967). *Computation of tangent, Euler, and Bernoulli numbers*. Math. Comp. **21**(100), pp. 663–688.
- N. Koblitz (1984).  *$p$ -adic Numbers,  $p$ -adic Analysis, and Zeta-Functions* (2nd ed.), Volume 58 of *Graduate Texts in Mathematics*. New York: Springer-Verlag.
- N. Koblitz (1993). *Introduction to Elliptic Curves and Modular Forms* (2nd ed.), Volume 97 of *Graduate Texts in Mathematics*. New York: Springer-Verlag.
- N. Koblitz (1999). *Algebraic Aspects of Cryptography*. Berlin: Springer-Verlag. Second printing with corrections.
- M. Koecher (1954). *Zur Theorie der Modulformen  $n$ -ten Grades. I*. Math. Z. **59**, pp. 399–416.
- J. Koekoek, R. Koekoek, and H. Bavinck (1998). *On differential equations for Sobolev-type Laguerre polynomials*. Trans. Amer. Math. Soc. **350**(1), pp. 347–393.

- R. Koekoek and R. F. Swarttouw (1998). *The Askey-scheme of hypergeometric orthogonal polynomials and its  $q$ -analogue*. Technical Report 98-17, Delft University of Technology, Faculty of Information Technology and Systems, Department of Technical Mathematics and Informatics. An online version exists.
- P. Koev and A. Edelman (2006). *The efficient evaluation of the hypergeometric function of a matrix argument*. *Math. Comp.* **75**(254), pp. 833–846.
- D. A. Kofke (2004). *Comment on “The incomplete beta function law for parallel tempering sampling of classical canonical systems”* [*J. Chem. Phys.* **120**, 4119 (2004)]. *J. Chem. Phys.* **121**(2), p. 1167.
- S. Koizumi (1976). *Theta relations and projective normality of Abelian varieties*. *Amer. J. Math.* **98**(4), pp. 865–889.
- G. C. Kokkorakis and J. A. Roumeliotis (1998). *Electromagnetic eigenfrequencies in a spheroidal cavity (calculation by spheroidal eigenvectors)*. *J. Electromagn. Waves Appl.* **12**(12), pp. 1601–1624.
- C. G. Kokologiannaki, P. D. Siafarikas, and C. B. Kouris (1992). *On the complex zeros of  $H_\mu(z)$ ,  $J'_\mu(z)$ ,  $J''_\mu(z)$  for real or complex order*. *J. Comput. Appl. Math.* **40**(3), pp. 337–344.
- K. S. Kölbig (1970). *Complex zeros of an incomplete Riemann zeta function and of the incomplete gamma function*. *Math. Comp.* **24**(111), pp. 679–696.
- K. S. Kölbig (1972a). *Complex zeros of two incomplete Riemann zeta functions*. *Math. Comp.* **26**(118), pp. 551–565.
- K. S. Kölbig (1972b). *On the zeros of the incomplete gamma function*. *Math. Comp.* **26**(119), pp. 751–755.
- K. S. Kölbig (1981). *A program for computing the conical functions of the first kind  $P_{-\frac{1}{2}+i\tau}^m(x)$  for  $m = 0$  and  $m = 1$* . *Comput. Phys. Comm.* **23**(1), pp. 51–61.
- K. S. Kölbig (1986). *Nielsen’s generalized polylogarithms*. *SIAM J. Math. Anal.* **17**(5), pp. 1232–1258.
- K. S. Kölbig, J. A. Mignaco, and E. Remiddi (1970). *On Nielsen’s generalized polylogarithms and their numerical calculation*. *Nordisk Tidskr. Informationsbehandling (BIT)* **10**, pp. 38–73.
- G. A. Kolesnik (1969). *An improvement of the remainder term in the divisor problem*. *Mat. Zametki* **6**, pp. 545–554. In Russian. English translation: *Math. Notes* **6**(1969), no. 5, pp. 784–791.
- I. V. Komarov, L. I. Ponomarev, and S. Yu. Slavyanov (1976). *Sferoidalnye i kulonovskie sferoidalnye funktsii*. Moscow: Izdat. “Nauka”. Translated title: *Spheroidal and Coulomb Spheroidal Functions*.
- E. J. Konopinski (1981). *Electromagnetic Fields and Relativistic Particles*. International Series in Pure and Applied Physics. New York: McGraw-Hill Book Co.
- T. H. Koornwinder (1974). *Jacobi polynomials. II. An analytic proof of the product formula*. *SIAM J. Math. Anal.* **5**, pp. 125–137.
- T. H. Koornwinder (1975a). *Jacobi polynomials. III. An analytic proof of the addition formula*. *SIAM J. Math. Anal.* **6**, pp. 533–543.
- T. H. Koornwinder (1975b). *A new proof of a Paley-Wiener type theorem for the Jacobi transform*. *Ark. Mat.* **13**, pp. 145–159.
- T. H. Koornwinder (1975c). *Two-variable Analogues of the Classical Orthogonal Polynomials*. In R. A. Askey (Ed.), *Theory and Application of Special Functions*, pp. 435–495. New York: Academic Press.
- T. H. Koornwinder (1977). *The addition formula for Laguerre polynomials*. *SIAM J. Math. Anal.* **8**(3), pp. 535–540.
- T. H. Koornwinder (1984a). *Jacobi Functions and Analysis on Noncompact Semisimple Lie Groups*. In *Special Functions: Group Theoretical Aspects and Applications*, pp. 1–85. Dordrecht: Reidel. Reprinted by Kluwer Academic Publishers, Boston, 2002.
- T. H. Koornwinder (1984b). *Orthogonal polynomials with weight function  $(1-x)^\alpha(1+x)^\beta + M\delta(x+1) + N\delta(x-1)$* . *Canad. Math. Bull.* **27**(2), pp. 205–214.
- T. H. Koornwinder (1989). *Meixner-Pollaczek polynomials and the Heisenberg algebra*. *J. Math. Phys.* **30**(4), pp. 767–769.
- T. H. Koornwinder (1992). *Askey-Wilson Polynomials for Root Systems of Type BC*. In *Hypergeometric Functions on Domains of Positivity, Jack Polynomials, and Applications (Tampa, FL, 1991)*, Volume 138 of *Contemp. Math.*, pp. 189–204. Providence, RI: Amer. Math. Soc.
- T. H. Koornwinder (2006). *Lowering and Raising Operators for Some Special Orthogonal Polynomials*. In *Jack, Hall-Littlewood and Macdonald Polynomials*, Volume 417 of *Contemp. Math.*, pp. 227–238. Providence, RI: Amer. Math. Soc.
- T. H. Koornwinder and I. Sprinkhuizen-Kuyper (1978). *Hypergeometric functions of  $2 \times 2$  matrix argument are expressible in terms of Appel’s functions  $F_4$* . *Proc. Amer. Math. Soc.* **70**(1), pp. 39–42.
- B. G. Korenev (2002). *Bessel Functions and their Applications*, Volume 8 of *Analytical Methods and Special Functions*. London-New York: Taylor & Francis Ltd. Translated from the Russian by E. V. Pankratiev.
- V. E. Korepin, N. M. Bogoliubov, and A. G. Izergin (1993). *Quantum Inverse Scattering Method and Correlation Functions*. Cambridge: Cambridge University Press.
- T. W. Körner (1989). *Fourier Analysis* (2nd ed.). Cambridge: Cambridge University Press.

- N. M. Korobov (1958). *Estimates of trigonometric sums and their applications*. Uspehi Mat. Nauk **13**(4 (82)), pp. 185–192.
- V. Kourganoff (1952). *Basic Methods in Transfer Problems. Radiative Equilibrium and Neutron Diffusion*. Oxford: Oxford University Press. With the collaboration of I. W. Busbridge.
- J. J. Kovacic (1986). *An algorithm for solving second order linear homogeneous differential equations*. J. Symbolic Comput. **2**(1), pp. 3–43.
- S. Kowalevski (1889). *Sur le problème de la rotation d'un corps solide autour d'un point fixe*. Acta Math. **12**(1), pp. 177–232.
- Y. A. Kravtsov (1964). *Asymptotic solution of Maxwell's equations near caustics*. Izv. Vuz. Radiofiz. **7**, pp. 1049–1056.
- Y. A. Kravtsov (1968). *Two new asymptotic methods in the theory of wave propagation in inhomogeneous media*. Sov. Phys. Acoust. **14**, pp. 1–17.
- Y. A. Kravtsov (1988). *Rays and caustics as physical objects*. In E. Wolf (Ed.), *Progress in Optics*, Volume 26, pp. 227–348. Amsterdam: North-Holland.
- R. Kress and E. Martensen (1970). *Anwendung der Rechteckregel auf die reelle Hilberttransformation mit unendlichem Intervall*. Z. Angew. Math. Mech. **50**(1-4), pp. T61–T64.
- E. Kreyszig (1957). *On the zeros of the Fresnel integrals*. Canad. J. Math. **9**, pp. 118–131.
- I. M. Krichever (1976). *An algebraic-geometrical construction of the Zakharov-Shabat equations and their periodic solutions*. Sov. Math. Doklady **17**, pp. 394–397.
- I. M. Krichever and S. P. Novikov (1989). *Algebras of Virasoro type, the energy-momentum tensor, and operator expansions on Riemann surfaces*. Funktsional. Anal. i Prilozhen. **23**(1), pp. 24–40. In Russian. English translation: Funct. Anal. Appl. **23**(1989), no. 1, pp. 19–33.
- S. G. Krivoshlykov (1994). *Quantum-Theoretical Formalism for Inhomogeneous Graded-Index Waveguides*. Berlin-New York: Akademie Verlag.
- E. D. Krupnikov and K. S. Kölbig (1997). *Some special cases of the generalized hypergeometric function  ${}_{q+1}F_q$* . J. Comput. Appl. Math. **78**(1), pp. 79–95.
- M. D. Kruskal (1974). *The Korteweg-de Vries Equation and Related Evolution Equations*. In A. C. Newell (Ed.), *Nonlinear Wave Motion (Proc. AMS-SIAM Summer Sem., Clarkson Coll. Tech., Potsdam, N.Y., 1972)*, Lectures in Appl. Math., Vol. 15, pp. 61–83. Providence, RI: Amer. Math. Soc.
- M. D. Kruskal and P. A. Clarkson (1992). *The Painlevé-Kowalevski and poly-Painlevé tests for integrability*. Stud. Appl. Math. **86**(2), pp. 87–165.
- V. I. Krylov and N. S. Skoblya (1985). *A Handbook of Methods of Approximate Fourier Transformation and Inversion of the Laplace Transformation*. Moscow: Mir. Translated from the Russian by George Yankovsky. Reprint of the 1977 translation.
- M. Kurz (1979). *Fehlerabschätzungen zu asymptotischen Entwicklungen der Eigenwerte und Eigenlösungen der Mathieuschen Differentialgleichung*. Ph. D. thesis, Universität Duisburg-Essen, Essen, D 45177.
- V. B. Kuznetsov (1992). *Equivalence of two graphical calculi*. J. Phys. A **25**(22), pp. 6005–6026.
- V. B. Kuznetsov and S. Sahi (Eds.) (2006). *Jack, Hall-Littlewood and Macdonald Polynomials*, Volume 417 of *Contemporary Mathematics*, Providence, RI. American Mathematical Society. Proceedings of the workshop held in Edinburgh, September 23–26, 2003.
- K. H. Kwon, L. L. Littlejohn, and G. J. Yoon (2006). *Construction of differential operators having Bochner-Krall orthogonal polynomials as eigenfunctions*. J. Math. Anal. Appl. **324**(1), pp. 285–303.
- G. Labahn and M. Mutrie (1997). *Reduction of Elliptic Integrals to Legendre Normal Form*. Technical Report 97-21, Department of Computer Science, University of Waterloo, Waterloo, Ontario.
- A. Laforgia (1979). *On the Zeros of the Derivative of Bessel Functions of Second Kind*, Volume 179 of *Pubblicazioni Serie III [Publication Series III]*. Rome: Istituto per le Applicazioni del Calcolo “Mauro Picone” (IAC).
- A. Laforgia (1984). *Further inequalities for the gamma function*. Math. Comp. **42**(166), pp. 597–600.
- A. Laforgia (1986). *Inequalities for Bessel functions*. J. Comput. Appl. Math. **15**(1), pp. 75–81.
- A. Laforgia (1991). *Bounds for modified Bessel functions*. J. Comput. Appl. Math. **34**(3), pp. 263–267.
- A. Laforgia and M. E. Muldoon (1983). *Inequalities and approximations for zeros of Bessel functions of small order*. SIAM J. Math. Anal. **14**(2), pp. 383–388.
- A. Laforgia and M. E. Muldoon (1988). *Monotonicity properties of zeros of generalized Airy functions*. Z. Angew. Math. Phys. **39**(2), pp. 267–271.
- A. Laforgia and S. Sismondi (1988). *Monotonicity results and inequalities for the gamma and error functions*. J. Comput. Appl. Math. **23**(1), pp. 25–33.
- J. C. Lagarias, V. S. Miller, and A. M. Odlyzko (1985). *Computing  $\pi(x)$ : The Meissel-Lehmer method*. Math. Comp. **44**(170), pp. 537–560.
- J. Lagrange (1770). *Démonstration d'un Théorème d'Arithmétique*. Nouveau Mém. Acad. Roy. Sci. Berlin, pp. 123–133. Reprinted in Oeuvres, Vol. 3, pp. 189–201, Gauthier-Villars, Paris, 1867.

- V. Laň (1994). *The two-point connection problem for differential equations of the Heun class*. Teoret. Mat. Fiz. **101**(3), pp. 360–368. In Russian. English translation: Theoret. and Math. Phys. **101**(1994), no. 3, pp. 1413–1418 (1995).
- H. Lamb (1932). *Hydrodynamics* (6th ed.). Cambridge: Cambridge University Press. Reprinted in 1993.
- C. G. Lambe (1952). *Lamé-Wangerin functions*. Quart. J. Math., Oxford Ser. (2) **3**, pp. 107–114.
- C. G. Lambe and D. R. Ward (1934). *Some differential equations and associated integral equations*. Quart. J. Math. (Oxford) **5**, pp. 81–97.
- E. Landau (1953). *Handbuch der Lehre von der Verteilung der Primzahlen. 2 Bände*. New York: Chelsea Publishing Co. 2nd edition, with an appendix by Paul T. Bateman.
- L. D. Landau and E. M. Lifshitz (1962). *The Classical Theory of Fields*. Oxford: Pergamon Press. Revised second edition. Course of Theoretical Physics, Vol. 2. Translated from the Russian by Morton Hamermesh.
- L. D. Landau and E. M. Lifshitz (1965). *Quantum Mechanics: Non-relativistic Theory*. Oxford: Pergamon Press Ltd. Revised second edition. Course of Theoretical Physics, Vol. 3. Translated from the Russian by J. B. Sykes and J. S. Bell.
- L. D. Landau and E. M. Lifshitz (1987). *Fluid Mechanics* (2nd ed.). London: Pergamon Press. Course of Theoretical Physics, Vol. 6. Translated from the Russian by J. B. Sykes and W. H. Reid.
- L. J. Landau (1999). *Ratios of Bessel functions and roots of  $\alpha J_\nu(x) + xJ'_\nu(x) = 0$* . J. Math. Anal. Appl. **240**(1), pp. 174–204.
- L. J. Landau (2000). *Bessel functions: Monotonicity and bounds*. J. London Math. Soc. (2) **61**(1), pp. 197–215.
- S. Lang (1987). *Elliptic Functions* (2nd ed.), Volume 112 of *Graduate Texts in Mathematics*. New York: Springer-Verlag. With an appendix by J. Tate.
- R. E. Langer (1934). *The solutions of the Mathieu equation with a complex variable and at least one parameter large*. Trans. Amer. Math. Soc. **36**(3), pp. 637–695.
- B. J. Laurenzi (1993). *Moment integrals of powers of Airy functions*. Z. angew. Math. Phys. **44**(5), pp. 891–908.
- H. A. Lauwerier (1974). *Asymptotic Analysis*. Number 54 in Mathematical Centre Tracts. Amsterdam: Mathematisch Centrum.
- D. F. Lawden (1989). *Elliptic Functions and Applications*, Volume 80 of *Applied Mathematical Sciences*. New York: Springer-Verlag.
- W. Lay, K. Bay, and S. Yu. Slavyanov (1998). *Asymptotic and numeric study of eigenvalues of the double confluent Heun equation*. J. Phys. A **31**(42), pp. 8521–8531.
- W. Lay and S. Yu. Slavyanov (1998). *The central two-point connection problem for the Heun class of ODEs*. J. Phys. A **31**(18), pp. 4249–4261.
- W. Lay and S. Yu. Slavyanov (1999). *Heun's equation with nearby singularities*. Proc. Roy. Soc. London Ser. A **455**, pp. 4347–4361.
- D. Le (1985). *An efficient derivative-free method for solving nonlinear equations*. ACM Trans. Math. Software **11**(3), pp. 250–262. Corrigendum, *ibid.* **15**(3) (1989), 287.
- E. W. Leaver (1986). *Solutions to a generalized spheroidal wave equation: Teukolsky's equations in general relativity, and the two-center problem in molecular quantum mechanics*. J. Math. Phys. **27**(5), pp. 1238–1265.
- A. V. Lebedev and R. M. Fedorova (1960). *A Guide to Mathematical Tables*. Amsterdam-New York-Oxford: Pergamon Press. See also Burunova (1960).
- N. N. Lebedev (1965). *Special Functions and Their Applications*. Englewood Cliffs, N.J.: Prentice-Hall Inc. R. A. Silverman, translator and editor; reprinted by Dover, New York, 1972.
- N. N. Lebedev, I. P. Skalskaya, and Y. S. Uflyand (1965). *Problems of Mathematical Physics*. Revised, enlarged and corrected English edition; translated and edited by Richard A. Silverman. With a supplement by Edward L. Reiss. Englewood Cliffs, NJ: Prentice-Hall Inc. Republished as *Worked Problems in Applied Mathematics* by Dover Publications, New York, 1979.
- J. LeCaine (1945). *A table of integrals involving the functions  $E_n(x)$* . National Research Council of Canada, Division of Atomic Energy, Document no. **MT-131** (NRC 1553).
- D. K. Lee (1990). *Application of theta functions for numerical evaluation of complete elliptic integrals of the first and second kinds*. Comput. Phys. Comm. **60**(3), pp. 319–327.
- S.-Y. Lee (1980). *The inhomogeneous Airy functions,  $Gi(z)$  and  $Hi(z)$* . J. Chem. Phys. **72**(1), pp. 332–336.
- D. J. Leeming (1977). *An asymptotic estimate for the Bernoulli and Euler numbers*. Canad. Math. Bull. **20**(1), pp. 109–111.
- D. J. Leeming (1989). *The real zeros of the Bernoulli polynomials*. J. Approx. Theory **58**(2), pp. 124–150.
- A. M. Legendre (1808). *Essai sur la Théorie des Nombres* (2nd ed.). Paris: Courcier.
- A. M. Legendre (1825–1832). *Traité des fonctions elliptiques et des intégrales Eulériennes*. Paris: Huzard-Courcier. vol.1, 1825; vol.2, 1826; three supplements, 1828–1832.
- D. R. Lehman and J. S. O'Connell (1973). *Graphical Recoupling of Angular Momenta*. Technical report, National Bureau of Standards, Washington, D.C. Monograph 136.

- D. R. Lehman, W. C. Parke, and L. C. Maximon (1981). *Numerical evaluation of integrals containing a spherical Bessel function by product integration*. J. Math. Phys. **22**(7), pp. 1399–1413.
- D. H. Lehmer (1940). *On the maxima and minima of Bernoulli polynomials*. Amer. Math. Monthly **47**(8), pp. 533–538.
- D. H. Lehmer (1941). *Guide to Tables in the Theory of Numbers*. Bulletin of the National Research Council, No. 105. Washington, D. C.: National Research Council. Reprinted in 1961.
- D. H. Lehmer (1943). *Ramanujan's function  $\tau(n)$* . Duke Math. J. **10**(3), pp. 483–492.
- D. H. Lehmer (1947). *The vanishing of Ramanujan's function  $\tau(n)$* . Duke Math. J. **14**(2), pp. 429–433.
- D. N. Lehmer (1914). *List of Prime Numbers from 1 to 10,006,721*. Publ. No. 165. Washington, DC: Carnegie Institution of Washington.
- J. Lehner (1941). *A partition function connected with the modulus five*. Duke Math. J. **8**(4), pp. 631–655.
- O. Lehto and K. I. Virtanen (1973). *Quasiconformal Mappings in the Plane* (2nd ed.). New York: Springer-Verlag. Translated from the German by K. W. Lucas, Die Grundlehren der mathematischen Wissenschaften, Band 126.
- A. Leitner and J. Meixner (1960). *Eine Verallgemeinerung der Sphäroidfunktionen*. Arch. Math. **11**, pp. 29–39.
- D. A. Leonard (1982). *Orthogonal polynomials, duality and association schemes*. SIAM J. Math. Anal. **13**(4), pp. 656–663.
- N. L. Lepe (1985). *Functions on a parabolic cylinder with a negative integer index*. Differ. Uravn. **21**(11), pp. 2001–2003, 2024. In Russian.
- J. Lepowsky and S. Milne (1978). *Lie algebraic approaches to classical partition identities*. Adv. in Math. **29**(1), pp. 15–59.
- J. Lepowsky and R. L. Wilson (1982). *A Lie theoretic interpretation and proof of the Rogers-Ramanujan identities*. Adv. in Math. **45**(1), pp. 21–72.
- M. Lerch (1887). *Note sur la fonction  $\mathfrak{R}(w, x, s) = \sum_{k=0}^{\infty} \frac{e^{2k\pi ix}}{(w+k)^s}$* . Acta Math. **11**(1-4), pp. 19–24.
- M. Lerch (1903). *Zur Theorie der Gaußschen Summen*. Math. Ann. **57**(4), pp. 554–567.
- J. Letessier (1995). *Co-recursive associated Jacobi polynomials*. J. Comput. Appl. Math. **57**(1-2), pp. 203–213.
- J. Letessier, G. Valent, and J. Wimp (1994). *Some Differential Equations Satisfied by Hypergeometric Functions*. In *Approximation and Computation (West Lafayette, IN, 1993)*, Volume 119 of *Internat. Ser. Numer. Math.*, pp. 371–381. Boston, MA: Birkhäuser Boston.
- C. Leubner and H. Ritsch (1986). *A note on the uniform asymptotic expansion of integrals with coalescing endpoint and saddle points*. J. Phys. A **19**(3), pp. 329–335.
- K. V. Leung and S. S. Ghaderpanah (1979). *An application of the finite element approximation method to find the complex zeros of the modified Bessel function  $K_n(z)$* . Math. Comp. **33**(148), pp. 1299–1306.
- L. Levey and L. B. Felsen (1969). *On incomplete Airy functions and their application to diffraction problems*. Radio Sci. **4**(10), pp. 959–969.
- E. Levin and D. S. Lubinsky (2001). *Orthogonal Polynomials for Exponential Weights*. CMS Books in Mathematics/Ouvrages de Mathématiques de la SMC, 4. New York: Springer-Verlag.
- H. Levine and J. Schwinger (1948). *On the theory of diffraction by an aperture in an infinite plane screen. I*. Phys. Rev. **74**(8), pp. 958–974.
- N. Levinson (1974). *More than one third of zeros of Riemann's zeta-function are on  $\sigma = \frac{1}{2}$* . Advances in Math. **13**(4), pp. 383–436.
- N. Levinson and R. M. Redheffer (1970). *Complex Variables*. San Francisco, CA: Holden-Day Inc.
- J. S. Lew (1994). *On the Darling-Mandelbrot probability density and the zeros of some incomplete gamma functions*. Constr. Approx. **10**(1), pp. 15–30.
- S. Lewanowicz (1985). *Recurrence relations for hypergeometric functions of unit argument*. Math. Comp. **45**(172), pp. 521–535.
- S. Lewanowicz (1987). *Corrigenda: "Recurrence relations for hypergeometric functions of unit argument" [Math. Comp. **45** (1985), no. 172, 521–535; MR 86m:33004]*. Math. Comp. **48**(178), p. 853.
- S. Lewanowicz (1991). *Evaluation of Bessel function integrals with algebraic singularities*. J. Comput. Appl. Math. **37**(1-3), pp. 101–112.
- L. Lewin (1981). *Polylogarithms and Associated Functions*. New York: North-Holland Publishing Co. With a foreword by A. J. Van der Poorten.
- J. T. Lewis and M. E. Muldoon (1977). *Monotonicity and convexity properties of zeros of Bessel functions*. SIAM J. Math. Anal. **8**(1), pp. 171–178.
- L.-W. Li, T. S. Yeo, P. S. Kooi, and M. S. Leong (1998). *Microwave specific attenuation by oblate spheroidal raindrops: An exact analysis of TCS's in terms of spheroidal wave functions*. J. Electromagn. Waves Appl. **12**(6), pp. 709–711.

- X. Li, X. Shi, and J. Zhang (1991). *Generalized Riemann  $\zeta$ -function regularization and Casimir energy for a piecewise uniform string*. Phys. Rev. D **44**(2), pp. 560–562.
- X. Li and R. Wong (1994). *Error bounds for asymptotic expansions of Laplace convolutions*. SIAM J. Math. Anal. **25**(6), pp. 1537–1553.
- X. Li and R. Wong (2000). *A uniform asymptotic expansion for Krawtchouk polynomials*. J. Approx. Theory **106**(1), pp. 155–184.
- X. Li and R. Wong (2001). *On the asymptotics of the Meixner-Pollaczek polynomials and their zeros*. Constr. Approx. **17**(1), pp. 59–90.
- Y. A. Li and P. J. Olver (2000). *Well-posedness and blow-up solutions for an integrable nonlinearly dispersive model wave equation*. J. Differential Equations **162**(1), pp. 27–63.
- Y. T. Li and R. Wong (2008). *Integral and series representations of the Dirac delta function*. Commun. Pure Appl. Anal. **7**(2), pp. 229–247.
- E. M. Lifshitz and L. P. Pitaevskiĭ (1980). *Statistical Physics, Part 2: Theory of the Condensed State*. Oxford: Pergamon Press. Course of Theoretical Physics, Vol. 9. Translated from the Russian by J. B. Sykes and M. J. Kearsley.
- M. J. Lighthill (1958). *An Introduction to Fourier Analysis and Generalised Functions*. Cambridge Monographs on Mechanics and Applied Mathematics. New York: Cambridge University Press.
- E. Lindelöf (1905). *Le Calcul des Résidus et ses Applications à la Théorie des Fonctions*. Paris: Gauthier-Villars. Reprinted by Éditions Jacques Gabay, Sceaux, 1989.
- P. Linz and T. E. Kropp (1973). *A note on the computation of integrals involving products of trigonometric and Bessel functions*. Math. Comp. **27**(124), pp. 871–872.
- J. E. Littlewood (1914). *Sur la distribution des nombres premiers*. Comptes Rendus de l'Académie des Sciences, Paris **158**, pp. 1869–1872.
- I. M. Longman (1956). *Note on a method for computing infinite integrals of oscillatory functions*. Proc. Cambridge Philos. Soc. **52**(4), pp. 764–768.
- J. L. López (1999). *Asymptotic expansions of the Whittaker functions for large order parameter*. Methods Appl. Anal. **6**(2), pp. 249–256. Dedicated to Richard A. Askey on the occasion of his 65th birthday, Part II.
- J. L. López (2000). *Asymptotic expansions of symmetric standard elliptic integrals*. SIAM J. Math. Anal. **31**(4), pp. 754–775.
- J. L. López (2001). *Uniform asymptotic expansions of symmetric elliptic integrals*. Constr. Approx. **17**(4), pp. 535–559.
- J. L. López and N. M. Temme (1999a). *Approximation of orthogonal polynomials in terms of Hermite polynomials*. Methods Appl. Anal. **6**(2), pp. 131–146.
- J. L. López and N. M. Temme (1999b). *Hermite polynomials in asymptotic representations of generalized Bernoulli, Euler, Bessel, and Buchholz polynomials*. J. Math. Anal. Appl. **239**(2), pp. 457–477.
- L. Lorch (1984). *Inequalities for ultraspherical polynomials and the gamma function*. J. Approx. Theory **40**(2), pp. 115–120.
- L. Lorch (1990). *Monotonicity in terms of order of the zeros of the derivatives of Bessel functions*. Proc. Amer. Math. Soc. **108**(2), pp. 387–389.
- L. Lorch (1992). *On Bessel functions of equal order and argument*. Rend. Sem. Mat. Univ. Politec. Torino **50**(2), pp. 209–216 (1993).
- L. Lorch (1993). *Some inequalities for the first positive zeros of Bessel functions*. SIAM J. Math. Anal. **24**(3), pp. 814–823.
- L. Lorch (1995). *The zeros of the third derivative of Bessel functions of order less than one*. Methods Appl. Anal. **2**(2), pp. 147–159.
- L. Lorch (2002). *Comparison of a pair of upper bounds for a ratio of gamma functions*. Math. Balkanica (N.S.) **16**(1–4), pp. 195–202.
- L. Lorch, M. E. Muldoon, and P. Szego (1970). *Higher monotonicity properties of certain Sturm-Liouville functions. III*. Canad. J. Math. **22**, pp. 1238–1265.
- L. Lorch, M. E. Muldoon, and P. Szego (1972). *Higher monotonicity properties of certain Sturm-Liouville functions. IV*. Canad. J. Math. **24**, pp. 349–368.
- L. Lorch and P. Szego (1963). *Higher monotonicity properties of certain Sturm-Liouville functions*. Acta Math. **109**, pp. 55–73.
- L. Lorch and P. Szego (1964). *Monotonicity of the differences of zeros of Bessel functions as a function of order*. Proc. Amer. Math. Soc. **15**(1), pp. 91–96.
- L. Lorch and P. Szego (1990). *On the points of inflection of Bessel functions of positive order. I*. Canad. J. Math. **42**(5), pp. 933–948. Corrigenda see same journal, **42**(6), p. 1132.
- L. Lorch and P. Szego (1995). *Monotonicity of the zeros of the third derivative of Bessel functions*. Methods Appl. Anal. **2**(1), pp. 103–111.
- Lord Kelvin (1891). *Popular Lectures and Addresses*, Volume 3, pp. 481–488. London: Macmillan.
- Lord Kelvin (1905). *Deep water ship-waves*. Phil. Mag. **9**, pp. 733–757.



- Lord Rayleigh (1945). *The Theory of Sound* (2nd ed.). New York: Dover Publications. Photographic reproduction of the 1929 reprint of the edition of 1894–1896, published by Macmillan, London.
- H. A. Lorentz, A. Einstein, H. Minkowski, and H. Weyl (1923). *The Principle of Relativity: A Collection of Original Memoirs on the Special and General Theory of Relativity*. London: Methuen and Co., Ltd. Translated from Das Relativitätsprinzip by W. Perrett and G. B. Jeffery. Reprinted by Dover Publications Inc., New York, 1952.
- L. Lorentzen and H. Waadeland (1992). *Continued Fractions with Applications*. Studies in Computational Mathematics. Amsterdam: North-Holland Publishing Co.
- J. D. Louck (1958). *New recursion relation for the Clebsch-Gordan coefficients*. Phys. Rev. (2) **110**(4), pp. 815–816.
- L. Lovász, L. Pyber, D. J. A. Welsh, and G. M. Ziegler (1995). *Combinatorics in Pure Mathematics*. In R. L. Graham, M. Grötschel, and L. Lovász (Eds.), *Handbook of Combinatorics, Vol. 2*, pp. 2039–2082. Amsterdam: Elsevier.
- E. R. Love (1970). *Changing the order of integration*. J. Austral. Math. Soc. **11**, pp. 421–432. An addendum appears in Vol. 14, pp. 383–384, of the same journal.
- E. R. Love (1972a). *Addendum to: “Changing the order of integration”*. J. Austral. Math. Soc. **14**, pp. 383–384.
- E. R. Love (1972b). *Two index laws for fractional integrals and derivatives*. J. Austral. Math. Soc. **14**, pp. 385–410.
- A. N. Lowan and W. Horenstein (1942). *On the function  $H(m, a, x) = \exp(-ix)F(m+1-ia, 2m+2; 2ix)$* . J. Math. Phys. Mass. Inst. Tech. **21**, pp. 264–283.
- T. A. Lowdon (1970). *Integral representation of the Hankel function in terms of parabolic cylinder functions*. Quart. J. Mech. Appl. Math. **23**(3), pp. 315–327.
- D. W. Lozier (1980). *Numerical Solution of Linear Difference Equations*. NBSIR 80-1976, National Bureau of Standards, Gaithersburg, MD 20899. (Available from National Technical Information Service, Springfield, VA 22161.)
- D. W. Lozier (1993). *An underflow-induced graphics failure solved by SLI arithmetic*. In E. E. Swartzlander, Jr., M. J. Irwin, and G. A. Jullien (Eds.), *IEEE Symposium on Computer Arithmetic*, Washington, D.C., pp. 10–17. IEEE Computer Society Press.
- D. W. Lozier and F. W. J. Olver (1993). *Airy and Bessel Functions by Parallel Integration of ODEs*. In R. F. Sincovec, D. E. Keyes, M. R. Leuze, L. R. Petzold, and D. A. Reed (Eds.), *Proceedings of the Sixth SIAM Conference on Parallel Processing for Scientific Computing*, Philadelphia, PA, pp. 530–538. Society for Industrial and Applied Mathematics (SIAM).
- D. W. Lozier and F. W. J. Olver (1994). *Numerical Evaluation of Special Functions*. In *Mathematics of Computation 1943–1993: A Half-Century of Computational Mathematics (Vancouver, BC, 1993)*, Volume 48 of *Proc. Sympos. Appl. Math.*, pp. 79–125. Providence, RI: Amer. Math. Soc. An updated version exists online.
- É. Lucas (1891). *Théorie des nombres. Tome I: Le calcul des nombres entiers, le calcul des nombres rationnels, la divisibilité arithmétique*. Paris: Gauthier-Villars.
- S. K. Lucas (1995). *Evaluating infinite integrals involving products of Bessel functions of arbitrary order*. J. Comput. Appl. Math. **64**(3), pp. 269–282.
- S. K. Lucas and H. A. Stone (1995). *Evaluating infinite integrals involving Bessel functions of arbitrary order*. J. Comput. Appl. Math. **64**(3), pp. 217–231.
- D. Ludwig (1966). *Uniform asymptotic expansions at a caustic*. Comm. Pure Appl. Math. **19**, pp. 215–250.
- N. A. Lukaševič (1965). *Elementary solutions of certain Painlevé equations*. Differ. Uravn. **1**(3), pp. 731–735. In Russian. English translation: *Differential Equations* **1**(3), pp. 561–564.
- N. A. Lukaševič (1967a). *Theory of the fourth Painlevé equation*. Differ. Uravn. **3**(5), pp. 771–780. In Russian. English translation: *Differential Equations* **3**(5), pp. 395–399.
- N. A. Lukaševič (1967b). *On the theory of Painlevé’s third equation*. Differ. Uravn. **3**(11), pp. 1913–1923. In Russian. English translation: *Differential Equations* **3**(11), pp. 994–999.
- N. A. Lukaševič (1968). *Solutions of the fifth Painlevé equation*. Differ. Uravn. **4**(8), pp. 1413–1420. In Russian. English translation: *Differential Equations* **4**(8), pp. 732–735.
- N. A. Lukaševič (1971). *The second Painlevé equation*. Differ. Uravn. **7**(6), pp. 1124–1125. In Russian. English translation: *Differential Equations* **7**(6), pp. 853–854.
- N. A. Lukaševič and A. I. Yablonskiĭ (1967). *On a set of solutions of the sixth Painlevé equation*. Differ. Uravn. **3**(3), pp. 520–523. In Russian. English translation: *Differential Equations* **3**(3), pp. 264–266.
- Y. L. Luke (1959). *Expansion of the confluent hypergeometric function in series of Bessel functions*. Math. Tables Aids Comput. **13**(68), pp. 261–271.
- Y. L. Luke (1962). *Integrals of Bessel Functions*. New York: McGraw-Hill Book Co., Inc.
- Y. L. Luke (1968). *Approximations for elliptic integrals*. Math. Comp. **22**(103), pp. 627–634.
- Y. L. Luke (1969a). *The Special Functions and their Approximations, Vol. 1*. New York: Academic Press.
- Y. L. Luke (1969b). *The Special Functions and their Approximations, Vol. 2*. New York: Academic Press.

- Y. L. Luke (1970). *Further approximations for elliptic integrals*. Math. Comp. **24**(109), pp. 191–198.
- Y. L. Luke (1971a). *Miniaturized tables of Bessel functions*. Math. Comp. **25**(114), pp. 323–330.
- Y. L. Luke (1971b). *Miniaturized tables of Bessel functions. II*. Math. Comp. **25**(116), pp. 789–795 and D14–E13. For Corrigendum see same journal **26**(120), pp. A1–A7.
- Y. L. Luke (1972). *Miniaturized tables of Bessel functions. III*. Math. Comp. **26**(117), pp. 237–240 and A14–B5.
- Y. L. Luke (1975). *Mathematical Functions and their Approximations*. New York: Academic Press Inc.
- Y. L. Luke (1977a). *Algorithms for rational approximations for a confluent hypergeometric function*. Utilitas Math. **11**, pp. 123–151.
- Y. L. Luke (1977b). *Algorithms for the Computation of Mathematical Functions*. New York: Academic Press.
- Y. L. Luke and J. Wimp (1963). *Jacobi polynomial expansions of a generalized hypergeometric function over a semi-infinite ray*. Math. Comp. **17**(84), pp. 395–404.
- J. Lund (1985). *Bessel transforms and rational extrapolation*. Numer. Math. **47**(1), pp. 1–14.
- J. H. Luscombe and M. Luban (1998). *Simplified recursive algorithm for Wigner  $3j$  and  $6j$  symbols*. Phys. Rev. E **57**(6), pp. 7274–7277.
- W. Luther (1995). *Highly accurate tables for elementary functions*. BIT **35**(3), pp. 352–360.
- R. J. Lyman and W. W. Edmonson (2001). *Linear prediction of bandlimited processes with flat spectral densities*. IEEE Trans. Signal Process. **49**(7), pp. 1564–1569.
- J. N. Lyness (1971). *Adjusted forms of the Fourier coefficient asymptotic expansion and applications in numerical quadrature*. Math. Comp. **25**(113), pp. 87–104.
- J. N. Lyness (1985). *Integrating some infinite oscillating tails*. J. Comput. Appl. Math. **12/13**, pp. 109–117.
- H. Maass (1971). *Siegel's modular forms and Dirichlet series*, Volume 216 of *Lecture Notes in Mathematics*. Berlin: Springer-Verlag.
- D. A. MacDonald (1989). *The roots of  $J_0(z) - iJ_1(z) = 0$* . Quart. Appl. Math. **47**(2), pp. 375–378.
- D. A. MacDonald (1997). *On the computation of zeroes of  $J_n(z) - iJ_{n+1}(z) = 0$* . Quart. Appl. Math. **55**(4), pp. 623–633.
- I. D. Macdonald (1968). *The Theory of Groups*. Oxford: Clarendon Press. Reprinted in 1988 by Krieger Publishing Co., Malabar, FL.
- I. G. Macdonald (1972). *Affine root systems and Dedekind's  $\eta$ -function*. Invent. Math. **15**(2), pp. 91–143.
- I. G. Macdonald (1982). *Some conjectures for root systems*. SIAM J. Math. Anal. **13**(6), pp. 988–1007.
- I. G. Macdonald (1990). *Hypergeometric Functions*. Unpublished Lecture Notes, University of London. An online version exists.
- I. G. Macdonald (1995). *Symmetric Functions and Hall Polynomials* (2nd ed.). New York-Oxford: The Clarendon Press, Oxford University Press. With contributions by A. Zelevinsky. Paperback version published by Oxford University Press, July 1999.
- I. G. Macdonald (1998). *Symmetric Functions and Orthogonal Polynomials*, Volume 12 of *University Lecture Series*. Providence, RI: American Mathematical Society.
- I. G. Macdonald (2000). *Orthogonal polynomials associated with root systems*. Sémin. Lothar. Combin. **45**, pp. Art. B45a, 40 pp. (electronic).
- I. G. Macdonald (2003). *Affine Hecke Algebras and Orthogonal Polynomials*, Volume 157 of *Cambridge Tracts in Mathematics*. Cambridge: Cambridge University Press.
- R. L. Mace and M. A. Hellberg (1995). *A dispersion function for plasmas containing superthermal particles*. Physics of Plasmas **2**(6), pp. 2098–2109.
- N. W. Macfadyen and P. Winternitz (1971). *Crossing symmetric expansions of physical scattering amplitudes: The  $O(2, 1)$  group and Lamé functions*. J. Mathematical Phys. **12**, pp. 281–293.
- A. J. MacLeod (1993). *Chebyshev expansions for modified Struve and related functions*. Math. Comp. **60**(202), pp. 735–747.
- A. J. MacLeod (1994). *Computation of inhomogeneous Airy functions*. J. Comput. Appl. Math. **53**(1), pp. 109–116.
- A. J. MacLeod (1996). *Rational approximations, software and test methods for sine and cosine integrals*. Numer. Algorithms **12**(3-4), pp. 259–272. Includes Fortran code, maximum accuracy 20S.
- A. J. MacLeod (2002a). *Asymptotic expansions for the zeros of certain special functions*. J. Comput. Appl. Math. **145**(2), pp. 261–267.
- A. J. MacLeod (2002b). *The efficient computation of some generalised exponential integrals*. J. Comput. Appl. Math. **148**(2), pp. 363–374.
- T. M. MacRobert (1967). *Spherical Harmonics. An Elementary Treatise on Harmonic Functions with Applications* (3rd ed.), Volume 98 of *International Series of Monographs in Pure and Applied Mathematics*. Oxford: Pergamon Press.
- A. P. Magnus (1995). *Painlevé-type differential equations for the recurrence coefficients of semi-classical orthogonal polynomials*. J. Comput. Appl. Math. **57**(1-2), pp. 215–237.

- W. Magnus (1941). *Zur Theorie des zylindrisch-parabolischen Spiegels*. Z. Physik **118**, pp. 343–356.
- W. Magnus, F. Oberhettinger, and R. P. Soni (1966). *Formulas and Theorems for the Special Functions of Mathematical Physics* (3rd ed.). New York-Berlin: Springer-Verlag. Table errata: Math. Comp. v. 23 (1969), p. 471, v. 24 (1970), pp. 240 and 505, v. 25 (1971), no. 113, p. 201, v. 29 (1975), no. 130, p. 672, v. 30 (1976), no. 135, pp. 677–678, v. 32 (1978), no. 141, pp. 319–320, v. 36 (1981), no. 153, pp. 315–317, and v. 41 (1983), no. 164, pp. 775–776.
- W. Magnus and S. Winkler (1966). *Hill's Equation*. Interscience Tracts in Pure and Applied Mathematics, No. 20. New York-London-Sydney: Interscience Publishers John Wiley & Sons. Reprinted by Dover Publications, Inc., New York, 1979.
- K. Mahler (1930). *Über die Nullstellen der unvollständigen Gammafunktionen*. Rend. del Circ. Matem. Palermo **54**, pp. 1–41.
- R. S. Maier (2005). *On reducing the Heun equation to the hypergeometric equation*. J. Differential Equations **213**(1), pp. 171–203.
- R. S. Maier (2007). *The 192 solutions of the Heun equation*. Math. Comp. **76**(258), pp. 811–843.
- H. Majima, K. Matsumoto, and N. Takayama (2000). *Quadratic relations for confluent hypergeometric functions*. Tohoku Math. J. (2) **52**(4), pp. 489–513.
- S. Makinouchi (1966). *Zeros of Bessel functions  $J_\nu(x)$  and  $Y_\nu(x)$  accurate to twenty-nine significant digits*. Technology Reports of the Osaka University **16**(685), pp. 1–44.
- Yu. I. Manin (1998). *Sixth Painlevé Equation, Universal Elliptic Curve, and Mirror of  $\mathbf{P}^2$* . In A. Khovanskii, A. Varchenko, and V. Vassiliev (Eds.), *Geometry of Differential Equations*, Volume 186 of *Amer. Math. Soc. Transl. Ser. 2*, pp. 131–151. Providence, RI: Amer. Math. Soc.
- E. L. Mansfield and H. N. Webster (1998). *On one-parameter families of Painlevé III*. Stud. Appl. Math. **101**(3), pp. 321–341.
- F. Marcellán, M. Alfaro, and M. L. Rezola (1993). *Orthogonal polynomials on Sobolev spaces: Old and new directions*. J. Comput. Appl. Math. **48**(1-2), pp. 113–131.
- M. Marden (1966). *Geometry of Polynomials* (2nd ed.). Providence, RI: American Mathematical Society.
- O. I. Marichev (1983). *Handbook of Integral Transforms of Higher Transcendental Functions: Theory and Algorithmic Tables*. Chichester/New York: Ellis Horwood Ltd./John Wiley & Sons, Inc. Edited by F. D. Gakhov, Translated from the Russian by L. W. Longdon.
- O. I. Marichev (1984). *On the Representation of Meijer's G-Function in the Vicinity of Singular Unity*. In *Complex Analysis and Applications '81 (Varna, 1981)*, pp. 383–398. Sofia: Publ. House Bulgar. Acad. Sci.
- S. M. Markov (1981). *On the interval computation of elementary functions*. C. R. Acad. Bulgare Sci. **34**(3), pp. 319–322.
- A. I. Markushevich (1983). *The Theory of Analytic Functions: A Brief Course*. Moscow: "Mir". Translated from the Russian by Eugene Yankovsky.
- A. I. Markushevich (1985). *Theory of Functions of a Complex Variable. Vols. I, II, III*. New York: Chelsea Publishing Co. Translated and edited by Richard A. Silverman.
- A. I. Markushevich (1992). *Introduction to the Classical Theory of Abelian Functions*. Providence, RI: American Mathematical Society. Translated from the 1979 Russian original by G. Blüher.
- P. Maroni (1995). *An integral representation for the Bessel form*. J. Comput. Appl. Math. **57**(1-2), pp. 251–260.
- J. E. Marsden and A. J. Tromba (1996). *Vector Calculus* (4th ed.). New York: W. H. Freeman & Company. Fifth edition printed in 2003.
- P. L. Marston (1992). A. D. Pierce and R. N. Thurston (Eds.). *Geometrical and Catastrophe Optics Methods in Scattering*, Volume 21, pp. 1–234. New York: Academic Press.
- P. L. Marston (1999). *Catastrophe optics of spheroidal drops and generalized rainbows*. J. Quantit. Spec. and Rad. Trans. **63**, pp. 341–351.
- B. Martić (1978). *Note sur certaines inégalités d'intégrales*. Akad. Nauka Umjet. Bosne Hercegov. Rad. Odjelj. Prirod. Mat. Nauka **61**(17), pp. 165–168.
- P. Martín, R. Pérez, and A. L. Guerrero (1992). *Two-point quasi-fractional approximations to the Airy function  $\text{Ai}(x)$* . J. Comput. Phys. **99**(2), pp. 337–340. There is an error in Eq. (5): the second term in parentheses needs to be multiplied by  $x$ .
- J. Martinek, H. P. Thielman, and E. C. Huebschman (1966). *On the zeros of cross-product Bessel functions*. J. Math. Mech. **16**, pp. 447–452.
- J. C. Mason and D. C. Handscomb (2003). *Chebyshev Polynomials*. Boca Raton, FL: Chapman & Hall/CRC.
- D. R. Masson (1991). *Associated Wilson polynomials*. Constr. Approx. **7**(4), pp. 521–534.
- T. Masuda (2003). *On a class of algebraic solutions to the Painlevé VI equation, its determinant formula and coalescence cascade*. Funkcial. Ekvac. **46**(1), pp. 121–171.
- T. Masuda (2004). *Classical transcendental solutions of the Painlevé equations and their degeneration*. Tohoku Math. J. (2) **56**(4), pp. 467–490.

- T. Masuda, Y. Ohta, and K. Kajiwara (2002). *A determinant formula for a class of rational solutions of Painlevé V equation*. Nagoya Math. J. **168**, pp. 1–25.
- A. M. Mathai (1993). *A Handbook of Generalized Special Functions for Statistical and Physical Sciences*. Oxford Science Publications. New York: The Clarendon Press Oxford University Press.
- F. Matta and A. Reichel (1971). *Uniform computation of the error function and other related functions*. Math. Comp. **25**(114), pp. 339–344.
- D. W. Matula and P. Kornerup (1980). *Foundations of Finite Precision Rational Arithmetic*. In G. Alefeld and R. D. Grigorieff (Eds.), *Fundamentals of Numerical Computation (Computer-oriented Numerical Analysis)*, Volume 2 of *Comput. Suppl.*, Vienna, pp. 85–111. Springer.
- L. C. Maximon (1955). *On the evaluation of indefinite integrals involving the special functions: Application of method*. Quart. Appl. Math. **13**, pp. 84–93.
- L. C. Maximon (1991). *On the evaluation of the integral over the product of two spherical Bessel functions*. J. Math. Phys. **32**(3), pp. 642–648.
- L. C. Maximon (2003). *The dilogarithm function for complex argument*. Proc. Roy. Soc. London Ser. A **459**, pp. 2807–2819.
- M. Mazzocco (2001a). *Rational solutions of the Painlevé VI equation*. J. Phys. A **34**(11), pp. 2281–2294.
- M. Mazzocco (2001b). *Picard and Chazy solutions to the Painlevé VI equation*. Math. Ann. **321**(1), pp. 157–195.
- R. C. McCann (1977). *Inequalities for the zeros of Bessel functions*. SIAM J. Math. Anal. **8**(1), pp. 166–170.
- J. P. McClure and R. Wong (1978). *Explicit error terms for asymptotic expansions of Stieltjes transforms*. J. Inst. Math. Appl. **22**(2), pp. 129–145.
- J. P. McClure and R. Wong (1979). *Exact remainders for asymptotic expansions of fractional integrals*. J. Inst. Math. Appl. **24**(2), pp. 139–147.
- J. P. McClure and R. Wong (1987). *Asymptotic expansion of a multiple integral*. SIAM J. Math. Anal. **18**(6), pp. 1630–1637.
- B. M. McCoy (1992). *Spin Systems, Statistical Mechanics and Painlevé Functions*. In D. Levi and P. Winternitz (Eds.), *Painlevé Transcendents: Their Asymptotics and Physical Applications*, Volume 278 of *NATO Adv. Sci. Inst. Ser. B Phys.*, pp. 377–391. New York: Plenum. Proc. NATO Adv. Res. Workshop, Sainte-Adèle, Canada, 1990.
- B. M. McCoy, C. A. Tracy, and T. T. Wu (1977). *Painlevé functions of the third kind*. J. Mathematical Phys. **18**(5), pp. 1058–1092.
- F. A. McDonald and J. Nuttall (1969). *Complex-energy method for elastic e-H scattering above the ionization threshold*. Phys. Rev. Lett. **23**(7), pp. 361–363.
- J. N. McDonald and N. A. Weiss (1999). *A Course in Real Analysis*. San Diego, CA: Academic Press Inc.
- H. R. McFarland, III and D. St. P. Richards (2001). *Exact misclassification probabilities for plug-in normal quadratic discriminant functions. I. The equal-means case*. J. Multivariate Anal. **77**(1), pp. 21–53.
- H. R. McFarland, III and D. St. P. Richards (2002). *Exact misclassification probabilities for plug-in normal quadratic discriminant functions. II. The heterogeneous case*. J. Multivariate Anal. **82**(2), pp. 299–330.
- H. McKean and V. Moll (1999). *Elliptic Curves*. Cambridge: Cambridge University Press. Reprint with corrections of original edition, published in 1997 by Cambridge University Press.
- N. M. McLachlan and A. L. Meyers (1936). *The ster and stei functions*. Phil. Mag. Series 7 **21**(140), pp. 425–436.
- N. W. McLachlan (1934). *Loud Speakers: Theory, Performance, Testing and Design*. New York: Oxford University Press. Reprinted, with corrections, by Dover Publications Inc., 1960.
- N. W. McLachlan (1947). *Theory and Application of Mathieu Functions*. Oxford: Clarendon Press. Corrected republication by Dover Publications, Inc., New York, 1964.
- N. W. McLachlan (1961). *Bessel Functions for Engineers* (2nd ed.). Oxford: Clarendon Press. The first edition was published in 1934 by Clarendon Press. The second edition was published originally in 1955.
- J. McMahon (1894/95). *On the roots of the Bessel and certain related functions*. Ann. of Math. **9**(1-6), pp. 23–30.
- J. M. McNamee (2007). *Numerical Methods for Roots of Polynomials. Part I*, Volume 14 of *Studies in Computational Mathematics*. Amsterdam: Elsevier.
- F. Mechel (1966). *Calculation of the modified Bessel functions of the second kind with complex argument*. Math. Comp. **20**(95), pp. 407–412.
- V. Meden and K. Schönhammer (1992). *Spectral functions for the Tomonaga-Luttinger model*. Phys. Rev. B **46**(24), pp. 15753–15760.
- D. S. Meek and D. J. Walton (1992). *Clothoid spline transition spirals*. Math. Comp. **59**(199), pp. 117–133.
- R. Mehrem, J. T. Londergan, and M. H. Macfarlane (1991). *Analytic expressions for integrals of products of spherical Bessel functions*. J. Phys. A **24**(7), pp. 1435–1453.
- M. L. Mehta (2004). *Random Matrices* (3rd ed.), Volume 142 of *Pure and Applied Mathematics (Amsterdam)*. Amsterdam: Elsevier/Academic Press.

- C. S. Meijer (1946). *On the G-function. VII, VIII*. Nederl. Akad. Wetensch., Proc. **49**, pp. 1063–1072, 1165–1175 = Indagationes Math. 8, 661–670, 713–723 (1946).
- J. W. Meijer and N. H. G. Baken (1987). *The exponential integral distribution*. Statist. Probab. Lett. **5**(3), pp. 209–211.
- G. Meinardus (1967). *Approximation of Functions: Theory and Numerical Methods*, Volume 13 of *Springer Tracts in Natural Philosophy*. New York: Springer-Verlag. Expanded translation from the German edition. Translated by Larry L. Schumaker.
- P. N. Meisinger, T. R. Miller, and M. C. Ogilvie (2002). *Phenomenological equations of state for the quark-gluon plasma*. Phys. Rev. D **65**(3), pp. (034009–1)–(034009–10).
- J. Meixner (1944). *Die Laméschen Wellenfunktionen des Drehellipsoids*. Forschungsbericht no. 1952, ZWB. English translation: *Lamé wave functions of the ellipsoid of revolution* appeared as NACA Technical Memorandum No. 1224, 1949.
- J. Meixner (1951). *Klassifikation, Bezeichnung und Eigenschaften der Sphäroidfunktionen*. Math. Nachr. **5**, pp. 1–18.
- J. Meixner and F. W. Schäfke (1954). *Mathiesche Funktionen und Sphäroidfunktionen mit Anwendungen auf physikalische und technische Probleme*. Die Grundlehren der mathematischen Wissenschaften in Einzeldarstellungen mit besonderer Berücksichtigung der Anwendungsgebiete, Band LXXI. Berlin: Springer-Verlag.
- J. Meixner, F. W. Schäfke, and G. Wolf (1980). *Mathieu Functions and Spheroidal Functions and Their Mathematical Foundations: Further Studies*, Volume 837 of *Lecture Notes in Mathematics*. Berlin-New York: Springer-Verlag.
- A. J. Menezes, P. C. van Oorschot, and S. A. Vanstone (1997). *Handbook of Applied Cryptography*. Boca Raton, FL: CRC Press. With a foreword by Ronald L. Rivest.
- A. McD. Mercer (1992). *The zeros of  $az^2 J'_\nu(z) + bz J'_\nu(z) + c J_\nu(z)$  as functions of order*. Internat. J. Math. Math. Sci. **15**(2), pp. 319–322.
- X. Merrheim (1994). *The computation of elementary functions in radix  $2^p$* . Computing **53**(3-4), pp. 219–232. International Symposium on Scientific Computing, Computer Arithmetic and Validated Numerics (Vienna, 1993).
- A. Messiah (1961). *Quantum Mechanics. Vol. I*. Amsterdam: North-Holland Publishing Co. Translated from the French by G. M. Temmer.
- R. Metzler, J. Klafter, and J. Jortner (1999). *Hierarchies and logarithmic oscillations in the temporal relaxation patterns of proteins and other complex systems*. Proc. Nat. Acad. Sci. U. S. A. **96**(20), pp. 11085–11089.
- A. Michaeli (1996). *Asymptotic analysis of edge-excited currents on a convex face of a perfectly conducting wedge under overlapping penumbra region conditions*. IEEE Trans. Antennas and Propagation **44**(1), pp. 97–101.
- C. Micu and E. Papp (2005). *Applying q-Laguerre polynomials to the derivation of q-deformed energies of oscillator and Coulomb systems*. Romanian Reports in Physics **57**(1), pp. 25–34.
- M. Micu (1968). *Recursion relations for the 3-j symbols*. Nuclear Physics A **113**(1), pp. 215–220.
- P. Midy (1975). *An improved calculation of the general elliptic integral of the second kind in the neighbourhood of  $x = 0$* . Numer. Math. **25**(1), pp. 99–101.
- G. J. Miel (1981). *Evaluation of complex logarithms and related functions*. SIAM J. Numer. Anal. **18**(4), pp. 744–750.
- J. W. Miles (1975). *Asymptotic approximations for prolate spheroidal wave functions*. Studies in Appl. Math. **54**(4), pp. 315–349.
- J. W. Miles (1978). *On the second Painlevé transcendent*. Proc. Roy. Soc. London Ser. A **361**, pp. 277–291.
- J. W. Miles (1980). *The Second Painlevé Transcendent: A Nonlinear Airy Function*. In *Mechanics Today*, Volume 5, pp. 297–313. Oxford: Pergamon.
- M. S. Milgram (1985). *The generalized integro-exponential function*. Math. Comp. **44**(170), pp. 443–458.
- A. R. Miller (1997). *A class of generalized hypergeometric summations*. J. Comput. Appl. Math. **87**(1), pp. 79–85.
- A. R. Miller (2003). *On a Kummer-type transformation for the generalized hypergeometric function  ${}_2F_2$* . J. Comput. Appl. Math. **157**(2), pp. 507–509.
- G. F. Miller (1960). *Tables of Generalized Exponential Integrals*. NPL Mathematical Tables, Vol. III. London: Her Majesty's Stationery Office.
- G. F. Miller (1966). *On the convergence of the Chebyshev series for functions possessing a singularity in the range of representation*. SIAM J. Numer. Anal. **3**(3), pp. 390–409.
- J. Miller and V. S. Adamchik (1998). *Derivatives of the Hurwitz zeta function for rational arguments*. J. Comput. Appl. Math. **100**(2), pp. 201–206.
- J. C. P. Miller (1946). *The Airy Integral, Giving Tables of Solutions of the Differential Equation  $y'' = xy$* . British Association for the Advancement of Science, Mathematical Tables Part-Vol. B. Cambridge: Cambridge University Press.
- J. C. P. Miller (1950). *On the choice of standard solutions for a homogeneous linear differential equation of the second order*. Quart. J. Mech. Appl. Math. **3**(2), pp. 225–235.

- J. C. P. Miller (1952). *On the choice of standard solutions to Weber's equation*. Proc. Cambridge Philos. Soc. **48**, pp. 428–435.
- J. C. P. Miller (Ed.) (1955). *Tables of Weber Parabolic Cylinder Functions*. London: Her Majesty's Stationery Office.
- W. Miller, Jr. (1974). *Lie theory and separation of variables. I: Parabolic cylinder coordinates*. SIAM J. Math. Anal. **5**(4), pp. 626–643.
- W. Miller, Jr. (1977). *Symmetry and Separation of Variables*. Reading, MA-London-Amsterdam: Addison-Wesley Publishing Co. Encyclopedia of Mathematics and its Applications, Vol. 4.
- J. P. Mills (1926). *Table of the ratio: Area to bounding ordinate, for any portion of normal curve*. Biometrika **18**, pp. 395–400.
- A. E. Milne, P. A. Clarkson, and A. P. Bassom (1997). *Bäcklund transformations and solution hierarchies for the third Painlevé equation*. Stud. Appl. Math. **98**(2), pp. 139–194.
- S. C. Milne (1985a). *A  $q$ -analog of the  ${}_5F_4(; ; 1)$  summation theorem for hypergeometric series well-poised in  $SU(n)$* . Adv. in Math. **57**(1), pp. 14–33.
- S. C. Milne (1985b). *An elementary proof of the Macdonald identities for  $A_l^{(1)}$* . Adv. in Math. **57**(1), pp. 34–70.
- S. C. Milne (1985c). *A new symmetry related to  $SU(n)$  for classical basic hypergeometric series*. Adv. in Math. **57**(1), pp. 71–90.
- S. C. Milne (1985d). *A  $q$ -analog of hypergeometric series well-poised in  $SU(n)$  and invariant  $G$ -functions*. Adv. in Math. **58**(1), pp. 1–60.
- S. C. Milne (1988). *A  $q$ -analog of the Gauss summation theorem for hypergeometric series in  $U(n)$* . Adv. in Math. **72**(1), pp. 59–131.
- S. C. Milne (1994). *A  $q$ -analog of a Whipple's transformation for hypergeometric series in  $U(n)$* . Adv. Math. **108**(1), pp. 1–76.
- S. C. Milne (1996). *New infinite families of exact sums of squares formulas, Jacobi elliptic functions, and Ramanujan's tau function*. Proc. Nat. Acad. Sci. U.S.A. **93**(26), pp. 15004–15008.
- S. C. Milne (1997). *Balanced  ${}_3\Theta_2$  summation theorems for  $U(n)$  basic hypergeometric series*. Adv. Math. **131**(1), pp. 93–187.
- S. C. Milne (2002). *Infinite families of exact sums of squares formulas, Jacobi elliptic functions, continued fractions, and Schur functions*. Ramanujan J. **6**(1), pp. 7–149.
- S. C. Milne and G. M. Lilly (1992). *The  $A_l$  and  $C_l$  Bailey transform and lemma*. Bull. Amer. Math. Soc. (N.S.) **26**(2), pp. 258–263.
- L. M. Milne-Thomson (1933). *The Calculus of Finite Differences*. London: Macmillan and Co. Ltd. Reprinted in 1951 by Macmillan, and in 1981 by Chelsea Publishing Co., New York, and American Mathematical Society, AMS Chelsea Book Series, Providence, RI.
- L. M. Milne-Thomson (1950). *Jacobian Elliptic Function Tables*. New York: Dover Publications Inc.
- A. C. G. Mitchell and M. W. Zemansky (1961). *Resonance Radiation and Excited Atoms* (2nd ed.). Cambridge, England: Cambridge University Press. Reprinted by Cambridge University Press in 1971.
- D. S. Mitrinović (1964). *Elementary Inequalities*. Groningen: P. Noordhoff Ltd. In cooperation with E. S. Barnes, D. C. B. Marsh, J. R. M. Radok. Tutorial Text, No. 1.
- D. S. Mitrinović (1970). *Analytic Inequalities*. New York: Springer-Verlag. Addenda: Univ. Beograd. Publ. Elektrotehn. Fak. Ser. Mat. Fiz., no. 634–677 (1979), pp. 3–24 and no. 577–598 (1977), pp. 3–10.
- D. S. Moak (1981). *The  $q$ -analogue of the Laguerre polynomials*. J. Math. Anal. Appl. **81**(1), pp. 20–47.
- D. S. Moak (1984). *The  $q$ -analogue of Stirling's formula*. Rocky Mountain J. Math. **14**(2), pp. 403–413.
- S. Moch, P. Uwer, and S. Weinzierl (2002). *Nested sums, expansion of transcendental functions, and multiscale multiloop integrals*. J. Math. Phys. **43**(6), pp. 3363–3386.
- V. P. Modenov and A. V. Filonov (1986). *Calculation of zeros of cylindrical functions and their derivatives*. Vestnik Moskov. Univ. Ser. XV Vychisl. Mat. Kibernet. (2), pp. 63–64, 71. In Russian.
- N. Mohankumar and A. Natarajan (1997). *The accurate evaluation of a particular Fermi-Dirac integral*. Comput. Phys. Comm. **101**(1-2), pp. 47–53.
- E. W. Montroll (1964). *Lattice Statistics*. In E. F. Beckenbach (Ed.), *Applied Combinatorial Mathematics*, University of California Engineering and Physical Sciences Extension Series, pp. 96–143. New York-London-Sydney: John Wiley and Sons, Inc. Reprinted by Robert E. Krieger Publishing Co. in 1981.
- P. Moon and D. E. Spencer (1971). *Field Theory Handbook. Including Coordinate Systems, Differential Equations and Their Solutions* (2nd ed.). Berlin: Springer-Verlag. Reprinted in 1988.
- R. E. Moore (1979). *Methods and Applications of Interval Analysis*, Volume 2 of *SIAM Studies in Applied Mathematics*. Philadelphia, PA: Society for Industrial and Applied Mathematics (SIAM).
- L. J. Mordell (1917). *On the representation of numbers as a sum of  $2r$  squares*. Quarterly Journal of Math. **48**, pp. 93–104.

- L. J. Mordell (1958). *On the evaluation of some multiple series*. J. London Math. Soc. (2) **33**, pp. 368–371.
- G. W. Morgenthaler and H. Reismann (1963). *Zeros of first derivatives of Bessel functions of the first kind,  $J'_n(x)$ ,  $21 \leq n \leq 51$ ,  $0 \leq x \leq 100$* . J. Res. Nat. Bur. Standards Sect. B **67B**(3), pp. 181–183.
- T. Morita (1978). *Calculation of the complete elliptic integrals with complex modulus*. Numer. Math. **29**(2), pp. 233–236. An Algol procedure for calculating the complete elliptic integrals of the first and the second kind with complex modulus  $k$  is included.
- R. Morris (1979). *The dilogarithm function of a real argument*. Math. Comp. **33**(146), pp. 778–787.
- P. M. Morse and H. Feshbach (1953a). *Methods of Theoretical Physics*, Volume 1. New York: McGraw-Hill Book Co.
- P. M. Morse and H. Feshbach (1953b). *Methods of Theoretical Physics*, Volume 2. New York: McGraw-Hill Book Co.
- L. Moser and M. Wyman (1958a). *Asymptotic development of the Stirling numbers of the first kind*. J. London Math. Soc. **33**, pp. 133–146.
- L. Moser and M. Wyman (1958b). *Stirling numbers of the second kind*. Duke Math. J. **25**(1), pp. 29–43.
- S. L. B. Moshier (1989). *Methods and Programs for Mathematical Functions*. Chichester: Ellis Horwood Ltd. Includes diskette.
- N. F. Mott and H. S. W. Massey (1956). *Theory of Atomic Collisions* (3rd ed.). Oxford: Oxford Univ. Press. Two-volume paperback version reprinted in 1987.
- R. J. Muirhead (1978). *Latent roots and matrix variates: A review of some asymptotic results*. Ann. Statist. **6**(1), pp. 5–33.
- R. J. Muirhead (1982). *Aspects of Multivariate Statistical Theory*. New York: John Wiley & Sons Inc.
- M. E. Muldoon (1970). *Singular integrals whose kernels involve certain Sturm-Liouville functions. I*. J. Math. Mech. **19**(10), pp. 855–873.
- M. E. Muldoon (1977). *Higher monotonicity properties of certain Sturm-Liouville functions. V*. Proc. Roy. Soc. Edinburgh Sect. A **77**(1-2), pp. 23–37.
- M. E. Muldoon (1979). *On the zeros of a cross-product of Bessel functions of different orders*. Z. Angew. Math. Mech. **59**(6), pp. 272–273.
- M. E. Muldoon (1981). *The variation with respect to order of zeros of Bessel functions*. Rend. Sem. Mat. Univ. Politec. Torino **39**(2), pp. 15–25.
- H. P. Mulholland and S. Goldstein (1929). *The characteristic numbers of the Mathieu equation with purely imaginary parameter*. Phil. Mag. Series 7 **8**(53), pp. 834–840.
- D. Müller, B. G. Kelly, and J. J. O'Brien (1994). *Spheroidal eigenfunctions of the tidal equation*. Phys. Rev. Lett. **73**(11), pp. 1557–1560.
- H. J. W. Müller (1962). *Asymptotic expansions of oblate spheroidal wave functions and their characteristic numbers*. J. Reine Angew. Math. **211**, pp. 33–47.
- H. J. W. Müller (1963). *Asymptotic expansions of prolate spheroidal wave functions and their characteristic numbers*. J. Reine Angew. Math. **212**, pp. 26–48.
- H. J. W. Müller (1966a). *Asymptotic expansions of ellipsoidal wave functions and their characteristic numbers*. Math. Nachr. **31**, pp. 89–101.
- H. J. W. Müller (1966b). *Asymptotic expansions of ellipsoidal wave functions in terms of Hermite functions*. Math. Nachr. **32**, pp. 49–62.
- H. J. W. Müller (1966c). *On asymptotic expansions of ellipsoidal wave functions*. Math. Nachr. **32**, pp. 157–172.
- J.-M. Muller (1997). *Elementary Functions: Algorithms and Implementation*. Boston, MA: Birkhäuser Boston Inc. A 2nd edition was published in 2006.
- K. H. Müller (1988). *Elastodynamics in parabolic cylinders*. Z. Angew. Math. Phys. **39**(5), pp. 748–752.
- D. Mumford (1983). *Tata Lectures on Theta. I*. Boston, MA: Birkhäuser Boston Inc.
- D. Mumford (1984). *Tata Lectures on Theta. II*. Boston, MA: Birkhäuser Boston Inc. Jacobian theta functions and differential equations.
- Y. Murata (1985). *Rational solutions of the second and the fourth Painlevé equations*. Funkcial. Ekvac. **28**(1), pp. 1–32.
- Y. Murata (1995). *Classical solutions of the third Painlevé equation*. Nagoya Math. J. **139**, pp. 37–65.
- L. A. Muraveĭ (1976). *Zeros of the function  $Ai'(z) - \sigma Ai(z)$* . Differential Equations **11**, pp. 797–811.
- B. T. M. Murphy and A. D. Wood (1997). *Hyperasymptotic solutions of second-order ordinary differential equations with a singularity of arbitrary integer rank*. Methods Appl. Anal. **4**(3), pp. 250–260.
- J. Murzewski and A. Sowa (1972). *Tables of the functions of the parabolic cylinder for negative integer parameters*. Zastos. Mat. **13**, pp. 261–273.
- A. Nakamura (1996). *Toda equation and its solutions in special functions*. J. Phys. Soc. Japan **65**(6), pp. 1589–1597.
- W. Narkiewicz (2000). *The Development of Prime Number Theory: From Euclid to Hardy and Littlewood*. Berlin: Springer-Verlag.

- A. Natarajan and N. Mohankumar (1993). *On the numerical evaluation of the generalised Fermi-Dirac integrals*. Comput. Phys. Comm. **76**(1), pp. 48–50.
- National Bureau of Standards (1944). *Tables of Lagrangian Interpolation Coefficients*. New York: Columbia University Press. Technical Director: Arnold N. Lowan.
- National Physical Laboratory (1961). *Modern Computing Methods* (2nd ed.). Notes on Applied Science, No. 16. London: Her Majesty's Stationery Office.
- D. Naylor (1984). *On simplified asymptotic formulas for a class of Mathieu functions*. SIAM J. Math. Anal. **15**(6), pp. 1205–1213.
- D. Naylor (1987). *On a simplified asymptotic formula for the Mathieu function of the third kind*. SIAM J. Math. Anal. **18**(6), pp. 1616–1629.
- D. Naylor (1989). *On an integral transform involving a class of Mathieu functions*. SIAM J. Math. Anal. **20**(6), pp. 1500–1513.
- D. Naylor (1990). *On an asymptotic expansion of the Kontorovich-Lebedev transform*. Applicable Anal. **39**(4), pp. 249–263.
- D. Naylor (1996). *On an asymptotic expansion of the Kontorovich-Lebedev transform*. Methods Appl. Anal. **3**(1), pp. 98–108.
- NBS (1958). National Bureau of Standards. *Integrals of Airy Functions*. Number 52 in National Bureau of Standards Applied Mathematics Series. Washington, D.C.: U.S. Government Printing Office.
- NBS (1967). National Bureau of Standards. *Tables Relating to Mathieu Functions: Characteristic Values, Coefficients, and Joining Factors* (2nd ed.). Number 59 in National Bureau of Standards Applied Mathematics Series. Washington, D.C.: U.S. Government Printing Office.
- J. Negro, L. M. Nieto, and O. Rosas-Ortiz (2000). *Confluent hypergeometric equations and related solvable potentials in quantum mechanics*. J. Math. Phys. **41**(12), pp. 7964–7996.
- W. J. Nellis and B. C. Carlson (1966). *Reduction and evaluation of elliptic integrals*. Math. Comp. **20**(94), pp. 223–231.
- G. Németh (1992). *Mathematical Approximation of Special Functions*. Commack, NY: Nova Science Publishers Inc. Ten papers on Chebyshev expansions.
- J. J. Nestor (1984). *Uniform Asymptotic Approximations of Solutions of Second-order Linear Differential Equations, with a Coalescing Simple Turning Point and Simple Pole*. Ph. D. thesis, University of Maryland, College Park, MD.
- E. Neuman (1969). *On the calculation of elliptic integrals of the second and third kinds*. Zastos. Mat. **11**, pp. 91–94.
- E. Neuman (2003). *Bounds for symmetric elliptic integrals*. J. Approx. Theory **122**(2), pp. 249–259.
- E. Neuman (2004). *Inequalities involving Bessel functions of the first kind*. JIPAM. J. Inequal. Pure Appl. Math. **5**(4), pp. Article 94, 4 pp. (electronic).
- P. Nevai (1986). *Géza Freud, orthogonal polynomials and Christoffel functions. A case study*. J. Approx. Theory **48**(1), pp. 3–167.
- E. H. Neville (1951). *Jacobian Elliptic Functions* (2nd ed.). Oxford: Clarendon Press.
- J. N. Newman (1984). *Approximations for the Bessel and Struve functions*. Math. Comp. **43**(168), pp. 551–556.
- M. Newman (1967). *Solving equations exactly*. J. Res. Nat. Bur. Standards Sect. B **71B**, pp. 171–179.
- T. D. Newton (1952). *Coulomb Functions for Large Values of the Parameter  $\eta$* . Technical report, Atomic Energy of Canada Limited, Chalk River, Ontario. Rep. CRT-526.
- E. W. Ng and M. Geller (1969). *A table of integrals of the error functions*. J. Res. Nat. Bur. Standards Sect. B. **73B**, pp. 1–20. See for additions and corrections same journal, Sect. B 75, 149–163 (1975).
- N. Nielsen (1906a). *Handbuch der Theorie der Gammafunktion*. Leipzig: B. G. Teubner. For a reprint with corrections see Nielsen (1965).
- N. Nielsen (1906b). *Theorie des Integrallogarithmus und verwandter Transzendenten*. Leipzig: B. G. Teubner. For a reprint with corrections see Nielsen (1965).
- N. Nielsen (1909). *Der Eulersche Dilogarithmus und seine Verallgemeinerungen*. Nova Acta Leopoldina **90**, pp. 123–212.
- N. Nielsen (1923). *Traité Élémentaire des Nombres de Bernoulli*. Paris: Gauthier-Villars.
- N. Nielsen (1965). *Die Gammafunktion. Band I. Handbuch der Theorie der Gammafunktion. Band II. Theorie des Integrallogarithmus und verwandter Transzendenten*. New York: Chelsea Publishing Co. Both books are textually unaltered except for correction of errata.
- Y. Nievergelt (1995). *Bisection hardly ever converges linearly*. Numer. Math. **70**(1), pp. 111–118.
- A. F. Nikiforov and V. B. Uvarov (1988). *Special Functions of Mathematical Physics: A Unified Introduction with Applications*. Basel: Birkhäuser Verlag. Translated from the Russian and with a preface by Ralph P. Boas, with a foreword by A. A. Samarskiĭ.
- I. Niven, H. S. Zuckerman, and H. L. Montgomery (1991). *An Introduction to the Theory of Numbers* (5th ed.). New York: John Wiley & Sons Inc.
- C. J. Noble (2004). *Evaluation of negative energy Coulomb (Whittaker) functions*. Comput. Phys. Comm. **159**(1), pp. 55–62. Double-precision Fortran-90 code.



- V. A. Noonburg (1995). *A separating surface for the Painlevé differential equation  $x'' = x^2 - t$* . J. Math. Anal. Appl. **193**(3), pp. 817–831.
- N. E. Nörlund (1922). *Mémoire sur les polynomes de Bernoulli*. Acta Math. **43**, pp. 121–196.
- N. E. Nörlund (1924). *Vorlesungen über Differenzenrechnung*. Berlin: Springer-Verlag. Reprinted 1954 by Chelsea Publishing Company, New York.
- N. E. Nörlund (1955). *Hypergeometric functions*. Acta Math. **94**, pp. 289–349.
- L. N. Nosova and S. A. Tumarkin (1965). *Tables of Generalized Airy Functions for the Asymptotic Solution of the Differential Equations  $\epsilon(py')' + (q + \epsilon r)y = f$* . Oxford: Pergamon Press. D. E. Brown, translator.
- M. Noumi (2004). *Painlevé Equations through Symmetry*, Volume 223 of *Translations of Mathematical Monographs*. Providence, RI: American Mathematical Society. Translated from the 2000 Japanese original by the author.
- M. Noumi and Y. Yamada (1998). *Affine Weyl groups, discrete dynamical systems and Painlevé equations*. Comm. Math. Phys. **199**(2), pp. 281–295.
- M. Noumi and Y. Yamada (1999). *Symmetries in the fourth Painlevé equation and Okamoto polynomials*. Nagoya Math. J. **153**, pp. 53–86.
- V. Y. Novokshënov (1985). *The asymptotic behavior of the general real solution of the third Painlevé equation*. Dokl. Akad. Nauk SSSR **283**(5), pp. 1161–1165. In Russian. English translation: Sov. Math., Dokl. **30**(1988), no. 8, pp. 666–668.
- V. Y. Novokshënov (1990). *The Boutroux ansatz for the second Painlevé equation in the complex domain*. Izv. Akad. Nauk SSSR Ser. Mat. **54**(6), pp. 1229–1251. In Russian. English translation: Math. USSR-Izv. **37**(1991), no. 3, pp. 587–609.
- H. M. Nussenzweig (1965). *High-frequency scattering by an impenetrable sphere*. Ann. Physics **34**(1), pp. 23–95.
- J. F. Nye (1999). *Natural Focusing and Fine Structure of Light: Caustics and Wave Dislocations*. Bristol: Institute of Physics Publishing.
- J. F. Nye (2006). *Dislocation lines in the hyperbolic umbilic diffraction catastrophe*. Proc. Roy. Soc. Lond. Ser. A **462**, pp. 2299–2313.
- J. F. Nye (2007). *Dislocation lines in the swallowtail diffraction catastrophe*. Proc. Roy. Soc. Lond. Ser. A **463**, pp. 343–355.
- F. Oberhettinger (1972). *Tables of Bessel Transforms*. Berlin-New York: Springer-Verlag. Table errata: Math. Comp. v. 65 (1996), no. 215, p. 1386.
- F. Oberhettinger (1973). *Fourier Expansions. A Collection of Formulas*. New York-London: Academic Press.
- F. Oberhettinger (1974). *Tables of Mellin Transforms*. Berlin-New York: Springer-Verlag.
- F. Oberhettinger (1990). *Tables of Fourier Transforms and Fourier Transforms of Distributions*. Berlin: Springer-Verlag.
- F. Oberhettinger and L. Badii (1973). *Tables of Laplace Transforms*. Berlin-New York: Springer-Verlag. Table errata: Math. Comp. v. 50 (1988), no. 182, pp. 653–654.
- F. Oberhettinger and T. P. Higgins (1961). *Tables of Lebedev, Mehler and Generalized Mehler Transforms*. Mathematical Note 246, Boeing Scientific Research Lab, Seattle.
- A. M. Odlyzko (1987). *On the distribution of spacings between zeros of the zeta function*. Math. Comp. **48**(177), pp. 273–308.
- A. M. Odlyzko (1995). *Asymptotic Enumeration Methods*. In L. Lovász, R. L. Graham, and M. Grötschel (Eds.), *Handbook of Combinatorics, Vol. 2*, pp. 1063–1229. Amsterdam: Elsevier.
- O. M. OGREID and P. OSLAND (1998). *Summing one- and two-dimensional series related to the Euler series*. J. Comput. Appl. Math. **98**(2), pp. 245–271.
- K. OKAMOTO (1981). *On the  $\tau$ -function of the Painlevé equations*. Phys. D **2**(3), pp. 525–535.
- K. OKAMOTO (1986). *Studies on the Painlevé equations. III. Second and fourth Painlevé equations,  $P_{II}$  and  $P_{IV}$* . Math. Ann. **275**(2), pp. 221–255.
- K. OKAMOTO (1987a). *Studies on the Painlevé equations. I. Sixth Painlevé equation  $P_{VI}$* . Ann. Mat. Pura Appl. (4) **146**, pp. 337–381.
- K. OKAMOTO (1987b). *Studies on the Painlevé equations. II. Fifth Painlevé equation  $P_V$* . Japan. J. Math. (N.S.) **13**(1), pp. 47–76.
- K. OKAMOTO (1987c). *Studies on the Painlevé equations. IV. Third Painlevé equation  $P_{III}$* . Funkcial. Ekvac. **30**(2-3), pp. 305–332.
- S. OKUI (1974). *Complete elliptic integrals resulting from infinite integrals of Bessel functions*. J. Res. Nat. Bur. Standards Sect. B **78B**(3), pp. 113–135.
- S. OKUI (1975). *Complete elliptic integrals resulting from infinite integrals of Bessel functions. II*. J. Res. Nat. Bur. Standards Sect. B **79B**(3-4), pp. 137–170.
- A. B. OLDE DAALHUIS (1994). *Asymptotic expansions for  $q$ -gamma,  $q$ -exponential, and  $q$ -Bessel functions*. J. Math. Anal. Appl. **186**(3), pp. 896–913.
- A. B. OLDE DAALHUIS (1995). *Hyperasymptotic solutions of second-order linear differential equations. II*. Methods Appl. Anal. **2**(2), pp. 198–211.

- A. B. Olde Daalhuis (1996). *Hyperterminants. I*. J. Comput. Appl. Math. **76**(1-2), pp. 255–264.
- A. B. Olde Daalhuis (1998a). *Hyperasymptotic solutions of higher order linear differential equations with a singularity of rank one*. Proc. Roy. Soc. London Ser. A **454**, pp. 1–29.
- A. B. Olde Daalhuis (1998b). *Hyperterminants. II*. J. Comput. Appl. Math. **89**(1), pp. 87–95.
- A. B. Olde Daalhuis (1998c). *On the resurgence properties of the uniform asymptotic expansion of the incomplete gamma function*. Methods Appl. Anal. **5**(4), pp. 425–438.
- A. B. Olde Daalhuis (2000). *On the asymptotics for late coefficients in uniform asymptotic expansions of integrals with coalescing saddles*. Methods Appl. Anal. **7**(4), pp. 727–745.
- A. B. Olde Daalhuis (2003a). *Uniform asymptotic expansions for hypergeometric functions with large parameters. I*. Analysis and Applications (Singapore) **1**(1), pp. 111–120.
- A. B. Olde Daalhuis (2003b). *Uniform asymptotic expansions for hypergeometric functions with large parameters. II*. Analysis and Applications (Singapore) **1**(1), pp. 121–128.
- A. B. Olde Daalhuis (2004a). *Inverse factorial-series solutions of difference equations*. Proc. Edinb. Math. Soc. (2) **47**(2), pp. 421–448.
- A. B. Olde Daalhuis (2004b). *On higher-order Stokes phenomena of an inhomogeneous linear ordinary differential equation*. J. Comput. Appl. Math. **169**(1), pp. 235–246.
- A. B. Olde Daalhuis (2005a). *Hyperasymptotics for nonlinear ODEs. I. A Riccati equation*. Proc. R. Soc. Lond. Ser. A Math. Phys. Eng. Sci. **461**(2060), pp. 2503–2520.
- A. B. Olde Daalhuis (2005b). *Hyperasymptotics for nonlinear ODEs. II. The first Painlevé equation and a second-order Riccati equation*. Proc. R. Soc. Lond. Ser. A Math. Phys. Eng. Sci. **461**(2062), pp. 3005–3021.
- A. B. Olde Daalhuis (2010). *Uniform asymptotic expansions for hypergeometric functions with large parameters. III*. Analysis and Applications (Singapore). In press.
- A. B. Olde Daalhuis and F. W. J. Olver (1994). *Exponentially improved asymptotic solutions of ordinary differential equations. II Irregular singularities of rank one*. Proc. Roy. Soc. London Ser. A **445**, pp. 39–56.
- A. B. Olde Daalhuis and F. W. J. Olver (1995a). *Hyperasymptotic solutions of second-order linear differential equations. I*. Methods Appl. Anal. **2**(2), pp. 173–197.
- A. B. Olde Daalhuis and F. W. J. Olver (1995b). *On the calculation of Stokes multipliers for linear differential equations of the second order*. Methods Appl. Anal. **2**(3), pp. 348–367.
- A. B. Olde Daalhuis and F. W. J. Olver (1998). *On the asymptotic and numerical solution of linear ordinary differential equations*. SIAM Rev. **40**(3), pp. 463–495.
- A. B. Olde Daalhuis and N. M. Temme (1994). *Uniform Airy-type expansions of integrals*. SIAM J. Math. Anal. **25**(2), pp. 304–321.
- M. N. Olevskii (1950). *Triorthogonal systems in spaces of constant curvature in which the equation  $\Delta_2 u + \lambda u = 0$  allows a complete separation of variables*. Mat. Sbornik N.S. **27**(69)(3), pp. 379–426. In Russian.
- T. Oliveira e Silva (2006). *Computing  $\pi(x)$ : The combinatorial method*. Revista do DETUA **4**(6), pp. 759–768.
- J. Oliver (1977). *An error analysis of the modified Clenshaw method for evaluating Chebyshev and Fourier series*. J. Inst. Math. Appl. **20**(3), pp. 379–391.
- I. Olkin (1959). *A class of integral identities with matrix argument*. Duke Math. J. **26**(2), pp. 207–213.
- F. W. J. Olver (1950). *A new method for the evaluation of zeros of Bessel functions and of other solutions of second-order differential equations*. Proc. Cambridge Philos. Soc. **46**(4), pp. 570–580.
- F. W. J. Olver (1951). *A further method for the evaluation of zeros of Bessel functions and some new asymptotic expansions for zeros of functions of large order*. Proc. Cambridge Philos. Soc. **47**, pp. 699–712.
- F. W. J. Olver (1952). *Some new asymptotic expansions for Bessel functions of large orders*. Proc. Cambridge Philos. Soc. **48**(3), pp. 414–427.
- F. W. J. Olver (1954). *The asymptotic expansion of Bessel functions of large order*. Philos. Trans. Roy. Soc. London. Ser. A. **247**, pp. 328–368.
- F. W. J. Olver (1959). *Uniform asymptotic expansions for Weber parabolic cylinder functions of large orders*. J. Res. Nat. Bur. Standards Sect. B **63B**, pp. 131–169.
- F. W. J. Olver (Ed.) (1960). *Bessel Functions. Part III: Zeros and Associated Values*. Royal Society Mathematical Tables, Volume 7. Cambridge-New York: Cambridge University Press.
- F. W. J. Olver (1962). *Tables for Bessel Functions of Moderate or Large Orders*. National Physical Laboratory Mathematical Tables, Vol. 6. Department of Scientific and Industrial Research. London: Her Majesty's Stationery Office.
- F. W. J. Olver (1964a). *Error analysis of Miller's recurrence algorithm*. Math. Comp. **18**(85), pp. 65–74.
- F. W. J. Olver (1964b). *Error bounds for asymptotic expansions in turning-point problems*. J. Soc. Indust. Appl. Math. **12**(1), pp. 200–214.

- F. W. J. Olver (1965). *On the asymptotic solution of second-order differential equations having an irregular singularity of rank one, with an application to Whittaker functions*. J. Soc. Indust. Appl. Math. Ser. B Numer. Anal. **2**(2), pp. 225–243.
- F. W. J. Olver (1967a). *Numerical solution of second-order linear difference equations*. J. Res. Nat. Bur. Standards Sect. B **71B**, pp. 111–129.
- F. W. J. Olver (1967b). *Bounds for the solutions of second-order linear difference equations*. J. Res. Nat. Bur. Standards Sect. B **71B**(4), pp. 161–166.
- F. W. J. Olver (1970). *A paradox in asymptotics*. SIAM J. Math. Anal. **1**(4), pp. 533–534.
- F. W. J. Olver (1974). *Error bounds for stationary phase approximations*. SIAM J. Math. Anal. **5**(1), pp. 19–29.
- F. W. J. Olver (1975a). *Second-order linear differential equations with two turning points*. Philos. Trans. Roy. Soc. London Ser. A **278**, pp. 137–174.
- F. W. J. Olver (1975b). *Legendre functions with both parameters large*. Philos. Trans. Roy. Soc. London Ser. A **278**, pp. 175–185.
- F. W. J. Olver (1976). *Improved error bounds for second-order differential equations with two turning points*. J. Res. Nat. Bur. Standards Sect. B **80B**(4), pp. 437–440.
- F. W. J. Olver (1977a). *Connection formulas for second-order differential equations with multiple turning points*. SIAM J. Math. Anal. **8**(1), pp. 127–154.
- F. W. J. Olver (1977b). *Connection formulas for second-order differential equations having an arbitrary number of turning points of arbitrary multiplicities*. SIAM J. Math. Anal. **8**(4), pp. 673–700.
- F. W. J. Olver (1977c). *Second-order differential equations with fractional transition points*. Trans. Amer. Math. Soc. **226**, pp. 227–241.
- F. W. J. Olver (1978). *General connection formulae for Liouville-Green approximations in the complex plane*. Philos. Trans. Roy. Soc. London Ser. A **289**, pp. 501–548.
- F. W. J. Olver (1980a). *Asymptotic approximations and error bounds*. SIAM Rev. **22**(2), pp. 188–203.
- F. W. J. Olver (1980b). *Whittaker functions with both parameters large: Uniform approximations in terms of parabolic cylinder functions*. Proc. Roy. Soc. Edinburgh Sect. A **86**(3-4), pp. 213–234.
- F. W. J. Olver (1983). *Error Analysis of Complex Arithmetic*. In H. Werner, L. Wuytack, E. Ng, and H. J. Bünger (Eds.), *Computational Aspects of Complex Analysis (Braunlage, 1982)*, Volume 102 of *NATO Adv. Sci. Inst. Ser. C: Math. Phys. Sci.*, pp. 279–292. Dordrecht-Boston, MA: D. Reidel.
- F. W. J. Olver (1991a). *Uniform, exponentially improved, asymptotic expansions for the generalized exponential integral*. SIAM J. Math. Anal. **22**(5), pp. 1460–1474.
- F. W. J. Olver (1991b). *Uniform, exponentially improved, asymptotic expansions for the confluent hypergeometric function and other integral transforms*. SIAM J. Math. Anal. **22**(5), pp. 1475–1489.
- F. W. J. Olver (1993a). *Exponentially-improved asymptotic solutions of ordinary differential equations I: The confluent hypergeometric function*. SIAM J. Math. Anal. **24**(3), pp. 756–767.
- F. W. J. Olver (1994a). *Asymptotic expansions of the coefficients in asymptotic series solutions of linear differential equations*. Methods Appl. Anal. **1**(1), pp. 1–13.
- F. W. J. Olver (1994b). *The Generalized Exponential Integral*. In R. V. M. Zahar (Ed.), *Approximation and Computation (West Lafayette, IN, 1993)*, Volume 119 of *International Series of Numerical Mathematics*, pp. 497–510. Boston, MA: Birkhäuser Boston.
- F. W. J. Olver (1995). *On an asymptotic expansion of a ratio of gamma functions*. Proc. Roy. Irish Acad. Sect. A **95**(1), pp. 5–9.
- F. W. J. Olver (1997a). *Asymptotic solutions of linear ordinary differential equations at an irregular singularity of rank unity*. Methods Appl. Anal. **4**(4), pp. 375–403.
- F. W. J. Olver (1997b). *Asymptotics and Special Functions*. Wellesley, MA: A. K. Peters. Reprint, with corrections, of original Academic Press edition, 1974.
- F. W. J. Olver (1999). *On the uniqueness of asymptotic solutions of linear differential equations*. Methods Appl. Anal. **6**(2), pp. 165–174.
- F. W. J. Olver and J. M. Smith (1983). *Associated Legendre functions on the cut*. J. Comput. Phys. **51**(3), pp. 502–518.
- F. W. J. Olver and D. J. Sookne (1972). *Note on backward recurrence algorithms*. Math. Comp. **26**(120), pp. 941–947.
- F. W. J. Olver and F. Stenger (1965). *Error bounds for asymptotic solutions of second-order differential equations having an irregular singularity of arbitrary rank*. J. Soc. Indust. Appl. Math. Ser. B Numer. Anal. **2**(2), pp. 244–249.
- P. J. Olver (1993b). *Applications of Lie Groups to Differential Equations* (2nd ed.), Volume 107 of *Graduate Texts in Mathematics*. New York: Springer-Verlag.
- M. K. Ong (1986). *A closed form solution of the s-wave Bethe-Goldstone equation with an infinite repulsive core*. J. Math. Phys. **27**(4), pp. 1154–1158.
- K. Ono (2000). *Distribution of the partition function modulo m*. Ann. of Math. (2) **151**(1), pp. 293–307.

- G. E. Ordóñez and D. J. Driebe (1996). *Spectral decomposition of tent maps using symmetry considerations*. J. Statist. Phys. **84**(1-2), pp. 269–276.
- J. M. Ortega and W. C. Rheinboldt (1970). *Iterative Solution of Nonlinear Equations in Several Variables*. New York: Academic Press. Reprinted in 2000 by the Society for Industrial and Applied Mathematics (SIAM), Philadelphia, Pennsylvania.
- C. Osácar, J. Palacián, and M. Palacios (1995). *Numerical evaluation of the dilogarithm of complex argument*. Celestial Mech. Dynam. Astronom. **62**(1), pp. 93–98.
- A. M. Ostrowski (1973). *Solution of Equations in Euclidean and Banach Spaces*, Volume 9 of *Pure and Applied Mathematics*. New York-London: Academic Press. Third edition of *Solution of equations and systems of equations*.
- R. H. Ott (1985). *Scattering by a parabolic cylinder—a uniform asymptotic expansion*. J. Math. Phys. **26**(4), pp. 854–860.
- M. L. Overton (2001). *Numerical Computing with IEEE Floating Point Arithmetic*. Philadelphia, PA: Society for Industrial and Applied Mathematics (SIAM). Including one theorem, one rule of thumb, and one hundred and one exercises.
- V. I. Pagurova (1961). *Tables of the Exponential Integral  $E_\nu(x) = \int_1^\infty e^{-xu} u^{-\nu} du$* . New York: Pergamon Press.
- V. I. Pagurova (1963). *Tablitsy nepolnoi gamma-funktsii*. Moscow: Vyčisl. Centr Akad. Nauk SSSR. In Russian. Translated title: *Tables of the Incomplete Gamma Function*.
- V. I. Pagurova (1965). *An asymptotic formula for the incomplete gamma function*. Ž. Vyčisl. Mat. i Mat. Fiz. **5**, pp. 118–121. English translation in U.S.S.R. Computational Math. and Math. Phys. **5**(1), pp. 162–166.
- P. Painlevé (1906). *Sur les équations différentielles du second ordre à points critiques fixés*. C.R. Acad. Sc. Paris **143**, pp. 1111–1117.
- E. Pairman (1919). *Tables of Digamma and Trigamma Functions*. In K. Pearson (Ed.), *Tracts for Computers, No. 1*. Cambridge Univ. Press.
- B. V. Pal'tsev (1999). *On two-sided estimates, uniform with respect to the real argument and index, for modified Bessel functions*. Mat. Zametki **65**(5), pp. 681–692. English translation in Math. Notes 65 (1999) pp. 571–581.
- D. J. Panow (1955). *Formelsammlung zur numerischen Behandlung partieller Differentialgleichungen nach dem Differenzenverfahren*. Berlin: Akademie-Verlag.
- A. Papoulis (1977). *Signal Analysis*. New York: McGraw-Hill.
- R. B. Paris (1984). *An inequality for the Bessel function  $J_\nu(\nu x)$* . SIAM J. Math. Anal. **15**(1), pp. 203–205.
- R. B. Paris (1991). *The asymptotic behaviour of Pearcey's integral for complex variables*. Proc. Roy. Soc. London Ser. A **432**, pp. 391–426.
- R. B. Paris (1992a). *Smoothing of the Stokes phenomenon for high-order differential equations*. Proc. Roy. Soc. London Ser. A **436**, pp. 165–186.
- R. B. Paris (1992b). *Smoothing of the Stokes phenomenon using Mellin-Barnes integrals*. J. Comput. Appl. Math. **41**(1-2), pp. 117–133.
- R. B. Paris (2001a). *On the use of Hadamard expansions in hyperasymptotic evaluation. I. Real variables*. Proc. Roy. Soc. London Ser. A **457**(2016), pp. 2835–2853.
- R. B. Paris (2001b). *On the use of Hadamard expansions in hyperasymptotic evaluation. II. Complex variables*. Proc. Roy. Soc. London Ser. A **457**, pp. 2855–2869.
- R. B. Paris (2002a). *Error bounds for the uniform asymptotic expansion of the incomplete gamma function*. J. Comput. Appl. Math. **147**(1), pp. 215–231.
- R. B. Paris (2002b). *A uniform asymptotic expansion for the incomplete gamma function*. J. Comput. Appl. Math. **148**(2), pp. 323–339.
- R. B. Paris (2002c). *Exponential asymptotics of the Mittag-Leffler function*. Proc. Roy. Soc. London Ser. A **458**, pp. 3041–3052.
- R. B. Paris (2003). *The asymptotic expansion of a generalised incomplete gamma function*. J. Comput. Appl. Math. **151**(2), pp. 297–306.
- R. B. Paris (2004). *Exactification of the method of steepest descents: The Bessel functions of large order and argument*. Proc. Roy. Soc. London Ser. A **460**, pp. 2737–2759.
- R. B. Paris (2005a). *A Kummer-type transformation for a  ${}_2F_2$  hypergeometric function*. J. Comput. Appl. Math. **173**(2), pp. 379–382.
- R. B. Paris (2005b). *The Stokes phenomenon associated with the Hurwitz zeta function  $\zeta(s, a)$* . Proc. Roy. Soc. London Ser. A **461**, pp. 297–304.
- R. B. Paris and S. Cang (1997). *An asymptotic representation for  $\zeta(\frac{1}{2} + it)$* . Methods Appl. Anal. **4**(4), pp. 449–470.
- R. B. Paris and D. Kaminski (2001). *Asymptotics and Mellin-Barnes Integrals*. Cambridge: Cambridge University Press.
- R. B. Paris and W. N.-C. Sy (1983). *Influence of equilibrium shear flow along the magnetic field on the resistive tearing instability*. Phys. Fluids **26**(10), pp. 2966–2975.
- R. B. Paris and A. D. Wood (1995). *Stokes phenomenon demystified*. Bull. Inst. Math. Appl. **31**(1-2), pp. 21–28.
- G. Parisi (1988). *Statistical Field Theory*. Reading, MA: Addison-Wesley.

- A. M. Parkhurst and A. T. James (1974). *Zonal Polynomials of Order 1 Through 12*. In H. L. Harter and D. B. Owen (Eds.), *Selected Tables in Mathematical Statistics*, Volume 2, pp. 199–388. Providence, RI: Amer. Math. Soc.
- J. B. Parkinson (1969). *Optical properties of layer antiferromagnets with  $K_2NiF_4$  structure*. J. Phys. C: Solid State Physics **2**(11), pp. 2012–2021.
- R. Parnes (1972). *Complex zeros of the modified Bessel function  $K_n(Z)$* . Math. Comp. **26**(120), pp. 949–953.
- P. I. Pastro (1985). *Orthogonal polynomials and some  $q$ -beta integrals of Ramanujan*. J. Math. Anal. Appl. **112**(2), pp. 517–540.
- S. Paszkowski (1988). *Evaluation of Fermi-Dirac Integral*. In A. Cuyt (Ed.), *Nonlinear Numerical Methods and Rational Approximation (Wilrijk, 1987)*, Volume 43 of *Mathematics and Its Applications*, pp. 435–444. Dordrecht: Reidel.
- S. Paszkowski (1991). *Evaluation of the Fermi-Dirac integral of half-integer order*. Zastos. Mat. **21**(2), pp. 289–301.
- J. K. Patel and C. B. Read (1982). *Handbook of the Normal Distribution*, Volume 40 of *Statistics: Textbooks and Monographs*. New York: Marcel Dekker Inc. A revised and expanded 2nd edition was published in 1996.
- J. Patera and P. Winternitz (1973). *A new basis for the representation of the rotation group. Lamé and Heun polynomials*. J. Mathematical Phys. **14**(8), pp. 1130–1139.
- A. R. Paterson (1983). *A First Course in Fluid Dynamics*. Cambridge: Cambridge University Press.
- F. A. Paxton and J. E. Rollin (1959, June). *Tables of the Incomplete Elliptic Integrals of the First and Third Kind*. Technical report, Curtiss-Wright Corp., Research Division, Quehanna, PA. Reviewed in Math. Comp. **14**(1960)209–210.
- T. Pearcey (1946). *The structure of an electromagnetic field in the neighbourhood of a cusp of a caustic*. Philos. Mag. (7) **37**, pp. 311–317.
- K. Pearson (Ed.) (1965). *Tables of the Incomplete  $\Gamma$ -function*. Cambridge: Biometrika Office, Cambridge University Press.
- K. Pearson (Ed.) (1968). *Tables of the Incomplete Beta-function* (2nd ed.). Cambridge: Published for the Biometrika Trustees at the Cambridge University Press.
- T. G. Pedersen (2003). *Variational approach to excitons in carbon nanotubes*. Phys. Rev. B **67**(7), pp. (073401–1)–(073401–4).
- M. D. Perlman and I. Olkin (1980). *Unbiasedness of invariant tests for MANOVA and other multivariate problems*. Ann. Statist. **8**(6), pp. 1326–1341.
- G. Petiau (1955). *La Théorie des Fonctions de Bessel Exposée en vue de ses Applications à la Physique Mathématique*. Paris: Centre National de la Recherche Scientifique.
- M. S. Petković and L. D. Petković (1998). *Complex Interval Arithmetic and its Applications*, Volume 105 of *Mathematical Research*. Berlin: Wiley-VCH Verlag Berlin GmbH.
- M. Petkovšek, H. S. Wilf, and D. Zeilberger (1996). *A = B*. Wellesley, MA: A K Peters Ltd. With a separately available computer disk.
- E. Petropoulou (2000). *Bounds for ratios of modified Bessel functions*. Integral Transform. Spec. Funct. **9**(4), pp. 293–298.
- P. C. B. Phillips (1986). *The exact distribution of the Wald statistic*. Econometrica **54**(4), pp. 881–895.
- B. Pichon (1989). *Numerical calculation of the generalized Fermi-Dirac integrals*. Comput. Phys. Comm. **55**(2), pp. 127–136.
- R. Piessens (1984). *Chebyshev series approximations for the zeros of the Bessel functions*. J. Comput. Phys. **53**(1), pp. 188–192.
- R. Piessens (1990). *On the computation of zeros and turning points of Bessel functions*. Bull. Soc. Math. Grèce (N.S.) **31**, pp. 117–122.
- R. Piessens and S. Ahmed (1986). *Approximation for the turning points of Bessel functions*. J. Comput. Phys. **64**(1), pp. 253–257.
- R. Piessens and M. Branders (1972). *Chebyshev polynomial expansions of the Riemann zeta function*. Math. Comp. **26**(120), pp. G1–G5.
- R. Piessens and M. Branders (1983). *Modified Clenshaw-Curtis method for the computation of Bessel function integrals*. BIT **23**(3), pp. 370–381.
- R. Piessens and M. Branders (1985). *A survey of numerical methods for the computation of Bessel function integrals*. Rend. Sem. Mat. Univ. Politec. Torino (Special Issue), pp. 249–265. International conference on special functions: theory and computation (Turin, 1984).
- A. Pinkus and S. Zafrany (1997). *Fourier Series and Integral Transforms*. Cambridge: Cambridge University Press.
- G. Pittaluga and L. Sacripante (1991). *Inequalities for the zeros of the Airy functions*. SIAM J. Math. Anal. **22**(1), pp. 260–267.
- S. Pokorski (1987). *Gauge Field Theories*. Cambridge Monographs on Mathematical Physics. Cambridge: Cambridge University Press.
- J. Polchinski (1998). *String Theory: An Introduction to the Bosonic String, Vol. I*. Cambridge Monographs on Mathematical Physics. Cambridge: Cambridge University Press.

- G. Pólya (1937). *Kombinatorische Anzahlbestimmungen für Gruppen, Graphen und chemische Verbindungen*. Acta Mathematica **68**, pp. 145–254.
- G. Pólya and R. C. Read (1987). *Combinatorial Enumeration of Groups, Graphs, and Chemical Compounds*. New York: Springer-Verlag. Pólya's contribution translated from the German by Dorothee Aepli.
- G. Pólya, R. E. Tarjan, and D. R. Woods (1983). *Notes on Introductory Combinatorics*, Volume 4 of *Progress in Computer Science*. Boston, MA: Birkhäuser Boston Inc.
- A. Poquérusse and S. Alexiou (1999). *Fast analytic formulas for the modified Bessel functions of imaginary order for spectral line broadening calculations*. J. Quantit. Spec. and Rad. Trans. **62**(4), pp. 389–395.
- S. Porubský (1998). *Voronoi type congruences for Bernoulli numbers*. In P. Engel and H. Syta (Eds.), *Voronoi's Impact on Modern Science. Book I*. Kyiv: Institute of Mathematics of the National Academy of Sciences of Ukraine.
- T. Poston and I. Stewart (1978). *Catastrophe Theory and its Applications*. London: Pitman. Reprinted by Dover in 1996.
- J. L. Powell (1947). *Recurrence formulas for Coulomb wave functions*. Physical Rev. (2) **72**(7), pp. 626–627.
- M. J. D. Powell (1967). *On the maximum errors of polynomial approximations defined by interpolation and by least squares criteria*. Comput. J. **9**(4), pp. 404–407.
- K. Prachar (1957). *Primzahlverteilung*, Volume 91 of *Die Grundlehren der mathematischen Wissenschaften*. Berlin-Göttingen-Heidelberg: Springer-Verlag. Reprinted in 1978.
- S. Pratt (2007). *Comoving coordinate system for relativistic hydrodynamics*. Phys. Rev. C **75**, pp. (024907–1)–(024907–10).
- T. Prellberg and A. L. Owczarek (1995). *Stacking models of vesicles and compact clusters*. J. Statist. Phys. **80**(3–4), pp. 755–779.
- P. J. Prince (1975). *Algorithm 498: Airy functions using Chebyshev series approximations*. ACM Trans. Math. Software **1**(4), pp. 372–379.
- M. H. Protter and C. B. Morrey, Jr. (1991). *A First Course in Real Analysis* (2nd ed.). Undergraduate Texts in Mathematics. New York: Springer-Verlag.
- A. P. Prudnikov, Yu. A. Brychkov, and O. I. Marichev (1986a). *Integrals and Series: Elementary Functions, Vol. 1*. New York: Gordon & Breach Science Publishers. Translated from the Russian and with a preface by N. M. Queen. Table errata: Math. Comp. v. 66 (1997), no. 220, pp. 1765–1766, Math. Comp. v. 65 (1996), no. 215, pp. 1380–1381.
- A. P. Prudnikov, Yu. A. Brychkov, and O. I. Marichev (1986b). *Integrals and Series: Special Functions, Vol. 2*. New York: Gordon & Breach Science Publishers. A second edition was published in 1988. Table errata: Math. Comp. v. 65 (1996), no. 215, pp. 1382–1383.
- A. P. Prudnikov, Yu. A. Brychkov, and O. I. Marichev (1990). *Integrals and Series: More Special Functions, Vol. 3*. New York: Gordon and Breach Science Publishers. Translated from the Russian by G. G. Gould. Table erratum Math. Comp. v. 65 (1996), no. 215, p. 1384.
- A. P. Prudnikov, Yu. A. Brychkov, and O. I. Marichev (1992a). *Integrals and Series: Direct Laplace Transforms, Vol. 4*. New York: Gordon and Breach Science Publishers. Table erratum: Math. Comp. v. 66 (1997), no. 220, p. 1766.
- A. P. Prudnikov, Yu. A. Brychkov, and O. I. Marichev (1992b). *Integrals and Series: Inverse Laplace Transforms, Vol. 5*. New York: Gordon and Breach Science Publishers.
- J. D. Pryce (1993). *Numerical Solution of Sturm-Liouville Problems*. Monographs on Numerical Analysis. New York: The Clarendon Press, Oxford University Press.
- M. Puoskari (1988). *A method for computing Bessel function integrals*. J. Comput. Phys. **75**(2), pp. 334–344.
- F. Qi and J.-Q. Mei (1999). *Some inequalities of the incomplete gamma and related functions*. Z. Anal. Anwendungen **18**(3), pp. 793–799.
- H.-z. Qin and Y.-m. Lu (2008). *A note on an open problem about the first Painlevé equation*. Acta Math. Appl. Sin. Engl. Ser. **24**(2), pp. 203–210.
- S.-L. Qiu and J.-M. Shen (1997). *On two problems concerning means*. J. Hangzhou Inst. Elec. Engrg. **17**, pp. 1–7. In Chinese.
- S.-L. Qiu and M. K. Vamanamurthy (1996). *Sharp estimates for complete elliptic integrals*. SIAM J. Math. Anal. **27**(3), pp. 823–834.
- W.-Y. Qiu and R. Wong (2000). *Uniform asymptotic expansions of a double integral: Coalescence of two stationary points*. Proc. Roy. Soc. London Ser. A **456**, pp. 407–431.
- W.-Y. Qiu and R. Wong (2004). *Asymptotic expansion of the Krawtchouk polynomials and their zeros*. Comput. Methods Funct. Theory **4**(1), pp. 189–226.
- C. K. Qu and R. Wong (1999). *“Best possible” upper and lower bounds for the zeros of the Bessel function  $J_\nu(x)$* . Trans. Amer. Math. Soc. **351**(7), pp. 2833–2859.
- H. Rademacher (1938). *On the partition function  $p(n)$* . Proc. London Math. Soc. (2) **43**(4), pp. 241–254.
- H. Rademacher (1973). *Topics in Analytic Number Theory*. New York: Springer-Verlag. Edited by E. Grosswald, J. Lehner and M. Newman, Die Grundlehren der mathematischen Wissenschaften, Band 169.

- H. A. Ragheb, L. Shafai, and M. Hamid (1991). *Plane wave scattering by a conducting elliptic cylinder coated by a nonconfocal dielectric*. IEEE Trans. Antennas and Propagation **39**(2), pp. 218–223.
- M. Rahman (2001). *The Associated Classical Orthogonal Polynomials*. In *Special Functions 2000: Current Perspective and Future Directions (Tempe, AZ)*, Volume 30 of NATO Sci. Ser. II Math. Phys. Chem., pp. 255–279. Dordrecht: Kluwer Acad. Publ.
- E. M. Rains (1998). *Normal limit theorems for symmetric random matrices*. Probab. Theory Related Fields **112**(3), pp. 411–423.
- E. D. Rainville (1960). *Special Functions*. New York: The Macmillan Co.
- A. Ralston (1965). *Rational Chebyshev approximation by Remes' algorithms*. Numer. Math. **7**(4), pp. 322–330.
- S. Ramanujan (1921). *Congruence properties of partitions*. Math. Z. **9**(1-2), pp. 147–153.
- S. Ramanujan (1927). *Some properties of Bernoulli's numbers (J. Indian Math. Soc. 3 (1911), 219–234.)*. In *Collected Papers*. Cambridge University Press.
- S. Ramanujan (1962). *Collected Papers of Srinivasa Ramanujan*. New York: Chelsea Publishing Co. Reprinted with commentary by Bruce Berndt, AMS Chelsea Publishing Series, American Mathematical Society (2000).
- Ju. M. Rappoport (1979). *Tablitsy modifitsirovannykh funktsii Besselya  $K_{\frac{1}{2}+i\beta}(x)$* . Moscow: "Nauka". In Russian. Translated title: *Tables of Modified Bessel Functions  $K_{\frac{1}{2}+i\beta}(x)$* .
- H. E. Rauch and A. Lebowitz (1973). *Elliptic Functions, Theta Functions, and Riemann Surfaces*. Baltimore, MD: The Williams & Wilkins Co.
- J. Raynal (1979). *On the definition and properties of generalized 6-j symbols*. J. Math. Phys. **20**(12), pp. 2398–2415.
- M. Razaz and J. L. Schonfelder (1980). *High precision Chebyshev expansions for Airy functions and their derivatives*. Technical report, University of Birmingham Computer Centre.
- M. Razaz and J. L. Schonfelder (1981). *Remark on Algorithm 498: Airy functions using Chebyshev series approximations*. ACM Trans. Math. Software **7**(3), pp. 404–405.
- I. S. Reed, D. W. Tufts, X. Yu, T. K. Truong, M. T. Shih, and X. Yin (1990). *Fourier analysis and signal processing by use of the Möbius inversion formula*. IEEE Trans. Acoustics, Speech, Signal Processing **38**, pp. 458–470.
- W. H. Reid (1972). *Composite approximations to the solutions of the Orr-Sommerfeld equation*. Studies in Appl. Math. **51**, pp. 341–368.
- W. H. Reid (1974a). *Uniform asymptotic approximations to the solutions of the Orr-Sommerfeld equation. I. Plane Couette flow*. Studies in Appl. Math. **53**, pp. 91–110.
- W. H. Reid (1974b). *Uniform asymptotic approximations to the solutions of the Orr-Sommerfeld equation. II. The general theory*. Studies in Appl. Math. **53**, pp. 217–224.
- W. H. Reid (1995). *Integral representations for products of Airy functions*. Z. Angew. Math. Phys. **46**(2), pp. 159–170.
- W. H. Reid (1997a). *Integral representations for products of Airy functions. II. Cubic products*. Z. Angew. Math. Phys. **48**(4), pp. 646–655.
- W. H. Reid (1997b). *Integral representations for products of Airy functions. III. Quartic products*. Z. Angew. Math. Phys. **48**(4), pp. 656–664.
- K.-D. Reinsch and W. Raab (2000). *Elliptic Integrals of the First and Second Kind – Comparison of Bulirsch's and Carlson's Algorithms for Numerical Calculation*. In C. Dunkl, M. Ismail, and R. Wong (Eds.), *Special Functions (Hong Kong, 1999)*, pp. 293–308. River Edge, NJ-Singapore 912805: World Sci. Publishing.
- F. E. Relton (1965). *Applied Bessel Functions*. New York: Dover Publications Inc. Reprint of original Blackie & Son Limited, London, 1946.
- G. F. Remenets (1973). *Computation of Hankel (Bessel) functions of complex index and argument by numerical integration of a Schläfli contour integral*. Ž. Vyčisl. Mat. i Mat. Fiz. **13**, pp. 1415–1424, 1636. English translation in U.S.S.R. Computational Math. and Math. Phys. **13**(6), pp. 58–67.
- E. Y. Remez (1957). *General Computation Methods of Chebyshev Approximation. The Problems with Linear Real Parameters*. Kiev: Publishing House of the Academy of Science of the Ukrainian SSR. English translation, AEC-TR-4491, United States Atomic Energy Commission.
- P. Ribenboim (1979). *13 Lectures on Fermat's Last Theorem*. New York: Springer-Verlag.
- S. O. Rice (1954). *Diffraction of plane radio waves by a parabolic cylinder. Calculation of shadows behind hills*. Bell System Tech. J. **33**, pp. 417–504.
- D. St. P. Richards (Ed.) (1992). *Hypergeometric Functions on Domains of Positivity, Jack Polynomials, and Applications*, Volume 138 of *Contemporary Mathematics*, Providence, RI. American Mathematical Society.
- D. St. P. Richards (2004). *Total positivity properties of generalized hypergeometric functions of matrix argument*. J. Statist. Phys. **116**(1-4), pp. 907–922.
- È. Y. Riekstynš (1991). *Asymptotics and Bounds of the Roots of Equations (Russian)*. Riga: Zinatne.

- B. Riemann (1851). *Grundlagen für eine allgemeine Theorie der Functionen einer veränderlichen complexen Grösse*. Inauguraldissertation, Göttingen.
- B. Riemann (1859). *Über die Anzahl der Primzahlen unter einer gegebenen Grösse*. Monats. Berlin Akad. November 1859, pp. 671–680. Reprinted in *Gesammelte Mathematische Werke*, pp. 145–155, published by Dover Publications, New York, N.Y. 1953.
- B. Riemann (1899). *Elliptische Functionen*. Leipzig: Teubner. Based on notes of lectures by B. Riemann edited and published by H. Stahl. Reprinted by UMI Books on Demand (Ann Arbor, MI, USA).
- J. Riordan (1958). *An Introduction to Combinatorial Analysis*. New York: John Wiley & Sons Inc. Reprinted by Princeton University Press, Princeton, NJ, 1980 and reissued by Dover Publications Inc., New York, 2002.
- J. Riordan (1979). *Combinatorial Identities*. Huntington, NY: Robert E. Krieger Publishing Co. Reprint of the 1968 original with corrections.
- S. Ritter (1998). *On the computation of Lamé functions, of eigenvalues and eigenfunctions of some potential operators*. *Z. Angew. Math. Mech.* **78**(1), pp. 66–72.
- T. J. Rivlin (1969). *An Introduction to the Approximation of Functions*. Waltham, MA-Toronto-London: Blaisdell Publishing Co. (Ginn and Co.). Corrected reprint by Dover Publications, Inc., New York, 1981.
- L. Robin (1957). *Fonctions sphériques de Legendre et fonctions sphéroïdales. Tome I*. Paris: Gauthier-Villars. Préface de H. Villat.
- L. Robin (1958). *Fonctions sphériques de Legendre et fonctions sphéroïdales. Tome II*. Paris: Gauthier-Villars.
- L. Robin (1959). *Fonctions sphériques de Legendre et fonctions sphéroïdales. Tome III*. Collection Technique et Scientifique du C. N. E. T. Gauthier-Villars, Paris.
- H. P. Robinson (1972). *Roots of  $\tan x = x$* . 10 typewritten pages deposited in the UMT file at Lawrence Berkeley Laboratory, University of California, Berkeley, CA.
- M. Robnik (1980). *An extremum property of the  $n$ -dimensional sphere*. *J. Phys. A* **13**(10), pp. L349–L351.
- D. L. Rod and B. D. Sleeman (1995). *Complexity in spatio-temporal dynamics*. *Proc. Roy. Soc. Edinburgh Sect. A* **125**(5), pp. 959–974.
- M. D. Rogers (2005). *Partial fractions expansions and identities for products of Bessel functions*. *J. Math. Phys.* **46**(4), pp. 043509–1–043509–18.
- A. Ronveaux (Ed.) (1995). *Heun's Differential Equations*. New York: The Clarendon Press Oxford University Press.
- C. C. J. Roothaan and S.-T. Lai (1997). *Calculation of  $3n-j$  symbols by Labarthe's method*. *International Journal of Quantum Chemistry* **63**(1), pp. 57–64.
- G. M. Roper (1951). *Some Applications of the Lamé Function Solutions of the Linearised Supersonic Flow Equations*. Technical Reports and Memoranda 2865, Aeronautical Research Council (Great Britain). Reprinted by Her Majesty's Stationery Office, London, 1962.
- R. R. Rosales (1978). *The similarity solution for the Korteweg-de Vries equation and the related Painlevé transcendent*. *Proc. Roy. Soc. London Ser. A* **361**, pp. 265–275.
- K. H. Rosen (2004). *Elementary Number Theory and its Applications* (5th ed.). Reading, MA: Addison-Wesley.
- K. H. Rosen, J. G. Michaels, J. L. Gross, J. W. Grossman, and D. R. Shier (Eds.) (2000). *Handbook of Discrete and Combinatorial Mathematics*. Boca Raton, FL: CRC Press.
- P. A. Rosenberg and L. P. McNamee (1976). *Precision controlled trigonometric algorithms*. *Appl. Math. Comput.* **2**(4), pp. 335–352.
- H. Rosengren (1999). *Another proof of the triple sum formula for Wigner  $9j$ -symbols*. *J. Math. Phys.* **40**(12), pp. 6689–6691.
- H. Rosengren (2004). *Elliptic hypergeometric series on root systems*. *Adv. Math.* **181**(2), pp. 417–447.
- J. B. Rosser (1939). *The  $n$ -th prime is greater than  $n \log n$* . *Proceedings of the London Mathematical Society* **45**, pp. 21–44.
- G.-C. Rota (1964). *On the foundations of combinatorial theory. I. Theory of Möbius functions*. *Z. Wahrscheinlichkeitstheorie und Verw. Gebiete* **2**, pp. 340–368.
- M. Rotenberg, R. Bivins, N. Metropolis, and J. K. Wooten, Jr. (1959). *The  $3-j$  and  $6-j$  Symbols*. Cambridge, MA: The Technology Press, MIT.
- M. Rothman (1954a). *The problem of an infinite plate under an inclined loading, with tables of the integrals of  $Ai(\pm x)$  and  $Bi(\pm x)$* . *Quart. J. Mech. Appl. Math.* **7**(1), pp. 1–7.
- M. Rothman (1954b). *Tables of the integrals and differential coefficients of  $Gi(+x)$  and  $Hi(-x)$* . *Quart. J. Mech. Appl. Math.* **7**(3), pp. 379–384.
- K. Rottbrand (2000). *Finite-sum rules for Macdonald's functions and Hankel's symbols*. *Integral Transform. Spec. Funct.* **10**(2), pp. 115–124.
- D. H. Rouvray (1995). *Combinatorics in Chemistry*. In R. L. Graham, M. Grötschel, and L. Lovász (Eds.), *Handbook of Combinatorics, Vol. 2*, pp. 1955–1981. Amsterdam: Elsevier.
- W. Rudin (1973). *Functional Analysis*. New York: McGraw-Hill Book Co. McGraw-Hill Series in Higher Mathematics.



- W. Rudin (1976). *Principles of Mathematical Analysis* (3rd ed.). New York: McGraw-Hill Book Co. International Series in Pure and Applied Mathematics.
- H.-J. Runckel (1971). *On the zeros of the hypergeometric function*. Math. Ann. **191**(1), pp. 53–58.
- J. Rushchitsky and S. Rushchitska (2000). *On Simple Waves with Profiles in the form of some Special Functions—Chebyshev-Hermite, Mathieu, Whittaker—in Two-phase Media*. In *Differential Operators and Related Topics, Vol. I (Odessa, 1997)*, Volume 117 of *Operator Theory: Advances and Applications*, pp. 313–322. Basel-Berlin-Boston: Birkhäuser.
- A. Russell (1909). *The effective resistance and inductance of a concentric main, and methods of computing the ber and bei and allied functions*. Philos. Mag. (6) **17**, pp. 524–552.
- H. Rutishauser (1957). *Der Quotienten-Differenzen-Algorithmus*. Mitteilungen aus dem Institut für Angewandte Mathematik an der Eidgenössischen Technischen Hochschule in Zürich, No. 7. Basel/Stuttgart: Birkhäuser.
- L. Saalschütz (1893). *Vorlesungen über die Bernoullischen Zahlen, ihren Zusammenhang mit den Secanten-Coefficienten und ihre wichtigeren Anwendungen*. Berlin: Springer-Verlag.
- A. Sachse (1882). *Über die Darstellung der Bernoullischen und Eulerschen Zahlen durch Determinanten*. Archiv für Mathematik und Physik **68**, pp. 427–432.
- B. E. Sagan (2001). *The Symmetric Group: Representations, Combinatorial Algorithms, and Symmetric Functions* (2nd ed.), Volume 203 of *Graduate Texts in Mathematics*. New York: Springer-Verlag. First edition published by Wadsworth & Brooks/Cole Advanced Books & Software, 1991.
- R. P. Sagar (1991a). *A Gaussian quadrature for the calculation of generalized Fermi-Dirac integrals*. Comput. Phys. Comm. **66**(2-3), pp. 271–275.
- R. P. Sagar (1991b). *On the evaluation of the Fermi-Dirac integrals*. Astrophys. J. **376**(1, part 1), pp. 364–366.
- H. Sakai (2001). *Rational surfaces associated with affine root systems and geometry of the Painlevé equations*. Comm. Math. Phys. **220**(1), pp. 165–229.
- K. L. Sala (1989). *Transformations of the Jacobian amplitude function and its calculation via the arithmetic-geometric mean*. SIAM J. Math. Anal. **20**(6), pp. 1514–1528.
- L. Z. Salchev and V. B. Popov (1976). *A property of the zeros of cross-product Bessel functions of different orders*. Z. angew. Math. Mech. **56**(2), pp. 120–121.
- H. E. Salzer (1955). *Orthogonal polynomials arising in the numerical evaluation of inverse Laplace transforms*. Math. Tables Aids Comput. **9**(52), pp. 164–177.
- P. Sarnak (1999). *Quantum Chaos, Symmetry and Zeta Functions. Lecture I, Quantum Chaos*. In R. Bott (Ed.), *Current Developments in Mathematics, 1997 (Cambridge, MA)*, pp. 127–144. Boston, MA: International Press.
- T. Schäfer and E. V. Shuryak (1998). *Instantons in QCD*. Rev. Modern Phys. **70**(2), pp. 323–425.
- F. W. Schäfke (1960). *Reihenentwicklungen analytischer Funktionen nach Biorthogonalsystemen spezieller Funktionen. I*. Math. Z. **74**, pp. 436–470.
- F. W. Schäfke (1961a). *Ein Verfahren zur Berechnung des charakteristischen Exponenten der Mathieuschen Differentialgleichung I*. Numer. Math. **3**(1), pp. 30–38.
- F. W. Schäfke (1961b). *Reihenentwicklungen analytischer Funktionen nach Biorthogonalsystemen spezieller Funktionen. II*. Math. Z. **75**, pp. 154–191.
- F. W. Schäfke (1983). *Über einige Integrale mit Produkten von Mathieu-Funktionen*. Arch. Math. (Basel) **41**(2), pp. 152–162.
- F. W. Schäfke and A. Finsterer (1990). *On Lindelöf's error bound for Stirling's series*. J. Reine Angew. Math. **404**, pp. 135–139.
- F. W. Schäfke and H. Groh (1962). *Zur Berechnung der Eigenwerte der Sphäroiddifferentialgleichung*. Numer. Math. **4**, pp. 310–312.
- C. W. Schelin (1983). *Calculator function approximation*. Amer. Math. Monthly **90**(5), pp. 317–325.
- J. L. Schiff (1999). *The Laplace Transform: Theory and Applications*. Undergraduate Texts in Mathematics. New York: Springer-Verlag.
- T. Schmelzer and L. N. Trefethen (2007). *Computing the gamma function using contour integrals and rational approximations*. SIAM J. Numer. Anal. **45**(2), pp. 558–571.
- D. Schmidt (1979). *Die Lösung der linearen Differentialgleichung 2. Ordnung um zwei einfache Singularitäten durch Reihen nach hypergeometrischen Funktionen*. J. Reine Angew. Math. **309**, pp. 127–148.
- D. Schmidt and G. Wolf (1979). *A method of generating integral relations by the simultaneous separability of generalized Schrödinger equations*. SIAM J. Math. Anal. **10**(4), pp. 823–838.
- I. J. Schoenberg (1971). *Norm inequalities for a certain class of  $C^\infty$  functions*. Israel J. Math. **10**, pp. 364–372.
- I. J. Schoenberg (1973). *Cardinal Spline Interpolation*. Philadelphia, PA: Society for Industrial and Applied Mathematics. Conference Board of the Mathematical Sciences Regional Conference Series in Applied Mathematics, No. 12.

- L. Schoenfeld (1976). *Sharper bounds for the Chebyshev functions  $\theta(x)$  and  $\psi(x)$ . II.* Math. Comp. **30**(134), pp. 337–360. For corrigendum see same journal v. 30 (1976), no. 136, p. 900.
- J. L. Schonfelder (1978). *Chebyshev expansions for the error and related functions.* Math. Comp. **32**(144), pp. 1232–1240.
- J. L. Schonfelder (1980). *Very high accuracy Chebyshev expansions for the basic trigonometric functions.* Math. Comp. **34**(149), pp. 237–244.
- F. Schottky (1903). *Über die Moduln der Thetafunktionen.* Acta Math. **27**(1), pp. 235–288.
- M. R. Schroeder (2006). *Number Theory in Science and Communication: With Applications in Cryptography, Physics, Digital Information, Computing, and Self-Similarity* (4th ed.). Berlin: Springer-Verlag. Volume 7 in Springer Series in Information Sciences.
- L. S. Schulman (1981). *Techniques and Applications of Path Integration.* New York: John Wiley & Sons Inc. Reprinted by Dover in 2005.
- K. Schulten and R. G. Gordon (1975a). *Exact recursive evaluation of  $3j$ - and  $6j$ -coefficients for quantum-mechanical coupling of angular momenta.* J. Mathematical Phys. **16**(10), pp. 1961–1970.
- K. Schulten and R. G. Gordon (1975b). *Semiclassical approximations to  $3j$ - and  $6j$ -coefficients for quantum-mechanical coupling of angular momenta.* J. Mathematical Phys. **16**(10), pp. 1971–1988.
- Z. Schulten, D. G. M. Anderson, and R. G. Gordon (1979). *An algorithm for the evaluation of the complex Airy functions.* J. Comput. Phys. **31**(1), pp. 60–75.
- L. L. Schumaker (1981). *Spline Functions: Basic Theory.* New York: John Wiley & Sons Inc. Pure and Applied Mathematics, A Wiley-Interscience Publication. Reprinted by Robert E. Krieger Publishing Co. Inc., 1993.
- R. Schürer (2004). *Adaptive Quasi-Monte Carlo Integration Based on MISER and VEGAS.* In *Monte Carlo and Quasi-Monte Carlo Methods 2002*, pp. 393–406. Berlin: Springer.
- I. J. Schwatt (1962). *An Introduction to the Operations with Series* (2nd ed.). New York: Chelsea Publishing Co. This is a reprint, with corrections, of the first edition [University of Pennsylvania Press, Philadelphia, Pa., 1924].
- R. S. Scorer (1950). *Numerical evaluation of integrals of the form  $I = \int_{x_1}^{x_2} f(x)e^{i\phi(x)} dx$  and the tabulation of the function  $\text{Gi}(z) = (1/\pi) \int_0^\infty \sin(uz + \frac{1}{3}u^3) du$ .* Quart. J. Mech. Appl. Math. **3**(1), pp. 107–112.
- J. B. Seaborn (1991). *Hypergeometric Functions and Their Applications*, Volume 8 of *Texts in Applied Mathematics*. New York: Springer-Verlag.
- M. J. Seaton (1982). *Coulomb functions analytic in the energy.* Comput. Phys. Comm. **25**(1), pp. 87–95. Double-precision Fortran code.
- M. J. Seaton (1983). *Quantum defect theory.* Rep. Prog. Phys. **46**(2), pp. 167–257.
- M. J. Seaton (1984). *The accuracy of iterated JWBK approximations for Coulomb radial functions.* Comput. Phys. Comm. **32**(2), pp. 115–119.
- M. J. Seaton (2002). *Coulomb functions for attractive and repulsive potentials and for positive and negative energies.* Comput. Phys. Comm. **146**(2), pp. 225–249.
- M. J. Seaton and G. Peach (1962). *The determination of phases of wave functions.* Proc. Phys. Soc. **79**(6), pp. 1296–1297.
- J. D. Secada (1999). *Numerical evaluation of the Hankel transform.* Comput. Phys. Comm. **116**(2-3), pp. 278–294.
- H. Segur and M. J. Ablowitz (1981). *Asymptotic solutions of nonlinear evolution equations and a Painlevé transcendent.* Phys. D **3**(1-2), pp. 165–184.
- J. Segura (1998). *A global Newton method for the zeros of cylinder functions.* Numer. Algorithms **18**(3-4), pp. 259–276.
- J. Segura (2001). *Bounds on differences of adjacent zeros of Bessel functions and iterative relations between consecutive zeros.* Math. Comp. **70**(235), pp. 1205–1220.
- J. Segura (2002). *The zeros of special functions from a fixed point method.* SIAM J. Numer. Anal. **40**(1), pp. 114–133.
- J. Segura and A. Gil (1999). *Evaluation of associated Legendre functions off the cut and parabolic cylinder functions.* Electron. Trans. Numer. Anal. **9**, pp. 137–146. Orthogonal polynomials: numerical and symbolic algorithms (Leganés, 1998).
- N. Seiberg and D. Shih (2005). *Flux vacua and branes of the minimal superstring.* J. High Energy Phys. Electronic. E-print number: hep-th/0412315. 38 pp.
- R. G. Selfridge and J. E. Maxfield (1958). *A Table of the Incomplete Elliptic Integral of the Third Kind.* New York: Dover Publications Inc.
- J.-P. Serre (1973). *A Course in Arithmetic*, Volume 7 of *Graduate Texts in Mathematics*. New York: Springer-Verlag. Translated from the French.
- R. Shail (1978). *Lamé polynomial solutions to some elliptic crack and punch problems.* Internat. J. Engrg. Sci. **16**(8), pp. 551–563.
- R. Shail (1980). *On integral representations for Lamé and other special functions.* SIAM J. Math. Anal. **11**(4), pp. 702–723.

- H. Shanker (1939). *On the expansion of the parabolic cylinder function in a series of the product of two parabolic cylinder functions*. J. Indian Math. Soc. (N. S.) **3**, pp. 226–230.
- H. Shanker (1940a). *On integral representation of Weber's parabolic cylinder function and its expansion into an infinite series*. J. Indian Math. Soc. (N. S.) **4**, pp. 34–38.
- H. Shanker (1940b). *On certain integrals and expansions involving Weber's parabolic cylinder functions*. J. Indian Math. Soc. (N. S.) **4**, pp. 158–166.
- H. Shanker (1940c). *On the expansion of the product of two parabolic cylinder functions of non integral order*. Proc. Benares Math. Soc. (N. S.) **2**, pp. 61–68.
- D. Shanks (1955). *Non-linear transformations of divergent and slowly convergent sequences*. J. Math. Phys. **34**, pp. 1–42.
- G. Shanmugam (1978). *Parabolic Cylinder Functions and their Application in Symmetric Two-centre Shell Model*. In *Proceedings of the Conference on Mathematical Analysis and its Applications (Inst. Engrs., Mysore, 1977)*, Volume 91 of *Matscience Rep.*, Aarhus, pp. P81–P89. Aarhus Univ.
- J. Shao and P. Hänggi (1998). *Decoherent dynamics of a two-level system coupled to a sea of spins*. Phys. Rev. Lett. **81**(26), pp. 5710–5713.
- O. A. Sharafeddin, H. F. Bowen, D. J. Kouri, and D. K. Hoffman (1992). *Numerical evaluation of spherical Bessel transforms via fast Fourier transforms*. J. Comput. Phys. **100**(2), pp. 294–296.
- A. Sharples (1967). *Uniform asymptotic forms of modified Mathieu functions*. Quart. J. Mech. Appl. Math. **20**(3), pp. 365–380.
- A. Sharples (1971). *Uniform asymptotic expansions of modified Mathieu functions*. J. Reine Angew. Math. **247**, pp. 1–17.
- I. Shavitt (1963). *The Gaussian Function in Calculations of Statistical Mechanics and Quantum Mechanics*. In B. Alder, S. Fernbach, and M. Rotenberg (Eds.), *Methods in Computational Physics: Advances in Research and Applications*, Volume 2, pp. 1–45. New York: Academic Press.
- I. Shavitt and M. Karplus (1965). *Gaussian-transform method for molecular integrals. I. Formulation for energy integrals*. J. Chem. Phys. **43**(2), pp. 398–414.
- D. C. Shaw (1985). *Perturbational results for diffraction of water-waves by nearly-vertical barriers*. IMA J. Appl. Math. **34**(1), pp. 99–117.
- N. T. Shawagfeh (1992). *The Laplace transforms of products of Airy functions*. Dirāsāt Ser. B Pure Appl. Sci. **19**(2), pp. 7–11.
- L. Shen (1981). *The elliptical microstrip antenna with circular polarization*. IEEE Trans. Antennas and Propagation **29**(1), pp. 90–94.
- L.-C. Shen (1998). *On an identity of Ramanujan based on the hypergeometric series  ${}_2F_1\left(\frac{1}{3}, \frac{2}{3}; \frac{1}{2}; x\right)$* . J. Number Theory **69**(2), pp. 125–134.
- M. M. Shepherd and J. G. Laframboise (1981). *Chebyshev approximation of  $(1 + 2x) \exp(x^2) \operatorname{erfc} x$  in  $0 \leq x < \infty$* . Math. Comp. **36**(153), pp. 249–253.
- M. E. Sherry (1959). *The zeros and maxima of the Airy function and its first derivative to 25 significant figures*. Report afrc-tr-59-135, astia document no. ad214568, Air Research and Development Command, U.S. Air Force, Bedford, MA. Available from U.S. Department of Commerce, Office of Technical Services, Washington, D.C.
- G. Shimura (1982). *Confluent hypergeometric functions on tube domains*. Math. Ann. **260**(3), pp. 269–302.
- T. Shiota (1986). *Characterization of Jacobian varieties in terms of soliton equations*. Invent. Math. **83**(2), pp. 333–382.
- R. B. Shirts (1993). *The computation of eigenvalues and solutions of Mathieu's differential equation for noninteger order*. ACM Trans. Math. Software **19**(3), pp. 377–390.
- P. N. Shivakumar and R. Wong (1988). *Error bounds for a uniform asymptotic expansion of the Legendre function  $P_n^{-m}(\cosh z)$* . Quart. Appl. Math. **46**(3), pp. 473–488.
- P. N. Shivakumar and J. Xue (1999). *On the double points of a Mathieu equation*. J. Comput. Appl. Math. **107**(1), pp. 111–125.
- B. W. Shore and D. H. Menzel (1968). *Principles of Atomic Spectra*. New York: John Wiley & Sons Ltd.
- A. Sidi (1997). *Computation of infinite integrals involving Bessel functions of arbitrary order by the  $\bar{D}$ -transformation*. J. Comput. Appl. Math. **78**(1), pp. 125–130.
- A. Sidi (2003). *Practical Extrapolation Methods: Theory and Applications*, Volume 10 of *Cambridge Monographs on Applied and Computational Mathematics*. Cambridge: Cambridge University Press.
- A. Sidi (2004). *Euler-Maclaurin expansions for integrals with endpoint singularities: A new perspective*. Numer. Math. **98**(2), pp. 371–387.
- C. L. Siegel (1935). *Über die analytische Theorie der quadratischen Formen*. Ann. of Math. (2) **36**(3), pp. 527–606.
- C. L. Siegel (1971). *Topics in Complex Function Theory. Vol. II: Automorphic Functions and Abelian Integrals*. Interscience Tracts in Pure and Applied Mathematics, No. 25. New York: Wiley-Interscience [John Wiley & Sons

- Inc.]. Translated from the original German by A. Shenitzer and M. Tretkoff. Reprinted by John Wiley & Sons, New York, 1988.
- C. L. Siegel (1973). *Topics in Complex Function Theory. Vol. III: Abelian Functions and Modular Functions of Several Variables*. Interscience Tracts in Pure and Applied Mathematics, No. 25. New York-London-Sydney: Wiley-Interscience, [John Wiley & Sons, Inc]. Translated from the original German by E. Gottschling and M. Tretkoff. Reprinted by John Wiley & Sons, New York, 1989.
- C. L. Siegel (1988). *Topics in Complex Function Theory. Vol. I: Elliptic Functions and Uniformization Theory*. Wiley Classics Library. New York: John Wiley & Sons Inc. Translated from the German by A. Shenitzer and D. Solitar. Reprint of the 1969 edition, a Wiley-Interscience Publication.
- K. M. Siegel (1953). *An inequality involving Bessel functions of argument nearly equal to their order*. Proc. Amer. Math. Soc. **4**(6), pp. 858–859.
- K. M. Siegel and F. B. Sleator (1954). *Inequalities involving cylindrical functions of nearly equal argument and order*. Proc. Amer. Math. Soc. **5**(3), pp. 337–344.
- C. E. Siewert and E. E. Burniston (1973). *Exact analytical solutions of  $ze^z = a$* . J. Math. Anal. Appl. **43**(3), pp. 626–632.
- J. H. Silverman and J. Tate (1992). *Rational Points on Elliptic Curves*. Undergraduate Texts in Mathematics. New York: Springer-Verlag.
- R. A. Silverman (1967). *Introductory Complex Analysis*. Englewood Cliffs, N.J.: Prentice-Hall, Inc. Reprinted by Dover Publications Inc. 1972.
- G. F. Simmons (1972). *Differential Equations with Applications and Historical Notes*. New York: McGraw-Hill Book Co. International Series in Pure and Applied Mathematics.
- B. Simon (1982). *Large orders and summability of eigenvalue perturbation theory: A mathematical overview*. Int. J. Quantum Chem. **21**, pp. 3–25.
- B. Simon (2005a). *Orthogonal Polynomials on the Unit Circle. Part 1: Classical Theory*, Volume 54 of *American Mathematical Society Colloquium Publications*. Providence, RI: American Mathematical Society.
- B. Simon (2005b). *Orthogonal Polynomials on the Unit Circle. Part 2: Spectral Theory*, Volume 54 of *American Mathematical Society Colloquium Publications*. Providence, RI: American Mathematical Society.
- R. Sips (1949). *Représentation asymptotique des fonctions de Mathieu et des fonctions d'onde sphéroïdales*. Trans. Amer. Math. Soc. **66**(1), pp. 93–134.
- R. Sips (1959). *Représentation asymptotique des fonctions de Mathieu et des fonctions sphéroïdales. II*. Trans. Amer. Math. Soc. **90**(2), pp. 340–368.
- R. Sips (1965). *Représentation asymptotique de la solution générale de l'équation de Mathieu-Hill*. Acad. Roy. Belg. Bull. Cl. Sci. (5) **51**(11), pp. 1415–1446.
- R. Sips (1967). *Répartition du courant alternatif dans un conducteur cylindrique de section elliptique*. Acad. Roy. Belg. Bull. Cl. Sci. (5) **53**(8), pp. 861–878.
- R. Sips (1970). *Quelques intégrales définies discontinues contenant des fonctions de Mathieu*. Acad. Roy. Belg. Bull. Cl. Sci. (5) **56**(5), pp. 475–491.
- R. Sitaramachandrarao and B. Davis (1986). *Some identities involving the Riemann zeta function. II*. Indian J. Pure Appl. Math. **17**(10), pp. 1175–1186.
- S. L. Skorokhodov (1985). *On the calculation of complex zeros of the modified Bessel function of the second kind*. Dokl. Akad. Nauk SSSR **280**(2), pp. 296–299. English translation in Soviet Math. Dokl. **31**(1), pp. 78–81.
- H. Skovgaard (1954). *On inequalities of the Turán type*. Math. Scand. **2**, pp. 65–73.
- H. Skovgaard (1966). *Uniform Asymptotic Expansions of Confluent Hypergeometric Functions and Whittaker Functions*, Volume 1965 of *Doctoral dissertation, University of Copenhagen*. Copenhagen: Jul. Gjellerups Forlag.
- J. C. Slater (1942). *Microwave Transmission*. New York: McGraw-Hill Book Co. Reprinted by Dover Publications Inc., New York, 1960.
- L. J. Slater (1960). *Confluent Hypergeometric Functions*. Cambridge-New York: Cambridge University Press. Table errata: Math. Comp. v. 30 (1976), no. 135, 677–678.
- L. J. Slater (1966). *Generalized Hypergeometric Functions*. Cambridge: Cambridge University Press.
- D. V. Slavić (1974). *Complements to asymptotic development of sine cosine integrals, and auxiliary functions*. Univ. Beograd. Publ. Elektrotehn. Fak., Ser. Mat. Fiz. **461–497**, pp. 185–191.
- I. Sh. Slavutskii (1995). *Staudt and arithmetical properties of Bernoulli numbers*. Historia Sci. (2) **5**(1), pp. 69–74.
- I. Sh. Slavutskii (1999). *About von Staudt congruences for Bernoulli numbers*. Comment. Math. Univ. St. Paul. **48**(2), pp. 137–144.
- I. Sh. Slavutskii (2000). *On the generalized Bernoulli numbers that belong to unequal characters*. Rev. Mat. Iberoamericana **16**(3), pp. 459–475.
- S. Yu. Slavyanov (1996). *Asymptotic Solutions of the One-dimensional Schrödinger Equation*. Providence, RI: American Mathematical Society. Translated from the 1990 Russian original by Vadim Khidekel.

- S. Yu. Slavyanov and W. Lay (2000). *Special Functions: A Unified Theory Based on Singularities*. Oxford Mathematical Monographs. Oxford: Oxford University Press.
- S. Yu. Slavyanov and N. A. Veshev (1997). *Structure of avoided crossings for eigenvalues related to equations of Heun's class*. J. Phys. A **30**(2), pp. 673–687.
- B. D. Sleeman (1966a). *The expansion of Lamé functions into series of associated Legendre functions of the second kind*. Proc. Cambridge Philos. Soc. **62**, pp. 441–452.
- B. D. Sleeman (1966b). *Some Boundary Value Problems Associated with the Heun Equation*. Ph. D. thesis, London University. Available from the library, University of Surrey, UK.
- B. D. Sleeman (1968a). *Integral equations and relations for Lamé functions and ellipsoidal wave functions*. Proc. Cambridge Philos. Soc. **64**, pp. 113–126.
- B. D. Sleeman (1968b). *On parabolic cylinder functions*. J. Inst. Math. Appl. **4**(1), pp. 106–112.
- B. D. Sleeman (1969). *Non-linear integral equations for Heun functions*. Proc. Edinburgh Math. Soc. (2) **16**, pp. 281–289.
- D. Slepian (1964). *Prolate spheroidal wave functions, Fourier analysis and uncertainty. IV. Extensions to many dimensions; generalized prolate spheroidal functions*. Bell System Tech. J. **43**, pp. 3009–3057.
- D. Slepian (1983). *Some comments on Fourier analysis, uncertainty and modeling*. SIAM Rev. **25**(3), pp. 379–393.
- D. Slepian and H. O. Pollak (1961). *Prolate spheroidal wave functions, Fourier analysis and uncertainty. I*. Bell System Tech. J. **40**, pp. 43–63.
- N. J. A. Sloane (2003). *The On-Line Encyclopedia of Integer Sequences*. Notices Amer. Math. Soc. **50**(8), pp. 912–915.
- W. M. Smart (1962). *Text-book on Spherical Astronomy*. Fifth edition. Cambridge: Cambridge University Press.
- A. D. Smirnov (1960). *Tables of Airy Functions and Special Confluent Hypergeometric Functions*. New York: Pergamon Press. Translated from the Russian by D. G. Fry.
- A. O. Smirnov (2002). *Elliptic Solitons and Heun's Equation*. In V. B. Kuznetsov (Ed.), *The Kowalevski Property (Leeds, UK, 2000)*, Volume 32 of CRM Proc. Lecture Notes, pp. 287–306. Providence, RI: Amer. Math. Soc.
- V. I. Smirnov (1996). *Izbrannyye Trudy. Analiticheskaya teoriya obyknovennykh differentsialnykh uravnenii*. St. Petersburg: Izdatel' stvo Sankt-Peterburgskogo Universiteta. In Russian. Translated title: *Selected Works. Analytic Theory of Ordinary Differential Equations*.
- D. M. Smith (1989). *Efficient multiple-precision evaluation of elementary functions*. Math. Comp. **52**(185), pp. 131–134.
- D. R. Smith (1986). *Liouville-Green approximations via the Riccati transformation*. J. Math. Anal. Appl. **116**(1), pp. 147–165.
- D. R. Smith (1990). *A Riccati approach to the Airy equation*. In R. Wong (Ed.), *Asymptotic and computational analysis (Winnipeg, MB, 1989)*, pp. 403–415. New York: Marcel Dekker.
- F. C. Smith (1939a). *On the logarithmic solutions of the generalized hypergeometric equation when  $p = q + 1$* . Bull. Amer. Math. Soc. **45**(8), pp. 629–636.
- F. C. Smith (1939b). *Relations among the fundamental solutions of the generalized hypergeometric equation when  $p = q + 1$ . II. Logarithmic cases*. Bull. Amer. Math. Soc. **45**(12), pp. 927–935.
- G. S. Smith (1997). *An Introduction to Classical Electromagnetic Radiation*. Cambridge-New York: Cambridge University Press.
- I. N. Sneddon (1966). *Mixed Boundary Value Problems in Potential Theory*. Amsterdam: North-Holland Publishing Co.
- I. N. Sneddon (1972). *The Use of Integral Transforms*. New York: McGraw-Hill.
- C. Snow (1952). *Hypergeometric and Legendre Functions with Applications to Integral Equations of Potential Theory*. National Bureau of Standards Applied Mathematics Series, No. 19. Washington, D. C.: U. S. Government Printing Office.
- W. V. Snyder (1993). *Algorithm 723: Fresnel integrals*. ACM Trans. Math. Software **19**(4), pp. 452–456. Single- and double-precision Fortran, maximum accuracy 16D. For remarks see same journal v. 22 (1996), p. 498–500 and v. 26 (2000), p. 617.
- I. I. Sobelman (1992). *Atomic Spectra and Radiative Transitions* (2nd ed.). Berlin: Springer-Verlag. A second printing with corrections was published in 1996.
- A. Sommerfeld (1928). *Atombau und Spektrallinien*. Braunschweig: Vieweg. English translation: *Wave Mechanics* published by Methuen, London, 1930.
- K. Soni (1980). *Exact error terms in the asymptotic expansion of a class of integral transforms. I. Oscillatory kernels*. SIAM J. Math. Anal. **11**(5), pp. 828–841.
- D. Sornette (1998). *Multiplicative processes and power laws*. Phys. Rev. E **57**(4), pp. 4811–4813.
- J. Spanier and K. B. Oldham (1987). *An Atlas of Functions*. Washington: Hemisphere Pub. Corp.
- G. W. Spenceley and R. M. Spenceley (1947). *Smithsonian Elliptic Functions Tables*. Smithsonian Miscellaneous Collections, v. 109 (Publication 3863). Washington, D. C.: The Smithsonian Institution.

- R. Spigler (1980). *Some results on the zeros of cylindrical functions and of their derivatives*. Rend. Sem. Mat. Univ. Politec. Torino **38**(1), pp. 67–85.
- R. Spigler and M. Vianello (1992). *Liouville-Green approximations for a class of linear oscillatory difference equations of the second order*. J. Comput. Appl. Math. **41**(1-2), pp. 105–116.
- R. Spigler and M. Vianello (1997). *A Survey on the Liouville-Green (WKB) Approximation for Linear Difference Equations of the Second Order*. In S. Elaydi, I. Györi, and G. Ladas (Eds.), *Advances in Difference Equations (Veszprém, 1995)*, pp. 567–577. Amsterdam: Gordon and Breach.
- R. Spigler, M. Vianello, and F. Locatelli (1999). *Liouville-Green-Olver approximations for complex difference equations*. J. Approx. Theory **96**(2), pp. 301–322.
- R. Spira (1971). *Calculation of the gamma function by Stirling's formula*. Math. Comp. **25**(114), pp. 317–322.
- V. P. Spiridonov (2002). *An elliptic incarnation of the Bailey chain*. Int. Math. Res. Not. (37), pp. 1945–1977.
- G. Springer (1957). *Introduction to Riemann Surfaces*. Reading, Massachusetts: Addison-Wesley Publishing Company. A second edition was published in 1981 (Chelsea Publishing Co., New York, and AMS Chelsea Book Series, American Mathematical Society, Providence, Rhode Island).
- K. Srinivasa Rao (1981). *Computation of angular momentum coefficients using sets of generalized hypergeometric functions*. Comput. Phys. Comm. **22**(2-3), pp. 297–302.
- K. Srinivasa Rao and V. Rajeswari (1993). *Quantum Theory of Angular Momentum: Selected Topics*. Berlin: Springer-Verlag. Fortran programs comparing methods for the calculation of Clebsch–Gordan coefficients, and of  $6j$  and  $9j$  symbols, are given on pp. 266–292.
- K. Srinivasa Rao, V. Rajeswari, and C. B. Chiu (1989). *A new Fortran program for the  $9-j$  angular momentum coefficient*. Comput. Phys. Comm. **56**(2), pp. 231–248.
- K. Srinivasa Rao and K. Venkatesh (1978). *New Fortran programs for angular momentum coefficients*. Comput. Phys. Comm. **15**(3-4), pp. 227–235.
- H. M. Srivastava (1988). *Sums of certain series of the Riemann zeta function*. J. Math. Anal. Appl. **134**(1), pp. 129–140.
- H. M. Srivastava and J. Choi (2001). *Series Associated with the Zeta and Related Functions*. Dordrecht: Kluwer Academic Publishers.
- F. D. Stacey (1977). *Physics of the Earth* (2nd ed.). New York: John Wiley & Sons, Inc. Fourth edition published in 2008 by Cambridge University Press.
- A. Stankiewicz (1968). *Tables of the integro-exponential functions*. Acta Astronom. **18**, pp. 289–311.
- R. P. Stanley (1989). *Some combinatorial properties of Jack symmetric functions*. Adv. Math. **77**(1), pp. 76–115.
- R. P. Stanley (1997). *Enumerative Combinatorics. Vol. 1*. Cambridge: Cambridge University Press. Corrected reprint of the 1986 original.
- R. P. Stanley (1999). *Enumerative Combinatorics. Vol. 2*. Cambridge: Cambridge University Press.
- I. A. Stegun and R. Zucker (1974). *Automatic computing methods for special functions. II. The exponential integral  $E_n(x)$* . J. Res. Nat. Bur. Standards Sect. B **78B**, pp. 199–216. Double-precision Fortran, maximum accuracy 16S.
- E. M. Stein and R. Shakarchi (2003). *Fourier Analysis: An Introduction*, Volume 1 of *Princeton Lectures in Analysis*. Oxford-Princeton, NJ: Princeton University Press.
- J. Steinig (1970). *The real zeros of Struve's function*. SIAM J. Math. Anal. **1**(3), pp. 365–375.
- J. Steinig (1972). *The sign of Lommel's function*. Trans. Amer. Math. Soc. **163**, pp. 123–129.
- F. Stenger (1966a). *Error bounds for asymptotic solutions of differential equations. I. The distinct eigenvalue case*. J. Res. Nat. Bur. Standards Sect. B **70B**, pp. 167–186.
- F. Stenger (1966b). *Error bounds for asymptotic solutions of differential equations. II. The general case*. J. Res. Nat. Bur. Standards Sect. B **70B**, pp. 187–210.
- F. Stenger (1993). *Numerical Methods Based on Sinc and Analytic Functions*, Volume 20 of *Springer Series in Computational Mathematics*. New York: Springer-Verlag.
- G. W. Stewart (2001). *Matrix Algorithms. Vol. 2: Eigensystems*. Philadelphia, PA: Society for Industrial and Applied Mathematics (SIAM).
- A. N. Stokes (1980). *A stable quotient-difference algorithm*. Math. Comp. **34**(150), pp. 515–519.
- J. A. Stratton, P. M. Morse, L. J. Chu, and R. A. Hutner (1941). *Elliptic Cylinder and Spheroidal Wave Functions, Including Tables of Separation Constants and Coefficients*. New York: John Wiley and Sons, Inc.
- J. A. Stratton, P. M. Morse, L. J. Chu, J. D. C. Little, and F. J. Corbató (1956). *Spheroidal Wave Functions: Including Tables of Separation Constants and Coefficients*. New York: Technology Press of M. I. T. and John Wiley & Sons, Inc.
- A. Strecok (1968). *On the calculation of the inverse of the error function*. Math. Comp. **22**(101), pp. 144–158.
- R. S. Strichartz (1994). *A Guide to Distribution Theory and Fourier Transforms*. Studies in Advanced Mathematics. Boca Raton, FL: CRC Press.

- A. H. Stroud (1971). *Approximate Calculation of Multiple Integrals*. Englewood Cliffs, N.J.: Prentice-Hall Inc.
- A. H. Stroud and D. Secrest (1966). *Gaussian Quadrature Formulas*. Englewood Cliffs, NJ: Prentice-Hall Inc.
- M. J. O. Strutt (1932). *Lamésche, Mathieusche, und verwandte Funktionen in Physik und Technik*. Berlin: Springer. Reprinted by J. W. Edwards, Ann Arbor, MI, 1944.
- B. I. Suleimanov (1987). *The relation between asymptotic properties of the second Painlevé equation in different directions towards infinity*. Differ. Uravn. **23**(5), pp. 834–842. In Russian. English translation: Differential Equations **23**(1987), no. 5, pp. 569–576.
- W. F. Sun (1996). *Uniform asymptotic expansions of Hermite polynomials*. M. Phil. thesis, City University of Hong Kong.
- S. K. Suslov (2003). *An Introduction to Basic Fourier Series*, Volume 9 of *Developments in Mathematics*. Dordrecht: Kluwer Academic Publishers.
- H. Suzuki, E. Takasugi, and H. Umetsu (1998). *Perturbations of Kerr-de Sitter black holes and Heun's equations*. Progr. Theoret. Phys. **100**(3), pp. 491–505.
- N. Svartholm (1939). *Die Lösung der Fuchsschen Differentialgleichung zweiter Ordnung durch hypergeometrische Polynome*. Math. Ann. **116**(1), pp. 413–421.
- C. A. Swanson and V. B. Headley (1967). *An extension of Airy's equation*. SIAM J. Appl. Math. **15**(6), pp. 1400–1412.
- C. E. Synolakis (1988). *On the roots of  $f(z) = J_0(z) - iJ_1(z)$* . Quart. Appl. Math. **46**(1), pp. 105–107.
- O. Szász (1950). *On the relative extrema of ultraspherical polynomials*. Boll. Un. Mat. Ital. (3) **5**, pp. 125–127.
- O. Szász (1951). *On the relative extrema of the Hermite orthogonal functions*. J. Indian Math. Soc. (N.S.) **15**, pp. 129–134.
- G. Szegő (1933). *Asymptotische Entwicklungen der Jacobischen Polynome*. Schr. der König. Gelehr. Gesell. Naturwiss. Kl. **10**, pp. 33–112.
- G. Szegő (1948). *On an inequality of P. Turán concerning Legendre polynomials*. Bull. Amer. Math. Soc. **54**, pp. 401–405.
- G. Szegő (1967). *Orthogonal Polynomials* (3rd ed.). New York: American Mathematical Society. American Mathematical Society Colloquium Publications, Vol. 23.
- G. Szegő (1975). *Orthogonal Polynomials* (4th ed.), Volume XXIII of *Colloquium Publications*. Providence, RI: American Mathematical Society.
- G. 't Hooft and M. Veltman (1979). *Scalar one-loop integrals*. Nuclear Phys. B **153**(3-4), pp. 365–401.
- K. Takasaki (2001). *Painlevé-Calogero correspondence revisited*. J. Math. Phys. **42**(3), pp. 1443–1473.
- Y. Takei (1995). *On the connection formula for the first Painlevé equation—from the viewpoint of the exact WKB analysis*. Sūrikaiseikikenkyūsho Kōkyūroku (931), pp. 70–99. Painlevé functions and asymptotic analysis (Japanese) (Kyoto, 1995).
- T. Takemasa, T. Tamura, and H. H. Wolter (1979). *Coulomb functions with complex angular momenta*. Comput. Phys. Comm. **17**(4), pp. 351–355. Single-precision Fortran code.
- A. Takemura (1984). *Zonal Polynomials*. Institute of Mathematical Statistics Lecture Notes—Monograph Series, 4. Hayward, CA: Institute of Mathematical Statistics.
- I. C. Tang (1969). *Some definite integrals and Fourier series for Jacobian elliptic functions*. Z. Angew. Math. Mech. **49**, pp. 95–96.
- J. W. Tanner and S. S. Wagstaff, Jr. (1987). *New congruences for the Bernoulli numbers*. Math. Comp. **48**(177), pp. 341–350.
- J. G. Taylor (1978). *Error bounds for the Liouville-Green approximation to initial-value problems*. Z. Angew. Math. Mech. **58**(12), pp. 529–537.
- J. G. Taylor (1982). *Improved error bounds for the Liouville-Green (or WKB) approximation*. J. Math. Anal. Appl. **85**(1), pp. 79–89.
- N. M. Temme (1975). *On the numerical evaluation of the modified Bessel function of the third kind*. J. Comput. Phys. **19**(3), pp. 324–337. Algol program.
- N. M. Temme (1978). *Uniform asymptotic expansions of confluent hypergeometric functions*. J. Inst. Math. Appl. **22**(2), pp. 215–223.
- N. M. Temme (1979a). *An algorithm with ALGOL 60 program for the computation of the zeros of ordinary Bessel functions and those of their derivatives*. J. Comput. Phys. **32**(2), pp. 270–279.
- N. M. Temme (1979b). *The asymptotic expansion of the incomplete gamma functions*. SIAM J. Math. Anal. **10**(4), pp. 757–766.
- N. M. Temme (1983). *The numerical computation of the confluent hypergeometric function  $U(a, b, z)$* . Numer. Math. **41**(1), pp. 63–82. Algol 60 variable-precision procedures are included.
- N. M. Temme (1985). *Laplace type integrals: Transformation to standard form and uniform asymptotic expansions*. Quart. Appl. Math. **43**(1), pp. 103–123.
- N. M. Temme (1986). *Laguerre polynomials: Asymptotics for large degree*. Technical Report AM-R8610, CWI, Amsterdam, The Netherlands.

- N. M. Temme (1987). *On the computation of the incomplete gamma functions for large values of the parameters*. In *Algorithms for approximation (Shrivenham, 1985)*, Volume 10 of *Inst. Math. Appl. Conf. Ser. New Ser.*, pp. 479–489. New York: Oxford Univ. Press.
- N. M. Temme (1990a). *Asymptotic estimates for Laguerre polynomials*. *Z. Angew. Math. Phys.* **41**(1), pp. 114–126.
- N. M. Temme (1990b). *Uniform asymptotic expansions of a class of integrals in terms of modified Bessel functions, with application to confluent hypergeometric functions*. *SIAM J. Math. Anal.* **21**(1), pp. 241–261.
- N. M. Temme (1992a). *Asymptotic inversion of incomplete gamma functions*. *Math. Comp.* **58**(198), pp. 755–764.
- N. M. Temme (1992b). *Asymptotic inversion of the incomplete beta function*. *J. Comput. Appl. Math.* **41**(1-2), pp. 145–157. Asymptotic methods in analysis and combinatorics.
- N. M. Temme (1993). *Asymptotic estimates of Stirling numbers*. *Stud. Appl. Math.* **89**(3), pp. 233–243.
- N. M. Temme (1994a). *Computational aspects of incomplete gamma functions with large complex parameters*. In R. V. M. Zahar (Ed.), *Approximation and Computation. A Festschrift in Honor of Walter Gautschi.*, Volume 119 of *International Series of Numerical Mathematics*, pp. 551–562. Boston, MA: Birkhäuser Boston.
- N. M. Temme (1994b). *Steepest descent paths for integrals defining the modified Bessel functions of imaginary order*. *Methods Appl. Anal.* **1**(1), pp. 14–24.
- N. M. Temme (1995a). *Asymptotics of zeros of incomplete gamma functions*. *Ann. Numer. Math.* **2**(1-4), pp. 415–423. *Special functions (Torino, 1993)*.
- N. M. Temme (1995b). *Bernoulli polynomials old and new: Generalizations and asymptotics*. *CWI Quarterly* **8**(1), pp. 47–66.
- N. M. Temme (1995c). *Uniform asymptotic expansions of integrals: A selection of problems*. *J. Comput. Appl. Math.* **65**(1-3), pp. 395–417.
- N. M. Temme (1996a). *Special Functions: An Introduction to the Classical Functions of Mathematical Physics*. New York: John Wiley & Sons Inc.
- N. M. Temme (1996b). *Uniform asymptotics for the incomplete gamma functions starting from negative values of the parameters*. *Methods Appl. Anal.* **3**(3), pp. 335–344.
- N. M. Temme (1997). *Numerical algorithms for uniform Airy-type asymptotic expansions*. *Numer. Algorithms* **15**(2), pp. 207–225.
- N. M. Temme (2000). *Numerical and asymptotic aspects of parabolic cylinder functions*. *J. Comput. Appl. Math.* **121**(1-2), pp. 221–246. *Numerical analysis in the 20th century, Vol. I, Approximation theory*.
- N. M. Temme (2003). *Large parameter cases of the Gauss hypergeometric function*. *J. Comput. Appl. Math.* **153**(1-2), pp. 441–462.
- N. M. Temme and J. L. López (2001). *The Askey scheme for hypergeometric orthogonal polynomials viewed from asymptotic analysis*. *J. Comput. Appl. Math.* **133**(1-2), pp. 623–633.
- N. M. Temme and A. B. Olde Daalhuis (1990). *Uniform asymptotic approximation of Fermi-Dirac integrals*. *J. Comput. Appl. Math.* **31**(3), pp. 383–387.
- A. Terras (1988). *Harmonic Analysis on Symmetric Spaces and Applications. II*. Berlin: Springer-Verlag.
- A. Terras (1999). *Fourier Analysis on Finite Groups and Applications*, Volume 43 of *London Mathematical Society Student Texts*. Cambridge: Cambridge University Press.
- S. A. Teukolsky (1972). *Rotating black holes: Separable wave equations for gravitational and electromagnetic perturbations*. *Phys. Rev. Lett.* **29**(16), pp. 1114–1118.
- I. J. Thompson (2004). *Erratum to “COULCC: A continued-fraction algorithm for Coulomb functions of complex order with complex arguments”*. *Comput. Phys. Comm.* **159**(3), pp. 241–242.
- I. J. Thompson and A. R. Barnett (1985). *COULCC: A continued-fraction algorithm for Coulomb functions of complex order with complex arguments*. *Comput. Phys. Comm.* **36**(4), pp. 363–372. Double-precision Fortran, minimum accuracy: 14D. See also Thompson (2004).
- I. J. Thompson and A. R. Barnett (1986). *Coulomb and Bessel functions of complex arguments and order*. *J. Comput. Phys.* **64**(2), pp. 490–509.
- W. J. Thompson (1994). *Angular Momentum: An Illustrated Guide to Rotational Symmetries for Physical Systems*. A Wiley-Interscience Publication. New York: John Wiley & Sons Inc. With 1 Macintosh floppy disk (3.5 inch; DD). Programs for the calculation of  $3j, 6j, 9j$  symbols are included.
- W. J. Thompson (1997). *Atlas for Computing Mathematical Functions: An Illustrated Guide for Practitioners*. New York: John Wiley & Sons Inc. With CD-ROM containing a large collection of mathematical function software written in Fortran 90 and Mathematica (an edition with the same software in C and Mathematica exists also). The functions are computed for real variables only. Maximum accuracy 12D.
- E. C. Titchmarsh (1962). *The Theory of Functions* (2nd ed.). Oxford: Oxford University Press.
- E. C. Titchmarsh (1986a). *Introduction to the Theory of Fourier Integrals* (Third ed.). New York: Chelsea Publishing Co. Original edition was published in 1937 by Oxford University Press. Expanded bibliography and some improvements were made for the second and third editions.



- E. C. Titchmarsh (1986b). *The Theory of the Riemann Zeta-Function* (2nd ed.). New York-Oxford: The Clarendon Press Oxford University Press. Edited and with a preface by D. R. Heath-Brown.
- J. Todd (1954). *Evaluation of the exponential integral for large complex arguments*. J. Research Nat. Bur. Standards **52**, pp. 313–317.
- J. Todd (1975). *The lemniscate constants*. Comm. ACM **18**(1), pp. 14–19. Collection of articles honoring Alston S. Householder. For corrigendum see same journal v. 18 (1975), no. 8, p. 462.
- P. G. Todorov (1978). *Une nouvelle représentation explicite des nombres d'Euler*. C. R. Acad. Sci. Paris Sér. A-B **286**(19), pp. A807–A809.
- P. G. Todorov (1984). *On the theory of the Bernoulli polynomials and numbers*. J. Math. Anal. Appl. **104**(2), pp. 309–350.
- P. G. Todorov (1991). *Explicit formulas for the Bernoulli and Euler polynomials and numbers*. Abh. Math. Sem. Univ. Hamburg **61**, pp. 175–180.
- O. I. Tolstikhin and M. Matsuzawa (2001). *Hyperspherical elliptic harmonics and their relation to the Heun equation*. Phys. Rev. A **63**(032510), pp. 1–8.
- G. P. Tolstov (1962). *Fourier Series*. Englewood Cliffs, N.J.: Prentice-Hall Inc. Translated from the Russian by Richard A. Silverman. Second English edition published by Dover Publications Inc., New York, 1976.
- R. F. Tooper and J. Mark (1968). *Simplified calculation of  $Ei(x)$  for positive arguments, and a short table of  $Shi(x)$* . Math. Comp. **22**(102), pp. 448–449.
- G. Torres-Vega, J. D. Morales-Guzmán, and A. Zúñiga-Segundo (1998). *Special functions in phase space: Mathieu functions*. J. Phys. A **31**(31), pp. 6725–6739.
- C. A. Tracy and H. Widom (1994). *Level-spacing distributions and the Airy kernel*. Comm. Math. Phys. **159**(1), pp. 151–174.
- C. A. Tracy and H. Widom (1997). *On exact solutions to the cylindrical Poisson-Boltzmann equation with applications to polyelectrolytes*. Phys. A **244**(1-4), pp. 402–413.
- J. F. Traub (1964). *Iterative Methods for the Solution of Equations*. Prentice-Hall Series in Automatic Computation. Englewood Cliffs, NJ: Prentice-Hall Inc.
- L. N. Trefethen (2008). *Is Gauss quadrature better than Clenshaw-Curtis?* SIAM Rev. **50**(1), pp. 67–87.
- L. N. Trefethen and D. Bau, III (1997). *Numerical Linear Algebra*. Philadelphia, PA: Society for Industrial and Applied Mathematics (SIAM).
- C. L. Tretkoff and M. D. Tretkoff (1984). *Combinatorial Group Theory, Riemann Surfaces and Differential Equations*. In *Contributions to Group Theory*, Volume 33 of *Contemp. Math.*, pp. 467–519. Providence, RI: Amer. Math. Soc.
- M. J. Tretter and G. W. Walster (1980). *Further comments on the computation of modified Bessel function ratios*. Math. Comp. **35**(151), pp. 937–939.
- F. G. Tricomi (1947). *Sugli zeri delle funzioni di cui si conosce una rappresentazione asintotica*. Ann. Mat. Pura Appl. (4) **26**, pp. 283–300.
- F. G. Tricomi (1949). *Sul comportamento asintotico dell' $n$ -esimo polinomio di Laguerre nell'intorno dell'ascissa  $4n$* . Comment. Math. Helv. **22**, pp. 150–167.
- F. G. Tricomi (1950a). *Über die Abzählung der Nullstellen der konfluenten hypergeometrischen Funktionen*. Math. Z. **52**, pp. 669–675.
- F. G. Tricomi (1950b). *Asymptotische Eigenschaften der unvollständigen Gammafunktion*. Math. Z. **53**, pp. 136–148.
- F. G. Tricomi (1951). *Funzioni Ellittiche* (2nd ed.). Bologna: Nicola Zanichelli Editore. German edition (M. Krafft, Ed.) Akad. Verlag., Leipzig, 1948.
- F. G. Tricomi (1954). *Funzioni ipergeometriche confluenti*. Roma: Edizioni Cremonese.
- H. Triebel (1965). *Über die Lamésche Differentialgleichung*. Math. Nachr. **30**, pp. 137–154.
- H. Trinkaus and F. Drepper (1977). *On the analysis of diffraction catastrophes*. J. Phys. A **10**, pp. L11–L16.
- B. A. Troesch and H. R. Troesch (1973). *Eigenfrequencies of an elliptic membrane*. Math. Comp. **27**(124), pp. 755–765.
- C. Truesdell (1945). *On a function which occurs in the theory of the structure of polymers*. Ann. of Math. (2) **46**, pp. 144–157.
- C. Truesdell (1948). *An Essay Toward a Unified Theory of Special Functions*. Annals of Mathematics Studies, no. 18. Princeton, N. J.: Princeton University Press.
- P.-H. Tseng and T.-C. Lee (1998). *Numerical evaluation of exponential integral: Their well function approximation*. Journal of Hydrology **205**(1-2), pp. 38–51.
- E. O. Tuck (1964). *Some methods for flows past blunt slender bodies*. J. Fluid Mech. **18**, pp. 619–635.
- A. Tucker (2006). *Applied Combinatorics* (5th ed.). New York: John Wiley and Sons.
- S. A. Tumarkin (1959). *Asymptotic solution of a linear nonhomogeneous second order differential equation with a transition point and its application to the computations of toroidal shells and propeller blades*. J. Appl. Math. Mech. **23**, pp. 1549–1565.

- A. A. Tuzhilin (1971). *Theory of the Fresnel integral*. USSR Comput. Math. and Math. Phys. **9**(4), pp. 271–279. Translation of the paper in Zh. Vychisl. Mat. Mat. Fiz., Vol. 9, No. 4, 938–944, 1969.
- H. Umemura (2000). *On the transformation group of the second Painlevé equation*. Nagoya Math. J. **157**, pp. 15–46.
- H. Umemura and H. Watanabe (1998). *Solutions of the third Painlevé equation. I*. Nagoya Math. J. **151**, pp. 1–24.
- Unpublished Mathematical Tables (1944). *Mathematics of Computation Unpublished Mathematical Tables Collection*. Archives of American Mathematics, Center for American History, The University of Texas at Austin. Covers 1944–1994. An online guide is arranged chronologically by date of issuance within *Mathematics of Computation*.
- J. Urbanowicz (1988). *On the equation  $f(1)1^k + f(2)2^k + \dots + f(x)x^k + R(x) = By^2$* . Acta Arith. **51**(4), pp. 349–368.
- F. Ursell (1960). *On Kelvin's ship-wave pattern*. J. Fluid Mech. **8**(3), pp. 418–431.
- F. Ursell (1972). *Integrals with a large parameter. Several nearly coincident saddle-points*. Proc. Cambridge Philos. Soc. **72**, pp. 49–65.
- F. Ursell (1980). *Integrals with a large parameter: A double complex integral with four nearly coincident saddle-points*. Math. Proc. Cambridge Philos. Soc. **87**(2), pp. 249–273.
- F. Ursell (1984). *Integrals with a large parameter: Legendre functions of large degree and fixed order*. Math. Proc. Cambridge Philos. Soc. **95**(2), pp. 367–380.
- F. Ursell (1994). *Ship Hydrodynamics, Water Waves and Asymptotics*, Volume 2 of *Collected works of F. Ursell, 1946–1992*. Singapore: World Scientific.
- K. M. Urwin (1964). *Integral equations for paraboloidal wave functions. I*. Quart. J. Math. Oxford Ser. (2) **15**, pp. 309–315.
- K. M. Urwin (1965). *Integral equations for the paraboloidal wave functions. II*. Quart. J. Math. Oxford Ser. (2) **16**, pp. 257–262.
- K. M. Urwin and F. M. Arscott (1970). *Theory of the Whittaker-Hill equation*. Proc. Roy. Soc. Edinburgh Sect. A **69**, pp. 28–44.
- J. V. Uspensky and M. A. Heaslet (1939). *Elementary Number Theory*. New York: McGraw-Hill Book Company, Inc.
- T. Uzer, J. T. Muckerman, and M. S. Child (1983). *Collisions and umbilic catastrophes. The hyperbolic umbilic canonical diffraction integral*. Molecular Phys. **50**(6), pp. 1215–1230.
- G. Valent (1986). *An integral transform involving Heun functions and a related eigenvalue problem*. SIAM J. Math. Anal. **17**(3), pp. 688–703.
- O. Vallée and M. Soares (2004). *Airy Functions and Applications to Physics*. London-Singapore: Imperial College Press. Distributed by World Scientific, Singapore.
- A. L. Van Buren, R. V. Baier, S. Hanish, and B. J. King (1972). *Calculation of spheroidal wave functions*. J. Acoust. Soc. Amer. **51**, pp. 414–416.
- A. L. Van Buren and J. E. Boisvert (2002). *Accurate calculation of prolate spheroidal radial functions of the first kind and their first derivatives*. Quart. Appl. Math. **60**(3), pp. 589–599.
- A. L. Van Buren, B. J. King, R. V. Baier, and S. Hanish (1975). *Tables of Angular Spheroidal Wave Functions, Vol. 1, Prolate,  $m = 0$ ; Vol. 2, Oblate,  $m = 0$* . Washington, D.C.: Naval Res. Lab. Reports.
- H. C. van de Hulst (1957). *Light Scattering by Small Particles*. New York: John Wiley and Sons, Inc.
- H. C. van de Hulst (1980). *Multiple Light Scattering, Volume 1*. New York: Academic Press.
- J. van de Lune, H. J. J. te Riele, and D. T. Winter (1986). *On the zeros of the Riemann zeta function in the critical strip. IV*. Math. Comp. **46**(174), pp. 667–681.
- H. Van de Vel (1969). *On the series expansion method for computing incomplete elliptic integrals of the first and second kinds*. Math. Comp. **23**(105), pp. 61–69.
- C. G. van der Laan and N. M. Temme (1984). *Calculation of Special Functions: The Gamma Function, the Exponential Integrals and Error-Like Functions*, Volume 10 of *CWI Tract*. Amsterdam: Stichting Mathematisch Centrum, Centrum voor Wiskunde en Informatica.
- A. J. van der Poorten (1980). *Some Wonderful Formulas ... an Introduction to Polylogarithms*. In R. Ribenboim (Ed.), *Proceedings of the Queen's Number Theory Conference, 1979 (Kingston, Ont., 1979)*, Volume 54 of *Queen's Papers in Pure and Appl. Math.*, Kingston, Ont., pp. 269–286. Queen's University.
- B. L. van der Waerden (1951). *On the method of saddle points*. Appl. Sci. Research B. **2**, pp. 33–45.
- J. F. Van Diejen and V. P. Spiridonov (2001). *Modular hypergeometric residue sums of elliptic Selberg integrals*. Lett. Math. Phys. **58**(3), pp. 223–238.
- C. Van Loan (1992). *Computational Frameworks for the Fast Fourier Transform*, Volume 10 of *Frontiers in Applied Mathematics*. Philadelphia, PA: Society for Industrial and Applied Mathematics (SIAM).
- B. Ph. van Milligen and A. López Fraguas (1994). *Expansion of vacuum magnetic fields in toroidal harmonics*. Comput. Phys. Comm. **81**(1-2), pp. 74–90.

- A. van Wijngaarden (1953). *On the coefficients of the modular invariant  $J(\tau)$* . Nederl. Akad. Wetensch. Proc. Ser. A. **56** = Indagationes Math. **15 56**, pp. 389–400.
- A. N. Varčenko (1976). *Newton polyhedra and estimates of oscillatory integrals*. Funkcional. Anal. i Priložen. **10**(3), pp. 13–38. English translation in Functional Anal. Appl. **18** (1976), pp. 175–196.
- R. S. Varma (1941). *An infinite series of Weber's parabolic cylinder functions*. Proc. Benares Math. Soc. (N.S.) **3**, p. 37.
- D. A. Varshalovich, A. N. Moskalev, and V. K. Khersonskii (1988). *Quantum Theory of Angular Momentum*. Singapore: World Scientific Publishing Co. Inc.
- A. N. Vavreck and W. Thompson, Jr. (1984). *Some novel infinite series of spherical Bessel functions*. Quart. Appl. Math. **42**(3), pp. 321–324.
- G. Vedeler (1950). *A Mathieu equation for ships rolling among waves. I, II*. Norske Vid. Selsk. Forh., Trondheim **22**(25–26), pp. 113–123.
- R. Vein and P. Dale (1999). *Determinants and Their Applications in Mathematical Physics*, Volume 134 of *Applied Mathematical Sciences*. New York: Springer-Verlag.
- G. Veneziano (1968). *Construction of a crossing-symmetric, Regge-behaved amplitude for linearly rising trajectories. II* Nuovo Cimento A **57**(1), pp. 190–197.
- P. Verbeeck (1970). *Rational approximations for exponential integrals  $E_n(x)$* . Acad. Roy. Belg. Bull. Cl. Sci. (5) **56**, pp. 1064–1072.
- R. Vidūnas (2005). *Transformations of some Gauss hypergeometric functions*. J. Comput. Appl. Math. **178**(1-2), pp. 473–487.
- R. Vidūnas and N. M. Temme (2002). *Symbolic evaluation of coefficients in Airy-type asymptotic expansions*. J. Math. Anal. Appl. **269**(1), pp. 317–331.
- L. Vietoris (1983). *Dritter Beweis der die unvollständige Gammafunktion betreffenden Lochsschen Ungleichungen*. Österreich. Akad. Wiss. Math.-Natur. Kl. Sitzungsber. II **192**(1-3), pp. 83–91.
- N. Ja. Vilenkin (1968). *Special Functions and the Theory of Group Representations*. Providence, RI: American Mathematical Society.
- N. Ja. Vilenkin and A. U. Klimyk (1991). *Representation of Lie Groups and Special Functions. Volume 1: Simplest Lie Groups, Special Functions and Integral Transforms*, Volume 72 of *Mathematics and its Applications (Soviet Series)*. Dordrecht: Kluwer Academic Publishers Group. Translated from the Russian by V. A. Groza and A. A. Groza.
- N. Ja. Vilenkin and A. U. Klimyk (1992). *Representation of Lie Groups and Special Functions. Volume 3: Classical and Quantum Groups and Special Functions*, Volume 75 of *Mathematics and its Applications (Soviet Series)*. Dordrecht: Kluwer Academic Publishers Group. Translated from the Russian by V. A. Groza and A. A. Groza.
- N. Ja. Vilenkin and A. U. Klimyk (1993). *Representation of Lie Groups and Special Functions. Volume 2: Class I Representations, Special Functions, and Integral Transforms*, Volume 74 of *Mathematics and its Applications (Soviet Series)*. Dordrecht: Kluwer Academic Publishers Group. Translated from the Russian by V. A. Groza and A. A. Groza.
- I. M. Vinogradov (1937). *Representation of an odd number as a sum of three primes (Russian)*. Dokl. Akad. Nauk SSSR **15**, pp. 169–172.
- I. M. Vinogradov (1958). *A new estimate of the function  $\zeta(1+it)$* . Izv. Akad. Nauk SSSR. Ser. Mat. **22**, pp. 161–164.
- N. Virchenko and I. Fedotova (2001). *Generalized Associated Legendre Functions and their Applications*. Singapore: World Scientific Publishing Co. Inc.
- H. Volkmer (1982). *Integral relations for Lamé functions*. SIAM J. Math. Anal. **13**(6), pp. 978–987.
- H. Volkmer (1983). *Integralgleichungen für periodische Lösungen Hill'scher Differentialgleichungen*. Analysis **3**(1-4), pp. 189–203.
- H. Volkmer (1984). *Integral representations for products of Lamé functions by use of fundamental solutions*. SIAM J. Math. Anal. **15**(3), pp. 559–569.
- H. Volkmer (1998). *On the growth of convergence radii for the eigenvalues of the Mathieu equation*. Math. Nachr. **192**, pp. 239–253.
- H. Volkmer (1999). *Expansions in products of Heine-Stieltjes polynomials*. Constr. Approx. **15**(4), pp. 467–480.
- H. Volkmer (2004a). *Error estimates for Rayleigh-Ritz approximations of eigenvalues and eigenfunctions of the Mathieu and spheroidal wave equation*. Constr. Approx. **20**(1), pp. 39–54.
- H. Volkmer (2004b). *Four remarks on eigenvalues of Lamé's equation*. Anal. Appl. (Singap.) **2**(2), pp. 161–175.
- A. P. Vorob'ev (1965). *On the rational solutions of the second Painlevé equation*. Differ. Uravn. **1**(1), pp. 79–81. In Russian. English translation: Differential Equations **1**(1), pp. 58–59.
- M. N. Vrahatis, T. N. Grapsa, O. Ragos, and F. A. Zafriopoulos (1997a). *On the localization and computation of zeros of Bessel functions*. Z. Angew. Math. Mech. **77**(6), pp. 467–475.

- M. N. Vrahatis, O. Ragos, T. Skiniotis, F. A. Zafirooulos, and T. N. Grapsa (1997b). *The topological degree theory for the localization and computation of complex zeros of Bessel functions*. Numer. Funct. Anal. Optim. **18**(1-2), pp. 227–234.
- E. L. Wachspress (2000). *Evaluating elliptic functions and their inverses*. Comput. Math. Appl. **39**(3-4), pp. 131–136.
- E. Wagner (1986). *Asymptotische Darstellungen der hypergeometrischen Funktion für große Parameter unterschiedlicher Größenordnung*. Z. Anal. Anwendungen **5**(3), pp. 265–276.
- E. Wagner (1988). *Asymptotische Entwicklungen der hypergeometrischen Funktion  $F(a, b, c, z)$  für  $|c| \rightarrow \infty$  und konstante Werte  $a, b$  und  $z$* . Demonstratio Math. **21**(2), pp. 441–458.
- E. Wagner (1990). *Asymptotische Entwicklungen der Gaußschen hypergeometrischen Funktion für unbeschränkte Parameter*. Z. Anal. Anwendungen **9**(4), pp. 351–360.
- S. S. Wagstaff, Jr. (1978). *The irregular primes to 125000*. Math. Comp. **32**(142), pp. 583–591.
- S. S. Wagstaff, Jr. (2002). *Prime Divisors of the Bernoulli and Euler Numbers*. In *Number Theory for the Millennium, III (Urbana, IL, 2000)*, pp. 357–374. Natick, MA: A. K. Peters.
- J. Waldvogel (2006). *Fast construction of the Fejér and Clenshaw-Curtis quadrature rules*. BIT **46**(1), pp. 195–202.
- J. Walker (1983). *Caustics: Mathematical curves generated by light shined through rippled plastic*. Scientific American **249**, pp. 146–153.
- J. Walker (1988). *Shadows cast on the bottom of a pool are not like other shadows. Why?* Scientific American **259**, pp. 86–89.
- J. Walker (1989). *A drop of water becomes a gateway into the world of catastrophe optics*. Scientific American **261**, pp. 120–123.
- P. L. Walker (1991). *Infinitely differentiable generalized logarithmic and exponential functions*. Math. Comp. **57**(196), pp. 723–733.
- P. L. Walker (1996). *Elliptic Functions. A Constructive Approach*. Chichester-New York: John Wiley & Sons Ltd.
- P. L. Walker (2003). *The analyticity of Jacobian functions with respect to the parameter  $k$* . Proc. Roy. Soc. London Ser A **459**, pp. 2569–2574.
- P. L. Walker (2007). *The zeros of Euler's psi function and its derivatives*. J. Math. Anal. Appl. **332**(1), pp. 607–616.
- H. S. Wall (1948). *Analytic Theory of Continued Fractions*. New York: D. Van Nostrand Company, Inc. Reprinted by Chelsea Publishing, New York, 1973 and AMS Chelsea Publishing, Providence, RI, 2000.
- Z. Wang and R. Wong (2002). *Uniform asymptotic expansion of  $J_\nu(\nu a)$  via a difference equation*. Numer. Math. **91**(1), pp. 147–193.
- Z. Wang and R. Wong (2003). *Asymptotic expansions for second-order linear difference equations with a turning point*. Numer. Math. **94**(1), pp. 147–194.
- Z. Wang and R. Wong (2005). *Linear difference equations with transition points*. Math. Comp. **74**(250), pp. 629–653.
- Z. Wang and R. Wong (2006). *Uniform asymptotics of the Stieltjes-Wigert polynomials via the Riemann-Hilbert approach*. J. Math. Pures Appl. (9) **85**(5), pp. 698–718.
- Z. X. Wang and D. R. Guo (1989). *Special Functions*. Singapore: World Scientific Publishing Co. Inc. Translated from the Chinese by Guo and X. J. Xia.
- R. S. Ward (1987). *The Nahm equations, finite-gap potentials and Lamé functions*. J. Phys. A **20**(10), pp. 2679–2683.
- S. O. Warnaar (1998). *A note on the trinomial analogue of Bailey's lemma*. J. Combin. Theory Ser. A **81**(1), pp. 114–118.
- L. C. Washington (1997). *Introduction to Cyclotomic Fields* (2nd ed.). New York: Springer-Verlag.
- W. Wasow (1965). *Asymptotic Expansions for Ordinary Differential Equations*. New York-London-Sydney: Interscience Publishers John Wiley & Sons, Inc. Reprinted by Krieger, New York, 1976 and Dover, New York, 1987.
- W. Wasow (1985). *Linear Turning Point Theory*. Applied Mathematical Sciences No. 54. New York: Springer-Verlag.
- H. Watanabe (1995). *Solutions of the fifth Painlevé equation. I*. Hokkaido Math. J. **24**(2), pp. 231–267.
- B. M. Watrasiewicz (1967). *Some useful integrals of  $\text{Si}(x)$ ,  $\text{Ci}(x)$  and related integrals*. Optica Acta **14**(3), pp. 317–322.
- G. N. Watson (1910). *The cubic transformation of the hypergeometric function*. Quart. J. Pure and Applied Math. **41**, pp. 70–79.
- G. N. Watson (1935a). *Generating functions of class-numbers*. Compositio Math. **1**, pp. 39–68.
- G. N. Watson (1935b). *The surface of an ellipsoid*. Quart. J. Math., Oxford Ser. **6**, pp. 280–287.
- G. N. Watson (1937). *Two tables of partitions*. Proc. London Math. Soc. (2) **42**, pp. 550–556.

- G. N. Watson (1944). *A Treatise on the Theory of Bessel Functions* (2nd ed.). Cambridge, England: Cambridge University Press. Reprinted in 1995.
- G. N. Watson (1949). *A table of Ramanujan's function  $\tau(n)$* . Proc. London Math. Soc. (2) **51**, pp. 1–13.
- J. K. G. Watson (1999). *Asymptotic approximations for certain 6- $j$  and 9- $j$  symbols*. J. Phys. A **32**(39), pp. 6901–6902.
- J. V. Wehausen and E. V. Laitone (1960). *Surface Waves*. In *Handbuch der Physik, Vol. 9, Part 3*, pp. 446–778. Berlin: Springer-Verlag.
- G. Wei and B. E. Eichinger (1993). *Asymptotic expansions of some matrix argument hypergeometric functions, with applications to macromolecules*. Ann. Inst. Statist. Math. **45**(3), pp. 467–475.
- A. Weil (1999). *Elliptic Functions According to Eisenstein and Kronecker*. Classics in Mathematics. Berlin: Springer-Verlag. Reprint of the 1976 original.
- M. I. Weinstein and J. B. Keller (1985). *Hill's equation with a large potential*. SIAM J. Appl. Math. **45**(2), pp. 200–214.
- M. I. Weinstein and J. B. Keller (1987). *Asymptotic behavior of stability regions for Hill's equation*. SIAM J. Appl. Math. **47**(5), pp. 941–958.
- G. Weiss (1965). *Harmonic Analysis*. In I. I. Hirschman, Jr. (Ed.), *Studies in Real and Complex Analysis*, Studies in Mathematics, Vol. 3, pp. 124–178. Buffalo, NY: The Mathematical Association of America.
- E. J. Weniger (1989). *Nonlinear sequence transformations for the acceleration of convergence and the summation of divergent series*. Computer Physics Reports **10**(5-6), pp. 189–371.
- E. J. Weniger (1996). *Computation of the Whittaker function of the second kind by summing its divergent asymptotic series with the help of nonlinear sequence transformations*. Computers in Physics **10**(5), pp. 496–503.
- E. J. Weniger (2003). *A rational approximant for the digamma function*. Numer. Algorithms **33**(1-4), pp. 499–507. International Conference on Numerical Algorithms, Vol. I (Marrakesh, 2001).
- E. J. Weniger (2007). *Asymptotic Approximations to Truncation Errors of Series Representations for Special Functions*. In A. Iske and J. Levesley (Eds.), *Algorithms for Approximation*, pp. 331–348. Berlin-Heidelberg-New York: Springer-Verlag.
- E. J. Weniger and J. Čížek (1990). *Rational approximations for the modified Bessel function of the second kind*. Comput. Phys. Comm. **59**(3), pp. 471–493.
- H. Werner, J. Stoer, and W. Bommas (1967). *Rational Chebyshev approximation*. Numer. Math. **10**(4), pp. 289–306.
- J. A. Wheeler (1937). *Wave functions for large arguments by the amplitude-phase method*. Phys. Rev. **52**, pp. 1123–1127.
- A. D. Wheelon (1968). *Tables of Summable Series and Integrals Involving Bessel Functions*. San Francisco, CA: Holden-Day.
- F. J. W. Whipple (1927). *Some transformations of generalized hypergeometric series*. Proc. London Math. Soc. (2) **26**(2), pp. 257–272.
- C. S. Whitehead (1911). *On a generalization of the functions ber  $x$ , bei  $x$ , ker  $x$ , kei  $x$* . Quart. J. Pure Appl. Math. **42**, pp. 316–342.
- G. B. Whitham (1974). *Linear and Nonlinear Waves*. New York: John Wiley & Sons. Reprinted in 1999.
- E. T. Whittaker (1902). *On the functions associated with the parabolic cylinder in harmonic analysis*. Proc. London Math. Soc. **35**, pp. 417–427.
- E. T. Whittaker (1964). *A Treatise on the Analytical Dynamics of Particles and Rigid Bodies* (4th ed.). Cambridge: Cambridge University Press. Reprinted in 1988.
- E. T. Whittaker and G. N. Watson (1927). *A Course of Modern Analysis* (4th ed.). Cambridge University Press. Reprinted in 1996. Table errata: Math. Comp. v. 36 (1981), no. 153, p. 319.
- D. V. Widder (1941). *The Laplace Transform*. Princeton Mathematical Series, v. 6. Princeton, NJ: Princeton University Press.
- D. V. Widder (1979). *The Airy transform*. Amer. Math. Monthly **86**(4), pp. 271–277.
- R. L. Wiegel (1960). *A presentation of cnoidal wave theory for practical application*. J. Fluid Mech. **7**(2), pp. 273–286.
- E. P. Wigner (1959). *Group Theory and its Application to the Quantum Mechanics of Atomic Spectra*. Pure and Applied Physics. Vol. 5. New York: Academic Press. Expanded and improved ed. Translated from the German by J. J. Griffin.
- H. S. Wilf (1994). *generatingfunctionology* (2nd ed.). Boston, MA: Academic Press Inc. A 3rd edition was published in 2006 by A.K. Peters, Ltd., Wellesley, MA.
- H. S. Wilf and D. Zeilberger (1992a). *An algorithmic proof theory for hypergeometric (ordinary and “ $q$ ”) multisum/integral identities*. Invent. Math. **108**, pp. 575–633.
- H. S. Wilf and D. Zeilberger (1992b). *Rational function certification of multisum/integral/“ $q$ ” identities*. Bull. Amer. Math. Soc. (N.S.) **27**(1), pp. 148–153.

- J. H. Wilkinson (1988). *The Algebraic Eigenvalue Problem*. Monographs on Numerical Analysis. Oxford Science Publications. Oxford: The Clarendon Press, Oxford University Press. Paperback reprint of original edition, published in 1965 by Clarendon Press, Oxford.
- C. A. Wills, J. M. Blair, and P. L. Ragde (1982). *Rational Chebyshev approximations for the Bessel functions  $J_0(x)$ ,  $J_1(x)$ ,  $Y_0(x)$ ,  $Y_1(x)$* . Math. Comp. **39**(160), pp. 617–623. Tables on microfiche.
- J. A. Wilson (1978). *Hypergeometric Series, Recurrence Relations and Some New Orthogonal Polynomials*. Ph. D. thesis, University of Wisconsin, Madison, WI.
- J. A. Wilson (1980). *Some hypergeometric orthogonal polynomials*. SIAM J. Math. Anal. **11**(4), pp. 690–701.
- J. A. Wilson (1991). *Asymptotics for the  ${}_4F_3$  polynomials*. J. Approx. Theory **66**(1), pp. 58–71.
- J. Wimp (1964). *A class of integral transforms*. Proc. Edinburgh Math. Soc. (2) **14**, pp. 33–40.
- J. Wimp (1965). *On the zeros of a confluent hypergeometric function*. Proc. Amer. Math. Soc. **16**(2), pp. 281–283.
- J. Wimp (1968). *Recursion formulae for hypergeometric functions*. Math. Comp. **22**(102), pp. 363–373.
- J. Wimp (1981). *Sequence Transformations and their Applications*, Volume 154 of *Mathematics in Science and Engineering*. New York: Academic Press Inc.
- J. Wimp (1984). *Computation with Recurrence Relations*. Boston, MA: Pitman.
- J. Wimp (1985). *Some explicit Padé approximants for the function  $\Phi'/\Phi$  and a related quadrature formula involving Bessel functions*. SIAM J. Math. Anal. **16**(4), pp. 887–895.
- J. Wimp (1987). *Explicit formulas for the associated Jacobi polynomials and some applications*. Canad. J. Math. **39**(4), pp. 983–1000.
- J. Wishart (1928). *The generalised product moment distribution in samples from a normal multivariate population*. Biometrika **20A**, pp. 32–52.
- E. Witten (1987). *Elliptic genera and quantum field theory*. Comm. Math. Phys. **109**(4), pp. 525–536.
- G. Wolf (1998). *On the central connection problem for the double confluent Heun equation*. Math. Nachr. **195**, pp. 267–276.
- G. Wolf (2008). *On the asymptotic behavior of the Fourier coefficients of Mathieu functions*. J. Res. Nat. Inst. Standards Tech. **113**(1), pp. 11–15.
- R. Wong (1973a). *An asymptotic expansion of  $W_{k,m}(z)$  with large variable and parameters*. Math. Comp. **27**(122), pp. 429–436.
- R. Wong (1973b). *On uniform asymptotic expansion of definite integrals*. J. Approximation Theory **7**(1), pp. 76–86.
- R. Wong (1976). *Error bounds for asymptotic expansions of Hankel transforms*. SIAM J. Math. Anal. **7**(6), pp. 799–808.
- R. Wong (1977). *Asymptotic expansions of Hankel transforms of functions with logarithmic singularities*. Comput. Math. Appl. **3**(4), pp. 271–286.
- R. Wong (1979). *Explicit error terms for asymptotic expansions of Mellin convolutions*. J. Math. Anal. Appl. **72**(2), pp. 740–756.
- R. Wong (1981). *Asymptotic expansions of the Kontorovich-Lebedev transform*. Appl. Anal. **12**(3), pp. 161–172.
- R. Wong (1982). *Quadrature formulas for oscillatory integral transforms*. Numer. Math. **39**(3), pp. 351–360.
- R. Wong (1983). *Applications of some recent results in asymptotic expansions*. Congr. Numer. **37**, pp. 145–182.
- R. Wong (1989). *Asymptotic Approximations of Integrals*. Boston-New York: Academic Press Inc. Reprinted with corrections by SIAM, Philadelphia, PA, 2001.
- R. Wong (1995). *Error bounds for asymptotic approximations of special functions*. Ann. Numer. Math. **2**(1–4), pp. 181–197. Special functions (Torino, 1993).
- R. Wong and T. Lang (1990). *Asymptotic behaviour of the inflection points of Bessel functions*. Proc. Roy. Soc. London Ser. A **431**, pp. 509–518.
- R. Wong and T. Lang (1991). *On the points of inflection of Bessel functions of positive order. II*. Canad. J. Math. **43**(3), pp. 628–651.
- R. Wong and H. Li (1992a). *Asymptotic expansions for second-order linear difference equations*. J. Comput. Appl. Math. **41**(1–2), pp. 65–94.
- R. Wong and H. Li (1992b). *Asymptotic expansions for second-order linear difference equations. II*. Stud. Appl. Math. **87**(4), pp. 289–324.
- R. Wong and J. F. Lin (1978). *Asymptotic expansions of Fourier transforms of functions with logarithmic singularities*. J. Math. Anal. Appl. **64**(1), pp. 173–180.
- R. Wong and M. Wyman (1974). *The method of Darboux*. J. Approximation Theory **10**(2), pp. 159–171.
- R. Wong and H. Y. Zhang (2007). *Asymptotic solutions of a fourth order differential equation*. Stud. Appl. Math. **118**(2), pp. 133–152.
- R. Wong and J.-M. Zhang (1994a). *Asymptotic monotonicity of the relative extrema of Jacobi polynomials*. Canad. J. Math. **46**(6), pp. 1318–1337.
- R. Wong and J.-M. Zhang (1994b). *On the relative extrema of the Jacobi polynomials  $P_n^{(0,-1)}(x)$* . SIAM J. Math. Anal. **25**(2), pp. 776–811.

- R. Wong and J.-M. Zhang (1997). *Asymptotic expansions of the generalized Bessel polynomials*. J. Comput. Appl. Math. **85**(1), pp. 87–112.
- R. Wong and Y.-Q. Zhao (1999a). *Smoothing of Stokes's discontinuity for the generalized Bessel function*. Proc. Roy. Soc. London Ser. A **455**, pp. 1381–1400.
- R. Wong and Y.-Q. Zhao (1999b). *Smoothing of Stokes's discontinuity for the generalized Bessel function. II*. Proc. Roy. Soc. London Ser. A **455**, pp. 3065–3084.
- R. Wong and Y.-Q. Zhao (2002a). *Exponential asymptotics of the Mittag-Leffler function*. Constr. Approx. **18**(3), pp. 355–385.
- R. Wong and Y.-Q. Zhao (2002b). *Gevrey asymptotics and Stieltjes transforms of algebraically decaying functions*. Proc. Roy. Soc. London Ser. A **458**, pp. 625–644.
- R. Wong and Y.-Q. Zhao (2003). *Estimates for the error term in a uniform asymptotic expansion of the Jacobi polynomials*. Anal. Appl. (Singap.) **1**(2), pp. 213–241.
- R. Wong and Y.-Q. Zhao (2004). *Uniform asymptotic expansion of the Jacobi polynomials in a complex domain*. Proc. Roy. Soc. London Ser. A **460**, pp. 2569–2586.
- R. Wong and Y.-Q. Zhao (2005). *On a uniform treatment of Darboux's method*. Constr. Approx. **21**(2), pp. 225–255.
- P. M. Woodward and A. M. Woodward (1946). *Four-figure tables of the Airy function in the complex plane*. Philos. Mag. (7) **37**, pp. 236–261.
- J. W. Wrench, Jr. (1968). *Concerning two series for the gamma function*. Math. Comp. **22**(103), pp. 617–626.
- E. M. Wright (1935). *The asymptotic expansion of the generalized Bessel function*. Proc. London Math. Soc. (2) **38**, pp. 257–270.
- E. M. Wright (1940a). *The asymptotic expansion of the generalized hypergeometric function*. Proc. London Math. Soc. (2) **46**, pp. 389–408.
- E. M. Wright (1940b). *The generalized Bessel function of order greater than one*. Quart. J. Math., Oxford Ser. **11**, pp. 36–48.
- F. J. Wright (1980). *The Stokes set of the cusp diffraction catastrophe*. J. Phys. A **13**(9), pp. 2913–2928.
- C. Y. Wu (1982). *A series of inequalities for Mills's ratio*. Acta Math. Sinica **25**(6), pp. 660–670.
- P. Wynn (1966). *Upon systems of recursions which obtain among the quotients of the Padé table*. Numer. Math. **8**(3), pp. 264–269.
- H. Xiao, V. Rokhlin, and N. Yarvin (2001). *Prolate spheroidal wavefunctions, quadrature and interpolation*. Inverse Problems **17**(4), pp. 805–838. Special issue to celebrate Pierre Sabatier's 65th birthday (Montpellier, 2000).
- A. I. Yablonskiĭ (1959). *On rational solutions of the second Painlevé equation*. Vesti Akad. Navuk. BSSR Ser. Fiz. Tkh. Nauk. **3**, pp. 30–35.
- G. D. Yakovleva (1969). *Tables of Airy Functions and Their Derivatives*. Moscow: Izdat. Nauka.
- Z. M. Yan (1992). *Generalized Hypergeometric Functions and Laguerre Polynomials in Two Variables*. In *Hypergeometric Functions on Domains of Positivity, Jack Polynomials, and Applications (Tampa, FL, 1991)*, Volume 138 of *Contemporary Mathematics*, pp. 239–259. Providence, RI: Amer. Math. Soc.
- A. J. Yee (2004). *Partitions with difference conditions and Alder's conjecture*. Proc. Natl. Acad. Sci. USA **101**(47), pp. 16417–16418.
- A. Yu. Yeremin, I. E. Kaporin, and M. K. Kerimov (1985). *The calculation of the Riemann zeta function in the complex domain*. USSR Comput. Math. and Math. Phys. **25**(2), pp. 111–119.
- A. Yu. Yeremin, I. E. Kaporin, and M. K. Kerimov (1988). *Computation of the derivatives of the Riemann zeta-function in the complex domain*. USSR Comput. Math. and Math. Phys. **28**(4), pp. 115–124. Includes Fortran programs.
- F. L. Yost, J. A. Wheeler, and G. Breit (1936). *Coulomb wave functions in repulsive fields*. Phys. Rev. **49**(2), pp. 174–189.
- A. Young and A. Kirk (1964). *Bessel Functions. Part IV: Kelvin Functions*. Royal Society Mathematical Tables, Volume 10. Cambridge-New York: Cambridge University Press.
- D. M. Young and R. T. Gregory (1988). *A Survey of Numerical Mathematics. Vol. II*. New York: Dover Publications Inc. Corrected reprint of the 1973 original, published by Addison-Wesley.
- A. P. Yutsis, I. B. Levinson, and V. V. Vanagas (1962). *Mathematical Apparatus of the Theory of Angular Momentum*. Jerusalem: Israel Program for Scientific Translations for National Science Foundation and the National Aeronautics and Space Administration. Translated from the Russian by A. Sen and R. N. Sen.
- F. A. Zafiropoulos, T. N. Grapsa, O. Ragos, and M. N. Vrahatis (1996). *On the Computation of Zeros of Bessel and Bessel-related Functions*. In D. Bainov (Ed.), *Proceedings of the Sixth International Colloquium on Differential Equations (Plovdiv, Bulgaria, 1995)*, Utrecht, pp. 409–416. VSP.
- D. Zagier (1989). *The Dilogarithm Function in Geometry and Number Theory*. In R. Askey et al. (Eds.), *Number Theory and Related Topics (Bombay, 1988)*, Volume 12 of *Tata Inst. Fund. Res. Stud. Math.*, pp. 231–249. Bombay/Oxford: Tata Inst. Fund. Res./Oxford University Press.

- D. Zagier (1998). *A modified Bernoulli number*. Nieuw Arch. Wisk. (4) **16**(1-2), pp. 63–72.
- R. Zanovello (1975). *Sul calcolo numerico della funzione di Struve  $H_\nu(z)$* . Rend. Sem. Mat. Univ. e Politec. Torino **32**, pp. 251–269.
- R. Zanovello (1977). *Integrali di funzioni di Anger, Weber ed Airy-Hardy*. Rend. Sem. Mat. Univ. Padova **58**, pp. 275–285.
- R. Zanovello (1978). *Su un integrale definito del prodotto di due funzioni di Struve*. Atti Accad. Sci. Torino Cl. Sci. Fis. Mat. Natur. **112**(1-2), pp. 63–81.
- R. Zanovello (1995). *Numerical analysis of Struve functions with applications to other special functions*. Ann. Numer. Math. **2**(1-4), pp. 199–208.
- A. Zarzo, J. S. Dehesa, and R. J. Yañez (1995). *Distribution of zeros of Gauss and Kummer hypergeometric functions. A semiclassical approach*. Ann. Numer. Math. **2**(1-4), pp. 457–472.
- D. Zeilberger and D. M. Bressoud (1985). *A proof of Andrews'  $q$ -Dyson conjecture*. Discrete Math. **54**(2), pp. 201–224.
- J. Zhang (1996). *A note on the  $\tau$ -method approximations for the Bessel functions  $Y_0(z)$  and  $Y_1(z)$* . Comput. Math. Appl. **31**(9), pp. 63–70.
- J. Zhang and J. A. Belward (1997). *Chebyshev series approximations for the Bessel function  $Y_n(z)$  of complex argument*. Appl. Math. Comput. **88**(2-3), pp. 275–286.
- J. M. Zhang, X. C. Li, and C. K. Qu (1996). *Error bounds for asymptotic solutions of second-order linear difference equations*. J. Comput. Appl. Math. **71**(2), pp. 191–212.
- S. Zhang and J. Jin (1996). *Computation of Special Functions*. New York: John Wiley & Sons Inc. Includes diskette containing a large collection of mathematical function software written in Fortran. Implementation in double precision. Maximum accuracy 16S.
- Q. Zheng (1997). *Generalized Watson Transforms and Applications to Group Representations*. Ph. D. thesis, University of Vermont, Burlington, VT.
- Ya. M. Zhileikin and A. B. Kukarkin (1995). *A fast Fourier-Bessel transform algorithm*. Zh. Vychisl. Mat. i Mat. Fiz. **35**(7), pp. 1128–1133. English translation in Comput. Math. Math. Phys. **35**(7), pp. 901–905.
- D. G. Zill and B. C. Carlson (1970). *Symmetric elliptic integrals of the third kind*. Math. Comp. **24**(109), pp. 199–214.
- A. Ziv (1991). *Fast evaluation of elementary mathematical functions with correctly rounded last bit*. ACM Trans. Math. Software **17**(3), pp. 410–423.
- I. J. Zucker (1979). *The summation of series of hyperbolic functions*. SIAM J. Math. Anal. **10**(1), pp. 192–206.
- H. S. Zuckerman (1939). *The computation of the smaller coefficients of  $J(\tau)$* . Bull. Amer. Math. Soc. **45**(12), pp. 917–919.
- M. I. Žurina and L. N. Karmazina (1963). *Tablitsy funktsii Lezhandra  $P_{-1/2+i\tau}^1(x)$* . Vyčisl. Centr Akad. Nauk SSSR, Moscow. Translated title: Tables of the Legendre functions  $P_{-1/2+i\tau}^1(x)$ .
- M. I. Žurina and L. N. Karmazina (1964). *Tables of the Legendre functions  $P_{-1/2+i\tau}(x)$ . Part I*. Translated by D. E. Brown. Mathematical Tables Series, Vol. 22. Oxford: Pergamon Press. Translation of Žurina and Karmazina, *Tablitsy funktsii Lezhandra  $P_{-1/2+i\tau}(x)$ . Tom I*, Izdat. Akad. Nauk SSSR, Moscow, 1960.
- M. I. Žurina and L. N. Karmazina (1965). *Tables of the Legendre functions  $P_{-1/2+i\tau}(x)$ . Part II*. Translated by Prasenjit Basu. Mathematical Tables Series, Vol. 38. A Pergamon Press Book. New York: The Macmillan Co. Translation of Žurina and Karmazina, *Tablitsy funktsii Lezhandra  $P_{-1/2+i\tau}(x)$ . Tom II*, Izdat. Akad. Nauk SSSR, Moscow, 1962.
- M. I. Žurina and L. N. Karmazina (1966). *Tables and formulae for the spherical functions  $P_{-1/2+i\tau}^m(z)$* . Translated by E. L. Albasiny. Oxford: Pergamon Press. Translation of Žurina and Karmazina, *Tablitsy i formuly dlya sfericheskikh funktsii  $P_{-1/2+i\tau}^m(z)$* , Vyčisl. Centr Akad. Nauk SSSR, Moscow, 1962.
- M. I. Žurina and L. N. Karmazina (1967). *Tablitsy modifitsirovannykh funktsii Besselya s mnimym indeksom  $K_{i\tau}(x)$* . Vyčisl. Centr Akad. Nauk SSSR, Moscow. Translated title: Tables of the Modified Bessel Functions with Imaginary Index  $K_{i\tau}(x)$ .
- M. I. Žurina and L. N. Osipova (1964). *Tablitsy vyrozhdennoi gipergeometricheskoi funktsii*. Moscow: Vyčisl. Centr Akad. Nauk SSSR. Translated title: Tables of the confluent hypergeometric function.





# Notations

<p>!</p> <p><math>n!_q</math>: <math>q</math>-factorial ..... 145</p> <p>.</p> <p><math>\mathbf{a} \cdot \mathbf{b}</math>: vector dot (or scalar) product ..... 9</p> <p>*</p> <p><math>f * g</math>: convolution for Fourier transforms ..... 27</p> <p><math>f * g</math>: convolution for Laplace transforms ..... 28</p> <p><math>f * g</math>: convolution for Mellin transforms ..... 29</p> <p><math>f * g</math>: convolution product ..... 53</p> <p><math>\times</math></p> <p><math>G \times H</math>: Cartesian product of groups <math>G</math> and <math>H</math> ... 570</p> <p><math>\times</math></p> <p><math>\mathbf{a} \times \mathbf{b}</math>: vector cross product ..... 9</p> <p>/</p> <p><math>S_1/S_2</math>: set of all elements of <math>S_1</math> modulo elements of <math>S_2</math> ..... 538</p> <p><math>\sim</math></p> <p>asymptotic equality ..... 42</p> <p><math>\nabla</math></p> <p>del operator ..... 10</p> <p><math>\nabla^2</math></p> <p>Laplacian ..... 7</p> <p>Laplacian for cylindrical coordinates ..... 7</p> <p>Laplacian for polar coordinates ..... 7</p> <p>Laplacian for spherical coordinates ..... 8</p> <p><math>\nabla f</math></p> <p>gradient of differentiable scalar function <math>f</math> ..... 10</p> <p><math>\nabla \times \mathbf{F}</math></p> <p>curl of vector-valued function <math>\mathbf{F}</math> ..... 10</p> <p><math>\nabla \cdot \mathbf{F}</math></p> <p>divergence of vector-valued function <math>\mathbf{F}</math> ..... 10</p> <p><math>f_a^b</math></p> <p>Cauchy principal value ..... 6</p> <p><math>\int_a^{(b+)}</math></p> <p>loop integral in <math>\mathbb{C}</math>: path begins at <math>a</math>, encircles <math>b</math> once in the positive sense, and returns to <math>a</math> ..... 139</p> <p><math>\int_P^{(1+,0+,1-,0-)}</math></p> <p>Pochhammer's loop integral ..... 142</p> <p><math>\int \cdots d_q x</math></p> <p><math>q</math>-integral ..... 422</p>	<p><math>\bar{z}</math></p> <p>complex conjugate ..... 15</p> <p><math> z </math></p> <p>modulus (or absolute value) ..... 15</p> <p><math>\ \mathbf{a}\ </math></p> <p>magnitude of vector ..... 9</p> <p><math>\ \mathbf{A}\ _p</math></p> <p><math>p</math>-norm of a matrix ..... 74</p> <p><math>\ \mathbf{x}\ _2</math></p> <p>Euclidean norm of a vector ..... 74</p> <p><math>\ \mathbf{x}\ _p</math></p> <p><math>p</math>-norm of a vector ..... 74</p> <p><math>\ \mathbf{x}\ _\infty</math></p> <p>infinity (or maximum) norm of a vector ..... 74</p> <p><math>f(c+)</math></p> <p>limit on right (or from above) ..... 4</p> <p><math>f(c-)</math></p> <p>limit on left (or from below) ..... 4</p> <p><math>f^{[n]}(z)</math></p> <p><math>n</math>th <math>q</math>-derivative ..... 421</p> <p><math>x^n</math></p> <p>falling factorial ..... 618</p> <p><math>x^{\bar{n}}</math></p> <p>rising factorial ..... 618</p> <p><math>b_0 + \frac{a_1}{b_1+} \frac{a_2}{b_2+} \cdots</math></p> <p>continued fraction ..... 24</p> <p><math>(n P)</math></p> <p>Jacobi symbol ..... 642</p> <p><math>(n p)</math></p> <p>Legendre symbol ..... 642</p> <p><math>(a; q)_n</math></p> <p><math>q</math>-factorial (or <math>q</math>-shifted factorial) ..... 145, 420</p> <p><math>(a; q)_\nu</math></p> <p><math>q</math>-shifted factorial (generalized) ..... 420</p> <p><math>(a; q)_\infty</math></p> <p><math>q</math>-shifted factorial ..... 420</p> <p><math>(a_1, a_2, \dots, a_r; q)_n</math></p> <p>multiple <math>q</math>-shifted factorial ..... 420</p> <p><math>(a_1, a_2, \dots, a_r; q)_\infty</math></p> <p>multiple <math>q</math>-shifted factorial ..... 420</p>
---	---

$(j_1 \ m_1 \ j_2 \ m_2   j_1 \ j_2 \ j_3 \ -m_3)$	
Clebsch–Gordan coefficient .....	758
$\binom{m}{n}$	
binomial coefficient .....	2, 619
$\binom{n_1+n_2+\dots+n_k}{n_1, n_2, \dots, n_k}$	
multinomial coefficient .....	620
$\begin{pmatrix} j_1 & j_2 & j_3 \\ m_1 & m_2 & m_3 \end{pmatrix}$	
$3j$ symbol .....	758
$\langle \Lambda, \phi \rangle$	
distribution .....	35
$\langle f, \phi \rangle$	
tempered distribution .....	52
$\langle \delta, \phi \rangle$	
Dirac delta distribution .....	36
$\langle n \rangle_k$	
Eulerian number .....	632
$[z_0, z_1, \dots, z_n]$	
divided difference .....	76
$[a]_\kappa$	
partitional shifted factorial .....	769
$[p/q]_f$	
Padé approximant .....	98
$\left[ \begin{matrix} n \\ k \end{matrix} \right]$	
Stirling cycle number .....	631
$\left[ \begin{matrix} n \\ m \end{matrix} \right]_q$	
$q$ -binomial coefficient (or Gaussian polynomial)	
.....	421, 627
$\left[ \begin{matrix} a_1+a_2+\dots+a_n \\ a_1, a_2, \dots, a_n \end{matrix} \right]_q$	
$q$ -multinomial coefficient .....	634
$\{ \dots \}$	
sequence, asymptotic sequence (or scale), or enumerable set .....	43
$\{z, \zeta\}$	
Schwarzian derivative .....	27
$\left\{ \begin{matrix} j_1 & j_2 & j_3 \\ l_1 & l_2 & l_3 \end{matrix} \right\}$	
$6j$ symbol .....	761
$\left\{ \begin{matrix} j_{11} & j_{12} & j_{13} \\ j_{21} & j_{22} & j_{23} \\ j_{31} & j_{32} & j_{33} \end{matrix} \right\}$	
$9j$ symbol .....	763
$A$	
Glaisher's constant .....	144
$\mathbf{A}_\nu(z)$	
Anger–Weber function .....	295
$A_\nu(\mathbf{T})$	
Bessel function of matrix argument (first kind) ..	769
$A_n(z)$	
generalized Airy function .....	206
$A_k(z, p)$	
generalized Airy function .....	207
$A_{m,s}(q)$	
$q$ -Euler number .....	422
$a_{m,s}(q)$	
$q$ -Stirling number .....	422
$\text{Ai}(z)$	
Airy function .....	194
$\text{am}(x, k)$	
Jacobi's amplitude function .....	561
$\text{arccd}(x, k)$	
inverse Jacobian elliptic function .....	561
$\text{arccn}(x, k)$	
inverse Jacobian elliptic function .....	561
$\text{Arccos } z$	
general arccosine function .....	118
$\arccos z$	
arccosine function .....	119
$\text{Arccosh } z$	
general inverse hyperbolic cosine function .....	127
$\text{arccosh } z$	
inverse hyperbolic cosine function .....	127
$\text{Arccot } z$	
general arccotangent function .....	118
$\text{arccot } z$	
arccotangent function .....	119
$\text{Arccoth } z$	
general inverse hyperbolic cotangent function .....	127
$\text{arccoth } z$	
inverse hyperbolic cotangent function .....	127
$\text{arccs}(x, k)$	
inverse Jacobian elliptic function .....	561
$\text{Arccsc } z$	
general arccosecant function .....	118
$\text{arccsc } z$	
arccosecant function .....	119
$\text{Arccsch } z$	
general inverse hyperbolic cosecant function .....	127
$\text{arcsch } z$	
inverse hyperbolic cosecant function .....	127
$\text{arcdc}(x, k)$	
inverse Jacobian elliptic function .....	561

$\operatorname{arcdn}(x, k)$	
inverse Jacobian elliptic function . . . . .	561
$\operatorname{arcds}(x, k)$	
inverse Jacobian elliptic function . . . . .	561
$\operatorname{arcnc}(x, k)$	
inverse Jacobian elliptic function . . . . .	561
$\operatorname{arcnd}(x, k)$	
inverse Jacobian elliptic function . . . . .	561
$\operatorname{arcns}(x, k)$	
inverse Jacobian elliptic function . . . . .	561
$\operatorname{arcsc}(x, k)$	
inverse Jacobian elliptic function . . . . .	561
$\operatorname{arcsd}(x, k)$	
inverse Jacobian elliptic function . . . . .	561
$\operatorname{Arcsec} z$	
general arcsecant function . . . . .	118
$\operatorname{arcsec} z$	
arcsecant function . . . . .	119
$\operatorname{Arcsech} z$	
general inverse hyperbolic secant function . . . . .	127
$\operatorname{arcsech} z$	
inverse hyperbolic secant function . . . . .	127
$\operatorname{Arcsin} z$	
general arcsine function . . . . .	118
$\operatorname{arcsin} z$	
arcsine function . . . . .	119
$\operatorname{Arcsinh} z$	
general inverse hyperbolic sine function . . . . .	127
$\operatorname{arcsinh} z$	
inverse hyperbolic sine function . . . . .	127
$\operatorname{arcsn}(x, k)$	
inverse Jacobian elliptic function . . . . .	561
$\operatorname{Arctan} z$	
general arctangent function . . . . .	118
$\operatorname{arctan} z$	
arctangent function . . . . .	119
$\operatorname{Arctanh} z$	
general inverse hyperbolic tangent function . . . . .	127
$\operatorname{arctanh} z$	
inverse hyperbolic tangent function . . . . .	127
$B_n$	
Bernoulli numbers . . . . .	588
$B_n^{(\ell)}$	
generalized Bernoulli numbers . . . . .	596
$B_n^{(x)}$	
Nörlund polynomials . . . . .	596
$B(n)$	
Bell number . . . . .	623
$B_n(x)$	
Bernoulli polynomials . . . . .	588
$B_\nu(\mathbf{T})$	
Bessel function of matrix argument (second kind) . . . . .	769
$B_n(z)$	
generalized Airy function . . . . .	206
$\tilde{B}_n(x)$	
periodic Bernoulli functions . . . . .	588
$B_k(z, p)$	
generalized Airy function . . . . .	207
$B_n^{(\ell)}(x)$	
generalized Bernoulli polynomials . . . . .	596
$B(a, b)$	
beta function . . . . .	142
$B_m(a, b)$	
multivariate beta function . . . . .	768
$B_x(a, b)$	
incomplete beta function . . . . .	183
$B_q(a, b)$	
$q$ -beta function . . . . .	145
$\operatorname{bei}_\nu(x)$	
Kelvin function . . . . .	267
$\operatorname{ber}_\nu(x)$	
Kelvin function . . . . .	267
$\beta_n(x, q)$	
$q$ -Bernoulli polynomial . . . . .	422
$\operatorname{Bi}(z)$	
Airy function . . . . .	194
$C(n)$	
Catalan number . . . . .	620
$C(I)$ or $C(a, b)$	
continuous on an interval $I$ or $(a, b)$ . . . . .	4
$C^n(I)$ or $C^n(a, b)$	
continuously differentiable $n$ times on an interval $I$ or $(a, b)$ . . . . .	5
$C^\infty(I)$ or $C^\infty(a, b)$	
infinitely differentiable on an interval $I$ or $(a, b)$ . . . . .	5
$\chi(n)$	
Dirichlet character . . . . .	642
$C(z)$	
Fresnel integral . . . . .	160
$\chi(n)$	
ratio of gamma functions . . . . .	198

- $c(n)$   
 number of compositions of  $n$  ..... 628
- $\mathcal{C}_\nu(z)$   
 cylinder function ..... 218
- $C_\ell(\eta)$   
 normalizing constant for Coulomb radial functions  
 ..... 742
- $c_m(n)$   
 number of compositions of  $n$  into exactly  $m$  parts  
 ..... 628
- $c_k(n)$   
 Ramanujan's sum ..... 642
- $C_\alpha^{(\lambda)}(z)$   
 Gegenbauer function ..... 394
- $C_n^{(\lambda)}(x)$   
 ultraspherical (or Gegenbauer) polynomial ..... 439
- $c(\text{condition}, n)$   
 restricted number of compositions of  $n$  ..... 628
- $C_n(x, a)$   
 Charlier polynomial ..... 462
- $C_n^m(z, \xi)$   
 Ince polynomials ..... 676
- $c(\epsilon, \ell; r)$   
 irregular Coulomb function ..... 748
- $C(f, h)(x)$   
 cardinal function ..... 77
- $C_n(x; \beta | q)$   
 continuous  $q$ -ultraspherical polynomial ..... 473
- $\text{cd}(z, k)$   
 Jacobian elliptic function ..... 550
- $cdE_{2n+2}^m(z, k^2)$   
 Lamé polynomial ..... 690
- $\text{Ce}_\nu(z, q)$   
 modified Mathieu function ..... 667
- $\text{ce}_\nu(z, q)$   
 Mathieu function of noninteger order ..... 665
- $\text{ce}_n(z, q)$   
 Mathieu function ..... 654
- $cE_{2n+1}^m(z, k^2)$   
 Lamé polynomial ..... 690
- $\text{cel}(k_c, p, a, b)$   
 Bulirsch's complete elliptic integral ..... 487
- $\text{Chi}(z)$   
 hyperbolic cosine integral ..... 150
- $\text{Ci}(z)$   
 cosine integral ..... 150
- $\text{Ci}(a, z)$   
 generalized cosine integral ..... 188
- $\text{ci}(a, z)$   
 generalized cosine integral ..... 188
- $\text{Cin}(z)$   
 cosine integral ..... 150
- $\text{cn}(z, k)$   
 Jacobian elliptic function ..... 550
- $\cos z$   
 cosine function ..... 112
- $\text{Cos}_q(x)$   
 $q$ -cosine function ..... 422
- $\cos_q(x)$   
 $q$ -cosine function ..... 422
- $\cosh z$   
 hyperbolic cosine function ..... 123
- $\cot z$   
 cotangent function ..... 112
- $\coth z$   
 hyperbolic cotangent function ..... 123
- $\text{cs}(z, k)$   
 Jacobian elliptic function ..... 550
- $\csc z$   
 cosecant function ..... 112
- $\text{csch } z$   
 hyperbolic cosecant function ..... 123
- $\text{curl}$   
 of vector-valued function ..... 10
- $\mathcal{D}(I)$   
 test function space ..... 35
- $D(k)$   
 complete elliptic integral of Legendre's type ..... 487
- $d(n)$   
 divisor function ..... 638
- $d(n)$   
 derangement number ..... 631
- $\mathcal{D}_q$   
 $q$ -differential operator ..... 421
- $D_\nu(z)$   
 parabolic cylinder function ..... 304
- $d_k(n)$   
 divisor function ..... 638
- $d_q x$   
 $q$ -differential ..... 422
- $D^\alpha$   
 fractional derivative ..... 35

$D(m, n)$	
Dellano number . . . . .	621
$D(\phi, k)$	
incomplete elliptic integral of Legendre's type . . . . .	486
$D_j(\nu, \mu, z)$	
cross-products of modified Mathieu functions and their derivatives . . . . .	674
$dc(z, k)$	
Jacobian elliptic function . . . . .	550
$\frac{\partial(f,g)}{\partial(x,y)}$	
Jacobian . . . . .	9
$dE_{2n+1}^m(z, k^2)$	
Lamé polynomial . . . . .	690
$\Delta(\tau)$	
discriminant function . . . . .	646
$\delta(x - a)$	
Dirac delta (or Dirac delta function) . . . . .	37
div	
divergence of vector-valued function . . . . .	10
$dn(z, k)$	
Jacobian elliptic function . . . . .	550
$ds(z, k)$	
Jacobian elliptic function . . . . .	550
$Ds_j(n, m, z)$	
cross-products of radial Mathieu functions and their derivatives . . . . .	674
$e$	
base of exponential function . . . . .	105
$E_n$	
Euler numbers . . . . .	588
$E_n^{(\ell)}$	
generalized Euler numbers . . . . .	596
$E(k)$	
Legendre's complete elliptic integral of the second kind . . . . .	487
$\eta(\tau)$	
Dedekind's eta function (or Dedekind modular function) . . . . .	579, 646
$E_s(\mathbf{z})$	
elementary symmetric function . . . . .	501
$E_n(x)$	
Euler polynomials . . . . .	588
$E_1(z)$	
exponential integral . . . . .	150
$E_p(z)$	
generalized exponential integral . . . . .	185
$E_{a,b}(z)$	
Mittag-Leffler function . . . . .	261
$E_q(x)$	
$q$ -exponential function . . . . .	422
$\mathbf{E}_\nu(z)$	
Weber function . . . . .	295
$e_q(x)$	
$q$ -exponential function . . . . .	422
$\tilde{E}_n(x)$	
periodic Euler functions . . . . .	588
$E_n^{(\ell)}(x)$	
generalized Euler polynomials . . . . .	596
$E(\phi, k)$	
Legendre's incomplete elliptic integral of the second kind . . . . .	486
$Ec_\nu^m(z, k^2)$	
Lamé function . . . . .	685
Ei( $x$ )	
exponential integral . . . . .	150
Ein( $z$ )	
complementary exponential integral . . . . .	150
el1( $x, k_c$ )	
Bulirsch's incomplete elliptic integral of the first kind . . . . .	487
el2( $x, k_c, a, b$ )	
Bulirsch's incomplete elliptic integral of the second kind . . . . .	487
el3( $x, k_c, p$ )	
Bulirsch's incomplete elliptic integral of the third kind . . . . .	487
env Ai( $x$ )	
envelope of Airy function . . . . .	59
env Bi( $x$ )	
envelope of Airy function . . . . .	59
env $J_\nu(x)$	
envelope of Bessel function . . . . .	61
env $Y_\nu(x)$	
envelope of Bessel function . . . . .	61
env $U(-c, x)$	
envelope of parabolic cylinder function . . . . .	367
env $\bar{U}(-c, x)$	
envelope of parabolic cylinder function . . . . .	367
$\epsilon_{jkl}$	
Levi-Civita symbol . . . . .	10
$\mathcal{E}(x, k)$	
Jacobi's epsilon function . . . . .	562

$\operatorname{erf} z$	
error function	160
$\operatorname{erfc} z$	
complementary error function	160
$E\mathfrak{s}_\nu^m(z, k^2)$	
Lamé function	685
$\exp z$	
exponential function	105
$F_n$	
Fibonacci number	629
$F_D$	
Lauricella's multivariate hypergeometric function	497
$F(z)$	
Dawson's integral	160
$\mathcal{F}(z)$	
Fresnel integral	160
$F_s(x)$	
Fermi–Dirac integral	612
$F_c(x)$	
Fourier cosine transform	27
$F_s(x)$	
Fourier sine transform	27
$F_p(z)$	
terminant function	189
$f_{e,m}(h)$	
joining factor for radial Mathieu functions	669
$f_{o,m}(h)$	
joining factor for radial Mathieu functions	669
$F(x)$	
Fourier transform	27
$F(\phi, k)$	
Legendre's incomplete elliptic integral of the first kind	486
$F(x, s)$	
periodic zeta function	612
$F_\ell(\eta, \rho)$	
regular Coulomb radial function	742
$F\left(\begin{smallmatrix} a, b \\ c \end{smallmatrix}; z\right)$	
hypergeometric function	384
$F(a, b; c; z)$	
hypergeometric function	384
$\mathbf{F}\left(\begin{smallmatrix} a, b \\ c \end{smallmatrix}; z\right)$	
Olver's hypergeometric function	384
$\mathbf{F}(a, b; c; z)$	
Olver's hypergeometric function	384
$f(\epsilon, \ell; r)$	
regular Coulomb function	748
${}_1F_1\left(\begin{smallmatrix} a \\ b \end{smallmatrix}; \mathbf{T}\right)$	
confluent hypergeometric function of matrix argument (first kind)	770
${}_1F_1(a; b; \mathbf{T})$	
confluent hypergeometric function of matrix argument (first kind)	768, 770
${}_2F_1\left(\begin{smallmatrix} a, b \\ c \end{smallmatrix}; \mathbf{T}\right)$	
hypergeometric function of matrix argument	771
${}_2F_1(a, b; c; \mathbf{T})$	
hypergeometric function of matrix argument	768, 771
${}_2F_1(a, b; c; z)$	
hypergeometric function	384
${}_pF_q\left(\begin{smallmatrix} \mathbf{a} \\ \mathbf{b} \end{smallmatrix}; z\right)$	
generalized hypergeometric function	404, 408
${}_pF_q\left(\begin{smallmatrix} a_1, \dots, a_p \\ b_1, \dots, b_q \end{smallmatrix}; z\right)$	
generalized hypergeometric function	404, 408
${}_pF_q\left(\begin{smallmatrix} a_1, a_2, \dots, a_p \\ b_1, b_2, \dots, b_q \end{smallmatrix}; \mathbf{T}\right)$	
generalized hypergeometric function of matrix argument	772
${}_pF_q(\mathbf{a}; \mathbf{b}; z)$	
generalized hypergeometric function	404, 408
${}_pF_q(a_1, \dots, a_p; b_1, \dots, b_q; z)$	
generalized hypergeometric function	404, 408
${}_pF_q(a_1, a_2, \dots, a_p; b_1, b_2, \dots, b_q; \mathbf{T})$	
generalized hypergeometric function of matrix argument	768, 772
${}_2\mathbf{F}_1(a, b; c; z)$	
Olver's hypergeometric function	384
${}_p\mathbf{F}_q\left(\begin{smallmatrix} \mathbf{a} \\ \mathbf{b} \end{smallmatrix}; z\right)$	
scaled (or Olver's) generalized hypergeometric function	405
$F_1(\alpha; \beta, \beta'; \gamma; x, y)$	
Appell function	413
$F_2(\alpha; \beta, \beta'; \gamma, \gamma'; x, y)$	
Appell function	413
$F_3(\alpha, \alpha'; \beta, \beta'; \gamma; x, y)$	
Appell function	413
$F_4(\alpha; \beta; \gamma, \gamma'; x, y)$	
Appell function	413
$\operatorname{Fe}_n(z, q)$	
modified Mathieu function	667
$\operatorname{fe}_n(z, q)$	
second solution, Mathieu's equation	657

- $G_n$   
 Genocchi numbers ..... 595
- $G(z)$   
 Barnes'  $G$ -function (or double gamma function) .. 144
- $G(z)$   
 Goodwin–Staton integral.....160
- $G(k)$   
 Waring's function..... 645
- $g(k)$   
 Waring's function..... 645
- $G_s(x)$   
 Bose–Einstein integral ..... 612
- $G_p(z)$   
 product of gamma and incomplete gamma functions  
 .....199, 230
- $g_{e,m}(h)$   
 joining factor for radial Mathieu functions.....669
- $g_{o,m}(h)$   
 joining factor for radial Mathieu functions.....669
- $G(n, \chi)$   
 Gauss sum..... 643
- $G_\ell(\eta, \rho)$   
 irregular Coulomb radial function ..... 742
- $G_{p,q}^{m,n} \left( z; \begin{smallmatrix} a_1, \dots, a_p \\ b_1, \dots, b_q \end{smallmatrix} \right)$   
 Meijer  $G$ -function..... 415
- $G_{p,q}^{m,n}(z; \mathbf{a}; \mathbf{b})$   
 Meijer  $G$ -function..... 415
- $\gamma$   
 Euler's constant.....136
- $\Gamma(z)$   
 gamma function ..... 136
- $\Gamma_m(a)$   
 multivariate gamma function.....768
- $\Gamma_q(z)$   
 $q$ -gamma function.....145
- $\Gamma(a, z)$   
 incomplete gamma function ..... 174
- $\gamma(a, z)$   
 incomplete gamma function ..... 174
- $\gamma^*(a, z)$   
 incomplete gamma function ..... 174
- $\text{gd } x$   
 Gudermannian function.....121
- $\text{gd}^{-1}(x)$   
 inverse Gudermannian function ..... 121
- $\text{Ge}_n(z, q)$   
 modified Mathieu function ..... 667
- $\text{ge}_n(z, q)$   
 second solution, Mathieu's equation ..... 657
- $\text{Gi}(z)$   
 Scorer function (inhomogeneous Airy function) .. 204
- $\text{grad}$   
 gradient of differentiable scalar function ..... 10
- $H(s)$   
 Euler sums..... 613
- $H(x)$   
 Heaviside function ..... 36
- $H_n(x)$   
 Hermite polynomial..... 439
- $\mathbf{H}_\nu(z)$   
 Struve function ..... 288
- $He_n(x)$   
 Hermite polynomial..... 439
- $H_\nu^{(1)}(z)$   
 Bessel function of the third kind (or Hankel function)  
 ..... 217
- $H_\nu^{(2)}(z)$   
 Bessel function of the third kind (or Hankel function)  
 ..... 217
- $h_n^{(1)}(z)$   
 spherical Bessel function of the third kind ..... 262
- $h_n^{(2)}(z)$   
 spherical Bessel function of the third kind ..... 262
- $H(s, z)$   
 generalized Euler sums..... 614
- $\mathcal{H}(f; x)$   
 Hilbert transform ..... 29
- $H(a, u)$   
 line-broadening function ..... 167
- $H_n(x | q)$   
 continuous  $q$ -Hermite polynomial.....473
- $h_n(x | q)$   
 continuous  $q^{-1}$ -Hermite polynomial ..... 473
- $h_n(x; q)$   
 discrete  $q$ -Hermite I polynomial ..... 471
- $\tilde{h}_n(x; q)$   
 discrete  $q$ -Hermite II polynomial ..... 472
- $H_\ell^\pm(\eta, \rho)$   
 irregular Coulomb radial functions ..... 742
- $h(\epsilon, \ell; r)$   
 irregular Coulomb function.....748



- ${}_pH_q\left(\begin{smallmatrix} a_1, \dots, a_p \\ b_1, \dots, b_q \end{smallmatrix}; z\right)$   
 bilateral hypergeometric function ..... 408
- $hc_p^m(z, \xi)$   
 paraboloidal wave function ..... 677
- $(s_1, s_2)Hf_m(a, q_m; \alpha, \beta, \gamma, \delta; z)$   
 Heun functions ..... 712
- $(s_1, s_2)Hf_m^\nu(a, q_m; \alpha, \beta, \gamma, \delta; z)$   
 path-multiplicative solutions of Heun's equation .. 712
- $Hh_n(z)$   
 probability function ..... 167, 308
- $Hi(z)$   
 Scorer function (inhomogeneous Airy function) .. 204
- $H\ell(a, q; \alpha, \beta, \gamma, \delta; z)$   
 Heun functions ..... 711
- $Hp_{n,m}(a, q_{n,m}; -n, \beta, \gamma, \delta; z)$   
 Heun polynomials ..... 712
- $hs_p^m(z, \xi)$   
 paraboloidal wave function ..... 677
- $I^\alpha$   
 fractional integral ..... 35, 53
- $I(\mathbf{m})$   
 general elliptic integral ..... 512
- $I_\nu(z)$   
 modified Bessel function ..... 249
- $\tilde{I}_\nu(x)$   
 modified Bessel function of imaginary order ..... 261
- $i_n^{(1)}(z)$   
 modified spherical Bessel function ..... 262
- $i_n^{(2)}(z)$   
 modified spherical Bessel function ..... 262
- $I_x(a, b)$   
 incomplete beta function ..... 183
- $\text{idem}(\chi_1; \chi_2, \dots, \chi_n)$   
 idem function ..... 420
- $Ie_n(z, h)$   
 modified Mathieu function ..... 668
- $i^n \text{erfc}(z)$   
 repeated integrals of the complementary error function ..... 167
- $\text{inv}$   
 inversion number ..... 632
- $\text{inverf } x$   
 inverse error function ..... 166
- $\text{inverfc } x$   
 inverse complementary error function ..... 166
- $\text{Io}_n(z, h)$   
 modified Mathieu function ..... 668
- $j_{\nu, m}$   
 zeros of the Bessel function  $J_\nu(x)$  ..... 235
- $j'_{\nu, m}$   
 zeros of the Bessel function derivative  $J'_\nu(x)$  ..... 235
- $J(\tau)$   
 Klein's complete invariant ..... 579
- $\mathbf{J}_\nu(z)$   
 Anger function ..... 295
- $J_\nu(z)$   
 Bessel function of the first kind ..... 217
- $\tilde{J}_\nu(x)$   
 Bessel function of imaginary order ..... 248
- $J_k(n)$   
 Jordan's function ..... 638
- $j_n(z)$   
 spherical Bessel function of the first kind ..... 262
- $K(k)$   
 Legendre's complete elliptic integral of the first kind  
 ..... 487
- $\kappa(\lambda)$   
 condition number ..... 75
- $K_\nu(z)$   
 modified Bessel function ..... 249
- $\tilde{K}_\nu(x)$   
 modified Bessel function of imaginary order ..... 261
- $\mathbf{K}_\nu(z)$   
 Struve function ..... 288
- $k_n(z)$   
 modified spherical Bessel function ..... 262
- $K_n(x; p, N)$   
 Krawtchouk polynomial ..... 462
- $\text{Ke}_n(z, h)$   
 modified Mathieu function ..... 668
- $\text{kei}_\nu(x)$   
 Kelvin function ..... 268
- $\text{ker}_\nu(x)$   
 Kelvin function ..... 268
- $\text{Ki}_\alpha(x)$   
 Bickley function ..... 259
- $\text{Ko}_n(z, h)$   
 modified Mathieu function ..... 668
- $\mathbb{L}$   
 lattice in  $\mathbb{C}$  ..... 570

- $L_n$   
 Lebesgue constant ..... 13  
 $L_n(x)$   
 Laguerre polynomial ..... 436, 439  
 $\mathbf{L}_\nu(z)$   
 modified Struve function ..... 288  
 $L_n^{(\alpha)}(x)$   
 Laguerre (or generalized Laguerre) polynomial .. 439  
 $L(s, \chi)$   
 Dirichlet  $L$ -function ..... 612  
 $\mathcal{L}(f; s)$   
 Laplace transform ..... 28  
 $L_n^{(\alpha)}(x; q)$   
 $q$ -Laguerre polynomial ..... 471  
 $\lambda(\tau)$   
 elliptic modular function ..... 579  
 $\Lambda(n)$   
 Mangoldt's function ..... 639  
 $\lambda(n)$   
 Liouville's function ..... 639  
 $\text{li}(x)$   
 logarithmic integral ..... 150  
 $\text{Li}_2(z)$   
 dilogarithm ..... 610  
 $\text{Li}_s(z)$   
 polylogarithm ..... 611  
 $\text{Ln } z$   
 general logarithm function ..... 104  
 $\ln z$   
 principal branch of logarithm function ..... 104  
 $\log x$   
 logarithm to base  $e$  (Chapter 27 only) ..... 105  
 $\log_{10} z$   
 common logarithm ..... 105  
 $\log_a z$   
 logarithm to general base  $a$  ..... 105  
 $\mathbf{M}(x)$   
 Mills' ratio ..... 163  
 $M(n)$   
 Motzkin number ..... 621  
 $\mathbf{M}_\nu(z)$   
 modified Struve function ..... 288  
 $M_{\kappa, \mu}(z)$   
 Whittaker confluent hypergeometric function .... 334  
 $M(a, g)$   
 arithmetic-geometric mean ..... 492  
 $\mathcal{M}(f; s)$   
 Mellin transform ..... 29  
 $\mathbf{M}_\nu^{(j)}(z, h)$   
 modified Mathieu function ..... 667  
 $M(a, b, z)$   
 Kummer confluent hypergeometric function ..... 322  
 $\mathbf{M}(a, b, z)$   
 Olver's confluent hypergeometric function ..... 322  
 $M_n(x; \beta, c)$   
 Meixner polynomial ..... 462  
 maj  
 major index ..... 632  
 $\text{Mc}_n^{(j)}(z, h)$   
 radial Mathieu function ..... 668  
 $\text{Me}_\nu(z, q)$   
 modified Mathieu function ..... 667  
 $\text{me}_\nu(z, q)$   
 Mathieu function of noninteger order ..... 664  
 $\text{me}_n(z, q)$   
 Mathieu function ..... 665  
 $\text{Ms}_n^{(j)}(z, h)$   
 radial Mathieu function ..... 668  
 $\mu(n)$   
 Möbius function ..... 639  
 $\mathcal{N}$   
 winding number ..... 16  
 $N(n, k)$   
 Narayana number ..... 622  
 $\text{nc}(z, k)$   
 Jacobian elliptic function ..... 550  
 $\text{nd}(z, k)$   
 Jacobian elliptic function ..... 550  
 $\text{ns}(z, k)$   
 Jacobian elliptic function ..... 550  
 $\nu(n)$   
 number of distinct primes dividing  $n$  ..... 638  
 $O(x)$   
 order not exceeding ..... 42  
 $o(x)$   
 order less than ..... 42  
 $O_n(x)$   
 Neumann's polynomial ..... 247  
 $\text{P}_I, \text{P}_{II}, \text{P}_{III}, \text{P}'_{III}, \text{P}_{IV}, \text{P}_V, \text{P}_{VI}$   
 Painlevé transcendents ..... 724  
 $p(\text{condition}, n)$   
 restricted number of partions of  $n$  ..... 627

$P \left\{ \begin{matrix} \alpha & \beta & \gamma \\ a_1 & b_1 & c_1 \\ a_2 & b_2 & c_2 \end{matrix} \middle  z \right\}$	
Riemann's $P$ -symbol for solutions of the generalized hypergeometric differential equation	396
$\wp(z)$ ( $= \wp(z \mathbb{L}) = \wp(z; g_2, g_3)$ )	
Weierstrass $\wp$ -function	570
$p(n)$	
total number of partitions of $n$	618
$P_\nu(x)$ : $P_\nu^\mu(x)$ with $\mu = 0$	352, 353
$P_n(x)$	
Legendre polynomial	439
$P_\nu(z)$ : $P_\nu^\mu(z)$ with $\mu = 0$	352, 353, 375
$p_k(n)$	
number of partitions of $n$ into at most $k$ parts	626
$P_\nu^\mu(x)$	
Ferrers function of the first kind	353
$P_\nu^\mu(z)$	
associated Legendre function of the first kind	353, 375
$P_n^*(x)$	
shifted Legendre polynomial	439
$P_n^{(\alpha, \beta)}(x)$	
Jacobi polynomial	439
$P_{-\frac{1}{2}+i\tau}^{-\mu}(x)$	
conical function	372
$P(a, z)$	
normalized incomplete gamma function	174
$P_n(x; c)$	
associated Legendre polynomial	474
$p_k(\leq m, n)$	
number of partitions of $n$ into at most $k$ parts, each less than or equal to $m$	626
$p_k(\mathcal{D}, n)$	
number of partitions of $n$ into at most $k$ distinct parts	627
$P_n^{(\alpha, \beta)}(x; c)$	
associated Jacobi polynomial	474
$P_n^{(\lambda)}(x; \phi)$	
Meixner–Pollaczek polynomial	462
$P_{m, n}^{\alpha, \beta, \gamma}(x, y)$	
triangle polynomial	478
$P_n^{(\lambda)}(x; a, b)$	
Pollaczek polynomial	476
$p_n(x; a, b; q)$	
little $q$ -Jacobi polynomial	471
$P_n^{(\alpha, \beta)}(x; c, d; q)$	
big $q$ -Jacobi polynomial	471
$p_n(x; a, b, \bar{a}, \bar{b})$	
continuous Hahn polynomial	462
$P_n(x; a, b, c; q)$	
big $q$ -Jacobi polynomial	471
$p_n(x; a, b, c, d   q)$	
Askey–Wilson polynomial	472
ph	
phase	15
$\phi(n)$	
Euler's totient	638
$\Phi_1(t; \mathbf{x})$	
fold catastrophe	776
$\Phi_2(t; \mathbf{x})$	
cuspid catastrophe	776
$\Phi_3(t; \mathbf{x})$	
swallowtail catastrophe	776
$\Phi_K(t; \mathbf{x})$	
cuspid catastrophe	776
$\phi_k(n)$	
sum of powers of integers relatively prime to $n$	638
$\phi_\lambda^{(\alpha, \beta)}(t)$	
Jacobi function	394
$\Phi^{(E)}(s, t; \mathbf{x})$	
elliptic umbilic catastrophe	776
$\Phi^{(H)}(s, t; \mathbf{x})$	
hyperbolic umbilic catastrophe	776
$\phi(\rho, \beta; z)$	
generalized Bessel function	261
$\Phi(z, s, a)$	
Lerch's transcendent	612
$\Phi^{(1)}(a; b, b'; c; x, y)$	
first $q$ -Appell function	423
$\Phi^{(2)}(a; b, b'; c, c'; x, y)$	
second $q$ -Appell function	423
$\Phi^{(3)}(a, a'; b, b'; c; x, y)$	
third $q$ -Appell function	423
$\Phi^{(4)}(a; b; c, c'; x, y)$	
fourth $q$ -Appell function	423
${}_{r+1}\phi_s \left( \begin{matrix} a_0, a_1, \dots, a_r \\ b_1, b_2, \dots, b_s \end{matrix} ; q, z \right)$	
basic hypergeometric (or $q$ -hypergeometric) function	423
${}_{r+1}\phi_s(a_0, a_1, \dots, a_r; b_1, b_2, \dots, b_s; q, z)$	
basic hypergeometric (or $q$ -hypergeometric) function	423

$\pi$	geometric) function . . . . .	423
set of plane partitions . . . . .	${}_r\psi_s(a_1, a_2, \dots, a_r; b_1, b_2, \dots, b_s; q, z)$	
$\pi(x)$	bilateral basic hypergeometric (or bilateral $q$ -hypergeometric) function . . . . .	423
$\Pi(\alpha^2, k)$	$Q_\nu(x)$ : $Q_\nu^\mu(x)$ with $\mu = 0$ . . . . .	352, 353
Legendre's complete elliptic integral of the third kind . . . . .	$Q_n(x; \alpha, \beta, N)$	
	Hahn polynomial . . . . .	462
$\Pi(\phi, \alpha^2, k)$	$Q_\nu(z)$ : $Q_\nu^\mu(z)$ with $\mu = 0$ . . . . .	352, 354, 375
Legendre's incomplete elliptic integral of the third kind . . . . .	$Q_\nu^\mu(x)$	
	Ferrers function of the second kind . . . . .	353
$pp(n)$	$Q_\nu^\mu(z)$	
number of plane partitions of $n$ . . . . .	associated Legendre function of the second kind . . . . .	354, 375
$pq(z, k)$		
generic Jacobian elliptic function . . . . .	$Q_\nu^\mu(z)$	
	Olver's associated Legendre function . . . . .	354, 375
$Ps_n^m(z, \gamma^2)$	$\widehat{Q}_{-\frac{1}{2}+i\tau}^{-\mu}(x)$	
spheroidal wave function of complex argument ..	conical function . . . . .	372
700	$Q(a, z)$	
$Ps_n^m(x, \gamma^2)$	normalized incomplete gamma function . . . . .	174
spheroidal wave function of the first kind . . . . .	$Q_n(x; a, b   q)$	
699	Al-Salam–Chihara polynomial . . . . .	473
$\psi(x)$	$Q_n(x; a, b   q^{-1})$	
Chebyshev $\psi$ -function . . . . .	$q^{-1}$ -Al-Salam–Chihara polynomial . . . . .	473
613	$Q_n(x; \alpha, \beta, N; q)$	
$\psi(z)$	$q$ -Hahn polynomial . . . . .	470
psi (or digamma) function . . . . .	$Qs_n^m(z, \gamma^2)$	
136	spheroidal wave function of complex argument ..	700
$\Psi_2(\mathbf{x})$	$Qs_n^m(x, \gamma^2)$	
Pearcey integral . . . . .	spheroidal wave function of the second kind . . . . .	700
777		
$\Psi_K(\mathbf{x})$	$r(n)$	
canonical integral . . . . .	Schröder number . . . . .	622
776	$r_{\text{tp}}(\epsilon, \ell)$	
$\psi^{(n)}(z)$	outer turning point for Coulomb functions . . . . .	748
polygamma functions . . . . .	$R_{m,n}^{(\alpha)}(z)$	
144	disk polynomial . . . . .	477
$\Psi^{(E)}(\mathbf{x})$	$R_{-a}(b_1, b_2, \dots, b_n; z_1, z_2, \dots, z_n)$	
canonical integral . . . . .	multivariate hypergeometric function . . . . .	498
776	$R_{-a}(\mathbf{b}; \mathbf{z})$	
$\Psi^{(H)}(\mathbf{x})$	multivariate hypergeometric function . . . . .	498
canonical integral . . . . .	$R_n(x; \gamma, \delta, N)$	
776	dual Hahn polynomial . . . . .	467
$\Psi_3(\mathbf{x}; k)$	$R_n(x; \alpha, \beta, \gamma, \delta)$	
swallowtail canonical integral function . . . . .	Racah polynomial . . . . .	467
777, 778	$R_n(x; \alpha, \beta, \gamma, \delta   q)$	
$\Psi_K(\mathbf{x}; k)$	$q$ -Racah polynomial . . . . .	474
diffraction catastrophe . . . . .		
777		
$\Psi^{(E)}(\mathbf{x}; k)$		
elliptic umbilic canonical integral function . . . . .		
777, 779, 780		
$\Psi^{(H)}(\mathbf{x}; k)$		
hyperbolic umbilic canonical integral function . . . . .		
777, 779, 781		
$\Psi(a; b; \mathbf{T})$		
confluent hypergeometric function of matrix argument (second kind) . . . . .		
768, 770		
${}_r\psi_s\left(\begin{smallmatrix} a_1, a_2, \dots, a_r \\ b_1, b_2, \dots, b_s \end{smallmatrix}; q, z\right)$		
bilateral basic hypergeometric (or bilateral $q$ -hyper-		

- $R_C(x, y)$   
 Carlson's elliptic integral with two variables . . . . . 487
- $R_D(x, y, z)$   
 elliptic integral symmetric in only two variables . . . 498
- $R_F(x, y, z)$   
 symmetric elliptic integral of first kind . . . . . 497
- $R_G(x, y, z)$   
 symmetric elliptic integral of second kind . . . . . 498
- $\rho_{\text{tp}}(\eta, \ell)$   
 outer turning point for Coulomb radial functions  
 . . . . . 742
- $R_J(x, y, z, p)$   
 symmetric elliptic integral of third kind . . . . . 497
- $\mathfrak{S}_n$   
 set of permutations of  $\{1, 2, \dots, n\}$  . . . . . 631
- $S(z)$   
 Fresnel integral . . . . . 160
- $S_{\mu, \nu}(z)$   
 Lommel function . . . . . 295
- $s_{\mu, \nu}(z)$   
 Lommel function . . . . . 294
- $S_n^{m(j)}(z, \gamma)$   
 radial spheroidal wave function . . . . . 703
- $\mathcal{S}(f; s)$   
 Stieltjes transform . . . . . 29
- $S(n, k)$   
 Stirling number of the second kind . . . . . 624
- $s(n, k)$   
 Stirling number of the first kind . . . . . 624
- $S_n(x; q)$   
 Stieltjes–Wigert polynomial . . . . . 471
- $S_n^m(z, \xi)$   
 Ince polynomials . . . . . 676
- $s(\epsilon, \ell; r)$   
 regular Coulomb function . . . . . 748
- $S(k, h)(x)$   
 Sinc function . . . . . 77
- $S_n(x; a, b, c)$   
 continuous dual Hahn polynomial . . . . . 467
- $\text{sc}(z, k)$   
 Jacobian elliptic function . . . . . 550
- $\text{scd}E_{2n+3}^m(z, k^2)$   
 Lamé polynomial . . . . . 690
- $\text{sc}E_{2n+2}^m(z, k^2)$   
 Lamé polynomial . . . . . 690
- $\text{sd}(z, k)$   
 Jacobian elliptic function . . . . . 550
- $\text{sd}E_{2n+2}^m(z, k^2)$   
 Lamé polynomial . . . . . 690
- $\text{Se}_\nu(z, q)$   
 modified Mathieu function . . . . . 667
- $\text{se}_\nu(z, q)$   
 Mathieu function of noninteger order . . . . . 665
- $\text{se}_n(z, q)$   
 Mathieu function . . . . . 654
- $\text{s}E_{2n+1}^m(z, k^2)$   
 Lamé polynomial . . . . . 690
- $\sec z$   
 secant function . . . . . 112
- $\text{sech } z$   
 hyperbolic secant function . . . . . 123
- $\text{Shi}(z)$   
 hyperbolic sine integral . . . . . 150
- $\text{Si}(z)$   
 sine integral . . . . . 150
- $\text{si}(z)$   
 sine integral . . . . . 150
- $\text{Si}(a, z)$   
 generalized sine integral . . . . . 188
- $\text{si}(a, z)$   
 generalized sine integral . . . . . 188
- $\sigma_n(\nu)$   
 Rayleigh function . . . . . 240
- $\sigma_\ell(\eta)$   
 Coulomb phase shift . . . . . 742
- $\sigma_\alpha(n)$   
 sum of powers of divisors of  $n$  . . . . . 638
- $\sigma(z) (= \sigma(z|\mathbb{L}) = \sigma(z; g_2, g_3))$   
 Weierstrass sigma function . . . . . 570
- $\sin z$   
 sine function . . . . . 112
- $\text{Sin}_q(x)$   
 $q$ -sine function . . . . . 422
- $\sin_q(x)$   
 $q$ -sine function . . . . . 422
- $\sinh z$   
 hyperbolic sine function . . . . . 123
- $\text{sn}(z, k)$   
 Jacobian elliptic function . . . . . 550
- $T_n$   
 tangent numbers . . . . . 596

$T_n(x)$	Chebyshev polynomial of the first kind . . . . .	439
$T_n^*(x)$	shifted Chebyshev polynomial of the first kind ..	439
$\tan z$	tangent function . . . . .	112
$\tanh z$	hyperbolic tangent function . . . . .	123
$\tau(n)$	Ramanujan's tau function . . . . .	647
$\theta_j(z \tau)$	theta function . . . . .	524
$\theta_j(z, q)$	theta function . . . . .	524
$\theta(\mathbf{z} \Omega)$	Riemann theta function . . . . .	538
$\hat{\theta}(\mathbf{z} \Omega)$	scaled Riemann theta function . . . . .	538
$\theta_{[\beta]}^{[\alpha]}(\mathbf{z} \Omega)$	Riemann theta function with characteristics . . . . .	539
$U_n(x)$	Chebyshev polynomial of the second kind . . . . .	439
$U_m(t)$	generalized Airy function . . . . .	207
$U_n^*(x)$	shifted Chebyshev polynomial of the second kind . . . . .	439
$U(a, z)$	parabolic cylinder function . . . . .	304
$U(x, t)$	Voigt function . . . . .	167
$\bar{U}(a, x)$	parabolic cylinder function . . . . .	305
$U(a, b, z)$	Kummer confluent hypergeometric function . . . . .	322
$uE_{2n}^m(z, k^2)$	Lamé polynomial . . . . .	690
$\mathcal{V}_{a,b}(f)$	total variation . . . . .	6
$V_n(x)$	Chebyshev polynomial of the third kind . . . . .	439
$V_m(t)$	generalized Airy function . . . . .	207
$\bar{V}_m(t)$	generalized Airy function . . . . .	207
$V(a, z)$	parabolic cylinder function . . . . .	304
$V(x, t)$	Voigt function . . . . .	167
$\mathcal{W}$	Wronskian . . . . .	26
$W(x)$	Lambert $W$ -function . . . . .	111
$w(z)$	complementary error function . . . . .	160
$W_n(x)$	Chebyshev polynomial of the fourth kind . . . . .	439
$Wp(x)$	principal branch of Lambert $W$ -function . . . . .	111
$Wm(x)$	nonprincipal branch of Lambert $W$ -function . . . . .	111
$W_{\kappa,\mu}(z)$	Whittaker confluent hypergeometric function . . . . .	334
$W(a, x)$	parabolic cylinder function . . . . .	314
$w_1(z, \lambda)$	basic solution, Hill's equation . . . . .	674
$w_{II}(z, \lambda)$	basic solution, Hill's equation . . . . .	674
$w_1(z; a, q)$	basic solution, Mathieu's equation . . . . .	653
$w_{II}(z; a, q)$	basic solution, Mathieu's equation . . . . .	653
$W_n(x; a, b, c, d)$	Wilson polynomial . . . . .	467
$\xi(s)$	Riemann's $\xi$ -function . . . . .	604
$y_{\nu,m}$	zeros of the Bessel function $Y_\nu(x)$ . . . . .	235
$y'_{\nu,m}$	zeros of the Bessel function derivative $Y'_\nu(x)$ . . . . .	235
$Y_\nu(z)$	Bessel function of the second kind . . . . .	217
$\tilde{Y}_\nu(x)$	Bessel function of imaginary order . . . . .	248
$y_n(z)$	spherical Bessel function of the second kind . . . . .	262
$y_n(x; a)$	Bessel polynomial . . . . .	476
$Y_{l,m}(\theta, \phi)$	spherical harmonic . . . . .	378

$Y_l^m(\theta, \phi)$		$Z(x k)$	
surface harmonic of the first kind .....	378	Jacobi's zeta function .....	562
$\mathcal{X}_\nu(z)$		$\zeta(s)$	
modified cylinder function .....	249	Riemann zeta function .....	602
$Z_\kappa(\mathbf{T})$		$\zeta_x(s)$	
zonal polynomial .....	769	incomplete Riemann zeta function .....	189
$z^a$		$\zeta(s, a)$	
power function .....	105	Hurwitz zeta function .....	607
		$\zeta(z)$ ( $= \zeta(z \mathbb{L}) = \zeta(z; g_2, g_3)$ )	
		Weierstrass zeta function .....	570

# Index

Abel means .....	33
Abel summability .....	33, 34
Abel–Plana formula .....	63
Abelian functions .....	545
absolute error .....	73
acceleration of convergence	
definition .....	93
for sequences .....	93–94
for series .....	93–94
limit-preserving .....	93
accumulation point .....	15
acoustics	
canonical integrals .....	792
additive number theory .....	644–647
Dedekind modular function .....	646
Dedekind sum .....	646
discriminant function .....	646
Euler’s pentagonal number theorem .....	646
Goldbach conjecture .....	644
Jacobi’s identities .....	645
notation .....	638
partition function .....	644
unrestricted .....	645
Ramanujan’s identity .....	646
Ramanujan’s tau function .....	646
representation by squares .....	645
Waring’s problem .....	645
aerodynamics	
Struve functions .....	298
affine Weyl groups	
Painlevé equations .....	732
Airy functions .....	<b>194</b>
analytic properties .....	194
applications	
mathematical .....	208
physical .....	209
ship waves .....	790
approximations	
expansions in Chebyshev series .....	211
in terms of elementary functions .....	211
in the complex plane .....	212
asymptotic expansions .....	198–199
error bounds .....	199
exponentially-improved .....	199
computation .....	209–210
connection formulas .....	194
definitions .....	194
differential equation .....	194
for products .....	203
initial values .....	194
numerically satisfactory solutions .....	194
Riccati form .....	194
Dirac delta .....	38
envelope functions .....	59
generalized .....	<i>see</i> generalized Airy functions.
graphics .....	195
incomplete .....	208
integral identities .....	787
integral representations .....	196, 203
integrals	
approximations .....	211, 212
asymptotic approximations .....	202
definite .....	202
indefinite .....	202
of products .....	204
repeated .....	203
tables .....	211
Laplace transforms .....	203
Maclaurin series .....	196
Mellin transform .....	203
modulus and phase	
asymptotic expansions .....	200
definitions .....	199
graphs .....	195
identities .....	200
monotonicity .....	200
relation to Bessel functions .....	199
relation to zeros .....	200
notation .....	194
products	
differential equation .....	203
integral representations .....	203
integrals .....	204
Wronskian .....	203
relation to umbilics .....	777
relations to other functions	
Bessel functions .....	196–197
confluent hypergeometric functions ..	197, 328, 338
Hankel functions .....	196–197
modified Bessel functions .....	196–197
Stieltjes transforms .....	203
tables	
complex variables .....	210
integrals .....	211
real variables .....	210
zeros .....	201–202, 211



- Wronskians ..... 194
- zeros
- asymptotic expansions ..... 201
  - computation ..... 76, 210
  - differentiation ..... 200
  - relation to modulus and phase ..... 200
  - tables ..... 201–202, 211
- Airy transform ..... 203
- Airy's equation
- ..... *see* Airy functions, differential equation.
- Aitken's  $\Delta^2$ -process
- for sequences ..... 93
  - iterated ..... 93
- Al-Salam–Chihara polynomials ..... 473
- algebraic curves
- Riemann surface ..... 543, 544, 546
- algebraic equations
- parametrization via Jacobian elliptic functions .. 563
  - spherical trigonometry ..... 564
  - uniformization ..... 564
- algebraic Lamé functions ..... 693
- alternant
- determinant ..... 3
- amplitude (am) function ..... 561
- applications ..... 564
- approximations
- small  $k, k'$  ..... 562
  - small  $x$  ..... 561
- computation ..... 567
- definition ..... 561
- Fourier series ..... 562
- integral representation ..... 561
- quasi-periodicity ..... 561
- relation to elliptic integrals ..... 562
- relation to Gudermannian function ..... 562
- special values ..... 561
- tables ..... 567
- analytic continuation ..... 19
- by reflection ..... 19
- analytic function ..... 16
- at infinity ..... 17
  - in a domain ..... 16
  - singularities ..... 19
  - zeros ..... 19
- Anger function ..... *see* Anger–Weber functions.
- Anger–Weber functions ..... 295
- analytic properties ..... 295
  - asymptotic expansions
    - large argument ..... 297
    - large order ..... 298  - computation ..... 87, 299
  - definitions ..... 295
  - derivatives ..... 297
  - differential equation ..... 295
  - graphics ..... 296
  - incomplete ..... 300
  - integral representations ..... 295
  - integrals ..... 297
  - interrelations ..... 296
  - Maclaurin series ..... 296
  - notation ..... 288
  - order ..... 288
  - recurrence relations ..... 297
  - relations to other functions
    - Fresnel integrals ..... 297
    - Lommel functions ..... 296
    - Struve functions ..... 297  - series expansions
    - power series ..... 296
    - products of Bessel functions ..... 297
    - special values ..... 297
    - sums ..... 297
    - tables ..... 299
- angle between arcs ..... 17
- angular momenta ..... 758
- angular momentum
- generalized hypergeometric functions ..... 418
- angular momentum coupling coefficients
- ..... *see*  $3j$  symbols,  $6j$  symbols, and  $9j$  symbols.
- angular momentum operator
- spherical coordinates ..... 379
- annulus ..... 19
- antenna research
- Lamé functions ..... 694
- Appell functions ..... 412
- analytic continuation ..... 414
  - applications
    - physical ..... 417
    - computation ..... 418  - definition ..... 412–413
  - integral representations ..... 414
  - integrals ..... 414
    - inverse Laplace transform ..... 414  - notation ..... 412
  - partial differential equations ..... 413
  - relation to Legendre's elliptic integrals ..... 490
  - relation to symmetric elliptic integrals ..... 509
  - relations to hypergeometric functions ..... 414
  - transformations of variables ..... 414–415
    - quadratic ..... 415
    - reduction formulas ..... 414
- approximation techniques
- Chebyshev-series expansions ..... 97
  - least squares ..... 99–100
  - minimax polynomials ..... 96
  - minimax rational functions ..... 97
  - Padé ..... 98–99
  - splines ..... 100

- arc length
  - Jacobian elliptic functions.....563
- arc(s) ..... 16
  - angle between.....17
- area of triangle.....246
- argument principle ..... *see* phase principle.
- arithmetic Fourier transform ..... 647
- arithmetic mean ..... 3, 13
- arithmetic progression ..... 2
- arithmetic-geometric mean..... 492
  - hypergeometric function ..... 400
  - integral representations ..... 492
  - Jacobian elliptic functions.....566
  - Legendre's elliptic integrals..... 492–493
  - symmetric elliptic integrals.....505
- arithmetics
  - complex.....73
  - exact rational.....72
  - floating-point.....72
  - interval.....72
  - level-index.....73
- Askey polynomials ..... 475
- Askey scheme for orthogonal polynomials.....464
- Askey–Gasper inequality
  - Jacobi polynomials.....478
- Askey–Wilson class orthogonal polynomials... 472–474
  - as eigenfunctions of a  $q$ -difference operator..... 472
  - asymptotic approximations.....474
  - interrelations with other orthogonal polynomials
    - .....464
  - orthogonality properties.....472
  - representation as  $q$ -hypergeometric functions
    - .....472–474
- Askey–Wilson polynomials ..... 472
  - asymptotic approximations.....474
  - relation to  $q$ -hypergeometric functions..... 472–474
- associated Anger–Weber function
  - ..... *see* Anger–Weber functions.
- associated Laguerre functions ..... 754
- associated Legendre equation..... 352, 375
  - exponent pairs.....352
  - numerically satisfactory solutions..... 352, 375
  - singularities.....352
  - standard solutions.....352, 354, 375
- associated Legendre functions..... **352**
  - ..... *see also* Ferrers functions.
  - addition theorems..... 370, 377
  - analytic continuation.....376
  - analytic properties.....375
  - applications..... 378–379
  - asymptotic approximations
    - ..... *see* uniform asymptotic approximations.
  - behavior at singularities..... 361, 375
  - computation.....379
  - connection formulas..... 362, 375
  - continued fractions.....364
  - cross-products.....353
  - definitions.....353–354, 375
  - degree.....352
  - derivatives.....362
    - with respect to degree or order.....363
  - differential equation
    - ..... *see* associated Legendre equation.
  - expansions in series of.....370
  - generalized.....378
  - generating functions..... 361, 375
  - graphics..... 357–359, 375–376
  - Heine's formula.....377
  - hypergeometric representations..... 353–354, 375
  - integer degree and order.....360–361, 375
  - integer order.....360, 375
  - integral representations.....363, 377
  - integrals
    - definite.....369
    - Laplace transforms.....370
    - Mellin transforms.....370
    - products.....369
  - notation.....352
  - of the first kind.....353
  - of the second kind.....354
  - Olver's.....354, 375
  - order.....352
  - orthogonality.....369
  - principal values (or branches).....375
  - recurrence relations.....362, 375
  - relations to other functions
    - elliptic integrals.....360
    - Gegenbauer function.....355
    - hypergeometric function.....353, 354, 394
    - Jacobi function.....355
    - Legendre polynomials.....360
    - Rodrigues-type formulas.....360
    - special values.....359, 360
    - sums.....370–371, 377
    - tables.....380
  - uniform asymptotic approximations
    - large degree.....366–368, 377
    - large order.....365–366, 377
    - values on the cut.....376
  - Whipple's formula.....362
  - Wronskians.....352–353, 375
  - zeros.....368, 377
- associated orthogonal polynomials.....474
  - corecursive.....474
  - Jacobi.....474
  - Legendre.....474
- astrophysics
  - error functions and Voigt functions.....169

- Heun functions and Heun's equation ..... 720
- asymptotic and order symbols ..... 42
- definition ..... 42
- differentiation ..... 42
- integration ..... 42
- asymptotic approximations and expansions .... *see also*
- asymptotic approximations of integrals, asymptotic approximations of sums and sequences, asymptotic solutions of difference equations, asymptotic solutions of differential equations, *and* asymptotic solutions of transcendental equations.
- algebraic operations ..... 42
- cases of failure ..... 52, 66
- differentiation ..... 42
- double asymptotic properties
- Bessel functions ..... 258
- Hankel functions ..... 258
- Kelvin functions ..... 273
- modified Bessel functions ..... 257
- parabolic cylinder functions ..... 311
- exponentially-improved expansions ..... 67–69
- generalized ..... 43
- hyperasymptotic expansions ..... 68
- improved accuracy via numerical transformations ..... 69
- integration ..... 42
- logarithms of ..... 42
- null ..... 42
- numerical use of ..... 66, 69
- Poincaré type ..... 42
- powers of ..... 42
- re-expansion of remainder terms ..... 67–69
- reversion of ..... 43
- Stokes phenomenon ..... 67
- substitution of ..... 42
- uniform ..... 43
- uniqueness ..... 42
- via connection formulas ..... 66
- asymptotic approximations of integrals ..... 43–55
- Bleistein's method ..... 45
- Chester–Friedman–Ursell method ..... 48
- coalescing critical points ..... 48
- coalescing peak and endpoint ..... 45
- coalescing saddle points ..... 48
- distributional methods ..... 51–55
- Fourier integrals ..... 44
- Haar's method ..... 46
- integration by parts ..... 43
- inverse Laplace transforms ..... 46–47
- Laplace transforms ..... 43
- Laplace's method ..... 44–45, 47
- Mellin transform methods ..... 48
- extensions ..... 49–51
- method of stationary phase ..... 45
- extensions ..... 45
- method of steepest descents ..... 47
- multidimensional integrals ..... 51
- Stieltjes transforms ..... 52–53
- generalized ..... 53
- Watson's lemma ..... 44, 46
- generalized ..... 44
- asymptotic approximations of sums and sequences ..... 63–66
- Abel–Plana formula ..... 63
- Darboux's method ..... 65–66
- entire functions ..... 64
- Euler–Maclaurin formula ..... 63
- summation by parts ..... 63
- asymptotic scale or sequence ..... 43
- asymptotic solutions of difference equations ..... 61–63
- characteristic equation ..... 62
- coincident characteristic values ..... 62
- Liouville–Green (or WKBJ) type approximations ..... 62
- transition points ..... 63
- turning points ..... 63
- with a parameter ..... 62–63
- asymptotic solutions of differential equations .... 55–61
- characteristic equation ..... 56
- coincident characteristic values ..... 57
- error-control function ..... 57
- Fabry's transformation ..... 57
- irregular singularities of rank 1 ..... 56
- Liouville–Green approximation theorem ..... 57
- Liouville–Green (or WKBJ) approximations ..... 57
- numerically satisfactory solutions ..... 58
- resurgence ..... 57, 68
- with a parameter ..... 58–61
- classification of cases ..... 58
- coalescing transition points ..... 61
- connection formulas across transition points ..... 61
- in terms of Airy functions ..... 59
- in terms of Bessel functions of fixed order ... 60–61
- in terms of Bessel functions of variable order ... 61
- in terms of elementary functions ..... 59
- Liouville transformation ..... 58
- transition points ..... 58
- turning points ..... 58
- asymptotic solutions of transcendental equations .... 43
- Lagrange's formula ..... 43
- atomic photo-ionization
- Coulomb functions ..... 753
- atomic physics
- Coulomb functions ..... 754
- error functions ..... 169
- atomic spectra
- Coulomb functions ..... 753
- atomic spectroscopy

- 3*j*, 6*j*, 9*j* symbols ..... 765
- attractive potentials
  - Coulomb functions ..... 753, 754
- auxiliary functions for Fresnel integrals
  - approximations ..... 170
  - asymptotic expansions ..... 164
  - computation ..... 169
  - definitions ..... 160
  - derivatives ..... 164
  - integral representations ..... 163
    - Mellin–Barnes integrals ..... 163
  - symmetry ..... 162
- auxiliary functions for sine and cosine integrals
  - analytic continuation ..... 151
  - approximations ..... 156
  - asymptotic expansions ..... 153
    - exponentially-improved ..... 154
  - Chebyshev-series expansions ..... 157
  - computation ..... 156
  - definition ..... 150
  - integral representations ..... 152
  - principal values ..... 151
  - relation to confluent hypergeometric functions... 153
  - tables ..... 156
- axially symmetric potential theory ..... 501
- Bäcklund transformations
  - classical orthogonal polynomials ..... 478
  - Painlevé transcendents ..... 730–732
- backward recursion ..... 85
- Bailey’s  ${}_2F_1(-1)$  sum
  - q*-analog ..... 426
- Bailey’s  ${}_4F_3(1)$  sum
  - q*-analogs (first and second) ..... 427
- Bailey’s  ${}_2\psi_2$  transformations
  - bilateral *q*-hypergeometric function ..... 429
- Bailey’s bilateral summations
  - bilateral *q*-hypergeometric function ..... 427
- bandlimited functions ..... 706
- Barnes’ beta integral ..... 143
- Barnes’ *G*-function
  - asymptotic expansion ..... 144
  - definition ..... 144
  - infinite product ..... 144
  - integral representation ..... 144
  - recurrence relation ..... 144
- Barnes’ integral
  - Ferrers functions ..... 369
- Bartky’s transformation
  - Bulirsch’s elliptic integrals ..... 487
  - symmetric elliptic integrals ..... 504
- basic elliptic integrals ..... 512
- basic hypergeometric functions... *see* bilateral *q*-hypergeometric function *and q*-hypergeometric function.
- Basset’s integral
  - modified Bessel functions ..... 253
- Bell numbers
  - asymptotic approximations ..... 623
  - definition ..... 623
  - generating function ..... 623
  - recurrence relation ..... 623
  - table ..... 623
- Bernoulli monosplines ..... 597
- Bernoulli numbers ..... **588**
  - arithmetic properties ..... 593
  - asymptotic approximations ..... 593
  - computation ..... 598
  - definition ..... 588
  - degenerate ..... 596
  - explicit formulas ..... 591
  - factors ..... 593
  - finite expansions ..... 590
  - generalizations ..... 596, 597
  - generating function ..... 588
  - identities ..... 591
  - inequalities ..... 593
  - integral representations ..... 592
  - inversion formulas ..... 591
  - irregular pairs ..... 598
  - Kummer congruences ..... 593
  - notation ..... 588
  - of the second kind ..... 596
  - recurrence relations
    - linear ..... 591
    - quadratic and higher order ..... 595
  - relations to
    - Eulerian numbers ..... 591
    - Genocchi numbers ..... 595
    - Stirling numbers ..... 596
    - tangent numbers ..... 596
  - sums ..... 595
  - tables ..... 589, 598
- Bernoulli polynomials ..... **588**
  - applications
    - mathematical ..... 597–598
    - physical ..... 598
  - asymptotic approximations ..... 593
  - computation ..... 598
  - definitions ..... 588
  - derivative ..... 590
  - difference equation ..... 589
  - explicit formulas ..... 591
  - finite expansions ..... 590
  - generalized ..... 596, 597
  - generating function ..... 588
  - graphs ..... 589
  - inequalities ..... 593
  - infinite series expansions
    - Fourier ..... 592

- other ..... 592
- integral representations ..... 592
- integrals ..... 594
  - compendia ..... 595
- Laplace transforms ..... 595
- multiplication formulas ..... 590
- notation ..... 588
- recurrence relations
  - linear ..... 591
  - quadratic ..... 595
- relation to Eulerian numbers ..... 591
- relation to Riemann zeta function ..... 591
- representation as sums of powers ..... 589
- special values ..... 590
- sums ..... 595
- symbolic operations ..... 590
- symmetry ..... 589
- tables ..... 589
- zeros
  - complex ..... 594
  - multiple ..... 594
  - real ..... 594
- Bernoulli's lemniscate ..... 515
- Bernstein–Szegő polynomials ..... 474
- Bessel functions ..... **217**
  - ..... *see also* cylinder functions, Hankel functions, Kelvin functions, modified Bessel functions, *and* spherical Bessel functions.
  - addition theorems ..... 246
  - analytic continuation ..... 226
  - applications
    - asymptotic solutions of differential equations ..... 274–275
    - electromagnetic scattering ..... 275
    - Helmholtz equation ..... 275
    - Laplace's equation ..... 275
    - oscillation of chains ..... 275
    - oscillation of plates ..... 276
    - wave equation ..... 275
  - approximations ..... 281
  - asymptotic expansions for large argument .. 228–230
    - error bounds ..... 229–230
    - exponentially-improved ..... 230
  - asymptotic expansions for large order ..... 231–235
    - asymptotic forms ..... 231
    - Debye's expansions ..... 231–232
    - double asymptotic properties ..... 235, 258
    - resurgence properties of coefficients ..... 233
    - transition region ..... 232
    - uniform ..... 232–235
  - branch conventions ..... 218
  - computation ..... 276–277
  - computation by quadrature ..... 83
  - computation by recursion ..... 87
  - connection formulas ..... 222
  - contiguous ..... 235
  - continued fractions ..... 226
  - cross-products ..... 222, 223
    - zeros ..... 238
  - definite integrals ..... 203
  - definitions ..... 217–218
  - derivatives
    - asymptotic expansions for large argument ..... 229
    - asymptotic expansions for large order ..... 231–232
    - explicit forms ..... 222
    - uniform asymptotic expansions for large order ..... 232
      - with respect to order ..... 227–228
    - zeros ..... *see* zeros of Bessel functions.
  - differential equations ..... 217, 226
    - ..... *see also* Bessel's equation.
  - Dirac delta ..... 38
  - envelope functions ..... 61
  - expansions in partial fractions ..... 247
  - expansions in series of ..... 247–248
  - Fourier–Bessel expansion ..... 248
  - generalized ..... 261
  - generating functions ..... 226
  - graphics ..... 218–222
  - incomplete ..... 261
  - inequalities ..... 227
  - infinite integrals ..... 448
  - infinite products ..... 235
  - integral representations
    - along the real line ..... 223–224
    - compendia ..... 226
    - contour integrals ..... 224–225
    - Mellin–Barnes type ..... 225
    - products ..... 225
  - integrals ..... *see also* integrals of Bessel and Hankel functions *and* Hankel transforms.
    - approximations ..... 281
    - computation ..... 277
    - tables ..... 279, 280
  - limiting forms ..... 223
  - minimax rational approximation ..... 98
  - modulus and phase functions
    - asymptotic expansions for large argument ..... 231
    - basic properties ..... 230
    - definitions ..... 230
    - graphics ..... 218
    - relation to zeros ..... 235
  - monotonicity ..... 227
  - multiplication theorem ..... 246
  - notation ..... 217
  - of imaginary argument
    - ..... *see* modified Bessel functions.
  - of imaginary order

- applications ..... 248
    - definitions ..... 248
    - graphs ..... 221–222
    - limiting forms ..... 248
    - numerically satisfactory pairs ..... 248
    - uniform asymptotic expansions for large order  
..... 248
    - zeros ..... 248
  - of matrix argument ..... **769**
    - applications ..... 773
    - asymptotic approximations ..... 770
    - definitions ..... 769
    - notation ..... 768
    - of the first and second kinds ..... 768
    - properties ..... 769
    - relations to confluent hypergeometric functions of  
matrix argument ..... 770
  - of the first, second, and third kinds ..... 217–218
  - orthogonality ..... 243, 244
  - power series ..... 223
  - principal branches (or values) ..... 217–218
  - recurrence relations ..... 222–223
  - relations to other functions
    - Airy functions ..... 196–197
    - confluent hypergeometric functions ..... 228
    - elementary functions ..... 228
    - generalized Airy functions ..... 206
    - generalized hypergeometric functions ..... 228
    - parabolic cylinder functions ..... 228, 315
  - sums ..... 246–248
    - addition theorems ..... 246–247
    - compendia ..... 248
    - expansions in series of Bessel functions ... 247–248
    - multiplication theorem ..... 246
  - tables ..... 278–279
  - Wronskians ..... 222
  - zeros ..... *see* zeros of Bessel functions.
- Bessel polynomials ..... 264, 476
- asymptotic expansions ..... 476
  - definition ..... 476
  - differential equations ..... 476
  - generalized ..... 476
  - orthogonality properties ..... 476
  - recurrence relations ..... 476
  - relations to other functions
    - complex orthogonal polynomials ..... 83
    - confluent hypergeometric functions ..... 476
    - generalized hypergeometric functions ..... 476
    - Jacobi polynomials ..... 476
- Bessel transform ..... *see* Hankel transform.
- Bessel's equation ..... 217
- inhomogeneous forms ..... 288, 294, 295
  - numerically satisfactory solutions ..... 218
  - singularities ..... 217
  - standard solutions ..... 217–218
- Bessel's inequality
- Fourier series ..... 13
- Bessel's integral
- Bessel functions ..... 223
- best uniform polynomial approximation ..... 96
- best uniform rational approximation ..... 97
- beta distribution
- incomplete beta functions ..... 189
- beta function ..... **142**
- ..... *see also* incomplete beta functions.
  - applications
    - physical ..... 145–146
  - definition ..... 142
  - integral representations ..... 142
    - multidimensional ..... 143
  - integrals ..... 143
  - multivariate ..... *see* multivariate beta function.
- beta integrals ..... 142–143
- Bickley function ..... 259
- applications ..... 276
  - approximations ..... 281
- biconfluent Heun equation ..... 718
- application to Rossby waves ..... 720
- Bieberbach conjecture ..... 417, 479
- Jacobi polynomials ..... 479
- bifurcation sets ..... 781
- visualizations ..... 782
- big  $q$ -Jacobi polynomials ..... 471
- bilateral basic hypergeometric function  
..... *see* bilateral  $q$ -hypergeometric function.
- bilateral hypergeometric function ..... 408
- bilateral  $q$ -hypergeometric function
- Bailey's  ${}_2\psi_2$  transformations ..... 429
  - Bailey's bilateral summations ..... 427
  - computation ..... 432
  - definition ..... 423
  - notation ..... 420
  - Ramanujan's  ${}_1\psi_1$  summation ..... 427
  - special cases ..... 427–428
  - transformations ..... 432
- bilateral series ..... 408
- bilinear transformation ..... 17
- cross ratio ..... 17
  - $SL(2, \mathbb{Z})$  ..... 579
- binary number system ..... 72
- binary quadratic sieve
- number theory ..... 648
- Binet's formula
- gamma function ..... 140
- binomial coefficients
- definitions ..... 619
  - generating functions ..... 619
  - identities ..... 619

- limiting form . . . . . 619
- recurrence relations . . . . . 619
- relation to lattice paths . . . . . 619
- tables . . . . . 619, 635
- binomial expansion . . . . . 108
- binomial theorem . . . . . 2
- binomials . . . . . 2
- black holes
  - Heun functions . . . . . 720
- Bohr radius
  - Coulomb functions . . . . . 754
- Bohr-Mollerup theorem
  - gamma function . . . . . 138
  - $q$ -gamma function . . . . . 145
- Boole summation formula . . . . . 597
- Borel summability . . . . . 33
- Borel transform theory
  - applications to asymptotic expansions . . . . . 68
- Bose–Einstein condensates
  - Lamé functions . . . . . 694
- Bose–Einstein integrals
  - computation . . . . . 614
  - definition . . . . . 611
  - relation to polylogarithms . . . . . 612
- Bose–Einstein phase transition . . . . . 614
- bound-state problems
  - hydrogenic . . . . . 754
  - Whittaker functions . . . . . 754
- boundary points . . . . . 11, 15
- boundary-value methods or problems
  - difference equations . . . . . 86, 87
  - ordinary differential equations . . . . . 88
  - parabolic cylinder functions . . . . . 317
- bounded variation . . . . . 6
- Boussinesq equation
  - Painlevé transcendents . . . . . 739
- box
  - plane partitions . . . . . 629
- branch
  - of multivalued function . . . . . 20, 104
    - construction . . . . . 20
    - example . . . . . 20
- branch cut . . . . . 104
- branch point . . . . . 20
  - movable . . . . . 724
- Bromwich integral . . . . . 83
- Bulirsch’s elliptic integrals . . . . . 487
  - computation . . . . . 518
  - first, second, and third kinds . . . . . 486
  - notation . . . . . 486
  - relation to symmetric elliptic integrals . . . . . 508
- calculus
  - complex variable . . . . . 14–18
  - one variable . . . . . 4–7
  - two or more variables . . . . . 7–9
- calculus of finite differences . . . . . 597
- canonical integrals . . . . . 776
  - applications
    - acoustics . . . . . 792
    - caustics . . . . . 791
    - integrals with coalescing critical points . . . . . 789–790
    - optics . . . . . 791
    - quantum mechanics . . . . . 791
  - asymptotic approximations . . . . . 789–790
  - computation . . . . . 792
  - convergent series . . . . . 787
  - definitions . . . . . 776
  - differential equations . . . . . 788
  - integral identities . . . . . 787–788
  - notation . . . . . 776
  - relations to other functions
    - Airy function . . . . . 777
    - Pearcey integral . . . . . 777
  - special cases . . . . . 777
  - symmetries . . . . . 777
  - visualizations of modulus . . . . . 778–779
  - visualizations of phase . . . . . 780–781
  - zeros . . . . . 785–787
- cardinal function . . . . . 77
- cardinal monosplines . . . . . 597–598
- cardinal spline functions . . . . . 597
- Carmichael numbers
  - number theory . . . . . 644
- Casimir forces
  - Bernoulli polynomials . . . . . 598
- Casimir–Polder effect
  - Riemann zeta function . . . . . 614
- Catalan numbers
  - definitions . . . . . 620
  - generating function . . . . . 621
  - identities . . . . . 623
  - limiting forms . . . . . 621
  - recurrence relations . . . . . 621
  - relation to lattice paths . . . . . 620
  - table . . . . . 621
- Catalan’s constant
  - Riemann zeta function . . . . . 610
- Cauchy determinant . . . . . 4
- Cauchy principal values
  - integrals . . . . . 6
- Cauchy’s integral formula . . . . . 16
  - for derivatives . . . . . 16
- Cauchy’s theorem . . . . . 16
- Cauchy–Riemann equations . . . . . 16
- Cauchy–Schwarz inequalities for sums and integrals
  - . . . . . 12, 13
- caustics
  - Airy functions . . . . . 209

- canonical integrals ..... 791
- Cayley's identity for Schwarzian derivatives ..... 27
- central differences in imaginary direction ..... 436
- Cesàro means ..... 33
- Cesàro summability ..... 33, 34
- chain rule
  - for derivatives ..... 5, 7
- characteristic equation
  - difference equations ..... 62
  - differential equations ..... 56
- characteristics
  - Riemann theta functions ..... 539
- characters
  - number theory
    - Dirichlet ..... 642
    - induced modulus ..... 642
    - orthogonality relation ..... 642
    - primitive ..... 642
    - principal ..... 642
    - quadratic Jacobi symbol ..... 642
    - quadratic Legendre symbol ..... 642
    - real ..... 642
- Charlier polynomials
  - ..... *see* Hahn class orthogonal polynomials.
- Chebyshev  $\psi$ -function ..... 613
- Chebyshev polynomials ..... 438
  - .. *see also* Chebyshev-series expansions *and* classical orthogonal polynomials.
  - applications
    - approximation theory ..... 478
    - solutions of differential equations ..... 478
  - computation ..... 479
  - continued fractions ..... 450
  - definition ..... 439
  - derivatives ..... 447
  - differential equations ..... 445
  - dilated ..... 437
  - expansions in series of ..... 96, 459, 461
  - explicit representations ..... 442–443
  - generating functions ..... 449
  - graphs ..... 440
  - inequalities ..... 450
  - integral representations ..... 448
  - integrals ..... 458
  - interrelations with other classical orthogonal polynomials ..... 444–445
  - leading coefficients ..... 439
  - linearization formula ..... 460
  - local maxima and minima ..... 451
  - normalization ..... 439
  - notation ..... 436
  - of the first, second, third, and fourth kinds ..... 439
  - orthogonality properties
    - with respect to integration ..... 96, 439
    - with respect to summation ..... 97, 440
  - recurrence relations ..... 96, 446
  - relations to other functions
    - hypergeometric function ..... 394
    - Jacobi polynomials ..... 444
    - trigonometric functions ..... 442
  - Rodrigues formula ..... 442
  - scaled ..... 478
  - shifted ..... 437, 439
  - special values ..... 444
  - symmetry ..... 444
  - tables ..... 480
    - of coefficients ..... 440
  - upper bounds ..... 451
  - weight functions ..... 439
  - zeros ..... 438, 440
- Chebyshev-series expansions
  - complex variables ..... 97
  - computation of coefficients ..... 97
  - relation to minimax polynomials ..... 97
  - summation ..... 97
- chemical reactions
  - $3j, 6j, 9j$  symbols ..... 765
- chi-square distribution function
  - incomplete gamma functions ..... 189
- Chinese remainder theorem
  - number theory ..... 647
- Christoffel coefficients (or numbers) ..... *see* Gauss quadrature, Christoffel coefficients (or numbers)
- Christoffel-Darboux formula
  - classical orthogonal polynomials ..... 438
  - confluent form ..... 438
- Chu–Vandermonde identity
  - hypergeometric function ..... 387
- circular trigonometric functions
  - ..... *see* trigonometric functions.
- classical dynamics
  - Jacobian elliptic functions ..... 566
  - Weierstrass elliptic functions ..... 582
- classical orthogonal polynomials ..... 438
  - addition theorems ..... 459
    - applications
      - approximation theory ..... 478
      - Bieberbach conjecture ..... 479
      - integrable systems ..... 478
      - numerical solution of differential equations ..... 478
      - physical ..... 479
      - quadrature ..... 478
      - quantum mechanics ..... 479
      - Radon transform ..... 479
      - random matrix theory ..... 479
      - Riemann–Hilbert problems ..... 479
    - asymptotic approximations ..... 451–454
    - computation ..... 479



- connection formulas ..... 460  
 contiguous relations ..... 446  
 continued fractions ..... 450  
 definitions ..... 438–439  
 derivatives ..... 446–447  
 differential equations ..... 445  
 expansions in series of ..... 459–461  
 explicit representations ..... 442–443  
 Fourier transforms ..... 456–457  
 generating functions ..... 449  
 in two or more variables ..... 477  
 inequalities  
   local maxima and minima ..... 450–451  
   Turan-type ..... 450  
   upper bounds ..... 450  
 integral representations ..... 447–448  
   for products ..... 455  
 integrals ..... 455–459  
   compendia ..... 459  
 interrelations  
   limiting forms ..... 445  
   linear ..... 444  
   quadratic ..... 445  
   with other orthogonal polynomials ..... 464  
 Laplace transforms ..... 457  
 leading coefficients ..... 439  
 limiting forms  
   Mehler–Heine type formulas ..... 449  
 linearization formulas ..... 460  
 local maxima and minima ..... 450–451  
 Mellin transforms ..... 457  
 multiplication theorems ..... 460  
 normalization ..... 439  
 notations ..... 436  
 orthogonality properties ..... 439, 443  
 parameter constraints ..... 439, 443  
 Poisson kernels ..... 461  
 recurrence relations ..... 446  
 relations to other functions  
   confluent hypergeometric functions ..... 442  
   generalized hypergeometric functions ..... 442  
   hypergeometric function ..... 393–394, 442  
 sums ..... 459–461  
   Bateman-type ..... 461  
   compendia ..... 461  
 tables ..... 480  
   of coefficients ..... 440  
 upper bounds ..... 450  
 weight functions ..... 439  
 zeros  
   asymptotic approximations ..... 454–455  
   distribution ..... 438  
   inequalities ..... 454  
 classical theta functions ..... *see* theta functions.
- Clausen’s integral ..... 611  
   tables ..... 614  
 Clebsch–Gordan coefficients ..... *see*  $3j$  symbols.  
   relation to generalized hypergeometric functions  
   ..... 418  
 Clenshaw’s algorithm  
   Chebyshev series ..... 97  
   classical orthogonal polynomials ..... 480  
 Clenshaw–Curtis quadrature formula ..... 79, 82  
   comparison with Gauss quadrature ..... 80  
 closed point set ..... 11, 15  
 closure  
   of interval ..... 6  
   of point sets in complex plane ..... 15  
 coalescing saddle points ..... 789–790  
 coaxial circles  
   symmetric elliptic integrals ..... 516  
 coding theory  
   combinatorics ..... 635  
   Krawtchouk and  $q$ -Racah polynomials ..... 479  
 cofactor ..... *see* determinants.  
 coherent states  
   generalized  
   confluent hypergeometric functions ..... 346  
 cols ..... *see* saddle points.  
 combinatorial design ..... 635  
 combinatorics ..... 618  
   applications ..... 635  
   mathematical ..... 635  
   physical ..... 635  
   generalized hypergeometric functions ..... 417  
   hypergeometric identities ..... 400  
   Painlevé transcendents ..... 739  
 compact set ..... 18  
 complementary error function ..... *see* error functions.  
 complementary exponential integral  
   ..... *see* exponential integrals.  
 completely multiplicative functions ..... 640  
 complex numbers  
   arithmetic operations ..... 15  
   complex conjugates ..... 15  
   DeMoivre’s theorem ..... 15  
   imaginary part ..... 14  
   modulus ..... 15  
   phase ..... 15  
   polar representation ..... 14  
   powers ..... 15  
   real part ..... 14  
   triangle inequality ..... 15  
 complex physical systems  
   incomplete gamma functions ..... 189  
 complex tori  
   theta functions ..... 533  
 computer arithmetic

- generalized exponentials and logarithms . . . . . 131
- computer-aided design
  - Cornu's spiral . . . . . 169
- conductor
  - generalized Bernoulli polynomials . . . . . 597
- confluent Heun equation . . . . . 717
  - applications . . . . . 720
  - properties of solutions . . . . . 718
  - special cases . . . . . 717
- confluent hypergeometric functions . . *see also* Kummer functions *and* Whittaker functions.
  - of matrix argument . . . . . **770**
    - asymptotic approximations . . . . . 771
    - computation . . . . . 773
    - definition . . . . . 770
    - first kind . . . . . 768
    - Laguerre form . . . . . 770
    - notation . . . . . 768
    - properties . . . . . 770
    - relations to Bessel functions of matrix argument . . . . . 770
    - second kind . . . . . 768
  - relations to other functions
    - Airy functions . . . . . 197
    - Bessel and Hankel functions . . . . . 228
    - classical orthogonal polynomials . . . . . 442
    - Coulomb functions . . . . . 742, 748
    - error functions . . . . . 164
    - exponential integrals . . . . . 153
    - generalized Bessel polynomials . . . . . 476
    - generalized exponential integral . . . . . 186
    - Hahn class orthogonal polynomials . . . . . 466
    - modified Bessel functions . . . . . 255
    - parabolic cylinder functions . . . . . 308, 315
    - repeated integrals of error functions . . . . . 167
    - sine and cosine integrals . . . . . 153
- conformal mapping . . . . . 16–17
  - generalized hypergeometric functions . . . . . 417
  - hypergeometric function . . . . . 399
  - Jacobian elliptic functions . . . . . 564
  - modular functions . . . . . 581
  - symmetric elliptic integrals . . . . . 515
  - Weierstrass elliptic functions . . . . . 581
- congruence of rational numbers . . . . . 593
- conical functions . . . . . **372**
  - applications . . . . . 379
    - asymptotic approximations
      - large degree . . . . . 374
      - large order . . . . . 374
    - behavior at singularities . . . . . 373
    - connection formulas . . . . . 372
    - definitions . . . . . 372
    - degree . . . . . 352
    - differential equation . . . . . 372
    - generalized Mehler–Fock transformation . . . . . 373
    - graphics . . . . . 373
    - integral representation . . . . . 373
    - integrals with respect to degree . . . . . 375
    - notation . . . . . 352, 372
    - order . . . . . 352
    - tables . . . . . 380
    - trigonometric expansion . . . . . 373
    - Wronskians . . . . . 372
    - zeros . . . . . 375
- connected point set . . . . . 15
- constants
  - roots of . . . . . 23
- continued fractions . . . . . 24–25
  - applications . . . . . 25
  - approximants . . . . . 24
  - canonical denominator (or numerator) . . . . . 24
  - contraction . . . . . 25
  - convergence . . . . . 25
  - convergents . . . . . 24
    - existence of . . . . . 25
  - determinant formula . . . . . 24
  - equivalent . . . . . 24
  - even part . . . . . 25
  - extension . . . . . 25
  - fractional transformations . . . . . 25
  - J*-fraction . . . . . 95
  - Jacobi fraction . . . . . 95
    - associated . . . . . 95
  - notation . . . . . 24
  - numerical evaluation
    - backward recurrence . . . . . 95
    - forward recurrence . . . . . 95
    - forward series recurrence . . . . . 96
  - odd part . . . . . 25
  - Pringsheim's theorem . . . . . 25
  - quotient-difference algorithm . . . . . 95
  - recurrence relations . . . . . 24
  - relation to power series . . . . . 94, 95
  - S*-fraction . . . . . 95
  - series . . . . . 24
  - Stieltjes fraction . . . . . 95
  - Van Vleck's theorem . . . . . 25
- continuous dual Hahn polynomials
  - . . . . . *see* Wilson class orthogonal polynomials.
- continuous dynamical systems and mappings
  - Painlevé transcendents . . . . . 739
- continuous function
  - at a point . . . . . 4, 7, 15
  - notation . . . . . 4
  - of two variables . . . . . 7, 15
  - on a point set . . . . . 7
  - on a region . . . . . 15
  - on an interval . . . . . 4

- on the left (or right).....4
- piecewise.....4, 7
- removable discontinuity.....4
- sectionally.....4
- simple discontinuity.....4
- continuous Hahn polynomials
  - ..... *see* Hahn class orthogonal polynomials.
- continuous  $q$ -Hermite polynomials.....473
- continuous  $q^{-1}$ -Hermite polynomials.....473
  - asymptotic approximations to zeros.....474
- continuous  $q$ -ultraspherical polynomials.....473
- contour.....16
  - simple.....16
  - simple closed.....16
- convergence
  - acceleration..... *see* acceleration of convergence.
  - cubic.....90
  - geometric.....90
  - linear.....90
  - local.....90
  - of the  $p$ th order.....90
  - quadratic.....90
- convex functions.....7
- coordinate systems
  - cylindrical.....7
  - ellipsoidal.....582, 693
  - elliptic.....720
  - elliptical.....677–678
  - oblate spheroidal.....705
  - parabolic cylinder.....317
  - paraboloid of revolution.....317
  - paraboloidal.....346, 678
  - polar.....7
  - projective.....581
  - prolate spheroidal.....704
  - spherical (or spherical polar).....8
  - sphero-conal.....693
  - toroidal.....371, 379
- Cornu's spiral.....168
  - applications.....169
  - connection with Fresnel integrals.....168
- cosecant function..... *see* trigonometric functions.
- cosine function..... *see* trigonometric functions.
- cosine integrals.....150
  - analytic continuation.....151
  - applications.....155
  - approximations.....156
  - asymptotic expansions.....153
    - exponentially-improved.....154
  - auxiliary functions... *see* auxiliary functions for sine and cosine integrals.
  - Chebyshev-series expansions.....156–157
  - computation.....155
  - definition.....150
  - expansion in spherical Bessel functions.....153
  - generalized.....188–189
  - graphics.....151
  - hyperbolic analog.....150
    - analytic continuation.....151
  - integral representations.....152
  - integrals.....154
  - Laplace transform.....154
  - notation.....150
  - power series.....151
  - principal value.....150
  - relations to exponential integrals.....151
  - sums.....154
  - tables.....156
  - value at infinity.....150
  - zeros.....154
    - asymptotic expansion.....154
    - computation.....156
- cosmology
  - confluent hypergeometric functions.....346
  - incomplete beta functions.....189
- cotangent function..... *see* trigonometric functions.
- Coulomb excitation of nuclei.....753
- Coulomb field.....754
- Coulomb functions
  - Dirac delta.....38
- Coulomb functions: variables  $\rho, \eta$ .....742
  - analytic properties.....742
  - applications.....753–755
  - asymptotic expansions
    - large  $\eta$ .....747
    - large  $\rho$ .....747
    - uniform expansions.....747–748
  - case  $\eta = 0$ .....744
  - complex variable and parameters.....748, 754
  - computation.....755
  - continued fractions.....745
  - conversions between variables and parameters...754
  - cross-product.....742
  - definitions.....742
  - derivatives.....744
  - expansions in Airy functions.....747
  - expansions in Bessel functions.....746
  - expansions in modified Bessel functions.....746
  - expansions in spherical Bessel functions.....745
  - functions  $F_\ell(\eta, \rho), G_\ell(\eta, \rho), H_\ell^\pm(\eta, \rho)$ .....742
  - graphics.....743–744
  - integral representations.....745
  - limiting forms
    - large  $\ell$ .....744
    - large  $|\eta|$ .....746
    - large  $\rho$ .....746, 747
    - small  $|\eta|$ .....744
    - small  $\rho$ .....744

- normalizing constant . . . . . 742
- phase shift (or phase) . . . . . 742, 756
- power-series expansions in  $\rho$  . . . . . 745
- recurrence relations . . . . . 744
- relations to other functions
  - confluent hypergeometric functions . . . . . 742
  - Coulomb functions with variables  $r, \epsilon$  . . . . . 751
  - Whittaker functions . . . . . 742
- scaling of variables and parameters . . . . . 753, 754
- tables . . . . . 755
- transition region . . . . . 747
- WKBJ approximations . . . . . 755
- Wronskians . . . . . 742
- Coulomb functions: variables  $r, \epsilon$  . . . . . **748**
  - analytic properties . . . . . 748
  - applications . . . . . 753–755
  - asymptotic approximations and expansions for large  $|r|$  . . . . . 753
  - asymptotic expansions as  $\epsilon \rightarrow 0$  . . . . . 753
    - uniform . . . . . 753
  - case  $\epsilon = 0$  . . . . . 752
  - complex variables and parameters . . . . . 754
  - computation . . . . . 755
  - conversions between variables and parameters . . . . . 754
  - definitions . . . . . 748
  - derivatives . . . . . 752
  - expansions in Airy functions . . . . . 753
  - expansions in Bessel functions . . . . . 752, 753
  - expansions in modified Bessel functions . . . . . 752, 753
  - functions  $f(\epsilon, \ell; r), h(\epsilon, \ell; r)$  . . . . . 748
  - functions  $s(\epsilon, \ell; r), c(\epsilon, \ell; r)$  . . . . . 748
  - graphics . . . . . 749–750
  - integral representations for Dirac delta . . . . . 749
  - limiting forms for large  $\ell$  . . . . . 752
  - power-series expansions in  $\epsilon$  . . . . . 752
  - power-series expansions in  $r$  . . . . . 752
  - recurrence relations . . . . . 752
  - relations to other functions
    - confluent hypergeometric functions . . . . . 748
    - Coulomb functions with variables  $\rho, \eta$  . . . . . 751
    - Whittaker functions . . . . . 748, 751
  - scaling of variables and parameters . . . . . 753, 754
  - tables . . . . . 755
  - Wronskians . . . . . 749
- Coulomb phase shift . . . . . 145, 742, 755, 756
- Coulomb potential barriers . . . . . 754
- Coulomb potentials . . . . . 753–754
  - $q$ -hypergeometric function . . . . . 432
- Coulomb radial functions
  - . . . . . *see* Coulomb functions: variables  $\rho, \eta$ .
- Coulomb spheroidal functions . . . . . 704
  - as confluent Heun functions . . . . . 717
- Coulomb wave equation
  - irregular solutions . . . . . 742, 748
  - regular solutions . . . . . 742, 748
  - singularities . . . . . 742, 748
  - turning points . . . . . 742, 748, 754
- Coulomb wave functions . . *see* Coulomb functions: variables  $\rho, \eta$  and Coulomb functions: variables  $r, \epsilon$ .
- counting techniques . . . . . 634
- critical phenomena
  - elliptic integrals . . . . . 517
  - hypergeometric function . . . . . 400
- critical points . . . . . **781**
  - coalescing . . . . . 789–790
- cross ratio . . . . . 17
- cryptography . . . . . 647
  - Weierstrass elliptic functions . . . . . 582
- cubature
  - for disks and squares . . . . . 84–85
- cubic equation . . . . . 23
  - resolvent . . . . . 23
- cubic equations
  - solutions as trigonometric and hyperbolic functions . . . . . 131
- curve
  - piecewise differentiable . . . . . 11
  - simple closed . . . . . 11
- cusp bifurcation set
  - formula . . . . . 781
  - picture . . . . . 782
- cusp canonical integral . . . . . **776**, 785
  - zeros . . . . . 785
    - table . . . . . 786
- cusp catastrophe . . . . . **776**, 784
- cuspsoids
  - normal forms . . . . . 776
- cut . . . . . 20
  - domain . . . . . 20
  - neighborhood . . . . . 20
- cycle . . . . . 618
  - Riemann surface . . . . . 543
- cyclic identities
  - Jacobian elliptic functions . . . . . 558
- cyclotomic fields
  - Bernoulli and Euler polynomials . . . . . 598
- cylinder functions
  - addition theorems . . . . . 246
  - definition . . . . . 218
  - derivatives . . . . . 222
  - differential equations . . . . . 217, 226
  - integrals . . . . . 240–241
  - multiplication theorem . . . . . 246
  - recurrence relations . . . . . 222
  - zeros . . . . . *see* zeros of cylinder functions.
- cylindrical coordinates . . . . . 7
- cylindrical polar coordinates
  - . . . . . *see* cylindrical coordinates.

- Darboux's method  
 asymptotic approximations of sums and sequences  
 ..... 65–66
- Dawson's integral ..... 160  
 applications ..... 169  
 approximations ..... 170  
 computation ..... 169  
 definition ..... 160  
 generalized ..... 166  
 graphics ..... 161  
 integral representation ..... 162  
 notation ..... 160  
 relation to error functions ..... 162  
 relation to parabolic cylinder functions ..... 308  
 tables ..... 169
- de Branges–Wilson beta integral ..... 143
- De Moivre's theorem  
 trigonometric functions ..... 118
- Dedekind modular function ..... 646  
 functional equation ..... 646
- Dedekind sums  
 number theory ..... 646
- Dedekind's eta function ..... *see* modular functions.
- Dedekind's modular function ... *see* modular functions.
- del operator ..... 10
- Dellano numbers  
 definition ..... 621  
 generating functions ..... 623  
 recurrence relation ..... 623  
 relation to lattice paths ..... 621  
 table ..... 621
- delta sequence ..... 37
- delta wing equation  
 Lamé polynomials ..... 694
- derivatives  
 chain rule ..... 5, 7  
 definition ..... 5, 7  
 distributional ..... 36  
 Faà di Bruno's formula ..... 5  
 Jacobian ..... 9  
 L'Hôpital's rule ..... 5  
 left-hand ..... 14  
 Leibniz's formula ..... 5  
 mean value theorem ..... 5  
 notation ..... 5, 7  
 of distribution ..... 35  
 partial ..... 7  
 right-hand ..... 14
- Descartes' rule of signs (for polynomials) ..... 22
- determinants  
 alternants ..... 3  
 Cauchy ..... 4  
 circulant ..... 4  
 cofactor ..... 3
- definition ..... 3
- Hadamard's inequality ..... 3
- Hankel ..... 93, 595
- inequalities ..... 3
- infinite  
 convergence ..... 4  
 Hill's type ..... 4
- Krattenthaler's formula ..... 4
- minor ..... 3
- notation ..... 3
- persymmetric ..... 595
- properties ..... 3
- Vandermonde ..... 3
- diatomic molecules  
 hypergeometric function ..... 400
- difference equations  
 asymptotic solutions  
 .. *see* asymptotic solutions of difference equations.  
 distinguished solutions ..... 85  
 minimal solutions ..... 85  
 numerical solution ..... 85–88  
 backward recursion method ..... 85, 86  
 boundary-value methods ..... 86, 87  
 homogeneous equations ..... 85–86  
 inhomogeneous equations ..... 86  
 normalizing factor ..... 86  
 stability ..... 85  
 recessive solutions ..... 85
- difference operators ..... 436  
 backward ..... 436  
 central in imaginary direction ..... 436  
 forward ..... 436
- differentiable functions ..... 5, 15
- differential equations  
 asymptotic solutions ..... *see* asymptotic solutions of  
 differential equations.  
 change of variables  
 elimination of first derivative ..... 26  
 Liouville transformation ..... 26  
 point at infinity ..... 26  
 classification of singularities ..... 56, 409  
 closed-form solutions ..... 27  
 dominant solutions ..... 57  
 Fuchs–Frobenius theory ..... 55  
 homogeneous ..... 26, 88  
 indices differing by an integer ..... 56  
 indicial equation ..... 56  
 inhomogeneous ..... 26, 88  
 solution by variation of parameters ..... 26  
 irregular singularity ..... 56  
 nonhomogeneous ..... *see* inhomogeneous.  
 numerical solution  
 boundary-value problems ..... 88  
 eigenfunctions ..... 89

- eigenvalues ..... 89
- initial-value problems ..... 88
- Runge–Kutta method ..... 89–90
- stability ..... 88
- Sturm–Liouville eigenvalue problems ..... 89
- Taylor-series methods ..... 88–89
- numerically satisfactory solutions ..... 58
- of arbitrary order ..... 409
- ordinary point ..... 55, 409
- rank of singularity ..... 56
- recessive solutions ..... 57
- regular singularity ..... 56
- Schwarzian derivative ..... 27
- solutions
  - existence ..... 25
  - fundamental pair ..... 26
  - in series of Chebyshev polynomials ..... 478, 480
  - in series of classical orthogonal polynomials ... 479
  - linearly independent ..... 26
  - products ..... 27
  - Wronskian ..... 26
- subdominant solutions ..... *see* recessive solutions.
- with a parameter ..... 26
- differentiation
  - Cauchy–Riemann equations ..... 16
  - numerical
    - analytic functions ..... 77
    - Lagrange’s formula for equally-spaced nodes ... 77
    - partial derivatives ..... 78
  - of integrals ..... 8, 21
  - partial ..... 7
- diffraction catastrophes ..... 777, 789
- notation ..... 776
- scaling laws ..... 785
- diffraction of light
  - Fresnel integrals and Cornu’s spiral ..... 161, 169
- diffraction problems
  - Mathieu functions ..... 678
- diffusion equations
  - theta functions ..... 533
- diffusion problems
  - Mathieu functions ..... 678
- digamma function ..... *see* psi function.
- dilogarithms
  - analytic properties ..... 610
  - approximations ..... 615
  - computation ..... 614
  - definition ..... 610
  - graphics ..... 611
  - principal branch (or value) ..... 610
  - tables ..... 614
- Dirac delta ..... 37–38
- delta sequences ..... 37–38
- integral representations
  - Airy functions ..... 38
  - Bessel functions ..... 38
  - Coulomb functions ..... 38
  - Fourier ..... 37–38
  - spherical Bessel functions ..... 38
  - mathematical definitions ..... 38
  - series representations
    - Fourier ..... 38
    - Hermite polynomials ..... 38
    - Laguerre polynomials ..... 38
    - Legendre polynomials ..... 38
    - spherical harmonics ..... 38
- Dirac delta distribution ..... 53
- Dirac delta function ..... *see* Dirac delta.
- Dirac equation
  - Coulomb functions ..... 754
- Dirichlet  $L$ -functions
  - analytic properties ..... 612
  - definition ..... 612
  - functional equation ..... 612
  - infinite products ..... 612
  - tables ..... 614
  - zeros ..... 613
- Dirichlet characters ..... 642
  - Gauss sum ..... 643
- Dirichlet problem
  - with toroidal symmetry ..... 379
- Dirichlet product (or convolution) ..... 641
- Dirichlet series ..... 602, 640
  - generating function ..... 640
- Dirichlet’s divisor problem
  - number theory ..... 643
- Dirichlet’s theorem
  - prime numbers in arithmetic progression ..... 643
- discontinuity ..... 4
- discrete Fourier transform ..... 99
- discrete  $q$ -Hermite I and II polynomials ..... 471
- discriminant
  - of a polynomial ..... 22
- discriminant function
  - number theory ..... 646
  - functional equation ..... 646
- disk
  - around infinity ..... 16
  - open ..... 15
- disk polynomials ..... 477
- dislocation theory
  - Heun functions ..... 720
- distribution function
  - Painlevé transcendents ..... 739
- distribution functions
  - connection with
    - incomplete beta functions ..... 189
    - incomplete gamma functions ..... 189

- distributional derivative ..... 36
- distributions ..... 35–37
  - convergence ..... 35, 36
  - convolutions ..... 54
  - derivatives ..... 35
  - Dirac delta ..... 36
  - distributional derivative ..... 36
  - Fourier transforms ..... 37
  - Heaviside function ..... 36
  - linear functionals ..... 35
  - of derivatives ..... 52
  - regular ..... 35
  - regularization ..... 55
  - regularization ..... 55
  - several variables ..... 36–37
  - singular ..... 35
  - support ..... 35
  - tempered ..... *see* tempered distributions, 52
  - test function space ..... 35
  - test functions ..... 35
    - convergence ..... 35
- divergence theorem
  - .. *see* Gauss's theorem for vector-valued functions.
- divergent integrals ..... 51
  - regularization ..... 55
- divided differences
  - definition ..... 76
  - integral representation ..... 76
- divisor function
  - number theory ..... 638
- Dixon's  ${}_3F_2(1)$  sum
  - $q$ -analog ..... 426
- Dixon's sum
  - F. H. Jackson's  $q$ -analog ..... 426
- domain ..... 15
  - closed ..... 15
  - cut ..... 20
  - simply-connected ..... 25
- dominated convergence theorem
  - infinite series ..... 18
- double gamma function ..... *see* Barnes'  $G$ -function.
- double integrals ..... 8–9
  - change of order of integration ..... 9
  - change of variables ..... 9
  - infinite ..... 9
- double sequence ..... 18
  - convergence ..... 18
- double series ..... 18
  - convergence ..... 18
- doubly-confluent Heun equation ..... 717
- Dougall's  ${}_7F_6(1)$  sum
  - F. H. Jackson's  $q$ -analog ..... 427
- Dougall's bilateral sum ..... 387
- Dougall's expansion
  - associated Legendre functions ..... 371
- dual Hahn polynomials
  - ..... *see* Wilson class orthogonal polynomials.
- Duffing's equation
  - Jacobian elliptic functions ..... 565
- dynamical systems
  - Mathieu functions ..... 679
  - Painlevé transcendents ..... 739
- Dyson's integral
  - gamma function ..... 144
- ecological systems
  - incomplete gamma functions ..... 189
- Einstein summation convention for vectors ..... 10
- Eisenstein convention ..... 577
- Eisenstein series
  - Jacobian elliptic functions ..... 559
- electric particle field
  - Stieltjes electrostatic interpretation ..... 719
- electromagnetic scattering
  - Bessel functions and spherical Bessel functions .. 275
- electromagnetic theory
  - sine and cosine integrals ..... 155
- electromagnetic waves
  - Mathieu functions ..... 678
- electron-ion collisions
  - Coulomb functions ..... 753
- electronic structure of heavy elements
  - Coulomb functions ..... 754
- electrostatics
  - Jacobian elliptic functions ..... 566
  - zeros of classical orthogonal polynomials ..... 479
- elementary functions ..... *see* exponential function, hyperbolic functions, inverse hyperbolic functions, inverse trigonometric functions, Lambert  $W$ -function, logarithm function, power function, *and* trigonometric functions.
  - relation to  $R_C$ -function ..... 495
- elementary particle physics
  - conical functions ..... 379
- ellipse
  - elliptic integrals ..... 514
- ellipse arc length
  - Jacobian elliptic functions ..... 563
- ellipsoid
  - capacity ..... 516
  - depolarization ..... 497, 516
  - potential ..... 516
  - self-energy ..... 516
  - surface area ..... 515
  - triaxial ..... 515
- ellipsoidal coordinates ..... 693
  - Weierstrass elliptic functions ..... 582
- ellipsoidal harmonics
  - Lamé polynomials ..... 694
- ellipsoidal wave equation ..... *see* Lamé wave equation.

- elliptic coordinates ..... 720
- elliptic crack and punch problems
  - Lamé polynomials ..... 694
- elliptic curves ..... 564
  - addition law ..... 581
  - definition ..... 581
  - Jacobi–Abel addition theorem ..... 564
  - Jacobian normal form ..... 564
  - Mordell’s theorem ..... 582
  - tables ..... 582
  - Weierstrass elliptic functions ..... 581
- elliptic functions ... *see also* Jacobian elliptic functions  
*and* Weierstrass elliptic functions.
  - general ..... 571
  - representation as Weierstrass elliptic functions  
 ..... 576
  - Weierstrass ..... *see* Weierstrass elliptic functions.
- elliptic integrals .. *see* basic elliptic integrals, Bulirsch’s  
 elliptic integrals, general elliptic integrals, general-  
 izations of elliptic integrals, Legendre’s elliptic in-  
 tegrals, *and* symmetric elliptic integrals.
  - complete
    - quasiconformal mapping ..... 399
  - relations to other functions
    - associated Legendre functions ..... 360
    - Ferrers functions ..... 360
    - Weierstrass elliptic functions ..... 576
- elliptic modular function ..... *see* modular functions.
- elliptic umbilic bifurcation set
  - formula ..... 781
  - picture ..... 782
- elliptic umbilic canonical integral ..... **776**
  - asymptotic approximations ..... 789–790
  - convergent series ..... 787
  - differential equations ..... 788
  - formulas for Stokes set ..... 783
  - integral identity ..... 788
  - pictures of modulus ..... 779
  - pictures of phase ..... 780
  - scaling laws ..... 785
  - zeros ..... 786
- elliptic umbilic catastrophe ..... **776**, 785
- elliptical coordinates
  - Mathieu functions ..... 677–678
- entire functions ..... 16
  - asymptotic expansions ..... 64
  - Liouville’s theorem ..... 16
- enumerative topology
  - Painlevé transcendents ..... 739
- epsilon function ..... *see* Jacobi’s epsilon function.
- equation of Ince .. *see* Hill’s equation, equation of Ince.
- equiconvergent ..... 699
- Erlang loss function
  - incomplete gamma functions ..... 189
- error-control function
  - differential equations ..... 57
- error functions ..... **160**
  - applications
    - asymptotic approximation of integrals ..... 168
    - physics ..... 169
    - statistics ..... 169
    - Stokes phenomenon ..... 168
  - approximations ..... 170
  - asymptotic expansions ..... 164
    - exponentially-improved ..... 164
  - computation ..... 83–84, 169
  - continued fractions ..... 163
  - definitions ..... 160
  - derivatives ..... 163
  - expansions in spherical Bessel functions ..... 162
  - generalized ..... 166
  - graphics ..... 160, 161
  - inequalities ..... 163
  - integral representations ..... 162–163
  - integrals
    - Fourier transform ..... 166
    - Laplace transforms ..... 166
  - interrelations ..... 162
  - inverse functions ..... 166
    - asymptotic expansions ..... 166
    - computation ..... 169
    - power-series expansions ..... 166
  - notation ..... 160
  - power-series expansions ..... 162
  - relations to other functions
    - confluent hypergeometric functions .. 164, 328, 338
    - Dawson’s integral ..... 162
    - Fresnel integrals ..... 162
    - generalized exponential integrals ..... 164
    - incomplete gamma functions ..... 164
    - parabolic cylinder functions ..... 308
    - probability functions ..... 160
    - Voigt functions ..... 167
  - repeated integrals of. ... *see* repeated integrals of the  
 complementary error function.
    - sums ..... 166
    - tables ..... 169, 170
    - values at infinity ..... 160
    - zeros ..... 165
      - asymptotic expansions ..... 165
      - tables ..... 165, 170
- error measures
  - absolute error ..... 73
  - complex arithmetic ..... 73
  - mollified error ..... 73
  - relative error ..... 73
  - relative precision ..... 73
- error term ..... 43



- essential singularity ..... 19
  - ..... *see also* isolated essential singularity.
- eta function ..... *see* Dedekind's eta function.
- Euler–Maclaurin formula ..... 63
  - extensions ..... 63
  - generalization ..... 597
- Euler numbers ..... **588**
  - arithmetic properties ..... 593
  - asymptotic approximations ..... 593
  - computation ..... 598
  - definition ..... 588
  - explicit formulas ..... 591
  - factors ..... 593
  - finite expansions ..... 590
  - generalizations ..... 596, 597
  - generating function ..... 588
  - identities ..... 591
  - inequalities ..... 593
  - integral representation ..... 592
  - inversion formulas ..... 591
  - Kummer congruences ..... 593
  - notation ..... 588
  - recurrence relations
    - linear ..... 591
    - quadratic and higher order ..... 595
  - sums ..... 595
  - tables ..... 589, 598
- Euler polynomials ..... **588**
  - applications
    - mathematical ..... 597–598
    - physical ..... 598
  - asymptotic approximations ..... 593
  - computation ..... 598
  - definition ..... 588
  - derivative ..... 590
  - difference equation ..... 589
  - explicit formulas ..... 591
  - finite expansions ..... 590
  - generalized ..... 596, 597
  - generating function ..... 588
  - graphs ..... 589
  - inequalities ..... 593
  - infinite series expansions
    - Fourier ..... 592
    - other ..... 592
  - integral representations ..... 592
  - integrals ..... 594
    - compendia ..... 595
  - Laplace transforms ..... 595
  - multiplication formulas ..... 590
  - notation ..... 588
  - recurrence relations
    - linear ..... 591
    - quadratic ..... 595
  - representations as sums of powers ..... 589
  - special values ..... 590
  - sums ..... 595
  - symbolic operations ..... 590
  - symmetry ..... 589
  - tables ..... 589
  - zeros
    - complex ..... 594
    - multiple ..... 594
    - real ..... 594
- Euler product
  - number theory ..... 640
- Euler splines ..... 597
- Euler sums
  - Riemann zeta function ..... 613
    - reciprocity law ..... 614
- Euler's beta integral ..... 142
- Euler's constant ..... 136
  - integral representations ..... 140
- Euler's homogeneity relation
  - symmetric elliptic integrals ..... 501
- Euler's integral
  - gamma function ..... 136
- Euler's pentagonal number theorem
  - number theory ..... 646
- Euler's sums
  - $q$ -hypergeometric function ..... 423, 424
- Euler's totient
  - number theory ..... 638
- Euler's transformation
  - applied to asymptotic expansions ..... 69
  - of series ..... 93
- Euler–Fermat theorem
  - number theory ..... 638, 647
- Euler–Poisson differential equations ..... 501
- Euler–Poisson–Darboux equation
  - symmetric elliptic integrals ..... 501
- Euler–Tricomi equation
  - Airy functions ..... 209
- Eulerian numbers
  - definition ..... 632
  - generating functions ..... 632
  - identities ..... 632
  - notation ..... 632
  - relation to Bernoulli numbers ..... 591
  - relation to permutations ..... 632
  - special values ..... 633
  - table ..... 632
- evolution equations
  - Lamé polynomials ..... 694
- exact rational arithmetic ..... 72
- exponential function ..... **105**
  - analytic properties ..... 105
  - approximations ..... 132

- Chebyshev-series expansions ..... 132
- computation ..... 131
- conformal maps ..... 106
- continued fractions ..... 110
- definition ..... 105
- derivatives ..... 109
- differential equation ..... 109
- generalized ..... 111
- graphics
  - complex argument ..... 107
  - real argument ..... 106
- identities ..... 109
- inequalities ..... 108
- integrals ..... 110
- limits ..... 107
- notation ..... 104
- periodicity ..... 105
- power series ..... 105
- special values ..... 107
- sums ..... 110
- tables ..... 132
- zeros ..... 105
- exponential growth ..... 28
- exponential integrals ..... **150**
  - analytic continuation ..... 151
  - applications ..... 155
  - approximations ..... 156
  - asymptotic expansions ..... 153
    - exponentially-improved ..... 153
    - re-expansion of remainder term ..... 153
  - Chebyshev-series expansions ..... 156, 157
  - computation ..... 155
  - continued fraction ..... 153
  - definition ..... 150
  - expansion in inverse factorials ..... 153
  - expansions in modified spherical Bessel functions
    - generalized ..... 153
  - generalized ..... 185
  - graphics ..... 151
  - inequalities ..... 152
  - integral representations ..... 152
  - integrals ..... 154
  - interrelations ..... 150, 151
  - Laplace transform ..... 154
  - notation ..... 150
  - power series ..... 151
  - principal value ..... 150
  - relations to other functions
    - confluent hypergeometric functions ..... 153
    - incomplete gamma function ..... 153
    - logarithmic integral ..... 150
    - sine and cosine integrals ..... 151
  - small argument ..... 51
  - tables ..... 156
  - zeros ..... 154
- extended complex plane ..... 16
- Faà di Bruno's formula
  - for derivatives ..... 5
- Fabry's transformation
  - differential equations ..... 57
- factorials (rising or falling) ..... 618
- factorization
  - of integers ..... 648
  - via Weierstrass elliptic functions ..... 582
- Faddeeva function ..... 169
- fast Fourier transform ..... 100
- Fay's trisecant identity
  - Riemann theta functions with characteristics ..... 544
  - generalizations ..... 544
- Fejér kernel
  - Fourier integral ..... 34
  - Fourier series ..... 33
- Fermat numbers
  - number theory ..... 648
- Fermat's last theorem
  - Bernoulli and Euler numbers and polynomials ... 598
- Fermi–Dirac integrals
  - approximations ..... 615
  - computation ..... 614
  - definition ..... 611
  - relation to polylogarithms ..... 612
  - tables ..... 614
  - uniform asymptotic approximation ..... 612
- Ferrers board ..... 633
- Ferrers function
  - of the first kind
    - integral equation for Lamé functions ..... 689
- Ferrers functions ..... **352**
  - addition theorems ..... 370
  - analytic continuation ..... 376
  - applications
    - spherical harmonics ..... 378–379
    - spheroidal harmonics ..... 378
  - asymptotic approximations
    - ..... *see* uniform asymptotic approximations.
  - behavior at singularities ..... 361–362
  - computation ..... 379
  - connection formulas ..... 362
  - cross-products ..... 352
  - definitions ..... 353–354
  - degree ..... 352
  - derivatives ..... 362
    - with respect to degree or order ..... 363
  - differential equation
    - ..... *see* associated Legendre equation.
  - generating functions ..... 361
  - graphics ..... 355–357
  - integer degree and order ..... 360–361

- integer order ..... 360
- integral representations ..... 363
- integrals
  - definite ..... 369
  - indefinite ..... 368
  - Laplace transforms ..... 370
  - Mellin transforms ..... 370
  - orthogonality properties ..... 369
- notation ..... 352
- of the first kind ..... 353
- of the second kind ..... 353
- order ..... 352
- orthogonality ..... 369
- recurrence relations ..... 362
- reflection formulas ..... 361
- relations to other functions
  - elliptic integrals ..... 360
  - hypergeometric function ..... 353, 354, 394
  - Legendre polynomials ..... 360
  - ultraspherical polynomials ..... 448
- Rodrigues-type formulas ..... 360
- special values ..... 359–360
- sums ..... 370–371
- tables ..... 380
- trigonometric expansions ..... 364
- uniform asymptotic approximations
  - large degree ..... 366–368
  - large order ..... 365–366
- Wronskians ..... 352–353
- zeros ..... 368
- Ferrers graph ..... 626
- Feynman diagrams
  - Appell functions ..... 417
- Feynman path integrals
  - theta functions ..... 534
- Fibonacci numbers ..... 596, 629
- fine structure constant
- Coulomb functions ..... 753
- finite Fourier series
  - number theory ..... 643
- fixed point ..... 90
- floating-point arithmetic
  - bits ..... 72
    - format width ..... 72
    - significant ..... 72
  - double precision ..... 72
  - exponent ..... 72
  - fractional part ..... 72
  - IEEE standard ..... 72
  - machine epsilon ..... 72
  - machine number ..... 72
  - machine precision ..... 72
  - overflow ..... 72
  - rounding
    - by chopping ..... 72
    - down ..... 72
    - symmetric ..... 72
    - to nearest machine number ..... 72
- significand ..... 72
- single precision ..... 72
- underflow ..... 72
- Floquet solutions
  - Hill's equation ..... 675
  - Mathieu's equation ..... 653
- Floquet's theorem
  - Hill's equation ..... 674
  - Mathieu's equation ..... 653
- fluid dynamics
  - elliptic integrals ..... 517
  - Legendre polynomials ..... 479
  - Riemann theta functions ..... 545
  - Struve functions ..... 298
- fold canonical integral ..... 776, 785
  - bifurcation set ..... 781
  - differential equation ..... 788
  - integral identity ..... 787
  - relation to Airy function ..... 777
  - zeros ..... 785
- fold catastrophe ..... 776, 785
- Fourier cosine and sine transforms
  - definition ..... 27
  - generalized ..... 400
  - inversion ..... 28
  - Parseval's formula ..... 28
  - tables ..... 31, 32
- Fourier integral
  - asymptotic expansions ..... 44, 45
  - Dirac delta ..... 38
  - Fejér kernel ..... 34
  - Poisson kernel ..... 34
  - summability ..... 34
- Fourier series ..... 13–14
  - Bessel's inequality ..... 13
  - coefficients ..... 13
  - compendia ..... 14
  - convergence ..... 14
  - definition ..... 13
  - differentiation ..... 14
  - Dirac delta ..... 38
  - Fejér kernel ..... 33
  - finite
    - number theory ..... 643
  - integration ..... 14
  - Parseval's formula ..... 14
  - Poisson kernel ..... 34
  - Poisson's summation formula ..... 14
  - properties ..... 13
  - summability ..... 33–34

- uniqueness ..... 13
- Fourier transform ..... 27–28
  - convergence ..... 27
  - convolution ..... 27
  - definitions ..... 27
  - discrete ..... 99
  - distributions ..... 37
  - fast ..... 100
  - group
    - hypergeometric function ..... 400
  - inversion ..... 27
  - Parseval's formula ..... 27
  - tables ..... 30, 32
  - tempered distributions ..... 37
  - uniqueness ..... 27
- Fourier–Bessel expansion
  - Bessel functions ..... 248
    - computation ..... 278
- Fourier-series expansions
  - nonuniformity of convergence ..... 155
  - piecewise continuous functions ..... 155
- fractals ..... 92
- fractional derivatives ..... 35
- fractional integrals ..... 35
  - asymptotic expansions ..... 53–55
  - definition ..... 53
- fractional linear transformation
  - ..... *see* bilinear transformation.
- Fresnel integrals ..... 160
  - applications
    - Cornu's spiral ..... 168
    - interference patterns ..... 161
    - physics and astronomy ..... 169
    - probability theory ..... 169
    - statistics ..... 169
  - approximations ..... 170
  - asymptotic expansions ..... 164
    - exponentially-improved ..... 164
  - auxiliary functions
    - ..... *see* auxiliary functions for Fresnel integrals.
  - computation ..... 169
  - definition ..... 160
  - expansions in spherical Bessel functions ..... 162
  - graphics ..... 161
  - integrals
    - Laplace transforms ..... 166
  - interrelations ..... 162
  - notation ..... 160
  - power-series expansions ..... 162
  - relations to other functions
    - Anger–Weber functions ..... 297
    - auxiliary functions ..... 160, 162
    - confluent hypergeometric functions ..... 164
    - error functions ..... 162
    - generalized hypergeometric functions ..... 164
    - symmetry ..... 161
    - tables ..... 169
    - values at infinity ..... 160
    - zeros ..... 165
      - asymptotic expansions ..... 165
      - tables ..... 165
- Freud weight function ..... 475
- Frobenius' identity
  - Riemann theta functions with characteristics ..... 544
- Fuchsian equation
  - classification of parameters ..... 718
  - definitions ..... 718
  - normal form ..... 718
  - polynomial solutions ..... 718
  - relation to Heun's equation ..... 718
- functions
  - analytic ..... *see* analytic function.
  - analytically continued ..... 19
  - continuous ..... *see* continuous function.
  - continuously differentiable ..... 5, 7
  - convex ..... 7
  - decreasing ..... 4
  - defined by contour integrals ..... 21
  - differentiable ..... 5
  - entire ..... *see* entire functions.
  - harmonic ..... 16
  - holomorphic ..... *see* analytic function.
  - increasing ..... 4
  - inverse ..... 21
  - limits ..... *see* limits of functions.
  - many-valued ..... *see* multivalued function.
  - meromorphic ..... 19
  - monotonic ..... 4
  - multivalued ..... *see* multivalued function.
  - nondecreasing ..... 4
  - nonincreasing ..... 4
  - of a complex variable ..... 18–22
  - of bounded variation ..... 6
  - of compact support ..... 35
  - of matrix argument
    - ..... *see* functions of matrix argument.
    - strictly decreasing ..... 4
    - strictly increasing ..... 4
    - strictly monotonic ..... 4
    - support of ..... 35
    - vector-valued ..... 10–11
- functions of matrix argument ..... 768
  - Laplace transform ..... 768
  - orthogonal invariance ..... 771
- fundamental theorem of arithmetic ..... 638
- fundamental theorem of calculus ..... 6
- gamma distribution
  - incomplete gamma functions ..... 189

- gamma function ..... **136**
  - ..... *see also* incomplete gamma functions.
  - analytic properties ..... 136
  - applications
    - mathematical ..... 145
    - physical ..... 145–146
  - approximations
    - Chebyshev series ..... 147
    - complex variables ..... 147
    - rational ..... 146, 147
  - asymptotic expansions ..... 140–142
    - error bounds ..... 141
    - exponentially-improved ..... 141
    - for ratios ..... 141
  - Bohr-Mollerup theorem ..... 138
  - computation ..... 146
  - continued fraction ..... 140
  - definition ..... 136
  - duplication formula ..... 138
  - Euler’s integral ..... 136
  - extrema
    - asymptotic approximation ..... 138
    - table of ..... 138
  - Gauss’s multiplication formula ..... 138
  - graphics ..... 136–137
  - inequalities ..... 138
  - infinite products ..... 139
  - integral representations ..... 139–140, 143–144, 188
    - for derivatives ..... 140
    - multidimensional ..... 143–144
  - logarithm
    - continued fraction ..... 140
    - convexity ..... 136, 138
    - graphics ..... 136
    - integral representations ..... 140
    - Taylor series ..... 139
  - maxima and minima ..... 138
  - multiplication formulas ..... 138
  - multivariate ..... *see* multivariate gamma function.
  - notation ..... 136
  - reciprocal
    - analytic properties ..... 136
    - graphics ..... 136, 137
    - Maclaurin series ..... 139
    - zeros ..... 136
  - recurrence relation ..... 138
  - reflection formula ..... 138
  - relations to hypergeometric function ..... 387
  - scaled ..... 185
  - special values ..... 137
  - tables ..... 146
- Gaunt coefficient
  - $3j$  symbol ..... 761
- Gaunt’s integral
  - $3j$  symbol ..... 761
- Gauss quadrature ..... 80–83
  - Christoffel coefficients (or numbers) ..... 80
  - comparison with Clenshaw–Curtis formula ..... 80
  - eigenvalue/eigenvector characterization ..... 82
  - for contour integrals ..... 83
  - Gauss–Chebyshev formula ..... 80
  - Gauss–Hermite formula ..... 81
  - Gauss–Jacobi formula ..... 80
  - Gauss–Laguerre formula ..... 80–81
    - generalized ..... 80
  - Gauss–Legendre formula ..... 80
  - logarithmic weight function ..... 81–82
  - nodes ..... 80
    - tables ..... 80–83
  - remainder terms ..... 80
  - weight functions ..... 80
    - tables ..... 80–83
- Gauss series
  - hypergeometric function ..... 384
  - convergence ..... 384
- Gauss sums
  - number theory
    - Dirichlet character ..... 643
    - separable ..... 643
  - theta functions ..... 532
- Gauss’s  ${}_2F_1(-1)$  sum
  - $q$ -analog ..... 426
- Gauss’s theorem for vector-valued functions ..... 12
- Gauss–Christoffel quadrature ... *see* Gauss quadrature.
- Gaussian
  - nonperiodic ..... 533
- Gaussian elimination ..... 73–74
  - back substitution ..... 73
  - forward elimination ..... 73
  - iterative refinement ..... 74
  - multipliers ..... 73
  - partial pivoting ..... 73
  - pivot (or pivot element) ..... 73
  - residual vector ..... 74
  - triangular decomposition ..... 73
  - tridiagonal systems ..... 74
- Gaussian hypergeometric function
  - ..... *see also* hypergeometric function.
  - of matrix argument ..... 771
    - applications ..... 773
    - asymptotic approximations ..... 772
    - basic properties ..... 771
    - case  $m = 2$  ..... 771
    - computation ..... 773
    - confluent form ..... 771
    - definition ..... 771
    - Gauss formula ..... 771
    - integral representation ..... 771

- Jacobi form . . . . . 771
  - notation . . . . . 768
  - partial differential equations . . . . . 771–772
  - reflection formula . . . . . 771
  - transformations of parameters . . . . . 771
  - Gaussian noise
    - Lambert  $W$ -function . . . . . 131
  - Gaussian polynomials
    - definition . . . . . 627
    - tables . . . . . 635
  - Gaussian probability functions . . . . . 160
  - Gaussian unitary ensemble
    - Painlevé transcendents . . . . . 739
  - Gegenbauer function
    - definition . . . . . 394
    - relation to associated Legendre functions . . . . . 355
    - relation to hypergeometric function . . . . . 394
  - Gegenbauer polynomials
    - . . . *see* ultraspherical polynomials *and also* classical orthogonal polynomials.
  - Gegenbauer’s addition theorem
    - Bessel functions . . . . . 247
    - modified Bessel functions . . . . . 261
  - general elliptic integrals . . . . . 486
    - reduction to basic elliptic integrals . . . . . 512
    - reduction to Legendre’s elliptic integrals . . . . . 496–497
    - reduction to symmetric elliptic integrals . . . . . 512–514
  - general orthogonal polynomials . . . . . 437
    - computation . . . . . 479
    - difference operators . . . . . 437
    - monic . . . . . 438
    - on finite point sets . . . . . 437
    - on intervals . . . . . 437
    - orthonormal . . . . . 438
    - recurrence relations . . . . . 438
    - sums of products . . . . . 438
    - weight functions . . . . . 437
    - $x$ -difference operators . . . . . 437
    - zeros . . . . . 438
  - generalizations of elliptic integrals . . . . . 516
  - generalized Airy functions
    - from differential equation . . . . . 206–207
      - asymptotic approximations . . . . . 206
      - definitions . . . . . 206, 207
      - relation to Bessel functions . . . . . 206
      - relation to modified Bessel functions . . . . . 206
      - tables . . . . . 211
    - from integral representations . . . . . 207–208
      - connection formulas . . . . . 208
      - definitions . . . . . 207
      - difference equation . . . . . 208
      - differential equation . . . . . 208
  - generalized exponential integral . . . . . 185
    - analytic continuation . . . . . 187
  - applications
    - mathematical . . . . . 189
    - physical . . . . . 189
  - approximations . . . . . 191
  - asymptotic expansions
    - exponentially-improved . . . . . 187
    - large parameter . . . . . 187
    - large variable . . . . . 187
  - Chebyshev-series expansions . . . . . 191
  - computation . . . . . 190
  - continued fraction . . . . . 187
  - definition . . . . . 185
  - derivatives . . . . . 186
  - further generalizations . . . . . 187
  - graphics . . . . . 185–186
  - inequalities . . . . . 187
  - integral representations . . . . . 185
    - Mellin–Barnes type . . . . . 185
  - integrals . . . . . 187
  - notation . . . . . 174
  - of large argument . . . . . 66
  - principal values . . . . . 185
  - recurrence relation . . . . . 186
  - relations to other functions
    - confluent hypergeometric functions . . . . . 186
    - error functions . . . . . 164
    - incomplete gamma functions . . . . . 185
  - series expansions . . . . . 186
  - special values . . . . . 186
  - tables . . . . . 190
- generalized exponentials . . . . . 111
  - generalized functions
    - distributions . . . . . 55
  - generalized hypergeometric differential equation . . . . . 409
    - confluence of singularities . . . . . 410
    - connection formula . . . . . 410
    - fundamental solutions . . . . . 409
    - singularities . . . . . 409
  - generalized hypergeometric function  ${}_0F_2$ 
    - definition . . . . . 404, 408
    - of large argument . . . . . 64
  - generalized hypergeometric functions . . . . . 404
    - analytic continuation . . . . . 408
    - analytic properties . . . . . 404, 405, 408
    - applications
      - mathematical . . . . . 417
      - physical . . . . . 417
    - approximations . . . . . 418
    - argument unity . . . . . 405
    - as functions of parameters . . . . . 405
    - asymptotic expansions
      - formal series . . . . . 411
      - large parameters . . . . . 412
      - large variable . . . . . 411

- small variable . . . . . 408
  - balanced . . . . . 405
  - bilateral series . . . . . 408
    - Dougall's bilateral sum . . . . . 408
  - computation . . . . . 418
  - contiguous balanced series . . . . . 407
  - contiguous functions . . . . . 405
  - contiguous relations . . . . . 407
  - continued fractions . . . . . 407
  - definitions . . . . . 404, 408
  - derivatives . . . . . 405
  - differential equation . . . . . *see* generalized hypergeometric differential equation.
  - Dixon's well-poised sum . . . . . 406
  - Dougall's bilateral sum . . . . . 408
  - Dougall's very well-poised sum . . . . . 406
  - Džrbasjan's sum . . . . . 406
  - expansions in series of . . . . . 410
  - extensions of Kummer's relations . . . . . 407
  - identities . . . . . 407
  - integral representations . . . . . 408
  - integrals . . . . . 408
    - inverse Laplace transform . . . . . 408
    - Laplace transform . . . . . 408
  - $k$ -balanced . . . . . 405
  - Kummer-type transformations . . . . . 407, 409
  - monodromy . . . . . 417
  - notation . . . . . 404
  - of matrix argument . . . . . **772**
    - applications . . . . . 773
    - computation . . . . . 773
    - confluence . . . . . 772
    - convergence properties . . . . . 772
    - definition . . . . . 772
    - Euler integral . . . . . 773
    - expansion in zonal polynomials . . . . . 772
    - general properties . . . . . 772
    - invariance . . . . . 773
    - Kummer transformation . . . . . 772
    - Laplace transform . . . . . 773
    - Mellin–Barnes integrals . . . . . 773
    - notation . . . . . 768
    - Pfaff–Saalschutz formula . . . . . 772
    - relations to other functions . . . . . 772
    - Thomae transformation . . . . . 772
    - ${}_3F_2$  case . . . . . 772
    - value at  $\mathbf{T} = \mathbf{0}$  . . . . . 772
  - Pfaff–Saalschütz balanced sum . . . . . 406
  - polynomial cases . . . . . 404
  - principal branch (value) . . . . . 404
  - products . . . . . 412
  - recurrence relations . . . . . 407
  - relations to other functions
    - associated Jacobi polynomials . . . . . 474
    - Bessel functions . . . . . 228
    - classical orthogonal polynomials . . . . . 442
    - Fresnel integrals . . . . . 164
    - generalized Bessel polynomials . . . . . 476
    - Hahn class orthogonal polynomials . . . . . 463
    - Kummer functions . . . . . 328
    - Meijer  $G$ -function . . . . . 416
    - modified Bessel functions . . . . . 255
    - orthogonal polynomials *and* other functions . . . . . 409
    - $3j, 6j, 9j$  symbols . . . . . 407, 418
    - Wilson class orthogonal polynomials . . . . . 468
  - Rogers–Dougall very well-poised sum . . . . . 406
  - Saalschützian . . . . . 405
  - terminating . . . . . 404
  - transformation of variable . . . . . 408
    - cubic . . . . . 409
    - quadratic . . . . . 408
  - very well-poised . . . . . 405
  - Watson's sum . . . . . 406
  - well-poised . . . . . 405
  - Whipple's sum . . . . . 406
  - Whipple's transformation . . . . . 407
  - with two variables . . . . . 412–415
  - zeros . . . . . 410
  - generalized hypergeometric series . . . . . 404
  - generalized integrals
    - asymptotic expansions . . . . . 52
  - generalized logarithms . . . . . 73, 111
    - applications . . . . . 131
  - generalized precision . . . . . 73
  - generalized sine and cosine integrals . . . . . **188**
    - analytic properties . . . . . 188
    - asymptotic expansions for large variable . . . . . 189
    - auxiliary functions . . . . . 189
    - asymptotic expansions for large variable . . . . . 189
    - integral representations . . . . . 189
  - computation . . . . . 190
  - definitions
    - general values . . . . . 188
    - principal values . . . . . 188
  - expansions in series of spherical Bessel functions . . . . . 188
  - integral representations . . . . . 188
  - interrelations . . . . . 188
  - notation . . . . . 174
  - power-series expansions . . . . . 188
  - relation to sine and cosine integrals . . . . . 188
  - special values . . . . . 188
- Genocchi numbers . . . . . 595
    - table . . . . . 596
  - genus
    - Riemann surface . . . . . 543
  - geometric mean . . . . . 3, 13
  - geometric progression (or series) . . . . . 2
  - geophysics

- spherical harmonics ..... 379
- Gibbs phenomenon
  - sine integral ..... 154
- Glaisher's constant ..... 63, 144
- Glaisher's notation
  - Jacobian elliptic functions ..... 550
- Goldbach conjecture
  - number theory ..... 644
- Goodwin–Staton integral
  - asymptotic expansion ..... 164
  - computation ..... 169
  - definition ..... 160
  - relations to Dawson's integral and exponential integral ..... 162
- Graf's addition theorem
  - Bessel functions ..... 247
  - modified Bessel functions ..... 261
- Gram–Schmidt procedure
  - for least squares approximation ..... 99
- graph theory
  - combinatorics ..... 635
- gravitational radiation
  - Coulomb functions ..... 755
- Green's theorem for vector-valued functions
  - three dimensions ..... 12
  - two dimensions ..... 11
- group representations
  - orthogonal polynomials ..... 479
- group theory
  - hypergeometric function ..... 400
- Gudermannian function ..... 121
  - inverse ..... 121
  - relation to  $R_C$ -function ..... 495
  - relation to amplitude (am) function ..... 561
  - tables ..... 132
- Haar measure ..... 769
- Hadamard's inequality for determinants ..... 3
- Hahn class orthogonal polynomials ..... 462–467
  - asymptotic approximations ..... 466–467
  - computation ..... 479
  - definitions ..... 462
  - difference equations on variable ..... 465
  - differences ..... 465
  - dualities ..... 463
  - generating functions ..... 466
  - interrelations with other orthogonal polynomials
    - ..... 463, 464
  - leading coefficients ..... 462
  - limit relations ..... 463
  - normalizations ..... 462
  - notation ..... 436
  - orthogonality properties ..... 462
  - recurrence relations ..... 464
  - relations to confluent hypergeometric functions and generalized hypergeometric functions ..... 328, 463
  - relations to hypergeometric function ..... 394, 463
  - Rodrigues formula ..... 462
  - special cases ..... 463
  - weight functions ..... 462
- Hahn polynomials
  - ..... *see* Hahn class orthogonal polynomials.
- Hamiltonian systems
  - chaotic
    - Lamé functions ..... 694
- handle
  - Riemann surface ..... 543
- Hankel functions ..... 217
  - addition theorems ..... 246–247
  - analytic continuation ..... 226
  - approximations ..... 281
  - asymptotic expansions for large argument .. 229–230
    - error bounds ..... 229–230
    - exponentially-improved ..... 230
  - asymptotic expansions for large order ..... 231–235
    - asymptotic forms ..... 231
    - double asymptotic properties ..... 235, 258
    - transition region ..... 232
    - uniform ..... 232–235
  - branch conventions ..... 218
  - computation ..... 276–277
  - connection formulas ..... 222
  - cross-product ..... 222
  - definitions ..... 217
  - derivatives ..... 222
    - asymptotic expansions for large argument ..... 229
    - asymptotic expansions for large order .... 231–232
    - uniform asymptotic expansions for large order
      - ..... 233
    - zeros ..... 238
  - differential equations ..... 217
    - ..... *see also* Bessel's equation.
  - graphics ..... 220–221
  - incomplete ..... 262
  - integral representations
    - along real line ..... 224
    - compendia ..... 226
    - contour integrals ..... 224
  - integrals
    - ..... *see* integrals of Bessel and Hankel functions.
  - limiting forms ..... 217, 223
  - multiplication theorem ..... 246
  - notation ..... 217
  - power series ..... 223
  - principal branches (or values) ..... 217
  - recurrence relations ..... 222
  - relations to other functions
    - Airy functions ..... 196–197



- confluent hypergeometric functions ..... 228
- elementary functions ..... 228
- Wronskians ..... 222
- zeros ..... 238
  - computation ..... 277
  - tables ..... 279
  - with respect to order ( $\nu$ -zeros) ..... 240
- Hankel transform ..... 246
  - computation ..... 277
- Hankel's expansions
  - for Bessel and Hankel functions ..... 228–229
  - for modified Bessel functions ..... 255
- Hankel's integrals
  - Bessel functions and Hankel functions ..... 226
- Hankel's inversion theorem
  - Bessel functions ..... 246
- Hankel's loop integral
  - gamma function ..... 139
- harmonic analysis
  - hypergeometric function ..... 399
- harmonic functions ..... 16
  - maximum modulus ..... 20
  - mean value property ..... 16
  - Poisson integral ..... 16
- harmonic mean ..... 3, 13
- harmonic oscillators
  - Hermite polynomials ..... 479
  - $q$ -hypergeometric function ..... 432
- harmonic trapping potentials
  - parabolic cylinder functions ..... 317
- heat conduction in liquids
  - Rayleigh function ..... 276
- heat theory
  - conical functions ..... 379
- Heaviside function ..... 36, 54
  - derivative ..... 36
- Heine's formula
  - associated Legendre functions ..... 377
- Heine's integral
  - Legendre functions ..... 364
- Helmholtz equation
  - $3j, 6j, 9j$  symbols ..... 765
  - associated Legendre functions ..... 379
  - Bessel functions and modified Bessel functions .. 275
  - parabolic cylinder functions ..... 317
  - paraboloidal coordinates ..... 678
- Hermite polynomials ..... 438
  - ..... *see also* classical orthogonal polynomials.
  - addition theorem ..... 460
  - applications
    - integrable systems ..... 478
    - random matrix theory ..... 479
    - Schrödinger equation ..... 479
  - asymptotic approximations ..... 453
  - computation ..... 479
  - continued fractions ..... 450
  - definitions ..... 439
  - derivatives ..... 447
  - differential equations ..... 445
  - Dirac delta ..... 38
  - expansions in series of ..... 459–461
  - explicit representations ..... 442–443
  - Fourier transforms ..... 457
  - generating functions ..... 450
  - graphs ..... 441
  - inequalities ..... 450, 451
    - Turan-type ..... 450
  - integral representations ..... 447, 448
  - integrals ..... 455, 457–459
    - indefinite ..... 455
    - Nicholson-type ..... 455
  - interrelations with other orthogonal polynomials
    - ..... 444–445, 463, 464
  - Laplace transform ..... 457
  - leading coefficients ..... 439
  - limiting forms as trigonometric functions ..... 449
  - linearization formulas ..... 461
  - local maxima and minima ..... 451
  - Mellin transform ..... 458
  - monic ..... 81, 441
  - multiplication theorem ..... 460
  - normalizations ..... 439
  - notation ..... 436
  - orthogonality properties ..... 439
  - Poisson kernels ..... 461
  - recurrence relations ..... 446
  - relations to other functions
    - confluent hypergeometric functions .. 328, 338, 449
    - derivatives of the error function ..... 163
    - generalized hypergeometric functions ..... 443
    - parabolic cylinder functions ..... 308
    - repeated integrals of the complementary error function ..... 167
  - Rodrigues formula ..... 442
  - special values ..... 444
  - symmetry ..... 444
  - tables ..... 480
    - of coefficients ..... 440
    - of zeros ..... 81
  - upper bounds ..... 450
  - zeros ..... 438, 455
    - asymptotic behavior ..... 455
    - tables ..... 81
- Hermite–Darboux method
  - Heun functions ..... 713
- Hermitian matrices
  - Gaussian unitary ensemble
    - limiting distribution of eigenvalues ..... 739

- Heun equation ..... *see* Heun's equation.
- Heun functions ..... **710**
- applications
    - mathematical ..... 719–720
    - physical ..... 720
  - asymptotic approximations ..... 718
  - computation ..... 720
  - definition ..... 712
  - differential equation ..... *see* Heun's equation.
  - expansions in series of
    - hypergeometric functions ..... 716–717
    - orthogonal polynomials ..... 717
  - integral equations and representations ..... 714–716
  - notation ..... 710
  - orthogonality
    - double ..... 714
    - single ..... 714
  - relations to hypergeometric function ..... 713
  - relations to Lamé functions ..... 713
- Heun polynomials ..... **712**
- applications ..... 719
  - definitions ..... 712
  - integral equations and representations ..... 715
  - notation ..... 712
  - orthogonality ..... 714
  - products ..... 719
- Heun's equation ..... **710**
- accessory parameter ..... 710
  - asymptotic approximations ..... 718
  - applications ..... 718
  - mathematical ..... 719–720
  - physical ..... 720
  - asymptotic approximations
    - eigenvalues of accessory parameters ..... 718
    - solutions near irregular singularities ..... 718
    - solutions of confluent forms ..... 718
    - solutions with coalescing singularities ..... 718
  - automorphisms ..... 711–713
  - composite ..... 711
  - $F$ -homotopic transformations ..... 711
  - homographic transformations ..... 711
  - basic solutions
    - equivalent expressions ..... 712
    - Fuchs–Frobenius ..... 711
  - biconfluent ..... 718
  - classification of parameters ..... 710
  - computation of solutions ..... 720
  - confluent forms ..... 717–718
  - asymptotic approximations ..... 718
  - integral equations ..... 716
  - special cases ..... 717
  - doubly-confluent ..... 717
  - doubly-periodic forms
    - Jacobi's elliptic ..... 710
    - Weierstrass's ..... 710
  - eigenvalues of accessory parameter ..... 712
  - expansions of solutions in series of
    - hypergeometric functions ..... 716–717
    - orthogonal polynomials ..... 717
  - exponent parameters ..... 710
  - integral equations ..... 714–716
  - integral representation of solutions ..... 714–716
  - kernel functions ..... 714, 716
  - separation constant ..... 714
  - inversion problem ..... 719
  - Jacobi's elliptic form ..... 710
  - Liouvillean solutions ..... 713
  - monodromy group ..... 719
  - normal form ..... 710
  - parameters
    - classification ..... 710
  - path-multiplicative solutions ..... 712
  - biorthogonality ..... 714
  - expansions in series of hypergeometric functions
    - ..... 717
    - relation to Fuchsian equation ..... 718
    - relation to Lamé's equation ..... 685
    - separation of variables ..... 720
  - singularities ..... 710
  - singularity parameter ..... 710
  - solutions analytic at three singularities
    - ..... *see* Heun polynomials.
  - solutions analytic at two singularities
    - ..... *see* Heun functions.
  - solutions via quadratures ..... 713
  - triconfluent ..... 718
  - trigonometric form ..... 710
  - uniformization problem ..... 719
  - Weierstrass's form ..... 710
- Heun's operator ..... 714
- hexadecimal number system ..... 72
- high-frequency scattering
  - parabolic cylinder functions ..... 317
- higher-order  $3nj$  symbols ..... 765
- highway design
  - Cornu's spiral ..... 169
- Hilbert space
  - interrelation between bases
    - Heun polynomial products ..... 719–720
  - $L^2_\rho(Q)$  orthonormal basis ..... 719
- Hilbert transform
  - computation ..... 84
  - definition ..... 29
  - Fourier transform of ..... 29
  - inequalities ..... 29
  - inversion ..... 29
- Hill's equation ..... **674**
- ..... *see also* Whittaker–Hill equation.

- antiperiodic solutions ..... 675
- basic solutions ..... 674
- characteristic equation ..... 675
- characteristic exponents ..... 675
- definition ..... 674
- discriminant ..... 675
- eigenfunctions ..... 676
- eigenvalues ..... 675
- equation of Ince ..... 676
  - Fourier-series solutions ..... 676
  - polynomial solutions ..... *see* Ince polynomials.
- expansions in series of eigenfunctions ..... 676
- Floquet solutions ..... 675
- Floquet's theorem ..... 674
- periodic solutions ..... 675
- pseudoperiodic solutions ..... 674
- real case ..... 675
- separation constants ..... 677, 678
- symmetric case ..... 675
- Hölder's inequalities for sums and integrals .... 12, 13
- holomorphic function ..... *see* analytic function.
- homogeneous harmonic polynomials ..... 379
- homographic transformation
  - ..... *see* bilinear transformation.
- Horner's scheme for polynomials ..... 22
  - extended ..... 22
- Hurwitz criterion for stable polynomials ..... 23
- Hurwitz system
  - Riemann surface ..... 546
- Hurwitz zeta function ..... 607
  - analytic properties ..... 607
  - asymptotic expansions for large parameter .... 610
  - computation ..... 614
  - definition ..... 607
  - derivatives ..... 608
    - asymptotic expansions for large parameter .... 610
  - graphics ..... 607–608
  - integral representations ..... 609
  - integrals ..... 610
  - relations to other functions
    - Lerch's transcendent ..... 612
    - periodic zeta function ..... 612
    - polylogarithms ..... 611
    - Riemann zeta function ..... 607
  - representations by Euler–Maclaurin formula .... 608
  - series representations ..... 608, 610
  - special values ..... 608
  - sums ..... 610
  - tables ..... 614
- hydrodynamics
  - Jacobian elliptic functions ..... 566
- hyperasymptotic expansions ..... 68
- hyperbola
  - elliptic integrals ..... 514
- hyperbolic cosecant function .. *see* hyperbolic functions.
- hyperbolic cosine function .... *see* hyperbolic functions.
- hyperbolic cotangent function
  - ..... *see* hyperbolic functions.
- hyperbolic functions ..... 123
  - addition formulas ..... 125
  - analytic properties ..... 123
  - approximations ..... 132
  - computation ..... 132
  - conformal maps ..... 124
  - continued fractions ..... 129
  - definitions ..... 123
  - derivatives ..... 125
  - differential equations ..... 125
  - elementary properties ..... 124
  - graphics
    - complex argument ..... 124
    - real argument ..... 123–124
  - identities ..... 125
  - inequalities ..... 125
  - infinite products ..... 126
  - integrals
    - definite ..... 130
    - indefinite ..... 130
  - inverse ..... *see* inverse hyperbolic functions.
  - Laurent series ..... 125
  - limits ..... 125
  - Maclaurin series ..... 125
  - moduli ..... 126
  - multiples of argument ..... 126
  - notation ..... 104
  - partial fractions ..... 126
  - periodicity ..... 123
  - poles ..... 123
  - real and imaginary parts ..... 126
  - relations to trigonometric functions ..... 123
  - special values ..... 125
  - squares and products ..... 126
  - sums ..... 130
  - tables ..... 132
  - zeros ..... 123
- hyperbolic secant function ... *see* hyperbolic functions.
- hyperbolic sine function ..... *see* hyperbolic functions.
- hyperbolic tangent function .. *see* hyperbolic functions.
- hyperbolic trigonometric functions
  - ..... *see* hyperbolic functions.
- hyperbolic umbilic bifurcation set
  - formula ..... 781
  - picture ..... 782
- hyperbolic umbilic canonical integral ..... 776
  - asymptotic approximations ..... 789–790
  - convergent series ..... 787
  - differential equations ..... 788
  - formulas for Stokes set ..... 783

- integral identity ..... 787
- pictures of modulus ..... 779
- pictures of phase ..... 781
- scaling laws ..... 785
- zeros ..... 787
- hyperbolic umbilic catastrophe ..... **776**, 785
- hyperelliptic functions ..... 566
- hyperelliptic integrals ..... 498
- hypergeometric differential equation ..... **394**
  - equivalent equation for contiguous functions ..... 388
  - fundamental solutions ..... 394–395
  - Kummer’s solutions ..... 395
  - singularities ..... 395
- hypergeometric equation
  - ..... *see* hypergeometric differential equation.
- hypergeometric function ..... **384**
  - ..... *see also* Gaussian hypergeometric function.
  - analytic properties ..... 384
  - applications
    - mathematical ..... 399
    - physical ..... 400
  - asymptotic approximations
    - large  $a$  (or  $b$ ) and  $c$  ..... 397, 398
    - large  $a$  and  $b$  ..... 397, 398
    - large  $a$  or  $b$  ..... 398
    - large  $a$ ,  $b$ , and  $c$  ..... 398
    - large  $c$  ..... 396–398
    - large variable ..... 396
  - branch points ..... 384
  - computation ..... 400
  - contiguous ..... 388
  - continued fractions ..... 389
  - definition ..... 384
  - derivatives ..... 387–388
  - Fourier transforms ..... 398
  - graphics ..... 385–386
  - Hankel transforms ..... 398
  - integral representations ..... 388–389
    - Mellin–Barnes type ..... 388–389
  - integrals ..... 326, 327, 337, 398–399
    - compendia ..... 398–399
  - Laplace transforms ..... 398
  - Maclaurin series ..... 384
  - Mellin transform ..... 398
  - multivariate ..... 498
  - notation ..... 384
  - Olver’s ..... 384
  - polynomial cases ..... 385
  - principal value (or branch) ..... 384
  - products
    - series expansions ..... 399
  - recurrence relations ..... 388
  - relations to other functions
    - associated Legendre functions ..... 353, 354, 394
    - classical orthogonal polynomials ..... 442
    - elementary functions ..... 386
    - Ferrers functions ..... 353, 354, 394
    - gamma function ..... 387
    - Gegenbauer function ..... 394
    - Hahn class orthogonal polynomials ..... 463
    - Heun functions ..... 713
    - incomplete beta functions ..... 183
    - Jacobi function ..... 394
    - orthogonal polynomials ..... 393–394
    - Painlevé transcendents ..... 399
    - Pollaczek polynomials ..... 476
    - psi function ..... 387
    - symmetric elliptic integrals ..... 509
    - Szegő–Askey polynomials ..... 475
    - Wilson class orthogonal polynomials ..... 469
  - singularities ..... 384
  - special cases
    - argument  $\pm 1$  ..... 387
    - argument a fraction ..... 387
    - arguments  $e^{\pm i\pi/3}$  ..... 387, 400
    - elementary functions ..... 386–387
  - sums ..... 399
    - compendia ..... 399
  - transformation of variable
    - cubic ..... 393
    - linear ..... 390–391, 400
    - quadratic ..... 391–393
  - with two variables ..... *see* Appell functions.
  - Wronskians ..... 395
  - zeros ..... 398
- hypergeometric functions of matrix argument
  - ..... *see* confluent hypergeometric functions of matrix argument, Gaussian hypergeometric functions of matrix argument, *and* generalized hypergeometric functions of matrix argument.
- hypergeometric  $R$ -function ..... **498**
  - derivative ..... 500
  - differential equation ..... 501
  - elliptic cases ..... 498
  - integral representations ..... 498
- implicit function theorem ..... 7
- Ince polynomials ..... 676
  - normalization ..... 676
  - zeros ..... 676
- Ince’s equation ... *see* Hill’s equation, equation of Ince.
- Ince’s theorem ..... *see* Theorem of Ince.
- incomplete Airy functions ..... 208
- incomplete beta functions ..... **183**
  - applications
    - physical ..... 189
    - statistical ..... 189
  - asymptotic expansions for large parameters
    - general case ..... 185

- inverse function ..... 185
  - symmetric case ..... 184
- basic properties ..... 183
- continued fraction ..... 184
- historical profile ..... 183
- integral representation ..... 183
- inverse function ..... 185
- notation ..... 174
- recurrence relations ..... 183
- relation to hypergeometric function ..... 183
- sums ..... 184
- tables ..... 190
- incomplete gamma functions ..... 174
  - analytic continuation ..... 174
  - applications
    - mathematical ..... 189
    - physical ..... 189
    - statistical ..... 189
  - approximations ..... 191
  - asymptotic approximations and expansions
    - exponentially-improved ..... 179, 181
    - for inverse function ..... 182
    - large variable and/or large parameter
      - ..... 179–180, 182
    - uniform for large parameter ..... 181, 182
  - basic properties ..... 174
  - Chebyshev-series expansions ..... 191
  - computation ..... 190
  - continued fraction ..... 179
  - definitions
    - general values ..... 174
    - principal values ..... 174
  - derivatives ..... 178
  - differential equations ..... 174
  - expansions in series of
    - Bessel functions ..... 178
    - Laguerre polynomials ..... 178
    - modified spherical Bessel functions ..... 178
  - generalizations ..... 183
  - graphics
    - complex argument ..... 176
    - real variables ..... 175–176
  - inequalities ..... 179
  - integral representations
    - along real line ..... 177
    - compendia ..... 178
    - contour integrals ..... 177
    - Mellin–Barnes type ..... 177
  - integrals ..... 182
  - monotonicity properties ..... 176
  - normalized ..... 174
  - notation ..... 174
  - of imaginary argument ..... 177
  - Padé approximant ..... 179
  - power-series expansions ..... 178
  - principal values ..... 174
  - recurrence relations ..... 178
  - relations to other functions
    - confluent hypergeometric functions .. 177, 328, 338
    - error functions ..... 164
    - exponential integrals ..... 153
    - generalized exponential integral ..... 185
    - incomplete Riemann zeta function ..... 189
  - special values ..... 176
  - sums ..... 183
  - tables ..... 190
  - zeros ..... 182
- incomplete Riemann zeta function ..... 189
  - asymptotic approximations ..... 189
  - expansions in series of incomplete gamma functions
    - ..... 189
  - zeros ..... 189
- inductance
  - symmetric elliptic integrals ..... 516
- inequalities
  - means ..... 13
  - sums and integrals
    - Cauchy–Schwarz ..... 12, 13
    - Hölder’s ..... 12, 13
    - Jensen’s ..... 13
    - Minkowski’s ..... 12, 13
- infinite partial fractions ..... 22
  - Mittag-Leffler’s expansion ..... 22
- infinite products
  - convergence ..... 21
    - absolute ..... 21
    - uniform ..... 21
  - $M$ -test for uniform convergence ..... 21
  - relation to infinite partial fractions ..... 22
  - Weierstrass product ..... 22
- infinite sequences
  - convergence ..... 17
    - absolute ..... 17
    - pointwise ..... 17
    - uniform ..... 17
  - double ..... 18
    - convergence ..... 18
    - relation to infinite double series ..... 18
- infinite series
  - ..... *see also* power series.
  - convergence ..... 17
    - absolute ..... 17
    - pointwise ..... 17
    - uniform ..... 17
  - Weierstrass  $M$ -test ..... 17
  - divergent ..... 17
  - dominated convergence theorem ..... 18
  - double ..... 18

- doubly-infinite ..... 17
- summability methods ..... 33–34
- term-by-term integration ..... 18
- inhomogeneous Airy functions ..... *see* Scorer functions.
- initial-value problems
  - Mathieu functions ..... 679
- integrable differential equations
  - Riemann theta functions ..... 545–546
- integrable equations
  - ..... *see* integrable differential equations.
- integral equations
  - Painlevé transcendents ..... 729
- integral transforms ..... 27
  - ..... *see also* Fourier cosine and sine transforms, Fourier transform, Jacobi transform, Hankel (or Bessel) transform, Hilbert transform, Kontorovich–Lebedev transform, Laplace transform, Mellin transform, spherical Bessel transform, and Stieltjes transform.
  - compendia ..... 32
  - in terms of parabolic cylinder functions ..... 317
  - in terms of Whittaker functions ..... 344
- integrals
  - asymptotic approximations
    - ..... *see* asymptotic approximations of integrals.
  - Cauchy principal values ..... 6
  - change of variables ..... 6
  - convergence ..... 6
    - absolute ..... 6
    - uniform ..... 8, 21
  - convolution product ..... 53
  - definite ..... 5
  - differentiation ..... 6, 8
  - double ..... *see* double integrals.
  - fundamental theorem of calculus ..... 6
  - generalized ..... 52
  - indefinite ..... 5
  - infinite ..... 6, 9, 16
  - Jensen’s inequality ..... 13
  - line ..... 11
  - mean value theorems
    - first ..... 6
    - second ..... 6
  - multiple ..... 8
  - over parametrized surface ..... 12
  - path ..... 11
  - repeated ..... 6
  - square-integrable ..... 6
  - summability methods ..... 34–35
  - tables ..... 5
  - with coalescing saddle points ..... 789–790
- integrals of Bessel and Hankel functions
  - compendia ..... 246
  - convolutions ..... 242
  - fractional ..... 243
  - Hankel (or Bessel) transform ..... 246
  - indefinite ..... 240–241
  - orthogonal properties ..... 243, 244
  - over finite intervals ..... 241–243
  - over infinite intervals ..... 243–246, 326
  - products ..... 241–246
    - triple ..... 245
  - trigonometric arguments ..... 241
- integrals of modified Bessel functions
  - compendia ..... 261
  - computation ..... 277
  - fractional ..... 259
  - indefinite ..... 258
  - Kontorovich–Lebedev transform ..... 260
  - over finite intervals ..... 258
  - over infinite intervals ..... 205, 258–260, 326, 337
  - products ..... 260
  - tables ..... 279
- integration ..... 5, 16
  - by parts ..... 5
  - numerical ..... *see* cubature, Gauss quadrature, Monte-Carlo methods, and quadrature.
  - term by term ..... 18
- interaction potentials
  - hypergeometric function ..... 400
- interior Dirichlet problem
  - for oblate spheroids ..... 706
  - for prolate spheroids ..... 705
- interior points ..... 15
- interpolation ..... 75–77, 91
  - ..... *see also* Lagrange interpolation.
  - based on Chebyshev points ..... 77
  - based on Sinc functions ..... 77
  - bivariate ..... 77
  - convergence properties ..... 77
  - Hermite ..... 77
  - inverse ..... 76
  - inverse linear ..... 91
  - linear ..... 76
  - rational ..... 77
  - spline ..... 77
  - trigonometric ..... 77
- interval
  - closure ..... 6
- interval arithmetic ..... 72
- inverse function ..... 21
  - Lagrange inversion theorem ..... 21
  - extended ..... 21
- inverse Gudermannian function ..... 121
- relation to Legendre’s elliptic integrals ..... 491
- relation to  $R_C$ -function ..... 491
- inverse hyperbolic functions ..... 127
  - addition formulas ..... 129

- analytic properties ..... 127
- approximations ..... 132
- branch cuts ..... 127
- branch points ..... 127
- Chebyshev-series expansions ..... 132
- computation ..... 132
- conformal maps ..... 124
- continued fractions ..... 129
- definitions ..... 127
- derivatives ..... 129
- fundamental property ..... 128
- general values ..... 127
- graphics
  - complex argument ..... 124
  - real argument ..... 123–124
- integrals ..... 129
- interrelations ..... 128
- logarithmic forms ..... 128
- notation ..... 104
- power series ..... 129
- principal values ..... 127
- reflection formulas ..... 128
- tables ..... 132
- values on the cuts ..... 128
- inverse incomplete beta function ..... 185
- inverse incomplete gamma function ..... 182
- inverse Jacobian elliptic functions ..... **561**
  - applications ..... 563
  - as Legendre's elliptic integrals ..... 561
  - as symmetric elliptic integrals ..... 561
  - computation ..... 567
  - definitions ..... 561
  - equivalent forms ..... 561
  - normal forms ..... 561
  - notation ..... 561
  - power-series expansions ..... 561
  - principal values ..... 561
- inverse Laplace transforms
  - asymptotic expansions ..... 46–47
- inverse trigonometric functions ..... **118**
  - addition formulas ..... 121
  - analytic properties ..... 119
  - approximations ..... 132
  - branch cuts ..... 119
  - branch points ..... 119
  - Chebyshev-series expansions ..... 132
  - computation ..... 132
  - conformal maps ..... 113
  - continued fractions ..... 121
  - definitions ..... 118
  - derivatives ..... 121
  - fundamental property ..... 120
  - general values ..... 118
  - graphics
    - complex argument ..... 113–115
    - real argument ..... 112
  - integrals ..... 122
  - interrelations ..... 120
  - logarithmic forms ..... 119–120
  - notation ..... 104
  - power series ..... 121
  - principal values ..... 119
  - real and imaginary parts ..... 120
  - reflection formulas ..... 119
  - special values ..... 120
  - sums ..... 123
  - tables ..... 132
  - values on the cuts ..... 119–120
- Ising model
  - Appell functions ..... 417
  - combinatorics ..... 635
  - generalized hypergeometric functions ..... 417
  - Painlevé transcendents ..... 739
- isolated essential singularity ..... 19
  - ..... *see also* essential singularity.
  - movable ..... 724
- isolated singularity ..... 19
- iterative methods
  - Bairstow's method (for zeros of polynomials) ..... 91
  - bisection method ..... 91
  - convergence
    - cubic ..... 90
    - geometric ..... 90
    - linear ..... 90
    - local ..... 90
    - logarithmic ..... 94
    - of the  $p$ th order ..... 90
    - quadratic ..... 90
  - eigenvalue methods ..... 91
  - fixed-point methods ..... 92
  - Halley's rule ..... 92
  - Newton's rule (or method) ..... 90
  - regula falsi ..... 91
  - secant method ..... 91
  - Steffensen's method ..... 91
- Jacobi fraction ( $J$ -fraction) ..... 95
- Jacobi function
  - applications ..... 399
  - definition ..... 394
  - relations to other functions
    - associated Legendre functions ..... 355
    - conical functions ..... 379
    - hypergeometric function ..... 394
- Jacobi polynomials ..... **438**
  - ..... *see also* classical orthogonal polynomials.
  - applications
    - Bieberbach conjecture ..... 479
    - associated ..... 474

- asymptotic approximations ..... 451–452
- Bateman-type sums ..... 461
- computation ..... 479
- definition ..... 439
- derivatives ..... 446
- differential equations ..... 445
- expansions in series of ..... 459–461
- Fourier transform ..... 456
- generating functions ..... 449
- graphs ..... 440
- inequalities ..... 450, 451
  - Szegő–Szász ..... 451
  - Turan-type ..... 450
- integral representations ..... 447, 448
- integrals ..... 455–457, 459
  - fractional ..... 456
  - indefinite ..... 455
- interrelations with other orthogonal polynomials
  - ..... 444–445, 463, 464
- Laplace transform ..... 457
- leading coefficients ..... 439
- limiting form
  - as Bessel functions ..... 449
  - as Bessel polynomials ..... 476
- limits to monomials ..... 444
- local maxima and minima ..... 450–451
- Mellin transform ..... 457
- monic ..... 80
- normalization ..... 439
- notation ..... 436
- orthogonality properties ..... 439
- parameter constraint ..... 439, 443
- recurrence relations ..... 446
- relations to other functions
  - hypergeometric function ..... 393, 442
  - orthogonal polynomials on the triangle ..... 478
- Rodrigues formula ..... 442
- shifted ..... 437
- special values ..... 444
- symmetry ..... 444
- tables of coefficients ..... 440
- upper bounds ..... 450
- weight function ..... 439
- zeros ..... 438, 454
  - asymptotic approximations ..... 454
- Jacobi symbol
  - number theory ..... 642
- Jacobi transform ..... 379, 394
  - inversion ..... 394
- Jacobi’s amplitude function
  - ..... *see* amplitude (am) function.
- Jacobi’s epsilon function ..... **562**
  - applications ..... 563
  - computation ..... 567
  - definition ..... 562
  - graphs ..... 563
  - integral representations ..... 562
  - quasi-addition formula ..... 562
  - quasi-periodicity ..... 562
  - relation to Legendre’s elliptic integrals ..... 562
  - relation to theta functions ..... 562
  - tables ..... 567
- Jacobi’s identities
  - number theory ..... 645
- Jacobi’s imaginary transformation ..... 556
- Jacobi’s inversion problem for elliptic functions ..... 532
- Jacobi’s nome
  - power-series expansion ..... 490
- Jacobi’s theta functions ..... *see* theta functions.
- Jacobi’s triple product ..... 529
  - $q$ -version ..... 427
- Jacobi’s zeta function ..... **562**
  - computation ..... 567
  - definition ..... 562
  - graphs ..... 563
  - quasi-addition formula ..... 562
  - tables ..... 567
- Jacobi–Abel addition theorem
  - Jacobian elliptic functions ..... 564
- Jacobi-type polynomials ..... 477
- Jacobian ..... 9
- Jacobian elliptic functions ..... **550**
  - addition theorems ..... 557
  - analytic properties ..... 550, 563
  - applications
    - mathematical ..... 563–564
    - physical ..... 564–566
  - change of modulus ..... 563
  - computation ..... 566–567
  - congruent points ..... 553
  - coperiodic ..... 553
  - copolar ..... 553
  - cyclic identities
    - notation ..... 558
    - points ..... 558
    - rank ..... 558
    - simultaneously permuted ..... 558
  - definitions ..... 550
  - derivatives ..... 560
  - differential equations
    - first-order ..... 560
    - second-order ..... 560
  - double argument ..... 556
  - Eisenstein series ..... 559
  - elementary identities ..... 556
  - equianharmonic case ..... 555
  - expansions in doubly-infinite partial fractions ... 559
  - Fourier series ..... 559



- for squares.....559
  - fundamental unit cell.....554
  - Glaisher's notation.....550, 554
  - graphical interpretation via Glaisher's notation..554
  - graphics
    - complex modulus.....552–553
    - complex variable.....552
    - real variable.....550–552
  - half argument.....556
  - hyperbolic series for squares.....559
  - integrals
    - definite.....561
    - indefinite.....560
    - of squares.....562
  - interrelations.....508
  - inverse..... *see* inverse Jacobian elliptic functions.
  - Jacobi's imaginary transformation.....556
  - Landen transformations
    - ascending.....557, 563, 566
    - descending.....556, 563, 566
    - generalized.....557
    - theta functions.....531
  - lattice.....554
    - computation.....566
  - lemniscatic case.....555
  - limiting forms as  $k \rightarrow 0$  or  $k \rightarrow 1$ .....555
  - Maclaurin series
    - in  $k, k'$ .....559
    - in  $z$ .....558
  - modulus.....**550**
    - change of.....563
    - complex.....552, 553, 563
    - limiting values.....555
    - outside the interval  $[0, 1]$ .....563
    - purely imaginary.....563
    - real.....563
  - nome.....550
  - notation.....550
  - periods.....550, 553–554
  - poles.....553–554
  - poristic polygon constructions.....557
  - principal.....550
  - relations to other functions
    - symmetric elliptic integrals.....508
    - theta functions.....550
    - Weierstrass elliptic functions.....575
  - rotation of argument.....556
  - special values of the variable.....554–555, 557
  - subsidiary.....550
  - sums of squares.....556
  - tables.....567
  - translation of variable.....554
  - trigonometric series expansions.....559
  - zeros.....553
- Jensen's inequality for integrals.....13
  - Jonquière's function..... *see* polylogarithms.
  - Jordan curve theorem.....16
  - Jordan's function
    - number theory.....638
  - Jordan's inequality
    - sine function.....116
  - Julia sets.....92
  - Kadomtsev–Petviashvili equation
    - Riemann theta functions.....545
  - Kapteyn's inequality
    - Bessel functions.....227
  - Kelvin functions.....**267**
    - applications.....276
    - approximations.....281
    - asymptotic expansions for large argument.....271
      - cross-products and sums of squares.....271
      - exponentially-small contributions.....271
    - asymptotic expansions for large order... *see* uniform asymptotic expansions for large order.
    - computation.....276–277
    - cross-products.....269
    - definitions.....267
    - derivatives.....269
      - with respect to order.....269
    - differential equations.....268
    - expansions in series of Bessel functions.....270
    - graphs.....268
    - integral representations.....269
    - integrals
      - compendia.....274
      - definite.....274
      - indefinite.....274
      - Laplace transforms.....274
    - modulus and phase functions
      - asymptotic expansions for large argument.....272
      - definitions.....272
      - properties.....272
    - notation.....217
    - orders  $\pm \frac{1}{2}$ .....268
    - power series.....269–270
      - compendia.....270
      - cross-products and sums of squares.....270
    - recurrence relations.....269
    - reflection formulas for arguments and orders...268
    - uniform asymptotic expansions for large order...273
      - double asymptotic property.....273
      - exponentially-small contributions.....273
    - zeros
      - asymptotic approximations for large zeros.....273
      - computation.....277
      - tables.....281
  - Kelvin's ship-wave pattern.....790–791
  - kernel equations

- Heun's equation ..... 715, 716
- kernel functions
- Heun's equation ..... 715, 716
- Klein's complete invariant ..... *see* modular functions.
- Klein–Gordon equation
- Coulomb functions ..... 754
- Kontorovich–Lebedev transform
- modified Bessel functions ..... 260
  - computation ..... 278
- Korteweg–de Vries equation
- Airy functions ..... 209
  - Jacobian elliptic functions ..... 565
  - Lamé polynomials ..... 694
  - Painlevé transcendents ..... 738
  - Riemann theta functions ..... 545
  - Weierstrass elliptic functions ..... 582
- Kovacic's algorithm ..... 713, 718
- KP equation ..... *see* Kadomtsev–Petviashvili equation.
- Krattenthaler's formula for determinants ..... 4
- Krawtchouk polynomials
- ..... *see also* Hahn class orthogonal polynomials.
  - applications
    - coding theory ..... 479
    - relation to hypergeometric function ..... 394
- Kummer congruences
- Bernoulli and Euler numbers ..... 593
- Kummer functions ..... **322**
- ..... *see also* confluent hypergeometric functions.
  - addition theorems ..... 333
  - analytic continuation ..... 323
  - analytical properties ..... 322
  - applications
    - physical ..... 346  - approximations ..... 347
  - asymptotic approximations for large parameters
    - large  $a$  ..... 330–331
    - large  $b$  ..... 330
    - uniform ..... 330–331  - asymptotic expansions for large argument .. 328–329
    - error bounds ..... 329
    - exponentially-improved ..... 329
    - hyperasymptotic ..... 329  - Chebyshev-series expansions ..... 347
  - computation ..... 346–347
  - connection formulas ..... 325
  - continued fractions ..... 327
  - definitions ..... 322
  - derivatives ..... 325–326
  - differential equation ..... *see* Kummer's equation
  - integer parameters ..... 322–323
  - integral representations
    - along the real line ..... 326
    - contour integrals ..... 326–327
    - Mellin–Barnes type ..... 327
- integrals
- along the real line ..... 326
  - compendia ..... 333
  - Fourier transforms ..... 332
  - Hankel transforms ..... 332–333
  - indefinite ..... 332
  - Laplace transforms ..... 332
  - Mellin transforms ..... 332
- interrelations ..... 322, 325
- Kummer's transformations ..... 325
- limiting forms
- as  $z \rightarrow 0$  ..... 323
  - as  $z \rightarrow \infty$  ..... 323
- Maclaurin series ..... 322
- multiplication theorems ..... 334
- notation ..... 322
- polynomial cases ..... 322, 323
- principal branches (or values) ..... 322
- products ..... 333
- recurrence relations ..... 325
- relations to other functions
- Airy functions ..... 328
  - elementary functions ..... 327
  - error functions ..... 328
  - generalized hypergeometric functions ..... 328
  - incomplete gamma functions ..... 328
  - modified Bessel functions ..... 328
  - orthogonal polynomials ..... 328
  - parabolic cylinder functions ..... 328
  - Whittaker functions ..... 334
- series expansions
- addition theorems ..... 333
  - in modified Bessel functions ..... 333
  - Maclaurin ..... 322
  - multiplication theorems ..... 334
- tables ..... 347
- Wronskians ..... 324
- zeros
- asymptotic approximations ..... 331
  - distribution ..... 331
  - inequalities ..... 331
  - number of ..... 331
- Kummer's equation ..... 322
- equivalent form ..... 325
  - fundamental solutions ..... 323–324
  - numerically satisfactory solutions ..... 323–324
  - relation to hypergeometric differential equation .. 322
  - relation to Whittaker's equation ..... 334
  - standard solutions ..... 322
- Kummer's transformations
- for  ${}_3F_2$  hypergeometric functions of matrix argument
    - ..... 772  - for confluent hypergeometric functions ..... 325
- L'Hôpital's rule for derivatives ..... 5

- Lagrange interpolation ..... 75–76  
 abscissas ..... 75  
 coefficients ..... 75  
 equally-spaced nodes ..... 75–76  
 error term ..... 75  
 formula ..... 75  
 Newton’s interpolation formula ..... 76  
 nodal polynomials ..... 75  
 nodes ..... 75  
 polynomial ..... 75  
 remainder terms ..... 75–76  
 via divided differences ..... 76
- Lagrange inversion theorem ..... 21  
 extended ..... 21
- Lagrange’s formula for reversion of series ..... 43
- Laguerre functions  
 associated ..... 754
- Laguerre polynomials ..... 438  
 ..... *see also* classical orthogonal polynomials.  
 addition theorem ..... 460  
 applications  
 Schrödinger equation ..... 479  
 asymptotic approximations ..... 452–453  
 computation ..... 479  
 continued fraction ..... 450  
 derivatives ..... 447  
 differential equations ..... 445  
 Dirac delta ..... 38  
 expansions in series of ..... 459, 460  
 explicit representations ..... 442–443  
 Fourier transforms ..... 457  
 generalized ..... 436  
 generating functions ..... 449  
 graphics ..... 441  
 inequalities ..... 450, 451  
 Turan-type ..... 450  
 integral representations ..... 447, 448  
 integrals ..... 455–457  
 fractional ..... 456  
 indefinite ..... 455  
 interrelations with other orthogonal polynomials  
 ..... 445, 463, 464  
 Laplace transform ..... 457  
 leading coefficients ..... 439  
 limiting form as a Bessel function ..... 449  
 limits to monomials ..... 444  
 local maxima and minima ..... 451  
 Mellin transform ..... 458  
 monic ..... 80  
 multiplication theorem ..... 460  
 normalization ..... 439  
 notation ..... 436  
 orthogonality properties ..... 439  
 parameter constraint ..... 439, 443
- Poisson kernels ..... 461  
 recurrence relations ..... 446  
 relation to confluent hypergeometric functions  
 ..... 328, 338, 443, 448
- Rodrigues formula ..... 442  
 tables ..... 480  
 of coefficients ..... 440  
 of zeros ..... 81  
 tables of zeros ..... 81  
 upper bounds ..... 450  
 value at  $z = 0$  ..... 443  
 weight function ..... 439  
 zeros ..... 438, 454  
 asymptotic behavior ..... 454  
 tables ..... 81
- Lamé functions ..... 684  
 algebraic ..... 693  
 applications  
 conformal mapping ..... 694  
 physical ..... 694  
 rotation group ..... 694  
 sphero-conal coordinates ..... 693  
 asymptotic expansions ..... 689  
 computation ..... 694  
 definition ..... 685  
 differential equation ..... *see* Lamé’s equation.  
 eigenvalues  
 asymptotic expansions ..... 689  
 coalescence ..... 685  
 computation ..... 694  
 continued-fraction equation ..... 685  
 definition ..... 685  
 distribution ..... 685  
 graphics ..... 686–687  
 interlacing ..... 685  
 limiting forms ..... 688  
 notation ..... 684  
 parity ..... 685  
 periods ..... 685  
 power-series expansions ..... 686  
 special cases ..... 688  
 tables ..... 694  
 Fourier series ..... 688–689  
 graphics ..... 687–688  
 integral equations ..... 689  
 limiting forms ..... 688  
 normalization ..... 686  
 notation ..... 684  
 order ..... 685  
 orthogonality ..... 686  
 parity ..... 686  
 period ..... 686  
 relations to Heun functions ..... 713  
 relations to Lamé polynomials ..... 689, 690

- special cases ..... 688
- with imaginary periods ..... 690
- with real periods ..... 685
- zeros ..... 685
- Lamé polynomials ..... **690**
- algebraic form ..... 691
- applications
  - ellipsoidal harmonics ..... 694
  - physical ..... 691, 694
  - spherical harmonics ..... 694
- asymptotic expansions ..... 693
- Chebyshev series ..... 693
- coefficients ..... 694
- computation ..... 694
- definition ..... 690
- eigenvalues
  - asymptotic expansions ..... 693
  - computation ..... 694
  - graphics ..... 691
- elliptic-function form ..... 690
- explicit formulas ..... 693
- Fourier series ..... 692
- graphics ..... 692
- notation ..... 684, 690, 691
- orthogonality ..... 692
- periodicity ..... 690
- relation to Lamé functions ..... 689, 690
- tables ..... 694
- zeros ..... 690
  - computation ..... 694
  - electrostatic interpretation ..... 691
- Lamé wave equation ..... 690
- Lamé's equation ..... **684**
- algebraic form ..... 684
- eigenfunctions ..... 686
- eigenvalues ..... *see* Lamé functions, eigenvalues.
- Jacobian elliptic-function form ..... 684
- other forms ..... 684–685
- relation to Heun's equation ..... 685
- second solution ..... 693
- singularities ..... 684
- stability ..... 690
- trigonometric form ..... 684
- Weierstrass elliptic-function form ..... 685
- Lamé–Wangerin functions ..... 693
- Lambert  $W$ -function ..... **111**
- applications ..... 131
- asymptotic expansions ..... 111
- computation ..... 132
- definition ..... 111
- graphs ..... 111
- integral representations ..... 111
- notation ..... 111
- principal branch ..... 111
  - other branches ..... 111
  - properties ..... 111
- Lambert series
  - number theory ..... 641
- Lanczos tridiagonalization of a symmetric matrix ... 75
- Lanczos vectors ..... 75
- Landen transformations
  - Jacobian elliptic functions ..... 556, 557, 563, 566
  - theta functions ..... 531
- Laplace equation
  - $3j, 6j, 9j$  symbols ..... 765
- Laplace transform
  - analyticity ..... 28
  - asymptotic expansions for large parameters
    - ..... 43, 44, 46
  - asymptotic expansions for small parameters ..... 51
  - convergence ..... 28
  - convolution ..... 28
  - definition ..... 28
  - derivatives ..... 28
  - differentiation ..... 28
  - for functions of matrix argument ..... 768
    - analytic properties ..... 768
    - convolution theorem ..... 768
    - definition ..... 768
    - inversion formula ..... 768
  - integration ..... 28
  - inversion ..... 28
  - notation ..... 28
  - numerical inversion ..... 83–84, 99
  - of periodic functions ..... 28
  - tables ..... 32
  - translation ..... 28
  - uniqueness ..... 29
- Laplace's equation
  - Bessel functions ..... 275
  - for elliptical cones ..... 694
  - spherical coordinates ..... 379
  - symmetric elliptic integrals ..... 501
  - toroidal coordinates ..... 379
- Laplace's method for asymptotic expansions of integrals
  - ..... 44, 47
- Laplacian ..... 7
  - cylindrical coordinates ..... 7
  - ellipsoidal coordinates ..... 583
  - numerical approximations ..... 78
  - oblate spheroidal coordinates ..... 706
  - parabolic cylinder coordinates ..... 317
  - polar coordinates ..... 7
  - prolate spheroidal coordinates ..... 705
  - spherical coordinates ..... 8
- lattice
  - for elliptic functions
    - ..... *see* Weierstrass elliptic functions, lattice.

- lattice models of critical phenomena  
  elliptic integrals.....517
- lattice parameter  
  theta functions.....524
- lattice paths.....618–623  
  definition.....618  
   $k$ -dimensional.....618
- lattice walks  
  Appell functions.....417  
  generalized hypergeometric functions.....417
- Laurent series.....19  
  asymptotic approximations for coefficients.....65
- Lauricella's function  
  relation to symmetric elliptic integrals.....509
- Lax pairs  
  classical orthogonal polynomials.....478  
  Painlevé transcendents.....728
- layered materials  
  elliptic integrals.....517
- least squares approximations.....99–100  
  conditioning.....99  
  normal equations.....99  
  orthogonal functions with respect to weighted summation.....99
- Lebesgue constants.....13, 97  
  asymptotic behavior.....13
- Legendre functions.....352  
  .. *see also* associated Legendre functions *and* Ferrers functions.  
  complex degree.....379
- Legendre functions on the cut... *see* Ferrers functions.
- Legendre polynomials.....438  
  ..... *see also* classical orthogonal polynomials.  
  addition theorem.....459  
  applications  
    Schrödinger equation.....479  
  associated.....474  
  asymptotic approximations.....452  
  computation.....479  
  continued fraction.....450  
  definition.....439  
  differential equation.....445  
  Dirac delta.....38  
  expansions in series of.....459, 461  
  explicit representations.....442–443  
  Fourier transforms.....456  
  generating functions.....449  
  graphs.....441  
  inequalities.....450  
    Turan-type.....450  
  integral representations.....447, 448  
    for products.....455  
  integrals.....455, 458  
    Nicholson-type.....455
- interrelations with other orthogonal polynomials.....444
- large degree.....65
- leading coefficients.....439
- Mellin transforms.....458
- monic.....80
- normalization.....439
- notation.....436
- orthogonality properties.....439
- recurrence relations.....446
- relations to other functions  
  associated Legendre functions.....360  
  Ferrers functions.....360  
  hypergeometric function.....394  
   $3j$  symbols.....760–761
- Rodrigues formula.....442
- shifted.....436, 439
- special values.....444
- symmetry.....444
- tables.....480  
  of coefficients.....440  
  of zeros.....80
- value at argument zero.....285
- weight function.....439
- zeros.....438, 454  
  tables.....80
- Legendre symbol  
  prime numbers.....642
- Legendre's elliptic integrals.....486  
  addition theorem.....495  
  applications  
    mathematical.....514–516  
    physical.....517  
  approximations (except asymptotic).....519  
  arithmetic-geometric mean.....492  
  asymptotic approximations.....495  
  change of amplitude.....492  
  change of modulus.....492  
  change of parameter.....492  
  circular cases.....487, 492  
  complete.....487  
  computation.....517–518  
  connection formulas.....491  
  derivatives.....490  
  differential equations.....490  
  duplication formulas.....495  
  first, second, and third kinds.....486  
  Gauss transformation.....493  
  graphics.....488–489  
  hyperbolic cases.....487, 492  
  imaginary-argument transformations.....492  
  imaginary-modulus transformations.....492  
  incomplete.....486  
  inequalities

- complete integrals ..... 494
- incomplete integrals ..... 494
- integration
  - with respect to amplitude ..... 496
  - with respect to modulus ..... 496
- Landen transformations
  - ascending ..... 493
  - descending ..... 493
- Laplace transforms ..... 496
- limiting values ..... 491
- notation ..... 486
- power-series expansions ..... 490
- quadratic transformations ..... 492
- reciprocal-modulus transformation ..... 492
- reduction of general elliptic integrals ..... 496–497
- relations to other functions
  - am function ..... 562
  - Appell functions ..... 490
  - inverse Gudermannian function ..... 491
  - inverse Jacobian elliptic functions ..... 561
  - Jacobi's epsilon function ..... 562
  - Jacobi's zeta function ..... 562
  - Jacobian elliptic functions ..... 494
  - symmetric elliptic integrals ..... 507, 508
  - theta functions ..... 494
  - Weierstrass elliptic functions ..... 494
- special cases ..... 491
- tables ..... 518–519
- Legendre's equation ..... 352
- standard solutions ..... 352
- Legendre's relation
  - Legendre's elliptic integrals ..... 492
- Legendre's relation for the hypergeometric function
  - generalized ..... 399
- Leibniz's formula for derivatives ..... 5
- lemniscate arc length ..... 563
- lemniscate constants ..... 502, 503
- lengths of plane curves
  - Bernoulli's lemniscate ..... 515
  - ellipse ..... 514
  - hyperbola ..... 514
- Lerch's transcendent
  - definition ..... 612
  - properties ..... 612
  - relation to Hurwitz zeta function ..... 612
  - relation to polylogarithms ..... 612
- level-index arithmetic ..... 73
- Levi-Civita symbol for vectors ..... 10
- Levin's transformations
  - application to asymptotic expansions ..... 69
  - for sequences ..... 94
- Lie algebras
  - $q$ -series ..... 432
- light absorption
  - Voigt functions ..... 169
- limit points (or limiting points) ..... 15
- limits of functions
  - of a complex variable ..... 15
  - of one variable ..... 4
  - of two complex variables ..... 15
  - of two variables ..... 7
- line broadening function ..... 167
- linear algebra ..... 73–75
  - ..... *see also* Gaussian elimination.
  - condition numbers ..... 74, 75
  - conditioning of linear systems ..... 74
  - error bounds ..... 74
    - a posteriori* ..... 74
  - norms
    - Euclidean ..... 74
    - of arbitrary order ..... 74
    - of matrices ..... 74
    - of vectors ..... 74
- linear functional ..... 35
- linear transformation ..... 17
- Liouville transformation for differential equations
  - ..... 26, 58
- Liouville's function
  - number theory ..... 639
- Liouville's theorem for entire functions ..... 16
- Liouville–Green (or WKBJ) approximation ..... 57
  - for difference equations ..... 62
- little  $q$ -Jacobi polynomials ..... 471
- local maxima and minima ..... 450
- locally analytic ..... 724
- locally integrable ..... 48
- logarithm function ..... 104
  - analytic properties ..... 104
  - approximations ..... 132
  - branch cut ..... 104
  - Briggs ..... 105
  - Chebyshev-series expansions ..... 132
  - common ..... 105
  - computation ..... 131
  - conformal maps ..... 106
  - continued fractions ..... 109
  - definition ..... 104
  - derivatives ..... 108
  - differential equations ..... 109
  - general base ..... 105
  - general value ..... 104
  - generalized ..... 111
  - graphics
    - complex argument ..... 107
    - real argument ..... 106
  - hyperbolic ..... 105
  - identities ..... 109
  - inequalities ..... 108

- integrals ..... 110
- limits ..... 107
- Napierian ..... 105
- natural ..... 105
- notation ..... 104
- power series ..... 108
- principal value ..... 104
- real and imaginary parts ..... 104
- special values ..... 107
- sums ..... 110
- tables ..... 132
- values on the cut ..... 104
- zeros ..... 104
- logarithmic integral ..... **150**
  - asymptotic expansion ..... 153
  - definition ..... 150
  - graph ..... 155
  - notation ..... 150
  - number-theoretic significance ..... 155
  - relation to exponential integrals ..... 150
- Lommel functions ..... **294**
  - asymptotic expansions for large argument ..... 295
  - computation ..... 299
  - definitions ..... 294–295
  - differential equation ..... 294
  - integral representations ..... 295
  - integrals ..... 295
  - notation ..... 288
  - power series ..... 294
  - reflection formulas ..... 295
  - relation to Anger–Weber functions ..... 296
  - series expansions
    - Bessel functions ..... 295
    - power series ..... 294
- Lucas numbers ..... 596
- M*-test for uniform convergence
  - infinite products ..... 21
  - infinite series ..... 17
- magic squares
  - number theory ..... 648
- magnetic monopoles
  - Riemann theta functions ..... 545
- Mangoldt’s function
  - number theory ..... 639
- many-body systems
  - confluent hypergeometric functions ..... 346
- many-valued function ..... *see* multivalued function.
- mathematical constants ..... 100
- Mathieu functions ..... **652, 664**
  - ..... *see also* Mathieu’s equation, modified Mathieu functions, *and* radial Mathieu functions.
  - analytic properties ..... 653, 661, 665
  - antiperiodicity ..... 654
  - applications
    - mathematical ..... 677–678
    - physical ..... 678–679
  - asymptotic expansions for large  $q$ 
    - .. *see also* uniform asymptotic approximations for large parameters.
    - Goldstein’s ..... 662
    - Sips’ ..... 661
  - computation ..... 679–680
  - connection formulas ..... 665
  - definitions ..... 664
  - differential equation ..... 652
  - expansions in series of ..... 664, 667
  - Fourier coefficients
    - asymptotic forms for small  $q$  ..... 657, 666
    - asymptotic forms of higher coefficients ..... 657
    - normalization ..... 657, 666
    - recurrence relations ..... 656, 666
    - reflection properties in  $q$  ..... 657
    - tables ..... 680
    - values at  $q = 0$  ..... 657
  - Fourier series ..... 653, 656, 666
  - graphics ..... 655–656, 665
  - integral equations
    - compendia ..... 663
    - variable boundaries ..... 663
    - with Bessel-function kernels ..... 663
    - with elementary kernels ..... 663, 672
  - integral representations ..... 672
    - compendia ..... 674
  - integrals
    - compendia ..... 674
    - of products ..... 674
    - of products with Bessel functions ..... 673–674
  - irreducibility ..... 661
  - limiting forms as order tends to integers ..... 665
  - normalization ..... 654, 664
  - notation ..... 652
  - of integer order ..... **654**
  - of noninteger order ..... **664**
  - orthogonality ..... 654, 664
  - parity ..... 654
  - periodicity ..... 654, 664
  - power series in  $q$  ..... 660, 666
  - pseudoperiodicity ..... 653, 664
  - reflection properties in  $\nu$  ..... 664
  - reflection properties in  $q$  ..... 654, 664, 665
  - reflection properties in  $z$  ..... 664
  - relations to other functions
    - basic solutions of Mathieu’s equation ..... 654
    - confluent Heun functions ..... 717
    - modified Mathieu functions ..... 667
  - tables ..... 680
  - uniform asymptotic approximations for large parameters

- Barrett's ..... 662
- Dunster's ..... 662–663
- values at  $q = 0$  ..... 654
- Wronskians ..... 658
- zeros ..... 663
  - tables ..... 680
- Mathieu's equation ..... **652**
  - algebraic form ..... 652
  - basic solutions ..... 653
    - relation to eigenfunctions ..... 654
  - characteristic equation ..... 653
  - characteristic exponents ..... 653
    - computation ..... 679
  - eigenfunctions ..... *see* Mathieu functions.
  - eigenvalues (or characteristic values) ..... 653
    - analytic continuation ..... 661
    - analytic properties ..... 661
    - asymptotic expansions for large  $q$  ..... 661, 666
    - branch points ..... 661
    - characteristic curves ..... 667
    - computation ..... 679
    - continued-fraction equations ..... 659, 666
    - distribution ..... 654, 664
    - exceptional values ..... 661
    - graphics ..... 654, 665
    - normal values ..... 661, 664
    - notation ..... 652, 653, 664
    - power-series expansions in  $q$  ..... 659–660, 666
    - reflection properties in  $\nu$  ..... 664
    - reflection properties in  $q$  ..... 654, 664
    - tables ..... 680
  - Floquet solutions ..... 653
    - computation ..... 679
    - Fourier-series expansions ..... 653
    - uniqueness ..... 653
  - Floquet's theorem ..... 653
  - parameters
    - definition ..... 652
    - stability chart ..... 667
    - stable pairs ..... 667
    - stable regions ..... 667
    - unstable pairs ..... 667
  - second solutions
    - antiperiodicity ..... 657
    - definitions ..... 657
    - expansions in Mathieu functions ..... 658
    - Fourier series ..... 658
    - graphics ..... 658
    - normalization ..... 657
    - notation ..... 652
    - periodicity ..... 657
    - reflection properties in  $q$  ..... 658
    - values at  $q = 0$  ..... 658
  - singularities ..... 652
  - standard form ..... 652
  - Theorem of Ince ..... 653, 657
  - transformations ..... 653
- matrix
  - ..... *see also* linear algebra.
  - augmented ..... 73
  - characteristic polynomial ..... 74
  - condition number ..... 74
  - eigenvalues ..... 74–75
    - characteristic polynomial ..... 74
    - computation ..... 75
    - condition numbers ..... 75
    - conditioning ..... 75
    - multiplicity ..... 74
  - eigenvectors
    - left ..... 74
    - normalized ..... 74
    - right ..... 74
  - equivalent ..... 542
  - factorization ..... 73
  - Jacobi ..... 82
  - nondefective ..... 74
  - norms ..... 74
  - Riemann ..... 538
  - symmetric
    - tridiagonalization ..... 75
  - symplectic ..... 541
  - triangular decomposition ..... 73
  - tridiagonal ..... 74
- maximum ..... 7
  - local ..... 5, 8
- maximum-modulus principle
  - analytic functions ..... 20
  - harmonic functions ..... 20
  - Schwarz's lemma ..... 20
- McKean and Moll's theta functions ..... 524
- McMahon's asymptotic expansions
  - zeros of Bessel functions ..... 236
    - error bounds ..... 236
- mean value property for harmonic functions ..... 16
- mean value theorems
  - differentiable functions ..... 5
  - integrals ..... 6
- means ..... *see* Abel
  - means, arithmetic mean, Cesàro means, geometric mean, harmonic mean, *and* weighted means.
- measure ..... 437
  - theory ..... 437
- Mehler functions ..... *see* conical functions.
- Mehler–Dirichlet formula
  - Ferrers functions ..... 363
- Mehler–Fock transformation ..... 373, 379
  - generalized ..... 373, 379
- Mehler–Sonine integrals



- Bessel and Hankel functions.....224
- Meijer  $G$ -function.....415
- approximations.....418
- asymptotic expansions.....417
- differential equation.....417
- identities.....416
- integral representations.....415
- integrals.....416
- notation.....415
- relation to generalized hypergeometric function  
    .....415–416
- special cases.....416
- sums.....416
- Meixner polynomials  
  ..... *see* Hahn class orthogonal polynomials.
- relation to hypergeometric function.....394
- Meixner–Pollaczek polynomials  
  ..... *see* Hahn class orthogonal polynomials.
- relation to hypergeometric function.....394
- Mellin transform
- analytic properties.....48
- analyticity.....29
- convergence.....29
- convolution.....29
- convolution integrals.....49
- definition.....29, 48
- inversion.....29, 48
- notation.....29
- Parseval-type formulas.....29
- tables.....32
- Mellin–Barnes integrals.....145
- meromorphic function.....19
- Mersenne numbers  
  number theory.....648
- Mersenne prime  
  number theory.....644
- method of stationary phase  
  asymptotic approximations of integrals.....45
- metric coefficients
- for oblate spheroidal coordinates.....705
- for prolate spheroidal coordinates.....704
- Mill’s ratio for complementary error function.....163
- inequalities.....163
- Miller’s algorithm  
  difference equations.....85–87
- minimax polynomial approximations.....96
- computation of coefficients.....96
- minimax rational approximations.....97
- computation of coefficients.....98
- type.....97
- weight function.....97
- minimum.....7
- local.....5, 8
- Minkowski’s inequalities for sums and series.....12, 13
- minor..... *see* determinants.
- Mittag-Leffler function.....261
- Mittag-Leffler’s expansion  
  infinite partial fractions.....22
- Möbius transformation.... *see* bilinear transformation.
- Möbius function  
  number theory.....639
- Möbius inversion formulas  
  number theory.....641
- modified Bessel functions.....248
- addition theorems.....260
- analytic continuation.....253
- applications
- asymptotic solutions of differential equations..274
- wave equation.....275
- approximations.....281
- asymptotic expansions for large argument ..255–256
- error bounds.....255, 256
- exponentially-improved.....256
- for derivatives with respect to order.....255
- for products.....255
- asymptotic expansions for large order.....256–258
- asymptotic forms.....256
- double asymptotic properties.....257–258
- in inverse factorial series.....257
- uniform.....256–257
- branch conventions.....249
- computation.....276–277
- connection formulas.....251
- continued fractions.....253
- cross-products.....251
- definitions.....248
- derivatives
- asymptotic expansions for large argument....255
- explicit forms.....252
- uniform asymptotic expansions for large order  
      .....256–257
- derivatives with respect to order.....254
- asymptotic expansion for large argument.....255
- differential equations.....248, 254
- ..... *see also* modified Bessel’s equation.
- generating function.....254
- graphics.....249
- hyperasymptotic expansions.....276
- incomplete.....262
- inequalities.....254
- integral representations
- along real line.....252–253
- compendia.....253
- contour integrals.....253
- Mellin–Barnes type.....253
- products.....253
- integrals .. *see* integrals of modified Bessel functions.
- limiting forms.....252

- monotonicity .....254
- multiplication theorem .....260
- notation .....217
- of imaginary order
  - approximations .....281
  - computation .....278
  - definitions .....261
  - graphs .....250, 251
  - limiting forms .....261
  - numerically satisfactory pairs .....261
  - tables .....280
  - uniform asymptotic expansions for large order
    - .....261
  - zeros .....261
- power series .....252
- principal branches (or values) .....249
- recurrence relations .....251
- relations to other functions
  - Airy functions .....197
  - confluent hypergeometric functions ..255, 328, 338
  - elementary functions .....254
  - generalized Airy functions .....206
  - generalized hypergeometric functions .....255
  - parabolic cylinder functions .....255, 308
- sums
  - addition theorems .....260
  - compendia .....261
  - expansions in series of .....261
  - multiplication theorem .....260
- tables .....279
- Wronskians .....251
- zeros .....258
  - computation .....277
  - tables .....280
- modified Bessel's equation .....248
  - inhomogeneous forms .....288, 295
  - numerically satisfactory solutions .....249
  - singularities .....248
  - standard solutions .....249
- modified Korteweg–de Vries equation
  - Painlevé transcendents .....738
- modified Mathieu functions .....667
  - ..... *see also* radial Mathieu functions.
  - addition theorems .....672
  - analytic continuation .....668
  - applications
    - mathematical .....677
    - physical .....678–679
  - asymptotic approximations
    - .. *see also* uniform asymptotic approximations for large parameters.
    - for large  $\Re z$  .....667, 672
    - for large  $q$  .....672
  - computation .....680
  - connection formulas .....667, 669
  - definitions .....667
  - differential equation .....667
  - expansions in series of
    - Bessel functions .....670
    - cross-products of Bessel functions and modified Bessel functions .....671
  - graphics .....669
  - integral representations .....672–674
    - compendia .....674
    - of cross-products .....674
  - integrals .....672
    - compendia .....674
  - joining factors .....652, 669
    - tables .....680
  - notation .....652
  - relation to Mathieu functions .....667
  - shift of variable .....668
  - tables .....680
  - uniform asymptotic approximations for large parameters .....662, 672
  - Wronskians .....668
  - zeros
    - tables .....680
- modified Mathieu's equation .....667
  - algebraic form .....667
- modified spherical Bessel functions
  - ..... *see* spherical Bessel functions.
- modified Struve functions ... *see* Struve functions and modified Struve functions.
- modified Struve's equation ... *see* Struve functions and modified Struve functions, differential equations.
- modular equations
  - modular functions .....582
- modular functions .....579
  - analytic properties .....579
  - applications
    - mathematical .....581–582
    - physical .....582–583
  - computation .....583
  - cuspidal form .....579
  - definitions .....579
  - elementary properties .....580
  - general .....579
  - graphics .....579
  - infinite products .....580
  - interrelations .....581
  - Laurent series .....580
  - level .....579
  - modular form .....579
  - modular transformations .....580
  - notation .....570, 579
  - power series .....580
  - relations to theta functions .....525, 532, 579

- special values ..... 580
- modular theorems
  - generalized elliptic integrals ..... 516
- molecular spectra
  - Coulomb functions ..... 753
- molecular spectroscopy
  - $3j, 6j, 9j$  symbols ..... 765
- mollified error ..... 73
- moment functionals ..... 476
- monic polynomial ..... 22, 80
- monodromy groups
  - Heun functions ..... 719
  - hypergeometric function ..... 400
- monosplines
  - Bernoulli ..... 597
  - cardinal ..... 597
- monotonicity ..... 4
- Monte Carlo sampling ..... 189
- Monte-Carlo methods
  - for multidimensional integrals ..... 84
- Mordell's theorem ..... 582
  - elliptic curves ..... 581
- Motzkin numbers
  - definition ..... 621
  - generating function ..... 623
  - identities ..... 623
  - recurrence relation ..... 623
  - relation to lattice paths ..... 621
  - table ..... 622
- multidimensional theta functions
  - ..... *see* Riemann theta functions *and* Riemann theta functions with characteristics.
- multinomial coefficients
  - definitions ..... 620
  - generating function ..... 620
  - recurrence relation ..... 620
  - relation to lattice paths ..... 620
  - table ..... 620
- multiple orthogonal polynomials ..... 477
- multiplicative functions ..... 640
- multiplicative number theory ..... 638–644
  - completely multiplicative functions ..... 640
  - Dirichlet series ..... 640
  - Euler product ..... 640
  - fundamental theorem of arithmetic ..... 638
  - multiplicative functions ..... 640
  - notation ..... 638
  - primitive roots ..... 638
- multivalued function ..... 20
  - branch ..... 20, 104
  - branch cut ..... 104
  - principal value ..... 104
    - closed definition ..... 104
- multivariate beta function
  - definition ..... 768
  - notation ..... 768
  - properties ..... 769
- multivariate gamma function
  - definition ..... 768
  - notation ..... 768
  - properties ..... 769
- multivariate hypergeometric function ..... 498
- mutual inductance of coaxial circles
  - elliptic integrals ..... 516
- $n$ -dimensional sphere
  - gamma function ..... 145
- Nörlund polynomials ..... 596
- nanotubes
  - Struve functions ..... 298
- Narayana numbers
  - definition ..... 622
  - generating function ..... 623
  - identity ..... 623
  - relation to lattice paths ..... 622
  - table ..... 622
- negative definite
  - Taylor series ..... 8
- neighborhood ..... 7, 15
  - cut ..... 20
  - of infinity ..... 16
  - punctured ..... 19
- Neumann's addition theorem
  - Bessel functions ..... 246
  - modified Bessel functions ..... 260
- Neumann's expansion
  - Bessel functions ..... 247
- Neumann's integral
  - Bessel functions ..... 224
  - Legendre functions ..... 364
- Neumann's polynomial
  - Bessel functions ..... 247
- Neumann-type expansions
  - modified Bessel functions ..... 261
- Neville's theta functions ..... 524
  - relations to Jacobian elliptic functions ..... 550
- Newton's interpolation formula ..... 76
- Newton's rule (or method) ..... 90
  - convergence ..... 90
- Nicholson's integral
  - Bessel functions ..... 225
- Nicholson-type integral
  - parabolic cylinder functions ..... 313
- $9j$  symbols ..... **763**
  - addition theorem ..... 764
  - applications ..... 765
  - approximations for large parameters ..... 764
  - computation ..... 765
  - definition ..... 763

- generating functions ..... 764
- graphical method ..... 765
- notation ..... 758
- orthogonality ..... 764
- recursion relations ..... 764
- representation as
  - finite sum of  $6j$  symbols ..... 763
  - finite sum of  $3j$  symbols ..... 763
  - generalized hypergeometric functions ..... 764
- special case ..... 764
- sum rule ..... 764
- summation convention ..... 760
- sums ..... 764
- symmetry ..... 764
- tables ..... 765
- zeros ..... 765
- nodal polynomials ..... 75
- nodes ..... 79, 80
- nome
  - Jacobi's ..... 490
  - Jacobian elliptic functions ..... 550
  - theta functions ..... 524
  - Weierstrass elliptic functions ..... 570
- nonlinear equations
  - fixed points ..... 90
  - numerical solutions
    - iterative methods ..... 90–92
  - systems ..... 92
- nonlinear evolution equations
  - Weierstrass elliptic functions ..... 582
- nonlinear harmonic oscillator
  - Painlevé equations ..... 725
- nonlinear ordinary differential equations
  - Jacobian elliptic functions ..... 565
- nonlinear partial differential equations
  - Jacobian elliptic functions ..... 565
- normal probability functions ..... 160
- Novikov's conjecture
  - Riemann theta functions ..... 546
- nuclear physics
  - Coulomb functions ..... 754
- nuclear structure
  - $3j, 6j, 9j$  symbols ..... 765
- number theory ..... *see also* additive number theory, multiplicative number theory, *and* prime numbers.
  - Bernoulli and Euler numbers and polynomials ... 598
  - generalized hypergeometric functions ..... 417
  - Jacobian elliptic functions ..... 564
  - modular functions ..... 582
  - theta functions ..... 533
  - Weierstrass elliptic functions ..... 582
- number-theoretic functions ..... 638–643
  - completely multiplicative ..... 640
  - computation ..... 649
- Dirichlet character ..... 642
  - induced modulus ..... 642
  - Legendre symbol ..... 642
  - primitive ..... 642
  - principal ..... 642
- Dirichlet divisor problem ..... 643
- divisor function ..... 638
- divisor sums ..... 641
- inversion formulas ..... 641
- Lambert series ..... 641
- Möbius inversion ..... 641, 647
  - pairs ..... 641
- multiplicative ..... 640
- orthogonality ..... 642
- periodic ..... 642
- Ramanujan's sum ..... 642
- tables ..... 649
- numerical differentiation
  - ..... *see* differentiation, numerical.
- oblate spheroidal coordinates ..... 705
  - Laplacian ..... 706
  - metric coefficients ..... 705
- Olver's algorithm
  - difference equations ..... 86–87
- Olver's associated Legendre function ..... 354, 375
- Olver's confluent hypergeometric function ..... 322
- Olver's hypergeometric function ..... 353, 384
- OP's ..... *see* orthogonal polynomials.
- open disks around infinity ..... 16
- open point set ..... 11, 15
- optical diffraction
  - Struve functions ..... 298
- optics
  - canonical integrals ..... 791
- Orr–Sommerfeld equation
  - Airy functions ..... 209
- orthogonal matrix polynomials ..... 477
- orthogonal polynomials
  - complex ..... 83
  - Painlevé transcendents ..... 739
  - relations to confluent hypergeometric functions
    - ..... 328, 338
  - relations to hypergeometric function ..... 393–394
- orthogonal polynomials associated with root systems
  - ..... 478
- orthogonal polynomials on the triangle ..... 478
- orthogonal polynomials on the unit circle
  - ..... *see* polynomials orthogonal on the unit circle.
- orthogonal polynomials with Freud weights ..... 475
- oscillations of chains
  - Bessel functions ..... 275
- oscillations of plates
  - Bessel functions ..... 276
- $\wp$ -function ..... *see* Weierstrass elliptic functions.

- packing analysis
  - incomplete beta functions . . . . . 189
- Padé approximations . . . . . 98–99
  - computation of coefficients . . . . . 98
  - convergence . . . . . 98
  - Padé table . . . . . 98
- Painlevé equations . . . . . **724**
  - . . . . . *see also* Painlevé transcendents.
  - affine Weyl groups . . . . . 732
  - alternative forms . . . . . 724
  - Bäcklund transformations . . . . . 730–732
  - coalescence cascade . . . . . 725
  - compatibility conditions . . . . . 728–729
  - elementary solutions . . . . . 732–735
  - elliptic form . . . . . 725
  - graphs of solutions . . . . . 726–728
  - Hamiltonian structure . . . . . 729–730
  - interrelations . . . . . 730–732
  - isomonodromy problems . . . . . 728
    - compatibility condition . . . . . 728
  - Lax pair . . . . . 728
  - rational solutions . . . . . 732–734
  - renormalizations . . . . . 724
  - special function solutions . . . . . 735–736
    - Airy functions . . . . . 735
    - Bessel functions . . . . . 735
    - Hermite polynomials . . . . . 735
    - hypergeometric function . . . . . 399, 736
    - parabolic cylinder functions . . . . . 735
    - Whittaker functions . . . . . 736
  - symmetric forms . . . . . 725
- Painlevé property . . . . . 724
  - applications . . . . . 739
- Painlevé transcendents . . . . . **724**
  - . . . . . *see also* Painlevé equations.
  - applications . . . . . 738
    - Boussinesq equation . . . . . 739
    - combinatorics . . . . . 739
    - enumerative topology . . . . . 739
    - integrable continuous dynamical systems . . . . . 739
    - integral equations . . . . . 729
    - Ising model . . . . . 739
    - Korteweg–de Vries equation . . . . . 738
    - modified Korteweg–de Vries equation . . . . . 738
    - orthogonal polynomials . . . . . 739
    - partial differential equations . . . . . 738–739
    - quantum gravity . . . . . 739
    - sine-Gordon equation . . . . . 739
    - statistical physics . . . . . 739
    - string theory . . . . . 739
  - asymptotic approximations . . . . . 736–738
    - complex variables . . . . . 738
    - real variables . . . . . 736–738
  - Bäcklund transformations . . . . . 730–732
  - computation . . . . . 740
  - differential equations for . . . . . 724
  - graphs . . . . . 726–728
  - Hamiltonians . . . . . 729–730
  - Lax pair . . . . . 728
  - notation . . . . . 724, 730–732
- parabolic cylinder functions . . . . . **304, 314**
  - addition theorems . . . . . 313
  - applications
    - mathematical . . . . . 317
    - physical . . . . . 317
  - approximations . . . . . 318
  - asymptotic expansions for large parameter . . *see* uniform asymptotic expansions for large parameter.
  - asymptotic expansions for large variable . . . 309, 315
    - exponentially-improved . . . . . 309, 317
  - computation . . . . . 318
  - connection formulas . . . . . 304, 315
  - continued fraction . . . . . 308
  - definitions . . . . . 304, 305, 314
  - derivatives . . . . . 309
  - differential equations . . . . . 304
    - numerically satisfactory solutions . . . . . 304, 314
    - standard solutions . . . . . 304
  - envelope functions . . . . . 367
  - expansions in Chebyshev series . . . . . 318
  - generalized . . . . . 317
  - graphics
    - complex variables . . . . . 306
    - real variables . . . . . 305–306, 314
  - Hermite polynomial case . . . . . 304, 308
  - integral representations
    - along the real line . . . . . 307, 315
    - compendia . . . . . 308
    - contour integrals . . . . . 307
    - Mellin–Barnes type . . . . . 308
  - integral transforms . . . . . 317
  - integrals . . . . . 313
    - asymptotic methods . . . . . 317
    - compendia . . . . . 313
    - Nicholson-type . . . . . 313
  - modulus and phase functions . . . . . 305, 316
  - notation . . . . . 304
  - orthogonality . . . . . 317
  - power-series expansions . . . . . 307, 315
  - recurrence relations . . . . . 309
  - reflection formulas . . . . . 304
  - relations to other functions
    - Bessel functions . . . . . 228, 315
    - confluent hypergeometric functions
      - . . . . . 308, 315, 328, 338
    - error and related functions . . . . . 308
    - Hermite polynomials . . . . . 308
    - modified Bessel functions . . . . . 255, 308

- probability functions.....308
- repeated integrals of the complementary error function ..... 167
- sums.....313
- tables.....318
- uniform asymptotic expansions for large parameter ..... 309–312, 315–316
  - double asymptotic property.....311
  - in terms of Airy functions.....311–312, 316
  - in terms of elementary functions.....310–311, 316
  - modified expansions in terms of Airy functions ..... 312
  - modified expansions in terms of elementary functions ..... 311
- values at  $z = 0$ ..... 304, 314
- Wronskians ..... 304, 314
- zeros
  - asymptotic expansions for large parameter .... 313
  - asymptotic expansions for large variable.. 312, 317
  - distribution.....312
- paraboloidal coordinates
  - wave equation ..... 346
  - Whittaker–Hill equation ..... 678
- paraboloidal wave functions ..... 677
  - asymptotic behavior for large variable.....677
  - orthogonality properties.....677
  - reflection properties.....677
- parallelepiped
  - volume.....10
- parallelogram
  - area.....10
- parametrization of algebraic equations
  - Jacobian elliptic functions.....563
- parametrized surfaces
  - area.....11
  - integral over ..... 12
  - of revolution ..... 12
  - orientation.....12
  - smooth ..... 11
  - sphere ..... 11
  - tangent vector ..... 11
- paraxial wave equation ..... 788
- Parseval’s formula
  - Fourier cosine and sine transforms.....28
  - Fourier series.....14
  - Fourier transform.....27
- Parseval-type formulas
  - Mellin transform ..... 29, 49
- partial derivative ..... 7
- partial differential equations
  - nonlinear
    - Weierstrass elliptic functions .....582
  - Painlevé transcendents.....738
  - spectral methods.....479
- partial differentiation.....7
- partial fractions ..... 2
  - ..... *see also* infinite partial fractions.
- particle scattering
  - Coulomb functions.....753
- partition ..... *see* partition function.
- partition function
  - asymptotic expansion.....646
  - calculation.....646
  - divisibility ..... 646
  - generating function ..... 646
  - hadronic matter.....146
  - parts.....645
  - Ramanujan congruences.....646
  - unrestricted.....645
- partitional shifted factorial ..... 769
- partitions.....618–620, 624–631, 769
  - applications.....635
  - compositions.....628
  - conjugate ..... 626
  - definition ..... 618
  - of a set ..... 618–620, 624–626
  - of integers ..... 618, 626–628
  - parts.....618
  - plane.....*see* plane partitions.
  - restricted.....*see* restricted integer partitions.
  - tables ..... 619, 629, 635
  - weight of.....769
- path
  - integrals of vector-valued functions ..... 11
  - length ..... 11
- PCFs.....*see* parabolic cylinder functions.
- Pearcey integral ..... 777
  - asymptotic approximations.....789–790
  - convergent series.....787
  - definition ..... 777
  - differential equation.....788
  - formula for Stokes set.....783
  - integral identities ..... 787
  - picture of Stokes set ..... 784
  - pictures of modulus.....778
  - pictures of phase.....780
  - scaling laws.....785
  - zeros.....785
    - table ..... 786
- pendulum
  - amplitude (am) function ..... 564
  - Jacobian elliptic functions.....564
  - Mathieu functions.....679
- pentagonal numbers
  - number theory.....646
- periodic Bernoulli functions ..... 588
- periodic Euler functions.....588
- periodic zeta function

- relation to Hurwitz zeta function ..... 612
- relation to polylogarithms ..... 612
- permutations ..... 618, 631–634
  - adjacent transposition ..... 631
  - cycle notation ..... 631
  - definition ..... 618
  - derangement ..... 631
  - derangement number ..... 631
  - descent ..... 632
  - even or odd ..... 631
  - excedance ..... 632
    - weak ..... 632
  - fixed points ..... 631
  - generating function ..... 632
  - greater index ..... 632
  - identities ..... 632
  - inversion numbers ..... 631–634
  - major index ..... 632, 634
  - matrix notation ..... 633
  - multiset ..... 634
  - order notation ..... 632
  - restricted position ..... 633
  - sign ..... 631, 633
  - special values ..... 633
  - transpositions ..... 631
  - twelvefold way ..... 634
- Pfaff–Saalschutz formula
  - ${}_3F_2$  functions of matrix argument ..... 772
- phase principle ..... 20, 92
- photon scattering
  - hypergeometric function ..... 400
- pi
  - computation to high precision via elliptic integrals ..... 516
- Picard’s theorem ..... 19
- Picard–Fuchs equations
  - generalized hypergeometric functions ..... 417
- piecewise continuous ..... 4
- piecewise differentiable curve ..... 11
- pion-nucleon scattering
  - Coulomb functions ..... 754
- pionic atoms
  - Coulomb functions ..... 754
- plane algebraic curves ..... *see* algebraic curves.
- plane curves
  - elliptic integrals ..... 514–515
  - Jacobian elliptic functions ..... 563
- plane partitions
  - applications ..... 635
  - complementary ..... 630
  - definitions ..... 629
  - descending ..... 630
  - generating functions ..... 630
  - limiting form ..... 631
- recurrence relation ..... 631
- strict shifted ..... 630
- symmetric ..... 629
- table ..... 629
- plane polar coordinates ..... *see* polar coordinates.
- plasma dispersion function ..... 169
- plasma waves
  - error functions ..... 169
- plasmas
  - hypergeometric function ..... 400
- Pochhammer double-loop contour ..... 326, 389, 714
- Pochhammer’s integral
  - beta function ..... 142
  - Heun functions ..... 714
- Pochhammer’s symbol ..... 136
- point sets in complex plane
  - closed ..... 15
  - closure ..... 15
  - compact ..... 18
  - connected ..... 15
  - domain ..... 15
    - exterior ..... 16
    - interior ..... 16
  - open ..... 15
  - region ..... 15
- points in complex plane
  - accumulation ..... 15
  - at infinity ..... 16
  - boundary ..... 15
  - interior ..... 15
  - limit (or limiting) ..... 15
- Poisson identity
  - discrete analog ..... 532
    - Gauss sum ..... 532
- Poisson integral ..... 16, 34
  - conjugate ..... 34
  - harmonic functions ..... 16
- Poisson kernel ..... 33
  - Fourier integral ..... 34
  - Fourier series ..... 33
- Poisson’s equation
  - in channel-like geometries ..... 379
- Poisson’s integral
  - Bessel functions ..... 224
- Poisson’s summation formula
  - Fourier series ..... 14
- polar coordinates ..... 7
- polar representation
  - complex numbers ..... 14
- pole ..... 19
  - movable ..... 724
  - multiplicity ..... 19
  - order ..... 19
- Pollaczek polynomials ..... 476

- definition ..... 476
- expansions in series of ..... 477
- orthogonality properties ..... 477
- relation to hypergeometric function ..... 476
- relations to other orthogonal polynomials ..... 477
- polygamma functions ..... **144**
  - computation ..... 146
  - continued fractions ..... 144
  - definition ..... 144
  - properties ..... 144
  - special values ..... 144
  - sums ..... 144
  - tables ..... 146
- polylogarithms ..... **611**
  - analytic properties ..... 611
  - computation ..... 614
  - definitions ..... 611
  - integral representations ..... 611
  - relations to other functions
    - Fermi–Dirac integrals ..... 612
    - Lerch’s transcendent ..... 612
    - periodic zeta function ..... 612
    - Riemann zeta function ..... 611
  - series expansions ..... 611
  - tables ..... 614
- polynomials
  - characteristic ..... 74
  - deflation ..... 91
  - discriminant ..... 22
  - monic ..... 22, 80
  - nodal ..... 75
  - stable ..... *see* stable polynomials.
  - Wilkinson’s ..... 92
  - zeros ..... *see* zeros of polynomials.
  - zonal ..... *see* zonal polynomials.
- polynomials orthogonal on the unit circle ..... 475–476
  - biorthogonal ..... 476
  - connection with orthogonal polynomials on the line
    - ..... 475
  - definition ..... 475
  - recurrence relations ..... 475
  - special cases ..... 475
- population biology
  - incomplete gamma functions ..... 189
- poristic polygon constructions of Poncelet
  - Jacobian elliptic functions ..... 557
- positive definite
  - Taylor series ..... 8
- potential theory
  - conical functions ..... 379
  - symmetric elliptic integrals ..... 501, 516
- power function ..... **105**
  - analytic properties ..... 105
  - branch cut ..... 104
- definition ..... 105
- derivatives ..... 109
- general bases ..... 105
- general value ..... 105
- identities ..... 109
- limits ..... 107
- modulus ..... 105
- notation ..... 105
- phase ..... 105
- principal value ..... 105
- special values ..... 107
- power series
  - addition ..... 17
  - convergence ..... 17
    - circle of ..... 17
    - radius of ..... 17
  - differentiation ..... 18
  - multiplication ..... 17
  - of logarithms ..... 18
  - of powers ..... 18
  - of reciprocals ..... 18
  - subtraction ..... 17
- primality testing
  - Weierstrass elliptic functions ..... 582
- prime number theorem ..... 638, 643, 644
  - equivalent statement ..... 613
- prime numbers
  - applications ..... 647
  - asymptotic formula ..... 644
  - computation ..... 648–649
  - counting ..... 648
  - cryptology ..... 647
  - distribution ..... 613, 638
    - asymptotic estimate ..... 638
  - Euler–Fermat theorem ..... 638
  - in arithmetic progressions
    - Dirichlet’s theorem ..... 613, 643
  - Jacobi symbol ..... 642
  - largest known ..... 644
  - Legendre symbol ..... 642
  - Mersenne prime ..... 644, 648
  - prime number theorem ..... 638, 643, 644
  - quadratic reciprocity law ..... 642
  - relation to logarithmic integral ..... 155
  - tables ..... 639, 649
- primes ..... *see* prime numbers.
- primitive Dirichlet characters
  - relation to generalized Bernoulli polynomials ..... 597
- principal branches ..... *see* principal values.
- principal values ..... 104
  - ..... *see also* Cauchy principal values.
  - closed definition ..... 104
- principle of the argument ..... *see* phase principle.
- Pringsheim’s theorem for continued fractions ..... 25



- probability distribution
  - symmetric elliptic integrals.....515
- probability functions.....160, 167, 308
  - Gaussian.....160
  - normal.....160
  - relations to other functions
    - error functions.....160
    - parabolic cylinder functions.....308
    - repeated integrals of the complementary error function.....167, 308
- problème des ménages.....633
- projective coordinates.....581
- projective quantum numbers
  - $3j$  symbols.....758
- prolate spheroidal coordinates.....704
  - Laplacian.....705
  - metric coefficients.....704
- Prym's functions.....174
- pseudoperiodic solutions
  - of Hill's equation.....674
  - of Mathieu's equation.....653, 664
- pseudoprime test.....644
- pseudorandom numbers.....648
- psi function.....136
  - analytic properties.....136
  - applications
    - mathematical.....145
  - approximations
    - Chebyshev series.....147
    - complex variable.....147
    - rational.....146, 147
  - asymptotic expansion.....140
  - computation.....146
  - continued fractions.....140
  - definition.....136
  - expansions in partial fractions.....139
  - graphics.....136, 137
  - inequalities.....138
  - integral representations.....140
  - multiplication formula.....138
  - notation.....136
  - recurrence relation.....138
  - reflection formula.....138
  - relation to hypergeometric function.....387
  - special values.....137
  - tables.....146
  - Taylor series.....139
  - zeros.....136
    - asymptotic approximation.....138
    - table of.....138
- public key codes.....647
- punctured neighborhood.....19
- $q$ -beta function.....145
- $q$ -factorials.....145
- $q$ -gamma function.....145
- $q$ -Appell functions.....423
  - transformations.....430
- $q$ -Bernoulli polynomials.....422
- $q$ -binomial coefficient.....421, 627
- $q$ -binomial series.....423
- $q$ -binomial theorem.....421, 424
- $q$ -calculus.....420–422
- $q$ -cosine function.....422
- $q$ -derivatives.....421
- $q$ -differential equations.....425
- $q$ -Dyson conjecture.....431
- $q$ -elementary functions.....422, 432
- $q$ -Euler numbers.....422
- $q$ -exponential function.....422
  - applications.....432
- $q$ -hypergeometric function.....420
  - Andrews–Askey sum.....424, 426
  - Andrews'  $q$ -Dyson conjecture.....431
  - applications
    - mathematical.....432
    - physical.....432
- Bailey chain.....430
- Bailey lemma
  - strong.....430
  - weak.....430
- Bailey pairs.....430
- Bailey transform.....430
- Bailey's  ${}_2F_1(-1)$  sum
  - $q$ -analog.....426
- Bailey's  ${}_4F_3(1)$  sum
  - $q$ -analogs (first and second).....427
- Bailey's transformation of very-well-poised  ${}_8\phi_7$ .....429
- Bailey–Daum  $q$ -Kummer sum.....424
- balanced series.....423
- bibasic sums and series.....429
- bilateral.... *see* bilateral  $q$ -hypergeometric function.
- Cauchy's sum.....424
- Chu–Vandermonde sums (first and second)
  - $q$ -analogs.....424
- computation.....432
- constant term identities.....431
- contiguous relations (Heine's).....425
- continued fractions.....426
- definition.....423
- differential equations.....425
- Dixon's  ${}_3F_2(1)$  sum
  - $q$ -analog.....426
- Dixon's sum
  - F. H. Jackson's  $q$ -analog.....426
- Dougall's  ${}_7F_6(1)$  sum
  - F. H. Jackson's  $q$ -analog.....427
- Euler's sums (first, second, third).....423, 424
- F. H. Jackson's transformations.....428

- Fine's transformations (first, second, third) . . . . . 424
- Gauss's  ${}_2F_1(-1)$  sum  
 $q$ -analog . . . . . 426
- generalizations . . . . . 432
- Heine's transformations (first, second, third) . . . . 424
- idem function . . . . . 420, 429
- integral representations . . . . . 426
- integrals . . . . . 431
- $k$ -balanced series . . . . . 423
- mixed base Heine-type transformations . . . . . 429
- nearly-poised . . . . . 423
- notation . . . . . 420
- $q$ -Pfaff–Saalschütz sum . . . . . 426
- $q$ -Saalschütz sum  
nonterminating form . . . . . 426
- $q$ -Sheppard identity . . . . . 428
- quintuple product identity . . . . . 427
- Ramanujan's integrals . . . . . 431
- relations to other functions  
Askey–Wilson class orthogonal polynomials  
. . . . . 472–474
- $q$ -Hahn class orthogonal polynomials . . . . 470–472
- Rogers–Fine identity . . . . . 424
- Saalschützian series . . . . . 423
- Sears' balanced  ${}_4\phi_3$  transformation . . . . . 428
- special cases . . . . . 426
- three-term  ${}_2\phi_1$  transformation . . . . . 425
- transformations . . . . . 428
- Vandermonde sum  
nonterminating  $q$ -version . . . . . 425
- very-well-poised . . . . . 423
- well-poised . . . . . 423
- Zeilberger–Bressoud theorem . . . . . 431
- $q$ -Hahn class orthogonal polynomials . . . . . 470–472
- as eigenvalues of  $q$ -difference operator . . . . . 470
- asymptotic approximations . . . . . 474
- orthogonality properties . . . . . 470
- relation to  $q$ -hypergeometric function . . . . . 470–472
- $q$ -Hahn polynomials . . . . . 470
- $q$ -hypergeometric orthogonal polynomials . . . . . 470
- $q$ -integrals . . . . . 422
- $q$ -Laguerre polynomials . . . . . 471
- applications . . . . . 432
- asymptotic approximations to zeros . . . . . 474
- $q$ -Leibniz rule . . . . . 421
- $q$ -multinomial coefficient . . . . . 634
- $q$ -Pochhammer symbol . . . . . 436
- $q$ -product . . . . . 436
- $q$ -Racah polynomials . . . . . 474
- applications  
coding theory . . . . . 479
- relation to  $q$ -hypergeometric function . . . . . 474
- $q$ -series  
classification . . . . . 423
- $q$ -sine function . . . . . 422
- $q$ -Stirling numbers . . . . . 422
- $q^{-1}$ -Al-Salam–Chihara polynomials . . . . . 473
- quadratic characters  
number theory . . . . . 642
- quadratic equations . . . . . 23
- quadratic reciprocity law  
number theory . . . . . 642
- quadrature . . . . . 78–84
- contour integrals . . . . . 83–84
- interpolatory rules (or formulas)  
. . . . . *see also* Gauss quadrature.  
Clenshaw–Curtis . . . . . 79
- closed . . . . . 79
- error term . . . . . 79
- Fejér's . . . . . 79
- midpoint . . . . . 79
- Newton–Cotes . . . . . 79
- nodes . . . . . 79
- open . . . . . 79
- weight function . . . . . 79
- oscillatory integrals  
Clenshaw–Curtis formula (extended) . . . . . 82
- Filon's rule . . . . . 82
- Longman's method . . . . . 82
- multidimensional . . . . . 82
- Romberg integration . . . . . 79
- Simpson's rule  
composite . . . . . 78, 79
- elementary . . . . . 79
- steepest-descent paths . . . . . 83–84
- trapezoidal rule  
composite . . . . . 78, 79, 84
- elementary . . . . . 78, 79
- improved . . . . . 78
- via classical orthogonal polynomials . . . . . 478
- quantum chemistry  
generalized exponential integral . . . . . 190
- incomplete gamma functions . . . . . 189
- quantum chromo-dynamics  
hypergeometric function . . . . . 400
- quantum field theory  
modular functions . . . . . 582
- Riemann zeta function . . . . . 614
- quantum gravity  
Painlevé transcendents . . . . . 739
- quantum groups  
 $q$ -series . . . . . 432
- quantum mechanics  
associated Legendre functions . . . . . 379
- canonical integrals . . . . . 791
- classical orthogonal polynomials . . . . . 479
- Heun functions . . . . . 720
- Mathieu functions . . . . . 679

- nonrelativistic
  - gamma function ..... 145
  - parabolic cylinder functions ..... 317
  - Struve functions ..... 298
  - Whittaker functions ..... 346
- quantum probability distributions
  - Euler polynomials ..... 598
- quantum scattering
  - hypergeometric function ..... 400
- quantum spin models
  - Painlevé transcendents ..... 739
- quantum spins
  - Heun's equation ..... 720
- quantum systems
  - Heun's equation ..... 720
- quantum wave-packets
  - theta functions ..... 534
- quark-gluon plasma
  - Bernoulli polynomials ..... 598
- quartic equations ..... 23
- quartic oscillator
  - Jacobian elliptic functions ..... 565
- quasiconformal mapping
  - complete elliptic integrals ..... 399
  - hypergeometric function ..... 399
- queueing theory
  - incomplete gamma functions ..... 189
- quintic equations
  - modular functions ..... 582
- quotient-difference algorithm ..... 95
  - rhombus rule ..... 95
  - stability ..... 95
- quotient-difference scheme ..... 95
- Raabe's theorem
  - Bernoulli polynomials ..... 590
- Racah polynomials ..... 407
  - ..... *see* Wilson class orthogonal polynomials.
- radial Mathieu functions ..... 668
  - ..... *see also* modified Mathieu functions.
  - definitions ..... 668
  - expansions in series of Bessel functions ..... 670
  - expansions in series of cross-products of Bessel functions and modified Bessel functions ..... 671–672
  - graphics ..... 669
  - integral representations ..... 672–674
    - compensia ..... 674
    - of cross-products ..... 674
  - joining factors ..... 652, 669
  - notation ..... 652
  - relation to modified Mathieu functions ..... 668
  - shift of variable ..... 668
- radial spheroidal wave functions ..... 703
  - applications ..... 706
  - asymptotic behavior for large variable ..... 703
  - computation ..... 708
  - connection formulas ..... 703
  - connection with spheroidal wave functions ..... 704
  - definitions ..... 703
  - graphics ..... 703
  - integral representation ..... 704
  - tables ..... 708
  - Wronskian ..... 703
- radiative equilibrium
  - generalized exponential integral ..... 190
- Radon transform
  - classical orthogonal polynomials ..... 479
- railroad track design
  - Cornu's spiral ..... 169
- rainbow
  - Airy functions ..... 209
- Ramanujan's  ${}_1\psi_1$  summation
  - bilateral  $q$ -hypergeometric function ..... 427
- Ramanujan's beta integral ..... 143
- Ramanujan's cubic transformation
  - hypergeometric function ..... 393
- Ramanujan's partition identity
  - number theory ..... 646
- Ramanujan's sum
  - number theory ..... 643
- Ramanujan's tau function
  - number theory ..... 646–647
- random graphs
  - generalized hypergeometric functions ..... 417
- random matrix theory
  - Hermite polynomials ..... 479
  - Painlevé transcendents ..... 739
- random walks ..... 417
- rational arithmetics ..... 72
  - exact ..... 72
- rational functions
  - summation ..... 145
- Rayleigh function ..... 240
  - applications ..... 276
- $R_C$ -function ..... 487
  - asymptotic approximations ..... 496
  - limiting values ..... 491
  - relation to elementary functions ..... 495
  - relation to Gudermannian function ..... 495
  - relation to inverse Gudermannian function ..... 491
  - special values ..... 491
- reduced Planck's constant ..... 379, 479, 753
- reduced residue system
  - number theory ..... 638
- reductions of partial differential equations
  - Painlevé transcendents ..... 738
- Regge poles
  - Coulomb functions ..... 754
- Regge symmetries

- 6j symbols ..... 762
- 3j symbols ..... 759
- region ..... 15
- regularization
  - distributional methods ..... 55
- relative error ..... 73
- relative precision ..... 73
- relativistic Coulomb equations ..... 754
- relaxation times for proteins
  - incomplete gamma functions ..... 189
- Remez's second algorithm
  - minimax rational approximations ..... 98
- removable singularity ..... 19
- repeated integrals of the complementary error function
  - ..... 167
  - applications ..... 169
  - asymptotic expansions ..... 167
  - computation ..... 169
  - continued fractions ..... 167
  - definition ..... 167
  - derivatives ..... 167
  - differential equation ..... 167
  - graphics ..... 167
  - power-series expansion ..... 167
  - recurrence relations ..... 167
  - relations to other functions
    - confluent hypergeometric functions ..... 167
    - Hermite polynomials ..... 167
    - parabolic cylinder functions ..... 167, 308
    - probability functions ..... 167, 308
  - scaled ..... 167
  - tables ..... 169
- representation theory
  - partitions ..... 635
- repulsive potentials
  - Coulomb functions ..... 753, 754
- residue ..... 19
  - theorem ..... 19
- resistive MHD instability theory
  - Struve functions ..... 298
- resolvent cubic equation ..... 23
- resonances
  - Coulomb functions ..... 754
- restricted integer partitions
  - Bessel-function expansion ..... 628
  - conjugate ..... 626
  - generating functions ..... 627
  - identities ..... 628
  - limiting form ..... 627, 628
  - notation ..... 626, 627
  - recurrence relations ..... 627, 628
  - relation to lattice paths ..... 626
  - tables ..... 626, 627
- resurgence
  - asymptotic solutions of differential equations ..... 57
  - reversion of series ..... 43
- Riccati–Bessel functions ..... 240
  - zeros ..... 240
- Riemann hypothesis ..... 606
  - equivalent statements ..... 613, 614, 644
- Riemann identity
  - Riemann theta functions ..... 542
  - Riemann theta functions with characteristics ..... 542
- Riemann matrix ..... 538
  - computation ..... 546
- Riemann surface ..... **543**
  - connection with Riemann theta functions ..... 543, 546
  - cycles ..... 543
  - definition ..... 543
  - genus ..... 543
  - handle ..... 543
  - holomorphic differentials ..... 543
  - hyperelliptic ..... 544
  - intersection indices ..... 538, 543
  - prime form ..... 544
  - representation via Hurwitz system ..... 546
  - representation via plane algebraic curve ..... 546
  - representation via Schottky group ..... 546
- Riemann theta functions ..... **538**
  - analytic properties ..... 538
  - applications ..... 543–546
  - components ..... 538
  - computation ..... 546
  - definition ..... 538
  - dimension ..... 538
  - genus ..... 538
  - graphics ..... 539–541
  - modular group ..... 542
  - modular transformations ..... 541–542
  - notation ..... 538
  - period lattice ..... 539
  - products ..... 542
  - quasi-periodicity ..... 539
  - relation to classical theta functions ..... 539
  - Riemann identity ..... 542
  - scaled ..... 538, 546
  - symmetry ..... 539
- Riemann theta functions with characteristics ..... **539**
  - addition formulas ..... 543
  - applications
    - Abelian functions ..... 545
  - characteristics ..... 539
    - half-period ..... 539
  - modular transformations ..... 542
  - notation ..... 538
  - quasi-periodicity ..... 539
  - Riemann identity ..... 542
  - symmetry ..... 539

- Riemann zeta function ..... **602**  
analytic properties ..... 602  
applications  
  mathematical ..... 613  
  physical ..... 614  
approximations ..... 615  
  asymptotic ..... 606  
Chebyshev series ..... 615  
computation ..... 614  
connection with incomplete gamma functions... 189  
critical line ..... 606  
critical strip ..... 606  
definition ..... 602  
derivatives ..... 602  
  integer arguments ..... 605  
  series expansions ..... 602  
Euler-product representation ..... 640  
graphics ..... 603  
incomplete ..... 189  
infinite products ..... 602  
integer argument ..... 605  
integral representations  
  along the real line ..... 604  
  contour integrals ..... 605  
integrals ..... 606  
notation ..... 602  
recursion formulas ..... 605  
reflection formulas ..... 603  
relations to other functions  
  Bernoulli and Euler numbers and polynomials  
    ..... 598, 605  
  Hurwitz zeta function ..... 607  
  polylogarithms ..... 611  
representations by Euler–Maclaurin formula .... 602  
series expansions ..... 602  
sums ..... 606  
tables ..... 614  
zeros  
  computation ..... 614  
  counting ..... 607, 614  
  distribution ..... 606  
  on critical line or strip ..... 606, 614  
  relation to quantum eigenvalues ..... 614  
  Riemann hypothesis ..... 606  
  trivial ..... 606  
Riemann’s  $\xi$ -function ..... 603  
approximations ..... 615  
Riemann’s differential equation  
  general form ..... 396  
  reduction to hypergeometric differential equation  
    ..... 396  
  singularities ..... 396  
  solutions  
    *P*-symbol notation ..... 396  
    transformations ..... 396  
Riemann–Hilbert problems  
  classical orthogonal polynomials ..... 479  
Riemann–Lebesgue lemma ..... 14  
Riemann–Siegel formula ..... 607  
  coefficients ..... 614  
Riemann’s *P*-symbol ..... 396  
ring functions ..... *see* toroidal functions.  
Ritt’s theorem  
  differentiation of asymptotic approximations .... 42  
robot trajectory planning  
  Cornu’s spiral ..... 169  
Rodrigues formulas  
  classical orthogonal polynomials ..... 442  
  Hahn class orthogonal polynomials ..... 462  
Rogers polynomials  
  ..... *see* continuous *q*-ultraspherical polynomials.  
Rogers–Ramanujan identities ..... 422, 430  
  constant term ..... 431  
  partitions ..... 628  
Rogers–Szegő polynomials ..... 475  
rolling of ships  
  Mathieu functions ..... 679  
rook polynomial ..... 633  
roots  
  of equations ..... 90  
Rossby waves  
  biconfluent Heun functions ..... 720  
rotation matrices  
  relation to  $3j$  symbols ..... 761  
Rouché’s theorem ..... 20, 92  
round-robin tournaments ..... 648  
Runge–Kutta methods  
  ordinary differential equations ..... 89–90  
Rutherford scattering  
  Coulomb functions ..... 753  
  gamma function ..... 145  
Rydberg constant  
  Coulomb functions ..... 754  
*S*-matrix scattering  
  Coulomb functions ..... 754  
saddle points ..... 47  
  coalescing ..... 48, 789–790  
sampling expansions  
  parabolic cylinder functions ..... 317  
scaled gamma function ..... 185  
scaled Riemann theta functions  
  computation ..... 546  
  definition ..... 538  
scaled spheroidal wave functions ..... 706–707  
  bandlimited ..... 706  
  extremal properties ..... 707  
  Fourier transform ..... 706  
  integral equation ..... 706

- orthogonality ..... 706
- scaling laws
  - for diffraction catastrophes ..... 785
- scattering problems
  - associated Legendre functions ..... 379
  - Coulomb functions ..... 753–755
- scattering theory
  - Mathieu functions ..... 679
- Schläfli's integrals
  - Bessel functions ..... 224, 225
- Schläfli–Sommerfeld integrals
  - Bessel and Hankel functions ..... 224
- Schläfli-type integrals
  - Kelvin functions ..... 269
- Schottky group
  - Riemann surface ..... 546
- Schottky problem
  - Riemann surface ..... 545
- Schröder numbers
  - definition ..... 622
  - generating function ..... 623
  - relation to lattice paths ..... 622
  - table ..... 622
- Schrödinger equation
  - Airy functions ..... 209
  - Coulomb functions ..... 753–755
  - nonlinear
    - Jacobian elliptic functions ..... 565
    - Riemann theta functions ..... 545
  - $q$ -deformed quantum mechanical ..... 432
  - solutions in terms of classical orthogonal polynomials
    - theta functions ..... 534
- Schwarz reflection principle ..... 19
- Schwarz's lemma ..... 20
- Schwarzian derivative ..... 27
- Scorer functions ..... 204
  - analytic properties ..... 204
  - applications ..... 209
  - approximations
    - expansions in Chebyshev series ..... 212
  - asymptotic expansions ..... 205
  - computation ..... 210
  - computation by quadrature ..... 84
  - connection formulas ..... 205
  - definition ..... 204
  - differential equation ..... 204
    - initial values ..... 204
    - numerically satisfactory solutions ..... 204
    - standard solutions ..... 204
  - graphs ..... 204
  - integral representations ..... 204–205
  - integrals
    - asymptotic expansions ..... 206
    - tables ..... 211
- Maclaurin series ..... 205
- notation ..... 194
- tables ..... 211
- zeros ..... 206
  - computation ..... 210
  - tables ..... 211
- secant function ..... *see* trigonometric functions.
- sectorial harmonics ..... 378
- Selberg integrals
  - generalized elliptic integrals ..... 516
- Selberg-type integrals
  - gamma function ..... 143
- separable Gauss sum
  - number theory ..... 643
- Shanks' transformation
  - for sequences ..... 93
- ship wave ..... 790–791
- sieve of Eratosthenes
  - prime numbers ..... 648
- sigma function ..... *see* Weierstrass elliptic functions.
- signal analysis
  - spheroidal wave functions ..... 706–707
- simple closed contour ..... 16
- simple closed curve ..... 11
- simple discontinuity ..... 4
- simple zero ..... 19
- simply-connected domain ..... 25
- Sinc function ..... 77
- sine function ..... *see* trigonometric functions.
- sine integrals ..... 150
  - applications
    - Gibbs phenomenon ..... 154
    - physical ..... 155
  - approximations ..... 156
  - asymptotic expansions ..... 153
  - exponentially-improved ..... 154
  - auxiliary functions ... *see* auxiliary functions for sine and cosine integrals.
  - Chebyshev-series expansions ..... 156–157
  - computation ..... 155
  - definition ..... 150
  - expansion in spherical Bessel functions ..... 153
  - generalized ..... 188–189
  - graphics ..... 151
  - hyperbolic analog ..... 150
  - integral representations ..... 152
  - integrals ..... 154
  - Laplace transform ..... 154
  - maxima and minima ..... 155
  - notation ..... 150
  - power series ..... 151
  - relations to exponential integrals ..... 151
  - sums ..... 154

- tables.....156
- value at infinity.....150
- zeros.....154
  - asymptotic expansion.....154
  - computation.....156
- sine-Gordon equation
  - Jacobian elliptic functions.....565
  - Painlevé transcendents.....739
- singularities
  - movable.....724
- singularity
  - branch point.....20
  - essential.....19
  - isolated.....19
  - isolated essential.....19
  - pole.....19
  - removable.....4, 19
- $6j$  symbols.....761
  - addition theorem.....763
  - applications.....765
  - approximations for large parameters.....764
  - computation.....765
  - definition.....761
    - alternative.....763
  - generating functions.....763
  - graphical method.....765
  - notation.....758
  - orthogonality.....763
  - recursion relations.....762
  - Regge symmetries.....762
  - representation as
    - finite sum of algebraic quantities.....762
    - finite sum of  $3j$  symbols.....761
    - generalized hypergeometric functions.....761
  - special cases.....762
  - sum rules.....763
  - summation convention.....760
  - sums.....763
  - symmetry.....762
  - tables.....765
  - zeros.....765
- $SL(2, \mathbb{Z})$  bilinear transformation.....579
- Sobolev polynomials.....477
- soliton theory
  - classical orthogonal polynomials.....478
- solitons
  - Jacobian elliptic functions.....565
  - Weierstrass elliptic functions.....582
- spatio-temporal dynamics
  - Heun functions.....718
- spectral problems
  - Heun's equation.....720
  - separation of variables.....720
- spherical Bessel functions.....262
  - addition theorems.....267
  - analytic properties.....262
  - applications
    - electromagnetic scattering.....276
    - Helmholtz equation.....276
    - wave equation.....276
  - approximations.....281
  - asymptotic approximations for large order.....see uniform asymptotic expansions for large order
  - computation.....276–277
  - continued fractions.....266
  - cross-products.....265
  - definitions.....262
  - derivatives.....265
    - zeros.....266, 280
  - differential equations.....262
    - numerically satisfactory solutions.....262
    - singularities.....262
    - standard solutions.....262
  - Dirac delta.....38
  - duplication formulas.....267
  - explicit formulas
    - modified functions.....264
    - sums or differences of squares.....264
    - unmodified functions.....264
  - generating functions.....266
  - graphs.....262
  - integral representations.....266
  - integrals.....267
    - computation.....278
  - interrelations.....262
  - limiting forms.....265
  - modified.....262
  - notation.....217
  - of the first, second, and third kinds.....262
  - power series.....265
  - Rayleigh's formulas.....264
  - recurrence relations.....265
  - reflection formulas.....262
  - sums.....267
    - addition theorems.....267
    - compensia.....267
    - duplication formulas.....267
    - tables.....280
    - uniform asymptotic expansions for large order...266
  - Wronskians.....265
  - zeros.....266
- spherical Bessel transform.....278
  - computation.....278
- spherical coordinates.....8
- spherical harmonics.....378
  - addition theorem.....379
  - applications.....379
  - basic properties.....378–379

- definitions ..... 378
- Dirac delta ..... 38
- distributional completeness ..... 379
- Lamé polynomials ..... 694
- relation to  $3j$  symbols ..... 760
- sums ..... 379
- zonal ..... 479
- spherical polar coordinates .. *see* spherical coordinates.
- spherical triangles
  - solution of ..... 131
- spherical trigonometry
  - Jacobian elliptic functions ..... 564
- sphero-conal coordinates ..... 693
- spheroidal coordinates ..... *see* oblate spheroidal coordinates *and* prolate spheroidal coordinates.
- spheroidal differential equation ..... **698**
  - eigenvalues ..... 698–699
    - asymptotic behavior ..... 702–703
    - computation ..... 707
    - continued-fraction equation ..... 699
    - graphics ..... 700
    - power-series expansion ..... 699
    - tables ..... 708
  - Liouville normal form ..... 698
  - singularities ..... 698
  - special cases ..... 698
  - with complex parameter ..... 700
- spheroidal harmonics
  - oblate ..... 378
  - prolate ..... 378
- spheroidal wave functions ..... **698**
  - addition theorem ..... 703
  - applications
    - signal analysis ..... 706–707
    - wave equation ..... 704–706
  - approximations ..... 703
  - as confluent Heun functions ..... 717
  - asymptotic behavior
    - as  $x \rightarrow \pm 1$  ..... 703
    - for large  $|\gamma^2|$  ..... 702–703
  - computation ..... 707–708
  - convolutions ..... 703
  - Coulomb ..... 704
  - definitions ..... 699, 700
  - differential equation ..... 698
  - eigenvalues ..... 698
  - elementary properties ..... 699
  - expansions in series of Ferrers functions ..... 702
    - asymptotic behavior of coefficients ..... 702
    - tables of coefficients ..... 708
  - expansions in series of spherical Bessel functions .. 703
  - Fourier transform ..... 706
  - generalized ..... 704
  - graphics ..... 700–701
  - integral equations ..... 703, 706
  - integrals ..... 703
  - notation ..... 698
  - oblate angular ..... 699
  - of complex argument ..... 700
  - of the first kind ..... 699
  - of the second kind ..... 700
  - orthogonality ..... 699
  - other notations ..... 698
  - power-series expansions ..... 699
  - products ..... 703
  - prolate angular ..... 699
  - radial ..... 703
  - scaled ..... 706
  - tables ..... 708
  - with complex parameters ..... 700
  - zeros ..... 699
- spline functions
  - Bernoulli monosplines ..... 597
  - cardinal monosplines ..... 597
  - cardinal splines ..... 597
  - Euler splines ..... 597
- splines
  - Bézier curves ..... 100
  - definitions ..... 100
- square-integrable function ..... 6
- stability problems
  - Mathieu functions ..... 679
- stable polynomials ..... 23
  - Hurwitz criterion ..... 23
- statistical analysis
  - multivariate
    - functions of matrix argument ..... 773
- statistical applications
  - functions of matrix argument ..... 773
- statistical mechanics
  - application to combinatorics ..... 635
  - Heun functions ..... 720
  - incomplete beta functions ..... 189
  - Jacobian elliptic functions ..... 564
  - modular functions ..... 582
  - $q$ -hypergeometric function ..... 432
  - solvable models ..... 146
  - theta functions ..... 533
- statistical physics
  - Bernoulli and Euler polynomials ..... 598
  - Painlevé transcendents ..... 739
- Steed's algorithm
  - for continued fractions ..... 96
- steepest-descent paths
  - numerical integration ..... 83–84
- Stickelberger codes
  - Bernoulli numbers ..... 598
- Stieltjes fraction ( $S$ -fraction) ..... 95



- Stieltjes polynomials  
 definition ..... 718  
 orthogonality ..... 719  
 products ..... 719  
 zeros ..... 718  
 electrostatic interpretation ..... 719
- Stieltjes transform  
 analyticity ..... 30  
 asymptotic expansions ..... 52–53  
 convergence ..... 29  
 definition ..... 29, 52  
 derivatives ..... 30  
 generalized ..... 53  
 inversion ..... 30  
 representation as double Laplace transform ..... 30
- Stieltjes–Wigert polynomials ..... 471  
 asymptotic approximations ..... 474
- Stirling cycle numbers ..... 631
- Stirling numbers (first and second kinds)  
 asymptotic approximations ..... 626  
 definitions ..... 624  
 generalized ..... 626  
 generating functions ..... 624  
 identities ..... 625  
 notations ..... 618  
 recurrence relations ..... 625  
 relations to Bernoulli numbers ..... 596  
 special values ..... 625  
 tables ..... 624, 635
- Stirling’s formula ..... 141
- Stirling’s series ..... 141
- Stokes line ..... 68
- Stokes multipliers ..... 57
- Stokes phenomenon ..... 67  
 complementary error function ..... 164  
 incomplete gamma functions ..... 189  
 smoothing of ..... 67
- Stokes sets ..... 782–785  
 cusps ..... 783  
 definitions ..... 782  
 umbilics ..... 783  
 visualizations ..... 784–785
- Stokes’ theorem for vector-valued functions ..... 12
- string theory  
 beta function ..... 146  
 elliptic integrals ..... 517  
 modular functions ..... 582  
 Painlevé transcendents ..... 739  
 Riemann theta functions ..... 545  
 theta functions ..... 533
- Struve functions ... *see* Struve functions and modified Struve functions.
- Struve functions and modified Struve functions ... **288**  
 analytic continuation ..... 291
- applications  
 physical ..... 298
- approximations ..... 300
- argument  $xe^{\pm 3\pi i/4}$  ..... 294
- asymptotic expansions  
 generalized ..... 293  
 large argument ..... 293  
 large order ..... 293  
 remainder terms ..... 293
- computation ..... 299
- definitions ..... 288
- derivatives ..... 292  
 with respect to order ..... 292
- differential equations ..... 288  
 numerically satisfactory solutions ..... 288  
 particular solutions ..... 288
- graphics ..... 289–291
- half-integer orders ..... 291
- incomplete ..... 300
- inequalities ..... 291
- integral representations  
 along real line ..... 292  
 compendia ..... 293  
 contour integrals ..... 292  
 Mellin–Barnes type ..... 293
- integrals  
 compendia ..... 294  
 definite ..... 294  
 indefinite ..... 293–294  
 Laplace transforms ..... 294  
 products ..... 294  
 tables ..... 299  
 with respect to order ..... 294
- Kelvin-function analogs ..... 294
- notation ..... 288
- order ..... 288
- power series ..... 288
- principal values ..... 288
- recurrence relations ..... 292
- relations to Anger–Weber functions ..... 297
- series expansions  
 Bessel functions ..... 292  
 Chebyshev ..... 300  
 power series ..... 288
- sums ..... 294
- tables ..... 299
- zeros ..... 292
- Struve’s equation ... *see* Struve functions and modified Struve functions, differential equations.
- Sturm–Liouville eigenvalue problems  
 ordinary differential equations ..... 89
- summability methods for integrals  
 Abel ..... 34  
 Cesàro ..... 34

- Fourier integrals
  - conjugate Poisson integral ..... 34
  - Fejér kernel ..... 34
  - Poisson integral ..... 34
  - Poisson kernel ..... 34
- fractional derivatives ..... 35
- fractional integrals ..... 35
- summability methods for series
  - Abel ..... 33
  - Borel ..... 33
  - Cesàro ..... 33
    - general ..... 33
  - convergence ..... 33
  - Fourier series
    - Abel means ..... 33
    - Cesàro means ..... 33
    - Fejér kernel ..... 33
    - Poisson kernel ..... 33
  - regular ..... 33
  - Tauberian theorems ..... 35
- summation by parts ..... 63
- summation formulas
  - Boole ..... 597
  - Euler–Maclaurin ..... 597
- sums of powers
  - as Bernoulli or Euler polynomials ..... 589
  - tables ..... 598
- supersonic flow
  - Lamé polynomials ..... 694
- support
  - of a function ..... 35
- surface ..... *see* parametrized surfaces.
- surface harmonics of the first kind ..... 378
- surface-wave problems
  - Struve functions ..... 298
- swallowtail bifurcation set
  - formula ..... 781
  - picture ..... 782
- swallowtail canonical integral ..... **776**
  - asymptotic approximations ..... 789–790
  - convergent series ..... 787
  - differential equations ..... 788
  - formulas for Stokes set ..... 783
  - integral identities ..... 787
  - picture of Stokes set ..... 784
  - pictures of modulus ..... 778
  - scaling laws ..... 785
  - zeros ..... 787
- swallowtail catastrophe ..... **776**, 784
- symmetric elliptic integrals ..... **497**
  - addition theorems ..... 509–510
  - advantages of symmetry ..... 497
  - applications
    - mathematical ..... 514–516
    - physical ..... 516–517
    - statistical ..... 515
  - arithmetic-geometric mean ..... 505
  - asymptotic approximations and expansions
    - ..... 53, 510–511
  - Bartky’s transformation ..... 504
  - change of parameter of  $R_J$  ..... 504
  - circular cases ..... 502–504
  - complete ..... 486
  - computation ..... 517–519
  - connection formulas ..... 503
  - degree ..... 498
  - derivatives ..... 500
  - differential equations ..... 501
  - duplication formulas ..... 510
  - elliptic cases of  $R_{-a}(\mathbf{b}; \mathbf{z})$  ..... 498
  - first, second, and third kinds ..... 486
  - Gauss transformations ..... 497, 505
  - general lemniscatic case ..... 502, 503
  - graphics ..... 499–500
  - hyperbolic cases ..... 502–504
  - inequalities
    - complete integrals ..... 506–507
    - incomplete integrals ..... 507
  - integral representations ..... 506
  - integrals of ..... 511
  - Landen transformations ..... 497, 505
  - notation ..... 486
  - permutation symmetry ..... 497, 498
  - power-series expansions ..... 501–502
  - reduction of general elliptic integrals ..... 512–514
  - relations to other functions
    - Appell functions ..... 509
    - Bulirsch’s elliptic integrals ..... 508
    - hypergeometric function ..... 509
    - Jacobian elliptic functions ..... 508
    - Lauricella’s function ..... 509
    - Legendre’s elliptic integrals ..... 507, 508
    - theta functions ..... 508
    - Weierstrass elliptic functions ..... 509
  - special cases ..... 502–503
  - tables ..... 519
  - transformations replaced by symmetry
    - ..... 497, 505, 508
- symmetries
  - of canonical integrals ..... 777
- Szegő–Askey polynomials ..... 475
- Szegő–Szász inequality
  - Jacobi polynomials ..... 451
- tangent function ..... *see* trigonometric functions.
- tangent numbers ..... 596
  - tables ..... 596
- Taylor series ..... 18
  - asymptotic approximations for coefficients ..... 65

- Taylor's theorem
  - one variable . . . . . 6, 18
  - two variables . . . . . 8
- tempered distributions . . . . . 36, 52
  - convergence . . . . . 36
  - Fourier transform . . . . . 37
- term-by-term integration . . . . . 18
- terminant function . . . . . 68
  - incomplete gamma functions . . . . . 189
- tesseral harmonics . . . . . 378
- test functions
  - distributions . . . . . 35
- Theorem of Ince
  - Mathieu's equation . . . . . 653, 657
- theta functions . . . . . 524
  - addition formulas . . . . . 531
  - applications
    - mathematical . . . . . 533
    - physical . . . . . 533
  - computation . . . . . 534
  - derivatives . . . . . 529–530
    - of ratios . . . . . 531
  - discrete analog . . . . . 532
  - double products . . . . . 530
  - duplication formula . . . . . 531
  - Fourier series . . . . . 524
  - fundamental parallelogram . . . . . 524
  - generalizations . . . . . 532
  - graphics
    - complex variables . . . . . 527–529
    - real variables . . . . . 525–527
  - infinite products . . . . . 529–530
  - integrals . . . . . 532
  - Jacobi's identity . . . . . 529
  - Jacobi's inversion formula . . . . . 532, 533
  - Jacobi's original notation . . . . . 524
  - Jacobi's triple product . . . . . 529
  - Landen transformation . . . . . 531
  - Laplace transform with respect to lattice parameter
    - . . . . . 532
  - lattice parameter . . . . . 524
    - transformation of . . . . . 531
  - lattice points . . . . . 524
  - limit forms as  $\Im\tau \rightarrow 0+$  . . . . . 534
  - McKean and Moll's . . . . . 524
  - Mellin transform with respect to lattice parameter
    - . . . . . 532
  - modular transformations . . . . . 531
  - multidimensional . . . . . *see* Chapter 21.
  - Neville's . . . . . 524, 550
  - nome . . . . . 524
    - rectangular case . . . . . 524
    - transformation of . . . . . 531
  - notation . . . . . 524
  - periodicity . . . . . 524
  - power series . . . . . 530
  - quasi-periodicity . . . . . 524
  - Ramanujan's . . . . . 533
  - Ramanujan's change of base . . . . . 533
  - rectangular case . . . . . 524
  - relations to other functions
    - Dedekind's eta function . . . . . 525
    - elliptic integrals . . . . . 532
    - elliptic modular function . . . . . 532
    - Jacobi's epsilon function . . . . . 562
    - Jacobian elliptic functions . . . . . 532, 550
    - modular functions . . . . . 579
    - Riemann zeta function . . . . . 532
    - symmetric elliptic integrals . . . . . 508
    - Weierstrass elliptic functions . . . . . 532, 574
  - Riemann . . . . . 538
  - Riemann with characteristics . . . . . 539
  - sums of squares . . . . . 530
  - tables . . . . . 534
  - translation by half-periods . . . . . 525
  - values at  $z = 0$  . . . . . 529
  - Watson's expansions . . . . . 531
  - Watson's identities . . . . . 531
  - with characteristics . . . . . 533
  - zeros . . . . . 525
- Thomae transformation
  - ${}_3F_2$  functions of matrix argument . . . . . 772
- $3j, 6j, 9j$  symbols
  - relation to generalized hypergeometric functions
    - . . . . . 407, 418
- $3j$  symbols . . . . . 758
  - angular momenta . . . . . 758
  - applications . . . . . 765
  - approximations for large parameters . . . . . 764
  - computation . . . . . 765
  - definition . . . . . 758
  - Gaunt coefficient . . . . . 761
  - Gaunt's integral . . . . . 761
  - generating functions . . . . . 760
  - graphical method . . . . . 765
  - notation . . . . . 758
  - orthogonality . . . . . 760
  - projective quantum numbers . . . . . 758
  - recursion relations . . . . . 760
  - Regge symmetries . . . . . 759
  - relations to other functions
    - Legendre functions . . . . . 760
    - rotation matrices . . . . . 761
    - spherical harmonics . . . . . 760
  - representation as
    - finite sum of algebraic quantities . . . . . 758
    - generalized hypergeometric functions . . . . . 758
    - special cases . . . . . 759

- summation convention ..... 760
- sums ..... 760
- symmetry ..... 759
- tables ..... 765
- triangle conditions ..... 758
- zeros ..... 765
- Toda equation
  - Hermite polynomials ..... 478
- tomography
  - confluent hypergeometric functions ..... 346
- tops
  - Jacobian elliptic, or hyperelliptic, integrals ..... 566
- toroidal coordinates ..... 371, 379
- toroidal functions ..... **371**
  - applications ..... 379
  - definitions ..... 371
  - hypergeometric representations ..... 371
  - integral representations ..... 371
  - sums ..... 372
  - Whipple's formula ..... 372
- torus
  - complex ..... 533
- transcendental equations
  - asymptotic solutions ..... 43
- transcendental functions ..... 724
- transition points ..... 58, 63
- transport equilibrium
  - generalized exponential integral ..... 190
- triangle conditions
  - $3j$  symbols ..... 758
- triangle inequality ..... 15
- triangles
  - solution of ..... 130
- triangular matrices
  - confluent hypergeometric functions ..... 345
- triconfluent Heun equation ..... 718
- trigonometric functions ..... **112**
  - addition formulas ..... 117
  - analytic properties ..... 112
  - applications
    - cubic equations ..... 131
    - solution of triangles and spherical triangles ... 130
  - approximations ..... 132
  - Chebyshev-series expansions ..... 132
  - computation ..... 131
  - conformal maps ..... 113
  - continued fractions ..... 121
  - definitions ..... 112
  - derivatives ..... 117
  - differential equations ..... 117
  - elementary properties ..... 115–116
  - graphics
    - complex argument ..... 113–115
    - real argument ..... 112
  - identities ..... 117
  - inequalities ..... 116
  - infinite products ..... 118
  - integrals
    - definite ..... 122
    - indefinite ..... 122
  - inverse ..... *see* inverse trigonometric functions.
  - Laurent series ..... 116
  - limits ..... 116
  - Maclaurin series ..... 116
  - moduli ..... 118
  - multiples of argument ..... 118
  - notation ..... 104
  - orthogonality ..... 122
  - partial fractions ..... 118
  - periodicity ..... 112
  - poles ..... 123
  - real and imaginary parts ..... 118
  - relations to hyperbolic functions ..... 123
  - special values ..... 116
  - squares and products ..... 117
  - sums ..... 123
  - tables ..... 132
  - zeros ..... 112
- triple integrals ..... 9
- truncated exponential series ..... 180
- turning points ..... 58, 63
  - fractional or multiple ..... 61
- two-body relativistic scattering
  - Lamé polynomials ..... 694
- ultraspherical polynomials ..... **438**
  - ..... *see also* classical orthogonal polynomials.
  - addition theorem ..... 459
  - applications
    - zonal spherical harmonics ..... 479
  - asymptotic approximations ..... 452
  - case  $\lambda = 0$  ..... 437
  - computation ..... 479
  - definition ..... 439
  - derivatives ..... 446
  - differential equation ..... 445
  - expansions in series of ..... 460, 461
  - Fourier transforms ..... 456
  - generating functions ..... 449
  - inequalities ..... 450
  - integral representations ..... 447, 448
    - for products ..... 455
  - integrals ..... 456
  - interrelations with other orthogonal polynomials
    - ..... 444–445, 448
  - leading coefficients ..... 439
  - limits to monomials ..... 444
  - linearization formula ..... 460
  - Mellin transform ..... 458

- normalization ..... 439
- notation ..... 436, 437
- orthogonality property ..... 439
- parameter constraint ..... 439, 443
- recurrence relations ..... 446
- relations to other functions
  - Ferrers functions ..... 448
  - hypergeometric function ..... 393, 442
- Rodrigues formula ..... 442
- special values ..... 444
- symmetry ..... 444
- tables of coefficients ..... 440
- upper bound ..... 450
- weight function ..... 439
- zeros ..... 438, 454
- umbilics
  - normal forms ..... 776
- umbral calculus
  - Bernoulli and Euler polynomials ..... 590
- uniformization
  - algebraic equations via Jacobian elliptic functions  
..... 564
- unity
  - roots of ..... 23
- vacuum magnetic fields
  - toroidal functions ..... 379
- validated computing ..... 72
- Van Vleck polynomials
  - definition ..... 718
  - zeros ..... 718
- Van Vleck's theorem for continued fractions ..... 25
- Vandermonde ..... 3
- Vandermonde determinant ..... 3
- variation of parameters
  - inhomogeneous differential equations ..... 26
- variation of real or complex functions ..... 6
  - bounded ..... 6
  - total ..... 6
- variational operator ..... 44
- vector
  - equivalent ..... 542
  - norms ..... 74
- vector-valued functions ..... 9–12
  - ..... *see also* parametrized surfaces.
  - curl ..... 10
  - del operator ..... 10
  - divergence ..... 10
  - divergence (or Gauss's) theorem ..... 12
  - gradient ..... 10
  - Green's theorem
    - three dimensions ..... 12
    - two dimensions ..... 11
  - line integral ..... 11
  - path integral ..... 11
  - reparametrization of integration paths
    - orientation-preserving ..... 11
    - orientation-reversing ..... 11
  - Stokes' theorem ..... 12
- vectors ..... 9
  - ..... *see also* vector-valued functions.
  - angle ..... 9
  - cross product ..... 9
    - right-hand rule ..... 10
  - dot product ..... 9
  - Einstein summation convention ..... 10
  - Levi-Civita symbol ..... 10
  - magnitude ..... 9
  - notations ..... 9, 10
  - right-hand rule for cross products ..... 10
  - scalar product ..... *see* dot product.
  - unit ..... 9
  - vector product ..... *see* cross product.
- vibrational problems
  - Mathieu functions ..... 678
- Voigt functions
  - applications ..... 169
  - computation ..... 169
  - definition ..... 167
  - graphs ..... 168
  - properties ..... 168
  - relation to line broadening function ..... 167
  - tables ..... 169
- von Staudt–Clausen theorem
  - Bernoulli numbers ..... 593
- Voronoi's congruence
  - Bernoulli numbers ..... 593
- Waring's problem
  - number theory ..... 645
- water waves
  - Kelvin's ship-wave pattern ..... 790–791
  - Riemann theta functions ..... 545
  - Struve functions ..... 298
- Watson integrals
  - Appell functions ..... 417
  - generalized hypergeometric functions ..... 417
- Watson's  ${}_3F_2$  sum
  - Andrews' terminating  $q$ -analog ..... 427
  - Gasper–Rahman  $q$ -analog ..... 426
- Watson's expansions
  - theta functions ..... 531
- Watson's identities
  - theta functions ..... 531
- Watson's lemma
  - asymptotic expansions of integrals ..... 44, 46
- Watson's sum
  - generalized hypergeometric functions ..... 406
- wave acoustics
  - generalized exponential integral ..... 190
- wave equation

- ..... *see also* water waves.
- Bessel functions and modified Bessel functions .. 276
- confluent hypergeometric functions ..... 346
- ellipsoidal coordinates ..... 693
- Mathieu functions ..... 678
- oblate spheroidal coordinates ..... 705–706
- paraboloidal coordinates ..... 346
- prolate spheroidal coordinates ..... 704–705
- separation constants ..... 693
- spherical Bessel functions ..... 276
- sphero-conal coordinates ..... 693
- symmetric elliptic integrals ..... 501
- wave functions
  - paraboloidal ..... 677
- waveguides ..... 275
- Weber function ..... *see* Anger–Weber functions.
- Weber parabolic cylinder functions
  - ..... *see* parabolic cylinder functions.
- Weber’s function
  - ..... *see* Bessel functions of the second kind.
- Weber–Schafheitlin discontinuous integrals
  - Bessel functions ..... 244
- Weierstrass  $M$ -test
  - ..... *see*  $M$ -test for uniform convergence.
- Weierstrass elliptic functions ..... **570**
  - addition theorems ..... 577
  - analytic properties ..... 570
  - applications
    - mathematical ..... 581
    - physical ..... 582–583
  - asymptotic approximations ..... 578
  - computation ..... 583
  - definitions ..... 570
  - derivatives ..... 571
  - differential equations ..... 571
  - discriminant ..... 571
  - duplication formulas ..... 578
  - equianharmonic case ..... 571–572, 574
  - Fourier series ..... 576
  - graphics
    - complex variables ..... 573–574
    - real variables ..... 571–572
  - homogeneity ..... 578
  - infinite products ..... 577
  - integral representations ..... 578
  - integrals ..... 579
  - lattice ..... 570
    - computation ..... 583
    - equianharmonic ..... 574
    - generators ..... 570
    - invariants ..... 571
    - lemniscatic ..... 571–572, 574
    - notation ..... 570
    - points ..... 570
    - pseudo-lemniscatic ..... 574
    - rectangular ..... 574
    - rhombic ..... 574
    - roots ..... 571
  - Laurent series ..... 577
  - lemniscatic case ..... 571–572, 574
  - $n$ -tuple formulas ..... 578
  - notation ..... 570
  - periodicity ..... 571
  - poles ..... 570
  - power series ..... 577
  - principal value ..... 577
  - pseudo-lemniscatic case ..... 574
  - quarter periods ..... 576
  - quasi-periodicity ..... 571
  - relations to other functions
    - elliptic integrals ..... 576
    - general elliptic functions ..... 576
    - Jacobian elliptic functions ..... 575
    - symmetric elliptic integrals ..... 509
    - theta functions ..... 574
  - rhombic case ..... 574
  - series of cosecants or cotangents ..... 577
  - tables ..... 584
  - zeros ..... 570, 579
- Weierstrass  $\wp$ -function
  - ..... *see* Weierstrass elliptic functions.
- Weierstrass product ..... 22
- Weierstrass sigma function
  - ..... *see* Weierstrass elliptic functions.
- Weierstrass zeta function
  - ..... *see* Weierstrass elliptic functions.
- weight functions
  - cubature ..... 84–85
  - definition ..... 79, 437
  - Freud ..... 475
  - least squares approximations ..... 99
  - logarithmic ..... 81–82
  - minimax rational approximations ..... 97
  - quadrature ..... 79–80
- weighted means ..... 3
- Weniger’s transformation
  - for sequences ..... 94
- Whipple’s  ${}_3F_2$  sum
  - Gaspar–Rahman  $q$ -analog ..... 427
- Whipple’s formula
  - associated Legendre functions ..... 362
  - toroidal functions ..... 372
- Whipple’s sum
  - generalized hypergeometric functions ..... 406
- Whipple’s theorem
  - Watson’s  $q$ -analog ..... 429
- Whipple’s transformation
  - generalized hypergeometric functions ..... 407

- Whittaker functions ..... **334**  
 ..... *see also* confluent hypergeometric functions.  
 addition theorems.....345  
 analytic continuation.....334  
 analytical properties ..... 334  
 applications  
   Coulomb functions.....346  
   groups of triangular matrices ..... 345  
   physical..... 346, 754  
   uniform asymptotic solutions of differential equations ..... 345  
 asymptotic approximations for large parameters  
   imaginary  $\kappa$  and/or  $\mu$ .....340  
   large  $\kappa$ ..... 341–342  
   large  $\mu$ ..... 339–341  
   uniform ..... 339–342  
 asymptotic expansions for large argument ..... 339  
   error bounds..... 339  
   exponentially-improved ..... 339  
 computation ..... 346  
 connection formulas.....335  
 continued fractions..... 338  
 definitions ..... 334  
 derivatives ..... 336  
 differential equation..... *see* Whittaker's equation.  
 expansions in series of.....344  
 integral representations  
   along the real line ..... 337  
   contour integrals..... 337  
   Mellin–Barnes type..... 337  
 integral transforms in terms of ..... 344  
 integrals ..... 337  
   compendia ..... 344  
   Fourier transforms..... 343  
   Hankel transforms..... 343–344  
   Laplace transforms ..... 343  
   Mellin transforms ..... 343  
 interrelations ..... 335  
 large argument.....69  
 limiting forms  
   as  $z \rightarrow 0$ .....335  
   as  $z \rightarrow \infty$ .....335  
 multiplication theorems ..... 345  
 notation ..... 322  
 power series.....334  
 principal branches (or values) ..... 334  
 products ..... 345  
 recurrence relations ..... 336  
 relations to other functions  
   Airy functions..... 338  
   Coulomb functions ..... 742, 748, 751  
   elementary functions.....338  
   error functions.....338  
   incomplete gamma functions ..... 338  
   Kummer functions.....334  
   modified Bessel functions ..... 338  
   orthogonal polynomials..... 338  
   parabolic cylinder functions.....338  
   series expansions ..... 344–345  
     addition theorems ..... 345  
     in Bessel functions or modified Bessel functions  
       ..... 344  
     multiplication theorems.....345  
     power ..... 334  
   Wronskians ..... 335  
   zeros  
     asymptotic approximations ..... 343  
     distribution..... 342  
     inequalities ..... 343  
     number of ..... 343  
 Whittaker's equation.....334  
   fundamental solutions.....335  
   numerically satisfactory solutions ..... 335  
   relation to Kummer's equation ..... 334  
   standard solutions ..... 334  
 Whittaker–Hill equation.....676  
   applications.....678  
   separation constants ..... 678  
 Wigner  $3j, 6j, 9j$  symbols  
   ..... *see*  $3j$  symbols,  $6j$  symbols, and  $9j$  symbols.  
 Wilf–Zeilberger algorithm  
   applied to generalized hypergeometric functions.. 407  
 Wilkinson's polynomial.....92  
 Wilson class orthogonal polynomials ..... 467–470  
   asymptotic approximations.....470  
   definitions ..... 467  
   differences ..... 469  
   dualities ..... 463  
   generating functions ..... 469  
   interrelations with other orthogonal polynomials  
     ..... 464, 468–469  
   leading coefficients ..... 468  
   normalizations ..... 467–468  
   notation ..... 436  
   orthogonality properties.....467  
   relation to generalized hypergeometric functions  
     ..... 468–469  
   transformations of variable ..... 467  
   weight functions.....467–468  
 Wilson polynomials  
   ..... *see* Wilson class orthogonal polynomials.  
 winding number  
   of closed contour ..... 16  
 WKB or WKB approximation  
   .. *see* Liouville–Green (or WKBJ) approximation.  
 Wronskian  
   differential equations.....26  
 Wynn's cross rule

- for Padé approximations ..... 98
- Wynn's epsilon algorithm
  - for sequences ..... 93
- zero potential
  - Coulomb functions ..... 753, 754
- zeros of analytic functions
  - computation ..... 90–92
  - conditioning ..... 92
  - multiplicity ..... 19, 90
  - simple ..... 90
- zeros of Bessel functions (including derivatives)
  - analytic properties ..... 235
  - approximations ..... 281
  - asymptotic expansions for large order
    - uniform ..... 237
  - asymptotic expansions for large zeros ..... 236
    - error bounds ..... 236
  - bounds ..... 236
  - common ..... 235
  - complex ..... 235, 238
  - computation ..... 277
  - distribution ..... 235, 238–240
  - double ..... 235
  - interlacing ..... 235
  - monotonicity ..... 236
  - notation ..... 235
  - of cross-products ..... 238
    - asymptotic expansions ..... 238
  - purely imaginary ..... 235, 236
  - relation to inverse phase functions ..... 235
  - tables ..... 132, 278
  - with respect to order ( $\nu$ -zeros) ..... 240
- zeros of cylinder functions (including derivatives)
  - ..... 235–237
  - analytic properties ..... 235
  - asymptotic expansions for large order
    - uniform ..... 236
  - asymptotic expansions for large zeros ..... 236
  - forward differences ..... 235
  - interlacing ..... 235
  - monotonicity ..... 236
  - relation to inverse phase functions ..... 235
- zeros of polynomials
  - ..... *see also* stable polynomials.
  - computation ..... 91–92
  - conditioning ..... 92
  - degrees two, three, four ..... 23
  - Descartes' rule of signs ..... 22
  - discriminant ..... 22
  - distribution ..... 22
  - division algorithm ..... 22
  - elementary properties ..... 22
  - elementary symmetric functions ..... 22
  - explicit formulas ..... 91
  - Horner's scheme ..... 22
    - extended ..... 22
  - resolvent cubic ..... 23
  - roots of constants ..... 23
  - roots of unity ..... 23
- zeta function ..... *see* Hurwitz zeta function, Jacobi's zeta function, periodic zeta function, Riemann zeta function, *and* Weierstrass zeta function.
- zonal polynomials ..... **769**
  - applications ..... 773
  - beta integral ..... 769
  - definition ..... 769
  - Laplace integral ..... 769
  - mean-value ..... 769
  - normalization ..... 769
  - notation ..... 769
  - orthogonality ..... 769
  - summation ..... 769
  - tables ..... 773
- zonal spherical harmonics
  - ultraspherical polynomials ..... 479