

Graduate Texts in Mathematics 196

*Editorial Board*

S. Axler F.W. Gehring K.A. Ribet

**Springer**

*New York*

*Berlin*

*Heidelberg*

*Barcelona*

*Hong Kong*

*London*

*Milan*

*Paris*

*Singapore*

*Tokyo*

# Graduate Texts in Mathematics

- 1 TAKEUTI/ZARING. Introduction to Axiomatic Set Theory. 2nd ed.
- 2 OXTOBY. Measure and Category. 2nd ed.
- 3 SCHAEFER. Topological Vector Spaces. 2nd ed.
- 4 HILTON/STAMMBACH. A Course in Homological Algebra. 2nd ed.
- 5 MAC LANE. Categories for the Working Mathematician. 2nd ed.
- 6 HUGHES/PIPER. Projective Planes.
- 7 SERRE. A Course in Arithmetic.
- 8 TAKEUTI/ZARING. Axiomatic Set Theory.
- 9 HUMPHREYS. Introduction to Lie Algebras and Representation Theory.
- 10 COHEN. A Course in Simple Homotopy Theory.
- 11 CONWAY. Functions of One Complex Variable I. 2nd ed.
- 12 BEALS. Advanced Mathematical Analysis.
- 13 ANDERSON/FULLER. Rings and Categories of Modules. 2nd ed.
- 14 GOLUBITSKY/GUILLEMIN. Stable Mappings and Their Singularities.
- 15 BERBERIAN. Lectures in Functional Analysis and Operator Theory.
- 16 WINTER. The Structure of Fields.
- 17 ROSENBLATT. Random Processes. 2nd ed.
- 18 HALMOS. Measure Theory.
- 19 HALMOS. A Hilbert Space Problem Book. 2nd ed.
- 20 HUSEMOLLER. Fibre Bundles. 3rd ed.
- 21 HUMPHREYS. Linear Algebraic Groups.
- 22 BARNES/MACK. An Algebraic Introduction to Mathematical Logic.
- 23 GREUB. Linear Algebra. 4th ed.
- 24 HOLMES. Geometric Functional Analysis and Its Applications.
- 25 HEWITT/STROMBERG. Real and Abstract Analysis.
- 26 MANES. Algebraic Theories.
- 27 KELLEY. General Topology.
- 28 ZARISKI/SAMUEL. Commutative Algebra. Vol.I.
- 29 ZARISKI/SAMUEL. Commutative Algebra. Vol.II.
- 30 JACOBSON. Lectures in Abstract Algebra I. Basic Concepts.
- 31 JACOBSON. Lectures in Abstract Algebra II. Linear Algebra.
- 32 JACOBSON. Lectures in Abstract Algebra III. Theory of Fields and Galois Theory.
- 33 HIRSCH. Differential Topology.
- 34 SPITZER. Principles of Random Walk. 2nd ed.
- 35 ALEXANDER/WERMER. Several Complex Variables and Banach Algebras. 3rd ed.
- 36 KELLEY/NAMIOKA et al. Linear Topological Spaces.
- 37 MONK. Mathematical Logic.
- 38 GRAUERT/FRITZSCHE. Several Complex Variables.
- 39 ARVESON. An Invitation to  $C^*$ -Algebras.
- 40 KEMENY/SNELL/KNAPP. Denumerable Markov Chains. 2nd ed.
- 41 APOSTOL. Modular Functions and Dirichlet Series in Number Theory. 2nd ed.
- 42 SERRE. Linear Representations of Finite Groups.
- 43 GILLMAN/JERISON. Rings of Continuous Functions.
- 44 KENDIG. Elementary Algebraic Geometry.
- 45 LOÈVE. Probability Theory I. 4th ed.
- 46 LOÈVE. Probability Theory II. 4th ed.
- 47 MOISE. Geometric Topology in Dimensions 2 and 3.
- 48 SACHS/WU. General Relativity for Mathematicians.
- 49 GRUENBERG/WEIR. Linear Geometry. 2nd ed.
- 50 EDWARDS. Fermat's Last Theorem.
- 51 KLINGENBERG. A Course in Differential Geometry.
- 52 HARTSHORNE. Algebraic Geometry.
- 53 MANIN. A Course in Mathematical Logic.
- 54 GRAVER/WATKINS. Combinatorics with Emphasis on the Theory of Graphs.
- 55 BROWN/PEARCY. Introduction to Operator Theory I: Elements of Functional Analysis.
- 56 MASSEY. Algebraic Topology: An Introduction.
- 57 CROWELL/FOX. Introduction to Knot Theory.
- 58 KOBLITZ.  $p$ -adic Numbers,  $p$ -adic Analysis, and Zeta-Functions. 2nd ed.
- 59 LANG. Cyclotomic Fields.
- 60 ARNOLD. Mathematical Methods in Classical Mechanics. 2nd ed.
- 61 WHITEHEAD. Elements of Homotopy
- 62 KARGAPOLOV/MERLZJAKOV. Fundamentals of the Theory of Groups.
- 63 BOLLOBAS. Graph Theory.
- 64 EDWARDS. Fourier Series. Vol. I 2nd ed.
- 65 WELLS. Differential Analysis on Complex Manifolds. 2nd ed.
- 66 WATERHOUSE. Introduction to Affine Group Schemes.
- 67 SERRE. Local Fields.
- 68 WEIDMANN. Linear Operators in Hilbert Spaces.
- 69 LANG. Cyclotomic Fields II.
- 70 MASSEY. Singular Homology Theory.
- 71 FARKAS/KRA. Riemann Surfaces. 2nd ed.

*(continued after index)*

M. Scott Osborne

# Basic Homological Algebra



Springer

M. Scott Osborne  
Department of Mathematics  
University of Washington  
Seattle, WA 98195-4350 USA  
sosborne@math.washington.edu

*Editorial Board*

S. Axler  
Mathematics Department  
San Francisco State  
University  
San Francisco, CA 94132  
USA

F.W. Gehring  
Mathematics Department  
East Hall  
University of Michigan  
Ann Arbor, MI 48109  
USA

K.A. Ribet  
Mathematics Department  
University of California  
at Berkeley  
Berkeley, CA 94720-3840  
USA

---

Mathematics Subject Classification (2000): 18-01, 18G15

---

Library of Congress Cataloging-in-Publication Data  
Osborne, M. Scott.

Basic homological algebra / M. Scott Osborne.

p. cm. — (Graduate texts in mathematics ; 196)

Includes bibliographical references and index.

ISBN 0-387-98934-X (hc. : alk. paper)

1. Algebra, Homological. I. Title. II. Series.

QA169.083 2000

512'.55—dc21

99-046582

Printed on acid-free paper.

© 2000 Springer-Verlag New York, Inc.

All rights reserved. This work may not be translated or copied in whole or in part without the written permission of the publisher (Springer-Verlag New York, Inc., 175 Fifth Avenue, New York, NY 10010, USA), except for brief excerpts in connection with reviews or scholarly analysis. Use in connection with any form of information storage and retrieval, electronic adaptation, computer software, or by similar or dissimilar methodology now known or hereafter developed is forbidden. The use of general descriptive names, trade names, trademarks, etc., in this publication, even if the former are not especially identified, is not to be taken as a sign that such names, as understood by the Trade Marks and Merchandise Marks Act, may accordingly be used freely by anyone.

This reprint has been authorized by Springer-Verlag (Berlin/Heidelberg/New York) for sale in the People's Republic of China only and not for export therefrom.

Reprinted in China by Beijing World Publishing Corporation, 2003

9 8 7 6 5 4 3 2 1

ISBN 0-387-98934-X Springer-Verlag New York Berlin Heidelberg SPIN 10745204

# Preface

Five years ago, I taught a one-quarter course in homological algebra. I discovered that there was no book which was really suitable as a text for such a short course, so I decided to write one. The point was to cover both Ext and Tor early, and still have enough material for a larger course (one semester or two quarters) going off in any of several possible directions. This book is also intended to be readable enough for independent study.

The core of the subject is covered in Chapters 1 through 3 and the first two sections of Chapter 4. At that point there are several options. Chapters 4 and 5 cover the more traditional aspects of dimension and ring changes. Chapters 6 and 7 cover derived functors in general. Chapter 8 focuses on a special property of Tor. These three groupings are independent, as are various sections from Chapter 9, which is intended as a source of special topics. (The prerequisites for each section of Chapter 9 are stated at the beginning.)

Some things have been included simply because they are hard to find elsewhere, and they naturally fit into the discussion. Lazard's theorem (Section 8.4) is an example; Sections 4, 5, and 7 of Chapter 9 contain other examples, as do the appendices at the end.

The idea of the book's plan is that subjects can be selected based on the needs of the class. When I taught the course, it was a prerequisite for a course on noncommutative algebraic geometry. It was also taken by several students interested in algebraic topology, who requested the material in Sections 9.2 and 9.3. (One student later said he wished he'd seen injective envelopes, so I put them in, too.) The ordering of the subjects in Chapter



9 is primarily based on how involved each section's prerequisites are.

The prerequisite for this book is a graduate algebra course. Those who have seen categories and functors can skip Chapter 1 (after a peek at its appendix).

There are a few oddities. The chapter on abstract homological algebra, for example, follows the pedagogical rule that if you don't need it, don't define it. For the expert, the absence of pullbacks and pushouts will stand out, but they are not needed for abstract homological algebra, not even for the long exact sequences in Abelian categories. In fact, they obscure the fact that, for example, the connecting morphism in the ker-coker exact sequence (sometimes called the snake lemma) is really a homology morphism. Similarly, overindulgence in  $\delta$ -functor concepts may lead one to believe that the subject of Section 6.5 is moot.

In the other direction, more attention is paid (where necessary) to set theoretic technicalities than is usual. This subject (like category theory) has become widely available of late, thanks to the very readable texts of Devlin [15], Just and Weese [41], and Vaught [73]. Such details are not needed very often, however, and the discussion starts at a much lower level.

Solution outlines are included for some exercises, including exercises that are used in the text.

In preparing this book, I acknowledge a huge debt to Mark Johnson. He read the whole thing and supplied numerous suggestions, both mathematical and stylistic. I also received helpful suggestions from Garth Warner and Paul Smith, as well as from Dave Frazzini, David Hubbard, Izuru Mori, Lee Nave, Julie Nuzman, Amy Rossi, Jim Mailhot, Eric Rimbey, and H. A. R. V. Wijesundera. Kate Senehi and Lois Fisher also supplied helpful information at strategic points. Many thanks to them all. I finally wish to thank Mary Sheetz, who put the manuscript together better than I would have believed possible.

Concerning source material, the very readable texts of Jans [40] and Rotman [68] showed me what good exposition can do for this subject, and I used them heavily in preparing the original course. I only wish I could write as well as they do.

M. Scott Osborne  
University of Washington  
Fall, 1998

### Chapter/Appendix Dependencies

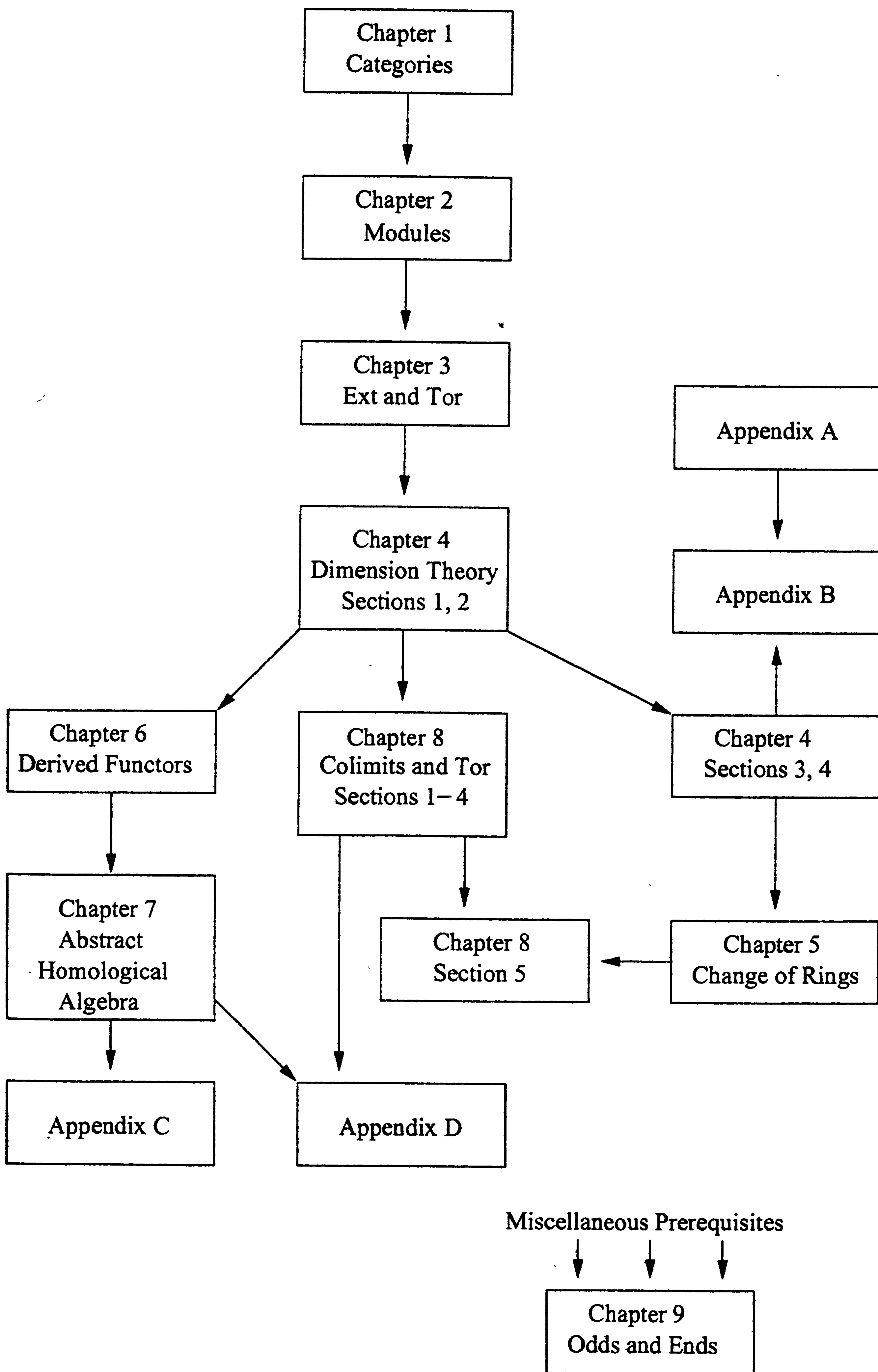





# Contents

<b>Preface</b>	<b>v</b>
<b>1 Categories</b>	<b>1</b>
<b>2 Modules</b>	<b>11</b>
2.1 Generalities . . . . .	11
2.2 Tensor Products . . . . .	14
2.3 Exactness of Functors . . . . .	22
2.4 Projectives, Injectives, and Flats . . . . .	28
<b>3 Ext and Tor</b>	<b>39</b>
3.1 Complexes and Projective Resolutions . . . . .	39
3.2 Long Exact Sequences . . . . .	47
3.3 Flat Resolutions and Injective Resolutions . . . . .	55
3.4 Consequences . . . . .	66
<b>4 Dimension Theory</b>	<b>73</b>
4.1 Dimension Shifting . . . . .	73
4.2 When Flats are Projective . . . . .	79
4.3 Dimension Zero . . . . .	82
4.4 An Example . . . . .	91
<b>5 Change of Rings</b>	<b>99</b>
5.1 Computational Considerations . . . . .	99
5.2 Matrix Rings . . . . .	104
5.3 Polynomials . . . . .	106
5.4 Quotients and Localization . . . . .	110
<b>6 Derived Functors</b>	<b>123</b>
6.1 Additive Functors . . . . .	123
6.2 Derived Functors . . . . .	126

6.3	Long Exact Sequences—I. Existence . . . . .	130
6.4	Long Exact Sequences—II. Naturality . . . . .	140
6.5	Long Exact Sequences—III. Weirdness . . . . .	147
6.6	Universality of Ext . . . . .	151
<b>7</b>	<b>Abstract Homological Algebra</b>	<b>165</b>
7.1	Living Without Elements . . . . .	165
7.2	Additive Categories . . . . .	169
7.3	Kernels and Cokernels . . . . .	173
7.4	Cheating with Projectives . . . . .	186
7.5	(Interlude) Arrow Categories . . . . .	202
7.6	Homology in Abelian Categories . . . . .	213
7.7	Long Exact Sequences . . . . .	225
7.8	An Alternative for Unbalanced Categories . . . . .	239
<b>8</b>	<b>Colimits and Tor</b>	<b>257</b>
8.1	Limits and Colimits . . . . .	257
8.2	Adjoint Functors . . . . .	264
8.3	Directed Colimits, $\otimes$ , and Tor . . . . .	270
8.4	Lazard's Theorem . . . . .	274
8.5	Weak Dimension Revisited . . . . .	280
<b>9</b>	<b>Odds and Ends</b>	<b>285</b>
9.1	Injective Envelopes . . . . .	285
9.2	Universal Coefficients . . . . .	290
9.3	The Künneth Theorems . . . . .	296
9.4	Do Connecting Homomorphisms Commute? . . . . .	309
9.5	The Ext Product . . . . .	318
9.6	The Jacobson Radical, Nakayama's Lemma, and Quasilocal Rings . . . . .	324
9.7	Local Rings and Localization Revisited (Expository) . . . . .	331
<b>A</b>	<b>GCDs, LCMs, PIDs, and UFDs</b>	<b>337</b>
<b>B</b>	<b>The Ring of Entire Functions</b>	<b>345</b>
<b>C</b>	<b>The Mitchell–Freyd Theorem and Cheating in Abelian Cat- egories</b>	<b>359</b>
<b>D</b>	<b>Noether Correspondences in Abelian Categories</b>	<b>363</b>
	<b>Solution Outlines</b>	<b>373</b>
	<b>References</b>	<b>383</b>
	<b>Symbol Index</b>	<b>389</b>
	<b>Index</b>	<b>391</b>

# 1

## Categories

Homological algebra addresses questions that appear naturally in category theory, so category theory is a good starting point. Most of what follows is standard, but there are a few slippery points.

First, a few words about classes. The concept of a *class* is intended to generalize the concept of a set. That is, not only will all sets be classes, but some other collections of things that are “too big” to be sets will also be classes. For example, the collection of all sets is a class. It is a *proper* class, in the sense that it cannot be a set; this is the Russell paradox, which traditionally is presented as follows.

Let  $\mathbf{S}$  be the class of all sets. Assume  $\mathbf{S}$  is a set. Then

$$A = \{X \in \mathbf{S} \mid X \notin X\}$$

is also a set. Note that for any set  $X$ ,

$$X \in A \Leftrightarrow X \notin X.$$

In particular, taking  $X = A$ ,

$$A \in A \Leftrightarrow A \notin A,$$

a contradiction.

Note also that  $\mathcal{P}(\mathbf{S}) \subset \mathbf{S}$ , which should be bizarre enough.

In Gödel–Bernays–von Neumann class theory, sets are defined as classes which are members of other classes. In fact, the *only* members any class has are sets. The power class is the collection of subsets, so  $\mathcal{P}(\mathbf{S}) = \mathbf{S}$ ,

and  $\mathbf{S} \notin \mathcal{P}(\mathbf{S})$ . The axioms of Gödel–Bernays–von Neumann class theory lead to what we have learned to expect of classes, but this is a complicated business. A brief variant appears as an appendix to Kelley [48, pp. 250–281].

For our purposes (at least until Section 6.6), all we need to know is that the class concept is like the set concept, only broader: Classes are still collections of things, and all sets are classes, but some classes (like the class of all sets) are not sets. Also, the *elementary* set manipulations, like union, intersection, specification, formation of functions, etc., can be carried out for classes as well. The one thing we *cannot* do is force a class to belong to another class, unless the first class is actually a set. For example, one can define an equivalence relation on a class, and then form equivalence classes, but one cannot form the class of equivalence classes unless the equivalence classes are actually sets. An example on the class  $\mathbf{S}$ : Say that  $X \sim Y$  when  $X$  and  $Y$  have the same cardinality. The equivalence class of  $\emptyset$  is  $\{\emptyset\}$ ; it is the only equivalence class which is a set.

A *category*  $\mathbf{C}$  consists of a class of objects,  $\text{obj } \mathbf{C}$ , together with sets (repeat, *sets*) of morphisms, which arise in the following manner. There is a function  $\text{Mor}$  which assigns to each pair  $A, B \in \text{obj } \mathbf{C}$  a set of morphisms  $\text{Mor}(A, B)$  from  $A$  to  $B$ , sometimes written  $\text{Mor}_{\mathbf{C}}(A, B)$  if  $\mathbf{C}$  is to be emphasized.  $\text{Mor}(A, B)$  is called the set of *morphisms from  $A$  to  $B$* . The category  $\mathbf{C}$  also includes a pairing (function), called composition:

$$\text{Mor}(B, C) \times \text{Mor}(A, B) \rightarrow \text{Mor}(A, C)$$

$$(g, f) \mapsto gf.$$

Finally, each  $\text{Mor}(A, A)$  contains a distinguished element  $i_A$ . The axioms are:

- 1) Composition is *associative*. That is, if  $f \in \text{Mor}(C, D)$ ,  $g \in \text{Mor}(B, C)$ , and  $h \in \text{Mor}(A, B)$ , then  $(fg)h = f(gh)$ .
- 2) Each  $i_A$  is an *identity*. That is, if  $f \in \text{Mor}(A, B)$ , then  $f = fi_A = i_B f$ .

Note: Many authors also require

- 3)  $\text{Mor}(A, B)$  is disjoint from  $\text{Mor}(C, D)$  unless  $A = C$ ,  $B = D$ .

This serves as a bookkeeping device, and also allows certain constructions. It is also a pain in the neck to enforce. (See below concerning concrete categories.) However, if  $\mathbf{C}$  does not satisfy this, one may replace  $f \in \text{Mor}(A, B)$  by the ordered triple  $(A, f, B)$ . That is, replace  $\text{Mor}(A, B)$  by  $\{A\} \times \text{Mor}(A, B) \times \{B\}$ .

**Example 1 SETS.**  $\text{obj } \mathbf{Set} =$  class of all sets.  $\text{Mor}(A, B) =$  all functions from  $A$  to  $B$ .

**Example 2** GROUPS.  $\text{obj Gr} =$  class of all groups.  $\text{Mor}(A, B) =$  all homomorphisms from  $A$  to  $B$ .

**Example 3** TOPOLOGICAL SPACES.  $\text{obj Top} =$  class of all topological spaces.  $\text{Mor}(A, B) =$  all continuous  $f : A \rightarrow B$ .

“Composition” is functional composition. The reader should be able to provide lots of examples like the above. There are other kinds, as well.

**Example 4** Given  $\mathbf{C}$ , form the opposite category,  $\mathbf{C}^{\text{op}} : \text{obj } \mathbf{C} = \text{obj } \mathbf{C}^{\text{op}}$ , while  $\text{Mor}_{\mathbf{C}^{\text{op}}}(A, B) = \text{Mor}_{\mathbf{C}}(B, A)$ . Composition is reversed: Letting  $*$  denote composition in  $\mathbf{C}^{\text{op}}$ , set  $f * g = gf$ .

**Example 5** Note that, from the definition,  $\text{Mor}(A, A)$  is always a monoid, that is, a semigroup with identity. This is quite general; if  $S$  is a monoid, define a category as follows:  $\text{obj } \mathbf{C} = \{S\}$ , and set  $\text{Mor}(S, S) = S$ . Composition is the semigroup multiplication. Note further that the singleton  $\text{obj } \mathbf{C}$  can, in fact, be replaced by any other singleton  $\{A\}$ , with  $\text{Mor}(A, A) = S$ . At this point, we are rather far from our intuitions about morphisms; the circuit breakers in our heads may need resetting.

The last two examples are different in flavor from the first three. But that’s good; the notion of a category is broad enough to include some weird examples. To isolate the content of the first three examples:

**Definition 1.1** *A category  $\mathbf{C}$  is called a concrete category provided  $\mathbf{C}$  comes equipped with a function  $\sigma$  whose domain is  $\text{obj } \mathbf{C}$  such that*

1. *If  $A \in \text{obj } \mathbf{C}$ , then  $\sigma(A)$  is a set. (It is called the underlying set of  $A$ .)*
2.  *$\text{Mor}(A, B)$  consists of functions from  $\sigma(A)$  to  $\sigma(B)$ , that is, any  $f \in \text{Mor}(A, B)$  is a function from  $\sigma(A)$  to  $\sigma(B)$ .*
3. *Categorical composition is functional composition.*
4.  *$i_A$  is the identity map on  $\sigma(A)$ .*

Observe that, if one adopts the disjointness requirement in the definition of a category, condition 2 cannot be taken literally. (For example, in  $\mathbf{Set}$ ,  $\text{Mor}(\emptyset, A) = \{\text{empty function}\}$  for all  $A$ .) Rather, replace it with

- 2'.  *$\text{Mor}(A, B)$  consists of ordered triples  $(A, f, B)$ , where  $f$  is a function from  $\sigma(A)$  to  $\sigma(B)$ .*

Concrete categories have a number of uses; an odd one will be described in the appendix. One use is the definition of free objects.



**Definition 1.2** If  $\mathbf{C}$  is a concrete category,  $F \in \text{obj } \mathbf{C}$ , and  $X$  is a set, and if  $\varphi : X \rightarrow \sigma(F)$  is a one-to-one function, then  $F$  is called **free on  $X$**  if and only if for every  $A \in \text{obj } \mathbf{C}$  and set map  $\psi : X \rightarrow \sigma(A)$ , there exists a unique morphism  $f \in \text{Mor}(F, A)$  such that  $f \circ \varphi = \psi$  as set maps from  $X$  to  $\sigma(A)$ .

**Example 6**  $\mathbf{C} = \mathbf{Ab}$  = category of Abelian groups. Say  $X = \{1, 2\}$ ,  $\sigma(F) = \mathbb{Z} \times \mathbb{Z}$ , i.e.,  $F$  is the Abelian group  $\mathbb{Z} \times \mathbb{Z}$ . Define  $\varphi(1) = (1, 0)$  and  $\varphi(2) = (0, 1)$ . Given  $\psi : X \rightarrow \sigma(A)$ , with  $\psi(1) = a$ ,  $\psi(2) = b$ , define  $f : F \rightarrow A$  by  $f(m, n) = ma + nb$ . Then  $f \circ \varphi = \psi$ ; furthermore, the definition of  $f$  is forced. Roughly speaking,  $F$  is “large enough” so that  $f$  can be defined, while  $F$  is not “too large” so that  $f$  is unique.

One quick definition: If  $\mathbf{C}$  is a category, and  $f \in \text{Mor}(A, B)$ , then  $f$  is an *isomorphism* provided there is a  $g \in \text{Mor}(B, A)$  for which  $fg = i_B$  and  $gf = i_A$ . By the usual trickery,  $g$  is unique: Given just that  $fg' = i_B$ , then  $g' = i_A g' = (gf)g' = g(fg') = gi_B = g$ .

**Theorem 1.3** If  $X$  is a set,  $\mathbf{C}$  is a concrete category, and  $F, F'$  are free on  $X$  (with  $\varphi : X \rightarrow \sigma(F)$ ,  $\varphi' : X \rightarrow \sigma(F')$ ), then  $F$  and  $F'$  are isomorphic.

**Proof:**  $F$  being free,  $\exists f \in \text{Mor}(F, F')$  with  $\varphi' = f \circ \varphi$ .  $F'$  being free,  $\exists g \in \text{Mor}(F', F)$  with  $\varphi = g \circ \varphi'$ . Then  $gf \in \text{Mor}(F, F)$ . Also,  $\varphi = g\varphi' = g(f\varphi) = (gf)\varphi$ . The uniqueness of the map (namely  $i_F$ ) satisfying  $\varphi = h\varphi$  implies that  $gf = i_F$ . Similarly,  $fg = i_{F'}$ .  $\square$

The above can be illustrated by using diagrams, as will usually be done in what follows. A  $\varphi \in \text{Mor}(A, B)$  can be illustrated by an arrow:

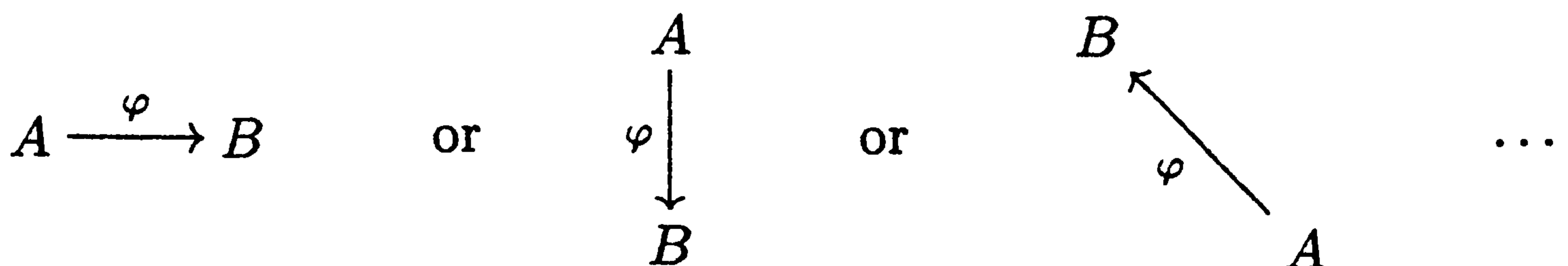

Diagrams assemble such morphisms:

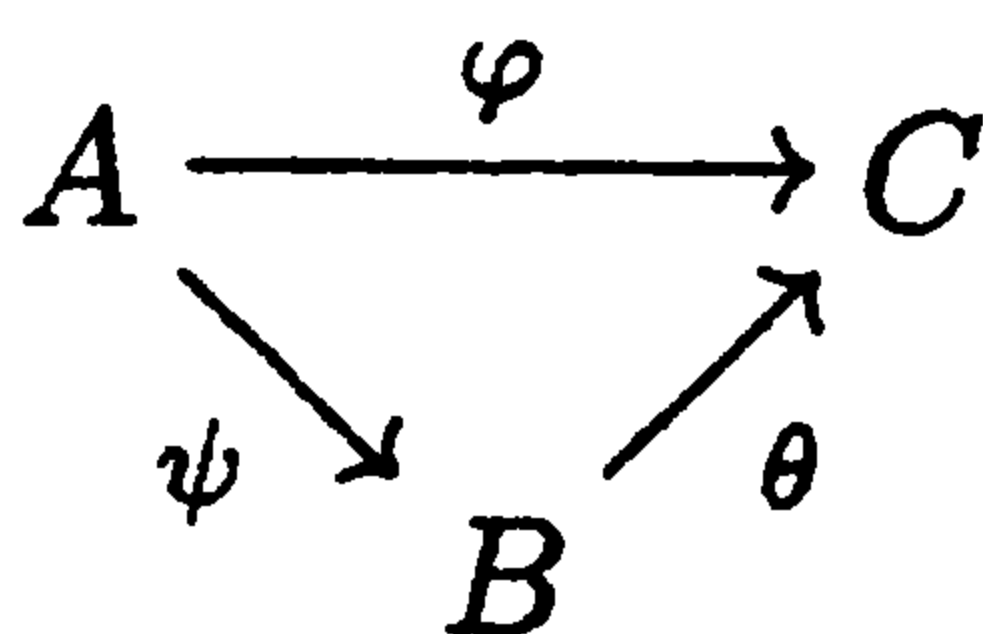

A diagram is *commutative* if any two paths along arrows that start at the same point and finish at the same point yield the same morphism via composition along successive arrows. In the diagram above, two paths lead from  $A$  to  $C$ , the direct one and the indirect one, so commutativity

requires  $\varphi = \theta\psi$ . For example, the commutative diagram associated with the definition of a free object is

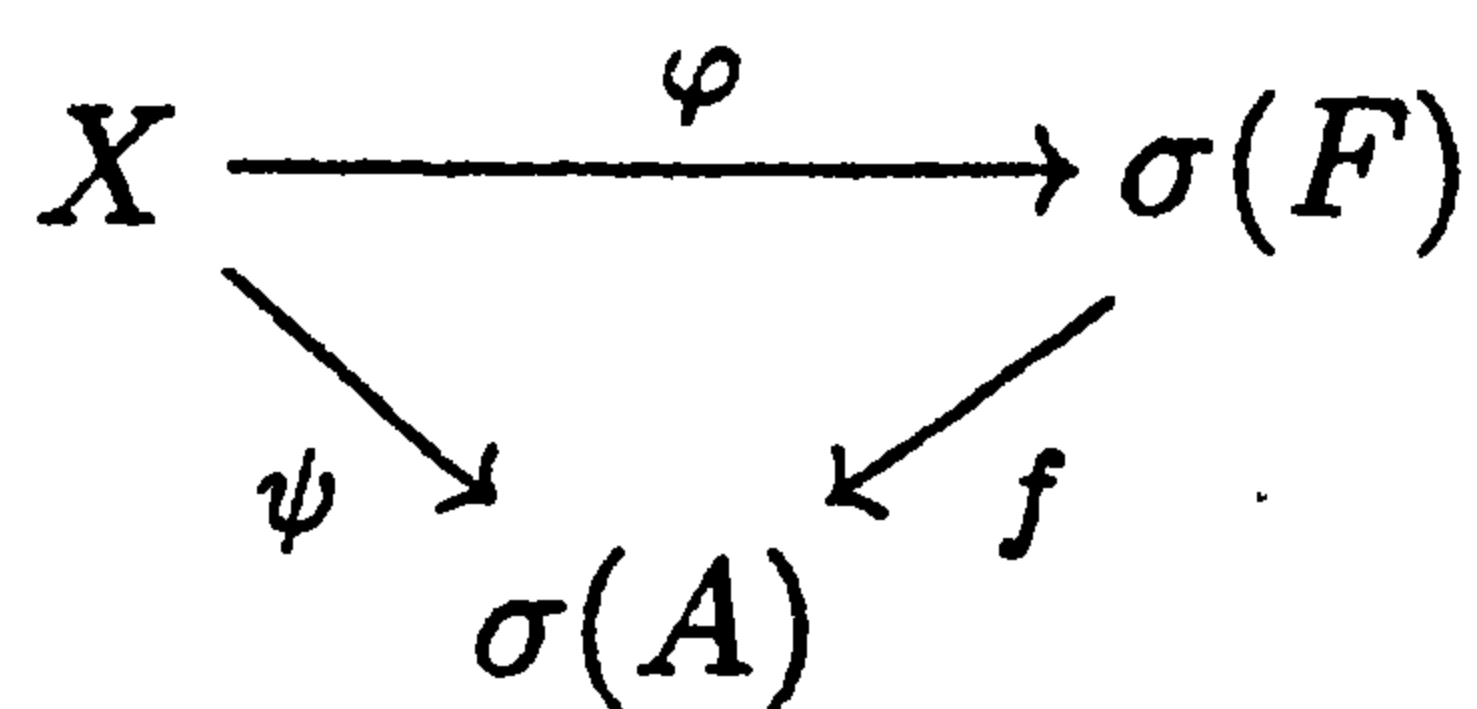

which illustrates the concept more clearly than the prose in the definition.

There may be many paths:

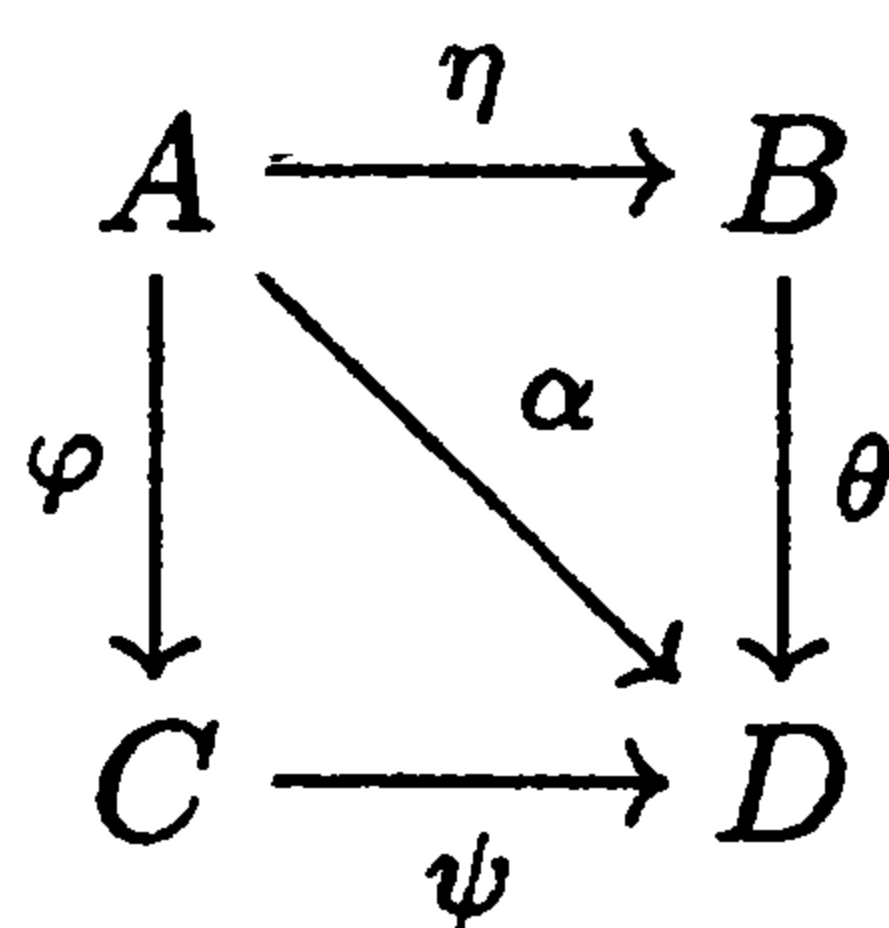

Commutativity requires  $\alpha = \psi\varphi = \theta\eta$ .

There may be many initial and/or final points:

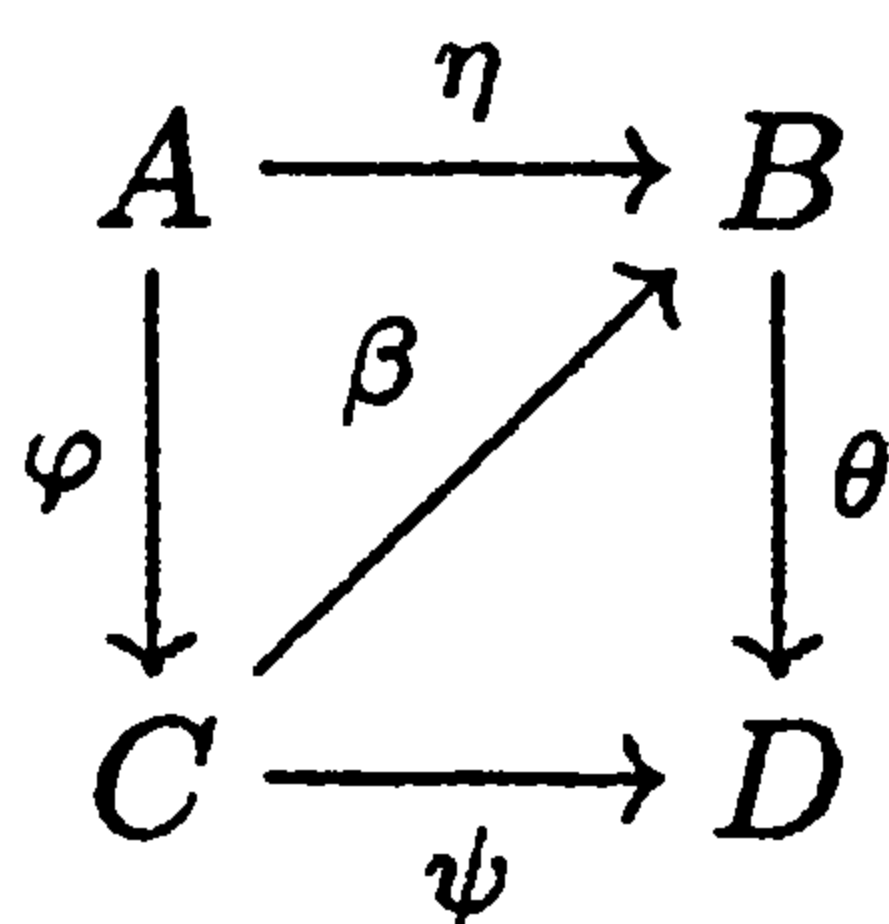

Commutativity requires  $\eta = \beta\varphi$  and  $\psi = \theta\beta$ , as well as  $\theta\eta = \psi\varphi$ . The last follows from the first two:  $\theta\eta = \theta\beta\varphi = \psi\varphi$ . That is, commutativity of the whole diagram follows from commutativity of the two triangles. This phenomenon is common; complicated diagrams are checked for commutativity by checking indecomposable pieces.

Diagrams are so useful that it may (depending on psychological factors more than anything else) be helpful to visualize morphisms as literal arrows.

Suppose  $\{A_i : i \in \mathcal{I}\}$  is an indexed family from  $\text{obj } \mathbf{C}$ . A *product* of the  $A_i$ , written

$$\prod_{i \in \mathcal{I}} A_i$$

is an object  $A$ , together with morphisms  $\pi_i \in \text{Mor}(A, A_i)$  for all  $i \in \mathcal{I}$ , satisfying the following universal property:

If  $B \in \text{obj } \mathbf{C}$ , and  $\psi_i \in \text{Mor}(B, A_i)$  for all  $i \in \mathcal{I}$ , then there is a unique  $\theta \in \text{Mor}(B, A)$  making all the diagrams

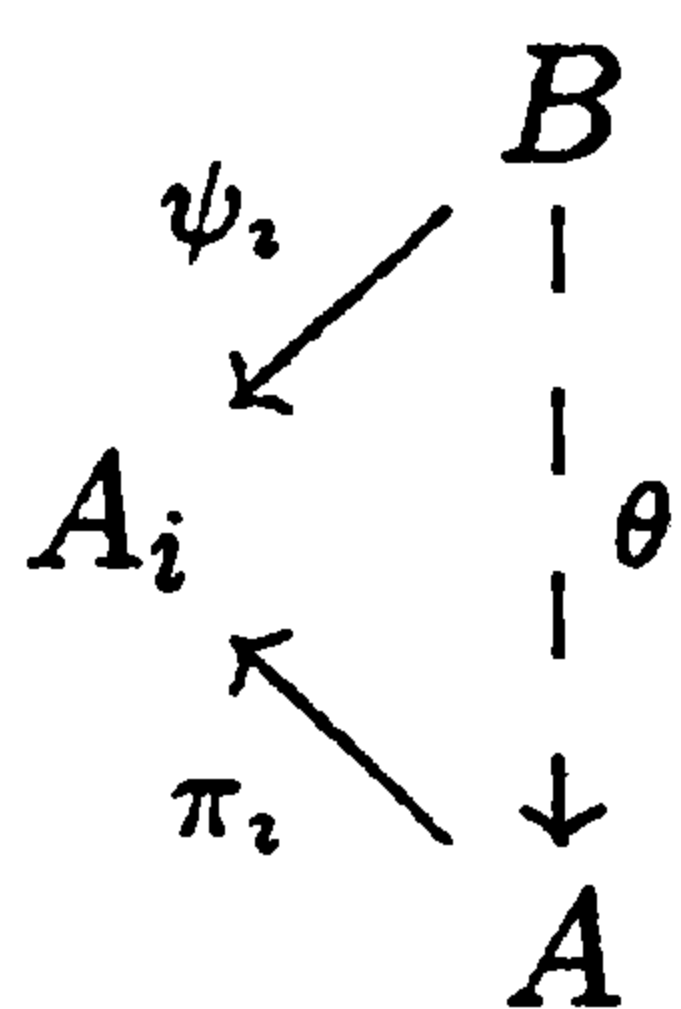



commutative. (A dashed line is used for  $\theta$  to emphasize that its existence is being hypothesized. Such hypothesized morphisms are often called *fillers*. The idea is that a filler extends a diagram in a commutative way.) Roughly speaking, a single morphism into  $\prod A_i$  models a collection of morphisms into the individual  $A_i$  ( $\langle \psi_i \rangle \leftrightarrow \theta$ ); as a target of morphisms,  $\prod A_i$  encapsulates all the  $A_i$ . In **Set**, the ordinary Cartesian product is a category theoretic product, with  $\theta(b) = \langle \psi_i(b) \rangle$ .

The case of only two objects can be illustrated with a single diagram:

$$\begin{array}{ccccc}
 & & B & & \\
 & \swarrow \psi_1 & \downarrow \theta & \searrow \psi_2 & \\
 A_1 & \xleftarrow{\pi_1} & A & \xrightarrow{\pi_2} & A_2
 \end{array}$$

If the indefinite article in the definition of a product worries you, and it should, rest assured. While products are not totally unique, they are as unique as could be hoped for—they are unique up to isomorphism. For if the  $B$  above is also a product, then there is also a unique  $\eta$  making

$$\begin{array}{ccc}
 & A & \\
 & \swarrow \pi_2 & \downarrow \eta \\
 A_i & \xleftarrow{\psi_i} & B \\
 & \swarrow \pi_2 & \downarrow \theta \\
 & A &
 \end{array}$$

commutative, whence

$$\begin{array}{ccc}
 & A & \\
 & \swarrow \pi_2 & \downarrow \theta\eta \\
 A_i & \xleftarrow{\pi_2} & A
 \end{array}$$

is commutative. Uniqueness implies that  $\theta\eta = i_A$ . Similarly  $\eta\theta = i_B$ .

The above is an example of a universal mapping construction; in general, there are morphisms between some of the  $A_i$ . There may even be noncategorical things, like the bilinear maps used to define tensor products. The idea behind uniqueness is the same, however, and such objects are unique up to isomorphism when the recipe allows the above argument to work. Here it is more important to understand the principle than to have a general theorem stated.

*Coproducts* are just products on the opposite category. The coproduct of  $A_i$  is an  $A$ , together with  $\varphi_i \in \text{Mor}(A_i, A)$ . The diagrams that must

commute are

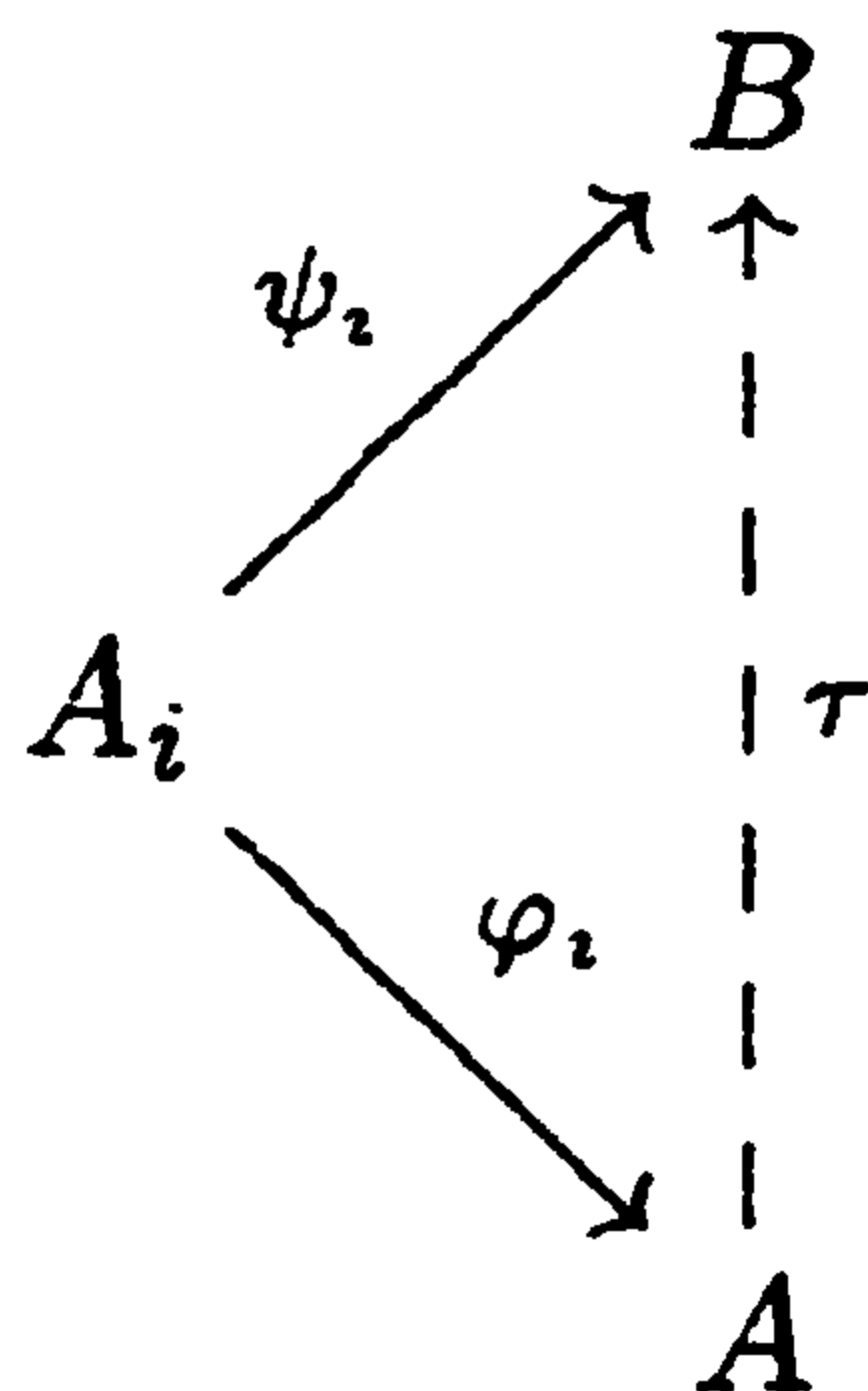

The coproduct of the  $A_i$  incorporates all the  $A_i$  collectively as far as tails of arrows are concerned ( $\langle \psi_i \rangle \leftrightarrow \tau$ ). The coproduct in **Set** is the disjoint union. That is, one defines

$$A = \bigcup_{i \in I} \{i\} \times A_i$$

and  $\varphi_i(a_i) = (i, a_i)$ .

The coproduct in **Ab** is the direct sum. (Coproducts are sometimes called direct sums, especially in older books. The term coproduct has largely taken over.)

**AN EXERCISE:** Show that if  $A$  is free on a set  $S$  in **Ab**, with map  $\Phi : S \rightarrow A$ , then  $A$  is also a coproduct of  $|S|$  copies of  $\mathbb{Z}$ , where each  $\varphi_x : \mathbb{Z} \rightarrow A$  is given by  $\varphi_x(n) = n \cdot \Phi(x)$  ( $x \in S$ ). That is, given  $B \in \text{obj Ab}$ , and  $\psi_x : \mathbb{Z} \rightarrow B$ , ... Do all this as categorically as possible.

One last gadget from general category theory: A (covariant) *functor*  $F$  from **C** to **D** is a function from  $\text{obj C}$  to  $\text{obj D}$ , also called  $F$ , as well as functions (also called  $F$ ) from  $\text{Mor}_{\mathbf{C}}(A, B)$  to  $\text{Mor}_{\mathbf{D}}(F(A), F(B))$ , that satisfy

- i)  $F(i_A) = i_{F(A)}$
- ii)  $F(\varphi\psi) = F(\varphi)F(\psi)$  if  $\varphi \in \text{Mor}_{\mathbf{C}}(B, C)$ ,  $\psi \in \text{Mor}_{\mathbf{C}}(A, B)$ .

Here is one place where requiring the morphism sets to be disjoint alleviates confusion. If they are not disjoint, then the functor is, on the morphism sets, an *amalgamation* of functions, one for each pair of objects.

A *contravariant* functor from **C** to **D** is literally a covariant functor from **C** to **D**<sup>op</sup>. That is, if  $\varphi \in \text{Mor}_{\mathbf{C}}(A, B)$ , then  $F(\varphi) \in \text{Mor}_{\mathbf{D}}(F(B), F(A))$ . Rules (i) and (ii) above apply, suitably modified. A *functor* is defined as either a covariant functor or a contravariant functor.

**Example 7**  $\mathbf{C} = \mathbf{Gr}$ ,  $\mathbf{D} = \mathbf{Ab}$ .  $F(G) = G/G'$ ,  $G'$  = commutator subgroup of  $G$ . If  $\varphi \in \text{Mor}(G, H)$ , then  $\varphi(G') \subset H'$ , so  $\varphi$  induces a homomorphism  $F(\varphi)$  from  $G/G'$  to  $H/H'$ .

**Example 8**  $\mathbf{C}$  = category of rings,  $\mathbf{D} = \mathbf{Ab}$ .  $F((R, +, \cdot)) = (R, +)$ .  $F(\varphi) = \varphi$ . This is sometimes called a *forgetful functor*; it “forgets” that  $R$  is a ring by filtering out all but the underlying additive group.

Roughly speaking, functors play the role in category theory that morphisms play in individual categories. In fact, one may define a category  $\mathbf{Sm}$  of *small* categories, that is, categories  $\mathbf{C}$  such that  $\text{obj } \mathbf{C}$  is actually a set. Since

$$\text{obj } \mathbf{C} \times \text{obj } \mathbf{C} \rightarrow \text{all sets} \quad (A, B) \mapsto \text{Mor}(A, B)$$

is a function, the collection of all  $\text{Mor}(A, B)$  so obtained is a set by the class-theoretic version of the axiom of replacement: If the domain of a function is a set, then its range is a set. Finally, morphisms of  $\mathbf{Sm}$  are functors (or, in more restrictive versions of this, covariant functors.)

Two final definitions: If  $\mathbf{C}$  and  $\mathbf{D}$  are categories, then  $\mathbf{C}$  is a *subcategory* of  $\mathbf{D}$  if  $\text{obj } \mathbf{C} \subset \text{obj } \mathbf{D}$ , and if for all  $A, B \in \text{obj } \mathbf{C}$ ,  $\text{Mor}_{\mathbf{C}}(A, B) \subset \text{Mor}_{\mathbf{D}}(A, B)$ . (One also requires that identity morphisms from  $\mathbf{C}$  coincide with identity morphisms from  $\mathbf{D}$ .) If the last set containment is always an equality, then  $\mathbf{C}$  is called a *full* subcategory of  $\mathbf{D}$ . For example,  $\mathbf{Ab}$  is a full subcategory of  $\mathbf{Gr}$ . The category of rings with unit is (ordinarily) not a full subcategory of the category of rings, since zero homomorphisms are allowed in the latter but not the former.

## Appendix

Suppose  $\mathbf{C}$  is a concrete category. Also assume  $\mathbf{C}$  is “uniform”, in that: If  $A \in \text{obj } \mathbf{C}$ ,  $S$  is a set, and  $\varphi : \sigma(A) \rightarrow S$  is a bijective function, then there exists  $B \in \text{obj } \mathbf{C}$  such that  $\sigma(B) = S$ , and  $\varphi$  is an isomorphism of  $A$  with  $B$ . (That is,  $\varphi \in \text{Mor}(A, B)$  and  $\varphi^{-1} \in \text{Mor}(B, A)$ .) In words, an isomorphic copy of  $A$  can be manufactured from any set  $S$  which is in one-to-one correspondence with  $\sigma(A)$ . (Note: This definition is not standard.)

Most familiar categories are concrete and uniform, but not all: If  $F$  is a field, then the category of extension fields is a concrete category, but no extension field can be manufactured from the set  $S$  unless  $F \subset S$  and  $\varphi$  is the identity on  $F$ .

The theorem below shows how to make an object be a literal subobject of another object. It will be called the Pulltab Theorem, for lack of a better name.

**Theorem 1.4** *Suppose  $\mathbf{C}$  is a concrete, uniform category. Suppose  $A, B \in \text{obj } \mathbf{C}$ , and  $f \in \text{Mor}(A, B)$ . Suppose that, as a map from  $\sigma(A)$  to  $\sigma(B)$ ,  $f$  is one-to-one. Then there exists  $C \in \text{obj } \mathbf{C}$ , as well as  $g \in \text{Mor}(A, C)$ ,  $h \in \text{Mor}(C, B)$ , such that  $f = hg$ , and*

*i)  $h$  is an isomorphism of  $C$  with  $B$ .*

*ii)  $\sigma(A) \subset \sigma(C)$ , and  $g(x) = x$  for all  $x \in \sigma(A)$  (that is,  $g : A \rightarrow C$  is set inclusion).*

**Discussion:** In words, this says that any one-to-one morphism is set inclusion into a larger object followed by an isomorphism. Applications are legion; here are two.  $\mathbf{C}$  = metric spaces; morphisms are isometries.  $A$  = any object,  $B$  = usual construction of the completion, and  $f$  = usual imbedding.  $C$  is a completion which has  $A$  as a literal subspace. Another:  $\mathbf{C}$  = fields,  $A$  = a field,  $p(x)$  is an irreducible polynomial in  $A[x]$ ,  $B = A[x]/(p(x))$ , and  $f$  = usual imbedding. Then  $C$  is a literal extension of  $A$  in which  $p(x)$  has a root.

**Proof:** Let  $S'$  be a set which is disjoint from  $\sigma(A)$ , and  $\varphi'$  a bijection from  $\sigma(B)$  to  $S'$ . (Such a pair  $(S', \varphi')$  exists with  $S'$  inside the power set of  $\sigma(A) \cup \sigma(B)$  for reasons of cardinality.) Define a set  $S$  and  $\varphi : \sigma(B) \rightarrow S$ , as follows:

$$\begin{aligned} S &= [S' \sim \varphi'(f(\sigma(A)))] \cup \sigma(A) \\ &= \varphi'(\sigma(B) \sim f(\sigma(A))) \cup \sigma(A) \\ \varphi(y) &= \begin{cases} x, & \text{if } y = f(x) \text{ for some } x \in \sigma(A) \\ \varphi'(y), & \text{if } y \notin f(\sigma(A)) \end{cases} \end{aligned}$$

(Roughly speaking, we “pull” the “copy”  $\varphi'(f(\sigma(A)))$  of  $\sigma(A)$  out of  $S'$  and replace it with  $\sigma(A)$ .)

Note that  $\varphi$  is a bijection, since it is a bijection from  $f(\sigma(A))$  to  $\sigma(A)$  (namely  $f^{-1}$ ), and from  $\sigma(B) \sim f(\sigma(A))$  to  $S' \sim \varphi'(f(\sigma(A)))$  (namely  $\varphi'$ ); further, the two target sets are disjoint.

Let  $C$  be an object with  $\sigma(C) = S$ , and  $h^{-1} = \varphi \in \text{Mor}(B, C)$ . Let  $g = h^{-1}f$ . Then  $hg = hh^{-1}f = f$ .  $h$  is an isomorphism by construction. By definition,  $\varphi$  “undoes” what  $f$  does on  $f(\sigma(A))$ , so  $g(x) = \varphi f(x) = x$  for  $x \in \sigma(A)$ .  $\square$

One final comment. One might expect that in a concrete, uniform category, the object  $C$  would be unique. The following example shows that this isn't so.

Let  $\mathbf{C}$  be the category of “hairy” sets:  $H$  is a class with at least two elements (types of hair), and  $\mathbf{C}$  consists of all ordered pairs  $(A, h)$ , where  $A$  is a set and  $h \in H$ . The morphisms from  $(A, h)$  to  $(B, h')$  are just functions from  $A$  to  $B$ .  $\mathbf{C}$  is a concrete, uniform category with  $\sigma((A, h)) = A$ . There are different objects  $B$  and  $C$  (with different hair) for which  $\sigma(B) = \sigma(C)$ , and for which the identity function is an isomorphism. (By the way, the term “hair” was borrowed from physicists who specialize in general relativity.)



# 2

## Modules

### 2.1 Generalities

In what follows, *all rings will be assumed to possess a unit element, and all modules will be assumed to be unitary.* We shall use the following notation, with  $R$  (or  $S$ ) being a ring:

- ${}_R\mathbf{M}$  = category of left  $R$ -modules,
- $\mathbf{M}_R$  = category of right  $R$ -modules,
- ${}_R\mathbf{M}_S$  = category of  $R - S$  bimodules.

Abusing notation, “ $A \in {}_R\mathbf{M}$ ” will mean “ $A$  is a left  $R$ -module.” That is, we won’t be writing “ $(A, +, \cdot) \in \text{obj } {}_R\mathbf{M}$ , with  $\sigma((A, +, \cdot)) = A$ .” The phrase “ $A \in {}_R\mathbf{M}$ ” is the shorthand used in most of mathematics. Note that if  $R$  is commutative, then  ${}_R\mathbf{M}$  and  $\mathbf{M}_R$  are isomorphic in an obvious way; also  ${}_Z\mathbf{M}$  is isomorphic to  $\mathbf{Ab}$ . They aren’t quite the same since they start with different internal structures. (For example, in the first case, on  ${}_R\mathbf{M}$ , the multiplication is defined on  $R \times A$  for an  $R$ -module  $A$ , while on  $\mathbf{M}_R$  it is defined on  $A \times R$ .)

Recall some of the standard constructions:

- i) Direct products: If  $A_i$  is an indexed family in  ${}_R\mathbf{M}$ ,  $i \in \mathcal{I}$ , then

$$\prod_{i \in \mathcal{I}} A_i$$

can be defined as the set of all  $\mathcal{I}$ -tuples  $\langle a_i \rangle$  with  $a_i \in A_i$ . That is, an element of the product is a function  $i \mapsto a_i$  such that  $a_i \in A_i$ . Note

that direct products are products in the category  ${}_R\mathbf{M}$ . The same construction works in  $\mathbf{M}_R$  and  ${}_R\mathbf{M}_S$ .

ii) Direct sums: If  $A_i$  is an indexed family in  ${}_R\mathbf{M}$ ,  $i \in \mathcal{I}$ , then

$$\bigoplus_{i \in \mathcal{I}} A_i$$

can be defined as those elements  $\langle a_i \rangle$  in the direct product for which  $\{i \in \mathcal{I} : a_i \neq 0\}$  is finite. Note that direct sums are coproducts in  ${}_R\mathbf{M}$ . The same construction works in  $\mathbf{M}_R$  and  ${}_R\mathbf{M}_S$ .

iii) Free modules: If  $\mathcal{I}$  is any set, then

$$\bigoplus_{i \in \mathcal{I}} R$$

serves as a free module on the set  $\mathcal{I}$ . The same construction works in  $\mathbf{M}_R$ , but not in  ${}_R\mathbf{M}_S$ .

The product and coproduct of two objects in  ${}_R\mathbf{M}$  are the same, and this is no accident. One has diagrams, for  $A = A_1 \times A_2$

$$A_1 \xleftarrow{\pi_1} A \xrightarrow{\pi_2} A_2 \qquad A_1 \xrightarrow{\varphi_1} A \xleftarrow{\varphi_2} A_2$$

satisfying  $\pi_1\varphi_1 = i_{A_1}$ ,  $\pi_2\varphi_2 = i_{A_2}$ , and  $\varphi_1\pi_1 + \varphi_2\pi_2 = i_A$ . Such an  $A$  is often called a *biproduct*. From this alone,  $A$  is both a product and a coproduct.

**Proposition 2.1** Suppose  $A_1, A_2, A \in {}_R\mathbf{M}$ , and suppose

$$A_1 \xleftarrow{\pi_1} A \xrightarrow{\pi_2} A_2 \qquad A_1 \xrightarrow{\varphi_1} A \xleftarrow{\varphi_2} A_2$$

are morphisms satisfying  $\pi_1\varphi_1 = i_{A_1}$ ,  $\pi_2\varphi_2 = i_{A_2}$ , and  $\varphi_1\pi_1 + \varphi_2\pi_2 = i_A$ . Then  $\varphi_2\pi_1 = 0$ ,  $\varphi_1\pi_2 = 0$ , and  $A$  is both a product and a coproduct of  $A_1$  and  $A_2$ .

**Proof:**  $\varphi_1 = i_A\varphi_1 = (\varphi_1\pi_1 + \varphi_2\pi_2)\varphi_1 = \varphi_1\pi_1\varphi_1 + \varphi_2\pi_2\varphi_1$   
 $= \varphi_1 i_{A_1} + \varphi_2\pi_2\varphi_1 = \varphi_1 + \varphi_2\pi_2\varphi_1.$

Hence  $\varphi_2\pi_2\varphi_1 = 0$ , so  $0 = \pi_2\varphi_2\pi_2\varphi_1 = i_{A_2}\pi_2\varphi_1 = \pi_2\varphi_1$ .  $\pi_1\varphi_2 = 0$  by a similar argument.

Now suppose  $B \in {}_R\mathbf{M}$ , and  $\psi_i : A_i \rightarrow B$  are given. If  $\theta : A \rightarrow B$  makes

$$\begin{array}{ccccc} A_1 & \xrightarrow{\varphi_1} & A & \xleftarrow{\varphi_2} & A_2 \\ & \searrow \psi_1 & \downarrow \theta & \swarrow \psi_2 & \\ & & B & & \end{array}$$



commute, then

$$\theta = \theta i_A = \theta(\varphi_1\pi_1 + \varphi_2\pi_2) = \theta\varphi_1\pi_1 + \theta\varphi_2\pi_2 = \psi_1\pi_1 + \psi_2\pi_2.$$

But, in fact, this works. Setting  $\theta = \psi_1\pi_1 + \psi_2\pi_2$  gives  $\theta\varphi_1 = (\psi_1\pi_1 + \psi_2\pi_2)\varphi_1 = \psi_1\pi_1\varphi_1 + \psi_2\pi_2\varphi_1 = \psi_1i_{A_1} + 0 = \psi_1$ , and (similarly)  $\theta\varphi_2 = \psi_2$ . This shows that  $A$  is a coproduct (with unique filler  $\psi_1\pi_1 + \psi_2\pi_2$ ).

Finally, suppose  $B \in {}_R\mathbf{M}$ , and  $\rho_i : B \rightarrow A_i$  are given. If  $\eta : B \rightarrow A$  makes

$$\begin{array}{ccccc} & & A_1 & \xleftarrow{\pi_1} & A & \xrightarrow{\pi_2} & A_2 \\ & & \swarrow & & \uparrow & & \searrow \\ & & \rho_1 & & \eta & & \rho_2 \\ & & & & B & & \end{array}$$

commute, then

$$\eta = i_A\eta = (\varphi_1\pi_1 + \varphi_2\pi_2)\eta = \varphi_1\pi_1\eta + \varphi_2\pi_2\eta = \varphi_1\rho_1 + \varphi_2\rho_2.$$

As before, setting  $\eta = \varphi_1\rho_1 + \varphi_2\rho_2$  works; details are left to the reader.  $\square$

Two operations are fundamental to homological algebra: the formation of homomorphism groups, and the taking of tensor products. The former is probably more familiar. If  $A, B \in {}_R\mathbf{M}$  (or  $\mathbf{M}_R$ ), let  $\text{Hom}(A, B)$  (or  $\text{Hom}_R(A, B)$  if  $R$  is to be emphasized) denote the group of module homomorphisms from  $A$  to  $B$ . It is an Abelian group, with the group operation inherited from  $B$ . Note that our notation-reducing conventions substitute  $\text{Hom}_R(A, B)$  for

$$(\text{Mor}_{{}_R\mathbf{M}}((A, +, \cdot), (B, +, \cdot)), +).$$

$\text{Hom}$  is used in place of  $\text{Mor}$  to emphasize the fact that it is an Abelian group. Furthermore, of fundamental importance is

*For each fixed  $A \in {}_R\mathbf{M}$ ,  $\text{Hom}(A, \bullet)$  is a covariant functor from  ${}_R\mathbf{M}$  to  $\mathbf{Ab}$ , and  $\text{Hom}(\bullet, A)$  is a contravariant functor from  ${}_R\mathbf{M}$  to  $\mathbf{Ab}$ .*

Functoriality comes from observing that, given  $\psi \in \text{Hom}(B, C)$ , we can define

$$\begin{aligned} \psi_* : \text{Hom}(A, B) &\rightarrow \text{Hom}(A, C) \\ \psi_*(f) &= \psi f, \end{aligned}$$

as well as

$$\begin{aligned} \psi^* : \text{Hom}(C, A) &\rightarrow \text{Hom}(B, A) \\ \psi^*(f) &= f\psi. \end{aligned}$$

In functorial notation,  $\text{Hom}(A, \psi) = \psi_*$ , while  $\text{Hom}(\psi, A) = \psi^*$ . A routine mess checks that these are functors. For example, if  $\theta \in \text{Hom}(C, D)$ , then  $(\theta\psi)^*(f) = f\theta\psi = (\theta^*f)\psi = \psi^*(\theta^*f)$ .

The above has been carried out for  ${}_R\mathbf{M}$ ; similar considerations hold for  $\mathbf{M}_R$ .

Bimodules enter in when noting that, if  $A \in {}_R\mathbf{M}_S$ , then  $\text{Hom}_R(A, \bullet)$  can be considered as a functor from  ${}_R\mathbf{M}$  to  ${}_S\mathbf{M}$ , while  $\text{Hom}_R(\bullet, A)$  can be considered as a functor from  ${}_R\mathbf{M}$  to  $\mathbf{M}_S$ :

Given  $f \in \text{Hom}_R(A, B)$ , set  $(s \cdot f)(a) = f(as)$ , and given  $g \in \text{Hom}_R(B, A)$ , set  $(g \cdot s)(b) = g(b) \cdot s$ .

These are on the correct side:

$$(s \cdot (s' \cdot f))(a) = (s' \cdot f)(as) = f((as) \cdot s') = f(a \cdot ss') = (ss' \cdot f)(a),$$

and

$$((g \cdot s) \cdot s')(b) = [(g \cdot s)(b)] \cdot s' = [g(b) \cdot s] \cdot s' = g(b) \cdot ss' = (g \cdot ss')(b).$$

Of later use: If  $A \in \mathbf{M}_S \approx {}_Z\mathbf{M}_S$  and  $G \in \mathbf{Ab} \approx {}_Z\mathbf{M}$ , then  $\text{Hom}_Z(A, G)$  can be viewed in  ${}_S\mathbf{M}$ .

Finally, we note the behavior of  $\text{Hom}(\bullet, B)$  and  $\text{Hom}(A, \bullet)$  under products/coproducts:

$$\text{Hom}(A, \Pi B_i) \approx \Pi \text{Hom}(A, B_i),$$

and

$$\text{Hom}(\oplus A_i, B) \approx \Pi \text{Hom}(A_i, B).$$

These isomorphisms can be directly verified from the constructions. They can also be verified from the universal properties. (See Exercise 3 at the end of this chapter.)

## 2.2 Tensor Products

Suppose  $A \in \mathbf{M}_R$  and  $B \in {}_R\mathbf{M}$ . A *bilinear map* from  $A \times B$  to  $G \in \mathbf{Ab}$  is a map  $\varphi : A \times B \rightarrow G$  satisfying, for all  $a, a' \in A$ ;  $b, b' \in B$ ; and  $r \in R$ ; the identities

$$\text{i) } \varphi(a, b + b') = \varphi(a, b) + \varphi(a, b'),$$

$$\text{ii) } \varphi(a + a', b) = \varphi(a, b) + \varphi(a', b),$$

$$\text{iii) } \varphi(ar, b) = \varphi(a, rb).$$

A pair  $(G, \varphi)$  is a *tensor product* of  $A$  and  $B$  if, for all  $H \in \mathbf{Ab}$ , and all bilinear maps  $\psi : A \times B \rightarrow H$ , there is a unique  $\theta \in \text{Hom}(G, H)$  making

$$\begin{array}{ccc} & & G \\ & \nearrow \varphi & | \\ A \times B & & | \theta \\ & \searrow \psi & | \\ & & H \end{array}$$

commutative. This is the solution of a universal mapping problem having multiple categories involved, but the uniqueness-up-to-isomorphism result holds.

We do need two things: (i) the fact that tensor products exist, and (ii) a specific tensor product of  $A$  and  $B$  (so that we do not need to deal with isomorphism classes of Abelian groups, which are proper classes that cannot be made members of any class). The construction of a tensor product takes care of both at once.

Let  $F$  be the free Abelian group (i.e.,  $\mathbb{Z}$ -module) on  $A \times B$  as constructed in Section 2.1, that is,

$$F = \bigoplus_{A \times B} \mathbb{Z}.$$

By  $1_{a,b}$  we denote the element of  $F$  whose value at  $(a', b')$  is one if  $a = a'$  and  $b = b'$ , but zero otherwise. Note that the map  $(a, b) \mapsto 1_{a,b}$ , which will be denoted by  $i$ , is exactly the map from  $A \times B$  to  $F$  which specifies  $F$  as a free Abelian group on  $A \times B$ . Let  $H$  be the subgroup of  $F$  generated by all

$$\begin{aligned} &1_{a,b} + 1_{a',b} - 1_{a+a',b}, \\ &1_{a,b} + 1_{a,b'} - 1_{a,b+b'}, \\ &1_{ar,b} - 1_{a,rb}. \end{aligned}$$

Write  $A \otimes B$  (or  $A \otimes_R B$  if  $R$  is to be emphasized) for the quotient  $F/H$ . Write  $a \otimes b$  for the coset of  $1_{a,b}$  in  $A \otimes B = F/H$ . Set  $\varphi(a, b) = a \otimes b$ . The generators of  $H$  guarantee that

$$\begin{aligned} (a + a') \otimes b &= a \otimes b + a' \otimes b, \\ a \otimes (b + b') &= a \otimes b + a \otimes b', \\ ar \otimes b &= a \otimes rb. \end{aligned}$$

That is,  $\varphi$  is a bilinear map from  $A \times B$  to  $A \otimes B$ . It remains to show that  $A \otimes B$  is a tensor product.

Suppose  $\psi : A \times B \rightarrow G \in \mathbf{Ab}$  is bilinear. There is a unique  $\eta \in \text{Hom}(F, G)$  making

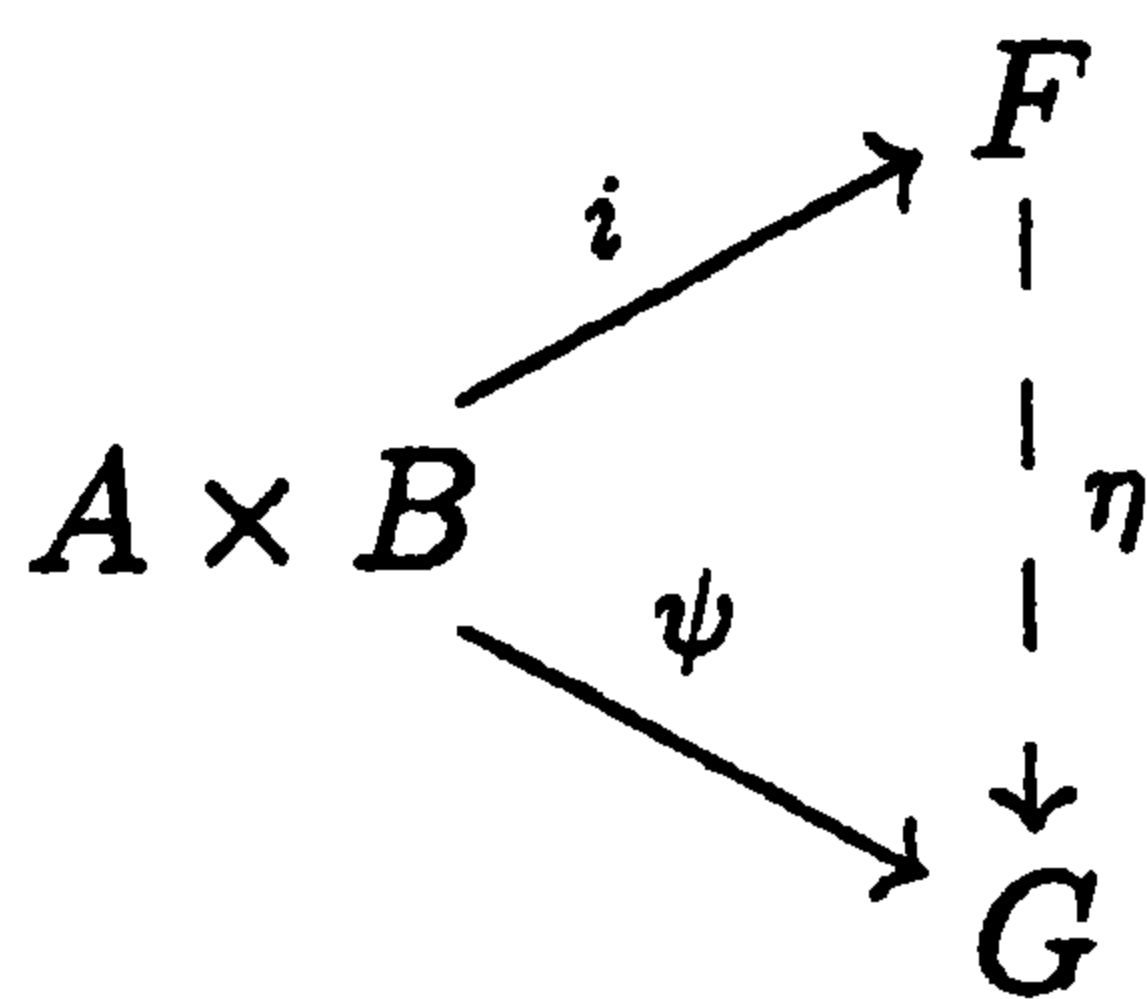

commutative, from the definition of  $F$  as a free Abelian group. Thus,  $\psi(a, b) = \eta(1_{a,b})$ . But now bilinearity of  $\psi$ , along with commutativity of the diagram, guarantee that  $\eta$  will vanish on each generator of  $H$ , so  $\eta$  induces a map  $\theta$  making

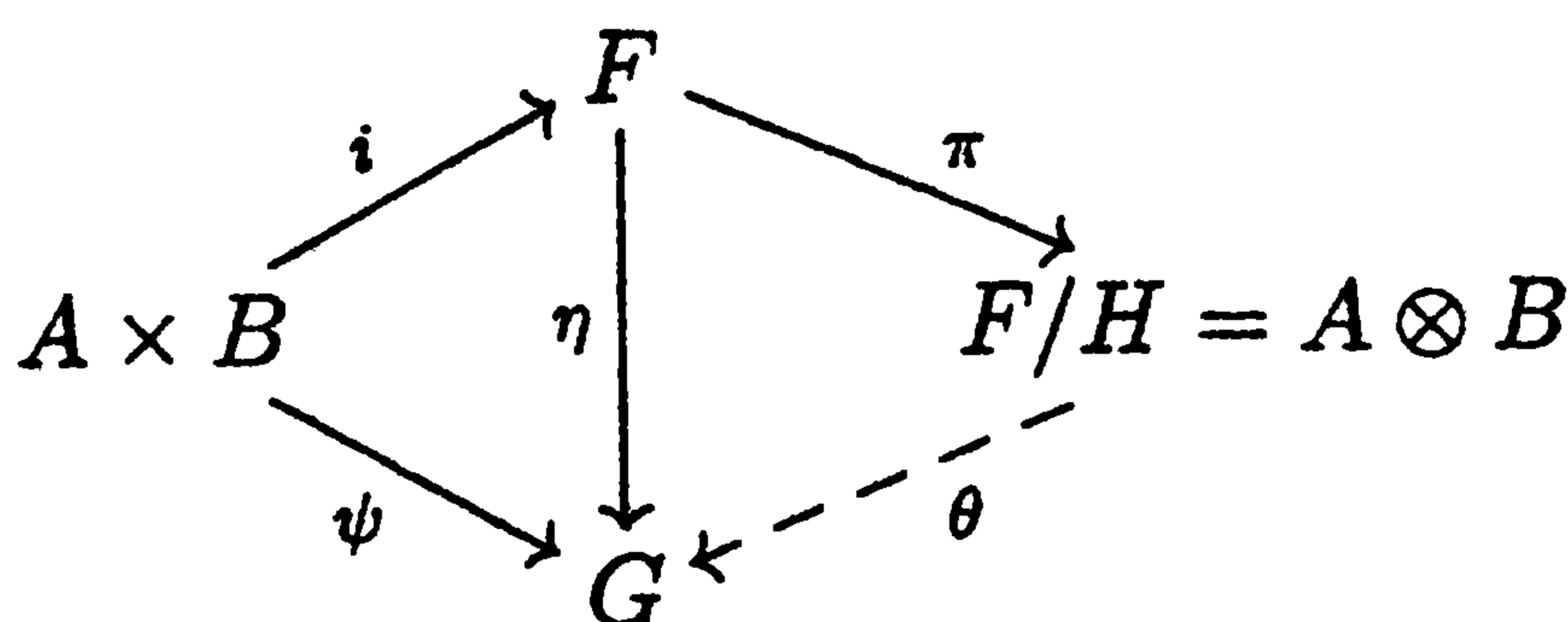

commutative. Finally, this  $\theta$  is unique in making

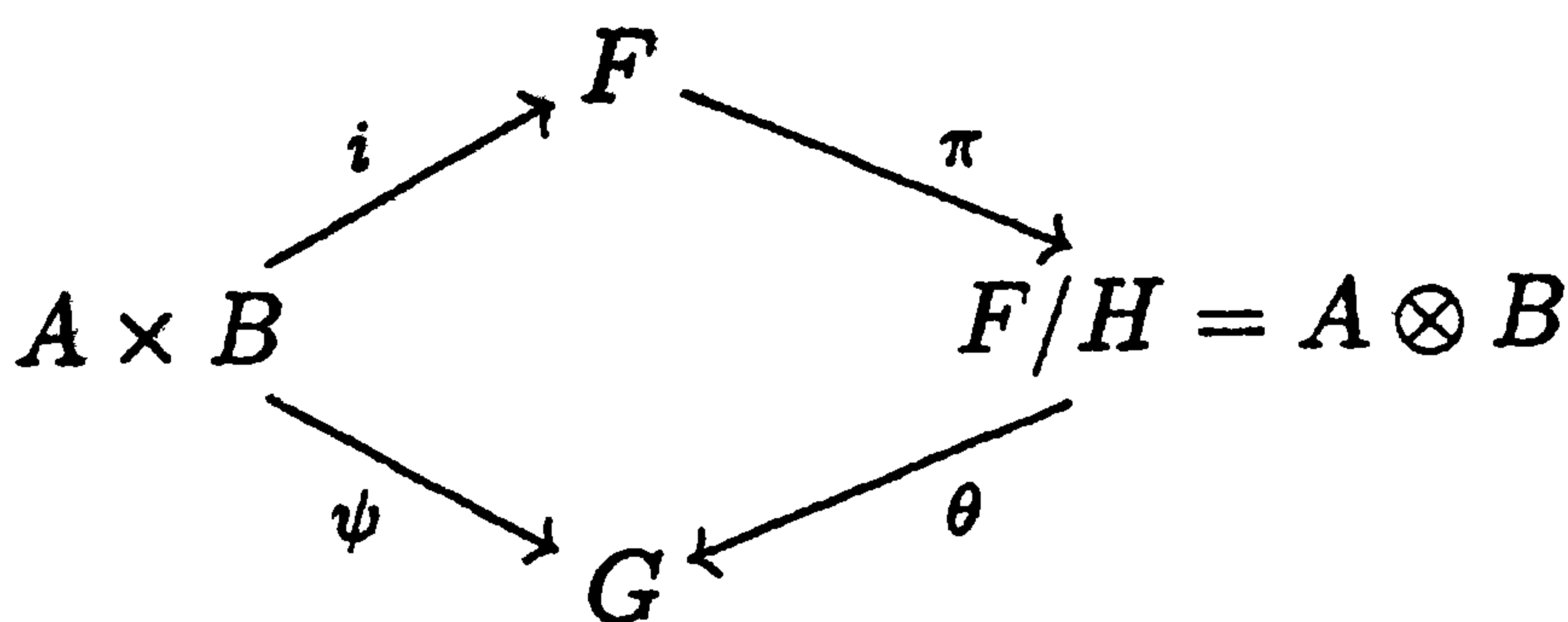

commutative, which is equivalent to commutativity of

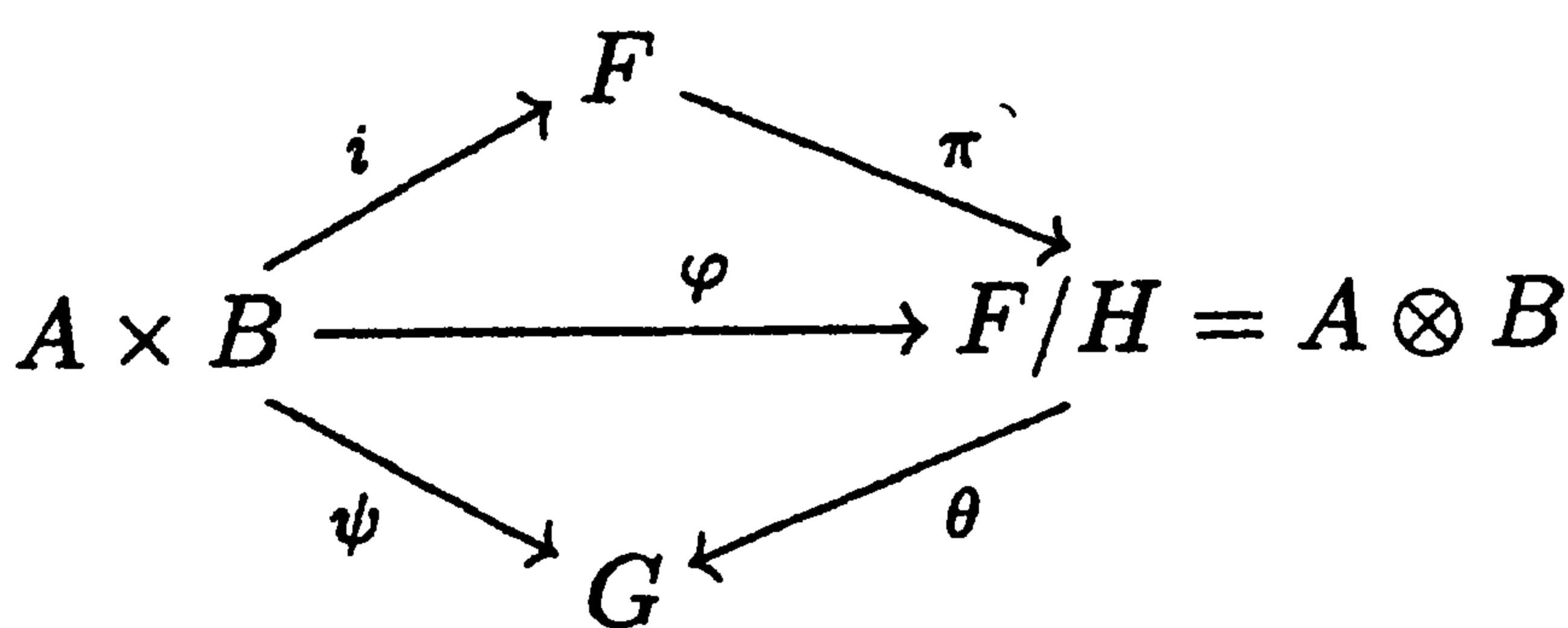

by commutativity of the top triangle:  $\theta\varphi = \theta\pi i = \psi$ . If, in fact,  $\theta'\varphi = \psi$ , then  $\theta'\pi i = \theta'\varphi = \psi = \theta\pi i = \eta i \Rightarrow \theta'\pi = \eta$  by uniqueness in the diagram

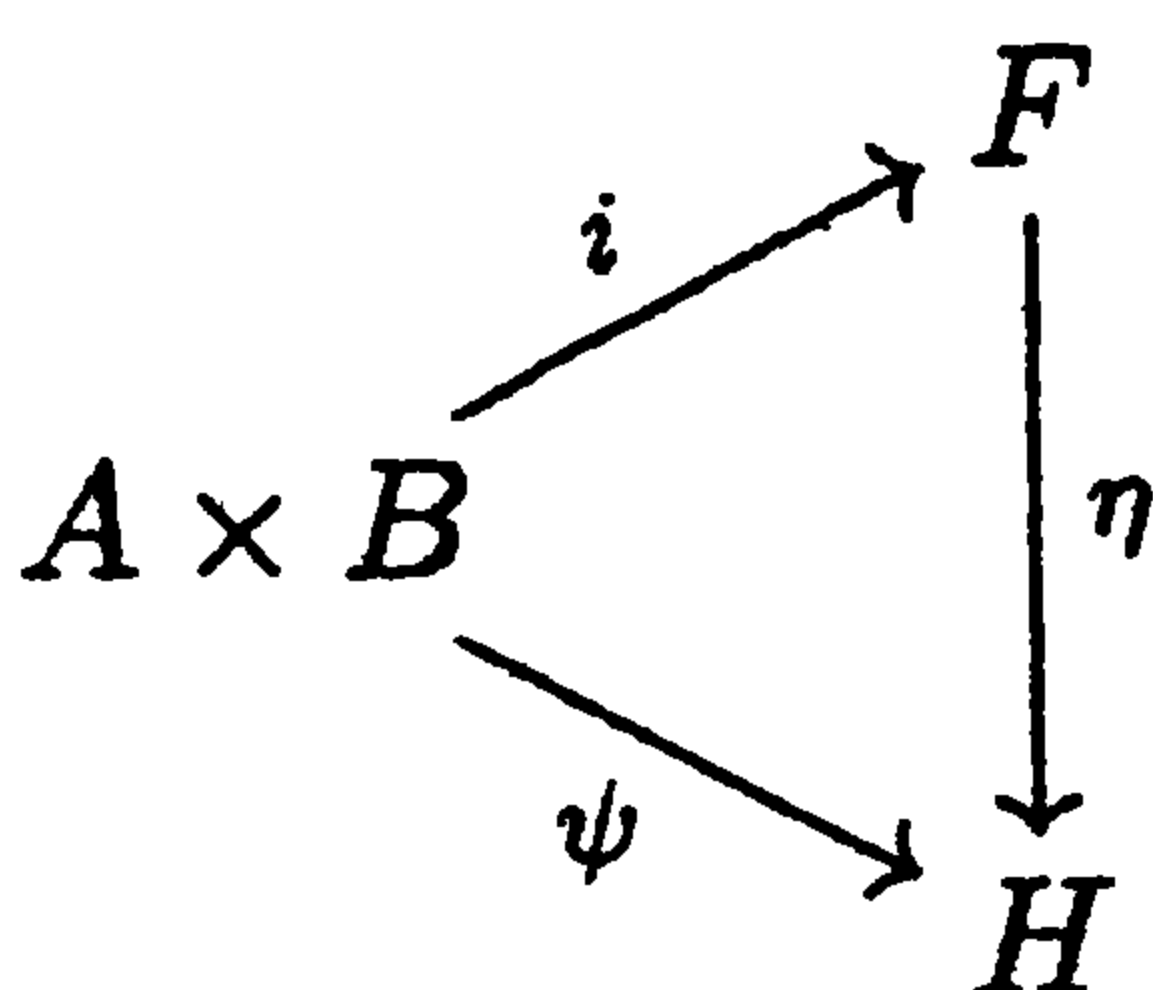

so  $\theta'\pi = \eta = \theta\pi \Rightarrow \theta' = \theta$ , since  $\pi$  is onto. Hence,  $\theta$  is unique.

This is how the tensor product is constructed, but the universal mapping property actually computes the typical tensor product (since  $F$  is, to put it mildly, huge).

**Proposition 2.2** *Suppose  $B \in {}_R\mathbf{M}$ .*

- a)  $R \otimes B \approx B$  as Abelian groups.
- b)  $(R/I) \otimes B \approx B/IB$  if  $I$  is a right ideal, and  $IB$  is the subgroup of  $B$  generated by all  $rb$ ,  $r \in I$ ,  $b \in B$ .

**Proof:** (a) We show  $B$  is a tensor product of  $R$  with  $B$ . Set  $\varphi(r, b) = rb$ .  $\varphi$  is bilinear from  $R \times B$  to  $B$ . Suppose  $\psi$  is bilinear from  $R \times B$  to  $G \in \mathbf{Ab}$ . Then  $\psi(r, b) = \psi(1, rb)$  so  $\theta = \psi(1, \bullet)$  is the unique element of  $\text{Hom}_{\mathbf{Z}}(B, G)$  making

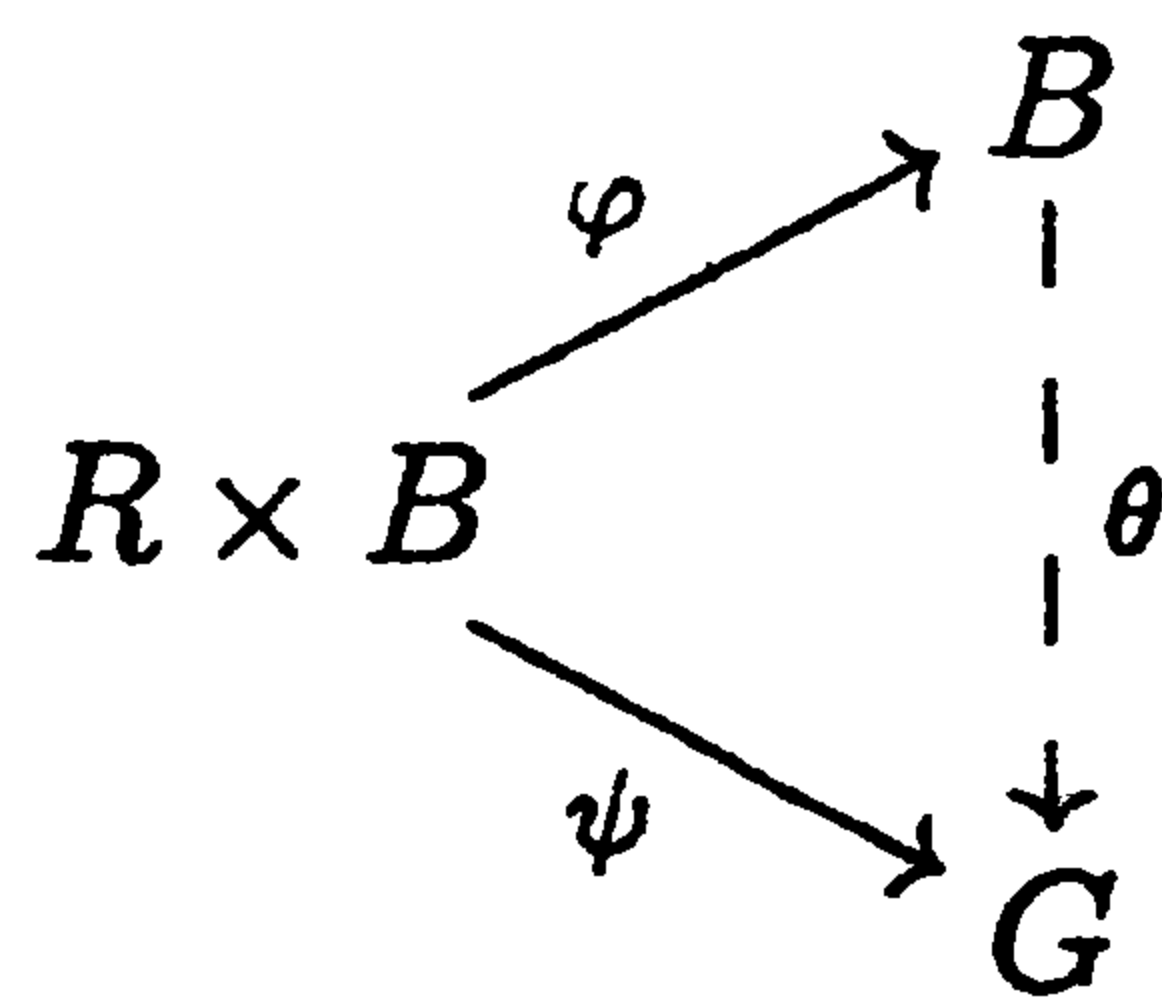

commutative (i.e.,  $\theta(rb) = \psi(r, b)$ ).

(b) Define  $\varphi' : (R/I) \times B$  to  $B/IB$  by  $\varphi'(r + I, b) = rb + IB$ .  $\varphi'$  is well-defined since  $r + I = r' + I \Rightarrow r - r' \in I \Rightarrow (r - r')b \in IB \Rightarrow rb + IB = r'b + IB$ . Suppose  $\psi : (R/I) \times B \rightarrow G \in \mathbf{Ab}$  is bilinear. Let  $\varphi$  be as in part (a). We have a unique  $\theta$  (by part (a)) making

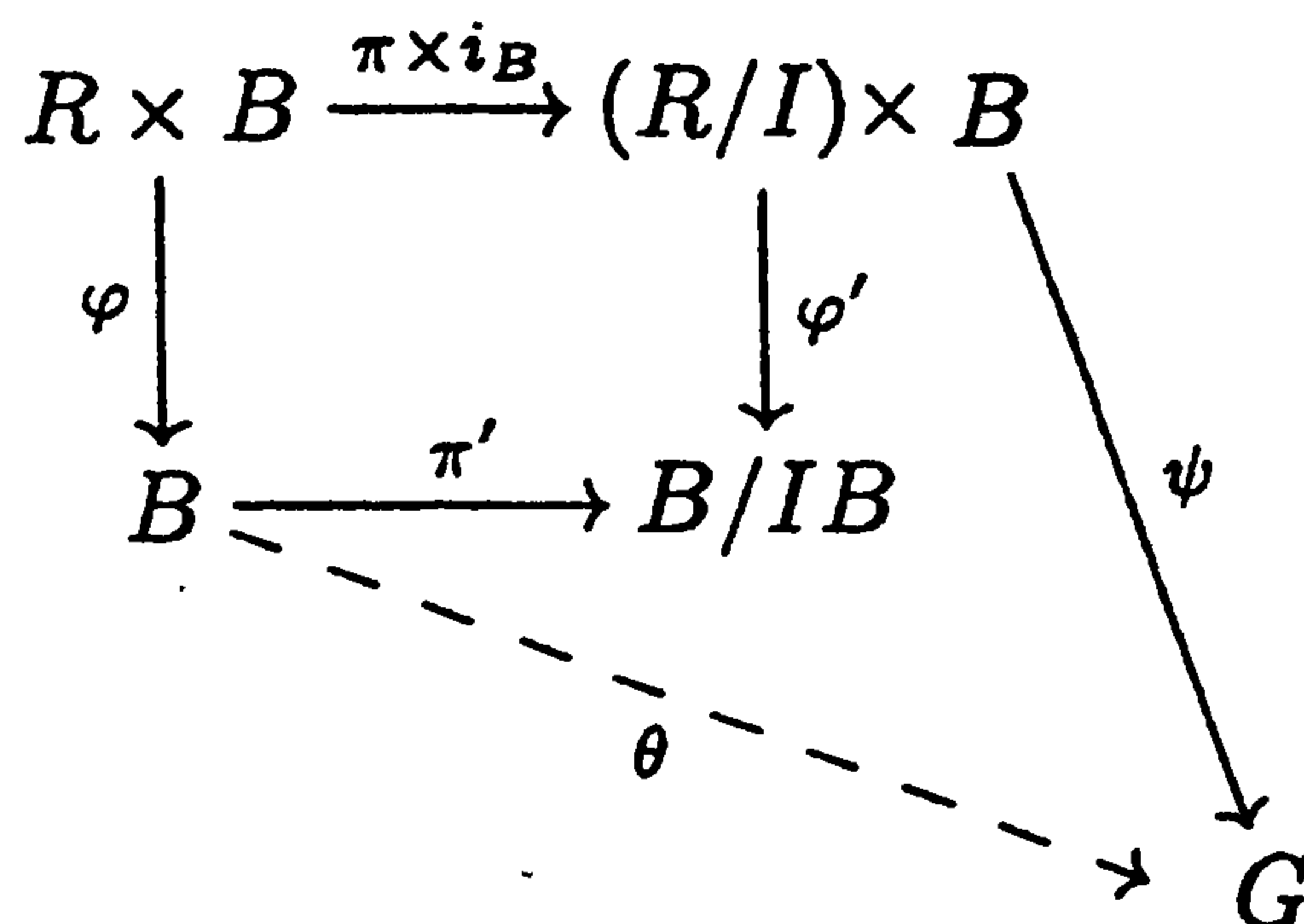

commutative. Note that if  $r \in I$  and  $b \in B$ , then  $\theta(rb) = \theta\varphi(r, b) = \psi(\pi \times i_B)(r, b) = \psi(0 + I, b) = 0$ , so  $IB \subset \ker \theta$ . Thus,  $\theta$  induces a map  $\theta' : B/IB \rightarrow G$  making  $\theta' \pi' = \theta$ . Hence,

$$\theta' \varphi'(\pi \times i_B) = \theta' \pi' \varphi = \theta \varphi = \psi(\pi \times i_B).$$

Since  $\pi \times i_B$  is onto,  $\theta' \varphi' = \psi$ , that is,

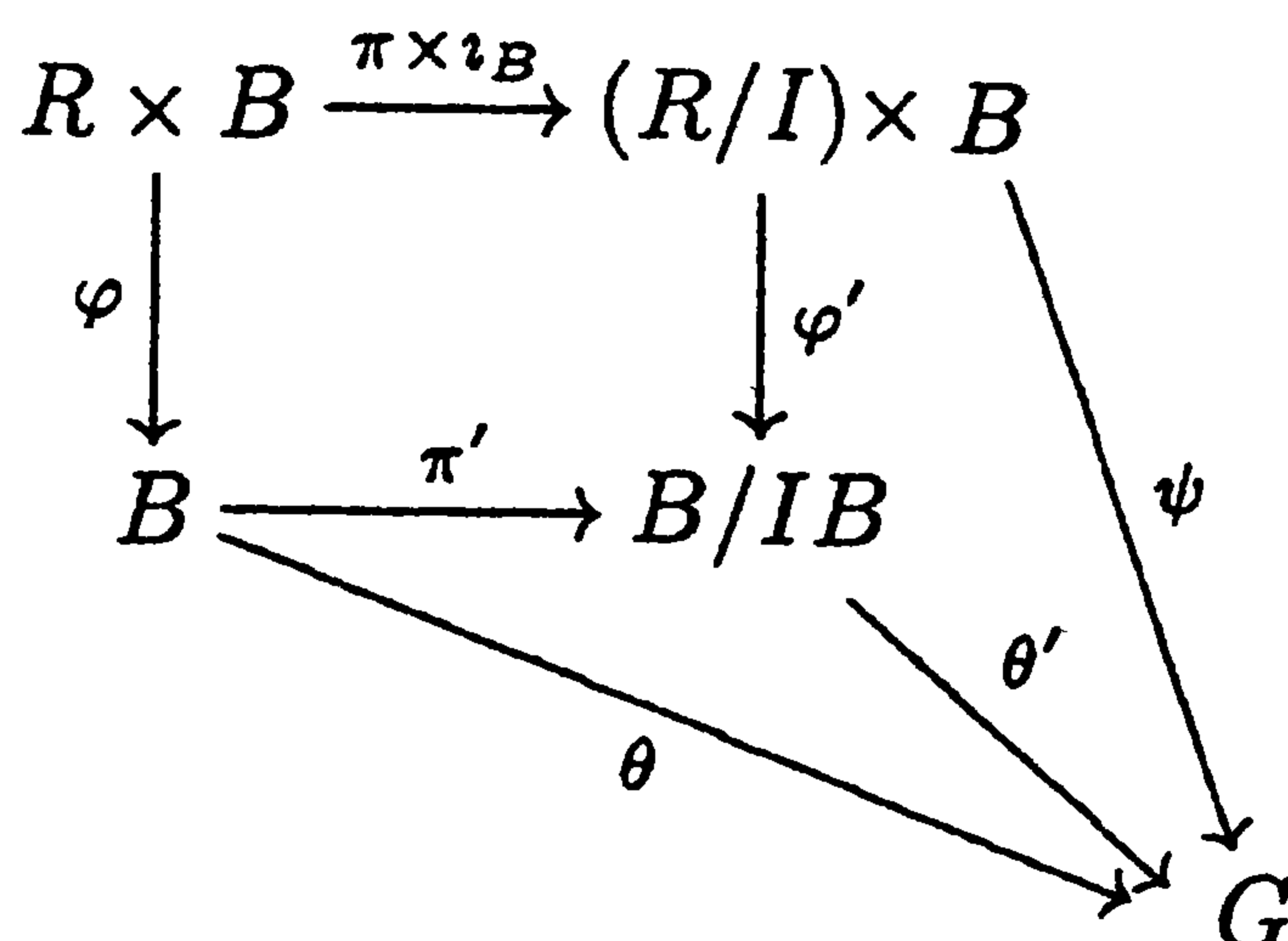

is commutative. Finally,  $\theta'$  is unique in that if  $\theta''$  makes

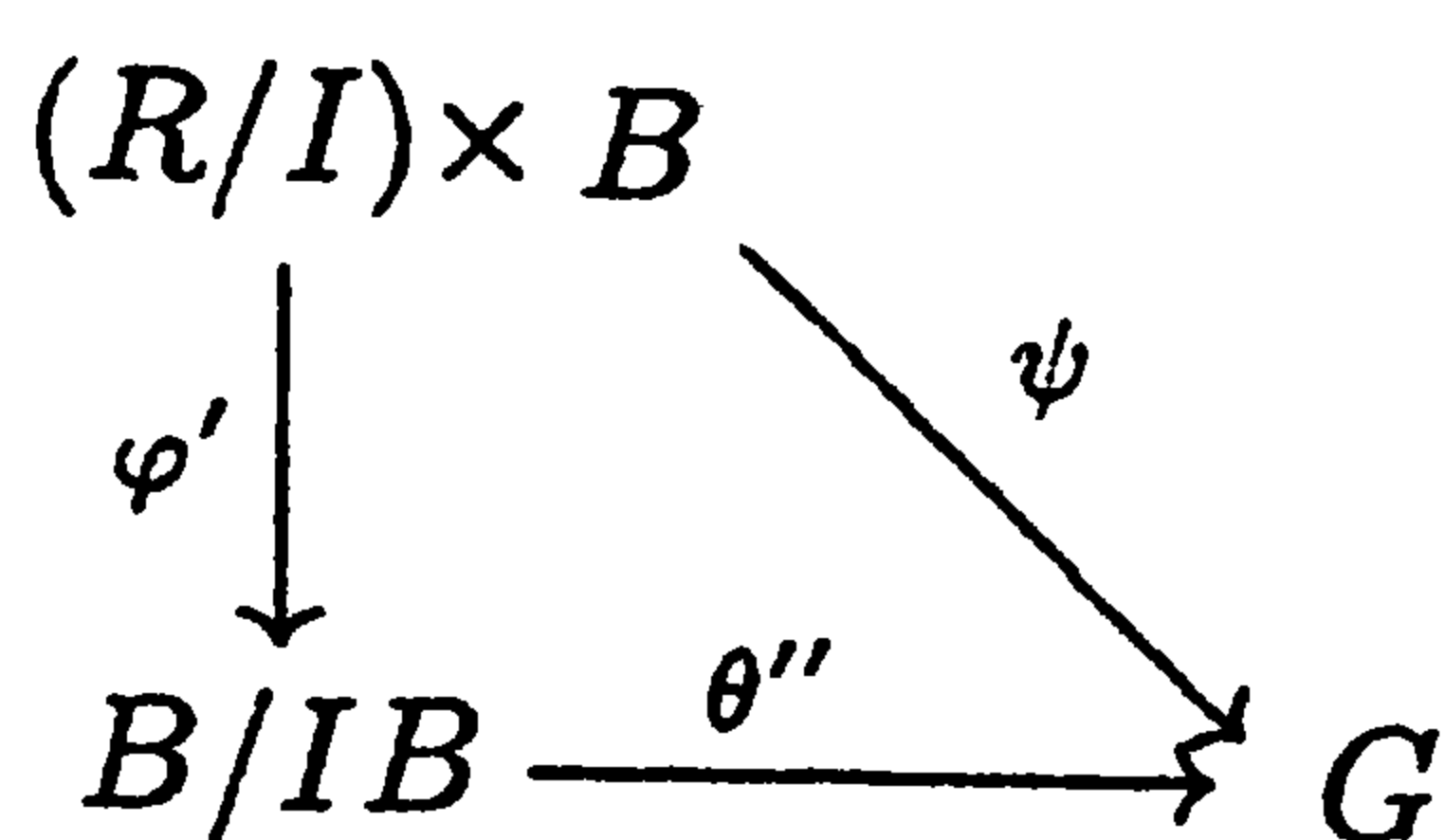

commutative, then  $\theta'' \varphi' = \psi$  so that

$$\theta'' \pi' \varphi = \theta'' \varphi' (\pi \times i_B) = \psi (\pi \times i_B) = \theta \varphi = \theta' \pi' \varphi$$

Hence  $\theta'' = \theta'$ , since  $\pi' \varphi$  is onto. □

Note two things. First is the absence of “ $I \otimes B \approx IB$ ”. This is missing because it is false, as the example  $R = \mathbb{Z}_4$ ,  $B = \mathbb{Z}_2 \approx I = \{0, 2\} \approx R/I$  shows:  $I \otimes B \approx (R/I) \otimes I \approx I/I^2 \approx I$ , while  $IB \approx I^2 = 0$ . (In general,  $I \otimes B$  maps onto  $IB$ , but not in a one-to-one fashion.) Second, note the absence of even the symbols  $a \otimes b$  in the above. When written as combinations of  $r \otimes b$ 's,  $I \otimes B$  looks like a subgroup of  $R \otimes B$ , but it isn't; the free Abelian groups and equivalence relations defining them are different. In fact, caution is *always* in order when attempting to define anything on some  $A \otimes B$  by saying where each  $a \otimes b$  must go. Bilinear maps and fillers work *much* better. In this vein, given  $f \in \text{Hom}(B, B')$ , where  $B, B' \in {}_R\mathbf{M}$ , we can define  $f_* \in \text{Hom}(A \otimes B, A \otimes B')$  when  $A \in \mathbf{M}_R$ , using nothing but the universal mapping property:

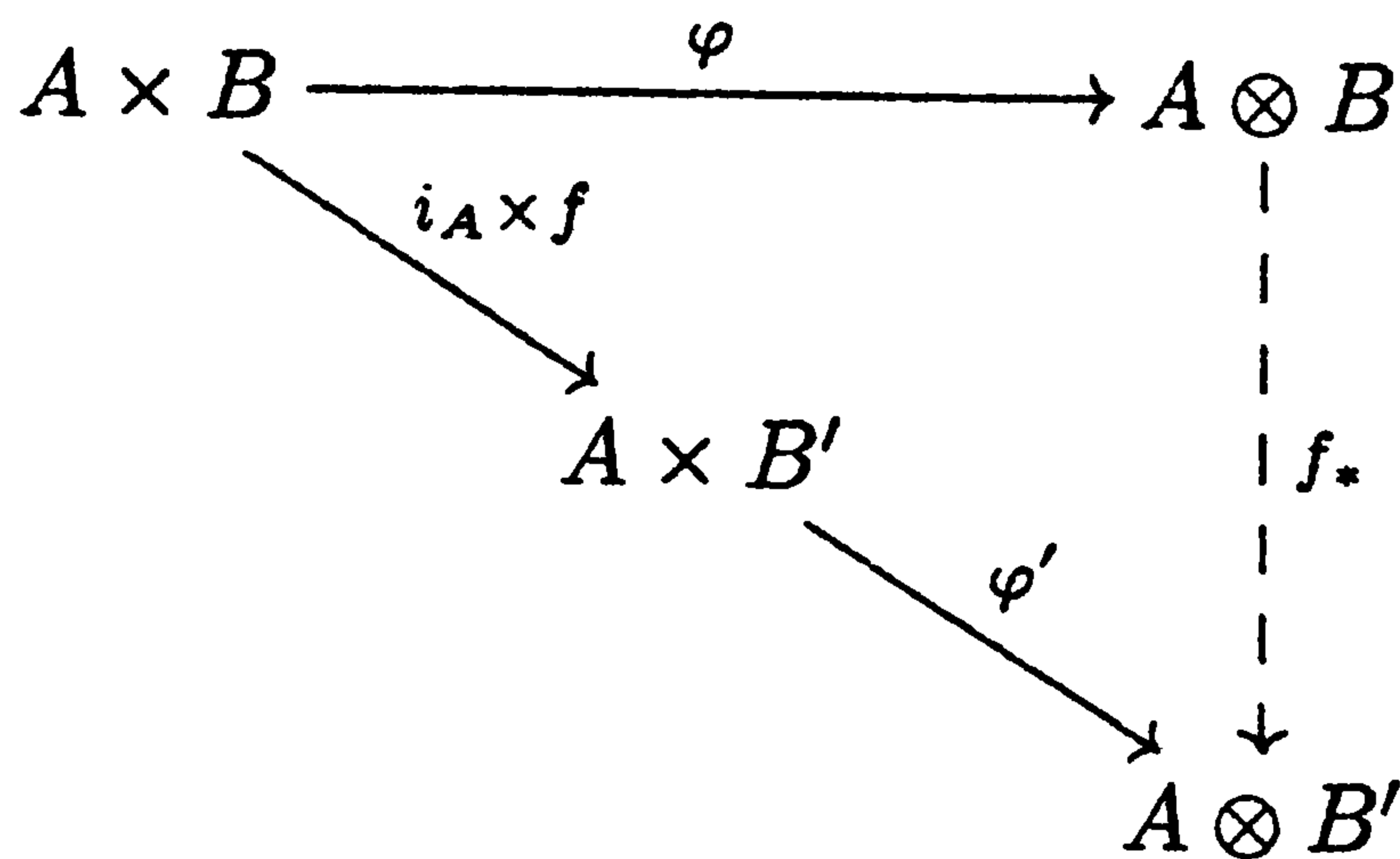

$f_*(a \otimes b) = a \otimes f(b)$  as expected. Compositions work properly as well, giving that,



If  $A \in \mathbf{M}_R$ , then  $A \otimes_R$  is a covariant functor from  ${}_R\mathbf{M}$  to  $\mathbf{Ab}$ . Similarly, if  $B \in {}_R\mathbf{M}$ , then  $\otimes_R B$  is a covariant functor from  $\mathbf{M}_R$  to  $\mathbf{Ab}$ .

If  $B \in {}_R\mathbf{M}_S$ , and  $s \in S$ , we can apply all this to  $f_s \in \text{Hom}_R(B, B)$ , where  $f_s(b) = bs$ . Setting  $x \cdot s = (f_s)_*(x)$  turns  $A \otimes_R B$  into a right  $S$ -module in which  $(a \otimes b)s = a \otimes (bs)$ ; details are left to the reader. (In this connection, observe that  $f_s \circ f_t = f_{ts}$ .) Similarly, if  $A \in {}_S\mathbf{M}_R$ , then  $A \otimes_R B$  becomes a left  $S$ -module.

As before, we specify the behavior of  $A \otimes$  under (in this case) direct sums.

**Proposition 2.3** *Suppose  $A \in \mathbf{M}_R$ , and  $B_i \in {}_R\mathbf{M}$  for  $i \in \mathcal{I}$ . Then  $A \otimes (\oplus B_i) \approx \oplus (A \otimes B_i)$ . In the isomorphism,  $a \otimes (\oplus b_i)$  maps to  $\oplus (a \otimes b_i)$ .*

**Proof:** We show that  $A \otimes (\oplus B_i)$  is a coproduct of the  $A \otimes B_i$  in  $\mathbf{Ab}$ . Set  $B = \oplus B_i$ , and let  $\varphi_i \in \text{Hom}(B_i, B)$  specify  $B$  as a direct sum. Applying  $A \otimes$  gives maps  $\varphi_{i*} \in \text{Hom}_{\mathbf{Z}}(A \otimes B_i, A \otimes B)$ . We must show that if  $G \in \mathbf{Ab}$ , and if  $\psi_i \in \text{Hom}(A \otimes B_i, G)$  are given, then there is a unique  $\theta$  making all

$$\begin{array}{ccc} A \otimes B_i & \xrightarrow{\varphi_{i*}} & A \otimes B \\ & \searrow \psi_i & \downarrow \theta \\ & & G \end{array}$$

commute. To do this, let  $\eta : A \times B \rightarrow A \otimes B$  and  $\eta_i : A \times B_i \rightarrow A \otimes B_i$  be the bilinear maps specifying the tensor products. Then  $\psi_i \eta_i$  is a bilinear map from  $A \times B_i$  to  $G$ . Hence,  $\Sigma \psi_i \eta_i$ , which is well-defined (despite being a possibly infinite sum), will be a bilinear map from  $A \times (\oplus B_i) = A \times B$  to  $G$ . (This is the one place in this proof where we use the explicit form of a construction, in this case that of  $\oplus B_i$ .) We thus have a unique  $\theta$  making

$$\begin{array}{ccc} A \times B & \xrightarrow{\eta} & A \otimes B \\ & \searrow \Sigma \psi_i \eta_i & \downarrow \theta \\ & & G \end{array}$$

commute. We now have commutative diagrams

$$\begin{array}{ccc} A \times B_j & \xrightarrow{\eta_j} & A \otimes B_j \\ \downarrow i_A \times \varphi_j & & \downarrow \varphi_{j*} \\ A \times B & \xrightarrow{\eta} & A \otimes B \\ & \searrow \Sigma \psi_i \eta_i & \downarrow \theta \\ & & G \end{array}$$



Now  $(\sum \psi_i \eta_i)(a, \langle b_k \rangle) = \sum \psi_i \eta_i(a, b_i) = \sum \psi_i(a \otimes b_i)$ , so  $(\sum \psi_i \eta_i)(i_A \times \varphi_j)(a, b_j) = \psi_j \eta_j(a, b_j)$ . We get that

$$\theta \varphi_{j*} \eta_j = (\sum \psi_i \eta_i)(i_A \times \varphi_j) = \psi_j \eta_j.$$

Since the image of  $\eta_j$  generates  $A \otimes B_j$ , we get that  $\theta \varphi_{j*} = \psi_j$ , that is,

$$\begin{array}{ccc} A \otimes B_j & \xrightarrow{\varphi_{j*}} & A \otimes B \\ & \searrow \psi_j & \downarrow \theta \\ & & G \end{array}$$

commutes.

It remains to show that  $\theta$  is unique with this property. Suppose all

$$\begin{array}{ccc} A \times B_j & \xrightarrow{i_A \times \varphi_j} & A \times B \\ \eta_j \downarrow & & \downarrow \eta \\ A \otimes B_j & \xrightarrow{\varphi_{j*}} & A \otimes B \\ & \searrow \psi_j & \downarrow \theta' \\ & & G \end{array}$$

commute. Then  $\theta' \eta(i_A \times \varphi_j) = \psi_j \eta_j = \theta \varphi_{j*} \eta_j = \theta \eta(i_A \times \varphi_j)$ , so that for all  $a \in A$  and for all  $j$ ,  $\theta \eta(a, \bullet)$  and  $\theta' \eta(a, \bullet)$  agree on all  $\text{im } \varphi_j \subset B$ . Since these images generate  $B$ ,  $\theta \eta = \theta' \eta$ . Since  $\text{im } \eta$  generates  $A \otimes B$ ,  $\theta = \theta'$ , and  $\theta$  is unique.  $\square$

We close this section with the fundamental theorem of tensor products. Recall that if  $A \in \mathbf{M}_R$ , then we may consider  $A$  to be a member of  ${}_Z \mathbf{M}_R$ . Hence, if  $G \in \mathbf{Ab}$ , we may consider  $\text{Hom}_Z(A, G)$  to be a member of  ${}_R \mathbf{M}$ .

**Theorem 2.4 (Fundamental Theorem of Tensor Products)** *Suppose  $A \in \mathbf{M}_R$ ,  $B \in {}_R \mathbf{M}$ , and  $G \in \mathbf{Ab}$ . Then, as Abelian groups,*

$$\text{Hom}_Z(A \otimes B, G) \approx \text{Hom}_R(B, \text{Hom}_Z(A, G)).$$

*This isomorphism is natural in  $A$ ,  $B$ , and  $G$ ; that is,*

*a) If  $\varphi \in \text{Hom}_R(B, B')$ , inducing  $\varphi_* \in \text{Hom}_Z(A \otimes B, A \otimes B')$ , then*

$$\begin{array}{ccc} \text{Hom}_Z(A \otimes B, G) \approx \text{Hom}_R(B, \text{Hom}_Z(A, G)) & & \\ \uparrow \text{Hom}_Z(\varphi_*, G) & & \uparrow \text{Hom}_R(\varphi, \text{Hom}_Z(A, G)) \\ \text{Hom}_Z(A \otimes B', G) \approx \text{Hom}_R(B', \text{Hom}_Z(A, G)) & & \end{array}$$

*commutes.*

b) If  $\varphi \in \text{Hom}_R(A, A')$ , inducing  $\varphi_* \in \text{Hom}(A \otimes B, A' \otimes B)$  and  $\varphi^* : \text{Hom}_Z(A', G) \rightarrow \text{Hom}_Z(A, G)$ , then

$$\begin{array}{ccc} \text{Hom}_Z(A \otimes B, G) \approx \text{Hom}_R(B, \text{Hom}_Z(A, G)) & & \\ \uparrow \text{Hom}_Z(\varphi_*, G) & & \uparrow \text{Hom}_R(B, \varphi^*) \\ \text{Hom}_Z(A' \otimes B, G) \approx \text{Hom}_R(B, \text{Hom}_Z(A', G)) & & \end{array}$$

commutes.

c) If  $\varphi \in \text{Hom}(G, G')$ , then

$$\begin{array}{ccc} \text{Hom}_Z(A \otimes B, G) \approx \text{Hom}_R(B, \text{Hom}_Z(A, G)) & & \\ \downarrow \text{Hom}_Z(A \otimes B, \varphi) & & \downarrow \text{Hom}_R(B, \text{Hom}_Z(A, \varphi)) \\ \text{Hom}_Z(A \otimes B, G') \approx \text{Hom}_R(B, \text{Hom}_Z(A, G')) & & \end{array}$$

commutes.

**Proof:** We show that each side is isomorphic (in a natural way) to  $\text{Bil}(A, B; G)$  the group of bilinear maps from  $A \times B$  to  $G$ . Note first that  $\text{Hom}_Z(A \otimes B, G) \approx \text{Bil}(A, B; G)$  practically by definition, for the map  $\eta : A \times B \rightarrow A \otimes B$  gives, via post-composition, a map from  $\text{Hom}_Z(A \otimes B, G)$  to  $\text{Bil}(A, B; G)$ . However, the universal mapping property of  $A \otimes B$  just says that post-composition is onto (existence of a filler) and one-to-one (uniqueness of fillers). It preserves the group structure, too, since that is inherited from  $G$ . It remains to show that

$$\text{Bil}(A, B; G) \approx \text{Hom}_R(B, \text{Hom}_Z(A, G)).$$

The correspondence is the usual one:

$$\begin{aligned} \{\text{maps} : A \times B \rightarrow G\} &\longleftrightarrow \{\text{maps} : B \rightarrow (\text{maps} : A \rightarrow G)\} \\ f &\longleftrightarrow g \\ f(a, b) &= [g(b)](a). \end{aligned}$$

What needs to be verified is that  $f$  is bilinear if and only if  $g$  is a homomorphism from  $B$  to  $\text{Hom}_Z(A, G)$ . Note first that linearity of  $f$  in  $A$  simply guarantees that  $g$  takes values in  $\text{Hom}_Z(A, G)$ , while linearity of  $f$  in  $B$  says that  $g$  is a homomorphism of Abelian groups. Finally,  $f(ar, b) = f(a, rb)$  if and only if  $g(rb)(a) = g(b)(ar) = [r \cdot g(b)](a)$ , that is,  $f$  is  $R$ -bilinear if and only if  $g$  is an  $R$ -module homomorphism.

Naturality follows, for example, in (a) from defining a map  $\varphi^*$  from  $\text{Bil}(A, B'; G)$  to  $\text{Bil}(A, B; G)$  by precomposition in the second variable and

verifying commutativity of the diagrams

$$\begin{array}{ccc} \text{Hom}_{\mathbb{Z}}(A \otimes B; G) \approx \text{Bil}(A, B; G) & & \\ \uparrow \text{Hom}_{\mathbb{Z}}(\varphi_*, G) & & \uparrow \varphi^* \\ \text{Hom}_{\mathbb{Z}}(A \otimes B'; G) \approx \text{Bil}(A, B'; G) & & \end{array}$$

and

$$\begin{array}{ccc} \text{Bil}(A, B; G) \approx \text{Hom}_R(B, \text{Hom}_{\mathbb{Z}}(A, G)) & & \\ \uparrow \varphi^* & & \uparrow \text{Hom}_R(\varphi, \text{Hom}_{\mathbb{Z}}(A, G)) \\ \text{Bil}(A, B'; G) \approx \text{Hom}_R(B', \text{Hom}_{\mathbb{Z}}(A, G)) & & \end{array}$$

which is routine and is left to the reader. □

## 2.3 Exactness of Functors

Suppose  $\varphi \in \text{Hom}(A, B)$  and  $\psi \in \text{Hom}(B, C)$ . The arrows

$$A \xrightarrow{\varphi} B \xrightarrow{\psi} C$$

will be called *exact* if  $\ker \psi = \text{im } \varphi$ . Note that exactness consists of two parts:

- i) The easy part,  $\ker \psi \supset \text{im } \varphi$ , verified by checking that  $\psi\varphi = 0$ .
- ii) The hard part,  $\ker \psi \subset \text{im } \varphi$ , verified by checking that  $\psi(b) = 0 \Rightarrow b = \varphi(a)$  for some  $a$ .

That is, (i) is checked by verifying a functional composition, while (ii) is checked by verifying an existential (existence of  $a$ ) condition on certain elements.

Let  $F$  be a covariant functor from  ${}_R\mathbf{M}$  to  $\mathbf{Ab}$ . Suppose  $F(0) = 0$ . Then

$$F(A) \xrightarrow{F(\varphi)} F(B) \xrightarrow{F(\psi)} F(C)$$

satisfies the easy part of exactness. It need not satisfy the hard part, as will soon become very apparent.

First off, the most important exact sequences are the *short exact sequences*

$$0 \rightarrow A \xrightarrow{\varphi} B \xrightarrow{\pi} C \rightarrow 0.$$

Here,  $\pi$  is onto,  $\varphi$  is one-to-one, and  $\ker \pi = \text{im } \varphi$ . This situation occurs when  $B$  is the biproduct of  $A$  and  $C$ , as well as, for example,

$$0 \rightarrow 2\mathbb{Z} \hookrightarrow \mathbb{Z} \rightarrow \mathbb{Z}_2 \rightarrow 0,$$

which has a different character. We say that

$$0 \rightarrow A \xrightarrow{\varphi} B \xrightarrow{\pi} C \rightarrow 0$$

splits if  $B$  is a biproduct of  $A$  and  $C$  in some way, that is, there exist maps  $\psi : C \rightarrow B$  and  $\rho : B \rightarrow A$  which, with  $\varphi$  and  $\pi$ , make  $B$  into a biproduct. It is a fundamental result (see Exercise 2 at the end of this chapter) that only  $\psi$  or  $\rho$  need be given (subject to  $\pi\psi = i_C$  or  $\rho\varphi = i_A$ , as the case may be) to get both.  $\psi$  is sometimes called a *section*. We shall sometimes abuse the language and say “ $B \rightarrow C \rightarrow 0$  splits” or “ $0 \rightarrow A \rightarrow B$  splits”. Note also that splitting is equivalent to the existence of an  $\eta$  making

$$\begin{array}{ccccccccc} 0 & \longrightarrow & A & \longrightarrow & B & \longrightarrow & C & \longrightarrow & 0 \\ & & \parallel & & \downarrow \eta & & \parallel & & \\ 0 & \longrightarrow & A & \longrightarrow & A \oplus C & \longrightarrow & C & \longrightarrow & 0 \end{array}$$

commutative. Any such  $\eta$  will be an isomorphism, thanks to the fabled “five lemma”:

**Proposition 2.5 (5-LEMMA)** *Suppose*

$$\begin{array}{ccccccccc} A_1 & \xrightarrow{f_1} & A_2 & \xrightarrow{f_2} & A_3 & \xrightarrow{f_3} & A_4 & \xrightarrow{f_4} & A_5 \\ \downarrow \varphi_1 & & \downarrow \varphi_2 & & \downarrow \varphi_3 & & \downarrow \varphi_4 & & \downarrow \varphi_5 \\ B_1 & \xrightarrow{g_1} & B_2 & \xrightarrow{g_2} & B_3 & \xrightarrow{g_3} & B_4 & \xrightarrow{g_4} & B_5 \end{array}$$

*is commutative with exact rows, and suppose*

- i)  $\varphi_2$  and  $\varphi_4$  are isomorphisms,*
- ii)  $\varphi_1$  is onto, and*
- iii)  $\varphi_5$  is one-to-one.*

*Then  $\varphi_3$  is an isomorphism.*

**Proof:**  $\varphi_3$  is one-to-one: Suppose  $\varphi_3(a) = 0$ . Then  $0 = g_3\varphi_3(a) = \varphi_4f_3(a) \Rightarrow f_3(a) = 0$ , since  $\varphi_4$  is one-to-one. Hence,  $a = f_2(a')$  for some  $a' \in A_2$ , by exactness of the top row. Hence,  $0 = \varphi_3f_2(a') = g_2\varphi_2(a')$ . Hence,  $\varphi_2(a') = g_1(b')$  for some  $b' \in B_1$  by exactness of the bottom row. Finally,  $b' = \varphi_1(a'')$  for some  $a'' \in A_1$ , since  $\varphi_1$  is onto. But now

$\varphi_2(a') = g_1(b') = g_1\varphi_1(a'') = \varphi_2f_1(a'')$ , so  $f_1(a'') = a'$  since  $\varphi_2$  is one-to-one. But that means that  $a = f_2(a') = f_2f_1(a'') = 0$  by exactness of the top row.

$\varphi_3$  is onto: This breaks into two parts. First,  $\text{im } g_2 \subset \text{im } \varphi_3$ : Suppose  $b' \in B_2$ . Then  $b' = \varphi_2(a)$  for some  $a \in A_2$ , since  $\varphi_2$  is onto. But now  $g_2(b') = g_2\varphi_2(a) = \varphi_3f_2(a) \in \text{im } \varphi_3$ .

Finally, suppose  $b \in B_3$ . Then  $g_3(b) \in B_4 = \text{im } \varphi_4$ , so  $\exists a \in A_4$  with  $g_3(b) = \varphi_4(a)$ . Now  $0 = g_4g_3(b) = g_4\varphi_4(a) = \varphi_5f_4(a)$  by exactness of the bottom row, so  $f_4(a) = 0$ , since  $\varphi_5$  is one-to-one. Hence,  $a = f_3(a')$  for some  $a' \in A_3$  by exactness of the top row. Hence,  $g_3(b) = \varphi_4(a) = \varphi_4f_3(a') = g_3\varphi_3(a')$ , that is,  $b - \varphi_3(a') \in \ker g_3 = \text{im } g_2 \subset \text{im } \varphi_3$ . That is,  $b - \varphi_3(a') = \varphi_3(a'')$  for some  $a'' \in A_3$ , so  $b = \varphi_3(a' + a'')$ .  $\square$

Whew! The above is an example of what is called a *diagram chase*, where maps are, well, chased around a diagram. It is a long and involved argument, but it is actually almost self-proving. Try it; cover, for example, the one-to-one part of the proof, and reconstruct it. At each stage, there is really only one thing to do.

Back to functors. Suppose  $F$  is a covariant functor from  ${}_R\mathbf{M}$  to  $\mathbf{Ab}$ .  $F$  will be called *exact* if, whenever

$$0 \rightarrow A \rightarrow B \rightarrow C \rightarrow 0$$

is short exact in  ${}_R\mathbf{M}$ , necessarily

$$0 \rightarrow F(A) \rightarrow F(B) \rightarrow F(C) \rightarrow 0$$

is exact. If given the same short exact sequence for  $A$ ,  $B$ , and  $C$ , one always has exactness of

$$0 \rightarrow F(A) \rightarrow F(B) \rightarrow F(C),$$

then  $F$  will be called *left exact*; while if one always has exactness of

$$F(A) \rightarrow F(B) \rightarrow F(C) \rightarrow 0,$$

then  $F$  will be called *right exact*. Finally, if one always has exactness of

$$F(A) \rightarrow F(B) \rightarrow F(C),$$

then  $F$  will be called *half exact*.

Note:

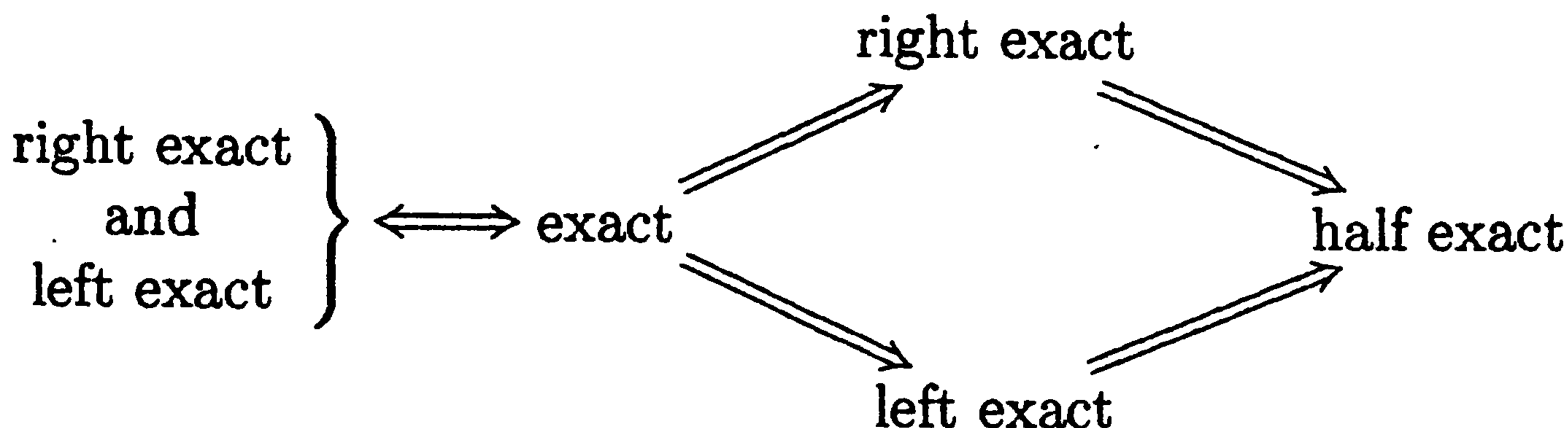



Half exact functors will be considered further in Chapter 6. We now establish:

**Proposition 2.6**

- a) If  $A \in {}_R\mathbf{M}$ , then  $\text{Hom}(A, \bullet)$  is left exact.  
 b) If  $A \in \mathbf{M}_R$ , then  $A \otimes$  is right exact.

**Proof:**

(a) If

$$0 \rightarrow B \xrightarrow{\varphi} B' \xrightarrow{\psi} B'' \rightarrow 0$$

is exact, examine

$$0 \rightarrow \text{Hom}(A, B) \xrightarrow{\varphi_*} \text{Hom}(A, B') \xrightarrow{\psi_*} \text{Hom}(A, B'').$$

Now if  $\varphi_*(f) = 0$ , then  $\varphi f = 0$ . Since  $\varphi$  is one-to-one,  $f = 0$ . That is,  $\varphi_*$  is one-to-one. Now,  $\psi_*\varphi_* = (\psi\varphi)_* = 0_* = 0$ , so it remains to show that  $\psi_*(f) = 0 \Rightarrow f = \varphi_*(g)$  for some  $g$ . Suppose  $\psi_*(f) = 0$ . Then  $\psi f = 0$ , that is,  $\text{im } f \subset \ker \psi$ . Thus,  $\text{im } f \subset \text{im } \varphi$ . Define  $g$  by  $g = \varphi^{-1}f$ , where  $\varphi^{-1}$  is defined on  $\text{im } \varphi$ . It is routine to check that  $g \in \text{Hom}(A, B)$  and  $\varphi_*(g) = f$ .

(b) If

$$0 \rightarrow B \xrightarrow{\varphi} B' \xrightarrow{\psi} B'' \rightarrow 0$$

is exact, examine

$$A \otimes B \xrightarrow{\varphi_*} A \otimes B' \xrightarrow{\psi_*} A \otimes B'' \rightarrow 0$$

indirectly. Let  $H$  denote  $A \otimes B' / \text{im } \varphi_*$ . Since  $\psi_*\varphi_* = 0_* = 0$  at least, we have a map  $\theta$  from  $H$  to  $A \otimes B''$  defined by  $\theta(x + \text{im } \varphi_*) = \psi_*(x)$ . We thus have a commutative diagram

$$\begin{array}{ccccccc} A \otimes B & \xrightarrow{\varphi_*} & A \otimes B' & \xrightarrow{\pi} & H & \longrightarrow & 0 \\ \parallel & & \parallel & & \downarrow \theta & & \\ A \otimes B & \xrightarrow{\varphi_*} & A \otimes B' & \xrightarrow{\psi_*} & A \otimes B'' & \longrightarrow & 0 \end{array}$$

It suffices to show that  $\theta$  is an isomorphism, since then, for example,  $\ker \psi_* = \ker \pi$  (while  $\ker \pi = \text{im } \varphi_*$  by definition of  $\pi$ ).

First of all, consider the diagram

$$\begin{array}{ccccccc}
 A \times B & \xrightarrow{i_A \times \varphi} & A \times B' & \xrightarrow{i_A \times \psi} & A \times B'' & & \\
 \downarrow \eta & & \downarrow \eta' & & \downarrow \tau & & \\
 A \otimes B & \xrightarrow{\varphi_*} & A \otimes B' & \xrightarrow{\pi} & H & \longrightarrow & 0 \\
 \parallel & & \parallel & & \downarrow \theta & & \\
 A \otimes B & \xrightarrow{\varphi_*} & A \otimes B' & \xrightarrow{\psi_*} & A \otimes B'' & \longrightarrow & 0
 \end{array}$$

$\tau$  exists since  $\pi\eta'(i_A \times \varphi) = \pi\varphi_*\eta = 0$ , so that  $\pi\eta'$  vanishes on  $A \times (\text{im } \varphi)$  in  $A \times B'$ . It thus induces a bilinear map on  $A \times (B'/\text{im } \varphi) \approx A \times B''$ , which we call  $\tau$ . Note that, from uniqueness and commutativity again,  $\theta\tau$  is the map  $\eta'' : A \times B'' \rightarrow A \otimes B''$  used in defining the tensor product  $A \otimes B''$ . This is easiest to see by writing  $\eta''(a, b'') = a \otimes b''$ ,  $b'' = \psi(b')$ . Then

$$\theta\tau(a, b'') = \theta(\pi(a \otimes b')) = \psi_*(a \otimes b') = a \otimes b'' = \eta''(a, b'').$$

It follows that  $\theta$  is onto, since the subgroup  $\text{im } \theta$  contains  $\text{im } \theta\tau = \text{im } \eta''$ , which generates  $A \otimes B''$ .

Finally, to show  $\theta$  is one-to-one, observe that the universal mapping property gives a filler  $\chi$  for

$$\begin{array}{ccc}
 A \times B'' & \xrightarrow{\eta''} & A \otimes B'' \\
 & \searrow \tau & \downarrow \chi \\
 & & H
 \end{array}$$

We now have

$$\begin{array}{ccccc}
 A \otimes B' & \xrightarrow{\pi} & H & & \\
 \uparrow \eta' & & \uparrow \tau & \searrow \theta & \\
 A \times B' & \xrightarrow{i_A \times \psi} & A \times B'' & \xrightarrow{\eta''} & A \otimes B'' \\
 \downarrow \eta' & & \downarrow \tau & \swarrow \chi & \\
 A \otimes B' & \xrightarrow{\pi} & H & & 
 \end{array}$$

commutative, from which  $\chi\theta\pi\eta' = \pi\eta'$ , so (since  $\text{im } \eta'$  generates  $A \otimes B'$ )

$$\begin{array}{ccccccc}
 A \otimes B & \longrightarrow & A \otimes B' & \xrightarrow{\pi} & H & \longrightarrow & 0 \longrightarrow 0 \\
 \parallel & & \parallel & & \downarrow \chi\theta & & \parallel & \parallel \\
 A \otimes B & \longrightarrow & A \otimes B' & \xrightarrow{\pi} & H & \longrightarrow & 0 & \longrightarrow 0
 \end{array}$$



is commutative, so  $\chi\theta$  is an isomorphism by the 5-lemma. Hence  $\ker\theta \subset \ker\chi\theta = \{0\}$ , so  $\theta$  is one-to-one.  $\square$

Now suppose  $F$  is a contravariant functor from  ${}_R\mathbf{M}$  (or  $\mathbf{M}_R$ ) to  $\mathbf{Ab}$ .  $F$  is *left exact* if, whenever

$$0 \rightarrow A \xrightarrow{\varphi} B \xrightarrow{\psi} C \rightarrow 0$$

is exact in  ${}_R\mathbf{M}$ , necessarily

$$0 \rightarrow F(C) \xrightarrow{\psi^*} F(B) \xrightarrow{\varphi^*} F(A)$$

is exact. Note that the zero winds up on the *left* side. Right exact, half exact, and exact are defined similarly.

**Proposition 2.7** *If  $A \in {}_R\mathbf{M}$ , then  $\text{Hom}(\bullet, A)$  is left exact.*

The proof is very similar to the proof of Proposition 2.6(a), except the compositions are on the other side. Details are left to the reader.

One final remark before closing this section. Suppose that

$$0 \rightarrow A \xrightarrow{\varphi} B \xrightarrow{\psi} C$$

is exact, and suppose  $F$  is a left exact covariant functor. Setting  $D = \text{im } \psi$ , we have two short exact sequences

$$0 \rightarrow A \xrightarrow{\varphi} B \xrightarrow{\bar{\psi}} D \rightarrow 0$$

and

$$0 \rightarrow D \xrightarrow{\iota} C \xrightarrow{\pi} C/D \rightarrow 0,$$

giving exactness of

$$0 \rightarrow F(A) \xrightarrow{F(\varphi)} F(B) \xrightarrow{F(\bar{\psi})} F(D)$$

and

$$0 \rightarrow F(D) \xrightarrow{F(\iota)} F(C) \xrightarrow{F(\pi)} F(C/D).$$

Hence,  $F(\iota)$  is one-to-one, so that  $\ker F(\psi) = \ker(F(\iota\bar{\psi})) = \ker(F(\iota)F(\bar{\psi})) = \ker F(\bar{\psi}) = \text{im } F(\varphi)$ , while  $F(\varphi)$  is one-to-one. That is, exactness of

$$0 \rightarrow A \xrightarrow{\varphi} B \xrightarrow{\psi} C$$

is enough to imply exactness of

$$0 \rightarrow F(A) \xrightarrow{F(\varphi)} F(B) \xrightarrow{F(\psi)} F(C).$$

Similar remarks apply to right exact covariant functors, and left and right exact contravariant functors. (Be sure the zero that is there corresponds to the zero hypothesized for the exact sequence of  $F$ -values.) Doing this twice shows that if  $F$  is exact, then  $F$  sends any exact sequence  $A \rightarrow B \rightarrow C$  to an exact sequence  $F(A) \rightarrow F(B) \rightarrow F(C)$ . (See Exercise 5.)

## 2.4 Projectives, Injectives, and Flats

### Definition 2.8

- i) Suppose  $A \in {}_R\mathbf{M}$ .  $A$  is projective if  $\text{Hom}(A, \bullet)$  is an exact functor.*
- ii) Suppose  $A \in {}_R\mathbf{M}$ .  $A$  is injective if  $\text{Hom}(\bullet, A)$  is an exact functor.*
- iii) Suppose  $A \in \mathbf{M}_R$ .  $A$  is flat if  $A \otimes$  is an exact functor.*

This definition for projective (as well as for injective) is equivalent to the usual one. That is, a filler  $g$  exists for any commutative diagram

$$\begin{array}{ccc} & P & \\ & \swarrow g & \downarrow f \\ B & \xrightarrow{\rho} & C \longrightarrow 0 \end{array}$$

with an exact row. To see this, complete the diagram to

$$\begin{array}{ccccccc} & & & & P & & \\ & & & & \downarrow f & & \\ 0 & \longrightarrow & \ker \rho^C & \longrightarrow & B & \xrightarrow{\rho} & C \longrightarrow 0 \end{array}$$

Since  $P$  is projective,  $\text{Hom}(P, B) \rightarrow \text{Hom}(P, C)$  is onto; in particular,  $f \in \text{im Hom}(P, \rho)$ , so that there exists a filler  $g$

$$\begin{array}{ccccccc} & & & & P & & \\ & & & & \downarrow f & & \\ 0 & \longrightarrow & \ker \rho^C & \longrightarrow & B & \xrightarrow{\rho} & C \longrightarrow 0 \end{array}$$

with  $\text{Hom}(P, \rho)(g) = f$ , that is,  $\rho g = f$ . This argument reverses.

Similarly,  $E$  is injective if and only if any diagram

$$\begin{array}{ccc} 0 & \longrightarrow & A \xrightarrow{\varphi} B \\ & & \downarrow f \\ & & E \end{array}$$

with an exact row has a filler  $g$ .

Note that there are similar definitions of projective and injective modules in  $M_R$  and of flat modules in  ${}_R M$ . Roughly speaking, homological algebra is concerned with the question of how much modules differ from being projective, injective, or flat.

The following result will be used to manufacture lots of projectives and flats.

### Proposition 2.9

- a) Suppose  $A_i \in {}_R M$ . Then  $\bigoplus A_i$  is projective if and only if each  $A_i$  is projective.
- b) Suppose  $A_i \in {}_R M$ . Then  $\prod A_i$  is injective if and only if each  $A_i$  is injective.
- c) Suppose  $A_i \in M_R$ . Then  $\bigoplus A_i$  is flat if and only if each  $A_i$  is flat.

**Proof:** The proofs are very similar, so only (a) will be done here. Suppose

$$0 \longrightarrow B \longrightarrow C \longrightarrow D \longrightarrow 0$$

is exact. Apply  $\text{Hom}(\bigoplus A_i, \bullet)$  to get

$$\begin{array}{ccccccc} 0 & \longrightarrow & \text{Hom}(\bigoplus A_i, B) & \longrightarrow & \text{Hom}(\bigoplus A_i, C) & \longrightarrow & \text{Hom}(\bigoplus A_i, D) \longrightarrow 0 \\ & & \cong & & \cong & & \cong \end{array}$$

$$0 \longrightarrow \prod \text{Hom}(A_i, B) \longrightarrow \prod \text{Hom}(A_i, C) \longrightarrow \prod \text{Hom}(A_i, D) \longrightarrow 0$$

(see Exercise 3). The top row is exact if and only if the bottom row is exact if and only if each

$$0 \longrightarrow \text{Hom}(A_i, B) \longrightarrow \text{Hom}(A_i, C) \longrightarrow \text{Hom}(A_i, D) \longrightarrow 0$$

is exact, as can be seen by looking at  $\mathcal{I}$ -tuples. (Note, too, that only the right hand arrow is at issue, by left exactness of  $\text{Hom}(A_i, \bullet)$ .)  $\square$

Now note that  $\text{Hom}(R, B) \approx B$  via  $f \mapsto f(1)$ , and  $R \otimes B \approx B$  by Proposition 2.2(a). Hence  $R$  is both projective (in  ${}_R M$ ) and flat (in  $M_R$ ). Since free modules are direct sums of copies of  $R$ , we get that:

*Free modules are projective and flat.*

Furthermore, if  $A \in {}_R M$ , then there is a free module  $F$  (free on  $A$  as a set) and a surjection  $F \rightarrow A$  (associated with the identity set map from  $A$  to itself), giving:

*(Enough projectives)* Every  $A \in {}_R\mathbf{M}$  is the homomorphic image of a projective module.

Now suppose  $P$  is projective, and suppose  $\varphi : A \rightarrow P$  is onto. Completing

$$\begin{array}{ccccccc}
 & & & & P & & \\
 & & & & \swarrow & \downarrow & \\
 & & & g & & i_P & \\
 & & & \swarrow & & & \\
 & & & \varphi & & & \\
 0 & \longrightarrow & \ker \varphi & \longrightarrow & A & \longrightarrow & P \longrightarrow 0
 \end{array}$$

one obtains that the horizontal sequence splits, and  $P$  is a direct summand of  $A$ . Conversely, taking  $F$  free and  $F \rightarrow P$  onto: If  $P$  is a direct summand of  $F$ , then  $P$  is projective by Proposition 2.9(a). Thus,

*If  $P \in {}_R\mathbf{M}$ , then  $P$  is projective if and only if whenever  $A \xrightarrow{\varphi} P$  is onto, necessarily  $P$  is a direct summand of  $A$ .*

and

*Any projective module is a direct summand of a free module.*

Furthermore, reversing the sides  $R$  works on:

*If  $P$  is projective in  $\mathbf{M}_R$ , then  $P$  is flat.*

Except for the absence of free modules, much of what has been said about projectives can be said about injectives, but this involves some work due to the absence at this point of something like free modules as candidate injectives. We also need to be able to identify injectives. The following, due to Baer [4], does the latter.

**Proposition 2.10 (Injective Test Lemma)** *Suppose  $E \in {}_R\mathbf{M}$ . Then  $E$  is injective if and only if a filler  $g$  exists for every diagram*

$$\begin{array}{ccccc}
 0 & \longrightarrow & I & \longrightarrow & R \\
 & & \downarrow & \swarrow & \\
 & & f & & \\
 & & \downarrow & \swarrow & \\
 & & E & & \\
 & & \downarrow & \swarrow & \\
 & & g & & 
 \end{array}$$

where  $I$  is a left ideal in  $R$ .

**Proof:** The “only if” part follows from the fact that such diagrams are particular cases of diagrams that must have fillers.

For the “if” part, suppose

$$\begin{array}{ccccc} 0 & \longrightarrow & A & \xrightarrow{\varphi} & B \\ & & \downarrow f & & \\ & & E & & \end{array}$$

has an exact row. We use Zorn’s lemma. Consider all  $(B', g')$ , where  $\varphi(A) \subset B' \subset B$ ,  $B'$  is a submodule of  $B$ , and

$$\begin{array}{ccccc} 0 & \longrightarrow & A & \xrightarrow{\varphi} & B' \\ & & \downarrow f & \swarrow g' & \\ & & E & & \end{array}$$

commutes, that is,  $g'\varphi = f$ . Such  $(B', g')$  exist;  $(\varphi(A), f\varphi^{-1})$  is one. Partially order by restriction, that is,  $(B', g') \geq (B'', g'')$  when  $B'' \subset B'$  and  $g'|_{B''} = g''$ . If  $\mathcal{C}$  is a nonempty chain of such pairs, then it is bounded by  $(B_0, g_0)$ , where  $B_0 = \bigcup\{B' : (B', g') \in \mathcal{C}\}$  and  $g_0(x) = g'(x)$  if  $x \in B'$  and  $(B', g') \in \mathcal{C}$  ( $g_0$  is well-defined since  $\mathcal{C}$  is a chain). Hence, there is a maximal element  $(g', B')$ . It suffices to show  $B' = B$ .

Suppose not. Suppose  $B' \neq B$ , and  $x \in B - B'$ . Let  $I = \{r \in R : rx \in B'\}$  = annihilator of  $x + B' \in R/B'$ , a left ideal. Set  $\bar{f}(r) = g'(rx)$  if  $r \in I$ . There is a filler  $\bar{g}$  for

$$\begin{array}{ccccc} 0 & \longrightarrow & I & \longrightarrow & R \\ & & \downarrow \bar{f} & \swarrow \bar{g} & \\ & & E & & \end{array}$$

so that  $\bar{g}(r) = \bar{f}(r) = g'(rx)$  when  $r \in I$ . Set  $B'' = B' + Rx$ , and set  $g''(b + rx) = g'(b) + \bar{g}(r)$ . If  $b + rx = b' + r'x$ , then  $b - b' = (r' - r)x \Rightarrow r' - r \in I \Rightarrow g'(b) - g'(b') = g'(b - b') = g'((r' - r)x) = \bar{f}(r' - r) = \bar{g}(r') - \bar{g}(r)$ , that is,  $g'(b) + \bar{g}(r) = g'(b') + \bar{g}(r')$ . That is,  $g''$  is well-defined, so  $(B'', g'')$  properly extends  $(B', g')$ , contradicting maximality.  $\square$

**Corollary 2.11** *Suppose  $R$  is a PID, and suppose  $E \in {}_R\mathbf{M}$  has the property that  $rE = E$  for all  $r \in R, r \neq 0$ . Then  $E$  is injective.*

**Proof:** Suppose we are given

$$\begin{array}{ccccc} 0 & \longrightarrow & I & \longrightarrow & R \\ & & \downarrow f & & \\ & & E & & \end{array}$$



with  $I = Rr$ . If  $r = 0$ , then  $g \equiv 0$  is a filler. If  $r \neq 0$ , then  $f(r) \in E = rE$ , so  $\exists a \in E$  with  $ra = f(r)$ . Set  $g(x) = xa$ . Then  $g(xr) = xra = xf(r) = f(xr)$ , so  $g$  is a filler.  $\square$

The property hypothesized in the corollary is called divisibility: In general,  $E$  is *divisible* if  $rE = E$  whenever  $r$  is a right nonzero divisor, that is,  $xr = 0 \Rightarrow x = 0$  for  $x \in R$ . Any injective module is divisible. (See Exercise 6.)

If  $R$  is a PID, we can now manufacture lots of injectives  $E$ . Suppose  $A \in {}_R\mathbf{M}$ . Write  $A \approx F/K$ , where  $F$  is free, that is,  $F = \bigoplus R$ . Let  $Q$  be the quotient field of  $R$ . Then  $A \approx (\bigoplus R)/K \hookrightarrow (\bigoplus Q)/K = E$ .  $E$  is divisible (since  $\bigoplus Q$  is), hence injective. That is,  $A$  can be imbedded into an injective module.

Not many rings are PIDs, but the following result manufactures injectives over any ring from injectives in  ${}_Z\mathbf{M}$ .

**Theorem 2.12** *Suppose  $A \in {}_R\mathbf{M}$  is flat, and suppose  $G \in {}_Z\mathbf{M}$  is injective. Then  $\text{Hom}_Z(A, G)$  is injective in  ${}_R\mathbf{M}$ .*

**Proof:** Suppose

$$0 \longrightarrow B \longrightarrow C \longrightarrow D \longrightarrow 0$$

is exact in  ${}_R\mathbf{M}$ . Since  $A$  is flat,

$$0 \longrightarrow A \otimes B \longrightarrow A \otimes C \longrightarrow A \otimes D \longrightarrow 0$$

is exact. Since  $G$  is injective in  ${}_Z\mathbf{M}$ , by Theorem 2.4,

$$0 \rightarrow \text{Hom}_Z(A \otimes D, G) \rightarrow \text{Hom}_Z(A \otimes C, G) \rightarrow \text{Hom}_Z(A \otimes B, G) \rightarrow 0$$

is exact. Using the fundamental theorem of tensor products,

$$0 \longrightarrow \text{Hom}_R(D, \text{Hom}_Z(A, G)) \longrightarrow \text{Hom}_R(C, \text{Hom}_Z(A, G)) \longrightarrow \text{Hom}_R(B, \text{Hom}_Z(A, G)) \longrightarrow 0$$

is exact. That is,  $\text{Hom}_R(\bullet, \text{Hom}_Z(A, G))$  is an exact functor, so that  $\text{Hom}_Z(A, G)$  is injective.  $\square$

**Corollary 2.13 (Enough Injectives)** *If  $A \in {}_R\mathbf{M}$ , then there exists an injective  $E \in {}_R\mathbf{M}$  and a one-to-one homomorphism:  $A \rightarrow E$ .*

**Proof:** As an Abelian group, there exists a divisible Abelian group  $G$  and an injection  $\varphi : A \rightarrow G$ .  $G$  is injective since  $\mathbb{Z}$  is a PID. Hence, as  $R$ -modules, recalling that  $\text{Hom}_Z$  denotes homomorphisms of Abelian groups:

$$A \approx \text{Hom}_R(R, A) \subset \text{Hom}_Z(R, A) \approx \text{Hom}_Z(R, \varphi(A)) \subset \text{Hom}_Z(R, G). \quad \square$$



Furthermore, the injection may be taken to be set inclusion by the pullback theorem. If  $E$  is injective, and  $E \subset E'$ , then as with projectives (but backwards), a filler for

$$\begin{array}{ccccccc}
 0 & \longrightarrow & E & \longrightarrow & E' & \longrightarrow & E'/E \longrightarrow 0 \\
 & & \downarrow i_E & \nearrow g & & & \\
 & & E & & & & 
 \end{array}$$

turns  $E$  into a direct summand of  $E'$ . Conversely, if  $E$  is a direct summand of  $E'$  and  $E'$  is injective, then  $E$  is injective by Proposition 2.9(b). Thus:

*$E$  is injective if and only if  $E$  is an absolute direct summand, that is,  $E$  is a direct summand of any module having  $E$  as a submodule.*

This is probably the most important absolute property in mathematics, even compared to the notion of an absolute neighborhood retract in topology.

We close this section (and this chapter) with an amusing theorem due (independently) to Bass [5] and Papp [65]. Recall that in constructing enough divisible (hence injective)  $\mathbb{Z}$ -modules, we took direct sums, rather than direct products. In view of Proposition 2.9(b), this seems strange.

**Proposition 2.14**  *$R$  is left Noetherian if and only if every direct sum of injectives in  ${}_R\mathbf{M}$  is injective.*

**Proof:** Suppose  $R$  is left Noetherian, that is, every left ideal is finitely generated. We use Proposition 2.10, the injective test lemma. Let  $I$  be a left ideal,  $I = \langle a_1, \dots, a_n \rangle$ , and suppose  $E_i$  are injective. If  $\varphi : I \rightarrow \bigoplus E_i$ , with  $\varphi = \bigoplus \varphi_i$ , then  $\{i : \varphi_i(a_j) \neq 0\}$  is finite for  $j = 1, \dots, n$ , so that

$$\begin{array}{ccc}
 0 & \longrightarrow & I \longrightarrow R \\
 & & \downarrow \varphi \\
 & & \bigoplus E_i
 \end{array}$$

factors as

$$\begin{array}{ccc}
 0 & \longrightarrow & I \longrightarrow R \\
 & & \downarrow \varphi \\
 & & \bigoplus' E_i \\
 & & \downarrow \\
 & & \bigoplus E_i
 \end{array}$$

where  $\oplus' E_i$  is the direct sum (and hence direct product) of finitely many  $E_i$ . Hence, one has a filler  $g$  for

$$\begin{array}{ccccc}
 0 & \longrightarrow & I & \longrightarrow & R \\
 & & \downarrow \varphi & \nearrow g & \\
 & & \oplus' E_i & & \\
 & & \downarrow & & \\
 & & \oplus E_i & & 
 \end{array}$$

by Proposition 2.9(b).

Now suppose  $R$  is *not* left Noetherian. Then there exists a chain of left ideals  $I_1 \subsetneq I_2 \subsetneq I_3 \subsetneq \dots$ . Let  $I = \bigcup I_n$ . Choose injectives  $E_n$  and injections  $\varphi_n : I/I_n \rightarrow E_n$ . Define  $\varphi(x) = \oplus \varphi_n(x + I_n)$  if  $x \in I$ . Since any  $x \in I$  is in  $I_n$  for large  $n$ ,  $\varphi_n(x + I_n) = 0$  for all but finitely many  $n$ . That is,  $\varphi$  takes values in  $\oplus E_n$ . If  $g$  is a filler for

$$\begin{array}{ccccc}
 0 & \longrightarrow & I & \longrightarrow & R \\
 & & \downarrow \varphi & \nearrow g & \\
 & & \oplus E_n & & 
 \end{array}$$

then  $\varphi_n(x + I_n) = g_n(x)$  where  $g(x) = \oplus g_n(x)$ . But now  $\varphi_n(x + I_n) = g_n(x) = xg_n(1)$  for  $x \notin I_n$  implies that  $g_n(1) \neq 0$  for all  $n$ . Thus,  $g(1)$  does *not* take values in  $\oplus E_n$ , a contradiction.  $\square$

## Exercises

1. Suppose only that  $A$  is a coproduct of  $A_1$  and  $A_2$  in  ${}_R\mathbf{M}$ , that is,

$$A_1 \xrightarrow{\varphi_1} A \xleftarrow{\varphi_2} A_2$$

makes  $A$  into a coproduct of  $A_1$  and  $A_2$  in  ${}_R\mathbf{M}$ . Show that there are unique  $\pi_i : A \rightarrow A_i$  making  $A$  into a biproduct, using *only* the properties of a coproduct.

Hint:  $\pi_1$ , for example, arises as a filler for

$$\begin{array}{ccccc} A_1 & \xrightarrow{\varphi_1} & A & \xleftarrow{\varphi_2} & A_2 \\ & \searrow & \downarrow & \swarrow & \\ & i_{A_1} & \downarrow \pi_1 & 0 & \\ & & A_1 & & \end{array}$$

**Remark:** There is a type of category called an additive category (to be discussed in Chapter 7) in which the above argument, as well as that of Proposition 2.1, can be carried out. When assembled, this shows that “ $A \oplus B \approx A \times B$ ” holds in *any* additive category, since the left hand side is a biproduct. A similar argument (with arrows reversed) shows that products of two objects are also automatic biproducts.

2. Suppose

$$0 \longrightarrow A \xrightarrow{\varphi} B \xrightarrow{\pi} C \longrightarrow 0$$

is exact, and suppose  $\psi : C \rightarrow B$  satisfies  $\pi\psi = i_C$ . Show that this sequence splits. (Note: The case where  $\eta : B \rightarrow A$  satisfies  $\varphi\eta = i_A$  works pretty much the same way.)

3. Show that  $\text{Hom}(A, \prod B_i) \approx \prod \text{Hom}(A, B_i)$  and  $\text{Hom}(\bigoplus A_i, B) \approx \prod \text{Hom}(A_i, B)$ .

Hint: Proceed directly, or show that, for example,  $\text{Hom}(A, \prod B_i)$  is a product of the  $\text{Hom}(A, B_i)$  in  ${}_Z\mathbf{M}$ . Use the idea behind Theorem 2.4: A map from  $G$  to  $\text{Hom}(A, B)$  is a type of map from  $G \times A$  to  $B$ .

4. Suppose  $B \in {}_R\mathbf{M}$ , and  $I$  is a right ideal. Show that the obvious map from  $I \otimes B$  to  $IB$  is always onto. Suppose it is not one-to-one. Show that there is a finitely generated right ideal  $J \subset I$  such that  $J \otimes B \rightarrow JB$  is not one-to-one. Hint: This is one of those rare places where it helps to consider  $\sum r_i \otimes b_i \in I \otimes B$ .

5. Suppose  $F$  is an exact covariant functor from  ${}_R\mathbf{M}$  to  $\mathbf{Ab}$ . Show that  $F$  sends any exact sequence  $A \rightarrow B \rightarrow C$  to an exact sequence  $F(A) \rightarrow F(B) \rightarrow F(C)$ .
6. Show that any injective module is divisible. Also show that if  $a$  is a right zero-divisor, and if  $R$  is a submodule of  $E$ , then  $1 \notin aE$  (even if  $E$  is injective).
7. (Simplest version of a projective test lemma.) Suppose  $P \in {}_R\mathbf{M}$ , and suppose a filler  $g$  exists for any diagram

$$\begin{array}{ccccc}
 & & P & & \\
 & & \swarrow & \downarrow f & \\
 & g & & & \\
 E & \xrightarrow{\pi} & C & \longrightarrow & 0
 \end{array}$$

when  $E$  is injective. Show that  $P$  is projective.

Hint: Given  $A \rightarrow B \rightarrow 0$ , imbed  $A$  in an injective  $E$  and consider

$$\begin{array}{ccccc}
 & & P & & \\
 & & \swarrow \bar{f} & \downarrow f & \\
 & & & & \\
 A & \xrightarrow{\pi} & B & \longrightarrow & 0 \\
 \downarrow & & \downarrow & & \\
 E & \longrightarrow & E/\ker \pi & \longrightarrow & 0
 \end{array}$$

8. Let  $R$  denote the ring of continuous functions from the real line  $\mathbb{R}$  to itself which are periodic with period  $\pi$ , that is,  $f(x + \pi) = f(x)$  for all  $x$ . Let  $P$  denote the continuous functions from  $\mathbb{R}$  to itself for which  $f(x + \pi) = -f(x)$ . Show that  $P \oplus P \approx R \oplus R$ , so that  $P$  is projective. Show also that  $P$  is not free.

Hint: For the last part, recall that if  $R$  is commutative and  $F$  is free, then the number of generators of  $F$  is uniquely determined as the dimension of  $F/MF$  over  $R/M$ , where  $M$  is any maximal ideal. (If you don't recall that, check it out. It's easy.) For the first part, write functions in  $P \oplus P$  or  $R \oplus R$  as column vectors, and consider the matrix

$$\begin{pmatrix} \cos x & \sin x \\ -\sin x & \cos x \end{pmatrix} .$$

The next four problems are interconnected. Also use Exercise 4, restated in the obvious way for  $A \otimes I \rightarrow AI$ ,  $A \in \mathbf{M}_R$ ,  $I$  a left ideal. If  $G$  is a divisible Abelian group, then  $G$  will be referred to as a *coseparator* if  $G$  contains an element of order  $p$  for every prime  $p$ .

Example:  $\mathbb{Q}/\mathbb{Z}$

9. Suppose  $G$  is a coseparator and  $0 \neq h \in H \in \mathbf{Ab}$ . Show that there is a  $\varphi \in \text{Hom}_{\mathbf{Z}}(H, G)$  for which  $\varphi(h) \neq 0$ . (An injective coseparator in  $\mathbf{Ab}$  is usually defined as a divisible Abelian group  $G$  with this property.)
10. (Partial converse of Theorem 2.12.) Suppose  $G$  is a coseparator,  $A \in \mathbf{M}_R$ , and suppose  $\text{Hom}_{\mathbf{Z}}(A, G)$  is injective. Show that  $A$  is flat.
11. (Flat test lemma.) Suppose  $A \in \mathbf{M}_R$ . Show that  $A$  is flat if and only if  $A \otimes I \rightarrow AI$  is one-to-one for every finitely generated left ideal  $I$ .
12. Suppose  $R$  is a PID. Show that  $A$  is flat if and only if  $A$  is torsion free; that is,  $ar = 0 \Rightarrow a = 0$  or  $r = 0$  for  $a \in A, r \in R$ . Hence, show  $\mathbb{Q}$  is a flat  $\mathbb{Z}$ -module. Note:  $\mathbb{Q}$  is *not* projective, as will be established in the next chapter. It is somewhere between amusing and exasperating to attempt this now. (There is a quick, tricky way.)
13. Suppose  $R$  and  $S$  are rings,  $A \in \mathbf{M}_R, B \in {}_R\mathbf{M}_S$ , and  $C \in {}_S\mathbf{M}$ . Then  $A \otimes_R B \in \mathbf{M}_S$  and  $B \otimes_S C \in {}_R\mathbf{M}$ . Show that  $A \otimes_R (B \otimes_S C) \approx (A \otimes_R B) \otimes_S C$ .

Note: The “obvious” approach, defining  $a \otimes (b \otimes c) \mapsto (a \otimes b) \otimes c$ , has the usual difficulty: Why is this well-defined? A better approach is this. Define a “tritenor product”  $T$  as a solution to an appropriate universal mapping problem for trilinear maps on  $A \times B \times C$ . Show that solutions are unique up to isomorphism, and show that  $A \otimes_R (B \otimes_S C)$  and  $(A \otimes_R B) \otimes_S C$  are both solutions.

14. (The short 5-lemma.) Suppose we have a commutative diagram

$$\begin{array}{ccccccccc}
 0 & \longrightarrow & A & \xrightarrow{j} & B & \xrightarrow{\pi} & C & \longrightarrow & 0 \\
 & & \downarrow \eta & & \downarrow \psi & & \downarrow \phi & & \\
 0 & \longrightarrow & A' & \xrightarrow{j'} & B' & \xrightarrow{\eta'} & C' & \longrightarrow & 0
 \end{array}$$

in  ${}_R\mathbf{M}$  with exact rows. Prove that:

- a) If  $\eta$  and  $\phi$  are one-to-one, then so is  $\psi$ .
- b) If  $\eta$  and  $\phi$  are onto, then so is  $\psi$ .

15. Suppose  $A \in {}_S\mathbf{M}_R, B \in {}_R\mathbf{M}$ , and  $C \in {}_S\mathbf{M}$ . Then  $\text{Hom}_S(A, C)$  becomes a left  $R$ -module, and  $A \otimes_R B$  becomes a left  $S$ -module. Prove that  $\text{Hom}_S(A \otimes_R B, C) \approx \text{Hom}_R(B, \text{Hom}_S(A, C))$  via the isomorphism of Theorem 2.4; that is,

$$\text{Hom}_S(A \otimes_R B, C) \subset \text{Hom}_{\mathbf{Z}}(A \otimes_R B, C)$$

corresponds to

$$\text{Hom}_R(B, \text{Hom}_S(A, C)) \subset \text{Hom}_R(B, \text{Hom}_Z(A, C)).$$

Hint: Show that each corresponds to the set of  $f \in \text{Bil}(A, B; C)$  that satisfy  $f(sa, b) = sf(a, b)$  for  $s \in S$ ,  $a \in A$ ,  $b \in B$ .

16. Suppose  $R$  is a PID, and  $a$  is a nonzero nonunit in  $R$ . Show that  $R/Ra$  is an injective module over itself.



# 3

## Ext and Tor

### 3.1 Complexes and Projective Resolutions

As stated in the last chapter, homological algebra is primarily concerned with measuring how much modules depart from being projective, injective, or flat. The measure of this is contained in two new sequences of functors, Tor and Ext. While there are several ways of defining these functors (a fact that is the source of some theorems), the most straightforward way is via complexes.

Recall that

$$A \xrightarrow{d} B \xrightarrow{\partial} C$$

is exact if  $\ker \partial = \operatorname{im} d$ . It is called a *complex* (or sometimes *underexact*) if  $\partial d = 0$ , that is, if the easier of the two conditions defining exactness is verified (see Section 2.3).

The *homology* of the complex is defined to be the quotient  $\ker \partial / \operatorname{im} d$ . The homology measures how much the sequence differs from being exact, that is, how underexact it is. It should not be all that surprising that certain homology groups will eventually specify how far a given module is from being injective, projective, or flat, since these concepts were defined in terms of the exactness of certain functors (see Section 2.4).

In general, we will have a long row (or column) which will be assumed to be a complex; that is, any composition of two homomorphisms along the row will be zero.

Suppose

$$\begin{array}{ccccc} A & \xrightarrow{d} & B & \xrightarrow{\partial} & C \\ \varphi \downarrow & & \psi \downarrow & & \eta \downarrow \\ A' & \xrightarrow{d'} & B' & \xrightarrow{\partial'} & C' \end{array}$$

commutes, with rows that are complexes. Set  $H = \ker \partial / \operatorname{im} d$ , and  $H' = \ker \partial' / \operatorname{im} d'$ . One can now define, using  $\psi$ , a homomorphism from  $H$  to  $H'$  via  $\psi_*(x + \operatorname{im} d) = \psi(x) + \operatorname{im} d'$ . The definition does not involve  $\varphi$  or  $\eta$ , but its internal consistency does:

- i)  $\psi_*$  is well-defined thanks to the presence of  $\varphi$ . If  $x + \operatorname{im} d = y + \operatorname{im} d$ , then  $x - y \in \operatorname{im} d \Rightarrow x - y = d(z) \Rightarrow \psi(x - y) = \psi d(z) = d' \varphi(z)$  so that  $\psi(x) - \psi(y) \in \operatorname{im} d'$ , that is,  $\psi(x) + \operatorname{im} d' = \psi(y) + \operatorname{im} d'$ .
- ii)  $\psi_*$  takes values in  $H'$  (not just in  $B' / \operatorname{im} d'$ ) thanks to the presence of  $\eta$ . If  $x \in \ker \partial$ , then  $\partial'(\psi(x)) = \eta \partial(x) = 0$ , so that  $\psi(x) \in \ker \partial'$ , and  $\psi(x) + \operatorname{im} d' \in H'$ .

The above describes how homomorphisms of homology arise. It is of major interest to know when different  $\varphi$ ,  $\psi$ , and  $\eta$  yield the same  $\psi_*$ . There are several reasons for this, among them being the fact that when we write the complexes later used to define Ext and Tor, some choices will be made, and we don't want our answers to depend on the choices. There is also the basic reason that it is just nice to know when two functions are equal.

The gimmick that does this is called a *homotopy*. Suppose

$$\begin{array}{ccccc} A & \xrightarrow{d} & B & \xrightarrow{\partial} & C \\ \downarrow \varphi' & & \downarrow \varphi' & & \downarrow \eta' \\ A' & \xrightarrow{d'} & B' & \xrightarrow{\partial'} & C' \end{array}$$

also commutes, along with the earlier diagram with unprimed  $\varphi$ ,  $\psi$ , and  $\eta$ . A homotopy is a pair of maps  $D : B \rightarrow A'$  and  $\Delta : C \rightarrow B'$  satisfying  $\psi - \psi' = d' D + \Delta \partial$ . When all the arrows are put in, we have the (decidedly noncommutative) diagram

$$\begin{array}{ccccc} A & \xrightarrow{d} & B & \xrightarrow{\partial} & C \\ \varphi \downarrow & \nearrow D & \psi \downarrow & \nearrow \Delta & \eta \downarrow \\ A' & \xrightarrow{d'} & B' & \xrightarrow{\partial'} & C' \end{array}$$

If a homotopy exists, then  $\psi_* = \psi'_*$ , since  $\psi(x) + \operatorname{im} d' = \psi'(x) + d' D(x) + \Delta \partial(x) + \operatorname{im} d' = \psi'(x) + d' D(x) + \operatorname{im} d'$  when  $x \in \ker \partial$ . But  $d' D(x) \in \operatorname{im} d'$ , so  $\psi'(x) + d' D(x) + \operatorname{im} d' = \psi'(x) + \operatorname{im} d'$ .

Why a homotopy? Isn't there an easier way? The advantage is that if  $F$  is a functor that is *additive*, that is,  $F(f + g) = F(f) + F(g)$  for morphisms  $f$  and  $g$ , then  $F$  sends a homotopy to a homotopy. Notice that we never specified what  $A, B, C$ , etc. were. Typically, they are  $R$ -modules, and  $F$  is an additive functor into  $\mathbf{Ab}$ . The complex starts out exact in  ${}_R\mathbf{M}$  (or  $\mathbf{M}_R$ ), but applying  $F$  makes it underexact.

By the way, the term "homotopy" comes from algebraic topology. Homology groups of topological spaces are, in fact, homology groups of certain complexes, and continuous functions yield homomorphisms of the complexes ( $\varphi, \psi$ , and  $\eta$ ). Homotopic continuous functions yield homotopic homomorphisms.

Back to  $R$ -modules. Suppose  $B \in {}_R\mathbf{M}$ . A *projective resolution* of  $B$ , denoted  $\langle P_n, d_n \rangle$ , is an exact sequence of  $R$ -modules

$$\cdots \longrightarrow P_{n+1} \xrightarrow{d_{n+1}} P_n \xrightarrow{d_n} \cdots \longrightarrow P_1 \xrightarrow{d_1} P_0 \xrightarrow{\pi} B \longrightarrow 0$$

going off to infinity to the left, in which all  $P_n$  are projective. Any left  $R$ -module has a projective resolution, which can be assembled recursively as follows using the fact that there are enough projectives:

Choose  $P_0$ , and  $\pi : P_0 \rightarrow B$  onto.

Choose  $P_1$ , and  $d_1 : P_1 \rightarrow \ker \pi$  onto.

Choose  $P_2$ , and  $d_2 : P_2 \rightarrow \ker d_1$  onto.

Etc.

(By the way, there is a reason for using the notation  $\pi : P_0 \rightarrow B$  as will become evident. Also, our constructions will eventually ignore  $\pi$ , so it has been left from the  $\langle P_n, d_n \rangle$  notation. We set  $d_0 = 0$ .) As noted earlier, there are choices involved here. The extent to which the choices drop out is covered by the following proposition.

**Proposition 3.1** *Suppose  $B, B' \in {}_R\mathbf{M}$ , and  $\varphi \in \text{Hom}(B, B')$ . Suppose  $\langle P_n, d_n \rangle$  is a projective resolution of  $B$ , and  $\langle P'_n, d'_n \rangle$  is a projective resolution of  $B'$ . Then there exist fillers  $\varphi_n \in \text{Hom}(P_n, P'_n)$  making*

$$\begin{array}{ccccccccccccccc} \cdots & \longrightarrow & P_{n+1} & \xrightarrow{d_{n+1}} & P_n & \xrightarrow{d_n} & \cdots & \longrightarrow & P_1 & \xrightarrow{d_1} & P_0 & \xrightarrow{\pi} & B & \longrightarrow & 0 \\ & & | & & | & & & & | & & | & & | & & \downarrow \varphi \\ & & | \varphi_{n+1} & & | \varphi_n & & & & | \varphi_1 & & | \varphi_0 & & & & \\ & & \downarrow & & \downarrow & & & & \downarrow & & \downarrow & & & & \\ \cdots & \longrightarrow & P'_{n+1} & \xrightarrow{d'_{n+1}} & P'_n & \xrightarrow{d'_n} & \cdots & \longrightarrow & P'_1 & \xrightarrow{d'_1} & P'_0 & \xrightarrow{\pi'} & B' & \longrightarrow & 0 \end{array}$$

*commutative. Further, if  $\varphi'_n \in \text{Hom}(P_n, P'_n)$  also serve as fillers, then  $\varphi_n$  and  $\varphi'_n$  are homotopic, that is, there exist  $D_n : P_n \rightarrow P'_{n+1}$  (with  $D_{-1} \equiv 0$ ) such that  $\varphi_n - \varphi'_n = d'_{n+1}D_n + D_{n-1}d_n$ .*

**Proof:** Define  $\varphi_0$  as a filler for

$$\begin{array}{ccc}
 & P_0 & \\
 & \swarrow \varphi_0 & \downarrow \pi \\
 & B & \\
 \swarrow & & \downarrow \varphi \\
 P'_0 & \xrightarrow{\pi'} & B' \longrightarrow 0.
 \end{array}$$

Suppose  $\varphi_0, \dots, \varphi_n$  have been defined; we define  $\varphi_{n+1}$  recursively. Note first that  $x \in \text{im } d_{n+1} \Rightarrow d_n(x) = 0 \Rightarrow 0 = \varphi_{n-1}d_n(x) = d'_n\varphi_n(x)$ . That is,  $\varphi_n(\text{im } d_{n+1}) \subset \ker d'_n = \text{im } d'_{n+1}$ . (This works if  $n > 0$ ; essentially the same argument works if  $n = 0$ , replacing  $d_0$  with  $\pi$ .) We can thus find  $\varphi_{n+1}$  as a filler for

$$\begin{array}{ccc}
 & P_{n+1} & \\
 & \swarrow \varphi_{n+1} & \downarrow d_{n+1} \\
 & \text{im } d_{n+1} & \\
 \swarrow & & \downarrow \varphi_n \\
 P'_{n+1} & \xrightarrow{d'_{n+1}} & \text{im } d'_{n+1} \longrightarrow 0.
 \end{array}$$

It remains to show any two fillers are homotopic. The  $D_n$  are constructed recursively, too.  $D_{-1} = 0$  is given. As above, the recursion step is much like the construction of  $D_0$ . Note that  $\pi'\varphi_0 = \varphi\pi = \pi'\varphi'_0$ , that is,  $\pi'(\varphi_0 - \varphi'_0) = 0$ . Thus  $\varphi_0 - \varphi'_0$  takes values in  $\ker \pi' = \text{im } d'_1$ .  $D_0$  is a filler for

$$\begin{array}{ccc}
 & P_0 & \\
 & \swarrow D_0 & \downarrow \varphi_0 - \varphi'_0 \\
 & \text{im } d'_1 & \\
 \swarrow & & \\
 P'_1 & \xrightarrow{d'_1} & \text{im } d'_1 \longrightarrow 0.
 \end{array}$$

We now suppose we are given  $D_0, \dots, D_n$ . In this case, we know that  $\varphi_n - \varphi'_n = d'_{n+1}D_n + D_{n-1}d_n$ , so that

$$\begin{aligned}
 d'_{n+1}(\varphi_{n+1} - \varphi'_{n+1} - D_n d_{n+1}) &= d'_{n+1}\varphi_{n+1} - d'_{n+1}\varphi'_{n+1} - d'_{n+1}D_n d_{n+1} \\
 &= \varphi_n d_{n+1} - \varphi'_n d_{n+1} - d'_{n+1}D_n d_{n+1} \\
 &= (\varphi_n - \varphi'_n - d'_{n+1}D_n)d_{n+1} \\
 &= D_{n-1}d_n d_{n+1} \\
 &= 0.
 \end{aligned}$$

That is,  $\text{im}(\varphi_{n+1} - \varphi'_{n+1} - D_n d_{n+1}) \subset \ker d'_{n+1} = \text{im } d'_{n+2}$ . (This works without change if  $n = 0$ .) Hence,  $D_{n+1}$  can be constructed as a filler for

$$\begin{array}{ccc} & P_{n+1} & \\ & \swarrow D_{n+1} & \downarrow \varphi_{n+1} - \varphi'_{n+1} - D_n d_{n+1} \\ P'_{n+2} & \xrightarrow{d'_{n+2}} & \text{im } d'_{n+2} \longrightarrow 0. \end{array}$$

□

Of course, any projective resolution is exact (by construction), and so has zero homology as a complex. But if  $F$  is any additive functor (so that, in addition,  $F(0) = F(0 + 0) = F(0) + F(0) \Rightarrow F(0) = 0$ ), applying  $F$  to the resolution yields a complex that *may* have nontrivial homology, and the fillers and homotopies are preserved.

We now define Tor. Let  $A \in \mathbf{M}_R$ . Apply  $A \otimes$  to any projective resolution of  $B$ , and drop the last  $A \otimes B$  term, giving

$$\begin{aligned} \dots &\longrightarrow A \otimes P_{n+1} \xrightarrow{A \otimes d_{n+1}} A \otimes P_n \xrightarrow{A \otimes d_n} \dots \\ \dots &\longrightarrow A \otimes P_1 \xrightarrow{A \otimes d_1} A \otimes P_0 \xrightarrow{A \otimes d_0} 0. \end{aligned}$$

(We will see later why  $A \otimes B$  is dropped: It reappears via Proposition 3.2(a).) The  $n$ th homology of this complex,  $\ker(A \otimes d_n) / \text{im}(A \otimes d_{n+1})$ , will be isomorphic to  $\text{Tor}_n(A, B)$  (or  $\text{Tor}_n^R(A, B)$ , if  $R$  is to be emphasized). First, observe that, up to isomorphism, the homology is independent of the projective resolution. Setting  $B = B'$ , and  $\varphi = i_B$ , and applying Proposition 3.1 twice gives

$$\begin{array}{ccccccccccc} \dots & \longrightarrow & P_{n+1} & \xrightarrow{d_{n+1}} & P_n & \xrightarrow{d_n} & \dots & \longrightarrow & P_1 & \xrightarrow{d_1} & P_0 & \xrightarrow{\pi} & B & \longrightarrow & 0 \\ & & \downarrow \varphi_{n+1} & & \downarrow \varphi_n & & & & \downarrow \varphi_1 & & \downarrow \varphi_0 & & \downarrow i_B & & \\ \dots & \longrightarrow & P'_{n+1} & \xrightarrow{d'_{n+1}} & P'_n & \xrightarrow{d'_n} & \dots & \longrightarrow & P'_1 & \xrightarrow{d'_1} & P'_0 & \xrightarrow{\pi'} & B & \longrightarrow & 0 \\ & & \downarrow \psi_{n+1} & & \downarrow \psi_n & & & & \downarrow \psi_1 & & \downarrow \psi_0 & & \downarrow i_B & & \\ \dots & \longrightarrow & P_{n+1} & \xrightarrow{d_{n+1}} & P_n & \xrightarrow{d_n} & \dots & \longrightarrow & P_1 & \xrightarrow{d_1} & P_0 & \longrightarrow & B & \longrightarrow & 0 \end{array}$$

Now by the proposition,  $\psi_n \varphi_n$  is homotopic to  $i_{P_n}$ , so  $(A \otimes \psi_n)_* (A \otimes \varphi_n)_* =$  identity on the  $n$ th homology. Reversing the roles of  $\langle P_n, d_n \rangle$  and  $\langle P'_n, d'_n \rangle$  yields the independence of projective resolution.

**Example 9**  $R = \mathbb{Z}_4$ ,  $A = B = \mathbb{Z}_2$ . A projective resolution of  $\mathbb{Z}_2$  is

$$\dots \longrightarrow \mathbb{Z}_4 \xrightarrow{\times 2} \mathbb{Z}_4 \xrightarrow{\times 2} \mathbb{Z}_4 \xrightarrow{\times 2} \mathbb{Z}_4 \xrightarrow{\pi} \mathbb{Z}_2 \longrightarrow 0.$$



Tensoring with  $\mathbb{Z}_2$  and deleting gives

$$\cdots \longrightarrow \mathbb{Z}_2 \xrightarrow{0} \mathbb{Z}_2 \xrightarrow{0} \mathbb{Z}_2 \xrightarrow{0} \mathbb{Z}_2 \longrightarrow 0$$

so that  $\text{Tor}_n^{\mathbb{Z}_2}(\mathbb{Z}_2, \mathbb{Z}_2) \approx \mathbb{Z}_2$  for all  $n$ .

For each  $B \in {}_R\mathbf{M}$ , choose a projective resolution of  $B$ . (Note: The axiom of choice from Gödel–Bernays–von Neumann class theory will be used in Chapter 6 to choose injective resolutions. Here one can define  $P_0$  as the free module on  $B$ ,  $P_1$  the free module on  $\ker \pi$ , etc. “The” free module on  $S$  is the direct sum of  $|S|$  copies of  $R$ , specifically parametrized by  $S$ .)  $\text{Tor}_n(A, B)$  is now the homology with this projective resolution. This way Tor is actually a group, not an isomorphism class of groups.

Note that by using  $(A \otimes \varphi_n)_*$ , where  $\langle \varphi_n \rangle$  is manufactured from  $\varphi \in \text{Hom}(B, B')$  using Proposition 3.1, we get that  $\text{Tor}_n(A, \bullet)$  is a covariant functor from  ${}_R\mathbf{M}$  to  $\mathbf{Ab}$ . Also, this functor is additive, since if  $\langle \varphi_n \rangle$  is a filler for  $\varphi \in \text{Hom}(B, B')$ , and  $\langle \psi_n \rangle$  is a filler for  $\psi \in \text{Hom}(B, B')$ , then  $\langle \varphi_n + \psi_n \rangle$  is a filler for  $\varphi + \psi$ . In particular, if  $B \in {}_R\mathbf{M}_S$ , then applying this to the morphisms right-multiplication-from- $S$  yields the fact that  $\text{Tor}_n^R(A, B)$  has the structure of a right  $S$ -module.

$\text{Tor}_n(\bullet, B)$  is also a functor, in fact an additive functor, since if  $A, A' \in \mathbf{M}_R$  and  $f \in \text{Hom}(A, A')$ , we have a commutative diagram

$$\begin{array}{ccccccc} \cdots & \longrightarrow & A \otimes P_{n+1} & \xrightarrow{A \otimes d_{n+1}} & A \otimes P_n & \xrightarrow{A \otimes d_n} & \cdots \longrightarrow A \otimes P_1 \xrightarrow{A \otimes d_1} A \otimes P_0 \xrightarrow{A \otimes d_0} 0 \\ & & \downarrow f \otimes P_{n+1} & & \downarrow f \otimes P_n & & \downarrow f \otimes P_1 & & \downarrow f \otimes P_0 \\ \cdots & \longrightarrow & A' \otimes P_{n+1} & \xrightarrow{A' \otimes d_{n+1}} & A' \otimes P_n & \xrightarrow{A' \otimes d_n} & \cdots \longrightarrow A' \otimes P_1 \xrightarrow{A' \otimes d_1} A' \otimes P_0 \xrightarrow{A' \otimes d_0} 0. \end{array}$$

One can verify that the resulting  $\text{Tor}_n(f, B)$  is independent of the projective resolution by considering the three-dimensional diagram (gulp!) whose typical block is given by

$$\begin{array}{ccccccc} \cdots & \longrightarrow & A \otimes P_{n+1} & \xrightarrow{A \otimes d_{n+1}} & A \otimes P_n & \xrightarrow{A \otimes d_n} & \cdots \\ & & \downarrow A \otimes \varphi_{n+1} & & \downarrow A \otimes \varphi_n & & \\ \cdots & \longrightarrow & A \otimes P'_{n+1} & \xrightarrow{A \otimes d'_{n+1}} & A \otimes P'_n & \xrightarrow{A \otimes d'_n} & \cdots \\ & & \downarrow f \otimes P_{n+1} & & \downarrow f \otimes P_n & & \\ \cdots & \longrightarrow & A' \otimes P_{n+1} & \xrightarrow{A' \otimes d_{n+1}} & A' \otimes P_n & \xrightarrow{A' \otimes d_n} & \cdots \\ & & \downarrow A' \otimes \varphi_{n+1} & & \downarrow A' \otimes \varphi_n & & \\ \cdots & \longrightarrow & A' \otimes P'_{n+1} & \xrightarrow{A' \otimes d'_{n+1}} & A' \otimes P'_n & \xrightarrow{A' \otimes d'_n} & \cdots \end{array}$$

Commutativity is verified on the various squares. The vertical arrows yield  $\text{Tor}_n(f, B)$  in the homology of the two resolutions. This also shows



(when  $\langle P'_n, d'_n \rangle$  is a projective resolution of  $B'$  and  $\varphi \in \text{Hom}(B, B')$ ) that  $\text{Tor}_n(f, B')\text{Tor}_n(A, \varphi) = \text{Tor}_n(A', \varphi)\text{Tor}_n(f, B)$ . That is, following the geometry of the diagram,

$$\begin{array}{ccc}
 \text{Tor}_n(A, B) & & \\
 \downarrow \text{Tor}_n(f, B) & \searrow \text{Tor}_n(A, \varphi) & \\
 & & \text{Tor}_n(A, B') \\
 & & \downarrow \text{Tor}_n(f, B') \\
 \text{Tor}_n(A', B) & & \text{Tor}_n(A', B') \\
 \searrow \text{Tor}_n(A', \varphi) & & \\
 & & 
 \end{array}$$

is commutative. (Functors of two variables with this property are called *bifunctors*.)

The functor  $\text{Ext}$  is defined by a similar device. If  $C \in {}_R\mathbf{M}$ , apply  $\text{Hom}_R(\bullet, C)$  to the chosen projective resolution of  $B$ , yielding

$$\begin{array}{ccccccc}
 \cdots & \longleftarrow & \text{Hom}(P_1, C) & \xleftarrow{\text{Hom}(d_1, C)} & \text{Hom}(P_0, C) & \xleftarrow{\text{Hom}(d_0, C)} & 0 \\
 & & & & & & \\
 \cdots & \longleftarrow & \text{Hom}(P_{n+1}, C) & \xleftarrow{\text{Hom}(d_{n+1}, C)} & \text{Hom}(P_n, C) & \xleftarrow{\text{Hom}(d_n, C)} & \cdots
 \end{array}$$

with  $\text{Hom}(B, C)$  deleted as before. The  $n$ th homology of this is  $\text{Ext}^n(B, C)$  (or  $\text{Ext}_R^n(B, C)$  if  $R$  is to be emphasized).<sup>1</sup> Again, even though directions are reversed (since  $\text{Hom}(\bullet, C)$  is contravariant), different projective resolutions give isomorphic homology, and everything in sight is well defined. Also, if  $B \in {}_R\mathbf{M}_S$ , then  $\text{Ext}_R^n(B, C)$  has the structure of a *left*  $S$ -module. It is a useful exercise to check exactly what the bifunctor condition means for  $\text{Ext}$ .

**Example 10** Let  $B = \mathbb{Z}_p$ ,  $R = \mathbb{Z}$ . As a projective resolution, use  $\cdots \rightarrow 0 \rightarrow \mathbb{Z} \rightarrow \mathbb{Z} \rightarrow \mathbb{Z}_p \rightarrow 0$ . The map from  $\mathbb{Z}$  to  $\mathbb{Z}$  is multiplication by  $p$ . Tensoring with  $A$  and deleting, we get

$$\cdots \longrightarrow 0 \longrightarrow 0 \longrightarrow \cdots \longrightarrow 0 \longrightarrow A \xrightarrow{\times p} A \longrightarrow 0.$$

Hence,  $\text{Tor}_0^{\mathbb{Z}}(A, \mathbb{Z}_p) \approx A/pA$ , while  $\text{Tor}_1^{\mathbb{Z}}(A, \mathbb{Z}_p) \approx \{x \in A : px = 0\}$ . Similarly, applying  $\text{Hom}(\bullet, C)$  gives

$$\cdots \longleftarrow 0 \longleftarrow 0 \longleftarrow \cdots \longleftarrow 0 \longleftarrow C \xleftarrow{\times p} C \longleftarrow 0$$

<sup>1</sup> $n$  is a superscript for  $\text{Ext}$  since  $\text{Ext}^n(B, C)$  is contravariant in  $B$ , and it is an ancient convention that contravariant functors be indexed by superscripts.

so  $\text{Ext}_{\mathbb{Z}}^0(\mathbb{Z}_p, C) \approx \{x \in C : px = 0\}$  and  $\text{Ext}_{\mathbb{Z}}^1(\mathbb{Z}_p, C) \approx C/pC$ .

We close this section with the elementary properties of Tor and Ext.

**Proposition 3.2** *If  $A \in \mathbf{M}_R$ ,  $B \in {}_R\mathbf{M}$ ,  $C \in {}_R\mathbf{M}$ , then*

- a)  $\text{Tor}_0(A, B) \approx A \otimes B$ .
- b)  $\text{Ext}^0(B, C) \approx \text{Hom}(B, C)$ .
- c)  $\text{Tor}_n(A, B) = 0$  if  $A$  is flat or  $B$  is projective,  $n \geq 1$ .
- d)  $\text{Ext}^n(B, C) = 0$  if  $B$  is projective or  $C$  is injective,  $n \geq 1$ .

**Proof:** First (a). Since  $A \otimes$  is right exact, the sequence

$$A \otimes P_1 \xrightarrow{A \otimes d_1} A \otimes P_0 \xrightarrow{A \otimes \pi} A \otimes B \longrightarrow 0$$

is exact. Hence,  $A \otimes B \approx A \otimes P_0 / \text{im}(A \otimes d_1) = \text{Tor}_0(A, B)$ . The proof of (b) is similar, since  $\text{Hom}(\bullet, C)$  is left exact.

If  $A$  is flat and  $n \geq 1$ , then  $A \otimes P_{n+1} \rightarrow A \otimes P_n \rightarrow A \otimes P_{n-1}$  is exact since  $A \otimes$  is an exact functor. Hence,  $\text{Tor}_n(A, B) = 0$  for  $n > 0$ . The proof that  $\text{Ext}^n(B, C) = 0$  if  $C$  is injective works pretty much the same way.

Finally, if  $B$  is projective, then

$$\longrightarrow 0 \longrightarrow 0 \longrightarrow \cdots \longrightarrow 0 \longrightarrow B \longrightarrow B \longrightarrow 0$$

is a projective resolution of  $B$ . Applying  $A \otimes$  and deleting the last term gives just

$$\longrightarrow 0 \longrightarrow 0 \longrightarrow \cdots \longrightarrow 0 \longrightarrow A \otimes B \longrightarrow 0.$$

Hence,  $\text{Tor}_n(A, B) = 0$  for  $n \geq 1$ . Again, Ext works virtually the same way. □

The reader who has been wondering how two functors could measure three properties (departure from flatness, projectivity, or injectivity) now has an answer:  $\text{Ext}(B, C)$  simultaneously measures departure of  $B$  from projectivity and departure of  $C$  from injectivity. By the way, this proposition is not definitive; it will turn out that  $\text{Tor}_n(A, B) = 0$  whenever  $B$  is flat in  ${}_R\mathbf{M}$  and  $n > 0$ .  $\text{Tor}(A, B)$  will simultaneously measure unflatness of  $A$  (in  $\mathbf{M}_R$ ) and  $B$  (in  ${}_R\mathbf{M}$ ).

Also, the proof of Proposition 3.2 shows why we never applied  $\text{Hom}(C, \bullet)$  to a projective resolution. The analog of property (b) would not hold, since  $\text{Hom}(C, \bullet)$  is not right exact. This failure will be more significant in the next section, where we relate  $\text{Ext}^n$  to  $\text{Ext}^{n+1}$ . The fact that  $\text{Hom}(C, \bullet)$  is left exact suggests that something *can* be done. The thoroughly remarkable result of this (to be discussed in Section 3) will be a cloning of the same Ext we got here. Onward!

## 3.2 Long Exact Sequences

We now have the definitions of Ext and Tor. As in most of mathematics, this is hardly enough to either compute or derive relations. Among other things, we have no relationship between  $\text{Ext}^n$  and  $\text{Ext}^m$  (or  $\text{Tor}_n$  and  $\text{Tor}_m$ ). This kind of thing would be very helpful, as eventually it would lead down to Hom (respectively,  $\otimes$ ). Long exact sequences provide the mechanism to do this. In this section we shall describe how these long exact sequences arise, and derive two of them (one each for Ext and Tor).

First, how they arise. For this purpose, a *chain complex* will denote a complex  $\mathcal{C} = \langle C_i, d_i \rangle$  of Abelian groups, with  $d_i : C_i \rightarrow C_{i-1}$ , and with  $i$  coming in from  $\infty$ . There are two standard conventions (lucky us!): In one, the  $C_i$  also go off to  $-\infty$ , while in the other the  $C_i$  terminate at  $i = 0$  (so  $d_0 = 0$ ). The second can be thought of as a special case of the first (with  $C_i = 0$  for  $i < 0$ ), so we adopt the first convention now. Nevertheless, when forming the *category* of chain complexes, there is good reason to adopt the second convention because of the way tensor products of two complexes eventually get defined. (More on this in Section 9.3.) We don't need this now; it is easier to have  $C_i$  defined for all integer  $i$ . That way we can apply our results to cochain complexes: A *cochain complex*  $\langle C_i, \partial_i \rangle$  is a complex where  $\partial_i : C_{i-1} \rightarrow C_i, i \in \mathbb{Z}$ . (The indexing matches the complex defining Ext.) We can get a chain complex by replacing  $i$  with  $-i$  and adjusting the subscript on  $\partial$ .

To define a category  $\text{Ch}$  of chain complexes, we need to define what the morphisms are. This should be no surprise. If  $\mathcal{C} = \langle C_i, d_i \rangle$  and  $\mathcal{C}' = \langle C'_i, d'_i \rangle$  are chain complexes, then a morphism  $\varphi = \langle \varphi_i \rangle$  from  $\mathcal{C}$  to  $\mathcal{C}'$  is a sequence of homomorphisms  $\varphi_i : C_i \rightarrow C'_i$  such that

$$\begin{array}{ccccccc} \cdots & \longrightarrow & C_i & \xrightarrow{d_i} & C_{i-1} & \longrightarrow & \cdots \\ & & \downarrow \varphi_i & & \downarrow \varphi_{i-1} & & \\ \cdots & \longrightarrow & C'_i & \xrightarrow{d'_i} & C'_{i-1} & \longrightarrow & \cdots \end{array}$$

commutes. A morphism of chain complexes is called a *chain map*. Note that for all  $n$ , the  $n$ th homology  $H_n$  is now an additive covariant functor from  $\text{Ch}$  to  $\text{Ab}$ .

A *short exact sequence* of chain complexes

$$0 \longrightarrow \mathcal{C} \xrightarrow{\varphi} \mathcal{C}' \xrightarrow{\psi} \mathcal{C}'' \longrightarrow 0$$



**Proof:** We first define  $\delta_n$ . Consider the diagram

$$\begin{array}{ccccccc}
 & & \vdots & & \vdots & & \vdots \\
 & & \downarrow & & \downarrow & & \downarrow \\
 0 & \longrightarrow & C_n & \xrightarrow{\varphi_n} & C'_n & \xrightarrow{\psi_n} & C''_n \longrightarrow 0 \\
 & & \downarrow d_n & & \downarrow d'_n & & \downarrow d''_n \\
 0 & \longrightarrow & C_{n-1} & \xrightarrow{\varphi_{n-1}} & C'_{n-1} & \xrightarrow{\psi_{n-1}} & C''_{n-1} \longrightarrow 0 \\
 & & \downarrow & & \downarrow & & \downarrow \\
 & & \vdots & & \vdots & & \vdots
 \end{array}$$

and suppose  $x \in C''_n$  with  $d''_n(x) = 0$ .  $\psi_n$  is onto, so  $\exists y \in C'_n$  with  $\psi_n(y) = x$ . Now  $0 = d''_n(x) = d''_n\psi_n(y) = \psi_{n-1}d'_n(y)$ , so  $d'_n(y) \in \ker \psi_{n-1} = \text{im } \varphi_{n-1}$ . We define  $\delta_n(x + \text{im } d''_{n+1})$  to be the coset of that  $z \in C_{n-1}$  for which  $\varphi_{n-1}(z) = d'_n(y)$ . There are now a large number of things to check:

- (i)  $z + \text{im } d_n$  is independent of the choice of  $y$ : If  $\psi_n(y') = x$ , then  $\psi_n(y - y') = 0$ , so  $y - y' \in \ker \psi_n = \text{im } \varphi_n$ , so  $y - y' = \varphi_n(t)$ , for some  $t \in C_n$ . Hence,  $d'_n(y) - d'_n(y') = d'_n(y - y') = d'_n\varphi_n(t) = \varphi_{n-1}d_n(t)$ . Hence, if  $d'_n(y) = \varphi_{n-1}(z)$  and  $d'_n(y') = \varphi_{n-1}(z')$ , then (since  $\varphi_{n-1}$  is one-to-one)  $z - z' = d_n(t) \in \text{im } d_n$ , so  $z + \text{im } d_n = z' + \text{im } d_n$ .
- (ii)  $z + \text{im } d_n \in H_{n-1}(C)$ , that is,  $d_{n-1}(z) = 0$ :  $\varphi_{n-2}d_{n-1}(z) = d'_{n-1}\varphi_{n-1}(z) = d'_{n-1}d'_n(y) = 0$ , so  $d_{n-1}(z) = 0$ , since  $\varphi_{n-2}$  is one-to-one.
- (iii) If  $x \in \text{im } d''_{n+1}$ , then  $z \in \text{im } d_n$ : If  $x = d''_{n+1}(s)$ , choose  $u \in C'_{n+1}$  such that  $\psi_{n+1}(u) = s$  (possible since  $\psi_{n+1}$  is onto). Then  $x = d''_{n+1}\psi_{n+1}(u) = \psi_n d'_{n+1}(u)$ , so we may take  $y = d'_{n+1}(u)$ . But then  $d'_n(y) = 0$  so we take  $z = 0$ . By (i), any other choice of  $y$  gives a  $z \in 0 + \text{im } d_n = \text{im } d_n$ .

At this point we know that  $x \mapsto z + \text{im } d_n$  yields a well-defined map from  $\ker d''_n$  to  $H_{n-1}(C)$  which is zero on  $\text{im } d''_{n+1}$ , so that  $\delta_n$  is well-defined. (When different  $x$ 's are added together, the chosen  $y$ 's can also be added, so  $\delta_n$  is a homomorphism.) We next check exactness at the slots involving  $\delta_n$ :

- (iv)  $\ker \delta_n \supset \text{im } H_n(\psi)$ : If  $x + \text{im } d''_{n+1} \in \text{im } H_n(\psi)$ , then we may take  $y$  to be such that  $H_n(\psi)(y + \text{im } d''_{n+1}) = x + \text{im } d''_{n+1}$ , since all that was required of  $y$  was that  $\psi_n(y) = x$ . That is, we may replace  $x$  with  $\psi_n(y)$  without changing the coset of  $\text{im } d''_{n+1}$  in  $H_n(C'')$ . But for this  $y$  and  $x$ ,  $d'_n(y) = 0$ , since it represents a homology class in  $H_n(C')$ . Hence,  $z = 0$ , and  $\delta_n(x + \text{im } d''_{n+1}) = 0$ .



- (v)  $\ker \delta_n \subset \text{im } H_n(\psi)$ : If  $\delta_n(x + \text{im } d''_{n+1}) = 0$ , then  $z \in \text{im } d_n$ , that is,  $z = d_n(t)$  for some  $t \in C_n$ . Thus  $d'_n(y) = \varphi_{n-1}(z) = \varphi_{n-1}d_n(t) = d'_n\varphi_n(t)$ , that is,  $d'_n(y - \varphi_n(t)) = 0$ . However,  $\psi_n(y - \varphi_n(t)) = \psi_n(y) - \psi_n\varphi_n(t) = x - 0$ . Hence,  $H_n(\psi)(y - \varphi_n(t) + \text{im } d''_{n+1}) = x + \text{im } d''_n$ .
- (vi)  $\ker H_{n-1}(\varphi) \supset \text{im } \delta_n$ : From the definition,  $H_{n-1}(\varphi)\delta_n(x + \text{im } d''_{n+1}) = \varphi_{n-1}(z) + \text{im } d'_n = d'_n(y) + \text{im } d'_n = 0$ .
- (vii)  $\ker H_{n-1}(\varphi) \subset \text{im } \delta_n$ : If  $z + \text{im } d_n \in \ker H_{n-1}(\varphi)$ , then  $\varphi_{n-1}(z) \in \text{im } d'_n$ , that is,  $\varphi_{n-1}(z) = d'_n(y)$  for  $y \in C_n$ . Set  $x = \psi_n(y)$ . This is just the definition of  $\delta_n$  run backwards, so all we must do is check that  $x + \text{im } d''_{n+1} \in H_n(C'')$ , that is, that  $d''_n(x) = 0$  for the  $x$  defined here. But  $d''_n(x) = d''_n\psi_n(y) = \psi_{n-1}d'_n(y) = \psi_{n-1}\varphi_{n-1}(z) = 0$ .

We still need exactness at the slot not involving  $\delta_n$ . Observe that  $H_n(\psi)H_n(\varphi) = H_n(\psi\varphi) = H_n(0) = 0$ , so at least  $\ker H_n(\psi) \supset \text{im } H_n(\varphi)$ .

- (viii)  $\ker H_n(\psi) \subset \text{im } H_n(\varphi)$ : Suppose  $H_n(\psi)(u + \text{im } d''_{n+1}) = 0$ . Then  $\psi_n(u) \in \text{im } d''_{n+1}$ , so  $\psi_n(u) = d''_{n+1}(v)$  for some  $v \in C''_{n+1}$ . Now  $\psi_{n+1}$  is onto, so  $v = \psi_{n+1}(w)$  for some  $w \in C'_{n+1}$ . Hence,

$$\psi_n(u) = d''_{n+1}(v) = d''_{n+1}\psi_{n+1}(w) = \psi_n d'_{n+1}(w)$$

or  $\psi_n(u - d'_{n+1}(w)) = 0$ . That is,  $u - d'_{n+1}(w) \in \ker \psi_n = \text{im } \varphi_n$ , so  $u - d'_{n+1}(w) = \varphi_n(t)$  for some  $t \in C_n$ . Now  $\varphi_{n-1}d_n(t) = d'_n\varphi_n(t) = d'_n(u) - d'_n d'_{n+1}(w) = 0$ , since  $u$  represents a homology class, so  $d_n(t) = 0$ , since  $\varphi_{n-1}$  is one-to-one. But now  $H_n(\varphi)(t + \text{im } d_{n+1}) = u + \text{im } d'_{n+1}$ .

What remains is naturality. This comes from a three-dimensional diagram chase. First note how  $\delta_n$  is defined via a "diagram":

$$\begin{array}{ccc} y & \xrightarrow{\psi_n} & x \\ & \downarrow d'_n & \\ z & \xrightarrow{\varphi_{n-1}} & * \end{array}$$

In this diagram, and others like it, the asterisk is used to signify the fact that the two arrows going to it have the same image. The three-dimensional



diagram is

$$\begin{array}{ccccccc}
 \vdots & & \vdots & & \vdots & & \vdots \\
 \downarrow & & \downarrow & & \downarrow & & \downarrow \\
 0 & \longrightarrow & C_n & \xrightarrow{\varphi_n} & C'_n & \xrightarrow{\psi_n} & C''_n & \longrightarrow & 0 \\
 & & \downarrow f_n & & \downarrow g_n & & \downarrow h_n & & \\
 & & \widehat{C}_n & \xrightarrow{\widehat{\varphi}_n} & \widehat{C}'_n & \xrightarrow{\widehat{\psi}_n} & \widehat{C}''_n & \longrightarrow & 0 \\
 & & \downarrow d_n & & \downarrow d'_n & & \downarrow d''_n & & \\
 0 & \longrightarrow & C_{n-1} & \xrightarrow{\varphi_{n-1}} & C'_{n-1} & \xrightarrow{\psi_{n-1}} & C''_{n-1} & \longrightarrow & 0 \\
 & & \downarrow f_{n-1} & & \downarrow g_{n-1} & & \downarrow h_{n-1} & & \\
 & & \widehat{C}_{n-1} & \xrightarrow{\widehat{\varphi}_{n-1}} & \widehat{C}'_{n-1} & \xrightarrow{\widehat{\psi}_{n-1}} & \widehat{C}''_{n-1} & \longrightarrow & 0 \\
 & & \downarrow \widehat{d}_n & & \downarrow \widehat{d}'_n & & \downarrow \widehat{d}''_n & & \\
 \vdots & & \vdots & & \vdots & & \vdots & & \\
 & & \downarrow & & \downarrow & & \downarrow & & \\
 & & \vdots & & \vdots & & \vdots & & 
 \end{array}$$

Now observe that one can chase

$$\begin{array}{ccccc}
 & & y & \xrightarrow{\psi_n} & x \\
 & & \downarrow d'_n & \searrow g_n & \downarrow h_n \\
 z & \xrightarrow{\varphi_{n-1}} & * & & \widetilde{y} & \xrightarrow{\widetilde{\psi}_n} & \widetilde{x} \\
 & & \downarrow f_{n-1} & & \downarrow \widetilde{d}'_n & & \\
 & & \widetilde{z} & \xrightarrow{\widetilde{\varphi}_{n-1}} & * & & 
 \end{array}$$

through the diagram. That is, if  $H_n(\mathbf{h})(x + \text{im } d''_{n+1}) = \widehat{x} + \text{im } \widehat{d}''_{n+1}$ , one can define the lower zigzag using the upper one, but *any* zigzag from  $\widehat{z}$  to  $\widehat{x}$  defines  $\widehat{\delta}_n(\widehat{x} + \text{im } \widehat{d}''_n)$ . Hence, we get  $H_{n-1}(\mathbf{f})(z + \text{im } d_n) = \widehat{z} + \text{im } \widehat{d}_n$ .  $\square$

It should be noted that, for cochain complexes, the analog of  $\delta_n$  increases the index on the homology. The maps  $\delta_n$  are called *connecting homomorphisms*. For consistency, the index on  $\delta_n$  is set to equal the index on the differential  $d'_n$  used to define it.

The following theorem is really a corollary to Theorem 3.3, but it is too important to be called a mere corollary.

**Theorem 3.4 a) (First Long Exact Sequence for Tor)** Suppose  $0 \rightarrow A \rightarrow A' \rightarrow A'' \rightarrow 0$  is short exact in  $\mathbf{M}_R$ . Then for all  $B \in {}_R\mathbf{M}$ , there is a long exact sequence

$$\begin{array}{c}
 \dots \longrightarrow \text{Tor}_{n+1}(A'', B) \xrightarrow{\delta_{n+1}} \\
 \text{Tor}_n(A, B) \longrightarrow \text{Tor}_n(A', B) \longrightarrow \text{Tor}_n(A'', B) \xrightarrow{\delta_n} \\
 \dots \longleftarrow \text{Tor}_1(A', B) \longrightarrow \text{Tor}_1(A'', B) \xrightarrow{\delta_1} \\
 A \otimes B \longrightarrow A' \otimes B \longrightarrow A'' \otimes B \longrightarrow 0
 \end{array}$$

b) **(First Long Exact Sequence for Ext).** Suppose  $0 \rightarrow C \rightarrow C' \rightarrow C'' \rightarrow 0$  is short exact in  ${}_R\mathbf{M}$ . Then for all  $B \in {}_R\mathbf{M}$ , there is a long exact sequence

$$\begin{array}{c}
 \text{Ext}^{n+1}(B, C) \longrightarrow \dots \\
 \text{Ext}^n(B, C) \longrightarrow \text{Ext}^n(B, C') \longrightarrow \text{Ext}^n(B, C'') \longrightarrow \dots \\
 \text{Ext}^1(B, C) \longrightarrow \text{Ext}^1(B, C') \longrightarrow \dots \\
 0 \longrightarrow \text{Hom}(B, C) \longrightarrow \text{Hom}(B, C') \longrightarrow \text{Hom}(B, C'')
 \end{array}$$

**Proof:** For Tor, tensor  $0 \rightarrow A \rightarrow A' \rightarrow A'' \rightarrow 0$  with a projective resolution  $\langle P_i, d_i \rangle$  of  $B$ , giving

$$\begin{array}{ccccccc}
 & \vdots & & \vdots & & \vdots & \\
 & \downarrow & & \downarrow & & \downarrow & \\
 0 & \longrightarrow & A \otimes P_n & \longrightarrow & A' \otimes P_n & \longrightarrow & A'' \otimes P_n \longrightarrow 0 \\
 & & \downarrow & & \downarrow & & \downarrow \\
 0 & \longrightarrow & A \otimes P_{n-1} & \longrightarrow & A' \otimes P_{n-1} & \longrightarrow & A'' \otimes P_{n-1} \longrightarrow 0 \\
 & & \downarrow & & \downarrow & & \downarrow \\
 & & \vdots & & \vdots & & \vdots \\
 & & \downarrow & & \downarrow & & \downarrow \\
 0 & \longrightarrow & A \otimes P_0 & \longrightarrow & A' \otimes P_0 & \longrightarrow & A'' \otimes P_0 \longrightarrow 0 \\
 & & \downarrow & & \downarrow & & \downarrow \\
 & & 0 & & 0 & & 0
 \end{array}$$

Rows are exact since each  $P_k$  is projective, hence flat, in  ${}_R\mathbf{M}$ . Apply Theorem 3.3 and the definition of Tor.

For Ext, a similar construction applied (via Hom) to  $0 \rightarrow C \rightarrow C' \rightarrow C'' \rightarrow 0$  and  $\langle P_i, d_i \rangle$  yields

$$\begin{array}{ccccccc}
 & \vdots & & \vdots & & \vdots & \\
 & \uparrow & & \uparrow & & \uparrow & \\
 0 & \longrightarrow & \text{Hom}(P_n, C) & \longrightarrow & \text{Hom}(P_n, C') & \longrightarrow & \text{Hom}(P_n, C'') \longrightarrow 0 \\
 & & \uparrow & & \uparrow & & \uparrow \\
 0 & \longrightarrow & \text{Hom}(P_{n-1}, C) & \longrightarrow & \text{Hom}(P_{n-1}, C') & \longrightarrow & \text{Hom}(P_{n-1}, C'') \longrightarrow 0 \\
 & & \uparrow & & \uparrow & & \uparrow \\
 & & \vdots & & \vdots & & \vdots \\
 & & \uparrow & & \uparrow & & \uparrow \\
 0 & \longrightarrow & \text{Hom}(P_0, C) & \longrightarrow & \text{Hom}(P_0, C') & \longrightarrow & \text{Hom}(P_0, C'') \longrightarrow 0 \\
 & & \uparrow & & \uparrow & & \uparrow \\
 & & 0 & & 0 & & 0
 \end{array}$$

Rows are exact since each  $P_k$  is projective. Columns are cochain complexes,

and their homology gives Ext by definition. Apply Theorem 3.3 (and the comment following the proof).  $\square$

**Corollary 3.5** *Suppose  $0 \rightarrow A \rightarrow F \rightarrow A' \rightarrow 0$  is short exact in  $\mathbf{M}_R$ , with  $F$  flat. Then  $\text{Tor}_n(A, B) \approx \text{Tor}_{n+1}(A', B)$  for all  $B \in {}_R\mathbf{M}$  and  $n \geq 1$ .*

**Proof:**  $0 = \text{Tor}_{n+1}(F, B) \rightarrow \text{Tor}_{n+1}(A', B) \rightarrow \text{Tor}_n(A, B) \rightarrow \text{Tor}_n(F, B) = 0$  is exact.  $\square$

**Corollary 3.6** *Suppose  $0 \rightarrow C \rightarrow E \rightarrow C' \rightarrow 0$  is short exact in  ${}_R\mathbf{M}$ , with  $E$  injective. Then  $\text{Ext}^n(B, C') \approx \text{Ext}^{n+1}(B, C)$  for all  $B \in {}_R\mathbf{M}$  and  $n \geq 1$ .*

**Proof:**  $0 = \text{Ext}^n(B, E) \rightarrow \text{Ext}^n(B, C') \rightarrow \text{Ext}^{n+1}(B, C) \rightarrow \text{Ext}^{n+1}(B, E) = 0$  is exact.  $\square$

(These two corollaries are examples of *dimension shifting*. There is much more of this to come.)

**Corollary 3.7** *Suppose  $B \in {}_R\mathbf{M}$ , and suppose  $\text{Tor}_1(R/I, B) = 0$  for every finitely generated right ideal  $I$ . Then  $B$  is flat.*

**Proof:** Applying Theorem 3.4(a) to  $0 \rightarrow I \rightarrow R \rightarrow R/I \rightarrow 0$  yields, in part,

$$0 = \text{Tor}_1(R/I, B) \rightarrow I \otimes B \rightarrow R \otimes B \approx B.$$

Hence  $I \otimes B \rightarrow IB$  is one-to-one. By the flat test lemma (Chapter 2, Exercise 11),  $B$  is flat.  $\square$

**Corollary 3.8** *Suppose  $B \in {}_R\mathbf{M}$ . The following are equivalent:*

- (i)  $B$  is projective.
- (ii) For all  $C \in {}_R\mathbf{M}$  and  $n \geq 1$ ,  $\text{Ext}^n(B, C) = 0$ .
- (iii) For all  $C \in {}_R\mathbf{M}$ ,  $\text{Ext}^1(B, C) = 0$ .

**Proof:** (i)  $\Rightarrow$  (ii) is Proposition 3.2(d). (ii)  $\Rightarrow$  (iii) is trivial. Given (iii), if  $0 \rightarrow C \rightarrow C' \rightarrow C'' \rightarrow 0$  is exact in  ${}_R\mathbf{M}$ , then Theorem 3.4(b) says, in part, that

$$0 \rightarrow \text{Hom}(B, C) \rightarrow \text{Hom}(B, C') \rightarrow \text{Hom}(B, C'') \rightarrow \text{Ext}^1(B, C) = 0$$

is exact, i.e.  $\text{Hom}(B, \bullet)$  is an exact functor. Hence  $B$  is projective.  $\square$

Clearly, Corollary 3.7 is not as satisfactory as Corollary 3.8, since Corollary 3.7 does not assert an equivalence of conditions. Further, we need to derive long exact sequences involving the variable we have called  $B$ . These issues will be addressed in Section 4.

### 3.3 Flat Resolutions and Injective Resolutions

It is now time to address seriously the question: What happens if, in  $A \otimes B$ , we form a resolution of  $A$  instead of  $B$ . Similarly, while a projective resolution of  $C$  does no service to  $\text{Hom}(B, C)$ , something ought to be possible. The resolutions of  $A$  will be flat resolutions; those of  $C$  will be injective resolutions.

A flat resolution  $\langle F_i, d_i \rangle$  of  $A \in \mathbf{M}_R$  is an exact sequence

$$\cdots \rightarrow F_n \xrightarrow{d_n} F_{n-1} \rightarrow \cdots \rightarrow F_1 \xrightarrow{d_1} F_0 \xrightarrow{\pi} A \rightarrow 0$$

where each  $F_n$  is flat; note that any projective resolution is a flat resolution, but not *vice versa*. Our immediate objective is to show that the  $n$ th homology of

$$\cdots \rightarrow F_n \otimes B \xrightarrow{d_n \otimes B} F_{n-1} \otimes B \rightarrow \cdots \rightarrow F_1 \otimes B \xrightarrow{d_1 \otimes B} F_0 \otimes B \rightarrow 0$$

is our old friend  $\text{Tor}_n(A, B)$ . There are a number of ways of going about this.

One method, which would only work for projective resolutions, would be to call the new functor “tor” (projectives are required to give a functor in the resolved variable), derive properties of tor, then do a dimension shifting argument to show that  $\text{tor} \approx \text{Tor}$ . Much later, one shows that flat resolutions produce the same result as projective resolutions.

Another method, whose organization is very similar to many homological algebra proofs, is carried out in three steps. To show that the  $n$ th homology is isomorphic to  $\text{Tor}_n$  by induction on  $n$ : (i) check the case  $n = 0$ ; (ii) check the case  $n = 1$ ; (iii) verify the induction step. Oddly, step (ii) is the hardest both here and generally; step (iii) works by replacing  $A$  with  $\text{im } d_1$ , and explicitly using what step (ii) says about the entries in the long exact sequence for  $\text{Tor}$  derived in the last section. This proof will be deferred to the exercises; it is the easiest of the proofs to carry out.

The approach here will be the “zigzag proof.” The advantage is that the isomorphism is displayed before one’s very eyes, allowing its naturality to be observed as well. This construction will also be used later in Sections 6.5 and 9.4. However, the version in Exercise 3 is sufficient for this chapter as an alternative approach. That is, if you solve Exercise 3 (and its analog for  $\text{Ext}$ , the first sentence of Corollary 3.12), then you have what you need for Section 3.4.

The fundamental idea behind the zigzag proof is to take the chosen projective resolution of  $B$  and tensor it with the flat resolution of  $A$ . After

deletion of  $A \otimes B$  we get the commutative diagram,

$$\begin{array}{ccccccccc}
 & \vdots & & \vdots & & \vdots & & \vdots & & \vdots \\
 & \downarrow & & \downarrow & & \downarrow & & \downarrow & & \downarrow \\
 \cdots & \rightarrow & F_3 \otimes P_3 & \rightarrow & F_3 \otimes P_2 & \rightarrow & F_3 \otimes P_1 & \rightarrow & F_3 \otimes P_0 & \rightarrow & F_3 \otimes B & \rightarrow & 0 \\
 & & \downarrow & & \downarrow & & \downarrow & & \downarrow & & \downarrow & & \\
 \cdots & \rightarrow & F_2 \otimes P_3 & \rightarrow & F_2 \otimes P_2 & \rightarrow & F_2 \otimes P_1 & \rightarrow & F_2 \otimes P_0 & \rightarrow & F_2 \otimes B & \rightarrow & 0 \\
 & & \downarrow & & \downarrow & & \downarrow & & \downarrow & & \downarrow & & \\
 \cdots & \rightarrow & F_1 \otimes P_3 & \rightarrow & F_1 \otimes P_2 & \rightarrow & F_1 \otimes P_1 & \rightarrow & F_1 \otimes P_0 & \rightarrow & F_1 \otimes B & \rightarrow & 0 \\
 & & \downarrow & & \downarrow & & \downarrow & & \downarrow & & \downarrow & & \\
 \cdots & \rightarrow & F_0 \otimes P_3 & \rightarrow & F_0 \otimes P_2 & \rightarrow & F_0 \otimes P_1 & \rightarrow & F_0 \otimes P_0 & \rightarrow & F_0 \otimes B & \rightarrow & 0 \\
 & & \downarrow & & \downarrow & & \downarrow & & \downarrow & & \downarrow & & \\
 \cdots & \rightarrow & A \otimes P_3 & \rightarrow & A \otimes P_2 & \rightarrow & A \otimes P_1 & \rightarrow & A \otimes P_0 & \rightarrow & 0 & \rightarrow & 0 \\
 & & \downarrow & & \downarrow & & \downarrow & & \downarrow & & \downarrow & & \\
 & & 0 & & 0 & & 0 & & 0 & & 0 & & 
 \end{array}$$

Observe that all rows but the bottom are exact (since all  $F_j$  are flat), while all columns but the rightmost are exact (since all  $P_j$  are projective, hence flat, in  ${}_R M$ ). We now quote a general result:

**Proposition 3.9** *Suppose  $C_{i,j}, d_{i,j}, \partial_{i,j}$  form a commutative array in  $\mathbf{Ab}$  (with rows and columns being complexes):*

$$\begin{array}{ccccccccc}
 & \vdots & & \vdots & & \vdots & & \vdots & & \vdots \\
 & \downarrow & & \downarrow & & \downarrow & & \downarrow & & \downarrow \\
 \cdots & \rightarrow & C_{3,3} & \xrightarrow{d_{3,3}} & C_{3,2} & \xrightarrow{d_{3,2}} & C_{3,1} & \xrightarrow{d_{3,1}} & C_{3,0} & \xrightarrow{d_{3,0}} & 0 \\
 & & \downarrow \partial_{3,3} & & \downarrow \partial_{3,2} & & \downarrow \partial_{3,1} & & \downarrow \partial_{3,0} & & \\
 \cdots & \rightarrow & C_{2,3} & \xrightarrow{d_{2,3}} & C_{2,2} & \xrightarrow{d_{2,2}} & C_{2,1} & \xrightarrow{d_{2,1}} & C_{2,0} & \xrightarrow{d_{2,0}} & 0 \\
 & & \downarrow \partial_{2,3} & & \downarrow \partial_{2,2} & & \downarrow \partial_{2,1} & & \downarrow \partial_{2,0} & & \\
 \cdots & \rightarrow & C_{1,3} & \xrightarrow{d_{1,3}} & C_{1,2} & \xrightarrow{d_{1,2}} & C_{1,1} & \xrightarrow{d_{1,1}} & C_{1,0} & \xrightarrow{d_{1,0}} & 0 \\
 & & \downarrow \partial_{1,3} & & \downarrow \partial_{1,2} & & \downarrow \partial_{1,1} & & \downarrow \partial_{1,0} & & \\
 \cdots & \rightarrow & C_{0,3} & \xrightarrow{d_{0,3}} & C_{0,2} & \xrightarrow{d_{0,2}} & C_{0,1} & \xrightarrow{d_{0,1}} & C_{0,0} & \xrightarrow{d_{0,0}} & 0 \\
 & & \downarrow \partial_{0,3} & & \downarrow \partial_{0,2} & & \downarrow \partial_{0,1} & & \downarrow \partial_{0,0} & & \\
 & & 0 & & 0 & & 0 & & 0 & & 
 \end{array}$$



with all rows but the bottom exact, and all columns but the rightmost exact. Then the  $n$ th homology of the bottom row is isomorphic to the  $n$ th homology of the rightmost column.

**Proof:** As the reader might guess, a detailed proof is likely to drown in a sea of indices. There is a way of avoiding this while still including the relevant details. The gimmick comes in two parts.

The first half of the modification is to set  $C_{i,j}$  equal to 0 if  $i < 0$  or  $j < 0$ , extending the  $C_{i,j}$  diagram to the whole plane by putting in zeros off the second quadrant. (The  $\partial_{i,j}$  and  $d_{i,j}$  are extended to zero as necessary.) The second half consists of replacing the  $C_{i,j}$  (as well as  $\partial_{i,j}$  and  $d_{i,j}$ ) by isomorphic copies in such a way that the replacement  $C_{i,j}$  are pairwise disjoint. (In particular, we get a countable infinity of disjoint zeros off the second quadrant.) Now let  $C$  denote the (disjoint) union of all the  $C_{i,j}$ . We define  $\partial : C \rightarrow C$  by  $\partial(x) = \partial_{i,j}(x)$  if  $x \in C_{i,j}$ ;  $d : C \rightarrow C$  is defined similarly. The disjointness guarantees that  $d$  and  $\partial$  are unambiguous; the extension-by-zero makes  $d$  and  $\partial$  globally defined with values back in  $C$ . Commutativity of the diagram is stated thusly:  $d\partial = \partial d$ . Rows are complexes:  $dd = 0$ . Columns are complexes:  $\partial\partial = 0$ . Exactness of all rows except the axis:  $d(x) = 0 \Rightarrow x = d(y)$  for some  $y$  UNLESS  $x \in C_{0j}$  for some  $j$ . (The proviso illustrates the not-so-surprising point that we must occasionally write indices.)

Now to the zigzags. The space of zigzags (from  $C_{1,n}$  to  $C_{n,1}$ ), call it  $Z_n$ , is defined as follows for  $n \geq 2$ :

$$Z_n \subset \bigoplus_{i=1}^n C_{i,n-i+1}$$

$$(y_1, \dots, y_n) \in Z_n \Leftrightarrow d(y_i) = \partial(y_{i+1}), \quad i = 1, \dots, n.$$

In pictures:

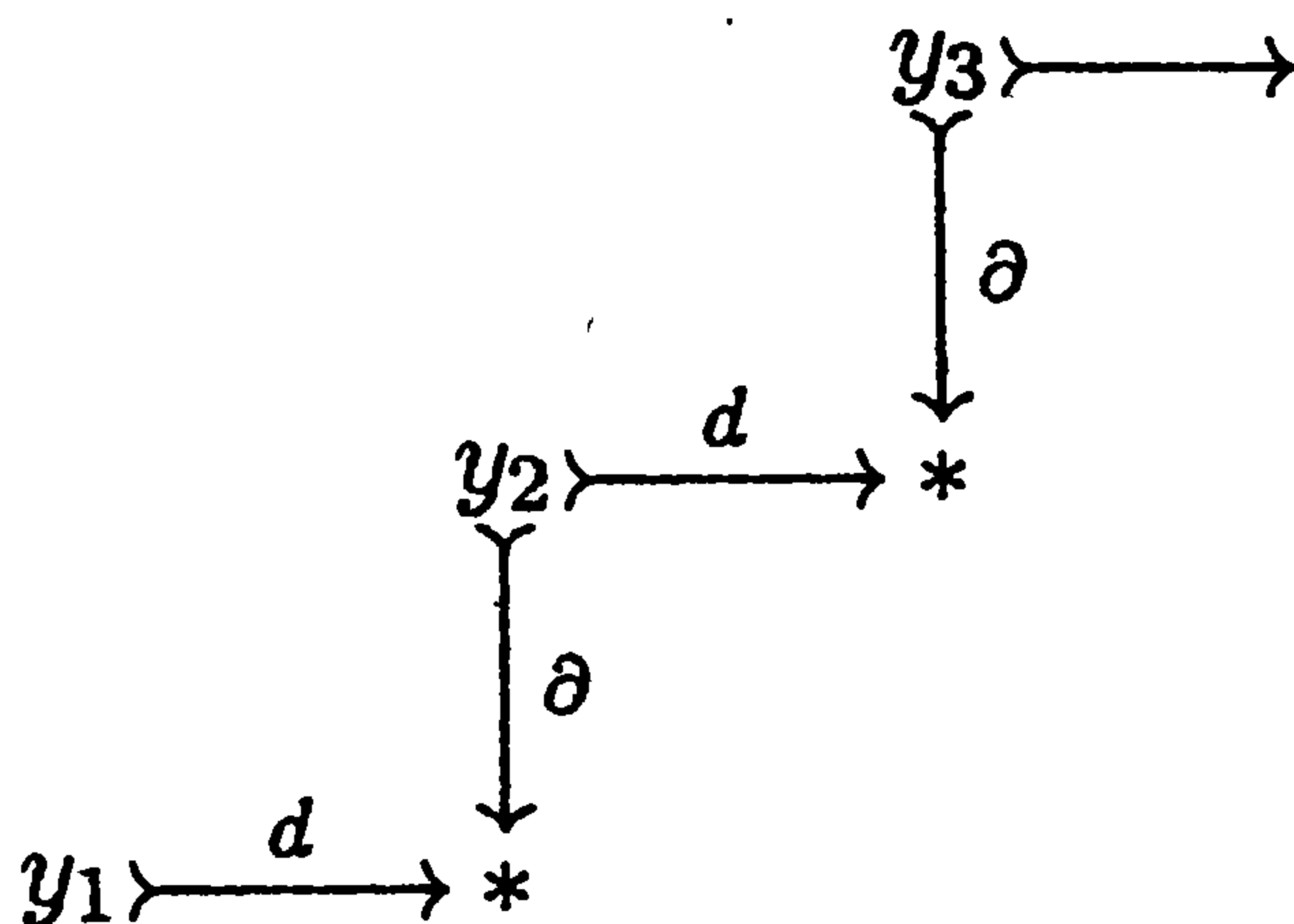

The set  $Z_n$  is a group by linearity of  $d$  and  $\partial$ . Further,  $Z_n$  maps to  $C_{0,n}$  by applying  $\partial_{1,n}$  to  $y_1$ . We now have several things to check.

- i) If  $(y_1, \dots, y_n) \in Z_n$ , then  $\partial_{1,n}(y_1) \in \ker d_{0,n}$ . Reason:  $d_{0,n}\partial_{1,n}(y_1) = \partial_{1,n-1}d_{1,n}(y_1) = \partial_{1,n-1}\partial_{2,n-1}(y_2) = 0$ . Remember that we assume  $n \geq 2$  here.
- ii) If  $x \in \ker d_{0,n}$ , then  $\exists (y_1, \dots, y_n) \in Z_n$  with  $\partial_{1,n}(y_1) = x$ . Well,  $\partial_{1,n}$  is onto, so  $\exists y_1$  with  $\partial_{1,n}(y_1) = x$ . Now  $0 = d_{0,n}(x) = d_{0,n}\partial_{1,n}(y_1) = \partial_{1,n-1}d_{1,n}(y_1) \Rightarrow d_{1,n}(y_1) \in \ker \partial_{1,n-1} = \text{im } \partial_{2,n-1}$ . Hence  $\exists y_2$  with  $\partial_{2,n-1}(y_2) = d_{1,n}(y_1)$ . Now drop indices. Given  $y_1, \dots, y_k, k \geq 2$ ,  $\partial d(y_k) = d\partial(y_k) = dd(y_{k-1}) = 0$ , so from the diagram

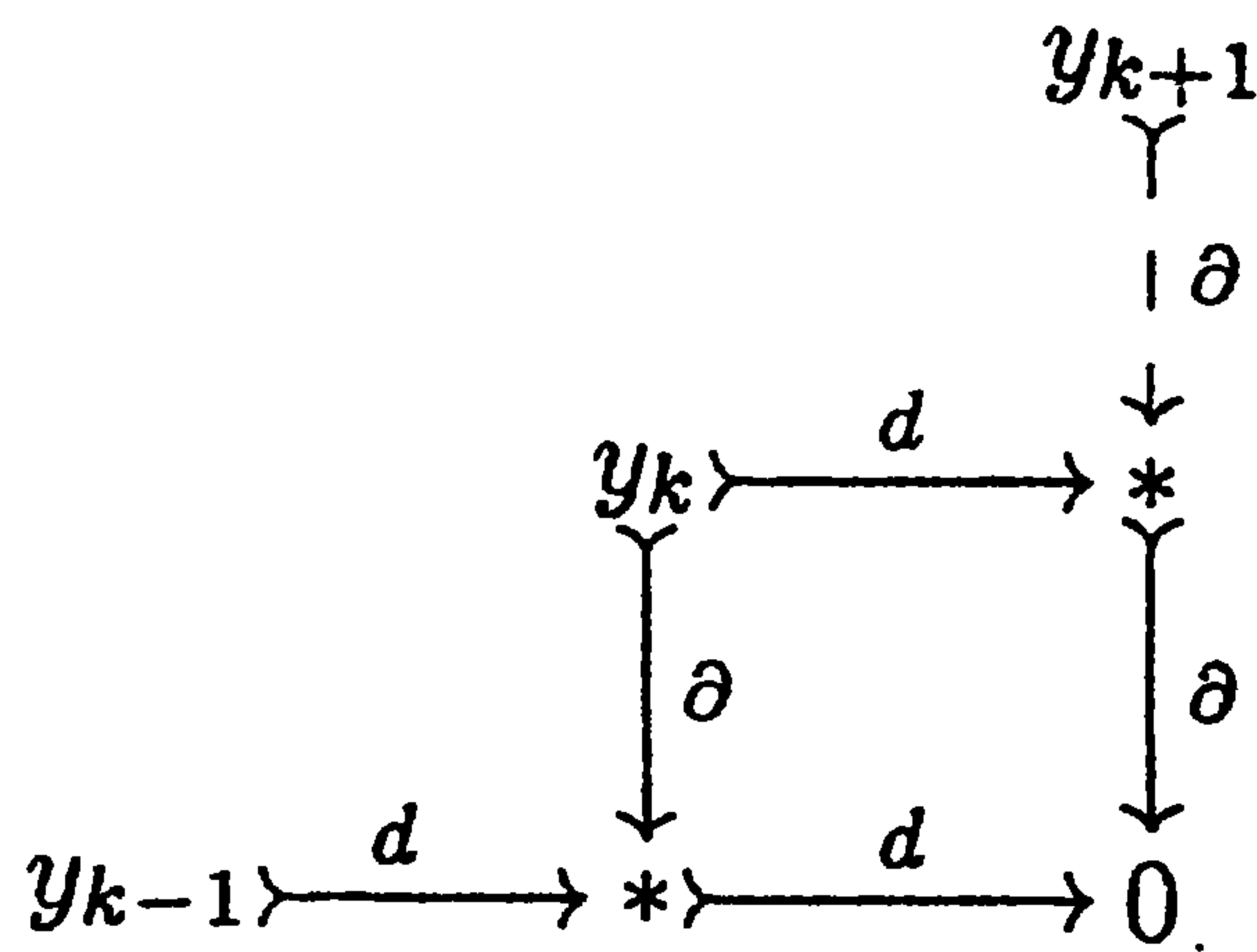

we have  $d(y_k) \in \text{im } \partial$ , that is,  $\partial(y_{k+1}) = d(y_k)$  for some  $y_{k+1}$ .

We now have that  $(y_1, \dots, y_n) \mapsto \partial_{1,n}(y_1)$  yields a map from  $Z_n$  onto the  $n$ th homology along the horizontal axis. We need the kernel. Suppose

$$(z_1, \dots, z_{n+1}) \in \bigoplus_{i=1}^{n+1} C_{i,n-i+2}$$

and, for  $k = 1, \dots, n$ :  $y_k = d(z_k) + \partial(z_{k+1})$ . In pictures,

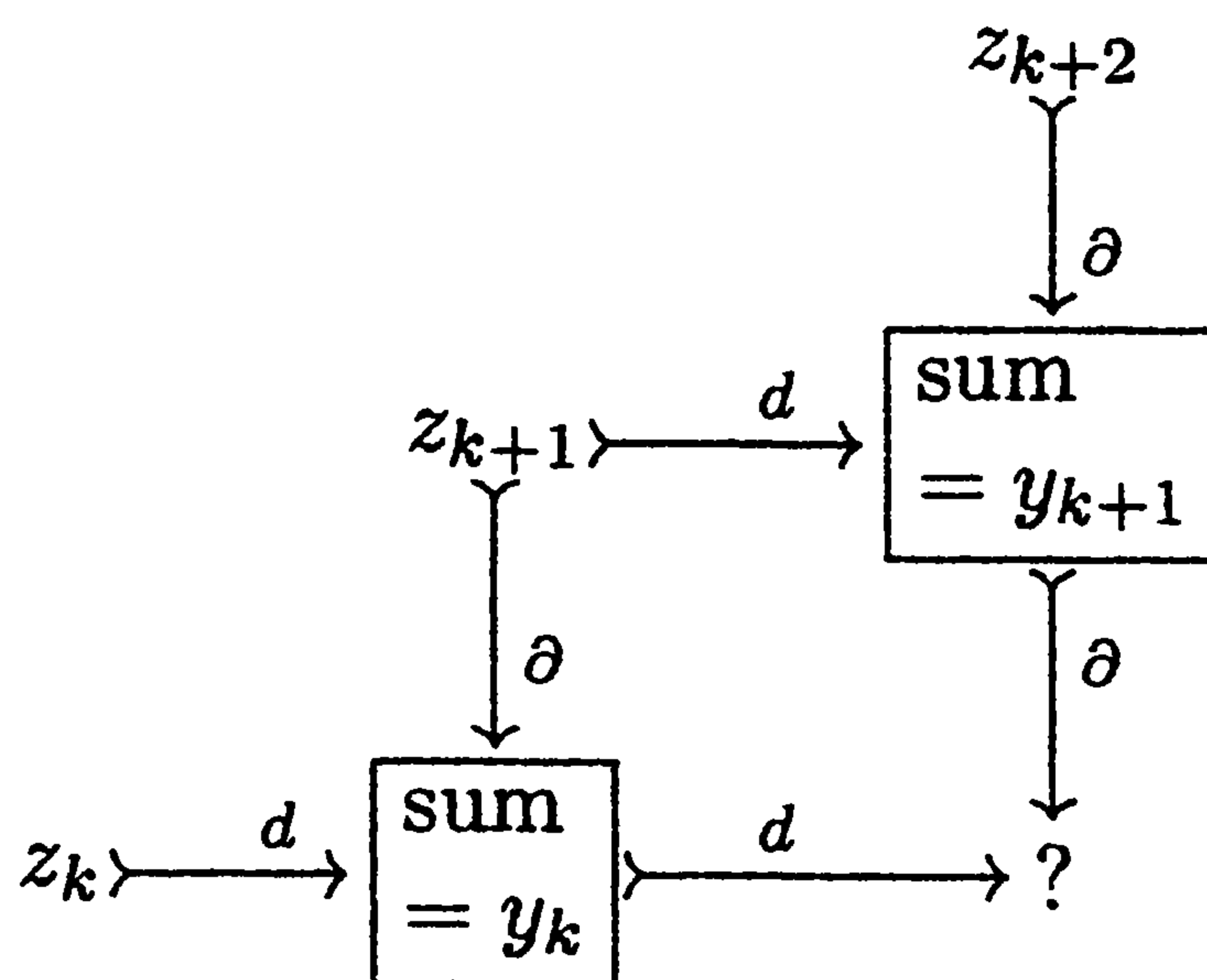

The question mark is a star, that is,  $d(y_k) = \partial(y_{k+1})$ :

$$\begin{aligned}
 d(y_k) &= dd(z_k) + d\partial(z_{k+1}) = d\partial(z_{k+1}) \\
 &= \partial d(z_{k+1}) = \partial d(z_{k+1}) + \partial\partial(z_{k+2}) = \partial(y_{k+1}).
 \end{aligned}$$

- iii) Any  $(y_1, \dots, y_n)$  that is produced this way produces zero in the  $n$ th homology of the horizontal axis. To see this, observe that  $\partial_{1,n}(y_1) = \partial_{1,n}(d(z_1) + \partial(z_2)) = \partial d(z_1) + \partial\partial(z_2) = d_{0,n+1}\partial(z_1) \in \text{im } d_{0,n+1}$ .

iv) If  $\partial_{1,n}(y_1) \in \text{im } d_{0,n+1}$ , then  $\exists (z_1, \dots, z_{n+1})$  that produces  $(y_1, \dots, y_n)$  as above. To see this, first note that if  $\partial_{1,n}(y_1) = d_{0,n+1}(x)$ , one can choose  $z_1$  so that  $\partial_{1,n+1}(z_1) = x$ , since  $\partial_{1,n+1}$  is onto. But

$$\begin{aligned} \partial_{1,n}(y_1 - d_{1,n+1}(z_1)) &= \partial_{1,n}(y_1) - \partial_{1,n}d_{1,n+1}(z_1) \\ &= \partial_{1,n}(y_1) - d_{0,n+1}\partial_{1,n+1}(z_1) \\ &= \partial_{1,n}(y_1) - d_{0,n+1}(x) \\ &= 0 \end{aligned}$$

so that  $y_1 - d_{1,n+1}(z_1) \in \ker \partial_{1,n} = \text{im } \partial_{2,n}$ . Hence (dropping indices now)  $\exists z_2 \in C_{2,n}$  with  $\partial(z_2) = y_1 - d(z_1)$ , so that  $y_1 = d(z_1) + \partial(z_2)$  as required. Given  $z_1, \dots, z_{k+1}$ ,  $k \geq 1$ , an examination of the diagram

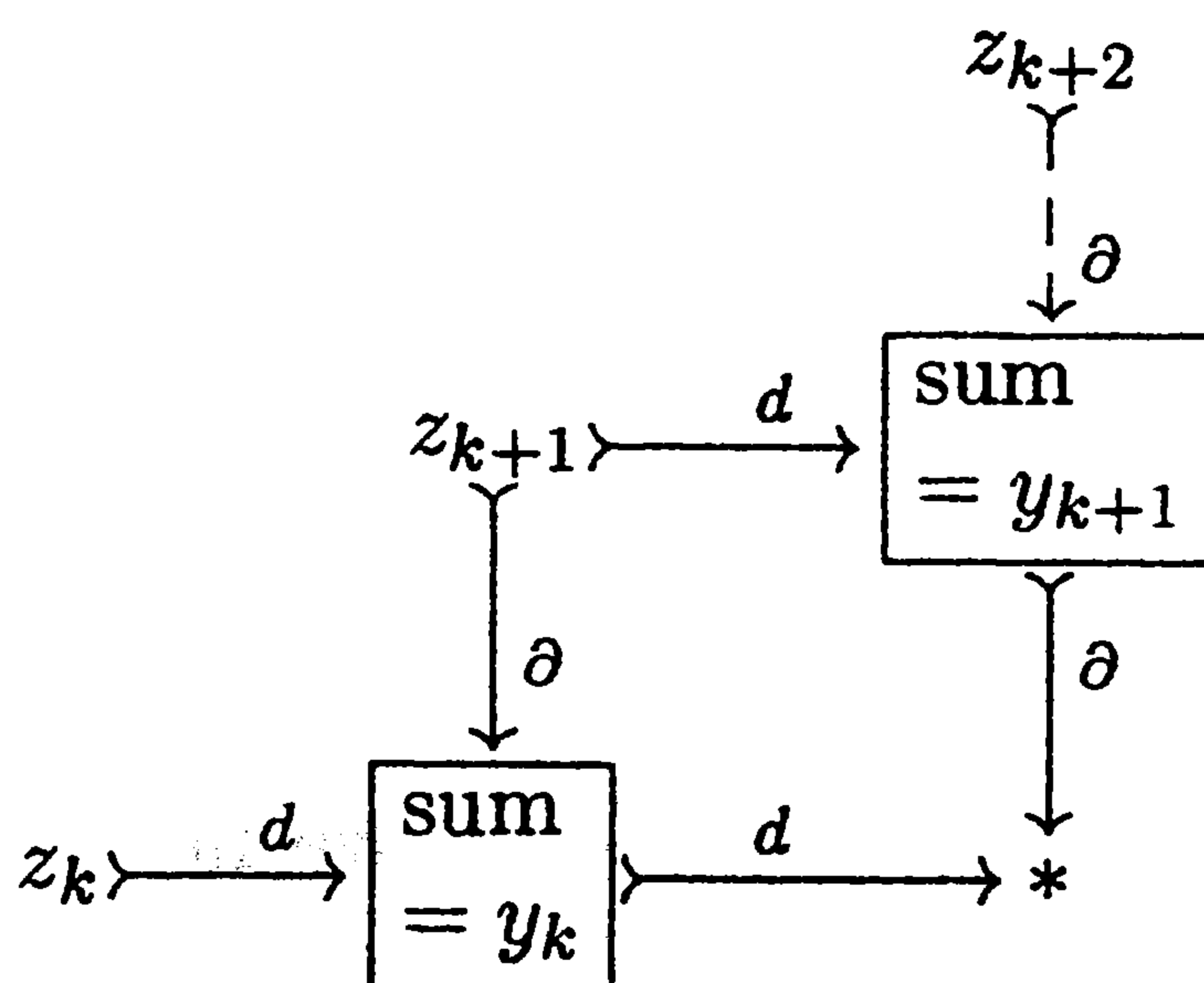

shows that

$$\begin{aligned} \partial(y_{k+1} - d(z_{k+1})) &= \partial(y_{k+1}) - \partial d(z_{k+1}) \\ &= d(y_k) - d\partial(z_{k+1}) = d(y_k - \partial(z_{k+1})) \\ &= dd(z_k) \\ &= 0 \end{aligned}$$

so that  $y_{k+1} - d(z_{k+1}) = \partial(z_{k+2})$  for some  $z_{k+2}$  (and  $y_{k+1} = d(z_{k+1}) + \partial(z_{k+2})$ ).

So we now have that the  $n$ th homology of the bottom row is isomorphic to  $Z_n/B_n$ , where  $B_n$  is the subgroup consisting of those  $(y_1, \dots, y_n)$  which come from a  $(z_1, \dots, z_{n+1})$ , since that is the kernel of  $(y_1, \dots, y_n) \mapsto \partial_{1,n}(y_1) + \text{im } d_{0,n+1}$ .

*This situation is symmetric.* That is, if we flip the whole diagram about a 45-degree line going northwest-southeast, changing  $C_{i,j}$  to  $C_{j,i}$  and interchanging  $d$  with  $\partial$ , we get the same picture, but with  $(y_1, \dots, y_n) \leftrightarrow (y_n, \dots, y_1)$  and  $(z_1, \dots, z_{n+1}) \leftrightarrow (z_{n+1}, \dots, z_1)$ . That is, in the original picture,  $Z_n/B_n$  is isomorphic to the  $n$ th homology of the righthand column, too, under the correspondence

$$(y_1, \dots, y_n) + B_n \mapsto d_{n,1}(y_n) + \text{im } \partial_{n+1,0}.$$

In pictures:

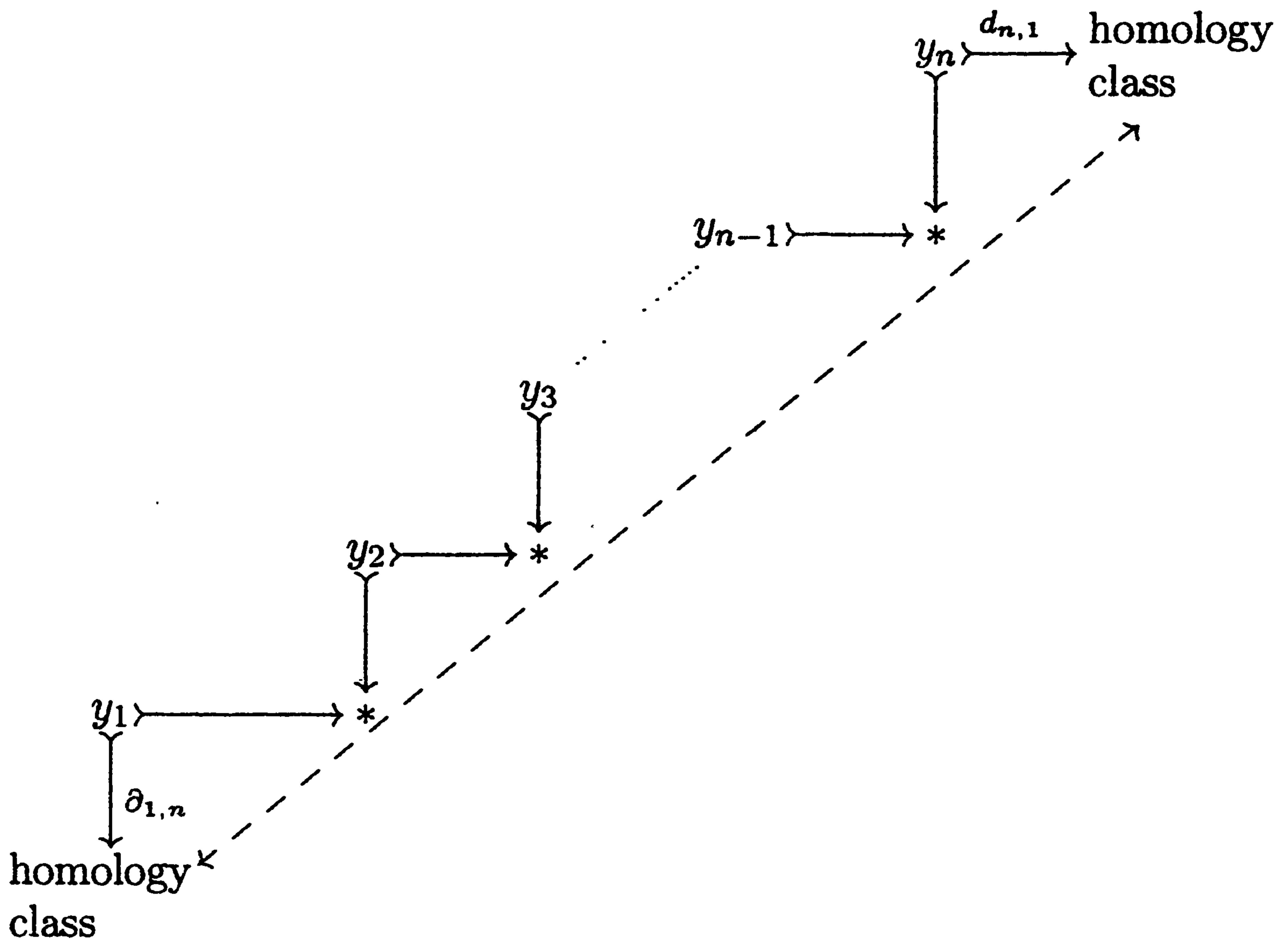

Before declaring the proof complete, we need to check the  $n = 0$  and  $n = 1$  cases.  $n = 0$  is easy enough: Since  $\partial_{1,1}$  and  $d_{1,1}$  are onto,

$$\text{im } d_{0,1} = \text{im } d_{0,1}\partial_{1,1} = \text{im } \partial_{1,0}d_{1,1} = \text{im } \partial_{1,0}$$

so that the zero'th homology groups are actually the same group, namely  $C_{0,0}/\text{im } d_{0,1} \cong C_{0,0}/\text{im } \partial_{1,0}$ .

For  $n = 1$ , we redo the above, but with a special  $Z_1$ , namely

$$\begin{aligned} Z_1 &= \{y_1 \in C_{1,1} : d_{0,1}\partial_{1,1}(y_1) = 0\} \\ &= \{y_1 \in C_{1,1} : \partial_{1,0}d_{1,1}(y_1) = 0\}. \end{aligned}$$

As before, but more easily,  $\partial_{1,1}(y_1) \in \ker d_{0,1}$ . Further, any  $x \in \ker d_{0,1}$  is the image of a  $y_1 \in C_{1,1}$  since  $\partial_{1,1}$  is onto, and  $x \in \ker d_{0,1} \Rightarrow y_1 \in Z_1$ . We can get such a  $y_1$  from  $(z_1, z_2) \in C_{1,2} \oplus C_{2,1}$  by  $y_1 = d(z_1) + \partial(z_2)$ , since then

$$\begin{aligned} d_{0,1}\partial_{1,1}(y_1) &= d\partial d(z_1) + d\partial\partial(z_2) \\ &= \partial dd(z_1) + d\partial\partial(z_2) \\ &= 0. \end{aligned}$$

Further, in this case, (using indices):

$$\begin{aligned} \partial_{1,1}(y_1) &= \partial_{1,1}d_{1,2}(z_1) + \partial_{1,1}\partial_{2,1}(z_2) \\ &= d_{0,2}\partial_{1,2}(z_1) + 0 \in \text{im } d_{0,2}. \end{aligned}$$

Finally, any  $y_1$  which winds up in  $\text{im } d_{0,2}$  comes from a  $(z_1, z_2)$ , a result that is left as an exercise. Again, the situation is symmetric.  $\square$

**Corollary 3.10**  $\text{Tor}_n(A, B)$  is isomorphic to the  $n$ th homology of a flat resolution of  $A$ , tensored with  $B$  (and  $A \otimes B$  deleted). Furthermore, this isomorphism is natural in that if  $\varphi \in \text{Hom}(B, B')$ , and if  $H_n$  denotes the  $n$ th homology of a chain complex, and  $\langle F_k, d_k \rangle$  is a flat resolution of  $A$ , then

$$\begin{array}{ccc} \text{Tor}_n(A, B) & \xrightarrow{\text{Tor}_n(A, \varphi)} & \text{Tor}_n(A, B') \\ \cong & & \cong \\ H_n\langle F_k \otimes B, d_k \otimes B \rangle & \xrightarrow{H_n\langle F_k, d_k \rangle \otimes \varphi} & H_n\langle F_k \otimes B', d_k \otimes B' \rangle \end{array}$$

commutes.

**Proof:** The isomorphism was just proved. To see naturality, take a diagram

$$\begin{array}{ccccccccccc} \cdots & \longrightarrow & P_n & \longrightarrow & P_{n-1} & \longrightarrow & \cdots & \longrightarrow & P_1 & \longrightarrow & P_0 & \longrightarrow & B & \longrightarrow & 0 \\ & & \downarrow \varphi_n & & \downarrow \varphi_{n-1} & & & & \downarrow \varphi_1 & & \downarrow \varphi_0 & & \downarrow \varphi & & \\ \cdots & \longrightarrow & P'_n & \longrightarrow & P'_{n-1} & \longrightarrow & \cdots & \longrightarrow & P'_1 & \longrightarrow & P'_0 & \longrightarrow & B' & \longrightarrow & 0 \end{array}$$

and tensor it with the flat resolution  $\langle F_k, d_k \rangle$  of  $A$ . The result is a two-layer, three dimensional diagram whose typical cube looks like:

$$\begin{array}{ccccccc} & & \vdots & & \vdots & & \vdots \\ & & \downarrow & & \downarrow & & \downarrow \\ \cdots & \longrightarrow & F_{i+1} \otimes P_{j+1} & \longrightarrow & F_{i+1} \otimes P_j & \longrightarrow & \cdots \\ & & \downarrow & \searrow & \downarrow & \searrow & \downarrow \\ \cdots & \longrightarrow & F_{i+1} \otimes P'_{j+1} & \longrightarrow & F_{i+1} \otimes P'_j & \longrightarrow & \cdots \\ & & \downarrow & & \downarrow & & \downarrow \\ \cdots & \longrightarrow & F_i \otimes P_{j+1} & \longrightarrow & F_i \otimes P_j & \longrightarrow & \cdots \\ & & \downarrow & \searrow & \downarrow & \searrow & \downarrow \\ \cdots & \longrightarrow & F_i \otimes P'_{j+1} & \longrightarrow & F_i \otimes P'_j & \longrightarrow & \cdots \\ & & \downarrow & & \downarrow & & \downarrow \\ & & \vdots & & \vdots & & \vdots \end{array}$$

Now simply observe that a zigzag for  $\langle F_i \otimes P_j \rangle$  maps to a zigzag for  $\langle F_i \otimes P'_j \rangle$ :

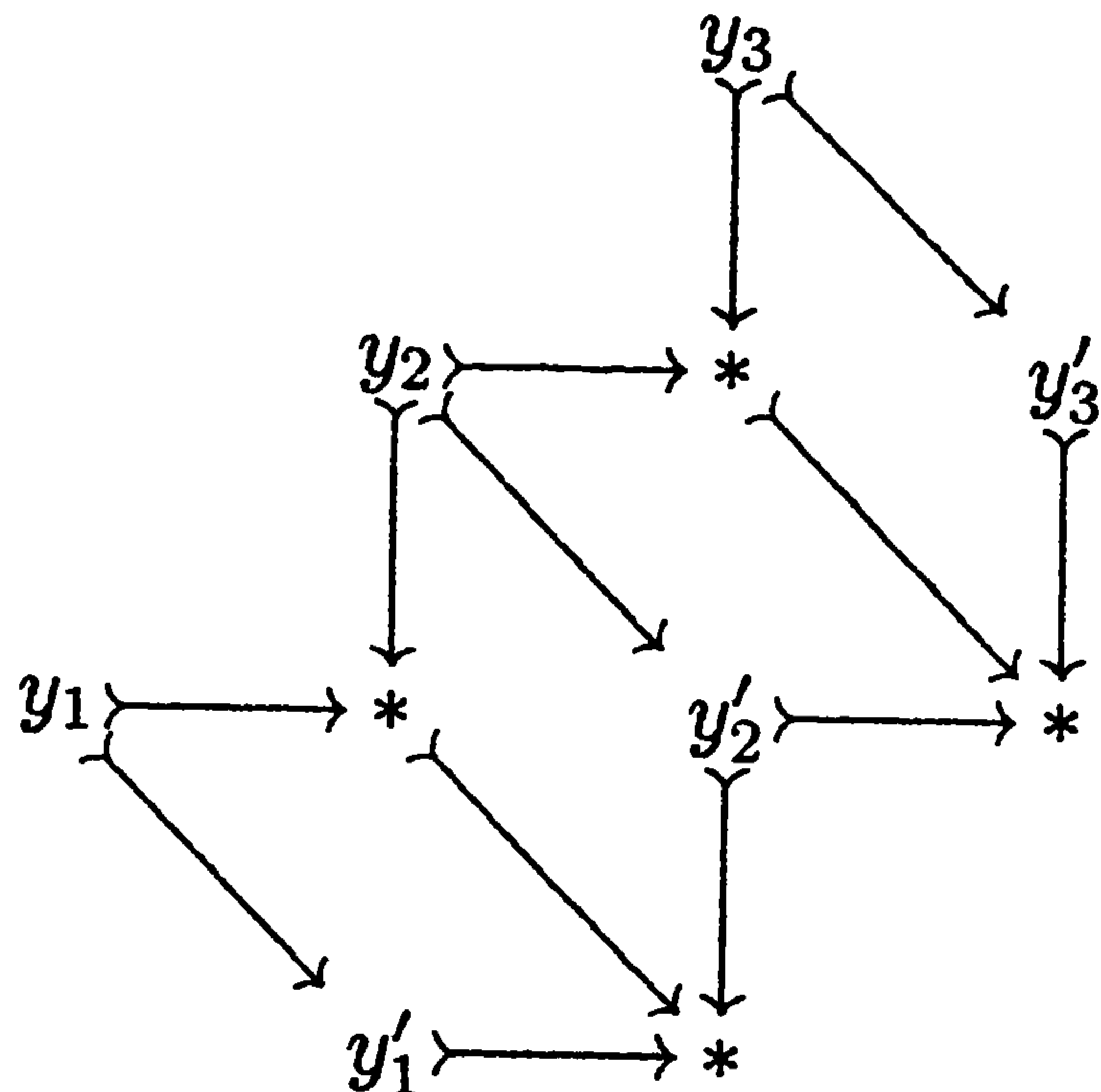

The first homology,  $Z_1/B_1$ , works even more easily, and these are all that appear here. □

There is one more thing that needs to be said, and it is reflected in the notation. “ $Z_n/B_n$  is (almost) the homology of a complex.” To see this, note that the condition “ $d(y_i) = \partial(y_{i+1})$ ” can be replaced by “ $d(y_i) - \partial(y_{i+1}) = 0$ ,” the vanishing of certain maps on  $(y_1, \dots, y_n)$ . In more detail, one may set (for  $n \geq 2$ ):

$$C_n = \bigoplus_{i=1}^n C_{i,n-i+1}$$

$$\begin{aligned} d_n(x_1, \dots, x_n) &= (d(x_1), \dots, d(x_{n-1})), \\ \partial_n(x_1, \dots, x_n) &= (\partial(x_2), \dots, \partial(x_n)), \end{aligned}$$

and

$$D_n = d_n + (-1)^{n+1} \partial_n : C_n \rightarrow C_{n-1}.$$

Also, as a special case, set  $C_0 = C_{0,0}$ , and  $D_1 = d\partial = \partial d$  on  $C_1 = C_{1,1}$ . Then  $D_{n-1}D_n = 0$ , and  $Z_n/B_n$  is the  $n$ th homology of  $\langle C_n, D_n \rangle$  when  $n$  is even, and  $(y_1, y_2, y_3, \dots, y_{n-1}, y_n) \leftrightarrow (y_1, -y_2, \dots, -y_{n-1}, y_n)$  makes  $Z_n/B_n$  isomorphic to the  $n$ th homology when  $n$  is odd. Furthermore,  $(y_1, \dots, y_n) \mapsto \partial_{1,n}y_1$  is a chain map to the horizontal axis complex. This sign convention is not standard, but any convention has advantages and



disadvantages. This one facilitates the discussion in Chapter 6, but we shall have to modify it in the discussion of the Künneth theorems in Chapter 9. Anyway, no matter what sign is used, we will *not* get a chain map to the vertical axis complex. Those minus signs eventually cause some trouble. In Section 6.5 this will all be done systematically.

Now consider injective resolutions and Ext. The construction is similar, but with some differences. Suppose  $C \in {}_R\mathbf{M}$ . An injective resolution  $\langle E_i, d_i \rangle$  of  $C$  is an exact sequence

$$0 \rightarrow C \xrightarrow{\iota} E_0 \xrightarrow{d_1} E_1 \xrightarrow{d_2} E_2 \xrightarrow{d_3} \dots$$

going off to infinity on the right. Injective resolutions exist, thanks to the enough injectives theorem. Imbed  $C$  in  $E_0$  via  $\iota$ ; imbed  $E_0/\iota(C)$  in  $E_1$ , etc. Apply  $\text{Hom}(B, \bullet)$  and delete  $\text{Hom}(B, C)$ ; we wish to show that the  $n$ th homology of

$$0 \rightarrow \text{Hom}(B, E_0) \xrightarrow{\text{Hom}(B, d_1)} \text{Hom}(B, E_1) \xrightarrow{\text{Hom}(B, d_2)} \text{Hom}(B, E_2) \rightarrow \dots$$

is isomorphic to  $\text{Ext}^n(B, C)$ .

The relevant double complex is

$$\begin{array}{ccccccc}
 & \vdots & & \vdots & & \vdots & & \vdots \\
 & \uparrow & & \uparrow & & \uparrow & & \uparrow \\
 \dots & \leftarrow \text{Hom}(P_2, E_2) & \leftarrow & \text{Hom}(P_2, E_1) & \leftarrow & \text{Hom}(P_2, E_0) & \leftarrow & \text{Hom}(P_2, C) & \leftarrow & 0 \\
 & \uparrow & & \uparrow & & \uparrow & & \uparrow & & \\
 \dots & \leftarrow \text{Hom}(P_1, E_2) & \leftarrow & \text{Hom}(P_1, E_1) & \leftarrow & \text{Hom}(P_1, E_0) & \leftarrow & \text{Hom}(P_1, C) & \leftarrow & 0 \\
 & \uparrow & & \uparrow & & \uparrow & & \uparrow & & \\
 \dots & \leftarrow \text{Hom}(P_0, E_2) & \leftarrow & \text{Hom}(P_0, E_1) & \leftarrow & \text{Hom}(P_0, E_0) & \leftarrow & \text{Hom}(P_0, C) & \leftarrow & 0 \\
 & \uparrow & & \uparrow & & \uparrow & & \uparrow & & \\
 \dots & \leftarrow \text{Hom}(B, E_2) & \leftarrow & \text{Hom}(B, E_1) & \leftarrow & \text{Hom}(B, E_0) & \leftarrow & 0 & \leftarrow & 0 \\
 & \uparrow & & \uparrow & & \uparrow & & \uparrow & & \\
 & 0 & & 0 & & 0 & & 0 & & 
 \end{array}$$

Again, all rows but the bottom are exact since all  $P_n$  are projective, and all columns but the rightmost are exact since all  $E_n$  are injective. The companion to Proposition 3.9 is:

**Proposition 3.11** *Suppose  $C_{i,j}, d_{i,j}, \partial_{i,j}$  form a commutative array in  $\mathbf{Ab}$*

(with rows and columns being complexes):

$$\begin{array}{ccccccc}
 & \vdots & & \vdots & & \vdots & & \vdots \\
 & \uparrow & & \uparrow & & \uparrow & & \uparrow \\
 \cdots & \longleftarrow & C_{3,3} & \xleftarrow{d_{3,2}} & C_{3,2} & \xleftarrow{d_{3,1}} & C_{3,1} & \xleftarrow{d_{3,0}} & C_{3,0} & \longleftarrow & 0 \\
 & & \uparrow \partial_{2,3} & & \uparrow \partial_{2,2} & & \uparrow \partial_{2,1} & & \uparrow \partial_{2,0} & & \\
 \cdots & \longleftarrow & C_{2,3} & \xleftarrow{d_{2,2}} & C_{2,2} & \xleftarrow{d_{2,1}} & C_{2,1} & \xleftarrow{d_{2,0}} & C_{2,0} & \longleftarrow & 0 \\
 & & \uparrow \partial_{1,3} & & \uparrow \partial_{1,2} & & \uparrow \partial_{1,1} & & \uparrow \partial_{1,0} & & \\
 \cdots & \longleftarrow & C_{1,3} & \xleftarrow{d_{1,2}} & C_{1,2} & \xleftarrow{d_{1,1}} & C_{1,1} & \xleftarrow{d_{1,0}} & C_{1,0} & \longleftarrow & 0 \\
 & & \uparrow \partial_{0,3} & & \uparrow \partial_{0,2} & & \uparrow \partial_{0,1} & & \uparrow \partial_{0,0} & & \\
 \cdots & \longleftarrow & C_{0,3} & \xleftarrow{d_{0,2}} & C_{0,2} & \xleftarrow{d_{0,1}} & C_{0,1} & \xleftarrow{d_{0,0}} & C_{0,0} & \longleftarrow & 0 \\
 & & \uparrow 0 & & \uparrow 0 & & \uparrow 0 & & \uparrow 0 & & \\
 & & 0 & & 0 & & 0 & & 0 & & 
 \end{array}$$

with all rows but the bottom exact, and all columns but the rightmost exact. Then the  $n$ th homology of the bottom row is isomorphic to the  $n$ th homology of the rightmost column.

**Proof:** Make the same modifications and conventions as in the proof of Proposition 3.9. Here, a zigzag is a member of

$$Z_n \subset \bigoplus_{i=0}^n C_{i,n-i}$$

$$(x_0, \dots, x_n) \in Z_n \Leftrightarrow \partial(x_j) = d(x_{j+1}), d(x_0) = 0, \text{ and } \partial(x_n) = 0.$$

In pictures:

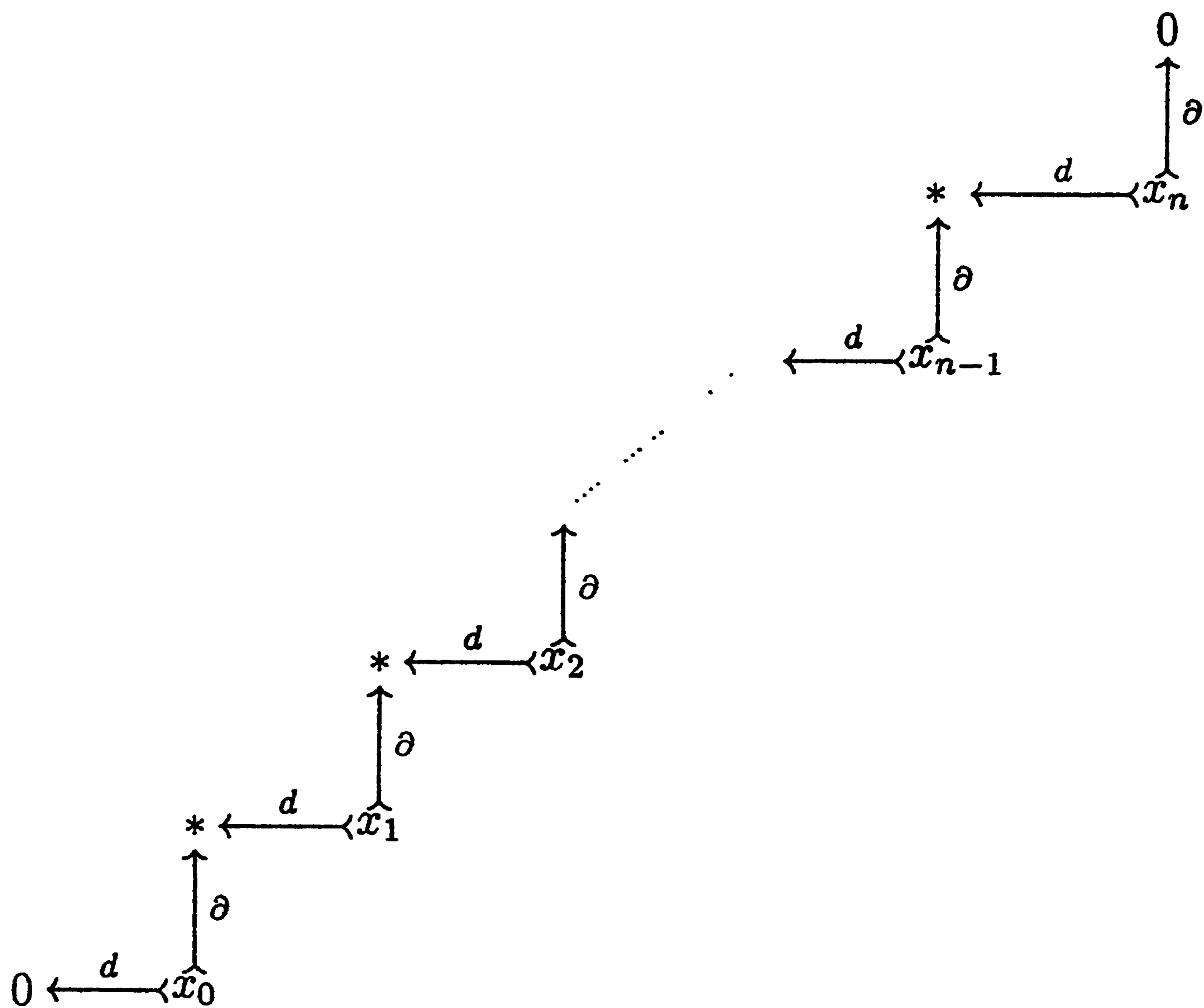

We manufacture such a zigzag from the object  $(z_0, \dots, z_{n-1})$  in

$$\bigoplus_{i=0}^{n-1} C_{i, n-i-1}$$

$$\begin{aligned} x_j &= d(z_j) + \partial(z_{j-1}) \text{ for } j = 1, \dots, n-1 \\ x_0 &= d(z_0), \quad x_n = \partial(z_{n-1}). \end{aligned}$$

The correspondence to  $\ker d_{0,n}$  is just  $(x_0, \dots, x_n) \mapsto x_0$ . (The situation is simpler here.) All this works for all  $n > 0$ ; if  $n = 0$ , keep  $Z_0$  as is, and set  $B_0 = 0$ . Note that this time the bottom row and right hand column are included.

From the definition, it follows that  $x_0 \in \ker d_{0,n}$ , while if  $(x_0, \dots, x_n)$  comes from a  $(z_0, \dots, z_{n-1})$ , necessarily  $x_0 = d_{0,n-1}(z_0) \in \text{im } d_{0,n-1}$ . It remains to show that any  $x_0 \in \ker d_{0,n}$  can be extended to a zigzag, and that if  $(x_0, \dots, x_n) \in Z_n$  is such that  $x_0 = d_{0,n-1}(z_0)$ , then  $z_0$  can be extended to  $(z_0, \dots, z_{n-1})$  mapping to  $(x_0, \dots, x_n)$  as above.

For the first part, since  $0 = d_{0,n}(x_0)$ ,  $0 = \partial d(x_0) = d \partial(x_0) \Rightarrow \partial(x_0) = d(x_1)$  for some  $x_1$ . In general, given  $(x_0, \dots, x_k)$ ,  $k \geq 1$ ,  $d \partial(x_k) = \partial d(x_k) = \partial \partial(x_{k-1}) = 0$  so  $\partial(x_k) = d(x_{k+1})$  for some  $x_{k+1}$ . Finally, given  $(x_0, \dots, x_n)$  constructed this way,  $0 = \partial \partial(x_{n-1}) = \partial d(x_n) = d \partial(x_n)$ , so  $\partial(x_n) = 0$ , since  $d$  is one-to-one on  $C_{n,0}$ . (Okay, the case  $n = 0$  is special;  $0 = d(x_0)$ , so  $0 = \partial d(x_0) = d \partial(x_0) \Rightarrow \partial(x_0) = 0$ , too.)

The second part is left as an exercise. □

**Corollary 3.12**  $\text{Ext}^n(B, C)$  is isomorphic to the  $n$ th homology of  $\text{Hom}(B, \bullet)$  applied to an injective resolution of  $C$  (and  $\text{Hom}(B, C)$  deleted). Furthermore, this isomorphism is natural in that if  $\varphi \in \text{Hom}(B, B')$  and if  $H^n$  denotes  $n$ th homology of a cochain complex, and  $\langle E_k, d_k \rangle$  is an injective resolution of  $C$ , then

$$\begin{array}{ccc} \text{Ext}^n(B, C) & \xleftarrow{\text{Ext}^n(\varphi, C)} & \text{Ext}^n(B', C) \\ \cong & & \cong \\ & \xleftarrow{H^n(\text{Hom}(\varphi, E_k))} & \\ H^n(\text{Hom}(B, E_k), \text{Hom}(B, d_k)) & & H^n(\text{Hom}(B', E_k), \text{Hom}(B', d_k)) \end{array}$$

commutes.

The proof is essentially the same as that of Corollary 3.10 with arrows going the other way.

One may ask what happens if rows and columns other than the edges are just complexes, and not exact. What one gets is a *spectral sequence*, a gadget discussed, for example, in Rotman [68, Chapter 11]. Spectral sequences are important, but not “basic,” and are beyond the scope of this book.

### 3.4 Consequences

The last two sections were long, with just a few results. This one will be shorter, with a lot of results. First, Ext.

**Proposition 3.13 (Second Long Exact Sequence for Ext).** *Suppose  $0 \rightarrow B \rightarrow B' \rightarrow B'' \rightarrow 0$  is a short exact sequence in  ${}_R\mathbf{M}$ , and suppose  $C \in {}_R\mathbf{M}$ . Then there is a long exact sequence:*

$$\begin{array}{ccccccc} & & \cdots & & & & \\ & \hookrightarrow & & \hookrightarrow & & \hookrightarrow & \\ & & \cdots & & & & \\ & \hookrightarrow & \text{Ext}^n(B'', C) & \longrightarrow & \text{Ext}^n(B', C) & \longrightarrow & \text{Ext}^n(B, C) & \xrightarrow{\delta_{n+1}} \\ & & & & & & & \\ & \hookrightarrow & & \hookrightarrow & & \hookrightarrow & & \\ & & \cdots & & & & \\ & \hookrightarrow & \text{Ext}^1(B'', C) & \longrightarrow & \text{Ext}^1(B', C) & \longrightarrow & \text{Ext}^n(B, C) & \xrightarrow{\delta_2} \\ & & & & & & & \\ & \hookrightarrow & 0 & \longrightarrow & \text{Hom}(B'', C) & \longrightarrow & \text{Hom}(B', C) & \longrightarrow & \text{Hom}(B, C) & \xrightarrow{\delta_1} \end{array}$$

**Proof:** Take an injective resolution  $\langle E_i, d_i \rangle$  of  $C$  and apply  $\text{Hom}(B, \bullet)$ ,  $\text{Hom}(B', \bullet)$ , and  $\text{Hom}(B'', \bullet)$  to it, deleting the terms with  $C$ :

$$\begin{array}{ccccccc}
 & & 0 & & 0 & & 0 \\
 & & \uparrow & & \uparrow & & \uparrow \\
 0 & \longrightarrow & \text{Hom}(B, E_0) & \longrightarrow & \text{Hom}(B, E_1) & \longrightarrow & \text{Hom}(B, E_2) \longrightarrow \dots \\
 & & \uparrow & & \uparrow & & \uparrow \\
 0 & \longrightarrow & \text{Hom}(B', E_0) & \longrightarrow & \text{Hom}(B', E_1) & \longrightarrow & \text{Hom}(B', E_2) \longrightarrow \dots \\
 & & \uparrow & & \uparrow & & \uparrow \\
 0 & \longrightarrow & \text{Hom}(B'', E_0) & \longrightarrow & \text{Hom}(B'', E_1) & \longrightarrow & \text{Hom}(B'', E_2) \longrightarrow \dots \\
 & & \uparrow & & \uparrow & & \uparrow \\
 & & 0 & & 0 & & 0
 \end{array}$$

Columns are exact since all  $E_j$  are injective. The result now follows from Theorem 3.3 and Corollary 3.12.  $\square$

**Corollary 3.14** Suppose  $0 \rightarrow B \rightarrow P \rightarrow B' \rightarrow 0$  is short exact in  ${}_R\mathbf{M}$ , with  $P$  projective. Then  $\text{Ext}^n(B, C) \approx \text{Ext}^{n+1}(B', C)$  for all  $C \in {}_R\mathbf{M}$  and  $n \geq 1$ .

**Proof:**  $0 = \text{Ext}^n(P, C) \rightarrow \text{Ext}^n(B, C) \rightarrow \text{Ext}^{n+1}(B', C) \rightarrow \text{Ext}^{n+1}(P, C) = 0$  is exact.  $\square$

**Corollary 3.15** Suppose  $C \in {}_R\mathbf{M}$ . The following are equivalent:

- i)  $C$  is injective.
- ii)  $\text{Ext}^n(B, C) = 0$  for all  $B \in {}_R\mathbf{M}$  and  $n \geq 1$ .
- iii)  $\text{Ext}^1(R/I, C) = 0$  for all left ideals  $I$ .

**Proof:** (i)  $\Rightarrow$  (ii) is Proposition 3.2(d). (ii)  $\Rightarrow$  (iii) is trivial. Given (iii), one has, as part of the long exact sequence,

$$0 \rightarrow \text{Hom}(R/I, C) \rightarrow \text{Hom}(R, C) \rightarrow \text{Hom}(I, C) \rightarrow \text{Ext}^1(R/I, C) = 0$$

so that  $\text{Hom}(R, C) \rightarrow \text{Hom}(I, C)$  is onto. This is exactly what gives a filler for any diagram

$$\begin{array}{ccccc}
 0 & \longrightarrow & I & \longrightarrow & R \\
 & & \downarrow & \swarrow & \\
 & & C & & 
 \end{array}$$



so that  $C$  is injective by the injective test lemma.  $\square$

It should be noted that the long exact sequence is natural, in that if  $\varphi \in \text{Hom}(C, C')$ , then

$$\begin{array}{ccccccc} \text{Ext}^n(B'', C) & \longrightarrow & \text{Ext}^n(B', C) & \longrightarrow & \text{Ext}^n(B, C) & \longrightarrow & \text{Ext}^{n+1}(B'', C) \\ \downarrow \text{Ext}^n(B'', \varphi) & & \downarrow \text{Ext}^n(B', \varphi) & & \downarrow \text{Ext}^n(B, \varphi) & & \downarrow \text{Ext}^{n+1}(B'', \varphi) \\ \text{Ext}^n(B'', C') & \longrightarrow & \text{Ext}^n(B', C') & \longrightarrow & \text{Ext}^n(B, C') & \longrightarrow & \text{Ext}^{n+1}(B'', C') \end{array}$$

commutes. The idea is much like the business in Proposition 3.1, but for injectives. One has, for injective resolutions  $\langle E_i, d_i \rangle$  of  $C$ , and  $\langle E'_i, d'_i \rangle$  of  $C'$ , fillers

$$\begin{array}{ccccccccccc} 0 & \longrightarrow & C & \xrightarrow{\iota} & E_0 & \longrightarrow & E_1 & \longrightarrow & E_2 & \longrightarrow & \cdots \\ & & \downarrow \varphi & & \downarrow \varphi_0 & & \downarrow \varphi_1 & & \downarrow \varphi_2 & & \\ 0 & \longrightarrow & C' & \xrightarrow{\iota'} & E'_0 & \longrightarrow & E'_1 & \longrightarrow & E'_2 & \longrightarrow & \cdots \end{array}$$

Again, any two fillers are homotopic. Finally, these maps, after applying any  $\text{Hom}(B, \bullet)$ , and deleting  $\text{Hom}(B, C)$  and  $\text{Hom}(B, C')$ , give chain maps, hence maps from  $\text{Ext}^n(B, C)$  to  $\text{Ext}^n(B, C')$ . By an argument like that of the naturality part of the two corollaries in the last section, this map is precisely  $\text{Ext}^n(B, \varphi)$ . Finally, if  $0 \rightarrow B \rightarrow B' \rightarrow B'' \rightarrow 0$  is short exact, one obtains a two-layer array like the one near the end of the proof of Theorem 3.3. Details are left as an exercise.

Before going on to Tor, the next example gives an amusing calculation (which shows among other things, that  $\mathbb{Q}$  is not projective).

**Example 11**  $\text{Ext}_{\mathbb{Z}}^1(\mathbb{Q}, \mathbb{Z}) \approx \mathbb{R}$  (as groups).

Use an injective resolution of  $\mathbb{Z}$ :

$$0 \rightarrow \mathbb{Z} \rightarrow \mathbb{Q} \rightarrow \mathbb{Q}/\mathbb{Z} \rightarrow 0 \rightarrow 0 \rightarrow \cdots$$

The complex is  $0 \rightarrow \text{Hom}(\mathbb{Q}, \mathbb{Q}) \rightarrow \text{Hom}(\mathbb{Q}, \mathbb{Q}/\mathbb{Z}) \rightarrow 0 \rightarrow 0 \rightarrow \cdots$ . Now  $\text{Hom}(\mathbb{Q}, \mathbb{Q}) \approx \mathbb{Q}$ , since  $\mathbb{Q}$  is *uniquely* divisible: If  $f \in \text{Hom}(\mathbb{Q}, \mathbb{Q})$  and  $f(1) = q$ , then  $q = f(n/n) = nf(1/n) \Rightarrow f(1/n) = q/n$ , so that  $f(m/n) = mf(1/n) = \frac{m}{n} \cdot q$ . Hence  $f \mapsto f(1)$  is an isomorphism of  $\text{Hom}(\mathbb{Q}, \mathbb{Q})$  with  $\mathbb{Q}$ . To finish, note that  $\mathbb{Q} \in {}_{\mathbb{Z}}\mathbf{M}_{\mathbb{Q}}$ , so that  $\text{Hom}(\mathbb{Q}, \mathbb{Q}/\mathbb{Z})$  is a vector space over  $\mathbb{Q}$ . It suffices to show that its dimension over  $\mathbb{Q}$  is the same as the dimension of  $\mathbb{R}$ , that is, a continuum. That way the dimension of  $\text{Ext}_{\mathbb{Z}}^1(\mathbb{Q}, \mathbb{Z})$  will be a continuum. For this purpose, it suffices to show (since  $\mathbb{Q}$  is countable) that  $\text{Hom}(\mathbb{Q}, \mathbb{Q}/\mathbb{Z})$  is a continuum. To see this, note that one can define an  $f \in \text{Hom}(\mathbb{Q}, \mathbb{Q}/\mathbb{Z})$  by recursive choices:



**Proof:** (i)  $\Rightarrow$  (ii) is Proposition 3.2(c). (ii)  $\Rightarrow$  (iii) is trivial. (iii)  $\Rightarrow$  (i) follows from Proposition 3.16 and Corollary 3.7.  $\square$

**Corollary 3.19** *Suppose  $B \in {}_R\mathbf{M}$ . The following are equivalent:*

- i)  $B$  is flat.*
- ii)  $\text{Tor}_n^R(A, B) = 0$  for all  $A \in \mathbf{M}_R$ ,  $n \geq 1$ .*
- iii)  $\text{Tor}_1^R(R/J, B) = 0$  for every finitely generated right ideal  $J$ .*

**Proof:** Corollary 3.18 plus Proposition 3.16.  $\square$

**Corollary 3.20** *Suppose  $0 \rightarrow B \rightarrow F \rightarrow B' \rightarrow 0$  is short exact in  ${}_R\mathbf{M}$ , with  $F$  flat. Then  $\text{Tor}_n(A, B) \approx \text{Tor}_{n+1}(A, B')$  for all  $A \in \mathbf{M}_R$ , and  $n \geq 1$ .*

**Proof:**  $0 = \text{Tor}_{n+1}(A, F) \rightarrow \text{Tor}_{n+1}(A, B') \rightarrow \text{Tor}_n(A, B) \rightarrow \text{Tor}_n(A, F) = 0$  is exact.  $\square$

**Corollary 3.21**  *$\text{Tor}_n^R(A, B)$  can be computed from any flat resolution of  $B$ .*

## Exercises

1. Compute  $\text{Tor}_n^{\mathbb{Z}_8}(\mathbb{Z}_4, \mathbb{Z}_4)$ .
2. Define what it means for Ext to be a bifunctor, and prove it.
3. Suppose  $\langle F_n, d_n \rangle$  is a flat resolution of  $A$ . Show that the  $n$ th homology of

$$\cdots \rightarrow F_2 \otimes B \rightarrow F_1 \otimes B \rightarrow F_0 \otimes B \rightarrow 0$$

is isomorphic to  $\text{Tor}_n(A, B)$  by the following steps:

- a) Verify the case  $n = 0$ .
  - b) Verify the case  $n = 1$  by the following device: Set  $K = \text{im } d_1 \subset F_0$ . One has a short exact sequence  $0 \rightarrow K \rightarrow F_0 \rightarrow A \rightarrow 0$ , to which Theorem 3.4(a) applies. One also has  $F_2 \rightarrow F_1 \rightarrow K \rightarrow 0$  exact, and  $\otimes B$  is right exact. Play these off against each other.
  - c) Verify the induction step  $n \rightarrow n+1$ , using Theorem 3.4(a) again, along with the fact that  $\cdots \rightarrow F_2 \rightarrow F_1 \rightarrow K \rightarrow 0$  is a flat resolution of  $K$ .
4. Complete the proof of Proposition 3.9, as stated in the last two sentences in the proof.
  5. Show that, in defining a zigzag in Proposition 3.11, the conditions “ $d(x_0) = 0$ ” and “ $\partial(x_n) = 0$ ” follow from “ $\partial(x_j) = d(x_{j+1})$ ” when  $n \geq 2$ .
  6. Complete the proof of Proposition 3.11, as described in the last sentence in the proof.
  7. Suppose  $\langle E_i, d_i \rangle$  is an injective resolution of  $C \in {}_R\mathbf{M}$ ,  $\langle E'_i, d'_i \rangle$  is an injective resolution of  $C'$ , and  $\varphi \in \text{Hom}(C, C')$ . Show that fillers  $\varphi_n$  exist for

$$\begin{array}{ccccccccccc} 0 & \longrightarrow & C & \xrightarrow{\iota} & E_0 & \xrightarrow{d_1} & E_1 & \xrightarrow{d_2} & E_2 & \longrightarrow & \cdots \\ & & \downarrow \varphi & & \downarrow \varphi_0 & & \downarrow \varphi_1 & & \downarrow \varphi_2 & & \\ 0 & \longrightarrow & C' & \xrightarrow{\iota'} & E'_0 & \xrightarrow{d'_1} & E'_1 & \xrightarrow{d'_2} & E'_2 & \longrightarrow & \cdots \end{array}$$

and that any two fillers are homotopic.

8. Show that if  $\text{Ext}_R^1(B, C) = 0$ , then any short exact sequence  $0 \rightarrow C \rightarrow X \rightarrow B \rightarrow 0$  is split. (This has a converse; in fact,  $\text{Ext}_R^1(B, C)$  parametrizes the available  $X$ 's. This can be found in many books, for example Northcott [60, pp. 83–87] or Rotman [68, pp. 202–206]. It is the origin of “Ext” as a shortened form of “Extension”.)

9. Suppose  $I$  is a left ideal and  $J$  is a right ideal. Show that

- a)  $\text{Tor}_n(R/J, R/I) \approx \text{Tor}_{n-2}(J, I)$  for  $n > 2$ .
- b)  $\text{Tor}_2(R/J, R/I) \approx \text{kernel of } (J \otimes I \rightarrow JI)$ .
- c)  $\text{Tor}_1(R/J, R/I) \approx (J \cap I)/(JI)$ .

10. Suppose  $B$  is an Abelian group. The *torsion subgroup*,  $T(B)$ , is the subgroup of  $B$  consisting of elements of finite order. Show that  $T(B) \approx \text{Tor}_1^{\mathbb{Z}}(\mathbb{Q}/\mathbb{Z}, B)$ . (This result and others like it gave Tor its name, short for "Torsion.")

Hint:  $B/T(B)$  is torsion free, hence flat, and  $0 \rightarrow T(B) \rightarrow B \rightarrow B/T(B) \rightarrow 0$  is short exact. Also,  $\mathbb{Q}/\mathbb{Z}$  has a straightforward flat resolution. Finally, there are no nonzero bilinear forms on  $\mathbb{Q} \times T(B)$ . (Why?) What does this say about  $\mathbb{Q} \otimes T(B)$ ?

11. Show that

- a)  $\text{Ext}^n(\bigoplus_I B_i, C) \approx \prod_I \text{Ext}^n(B_i, C)$ .
- b)  $\text{Ext}^n(B, \prod_I C_i) \approx \prod_I \text{Ext}^n(B, C_i)$ .
- c)  $\text{Tor}_n(A, \bigoplus_I B_i) \approx \bigoplus_I \text{Tor}_n(A, B_i)$ .

12. Suppose  $B_1$  and  $B_2$  are submodules of  $B \in {}_R\mathbf{M}$ . Show that  $\forall C \in {}_R\mathbf{M}$  there is a long exact sequence

$$\begin{array}{c}
 \cdots \\
 \longrightarrow \text{Ext}^n(B_1 + B_2, C) \longrightarrow \text{Ext}^n(B_1, C) \oplus \text{Ext}^n(B_2, C) \longrightarrow \text{Ext}^n(B_1 \cap B_2, C) \longrightarrow \cdots \\
 \cdots \\
 \longrightarrow \text{Ext}^1(B_1 + B_2, C) \longrightarrow \text{Ext}^1(B_1, C) \oplus \text{Ext}^1(B_2, C) \longrightarrow \text{Ext}^1(B_1 \cap B_2, C) \longrightarrow \cdots \\
 0 \longrightarrow \text{Hom}(B_1 + B_2, C) \longrightarrow \text{Hom}(B_1, C) \oplus \text{Hom}(B_2, C) \longrightarrow \text{Hom}(B_1 \cap B_2, C) \longrightarrow \cdots
 \end{array}$$

Derive similar exact sequences for the second variable in Ext and for Tor. These are called *algebraic Mayer-Vietoris sequences*.



# 4

## Dimension Theory

### 4.1 Dimension Shifting

The functors  $\text{Ext}$  and  $\text{Tor}$  measure properties of the modules entered as variables, but for certain purposes they provide too much information. The underlying idea in this chapter (and much of the next) is to defocus a bit. The resulting concept (expressed as a number) is called *dimension*, and we shall define three such dimensions for any  $B \in {}_R\mathbf{M}$ .

There are advantages and disadvantages to the dimension concept. The most obvious disadvantage is that information is lost. More subtle is the fact that any dimension will be only a number, not a group. All the algebra that comes associated with group theory is lost, too.

There are two things gained. The first is that there will be only one variable instead of two; the modules will stand alone. The second is that relations between dimensions of modules can be set up using devices other than module homomorphisms. In particular, even the ring itself can change.

Dimension is easy enough to define, although some care is required to keep the trivial module from having dimension  $-1$ . (Actually, some authors make this convention.) Projective dimension first. A preliminary observation is helpful.

Suppose  $n \geq 1$ , and  $\text{Ext}^n(B, \bullet) \equiv 0$ , that is, suppose  $\text{Ext}^n(B, C) = 0$  for any  $C \in {}_R\mathbf{M}$ . Then for any  $C \in {}_R\mathbf{M}$ , imbedding  $C$  in an injective  $E$  yields  $\text{Ext}^{n+1}(B, C) \approx \text{Ext}^n(B, E/C) = 0$  by Corollary 3.6. Thus,  $\text{Ext}^{n+1}(B, \bullet) \equiv 0$ , too. Continuing this upward:

*If  $B \in {}_R\mathbf{M}$ ,  $n \geq 1$ , and  $\text{Ext}^n(B, \bullet) \equiv 0$ , then  $\text{Ext}^k(B, \bullet) \equiv 0$  for all*

$$k \geq n.$$

We now define *projective dimension*, abbreviated P-dim :

$$\text{P-dim } B = \inf\{n \geq 0 : \text{Ext}^{n+1}(B, \bullet) \equiv 0\}.$$

(By the usual convention, the infimum of the empty set is  $\infty$ .) In words, we have an ironclad guarantee that (for  $k \geq 1$ )  $\text{Ext}^k(B, C)$  will be zero, regardless of  $C$ , exactly when  $k > \text{P-dim } B$ . Note also that  $B$  has projective dimension zero if and only if  $B$  is actually projective, since that is exactly when  $\text{Ext}^1(B, \bullet) \equiv 0$  by Corollary 3.8

Injective and flat dimension are defined analogously. As above, if  $C \in {}_R\mathbf{M}$  and  $\text{Ext}^n(\bullet, C) \equiv 0$ , and  $B \in {}_R\mathbf{M}$ , then one may find a projective  $P$  mapping onto  $B$  by the enough projectives theorem; say  $0 \rightarrow K \rightarrow P \rightarrow B \rightarrow 0$ . Then by Corollary 3.14,  $\text{Ext}^{n+1}(B, C) \approx \text{Ext}^n(K, C) = 0$ . Since  $B$  is arbitrary,  $\text{Ext}^{n+1}(\bullet, C) \equiv 0$ , too. Thus,

*If  $C \in {}_R\mathbf{M}$ ,  $n \geq 1$ , and  $\text{Ext}^n(\bullet, C) \equiv 0$ , then  $\text{Ext}^k(\bullet, C) \equiv 0$  for all  $k \geq n$ .*

We now define *injective dimension*, abbreviated I-dim :

$$\text{I-dim } C = \inf\{n \geq 0 : \text{Ext}^{n+1}(\bullet, C) \equiv 0\}.$$

Finally, the following is left as an exercise:

*If  $B \in {}_R\mathbf{M}$ ,  $n \geq 1$ , and  $\text{Tor}_n(\bullet, B) \equiv 0$ , then  $\text{Tor}_k(\bullet, B) \equiv 0$  for all  $k \geq n$ .*

With this in mind, we define *flat dimension*, abbreviated F-dim :

$$\text{F-dim } B = \inf\{n \geq 0 : \text{Tor}_{n+1}(\bullet, B) \equiv 0\}.$$

In a similar way, one may define projective dimension, injective dimension, and flat dimension for  $A \in \mathbf{M}_R$ .

We now define dimensions for  $R$  itself. The *left global dimension* of  $R$ , abbreviated LG-dim, is defined as follows:

$$\text{LG-dim } R = \sup\{\text{P-dim } B : B \in {}_R\mathbf{M}\}.$$

Similarly, one can define the *right global dimension*, abbreviated RG-dim, as follows:

$$\text{RG-dim } R = \sup\{\text{P-dim } A : A \in \mathbf{M}_R\}.$$

The (left) *weak dimension*, abbreviated W-dim, is defined as follows:

$$\text{W-dim } R = \sup\{\text{F-dim } B : B \in {}_R\mathbf{M}\}.$$

The word “left” is actually superfluous, thanks to the following.

**Proposition 4.1**

- a)  $\text{LG-dim } R = \inf\{n \geq 0 : \text{Ext}^{n+1}(\bullet, \bullet) \equiv 0\}$   
 $= \sup\{\text{I-dim } C : C \in {}_R\mathbf{M}\}.$
- b)  $\text{W-dim } R = \inf\{n \geq 0 : \text{Tor}_{n+1}(\bullet, \bullet) \equiv 0\}$   
 $= \sup\{\text{F-dim } A : A \in \mathbf{M}_R\}.$

**Proof:** For  $n < \infty$ ,

$$\begin{aligned} n \geq \text{LG-dim } R &\Leftrightarrow n \geq \text{P-dim } B \text{ for all } B \in {}_R\mathbf{M} \\ &\Leftrightarrow \text{Ext}^{n+1}(B, C) = 0 \text{ for all } B \in {}_R\mathbf{M}, C \in {}_R\mathbf{M} \\ &\Leftrightarrow n \geq \text{I-dim } C \text{ for all } C \in {}_R\mathbf{M}. \end{aligned}$$

This proves (a); (b) is similar.  $\square$

The fundamental tool in this section is a generalized form of dimension shifting. The setup is the same for projectives, injectives, and flats, but the interpretation is slightly different. The following result incorporates the relevant mathematics to the extent that all that follows in this section is really corollary. Nevertheless, the consequences will require some discussion.

**Proposition 4.2** *Suppose  $0 \rightarrow D \rightarrow L_1 \rightarrow L_2 \rightarrow \cdots \rightarrow L_n \rightarrow D' \rightarrow 0$  is exact in  ${}_R\mathbf{M}$ , and  $d \geq 0$ .*

- a) *If  $\text{P-dim } L_j \leq d$  for all  $j$ , then  $\text{Ext}^k(D, C) \approx \text{Ext}^{k+n}(D', C)$  for all  $C \in {}_R\mathbf{M}$ , and  $k > d$ .*
- b) *If  $\text{I-dim } L_j \leq d$  for all  $j$ , then  $\text{Ext}^k(B, D') \approx \text{Ext}^{k+n}(B, D)$  for all  $B \in {}_R\mathbf{M}$ , and  $k > d$ .*
- c) *If  $\text{F-dim } L_j \leq d$  for all  $j$ , then  $\text{Tor}_k(A, D) \approx \text{Tor}_{k+n}(A, D')$  for all  $A \in \mathbf{M}_R$ , and  $k > d$ .*

**Proof:** They all work essentially the same way, so only (a) will be proved. The proof is by induction on  $n$ ; the discussion of the  $n = 1$  case also carries out the induction step.

Given  $n = 1$ , we have  $0 \rightarrow D \rightarrow L_1 \rightarrow D' \rightarrow 0$  short exact, and a piece of the long exact sequence of Proposition 3.13 yields, for  $k > d$ :

$$0 = \text{Ext}^k(L_1, C) \rightarrow \text{Ext}^k(D, C) \rightarrow \text{Ext}^{k+1}(D', C) \rightarrow \text{Ext}^{k+1}(L_1, C) = 0.$$

The induction step (with  $n \geq 2$ ) comes from defining  $Q$  to be the kernel of  $L_n \rightarrow D'$ . We have *two* sequences,  $0 \rightarrow D \rightarrow L_1 \rightarrow L_2 \rightarrow \cdots \rightarrow L_{n-1} \rightarrow Q \rightarrow 0$  and  $0 \rightarrow Q \rightarrow L_n \rightarrow D' \rightarrow 0$ . We thus get (by induction)

$$\text{Ext}^k(D, C) \approx \text{Ext}^{k+n-1}(Q, C) \approx \text{Ext}^{k+n}(D', C). \quad \square$$

For this chapter, we will be primarily concerned with the  $d = 0$  case, that is, where the  $L_k$  are projective, injective, or flat, respectively. One corollary to the general case needs to be recorded now; it will play a role in Chapter 5.

**Corollary 4.3** *Suppose  $0 \rightarrow Q_n \rightarrow Q_{n-1} \rightarrow \cdots \rightarrow Q_1 \rightarrow Q_0 \rightarrow B \rightarrow 0$  is exact in  ${}_R\mathbf{M}$ .*

a) *If  $\text{P-dim } Q_j \leq d$ , for all  $j$ , then  $\text{P-dim } B \leq d + n$ .*

b) *If  $\text{F-dim } Q_j \leq d$ , for all  $j$ , then  $\text{F-dim } B \leq d + n$ .*

**Proof:** For (a)  $\text{Ext}^{d+n+1}(B, C) \approx \text{Ext}^{d+1}(Q_n, C) = 0$  for all  $C \in {}_R\mathbf{M}$ . For (b)  $\text{Tor}_{d+n+1}(A, B) \approx \text{Tor}_{d+1}(A, Q_n) = 0$  for all  $A \in \mathbf{M}_R$ .  $\square$

To proceed, suppose we are given a projective (or flat) resolution of  $B \in {}_R\mathbf{M}$ :

$$\cdots \rightarrow P_2 \xrightarrow{d_2} P_1 \xrightarrow{d_1} P_0 \xrightarrow{\pi} B \rightarrow 0.$$

Set  $K_0 = B$ ,  $K_1 = \ker \pi$ , and  $K_n = \ker d_{n-1}$  if  $n \geq 2$ . In all cases, we may define a new "resolution" of  $B$  by defining, for  $n$  fixed,

$$P'_k = \begin{cases} P_k, & \text{if } k < n \\ K_n, & \text{if } k = n \\ 0, & \text{if } k > n \end{cases}$$

to get  $\cdots \rightarrow 0 \rightarrow 0 \rightarrow K_n \rightarrow P_{n-1} \rightarrow \cdots \rightarrow P_0 \rightarrow B \rightarrow 0$ , which will be exact. If, by chance (!),  $K_n$  is projective (or flat), we have a new projective (or flat) resolution of  $B$ .  $K_n$  is called the  $n$ th kernel of the projective (or flat) resolution  $\langle P_k, d_k \rangle$ .

**Proposition 4.4 (Projective Dimension Theorem)** *Suppose  $B \in {}_R\mathbf{M}$ . The following are equivalent:*

- i)  $\text{P-dim } B \leq n$ .
- ii) *The  $n$ th kernel of any projective resolution of  $B$  is projective.*
- iii) *There exists a projective resolution of  $B$  whose  $n$ th kernel is projective.*
- iv) *There exists a projective resolution  $\langle P_k, d_k \rangle$  of  $B$  for which  $P_k = 0$  when  $k > n$ .*

**Proof:** (i)  $\Rightarrow$  (ii) follows from Corollary 3.8, since  $\text{Ext}^1(K_n, C) \approx \text{Ext}^{n+1}(B, C)$  if  $K_n$  is the  $n$ th kernel of a projective resolution of  $B$ . (ii)  $\Rightarrow$  (iii) is trivial. (iii)  $\Rightarrow$  (iv) by the discussion immediately preceding this proposition. Finally, (iv)  $\Rightarrow$  (i), since  $\text{Ext}^{n+1}(B, C)$  will be the homology at  $\cdots \leftarrow \text{Hom}(P_{n+1}, C) \leftarrow \cdots$ , and  $P_{n+1} = 0$ .  $\square$

**Proposition 4.5 (Flat Dimension Theorem)** *Suppose  $B \in {}_R\mathbf{M}$ . The following are equivalent:*

- i)  $\text{F-dim } B \leq n$ .
- ii)  $\text{Tor}_{n+1}(R/I, B) = 0$  for all finitely generated right ideals  $I$ .
- iii) The  $n$ th kernel of any flat resolution of  $B$  is flat.
- iv) There exists a flat resolution of  $B$  whose  $n$ th kernel is flat.
- v) There exists a flat resolution  $\langle F_k, d_k \rangle$  of  $B$  for which  $F_k = 0$  when  $k > n$ .

**Proof:** Pretty much like Proposition 4.4, except (ii)  $\Rightarrow$  (iii) uses Corollary 3.19.  $\square$

**Corollary 4.6** *For all  $B \in {}_R\mathbf{M}$ ,  $\text{F-dim } B \leq \text{P-dim } B$ .*

**Proof:** If  $\text{P-dim } B = \infty$ , this is immediate. If  $\text{P-dim } B = n < \infty$ , then the  $n$ th kernel of a projective resolution of  $B$  is projective, hence flat. Thus,  $\text{F-dim } B \leq n$ .  $\square$

**Corollary 4.7**  *$\text{LG-dim } R \geq \text{W-dim } R$  and  $\text{RG-dim } R \geq \text{W-dim } R$ .*

**Proof:** Take the supremum; see also Proposition 3.16.  $\square$

Now for injectives. Suppose we are given an injective resolution of  $C \in {}_R\mathbf{M}$ :

$$0 \rightarrow C \xrightarrow{\iota} E_0 \xrightarrow{d_1} E_1 \xrightarrow{d_2} E_2 \rightarrow \dots$$

Set  $D_n = \text{im } d_n$  if  $n \geq 1$ , while  $D_0 = C$ . Again, fixing  $n$ , if we define

$$E'_k = \begin{cases} E_k, & \text{if } k < n \\ D_n, & \text{if } k = n \\ 0, & \text{if } k > n \end{cases}$$

to get  $0 \rightarrow C \rightarrow E_0 \rightarrow \dots \rightarrow E_{n-1} \rightarrow D_n \rightarrow 0 \rightarrow 0 \rightarrow \dots$  we have an exact sequence. It is an injective resolution of  $C$  provided  $D_n$  is injective.  $D_n$  is called the  $n$ th cokernel of the injective resolution.

**Proposition 4.8 (Injective Dimension Theorem)** *Suppose  $C \in {}_R\mathbf{M}$ . The following are equivalent:*

- i)  $\text{I-dim } C \leq n$ .



ii)  $\text{Ext}^{n+1}(R/I, C) = 0$  for all left ideals  $I$ .

iii) The  $n$ th cokernel of any injective resolution of  $C$  is injective.

iv) There exists an injective resolution of  $C$  whose  $n$ th cokernel is injective.

v) There exists an injective resolution  $\langle E_k, d_k \rangle$  of  $C$  for which  $E_k = 0$  when  $k > n$ .

**Proof:** Again, like Proposition 4.4, with arrows reversed. (ii)  $\Rightarrow$  (iii) uses Corollary 3.15.  $\square$

The fact that (ii) only incorporates quotients  $R/I$ , for  $I$  a left ideal, leads to the following, due to Auslander:

**Proposition 4.9 (Global Dimension Theorem)**

$$\text{LG-dim } R = \sup\{\text{P-dim } (R/I) : I \text{ a left ideal}\}.$$

**Proof:** Set  $n = \sup\{\text{P-dim } (R/I) : I \text{ a left ideal}\}$ .  $n \leq \text{LG-dim } R$  by definition, so suppose  $n < \text{LG-dim } R$ . Then  $n < \infty$ , so by Proposition 4.1(a), there exists a  $C \in {}_R\mathbf{M}$  with  $\text{I-dim } C > n$ . By Proposition 4.8, there exists a left ideal  $I$  for which  $\text{Ext}^{n+1}(R/I, C) \neq 0$ . But now by definition  $\text{P-dim } (R/I) > n$ , contradicting the definition of  $n$ .  $\square$

**Corollary 4.10** *If  $\text{LG-dim } R > 0$ , then  $\text{LG-dim } R = 1 + \sup\{\text{P-dim } I : I \text{ a left ideal}\}$ .*

**Proof:** From  $0 \rightarrow I \rightarrow R \rightarrow R/I \rightarrow 0$ , for all  $n \geq 1$ ,  $\text{Ext}^n(I, C) \approx \text{Ext}^{n+1}(R/I, C)$ . Hence, if  $R/I$  is not projective, then  $n+1 > \text{P-dim } (R/I)$  if and only if  $n > \text{P-dim } I$ . That is,  $\text{P-dim } (R/I) = 1 + \text{P-dim } I$ . (This is a special case of some general results; see the exercises and the next chapter.) On the other hand, if  $R/I$  is projective, then so is  $I$  by setting  $n = 1$ . Hence, in all cases,  $1 + \text{P-dim } I \leq \text{LG-dim } R$ , while if  $\text{P-dim } (R/I) > 0$ , then  $\text{P-dim } (R/I) = 1 + \text{P-dim } I$ . Taking the (positive) supremum yields the result.  $\square$

**Corollary 4.11**  *$\text{LG-dim } R \leq 1$  if and only if every left ideal is projective.*

Rings with this property are called *left hereditary*.

**Corollary 4.12** *If  $R$  is a PID, then  $\text{LG-dim } R \leq 1$ .*

**Proof:** If  $I = Ra \neq 0$ , then  $I$  is isomorphic to  $R$  in  ${}_R\mathbf{M}$  since  $R$  is an integral domain ( $I$  is free on  $\{a\}$ ).  $\square$

**Note:** The ring  $\mathbb{Z}_4$  has infinite weak dimension, since  $\text{Tor}_n^{\mathbb{Z}_4}(\mathbb{Z}_2, \mathbb{Z}_2) \approx \mathbb{Z}_2 \neq 0$ , a calculation from Chapter 3. Note that  $\mathbb{Z}_4$  is a principal ideal ring; the preceding corollary requires  $R$  to be an integral domain.

Finally, we have:

### Proposition 4.13 (Weak Dimension Theorem)

$$\begin{aligned} \text{W-dim } R &= \sup\{\text{F-dim } (R/I) : I \text{ a finitely generated right ideal}\} \\ &= \sup\{\text{F-dim } (R/I) : I \text{ a finitely generated left ideal}\}. \end{aligned}$$

**Proof:** Much like Proposition 4.9, but using the flat dimension theorem instead of the injective dimension theorem.  $\square$

**Corollary 4.14** *If  $\text{W-dim } R > 0$ , then  $\text{W-dim } R = 1 + \sup\{\text{F-dim } I : I \text{ a finitely generated right ideal}\} = 1 + \sup\{\text{F-dim } I : I \text{ a finitely generated left ideal}\}$ .*

**Corollary 4.15**  *$\text{W-dim } R \leq 1$  if and only if every finitely generated left ideal is flat.*

## 4.2 When Flats are Projective

At this point, we know that all projectives are flat, but not vice versa (e.g.,  $\mathbb{Q}$  as a  $\mathbb{Z}$ -module). It turns out that all nonprojective flats are “big” in some sense. The purpose of this section is to clarify the matter.

First, some remarks about module homomorphisms. Suppose  $B \in {}_R\mathbf{M}$ . Define  $B^*$  to be  $\text{Hom}(B, R)$ . Note that since  $R \in {}_R\mathbf{M}_R$ , we have that  $B^* \in \mathbf{M}_R$ . Further, we have a natural map from  $B^* \otimes C$  to  $\text{Hom}(B, C)$ . How? The same way we *always* get maps from tensor products: Define a bilinear map from  $B^* \times C$  to  $\text{Hom}(B, C)$  by sending  $(f, c)$  to  $\varphi$ , where  $\varphi(b) = f(b) \cdot c$ . Bilinearity is easy to check, as is naturality: If  $B \rightarrow \tilde{B}$  is given, then

$$\begin{array}{ccc} B^* \times C \longleftarrow \tilde{B}^* \times C & & B^* \otimes C \longleftarrow \tilde{B}^* \otimes C \\ \downarrow & & \downarrow \\ \text{Hom}(B, C) \longleftarrow \text{Hom}(\tilde{B}, C) & \text{and} & \text{Hom}(B, C) \longleftarrow \text{Hom}(\tilde{B}, C) \end{array}$$

commute. This is the most important part; similarly paired diagrams involving  $C \rightarrow C'$  are also commutative. Details are left to the reader.

To make further progress, we need to identify projectives more closely. The preceding discussion will be relevant in the finitely generated case.

**Proposition 4.16 (Projective Basis Theorem)** *Suppose  $P \in {}_R\mathbf{M}$ . The following are equivalent:*

- i)  $P$  is projective.
- ii) If  $P$  is generated by  $\{s_i : i \in \mathcal{I}\}$ , then there exist  $\varphi_i \in P^*$ ,  $i \in \mathcal{I}$  such that for all  $x \in P$ ,  $\{i \in \mathcal{I} : \varphi_i(x) \neq 0\}$  is finite, and  $x = \sum \varphi_i(x)s_i$ .
- iii) There exists a generating set  $\{s_i : i \in \mathcal{I}\}$  of  $P$  for which there exist  $\varphi_i \in P^*$ ,  $i \in \mathcal{I}$  such that for all  $x \in P$ ,  $\{i \in \mathcal{I} : \varphi_i(x) \neq 0\}$  is finite, and  $x = \sum \varphi_i(x)s_i$ .

**Proof:** (i)  $\Rightarrow$  (ii). Suppose  $P$  is generated by  $\{s_i : i \in \mathcal{I}\}$ . Let  $F$  be the free module on  $\mathcal{I}$ ,  $\pi : F \rightarrow P$  defined via  $i \mapsto s_i$ . Then  $F \rightarrow P \rightarrow 0$  is exact, hence splits since  $P$  is projective. Suppose  $\eta : P \rightarrow F$  is a splitting, with  $\eta(x) = \langle \varphi_i(x) : i \in \mathcal{I} \rangle$ , that is, suppose the  $i$ th coordinate of  $\eta$  is  $\varphi_i$ . Then these  $\varphi_i$  have all the required properties, including  $x = \sum \varphi_i(x)s_i$ , which follows from  $i_P = \pi\eta$ .

(ii)  $\Rightarrow$  (iii) is trivial, so assume (iii), and again let  $F$  be the free module on  $\mathcal{I}$ ,  $\pi : F \rightarrow P$  defined via  $i \mapsto s_i$ . Run the previous paragraph in reverse; define  $\eta(x) = \sum \varphi_i(x) \cdot i$ , that is, define  $\eta(x)$  by requiring its  $i$ th coordinate to be  $\varphi_i(x)$ . Then  $x = \sum \varphi_i(x) \cdot s_i$  implies that  $i_P = \pi\eta$ , so that  $F \rightarrow P \rightarrow 0$  splits. Thus,  $P$  is (isomorphic to) a direct summand of  $F$ , and so is projective.  $\square$

**Corollary 4.17** *Suppose  $P$  is finitely generated. Then  $P$  is projective if and only if the image of the natural map:  $P^* \otimes P \rightarrow \text{Hom}(P, P)$  contains  $i_P$ .*

**Proof:**  $x = \sum \varphi_i(x) \cdot s_i$  for all  $x \Leftrightarrow \sum \varphi_i \otimes s_i \mapsto i_P$ .  $\square$

Before generalizing this to identify finitely generated projective modules more closely, we need to discuss finitely generated free modules. First note that  $R^* \approx R$ , so that  $R^* \otimes C \approx C \approx \text{Hom}(R, C)$  for any  $C \in {}_R\mathbf{M}$ . Taking finite direct sums, we see that  $F^* \otimes C \approx \text{Hom}(F, C)$  for any finitely generated free module  $F$ .

Finally, suppose  $B \in {}_R\mathbf{M}$  is finitely generated.  $B$  is called *finitely presented* provided there exists a finitely generated free module  $F$ , and a map  $\pi$  from  $F$  onto  $B$ , such that  $\ker \pi$  is also finitely generated. Observe that if  $F \xrightarrow{\pi} B \rightarrow 0$  splits, then  $\ker \pi$  is a direct summand, hence an image, of  $F$ ;  $\ker \pi$  will then automatically be finitely generated. Thus all finitely generated projective modules are finitely presented. Since we will need it in Chapter 8, the next result is stated as a proposition.

**Proposition 4.18** *Suppose  $B \in {}_R\mathbf{M}$  is flat, and suppose  $C \in {}_R\mathbf{M}$  is finitely presented. Then  $C^* \otimes B \rightarrow \text{Hom}(C, B)$  is an isomorphism.*

**Proof:** We may suppose that we have finitely generated free modules  $F_0$  and  $F_1$ , and an exact sequence  $F_1 \rightarrow F_0 \rightarrow C \rightarrow 0$ .  $\text{Hom}(\bullet, R)$  is left exact, so  $0 \rightarrow C^* \rightarrow F_0^* \rightarrow F_1^*$  is exact.  $B$  is flat, so we have exactness of  $0 \rightarrow C^* \otimes B \rightarrow F_0^* \otimes B \rightarrow F_1^* \otimes B$ . But naturality of  $A^* \otimes B \rightarrow \text{Hom}(A, B)$  in the variable  $A$  gives commutativity of

$$\begin{array}{ccccccc} 0 & \longrightarrow & 0 & \longrightarrow & C^* \otimes B & \longrightarrow & F_0^* \otimes B & \longrightarrow & F_1^* \otimes B \\ \cong & & \cong & & \downarrow & & \cong & & \cong \\ 0 & \longrightarrow & 0 & \longrightarrow & \text{Hom}(C, B) & \longrightarrow & \text{Hom}(F_0, B) & \longrightarrow & \text{Hom}(F_1, B) \end{array}$$

so that  $C^* \otimes B \rightarrow \text{Hom}(C, B)$  is an isomorphism by the 5-lemma.  $\square$

We can now give the main result of this section.

**Theorem 4.19** *Suppose  $P \in {}_R\mathbf{M}$  is finitely generated. The following are equivalent:*

- i)  $P$  is projective.*
- ii)  $P$  is flat and finitely presented.*
- iii) The natural map from  $P^* \otimes P$  to  $\text{Hom}(P, P)$  is an isomorphism.*
- iv) The image of the natural map from  $P^* \otimes P$  to  $\text{Hom}(P, P)$  contains  $i_P$ .*

**Proof:** (i)  $\Rightarrow$  (ii) is contained in the discussions preceding Proposition 4.18. (ii)  $\Rightarrow$  (iii) follows from Proposition 4.18 by setting  $B = P$  and  $C = P$ . (iii)  $\Rightarrow$  (iv) is trivial. Finally, (iv)  $\Rightarrow$  (i) is part of Corollary 4.17.  $\square$

Now suppose  $R$  is left Noetherian. Suppose  $B \in {}_R\mathbf{M}$ , and suppose  $B$  is finitely generated. Choose a finitely generated free  $F_0$  and  $\pi$  from  $F_0$  onto  $B$ .  $\ker \pi$  is also finitely generated; choose a finitely generated  $F_1$  and  $d_1$  from  $F_1$  onto  $\ker \pi$ ; etc. Moral: If  $B \in {}_R\mathbf{M}$  and  $B$  is finitely generated, then  $B$  has a projective resolution consisting of finitely generated free modules. Note that given any such resolution, the  $n$ th kernel will be finitely generated; in fact, it will be finitely presented. Hence, it will be projective exactly when it is flat. Combining this with the projective and flat dimension theorems proves:

**Proposition 4.20** *Suppose  $R$  is left Noetherian, and suppose  $B$  is a finitely generated left  $R$ -module. Then  $\text{P-dim } B = \text{F-dim } B$ .*



**Corollary 4.21** *Suppose  $R$  is left Noetherian. Then  $\text{LG-dim } R = \text{W-dim } R$ .*

**Proof:** The global and weak dimension theorems imply that only dimensions of quotients  $R/I$  need to be examined, and  $\text{P-dim } R/I = \text{F-dim } R/I$  by Proposition 4.20.  $\square$

**Corollary 4.22 (Auslander)** *Suppose  $R$  is both right and left Noetherian. Then  $\text{LG-dim } R = \text{RG-dim } R$ .*

**Proof:** Both equal  $\text{W-dim } R$ .  $\square$

### 4.3 Dimension Zero

The second corollary to the projective dimension theorem asserts that  $R$  has left global dimension less than or equal to one if and only if every left ideal is projective. In this section we shall be concerned with small dimension, especially dimension zero. Some useful things can be said about global dimension one, however, primarily for integral domains.

The term “Dedekind domain” is one of those mathematical terms with many possible definitions. The one we adopt is this: A *Dedekind domain* is an integral domain with global dimension less than or equal to one. Hungerford [37, pp. 405–6] gives nine equivalent conditions; our definition appears sixth on his list. Rather than reproduce this, we shall be concerned with what the condition “Every ideal is projective” says, in view of the projective basis theorem. It will be helpful for later use to discuss this in more generality. First note that the zero ideal is always projective, and any nonzero ideal in an integral domain must contain nonzero divisors.

Suppose  $R$  is a commutative ring, and suppose  $I$  is a projective ideal which contains a nonzero divisor,  $b$ . Suppose  $I$  is generated by  $s_1, s_2, \dots$ . By the basis theorem, there exist module homomorphisms  $\varphi_i : I \rightarrow R$  for which each  $x \in I$  is given by  $x = \sum \varphi_i(x)s_i$  (finite sum for each  $x$ ). However, if  $x \in I$ , then  $b\varphi_i(x) = \varphi_i(bx) = \varphi_i(xb) = x\varphi_i(b)$ . Hence, if  $\varphi_i(b) = 0$ , then for any  $x \in I$ ,  $b\varphi_i(x) = 0$ . But then  $\varphi_i(x) = 0$  since  $b$  is not a zero divisor. Since  $x$  is arbitrary,  $\varphi_i \equiv 0$  whenever  $\varphi_i(b) = 0$ . But  $\varphi_i(b) \neq 0$  only for finitely many  $i$ , so all but finitely many  $\varphi_i$  are identically zero. Since those  $i$  for which  $\varphi_i \equiv 0$  can be discarded from “ $x = \sum \varphi_i(x)s_i$ ,” we get that both  $\{s_i\}$  and  $\{\varphi_i\}$  can be reduced to finite subsets. In particular,  $I$  is finitely generated. Further, if  $\varphi_i(b) = b_i$ , then for all  $x \in I$ ,  $b$  divides  $xb_i$ , and  $(xb_i)/b$  is exactly  $\varphi_i(x)$ . That is,  $x = \sum ((xb_i)/b)s_i$ , so that the coordinate homomorphisms are computed from the ring operations. Finally, setting  $S = \{1, b, b^2, b^3, \dots\}$ ,  $R$  imbeds in the ring  $S^{-1}R$  of quotients (since  $b$  is a nonzero divisor), where the equation “ $\varphi_i(x) = x \cdot (b_i/b)$ ” is valid. We have proved:



**Proposition 4.23** *Suppose  $R$  is commutative, and  $I$  is a projective ideal containing a nonzero divisor  $b$ . Then  $I$  is finitely generated, say by  $s_1, \dots, s_n$ . Further, there exist  $b_1, \dots, b_n$  in  $R$  such that, for all  $j$ ,  $b$  divides  $xb_j$  for all  $x \in I$ , and  $x = \Sigma((xb_j)/b)s_j$ . In particular, if  $R$  is an integral domain, then any projective ideal is finitely generated; hence, any Dedekind domain is Noetherian.*

A final note about this situation. Suppose  $J$  is the ideal generated by  $b_1, \dots, b_n$ . Then  $b$  divides each  $s_j b_j$  so  $IJ \subset Rb$ . However,  $b = \Sigma b_j s_j$  so  $IJ \supset Rb$ . Thus  $IJ = Rb$ . Further, if  $R$  is a Dedekind domain, then  $R = I \cdot (b^{-1}J)$  in the quotient field of  $R$ . (This establishes the connection between finding a “fractional ideal inverse” to  $I$ , and finding a projective basis.)

Now for global dimension zero. A number of associated concepts arise in this context, and we will need some lemmas. First note that, for a ring with left global dimension zero, every left  $R$ -module is injective by Proposition 4.1(a), so if  $B$  is a submodule of  $C$ , then  $B$  is a direct summand of  $C$  since  $B$  is injective, that is, an absolute direct summand. This establishes the relevance of the concept of *semisimple*.

**Definition 4.24** *If  $R$  is a ring, and  $B$  is an  $R$ -module (left or right), then  $B$  is semisimple if every submodule of  $B$  is a direct summand of  $B$ .*

Two more definitions also are needed; those of *simple* and *maximal*.

**Definition 4.25** *If  $R$  is a ring, and  $B$  is an  $R$ -module, then  $B$  is simple if  $B \neq 0$ , and the only submodules of  $B$  are  $0$  and  $B$ .*

Note that  $B$  is simple if and only if  $B \neq 0$ , and  $Rx = B$  for all  $x \in B$ ,  $x \neq 0$  (since  $Rx$  is a submodule).

**Definition 4.26** *If  $R$  is a ring,  $B$  is an  $R$ -module, and  $B'$  is a submodule, then  $B'$  is maximal if  $B/B'$  is simple, that is, if (thanks to submodule correspondence in the fundamental isomorphism theorems)  $B'$  is maximal among proper submodules of  $B$ .*

For the last definition, observe that if  $I$  is a maximal left ideal in  $R$ , then  $I$  is maximal as a submodule, that is,  $R/I$  is simple. On the other hand, if  $B$  is simple and  $0 \neq x \in B$ , then  $Rx = B$ . But  $Rx \approx R/\text{ann}(x)$ , where  $\text{ann}(x) = \{r \in R : rx = 0\}$  is the annihilator of  $x$ . Since  $B$  is simple,  $\text{ann}(x)$  is a maximal left ideal. Moral: Every simple left  $R$ -module is isomorphic to a quotient  $R/I$ , where  $I$  is a maximal left ideal.

It is clear that every simple module is semisimple, but trivially so; there is no obvious connection between the two concepts. There is a subtle one, as will soon become evident.

**Lemma 4.27** *Every submodule of a semisimple module is semisimple.*

**Proof:** This follows from the modular law (the term is from lattice theory, and its proof is left as an exercise): If  $A, B,$  and  $C$  are submodules of  $D$ , with  $A \subset C$ , then  $A + (B \cap C) = (A + B) \cap C$ . Taking  $C \subset D$  with  $D$  semisimple and  $A$  a submodule of  $C$ , there exists  $B$  such that  $A \oplus B = D$ , since  $D$  is semisimple. Hence,  $A + (B \cap C) = (A + B) \cap C = C$ . Since  $A \cap (B \cap C) \subset A \cap B = \{0\}$ ,  $A + (B \cap C)$  is a direct sum.  $\square$

Since the following will be needed in Chapter 9, it is recorded as a proposition.

**Proposition 4.28** *Suppose  $R$  is a ring, and  $B \in {}_R\mathbf{M}$ . Suppose  $B$  is generated by a set  $S$  together with an element  $x$ , but is not generated by  $S$  alone. Then any submodule of  $B$  that contains  $S$ , and is maximal (under set inclusion) with respect to the property of not containing  $x$ , is maximal as a submodule. Such submodules exist.*

**Proof:** If  $B'$  is such a submodule, then  $S \subset B'$ ,  $x \notin B'$ , and  $(B' \subset B'' \subset B, B'' \text{ a sub-module}) \Rightarrow x \in B''$ . But then  $x \in B''$  and  $S \subset B'' \Rightarrow B'' = B$  since  $S$  and  $x$  generate  $B$ . Hence,  $B'$  is maximal. It remains to show that such submodules exist. This uses Zorn's lemma: Look at the set  $\mathcal{B}$  of all submodules of  $B$  that contain  $S$  but do not contain  $x$ ; the submodule generated by  $S$  is such a submodule. Partially order by set inclusion. The union of a nonempty chain of submodules not containing  $x$  will be a submodule not containing  $x$ , and will constitute an upper bound for the chain. Since every nonempty chain in  $\mathcal{B}$  is bounded, Zorn's lemma applies, and  $\mathcal{B}$  has a maximal element.  $\square$

**Lemma 4.29** *Every nonzero semisimple module contains a simple submodule.*

**Proof:** Suppose  $B$  is semisimple, and  $0 \neq x \in B$ . Let  $B'$  be the submodule generated by  $x$ , and let  $S = \emptyset$ . Using Proposition 4.28, there exists a  $B''$  which is a maximal submodule of  $B'$ , so that  $B'/B''$  will be simple. But  $B'$  is semisimple by Lemma 4.27, so there exists  $B'''$  such that  $B' = B'' \oplus B'''$ . But  $B''' \approx B'/B''$ , so  $B'''$  is a simple submodule of  $B$ .  $\square$

**Lemma 4.30** *Every semisimple module is the sum of its simple submodules.*

**Proof:** Let  $B$  be semisimple, and let  $B'$  denote the sum of the simple submodules of  $B$ . If  $B \neq B'$ , then  $B = B' \oplus B''$  for a nonzero submodule  $B''$  since  $B$  is semisimple. But  $B''$  is semisimple by Lemma 4.27, so  $B''$  contains a simple submodule by Lemma 4.29. This contradicts  $B'' \cap B' = 0$ , since  $B'$  is the sum of *all* simple submodules of  $B$ .  $\square$

**Lemma 4.31** *Suppose  $B$  is an  $R$ -module,  $\mathcal{I}$  is an index set, and  $B_i$  is a simple submodule of  $B$  for each  $i \in \mathcal{I}$ . Also suppose  $B = \Sigma_{\mathcal{I}} B_i$ , that is,  $B$  is the sum (possibly not direct) of the  $B_i$ . Then for any submodule  $B'$  of  $B$  there exists a subset  $\mathcal{J}$  of  $\mathcal{I}$  such that  $B = B' \oplus (\oplus_{\mathcal{J}} B_i)$  (direct sum).*

**Proof:** Consider all subsets  $\mathcal{J}$  of  $\mathcal{I}$  such that  $B' + (\Sigma_{\mathcal{J}} B_i)$  is a direct sum,  $B' \oplus (\oplus_{\mathcal{J}} B_i)$ , and partially order by set inclusion. (The empty set is such a subset of  $\mathcal{I}$ .) Zorn's lemma applies: Given any chain  $\{\mathcal{J}_\alpha\}$  of such subsets, their union  $\mathcal{J} = \cup \mathcal{J}_\alpha$  is such a subset, that is,  $B' + (\Sigma_{\mathcal{J}} B_i)$  is a direct sum,  $B' \oplus (\oplus_{\mathcal{J}} B_i)$ . To see this, observe that any  $b' + (\Sigma_{\mathcal{J}} b_i)$  (being a *finite* sum) has only nonzero  $b_i$  for (finitely many)  $i$  in *one* of the  $\mathcal{J}_\alpha$  (since  $\{\mathcal{J}_\alpha\}$  is a chain), so  $b' + (\Sigma_{\mathcal{J}} b_i) = 0 \Rightarrow b' = 0 = b_i$ , all  $i \in \mathcal{J}$ . Thus, there is a  $\mathcal{J} \subset \mathcal{I}$  which is maximal with the property that  $B' + (\Sigma_{\mathcal{J}} B_i)$  is a direct sum,  $B' \oplus (\oplus_{\mathcal{J}} B_i)$ . Suppose  $j \in \mathcal{I} - \mathcal{J}$ . Then  $\mathcal{J} \subsetneq \mathcal{J} \cup \{j\}$ , so  $B' + (\Sigma_{\mathcal{J} \cup \{j\}} B_i)$  is not a direct sum while  $B' \oplus (\oplus_{\mathcal{J}} B_i)$  is, so  $(B' \oplus (\oplus_{\mathcal{J}} B_i)) \cap B_j \neq 0$ . As a submodule of the simple module  $B_j$ ,  $(B' \oplus (\oplus_{\mathcal{J}} B_i)) \cap B_j = B_j$ . That is,  $B_j \subset B' \oplus (\oplus_{\mathcal{J}} B_i)$ . But that means that  $B' \oplus (\oplus_{\mathcal{J}} B_i)$  contains every  $B_j$ ,  $j \in \mathcal{I}$ , since it trivially contains every  $B_j$ ,  $j \in \mathcal{J}$ . Hence,  $B' \oplus (\oplus_{\mathcal{J}} B_i) \supset \Sigma_{\mathcal{I}} B_i = B$ .  $\square$

**Proposition 4.32** *Suppose  $B$  is an  $R$ -module. The following are equivalent:*

- i)  $B$  is semisimple.
- ii)  $B$  is a sum of simple submodules.
- iii)  $B$  is a direct sum of simple submodules.

**Proof:** (i)  $\Rightarrow$  (ii) is Lemma 4.30. (ii)  $\Rightarrow$  (iii) is Lemma 4.31, with  $B' = 0$ . (iii)  $\Rightarrow$  (ii) is trivial. (ii)  $\Rightarrow$  (i) follows from Lemma 4.31, since Lemma 4.31 says that any submodule  $B'$  is a direct summand, the other factor being  $\oplus_{\mathcal{J}} B_i$ .  $\square$

We now have the connection between simple modules and semisimple modules, but we will need more about simple modules. First note that for any  $R$ -module  $B$ ,  $\text{Hom}_R(B, B)$  is a ring with multiplication being functional composition. (It is an  $R$ -algebra if  $R$  is commutative.) This is called the *endomorphism ring* of  $B$ , and is denoted  $\text{End}(B)$  (or  $\text{End}_R(B)$  if  $R$  is to be emphasized). The following result and its corollary are easy, but are too important not to emphasize.

**Proposition 4.33** *If  $B$  and  $B'$  are simple  $R$ -modules, then every nonzero element of  $\text{Hom}(B, B')$  is an isomorphism.*

**Proof:** If  $0 \neq \varphi \in \text{Hom}(B, B')$ , then  $\varphi \neq 0 \Rightarrow \ker \varphi \neq B$ , so  $\ker \varphi = 0$  since  $B$  is simple. Also,  $\varphi \neq 0 \Rightarrow \text{im} \varphi \neq 0$ , so  $\text{im} \varphi = B'$  since  $B'$  is simple. Hence,  $\varphi \neq 0 \Rightarrow \varphi$  is bijective  $\Rightarrow \varphi^{-1}$  exists in  $\text{Hom}(B', B)$ .  $\square$

**Corollary 4.34 (Schur's Lemma)** *If  $B$  is a simple  $R$ -module, then  $\text{End}(B)$  is a division ring.*

If  $R$  is a ring, let  $M_n(R)$  denote the ring of  $n \times n$  matrices with entries in  $R$ . Also, if  $B$  is an  $R$ -module, let  $B^n$  denote the (abstract) direct sum of  $n$  copies of  $B$ . After writing elements of  $B^n$  as column "vectors" and using matrix "multiplication," we obtain the following; details are left to the reader.

**Lemma 4.35**  $\text{End}(B^n) \approx M_n(\text{End}(B))$ .

Note that  $\text{Hom}(\bigoplus_{i=1}^n B, \bigoplus_{j=1}^n B) \approx \bigoplus_{i=1}^n \bigoplus_{j=1}^n \text{Hom}(B, B)$ . One need only verify that matrix multiplication gives functional composition on the direct sum.

Suppose  $B$  and  $C$  are simple but not isomorphic. By Proposition 4.33,  $\text{Hom}(B, C) = 0$ . Hence,

$$\text{Hom}(B^n, C^m) = \text{Hom}\left(\bigoplus_{i=1}^n B, \bigoplus_{j=1}^m C\right) \approx \bigoplus_{i=1}^n \bigoplus_{j=1}^m \text{Hom}(B, C) = 0.$$

Repeating as often as necessary, we get:

**Lemma 4.36** *Suppose  $B_1, \dots, B_N$  are pairwise nonisomorphic simple  $R$ -modules. Then*

$$\text{End}(B_1^{n_1} \oplus \dots \oplus B_N^{n_N}) \approx M_{n_1}(\text{End}(B_1)) \oplus \dots \oplus M_{n_N}(\text{End}(B_N)),$$

*a finite sum of matrix rings over division rings.*

**Proof:**

$$\begin{aligned} \text{End}(B_1^{n_1} \oplus \dots \oplus B_N^{n_N}) &\approx \bigoplus_{i=1}^N \bigoplus_{j=1}^N \text{Hom}(B_i^{n_i}, B_j^{n_j}) \\ &\approx \bigoplus_{i=1}^N \text{Hom}(B_i^{n_i}, B_i^{n_i}) \\ &= \bigoplus_{i=1}^N \text{End}(B_i^{n_i}) \\ &\approx \bigoplus_{i=1}^N M_{n_i}(\text{End}(B_i)). \end{aligned} \quad \square$$



We're almost up to the fabled Artin–Wedderburn structure theorem, but we need three more lemmas.

**Lemma 4.37** *Suppose  $B$  is a finitely generated semisimple  $R$ -module. Then  $B$  is a finite direct sum of simple modules.*

**Proof:** If  $B = \Sigma B_i$  over some index set  $\mathcal{I}$ , and  $B$  is generated by  $x_1, \dots, x_n$ , then for each  $j$ , there exists a finite subset  $\mathcal{F}_j$  of  $\mathcal{I}$  such that  $x_j \in \Sigma_{\mathcal{F}_j} B_i$ . Set  $\mathcal{F} = \cup \mathcal{F}_j$ . Then each  $x_j \in \Sigma_{\mathcal{F}} B_i$ , so  $B = \Sigma_{\mathcal{F}} B_i$ . By Lemma 4.31,  $\mathcal{F}$  has a (necessarily finite) subset  $\mathcal{J}$  for which  $B = \oplus_{\mathcal{J}} B_i$ .  $\square$

Finally, we consider opposite rings. If  $R$  is a ring, then  $R^{\text{op}}$  will denote the opposite ring, and  ${}_R R$  will denote  $R$  as a left  $R$ -module. The next lemma is the noncommutative ring version of the familiar result from linear algebra that  $(AB)^T = B^T A^T$  for  $n \times n$  real matrices, where superscript  $T$  denotes transpose. Details are left to the reader.

**Lemma 4.38** *If  $R$  is any ring, then the opposite ring to  $M_n(R)$  is isomorphic to  $M_n(R^{\text{op}})$ , via  $A \mapsto A^T$ .*

Why opposite rings?

**Lemma 4.39**  $\text{End}({}_R R) \approx R^{\text{op}}$ .

**Proof:** Send  $R$  to  $\text{End}({}_R R)$  by sending  $r$  to  $\varphi_r$ , where  $\varphi_r(x) = xr$ . That pesky problem of writing  $r$  on the right guarantees that if we define  $\Phi(r) = \varphi_r$ , then  $\Phi(rs) = \Phi(s)\Phi(r)$ ; this is left to the reader. Finally, observe that  $\ker \Phi = 0$ , since  $\Phi(r) = 0 \Rightarrow \varphi_r = 0 \Rightarrow \varphi_r(1) = 0 \Rightarrow r = 1 \cdot r = 0$ , while  $\Phi$  is onto, since  $\psi \in \text{End}({}_R R)$  implies that  $\psi(x) = \psi(x \cdot 1) = x\psi(1) = \varphi_r(x)$ , where  $r = \psi(1)$ , so that  $\psi = \Phi(r)$ .  $\square$

We now have all the ingredients for the Artin–Wedderburn structure theorem, but in the immortal words of toy manufacturers everywhere, some assembly is required.

**Theorem 4.40 (Artin–Wedderburn Structure Theorem)** *Suppose  $R$  is a ring. The following are equivalent:*

- i)  $\text{LG-dim } R = 0$ .
- ii) Every left  $R$ -module is projective.
- iii) Every left  $R$ -module is injective.
- iv) Every left  $R$ -module is semisimple.



- v) Every short exact sequence of left  $R$ -modules splits.
- vi) Every left ideal is injective.
- vii) Every maximal left ideal is injective.
- viii) Every maximal left ideal is a direct summand of  $R$ .
- ix) For every left ideal  $I$ ,  $R/I$  is projective.
- x) Every simple left  $R$ -module is projective.
- xi)  $R$  is semisimple as a left  $R$ -module.
- xii)  $R$  is a finite direct sum of matrix rings over division rings.

**Proof:** It's hard to follow the logic without a scorecard. The implications are proved as follows:

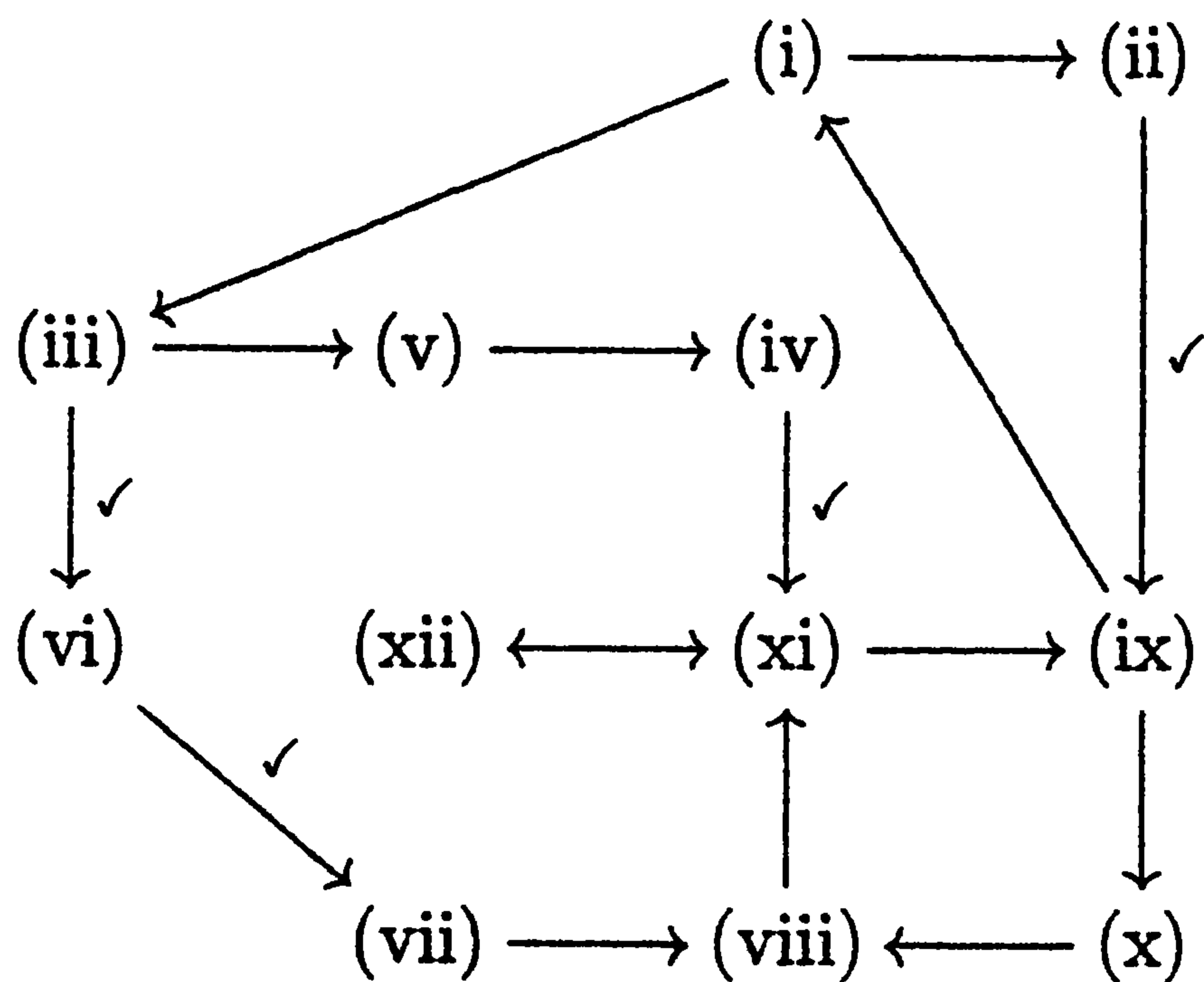

The implications marked with a check are trivial as statements. Most of the rest are quick. If  $B \in {}_R\mathbf{M}$ , then  $\text{P-dim } B = 0 \Leftrightarrow B$  is projective, so (i)  $\Rightarrow$  (ii) by definition of left global dimension. Similarly, (i)  $\Rightarrow$  (iii), using Proposition 4.1(a). (ix)  $\Rightarrow$  (i) by the global dimension theorem. (iii)  $\Rightarrow$  (v), since if  $0 \rightarrow A \rightarrow B \rightarrow C \rightarrow 0$  is short exact, then it must split when  $A$  is injective. (v)  $\Rightarrow$  (iv) since if  $A$  is a submodule of  $B$ , then the splitting of  $0 \rightarrow A \rightarrow B \rightarrow B/A \rightarrow 0$  will guarantee that  $A$  is a direct summand of  $B$ . (vii)  $\Rightarrow$  (viii) since injectives are absolute direct summands. (xi)  $\Rightarrow$  (ix), since if a left ideal  $I$  is a direct summand of  $R$ , then the other summand is  $R/I$ , which will then be projective, since  $R$  is projective. We now have all the implications except (ix)  $\Rightarrow$  (x)  $\Rightarrow$  (viii)  $\Rightarrow$  (xi)  $\Leftrightarrow$  (xii).

Suppose  $B$  is a simple left  $R$ -module, and  $0 \neq x \in B$ . Then  $B = Rx \approx R/\text{ann}(x)$ . Hence, (ix)  $\Rightarrow$  (x). But if  $I$  is a maximal left ideal, then  $R/I$  is simple, so (x)  $\Rightarrow$   $0 \rightarrow I \rightarrow R \rightarrow R/I \rightarrow 0$  splits when  $I$  is a maximal left ideal, and this implies (viii). We are now left with (viii)  $\Rightarrow$  (xi)  $\Leftrightarrow$  (xii).

(viii)  $\Rightarrow$  (xi): Suppose (viii). Let  $I$  be the (left ideal) sum of all simple submodules (that is, simple left ideals) in  $R$ . Suppose  $I \neq R$ . Let  $J$  be

a maximal left ideal with  $J \supset I$ . Then  $J$  is a direct summand of  $R$ , say  $R = J \oplus J'$ . But  $J' \approx R/J$  is simple, so  $J' \subset I$  by definition. But now  $J' \subset I \subset J$ , while  $J \oplus J'$  is a direct sum. Hence,  $J' = 0$ , contradicting the definition of “simple.”

(xi)  $\Rightarrow$  (xii): If  ${}_R R$  is semisimple, then it is a finite direct sum of simple left  $R$ -modules (that is, simple left ideals) by Lemma 4.37. Grouping isomorphic submodules together (possible since “isomorphic” is an equivalence relation) leads to the situation of Lemma 4.36, whence  $R^{\text{op}} \approx \text{End}({}_R R)$  (Lemma 4.39) is isomorphic to a finite direct sum of matrix rings over division rings, a fate befalling  $R$  itself by Lemma 4.38. (Note that the opposite ring of a division ring is also a division ring.)

Finally, (xii)  $\Rightarrow$  (xi): If  $R$  is a finite direct sum of matrix rings over division rings, then  $R$  is the (finite) sum of the column ideals over each matrix ring. In more detail, if  $D$  is a division ring, the  $k$ th column left ideal  $L_k$  of  $M_n(D)$  is the left ideal of  $n \times n$  matrices having zero everywhere except the  $k$ th column.  $M_n(D)$  is the sum of these, and each is isomorphic to  $D^n$  as an  $M_n(D)$ -module. Hence, each is simple since  $D^n$  is simple. ( $0 \neq x \in D^n \Rightarrow M_n(D) \cdot x = D^n$  by the usual linear algebra. This implies simplicity.)  $\square$

A few comments are in order before going on. The Artin–Wedderburn theorem actually comes in three varieties. The above is the middle-sized version. The small version asserts the equivalence of (iv), (v), (xi), and (xii); it is devoid of homological algebra. (The implication (xi)  $\Rightarrow$  (iv) is done without the global dimension theorem.) The large version tacks on a thirteenth condition, that  $R$  be nonzero, and that  $R$  have Jacobson radical zero and be left Artinian. (A ring is left Artinian if left ideals satisfy the descending chain condition. The Jacobson radical is discussed in Chapter 9.) That thirteenth condition is a major addition because in it  $R$  is *not* assumed to possess a unit element. The reader is referred to Herstein [32, pp. 48–50] or Hungerford [37, pp. 435–6] for a discussion of this.

Finally, note that condition (xii) is symmetric in left and right. Hence  $\text{LG-dim } R = 0$  iff  $\text{RG-dim } R = 0$ . We could have rewritten (i)–(xi), replacing “left” with “right,” and gotten a theorem asserting the equivalence of twenty-three statements. The interested reader is invited to expand on each statement, for example, expanding “... is semisimple” to three statements via Proposition 4.32, “... is injective” via Corollary 3.15, etc. The resulting truly monstrous structure theorem would assert the equivalence of over fifty statements!

Now for weak dimension zero. Theorem 4.40 is often called the Artin–Wedderburn *structure* theorem because it explicitly tells what kind of rings arise, via condition (xii). For weak dimension zero the result is not so definitive. We will at least be able to assert the equivalence of “W-dim  $R = 0$ ” with an internal condition that is devoid of tensor products in its statement. This condition is called *regularity*.

**Definition 4.41 (von Neumann)** *If  $R$  is a ring, then  $R$  is regular if, for all  $a \in R$ , there exists  $r \in R$  for which  $a = ara$ .*

Suppose  $a = ara$ . Then  $ra = rara = (ra)^2$ , that is,  $ra$  is an idempotent. Furthermore,  $Rra \subset Ra$  trivially, while  $a = ara \in Rra$ , so that  $Rra \supset Ra$ . Hence,  $Ra = Rra$ . In words, every principal left ideal is generated by an idempotent. The significance of this is contained in the next lemma, the first of four we need in discussing weak dimension zero.

**Lemma 4.42** *Suppose  $R$  is a ring, and  $I$  is a left ideal. Then  $I$  is a direct summand of  $R$  if and only if  $I$  is principal and generated by an idempotent.*

**Proof:** If  $I = Re$ , with  $e = e^2$ , set  $f = 1 - e$ . Then  $1 = e + (1 - e) \in I + Rf$ , while if  $r, s \in R$  and  $re = s(1 - e) \in I \cap Rf$ , then  $re = s - se \Rightarrow s = se + re \Rightarrow se = (se + re)e = se^2 + re^2 = se + re \Rightarrow re = 0$ . Hence,  $I \cap Rf = 0$  and  $I \oplus Rf = R$ .

If  $R = I \oplus J$  for some left ideal  $J$ , then  $1 = e + f$  for some  $e \in I$  and  $f \in J$ . Thus,  $Re \subset I$  and  $Rf \subset J$ ; also, if  $x \in R$ , then  $x = x \cdot 1 = x \cdot (e + f) = xe + xf$ . Hence, “ $x = xe + xf$ ” is the decomposition of  $x$  into a sum of elements of  $I$  and  $J$ . Taking  $x \in I$  gives  $x = xe$  (and  $0 = xf$ ); in particular,  $e = e^2$  and  $I \subset Ie$ . Hence,  $I \supset Re \supset Ie \supset I$ , so  $I = Re$  is principal and generated by an idempotent.  $\square$

**Lemma 4.43** *Suppose  $R$  is a ring, and suppose  $e$  and  $f$  are idempotents in  $R$  such that  $ef = 0 = fe$ . Then  $e + f$  is idempotent and  $Re + Rf = R(e + f)$ .*

**Proof:**  $(e + f)^2 = e^2 + ef + fe + f^2 = e^2 + f^2 = e + f$ . Further,  $e + f \in Re + Rf$ , so  $R(e + f) \subset Re + Rf$ . Finally,  $e = e(e + f) \in R(e + f)$  and  $f = f(e + f) \in R(e + f)$ , so that  $Re + Rf \subset R(e + f)$ .  $\square$

**Lemma 4.44** *Suppose  $R$  is a ring. Then  $Ra + Rb = Ra + Rb(1 - a)$ .*

**Proof:**  $b(1 - a) = b - ba = -ba + b \in Ra + Rb$ , so  $Rb(1 - a) \subset Ra + Rb$ .  $Ra \subset Ra + Rb$  trivially, so  $Ra + Rb(1 - a) \subset Ra + Rb$ . On the other hand,  $b = ba + b(1 - a) \in Ra + Rb(1 - a)$ , so  $Rb \subset Ra + Rb(1 - a)$ . Again  $Ra \subset Ra + Rb(1 - a)$ , so  $Ra + Rb \subset Ra + Rb(1 - a)$ .  $\square$

**Lemma 4.45** *Suppose  $R$  is regular. Then every finitely generated left ideal is principal (and generated by an idempotent).*

**Proof:** Suppose we knew the sum of two principal left ideals was principal. Then the set of principal left ideals would be closed under addition of ideals, and so would include every finitely generated ideal. It thus suffices to show



that  $Re + Rf$  is principal if  $e$  and  $f$  are idempotents. (Recall that if  $R$  is regular, then every principal left ideal is generated by an idempotent.) For this purpose, we successively modify  $e$  and  $f$  without changing the sum  $Re + Rf$  until we are in the situation of Lemma 4.43.

First of all,  $Re + Rf = Re + Rf(1 - e)$  by Lemma 4.44. Write  $f(1 - e) = f(1 - e)rf(1 - e)$ , and set  $f' = rf(1 - e)$ . Then  $Rf(1 - e) = Rf'$ , so  $Re + Rf = Re + Rf'$ . Also,  $f'e = rf(1 - e)e = rf(e - e^2) = 0$ . Next, do the same to  $e$ :  $Rf' + Re = Rf' + Re(1 - f')$ . Set  $e' = e(1 - f')$ . This  $e'$  is already idempotent:  $(e')^2 = e(1 - f')e(1 - f') = e(e - f'e)(1 - f') = e^2(1 - f') = e(1 - f') = e'$ . Furthermore,  $e'f' = e(1 - f')f' = e(f' - (f')^2) = 0$ , while  $f'e' = f'e(1 - f') = 0$ . Hence,  $Re + Rf = Re + Rf' = Re' + Rf' = R(e' + f')$ , the last equality by Lemma 4.43.  $\square$

**Theorem 4.46 (Weak Dimension Zero Characterization)** *Suppose  $R$  is a ring. The following conditions are equivalent:*

- i)  $\text{W-dim } R = 0$ .
- ii) *Every left  $R$ -module is flat.*
- iii) *For every finitely generated left ideal  $I$ ,  $R/I$  is projective.*
- iv)  $\text{Tor}_1(R/J, R/I) = 0$  for every finitely generated right ideal  $J$  and every finitely generated left ideal  $I$ .
- v)  $\text{Tor}_1(R/aR, R/Ra) = 0$  for every  $a \in R$ .
- vi)  $R$  is regular.

**Proof:** We prove that (i)  $\Rightarrow$  (ii)  $\Rightarrow$  (iv)  $\Rightarrow$  (v)  $\Rightarrow$  (vi)  $\Rightarrow$  (iii)  $\Rightarrow$  (i). (i)  $\Rightarrow$  (ii) by definition. (ii)  $\Rightarrow$  (iv) by Corollary 3.19. (iv)  $\Rightarrow$  (v) trivially. (v)  $\Rightarrow$  (vi) by Exercise 9(c) of Chapter 3, which states, “ $\text{Tor}_1(R/J, R/I) \approx (J \cap I)/JI$ ”: If  $aR \cap Ra = aR \cdot Ra$ , then  $a \in aR \cap Ra = aR \cdot Ra = aRa \Rightarrow a = ara$  for some  $r \in R$ . (vi)  $\Rightarrow$  (iii), since every finitely generated left ideal  $I$  is then principal and generated by an idempotent (Lemma 4.45), hence is a direct summand of  $R$  (Lemma 4.42). But  $R/I$  is the other summand of  $R$ , and so is projective (since  $R$  is projective). Finally, (iii)  $\Rightarrow$  (i) by the weak dimension theorem.  $\square$

One final remark. The occurrence of the word “projective” in (iii) is no accident.  $R/I$  is finitely presented (since  $I$  is finitely generated), so  $R/I$  is projective if and only if it is flat (Theorem 4.19).

## 4.4 An Example

There are examples to complement some of the results. In Exercise 7 there is a commutative example where: (i) weak and global dimensions differ;

(ii) there is a flat, finitely generated module which is not finitely presented (and not projective); and (iii) there is a projective ideal (consisting of zero divisors) which is not finitely generated. In the next chapter, there will be an example where right and left global dimensions are not the same. Here we shall discuss an example where weak and global dimensions differ in a systematic way. This example is not as well known as it should be; it is a *Bezout domain*, that is, an integral domain in which every finitely generated ideal is principal. It is *not* a PID. The global and weak dimensions *always* differ in this circumstance. Furthermore, the constructions computing the global dimension mimic (in a simpler setting) some constructions in the next chapter.

First, a few simple facts about Bezout domains. Suppose  $R$  is an integral domain, and  $a$  is a nonzero element of  $R$ . Then  $R$  is isomorphic to  $Ra$  as an  $R$ -module via  $x \mapsto xa$ . Thus, any principal ideal in an integral domain is projective, hence flat. It follows that any Bezout domain has weak dimension less than or equal to one by Corollary 4.14. However, in an integral domain,  $0 \neq a = ara$  implies  $ra = 1$ . That is, a regular integral domain is a field. Consequently, by Theorem 4.46, any Bezout domain which is not a field has weak dimension one.

If a Bezout domain is not a PID, then it must contain ideals which are not finitely generated, hence not projective by Proposition 4.23. By Corollary 4.11, the global dimension will be greater than or equal to two.

Suppose  $R$  is a Bezout domain, and suppose  $I$  is a nonprincipal ideal generated by a countable set  $\{r_1, r_2, \dots\}$ ,  $r_1 \neq 0$ . We shall show that  $\text{P-dim } I = 1$ . Let  $I_n$  be the ideal generated by  $\{r_1, \dots, r_n\}$ . Say  $I_n = Ra_n$ , so  $a_n | r_k$  if  $k \leq n$ , and  $I_n \subset I_{n+1}$ , so that  $a_{n+1} | a_n$ , say  $a_n = d_n a_{n+1}$ .  $\bigcup I_n = I$ . Note that all  $a_n$  are nonzero.

Let  $F$  be free on  $1, 2, \dots$ , and send  $(x_1, x_2, \dots) \in F = \bigoplus_{i=1}^{\infty} R$  to  $\sum x_j a_j$ . This maps  $F$  onto  $I$ . Set  $v_1 = (1, -d_1, 0, 0, \dots)$ ,  $v_2 = (0, 1, -d_2, 0, 0, \dots)$ , etc. Note that  $v_j \mapsto a_j - d_j a_{j+1} = 0$ , so all  $v_j$  are in the kernel  $K$  of  $F \rightarrow I$ . In fact, the  $v_j$  form a free basis of  $K$ , as we shall shortly see.

Suppose  $(x_1, x_2, \dots) \in K$ , so that  $\sum_{j=1}^n x_j a_j = 0$ . Then  $x_n a_n = -\sum_{j=1}^{n-1} x_j a_j \in I_{n-1} = Ra_{n-1}$ , so for some  $s_{n-1}$ ,  $x_n a_n = s_{n-1} a_{n-1} = s_{n-1} d_{n-1} a_n$ , and  $x_n = s_{n-1} d_{n-1}$ . Thus,  $(x_1, \dots, x_{n-1}, x_n, 0, \dots) + s_{n-1} v_{n-1} = (x_1, \dots, x_{n-1} + s_{n-1}, x_n - s_{n-1} d_{n-1}, 0, \dots) = (x_1, \dots, x_{n-1} + s_{n-1}, 0, 0, \dots)$  is an element of  $K$  that has fewer nonzero entries. By induction on  $n$ , there are  $s_1, \dots, s_{n-1}$  giving  $(x_1, \dots, x_n, 0, 0, \dots) = -\sum_{j=1}^{n-1} s_j v_j$ . That is,  $K$  is generated by  $\{v_1, v_2, \dots\}$ .

Finally, suppose  $\sum_{j=1}^n s_j v_j = 0$ , with  $s_j \in R$ . Then the entry in the  $n+1$



slot is  $-d_n s_n$ , so that  $s_n = 0$ . To see this, note that

$$\begin{aligned} s_1 v_1 &= (s_1, -d_1 s_1, 0, 0, 0, \dots), \\ s_2 v_2 &= (0, s_2, -d_2 s_2, 0, 0, \dots), \\ s_3 v_3 &= (0, 0, s_3, -d_3 s_3, 0, \dots), \\ &\vdots \end{aligned}$$

That is, the  $n+1$  slot in  $s_k v_k$  is 0 unless  $k = n$ , where it is  $-d_n s_n$ . It follows that  $s_n = 0$ , and the sum is actually  $\sum_{j=1}^{n-1} s_j v_j = 0$ . Hence, by induction on  $n$ , all  $s_j = 0$ . That is, the submodule  $K$  is free, with basis  $\{v_1, v_2, \dots\}$ . Thus,  $\text{P-dim } I = 1$ .

Now for the example. Let  $F$  be a field. The ring  $R$  consists of all “formal expressions”  $\sum_{j=1}^n a_j x^{q_j}$ , where  $a_j \in F$ , and  $q_j$  is a nonnegative rational number. (Literally,  $R = \bigoplus_{\mathcal{I}} F$ , where  $\mathcal{I} = \mathbb{Q} \cap [0, \infty)$ .) Add and multiply like polynomials:  $(\sum a_j x^{q_j})(\sum b_k x^{r_k}) = \sum \sum a_j b_k x^{q_j + r_k}$ , for example. Note that  $R = \bigcup F[x^{1/n!}]$ , and  $R$  is an integral domain.

In fact, if  $\alpha \neq 0$  and  $\beta \neq 0$ , pick  $n$  so that  $\alpha, \beta \in F[x^{1/n!}]$ ; then  $\alpha\beta \neq 0$  there. The idea behind this is general: Any finite subset of  $R$  lies in a subring that is a PID, and properties defined using finite sets of elements (e.g. “ $\alpha\beta = 0 \Rightarrow \alpha = 0$  or  $\beta = 0$ ,” which is defined using sets  $\{\alpha, \beta\}$  having two elements) that hold in PIDs also hold in  $R$ . (Also of some importance is that as the rings  $F[x^{1/n!}]$  get larger, the group of units stays the same.)

Suppose  $I$  is a finitely generated ideal in  $R$  generated by  $\alpha_1, \dots, \alpha_m$ . Choose  $n$  so large that all  $\alpha_j \in F[x^{1/n!}]$ . Then the ideal in  $F[x^{1/n!}]$  generated by  $\alpha_1, \dots, \alpha_m$  is principal, generated by  $d$ . Now  $d = \sum \lambda_j \alpha_j$ ,  $\lambda_j \in F[x^{1/n!}]$ , and from this equation we conclude that  $d \in I$ . However, we also have that  $\alpha_j \in F[x^{1/n!}]d \subset Rd$  for all  $j$ , so  $I \subset Rd$ . Thus  $I = Rd$ , a principal ideal. Since  $I$  was arbitrary,  $R$  is a Bezout domain. However,  $R$  is not a PID since it is not a UFD:  $x$  is divisible infinitely often. From earlier remarks,  $\text{W-dim } R = 1$  and  $\text{LG-dim } R \geq 2$ .

Let  $I$  be an ideal in  $R$ . Then  $I \cap F[x^{1/n!}]$  is an ideal in the PID  $F[x^{1/n!}]$ , so it is principal, generated by  $d_n$ . But now  $I$  is generated by  $\{d_1, d_2, \dots\}$ . Letting  $I$  vary, we have that all ideals are countably generated. So:  $\text{P-dim } I$  is zero if  $I$  is principal, and one if  $I$  is not. Also, some ideals do have projective dimension one. By Corollary 4.10, the global dimension of  $R$  is two.

We close with some nonhomological remarks about this ring. First of all, suppose  $P$  is a nonzero prime ideal in  $R$ , and suppose  $\alpha \notin P$ . Find  $n$  so that  $\alpha \in F[x^{1/n!}]$ , and so that  $P \cap F[x^{1/n!}] \neq 0$ . Then  $P \cap F[x^{1/n!}]$  is a nonzero prime ideal in the PID  $F[x^{1/n!}]$ , so it is maximal. Hence, there exists  $\beta \in F[x^{1/n!}]$  for which  $1 - \alpha\beta \in P \cap F[x^{1/n!}]$ , since  $F[x^{1/n!}]/(P \cap F[x^{1/n!}])$  is a

field. Since we now have that  $1 - \alpha\beta \in P$ , we conclude that  $\alpha$  is invertible in  $R/P$ . Since  $\alpha \notin P$  is arbitrary,  $R/P$  is a field, that is,  $P$  is maximal. So: Every nonzero prime ideal in  $R$  is maximal.

Furthermore, any Bezout domain is a *GCD domain*, an integral domain in which any two nonzero elements  $a$  and  $b$  have a GCD. (It is “the” generator of the ideal  $Ra + Rb$  when  $R$  is a Bezout domain.) However, if  $F$  is algebraically closed, then any irreducible  $\alpha \in F[x^{1/n!}]$  has the form  $\alpha = rx^{1/n!} + s$ , and it factors into  $n + 1$  terms in  $F[x^{1/(n+1)!}]$ . That is,  $R$  has *no primes at all*. On the other hand, if  $F$  is the quotient field of a UFD, then any polynomial in  $F[x]$  which is directly<sup>2</sup> proved irreducible using Eisenstein’s criterion (e.g.,  $X^N - p$ ,  $p$  a prime), remains irreducible in  $R$ , so  $R$  has some primes. (Note, however, that  $x$  is not divisible by any prime.) In Appendix A, there is a quick review of GCDs, UFDs, and PIDs. Since it may be helpful for Exercise 9, we record here one result:

*A UFD is a PID if  $Rp + Rq = R$  for any pair of distinct (that is, nonassociate) primes  $p$  and  $q$ .*

This is helpful since, among other things, a UFD need not be Noetherian. (Consider a polynomial ring over  $\mathbb{Q}$  in an infinite number of variables.)

Finally, one might think that in any “reasonable” Bezout domain, all nonprincipal ideals would, in fact, be countably generated. This depends on one’s definition of reasonable; the ring of entire functions is a Bezout domain containing ideals that are not countably generated. A discussion of the algebraic aspects of this ring appears in Appendix B.

---

<sup>2</sup>i.e. without a change of variables, like  $x \mapsto x + 1$ .

## Exercises

1. State and prove the analog for injective dimension of Corollary 4.3.
2. Suppose  $0 \rightarrow B \rightarrow B' \rightarrow B'' \rightarrow 0$  is short exact in  ${}_R\mathbf{M}$ , and suppose  $\text{P-dim } B > \text{P-dim } B'$  or  $\text{P-dim } B'' > 1 + \text{P-dim } B'$ . Show that  $\text{P-dim } B'' = 1 + \text{P-dim } B$ .
3. If  $f \in \text{Hom}(C, C')$ , prove commutativity of

$$\begin{array}{ccc} B^* \otimes C & \xrightarrow{B^* \otimes f} & B^* \otimes C' \\ \downarrow & & \downarrow \\ \text{Hom}(B, C) & \xrightarrow{\text{Hom}(B, f)} & \text{Hom}(B, C') \end{array}$$

4. Prove Schanuel's lemma: If  $0 \rightarrow K_i \rightarrow P_i \rightarrow B \rightarrow 0$  are short exact for  $i = 1, 2$ , with  $P_1$  and  $P_2$  projective, then  $K_1 \oplus P_2 \approx K_2 \oplus P_1$ .

Hint: Complete the diagram

$$\begin{array}{ccccccccc} 0 & \longrightarrow & K_1 & \xrightarrow{j_1} & P_1 & \longrightarrow & B & \longrightarrow & 0 \\ & & \downarrow \alpha & & \downarrow \beta & & \parallel & & \\ 0 & \longrightarrow & K_2 & \xrightarrow{j_2} & P_2 & \longrightarrow & B & \longrightarrow & 0 \end{array}$$

using projectivity of  $P_1$ . Map  $K_2 \oplus P_1$  to  $P_2$  via  $(k, p) \mapsto j_2(k) - \beta(p)$ , and show that this map is onto with kernel isomorphic to  $K_1$ . Now exploit projectivity of  $P_2$ .

5. Suppose  $B$  is finitely presented, and suppose  $P$  is projective and finitely generated, with  $0 \rightarrow K \rightarrow P \rightarrow B \rightarrow 0$  short exact. Show that  $K$  is finitely generated. (Exercise 4 will help here.)
6. A ring  $R$  is called a *Boolean ring* if  $x = x^2$  for all  $x \in R$ .
  - a) Show that any Boolean ring  $R$  is commutative, with  $x = -x$  for all  $x \in R$ . (This involves no homological algebra.)
  - b) Show that any Boolean ring is regular.
  - c) Show that any finite Boolean ring is isomorphic to a (finite) direct sum of copies of  $\mathbb{Z}_2$ .

7. Let  $R = \prod_{n=1}^{\infty} \mathbb{Z}_2$ , the *product* of infinitely many copies of  $\mathbb{Z}_2$ . Note that

$R$  is a Boolean ring, hence is regular by Exercise 6. Let  $I = \bigoplus_{n=1}^{\infty} \mathbb{Z}_2$ .

## 4. Dimension Theory

- a) Show that  $I$  is projective but not finitely generated.
- b) Show that  $R/I$  is flat and finitely generated, but neither finitely presented nor projective. Show as explicitly as possible where Theorem 4.19 breaks down (e.g.,  $F_0 = R$ ,  $I^* \approx R^*$ , etc.).
- c) Show that  $\text{LG-dim } R > \text{W-dim } R$ .
8. Suppose  $I$  is a projective ideal in a GCD domain, and suppose  $x, y \in I$ . Show that “the” GCD  $d$  of  $x$  and  $y$  belongs to  $I$ . Hence show that  $I$  is principal. Finally, deduce that a GCD domain is a Dedekind domain if and only if it is a PID.
9. The following is a theorem from commutative algebra:
- Suppose  $R$  is a UFD, and not a field. Then  $R$  is a PID if and only if the Krull dimension of  $R$  is equal to one.*
- (See Appendix A.) Prove the analogous result with the word “Krull” replaced with “weak”. (Hint: Suppose  $p$  and  $q$  are distinct primes for which  $I = Rp + Rq \neq R$ . Compute  $\text{Tor}(R/I, R/I)$ .)
10. Prove the modular law: If  $A, B$ , and  $C$  are submodules of  $D$ , with  $A \subset C$ , then  $A + (B \cap C) = (A + B) \cap C$ .
11. Suppose  $B_i \in {}_R\mathbf{M}$ . Show that  $\text{P-dim } (\bigoplus B_i) = \sup(\text{P-dim } B_i)$ .
12. Suppose  $R$  is an integral domain and suppose  $a$  and  $b$  are nonzero and are nonunits in  $R$ . Set  $\bar{R} = R/Rab$ , and if  $x \in R$ , set  $\bar{x} = x + Rab \in R/Rab = \bar{R}$ .
- a) Show that  $\bar{R}\bar{b} \approx \bar{R}/\bar{R}\bar{a}$  in  $\bar{R}\mathbf{M}$ .
- b) Show that the following are equivalent:
- i)  $\bar{R}/\bar{R}\bar{a}$  is  $\bar{R}$ -projective.
  - ii)  $Ra + Rb = R$ .
  - iii)  $Ra + Rb = R$  and  $Ra \cap Rb = Rab$ .
  - iv)  $\bar{R}\bar{a} \oplus \bar{R}\bar{b} = \bar{R}$ .
- c) Show that if  $Ra + Rb \neq R$ , then  $\bar{R}$  has infinite weak dimension. (In particular, taking  $b = a$ ,  $R/Ra^2$  has infinite weak dimension.)
- d) Compute  $\text{Tor}_n^{\bar{R}}(\bar{R}/\bar{R}\bar{a}, \bar{R}/\bar{R}\bar{a})$  for the case  $R = \mathbb{Z}[x]$ ,  $a = x$ ,  $b = 2$ .
13. Suppose  $P$  is projective and finitely generated in  ${}_R\mathbf{M}$ , and suppose  $C \in {}_R\mathbf{M}$ . Show that  $P^* \otimes C \rightarrow \text{Hom}(P, C)$  is an isomorphism.
14. Suppose  $\text{P-dim } B = N \geq n$ . Show that the  $n$ th kernel of any projective resolution of  $B$  has projective dimension  $N - n$ .



15. Analytically similar objects can be algebraically quite different.
- Let  $R = C^\infty(\mathbb{R})$ , the ring of  $C^\infty$  functions from  $\mathbb{R}$  to  $\mathbb{R}$ . Let  $M$  be the (maximal) ideal  $\{f \in R : f(0) = 0\}$ . Show that  $\text{P-dim } {}_R R/M = 1$ .
  - Let  $R = C(\mathbb{R})$ , the ring of continuous functions from  $\mathbb{R}$  to  $\mathbb{R}$ . Let  $M$  be the (maximal) ideal  $\{f \in R : f(0) = 0\}$ . Show that  $\text{P-dim } {}_R R/M > 1$ .
16. (See 15(a), as well as Exercise 8, Chapter 2.) Let  $R$  be the ring of  $C^\infty$  functions on  $\mathbb{R}$  that are periodic with period  $2\pi$ .
- Show that all maximal ideals have the form  $M_a = \{f \in R : f(a) = 0\}$  for some  $a \in \mathbb{R}$ . Show that these ideals are projective (generated by  $\sin(x-a)$  and any  $\phi \in M_a$  for which  $\phi(a+\pi) \neq 0$ ). Hence, show  $\text{P-dim } B = 1$  for all simple modules  $B$ .
  - Let  $I$  be the ideal of all  $f \in R$  such that there exists an  $N$  for which  $f(1/n) = 0$  when  $n \geq N$ ,  $n$  a positive integer. (For the usual reasons,  $e^{-1/x} \sin(\pi/x)$ ,  $0 < x < \epsilon$ , extends to a nonzero divisor in  $I$ .) Show that  $I$  is not projective, so that  $\text{LG-dim } R \geq 2 > \sup\{\text{P-dim } B : B \text{ simple}\}$ . (See (i)  $\Leftrightarrow$  (x) in Theorem 4.40.)
17. Suppose  $X$  is a nonempty locally compact Hausdorff space, so that, for example,  $X$  is completely regular.  $C_c(X)$  is an ideal in  $C(X)$ , where  $C_c(X)$  is the set of compactly supported continuous functions.
- Suppose  $\Phi : C_c(X) \rightarrow C(X)$  is a  $C(X)$ -module homomorphism. Show that  $\exists \varphi \in C(X)$  such that  $\forall f \in C_c(X) : \Phi(f) = \varphi f$ .
  - Suppose  $\mathbb{F} \subset C_c(X)$ . Show that  $\mathbb{F}$  generates  $C_c(X)$  as an ideal iff  $\bigcap_{f \in \mathbb{F}} f^{-1}(0) = \emptyset$ .
  - (Bkouche) Show that  $C_c(X)$  is projective as a  $C(X)$ -module iff  $X$  is paracompact.

Hints:

- If  $f \in C_c(X)$ , then  $\varphi(x) = \Phi(f)(x)/f(x)$  whenever  $f(x) \neq 0$ . Show that these quotients patch together to give a well-defined  $\varphi \in C(X)$ .
- If  $g \in C_c(X)$ , and  $f_1, \dots, f_n \in \mathbb{F}$  are such that  $f_1^2 + \dots + f_n^2 \geq \delta > 0$  on  $\text{supp}(g)$ , then

$$g = \sum_{i=1}^n \frac{f_i g}{\max(\delta, f_1^2 + \dots + f_n^2)} f_i.$$

- There is a relation between projective bases and things that look enough like partitions of unity to give locally finite refinements.





# 5

## Change of Rings

### 5.1 Computational Considerations

In the discussions of the preceding chapters, the ring has stayed fixed. It has been arbitrary, but unvarying. That is about to change; we shall now be concerned with what happens when certain modifications are made to a ring. The three structural operations addressed later are the formation of matrix rings, polynomial rings, and localizations. There are some generalities to the theory, however, and they not only form a backdrop for change of rings, they also ease computations for specific rings.

The most general setting for change of rings involves two rings  $R$  and  $S$ , together with a covariant functor  $F : {}_S\mathbf{M} \rightarrow {}_R\mathbf{M}$  having the following two properties:

- i)  $F$  is exact, and
- ii)  $F(\bigoplus_I B_i) \approx \bigoplus_I F(B_i)$  for any indexed family in  ${}_S\mathbf{M}$ .

Condition (ii) will be referred to as “strong additivity,” so such a functor will be called an exact, strongly additive covariant functor. About half the time, such functors arise as follows:  $\phi : R \rightarrow \hat{R}$  is a ring homomorphism and any  $\hat{B} \in {}_{\hat{R}}\mathbf{M}$  is viewed as an  $R$ -module via  $r \cdot \hat{b} = \phi(r)\hat{b}$ . Set  $F(\hat{B}) = \hat{B}$  viewed as an  $R$ -module. By the way, the notation in this case is intended to be suggestive: Anything wearing a hat comes from  $\hat{R}$ . Furthermore, we shall often put subscripts on “P-dim” or “F-dim” to identify the relevant ring.

It can be argued that there is no such thing as a fundamental theorem of

change of rings, let alone a first or second fundamental theorem. Nevertheless, if any result deserves to be called the fundamental theorem of change of rings, it is part (a) of this:

**Theorem 5.1** *Suppose  $F : {}_S\mathbf{M} \rightarrow {}_R\mathbf{M}$  is an exact, strongly additive covariant functor. Then for all  $B \in {}_S\mathbf{M}$ :*

- a)  $\text{P-dim}_R F(B) \leq \text{P-dim}_S B + \text{P-dim}_R F(S)$ , and
- b)  $\text{F-dim}_R F(B) \leq \text{P-dim}_S B + \text{F-dim}_R F(S)$ .

**Proof:** First case:  $B$  is free. Then  $B = \bigoplus_{\mathcal{I}} S$  for some index set  $\mathcal{I}$ , and  $F(B) = \bigoplus_{\mathcal{I}} F(S)$  since  $F$  is strongly additive. But  $\text{P-dim}_R \bigoplus_{\mathcal{I}} F(S)$  is  $\text{P-dim}_R F(S)$  (Chapter 4, Exercise 11), or zero if  $\mathcal{I}$  is empty. Flat dimension also works this way.

Second case:  $B$  is projective. Then  $B \oplus C$  is free for some  $C$ , and  $\text{P-dim}_R F(B) \leq \text{P-dim}_R F(B) \oplus F(C) = \text{P-dim}_R F(B \oplus C) \leq \text{P-dim}_R F(S)$  by the first case. Flat dimension also works this way.

Finally, arbitrary  $B$ . If  $\text{P-dim}_S B = \infty$ , there is nothing to prove, so suppose  $n = \text{P-dim}_S B < \infty$ . Let  $0 \rightarrow P_n \rightarrow P_{n-1} \rightarrow \cdots \rightarrow P_0 \rightarrow B \rightarrow 0$  be a projective resolution of  $B$ , possible by the projective dimension theorem. Then  $0 \rightarrow F(P_n) \rightarrow F(P_{n-1}) \rightarrow \cdots \rightarrow F(P_0) \rightarrow F(B) \rightarrow 0$  is exact since  $F$  is exact, so  $\text{P-dim}_R F(B) \leq n + d$ , where  $d = \text{P-dim}_R F(R)$  by Corollary 4.3 (and the second case). Flat dimensions follow in a similar way.  $\square$

Clearly, (b) is less satisfactory than (a). The problem is that, in (b), the second case is still “ $B$  is projective,” not “ $B$  is flat”. Furthermore, no real analog of the first case would work for injective dimension. This explains why global dimension (rather than weak dimension) is analyzed for ring changes, as well as why global dimension is computed from projective dimension (rather than injective dimension). Nevertheless, the deficiencies of part (b) can be fixed using methods from Chapter 8: Proposition 8.19 asserts that  $\text{F-dim}_R F(B) \leq \text{F-dim}_S B + \text{F-dim}_R F(S)$ .

To proceed further, we need to generalize the corollary to the global dimension theorem. If  $B \in {}_R\mathbf{M}$ , and if  $B'$  is a submodule of  $B$ , define the “Supremal projective dimension” of  $(B', B)$  as follows. (Note: This is not a standard concept.)

$$\text{SP-dim}(B', B) = \sup\{\text{P-dim } C : C \text{ is a submodule of } B, \text{ and } C \supset B'\}$$

Also set  $\text{SP-dim } B = \text{SP-dim}(0, B)$ . Note that if  $\text{LG-dim } R > 0$ , then  $\text{LG-dim } R = 1 + \text{SP-dim } R$  by Corollary 4.10.

**Proposition 5.2** *Suppose  $B \in {}_R\mathbf{M}$ ,  $B'$  is a submodule of  $B$ , and  $B''$  is a submodule of  $B'$ . Then*

$$\text{SP-dim}(B'', B) = \max\{\text{SP-dim}(B'', B'), \text{SP-dim}(B', B)\}.$$

**Proof:** Since  $B'' \subset C \subset B'$  or  $B' \subset C \subset B \Rightarrow B'' \subset C \subset B$ ,  $\text{SP-dim}(B'', B) \geq \max\{\text{SP-dim}(B'', B'), \text{SP-dim}(B', B)\}$ . Suppose this inequality is strict. Then  $\exists C$  with  $\text{P-dim } C > \max\{\text{SP-dim}(B'', B'), \text{SP-dim}(B', B)\}$  and  $B'' \subset C \subset B$ . Since  $B'' \subset C \cap B' \subset B'$  and  $B' \subset C + B' \subset B$ , it follows that  $\text{P-dim } C > \max\{\text{P-dim}(C \cap B'), \text{P-dim}(C + B')\}$ . This cannot happen, though: Choose  $n$  finite,  $\text{P-dim } C \geq n > \max\{\text{P-dim}(C \cap B'), \text{P-dim}(C + B')\}$ ; and choose  $D$  so that  $\text{Ext}^n(C, D) \neq 0$ . By the algebraic Mayer–Vietoris sequence (Chapter 3, Exercise 12), we have an exact sequence  $0 = \text{Ext}^n(C \cap B', D) \leftarrow \text{Ext}^n(C, D) \oplus \text{Ext}^n(B', D) \leftarrow \text{Ext}^n(C + B', D) = 0$ , a contradiction.  $\square$

**Corollary 5.3** *If  $\text{LG-dim } R > 0$ , and  $0 = I_0 \subset I_1 \subset \cdots \subset I_n = R$  is a chain of left ideals in  $R$ , then  $\text{LG-dim } R = 1 + \max\{\text{SP-dim}(I_{j-1}, I_j) : j = 1, \dots, n\}$ .*

**Proof:** See comments preceding Proposition 5.2.  $\square$

**Proposition 5.4** *Suppose  $B, C \in {}_R\mathbf{M}$ . Then*

$$\text{SP-dim}(B \oplus C) = \max\{\text{SP-dim } B, \text{SP-dim } C\}.$$

**Proof:**  $\text{SP-dim}(B \oplus C) = \max\{\text{SP-dim}(B \oplus 0), \text{SP-dim}(B \oplus 0, B \oplus C)\}$  by Proposition 5.2. But any module between  $B \oplus 0$  and  $B \oplus C$  corresponds to a submodule of  $C \approx B \oplus C / B \oplus 0$  by the fundamental isomorphism theorems, so any module between  $B \oplus 0$  and  $B \oplus C$  has the form  $B \oplus C'$  for a submodule  $C'$  of  $C$ . Also  $\text{P-dim}(B \oplus C') = \max\{\text{P-dim } B, \text{P-dim } C'\}$  by Exercise 11, Chapter 4. Taking suprema over  $C'$ ,  $\text{SP-dim}(B \oplus 0, B \oplus C) = \max\{\text{P-dim } B, \text{SP-dim } C\}$ , so that

$$\text{SP-dim}(B \oplus C) = \max\{\text{SP-dim } B, \text{SP-dim } C\}$$

(since  $\text{SP-dim } B \geq \text{P-dim } B$  by definition).  $\square$

**Corollary 5.5** *If  $\text{LG-dim } R > 0$ , and if  $R = I_1 \oplus \cdots \oplus I_n$  is a direct sum of left ideals, then  $\text{LG-dim } R = 1 + \max\{\text{SP-dim } I_j : j = 1, \dots, n\}$ .*

**Proof:** Again, see the comments preceding Proposition 5.2.  $\square$

The preceding propositions and corollaries facilitate computations by reducing the number of left ideals that need to be considered. We need one more result:

**Proposition 5.6** *Suppose  $\phi : R \rightarrow \hat{R}$  is a surjective ring homomorphism, and suppose  $\hat{R}$  is  $R$ -projective. Then  $\text{P-dim}_R \hat{B} = \text{P-dim}_{\hat{R}} \hat{B}$  for all  $\hat{B} \in \hat{R}\mathbf{M}$ .*

**Proof:**  $\text{P-dim}_R \widehat{B} \leq \text{P-dim}_{\widehat{R}} \widehat{B}$  by Theorem 5.1. Hence, all  $\widehat{R}$ -projective modules are  $R$ -projective. Suppose  $\widehat{B}$  is  $R$ -projective. There is an  $\widehat{R}$ -projective module  $\widehat{P}$  and a surjection  $\widehat{\pi} : \widehat{P} \rightarrow \widehat{B}$ . There is a splitting over  $R$ , that is, an  $\eta : \widehat{B} \rightarrow \widehat{P}$  such that  $\widehat{\pi}\eta = i_{\widehat{B}}$ , since  $\widehat{B}$  is  $R$ -projective. But  $\phi$  surjective  $\Rightarrow \eta \in \text{Hom}_{\widehat{R}}(\widehat{B}, \widehat{P})$ :  $\eta(\phi(r)\widehat{b}) = \eta(r \cdot \widehat{b}) = r \cdot \eta(\widehat{b}) = \phi(r)\eta(\widehat{b})$  for all  $r \in R$  and  $\widehat{b} \in \widehat{B}$ , ( $\eta$  is an  $R$ -module homomorphism), so  $\eta(\widehat{r}\widehat{b}) = \widehat{r}\eta(\widehat{b})$ , since  $\phi$  is onto. Thus,  $\widehat{B}$  is (isomorphic to) a direct summand of  $\widehat{P}$ , and so is  $\widehat{R}$ -projective. That is,  $\widehat{B}$  is  $R$ -projective  $\Leftrightarrow \widehat{B}$  is  $\widehat{R}$ -projective.

In general,  $\text{P-dim}_R \widehat{B} \leq \text{P-dim}_{\widehat{R}} \widehat{B}$  by Theorem 5.1. If  $n = \text{P-dim}_R \widehat{B} < \text{P-dim}_{\widehat{R}} \widehat{B}$ , then the  $n$ th kernel of an  $\widehat{R}$ -projective resolution of  $\widehat{B}$  will be  $R$ -projective, hence  $\widehat{R}$ -projective, a contradiction.  $\square$

We close this section with an example, due to Small [71], where  $\text{W-dim } R = \text{RG-dim } R = 1$ , and  $\text{LG-dim } R = 2$ .  $R$  consists of all  $2 \times 2$  matrices  $\begin{pmatrix} a & b \\ 0 & c \end{pmatrix}$  for which  $a \in \mathbb{Z}$  and  $b, c \in \mathbb{Q}$ . Note that  $\begin{pmatrix} 2 & 0 \\ 0 & 0 \end{pmatrix} \neq \begin{pmatrix} 2 & 0 \\ 0 & 0 \end{pmatrix} r \begin{pmatrix} 2 & 0 \\ 0 & 0 \end{pmatrix}$  for any  $r \in R$  (direct calculation), so  $R$  is not regular, and  $\text{W-dim } R \geq 1$  by Theorem 4.46.

Right ideals first.  $\begin{pmatrix} 1 & 0 \\ 0 & 0 \end{pmatrix} R \oplus \begin{pmatrix} 0 & 0 \\ 0 & 1 \end{pmatrix} R = R$ , so  $\begin{pmatrix} 1 & 0 \\ 0 & 0 \end{pmatrix} R$  and  $\begin{pmatrix} 0 & 0 \\ 0 & 1 \end{pmatrix} R$  are projective, and

$$\begin{aligned} \text{RG-dim } R &= 1 + \text{SP-dim } R \\ &= 1 + \max \left\{ \text{SP-dim } \begin{pmatrix} 1 & 0 \\ 0 & 0 \end{pmatrix} R, \text{SP-dim } \begin{pmatrix} 0 & 0 \\ 0 & 1 \end{pmatrix} R \right\} \end{aligned}$$

by Corollary 5.3.

Suppose  $I$  is a right ideal,  $I \subset \begin{pmatrix} 1 & 0 \\ 0 & 0 \end{pmatrix} R = \left\{ \begin{pmatrix} a & b \\ 0 & 0 \end{pmatrix} : a \in \mathbb{Z}, b \in \mathbb{Q} \right\}$ . Set  $\tilde{I} = \left\{ n \in \mathbb{Z} : \begin{pmatrix} n & 0 \\ 0 & 0 \end{pmatrix} \in I \right\}$ . If  $\begin{pmatrix} a & b \\ 0 & 0 \end{pmatrix} \in I$ , then  $\begin{pmatrix} a & 0 \\ 0 & 0 \end{pmatrix} = \begin{pmatrix} a & b \\ 0 & 0 \end{pmatrix} \begin{pmatrix} 1 & 0 \\ 0 & 0 \end{pmatrix} \in I$ , so  $a \in \tilde{I}$ .  $\tilde{I}$  is an additive subgroup of  $\mathbb{Z}$ , so it is an ideal in  $\mathbb{Z}$ ; consequently,  $\tilde{I} = \mathbb{Z}n$  for some  $n$ , and  $\begin{pmatrix} n & 0 \\ 0 & 0 \end{pmatrix} R \subset I$ . If  $n \neq 0$ , then all elements of  $I$  have the form  $\begin{pmatrix} kn & b \\ 0 & 0 \end{pmatrix} = \begin{pmatrix} n & 0 \\ 0 & 0 \end{pmatrix} \begin{pmatrix} k & bn^{-1} \\ 0 & 0 \end{pmatrix} \in \begin{pmatrix} n & 0 \\ 0 & 0 \end{pmatrix} R$ , so  $I = \begin{pmatrix} n & 0 \\ 0 & 0 \end{pmatrix} R$ . But  $r \mapsto \begin{pmatrix} n & 0 \\ 0 & 0 \end{pmatrix} r$  is an isomorphism (as right  $R$ -modules) of  $\begin{pmatrix} 1 & 0 \\ 0 & 0 \end{pmatrix} R$  with  $I$ , and  $\begin{pmatrix} 1 & 0 \\ 0 & 0 \end{pmatrix} R$  is projective, so  $I$  is projective. If  $\tilde{I} = 0$ , then  $I$  consists of matrices of the form  $\begin{pmatrix} 0 & q \\ 0 & 0 \end{pmatrix}$ . Now  $\begin{pmatrix} 0 & q \\ 0 & 0 \end{pmatrix} \begin{pmatrix} 0 & 0 \\ 0 & q^{-1} \end{pmatrix} = \begin{pmatrix} 0 & 1 \\ 0 & 0 \end{pmatrix} \in I$  if  $q \neq 0$ , and  $\begin{pmatrix} 0 & 1 \\ 0 & 0 \end{pmatrix} \begin{pmatrix} a & b \\ 0 & c \end{pmatrix} = \begin{pmatrix} 0 & c \\ 0 & 0 \end{pmatrix}$ , so  $I \neq 0$  implies that  $I = \begin{pmatrix} 0 & 1 \\ 0 & 0 \end{pmatrix} R$ . But



$\begin{pmatrix} 0 & 0 \\ 0 & 1 \end{pmatrix} R$  is isomorphic to  $\begin{pmatrix} 0 & 1 \\ 0 & 0 \end{pmatrix} R$  as a right  $R$ -module, via  $r \mapsto \begin{pmatrix} 0 & 1 \\ 0 & 0 \end{pmatrix} r$ , so  $\begin{pmatrix} 0 & 1 \\ 0 & 0 \end{pmatrix} R$  is projective. Hence  $\text{SP-dim } \begin{pmatrix} 1 & 0 \\ 0 & 0 \end{pmatrix} R = 0$ .

Suppose  $I$  is a right ideal, and  $I \subset \begin{pmatrix} 0 & 0 \\ 0 & 1 \end{pmatrix} R = \left\{ \begin{pmatrix} 0 & 0 \\ 0 & c \end{pmatrix} : c \in \mathbb{Q} \right\}$ . If  $\begin{pmatrix} 0 & 0 \\ 0 & q \end{pmatrix} \in I$ ,  $q \neq 0$ , then  $\begin{pmatrix} 0 & 0 \\ 0 & 1 \end{pmatrix} = \begin{pmatrix} 0 & 0 \\ 0 & q \end{pmatrix} \begin{pmatrix} 0 & 0 \\ 0 & q^{-1} \end{pmatrix} \in I$ . Hence  $I \neq 0 \Rightarrow I = \begin{pmatrix} 0 & 0 \\ 0 & 1 \end{pmatrix} R$  (i.e.,  $\begin{pmatrix} 0 & 0 \\ 0 & 1 \end{pmatrix} R$  is simple). Thus the two right ideals inside  $\begin{pmatrix} 0 & 0 \\ 0 & 1 \end{pmatrix} R$  are 0 and  $\begin{pmatrix} 0 & 0 \\ 0 & 1 \end{pmatrix} R$ , and both are projective. Hence  $\text{SP-dim } \begin{pmatrix} 0 & 0 \\ 0 & 1 \end{pmatrix} R = 0$ .

Combining all of the above,  $1 \geq \text{RG-dim } R \geq \text{W-dim } R \geq 1$ , so  $\text{RG-dim } R = \text{W-dim } R = 1$ . The equality of  $\text{RG-dim } R$  with  $\text{W-dim } R$  is no accident:  $R$  is right Noetherian. To see this, note that all right ideals inside  $\begin{pmatrix} 1 & 0 \\ 0 & 0 \end{pmatrix} R$  or  $\begin{pmatrix} 0 & 0 \\ 0 & 1 \end{pmatrix} R$  are principal, hence finitely generated, so  $\begin{pmatrix} 1 & 0 \\ 0 & 0 \end{pmatrix} R$  and  $\begin{pmatrix} 0 & 0 \\ 0 & 1 \end{pmatrix} R$  are Noetherian as right  $R$ -modules (ascending chain condition; in general, if  $R$  is *any* ring, a module is Noetherian if and only if every submodule is finitely generated; see Dummit and Foote [17, p. 438]). Since sums of Noetherian modules are Noetherian,  $R = \begin{pmatrix} 1 & 0 \\ 0 & 0 \end{pmatrix} R + \begin{pmatrix} 0 & 0 \\ 0 & 1 \end{pmatrix} R$  is Noetherian as a right  $R$ -module, that is,  $R$  is right Noetherian. ( $R$  is not a right principal ideal ring, though;  $\left\{ \begin{pmatrix} 0 & b \\ 0 & c \end{pmatrix} : b, c \in \mathbb{Q} \right\}$  is not principal.)

Now left ideals. Note that  $R = R \begin{pmatrix} 1 & 0 \\ 0 & 0 \end{pmatrix} \oplus R \begin{pmatrix} 0 & 0 \\ 0 & 1 \end{pmatrix}$ .  $\text{LG-dim } R \geq \text{W-dim } R = 1$ , so Corollary 4.3 applies again.

First, suppose  $I \subset R \begin{pmatrix} 1 & 0 \\ 0 & 0 \end{pmatrix} = \left\{ \begin{pmatrix} a & 0 \\ 0 & 0 \end{pmatrix} : a \in \mathbb{Z} \right\}$ . If  $\tilde{I} = \mathbb{Z}n$ ,  $\tilde{I}$  as above, then  $I = R \begin{pmatrix} n & 0 \\ 0 & 0 \end{pmatrix}$ . If  $n \neq 0$ , then  $R \begin{pmatrix} 1 & 0 \\ 0 & 0 \end{pmatrix} \approx R \begin{pmatrix} n & 0 \\ 0 & 0 \end{pmatrix}$  via  $r \mapsto r \begin{pmatrix} n & 0 \\ 0 & 0 \end{pmatrix}$ , so  $I$  is projective. Since 0 is projective,  $\text{SP-dim } R \begin{pmatrix} 1 & 0 \\ 0 & 0 \end{pmatrix} = 0$ .

Next,  $R \begin{pmatrix} 0 & 0 \\ 0 & 1 \end{pmatrix} = \left\{ \begin{pmatrix} 0 & b \\ 0 & c \end{pmatrix} : b, c \in \mathbb{Q} \right\} \supset J = \left\{ \begin{pmatrix} 0 & q \\ 0 & 0 \end{pmatrix} : q \in \mathbb{Q} \right\}$ . Now  $J$  is a left ideal, since  $\begin{pmatrix} a & b \\ 0 & c \end{pmatrix} \begin{pmatrix} 0 & q \\ 0 & 0 \end{pmatrix} = \begin{pmatrix} 0 & aq \\ 0 & 0 \end{pmatrix}$ . Furthermore, if  $\begin{pmatrix} 0 & s \\ 0 & t \end{pmatrix} \in R \begin{pmatrix} 0 & 0 \\ 0 & 1 \end{pmatrix} - J$  (i.e.,  $t \neq 0$ ), then  $\begin{pmatrix} 0 & bt^{-1} \\ 0 & ct^{-1} \end{pmatrix} \begin{pmatrix} 0 & s \\ 0 & t \end{pmatrix} = \begin{pmatrix} 0 & b \\ 0 & c \end{pmatrix}$  for *any*  $b, c \in \mathbb{Q}$ . That is,  $J$  is maximal in  $R \begin{pmatrix} 0 & 0 \\ 0 & 1 \end{pmatrix}$ , so the only left ideals between  $J$  and

$R \begin{pmatrix} 0 & 0 \\ 0 & 1 \end{pmatrix}$  are  $R \begin{pmatrix} 0 & 0 \\ 0 & 1 \end{pmatrix}$  (which is projective) and  $J$  itself (which is between  $J$  and 0); thus,  $\text{SP-dim } R \begin{pmatrix} 0 & 0 \\ 0 & 1 \end{pmatrix} = \max \left\{ \text{SP-dim } J, \text{SP-dim} \left( J, R \begin{pmatrix} 0 & 0 \\ 0 & 1 \end{pmatrix} \right) \right\} = \text{SP-dim } J$ . We now have that  $\text{LG-dim } R = 1 + \text{SP-dim } J$ .

Now define  $\hat{R} = \mathbb{Z}$ , and  $\phi : R \rightarrow \hat{R}$  via  $\phi \left( \begin{pmatrix} a & b \\ 0 & c \end{pmatrix} \right) = a$ .  $\phi$  is a ring homomorphism onto, and as an  $R$ -module,  $\hat{R} \approx R \begin{pmatrix} 1 & 0 \\ 0 & 0 \end{pmatrix}$ , which is projective. But  $\begin{pmatrix} a & b \\ 0 & c \end{pmatrix} \begin{pmatrix} 0 & q \\ 0 & 0 \end{pmatrix} = \begin{pmatrix} 0 & aq \\ 0 & 0 \end{pmatrix}$  implies that any left ideal inside  $J$  comes from a  $\hat{B} \in {}_{\hat{R}}\mathbf{M}$ , where  $\hat{B}$  is a  $\mathbb{Z}$ -submodule of  $\mathbb{Q}$ . By Proposition 5.6,  $\text{P-dim}_R \hat{B} = \text{P-dim}_{\hat{R}} \hat{B} \leq 1$ , and the value of one is achieved by  $\mathbb{Q}$  itself (which is not  $\mathbb{Z}$ -projective). Hence,  $\text{SP-dim } J = 1$ , and  $\text{LG-dim } R = 2$ .

In reviewing the above, note how many ideals did *not* have to be examined. That's the beauty of Propositions 5.2 and 5.3 (and their corollaries). We shall see this again in the next section.

## 5.2 Matrix Rings

Nearly all the work required to prove the main result of this section has been done. Here is the situation:  $R$  is a ring; form the ring  $M_n(R)$  of  $n \times n$  matrices with entries from  $R$ . One might expect global dimensions to go up, but they don't:  $\text{LG-dim } M_n(R) = \text{LG-dim } R$ .

The case  $\text{LG-dim } R = 0$  requires some discussion, since Corollary 5.5 will be used. First of all, easy calculations show that  $M_n(R \oplus S) \approx M_n(R) \oplus M_n(S)$  and  $M_n(M_k(R)) \approx M_{nk}(R)$  (block matrices). Thus, if  $R$  is a finite sum of matrix rings, then so is  $M_n(R)$ ; the matrices are just bigger. Consequently,  $\text{LG-dim } R = 0 \Rightarrow \text{LG-dim } M_n(R) = 0$  (Artin-Wedderburn). This lends some plausibility to the following result.

**Theorem 5.7** *For any ring  $R$ , and any positive integer  $n$ ,  $\text{LG-dim } R = \text{LG-dim } M_n(R)$ .*

**Proof:** Set  $\hat{R} = M_n(R)$ . Define  $\phi : R \rightarrow \hat{R}$  via  $\phi(r) = r \cdot I_n$ ,  $I_n = n \times n$  identity matrix.  $\hat{R} \approx R^{n^2}$  as an  $R$ -module, so  $\text{P-dim}_R \hat{R} = 0$ . Thus, for any  $\hat{B} \in {}_{\hat{R}}\mathbf{M}$ ,  $\text{P-dim}_R \hat{B} \leq \text{P-dim}_{\hat{R}} \hat{B}$  by Theorem 5.1(a).

Define  $\hat{F} : {}_R\mathbf{M} \rightarrow {}_{\hat{R}}\mathbf{M}$  by  $\hat{F}(B) = B^n$ , where elements of  $B^n$  are written as column vectors.  $\hat{F}(B)$  is in  ${}_{\hat{R}}\mathbf{M}$  via the expected version of

matrix multiplication:

$$\begin{pmatrix} r_{11} & \cdots & r_{1n} \\ \vdots & & \vdots \\ r_{n1} & \cdots & r_{nn} \end{pmatrix} \begin{pmatrix} b_1 \\ \vdots \\ b_n \end{pmatrix} = \begin{pmatrix} r_{11}b_1 + \cdots + r_{1n}b_n \\ \vdots \\ r_{n1}b_1 + \cdots + r_{nn}b_n \end{pmatrix}.$$

$\widehat{F}$  is an exact, strongly additive covariant functor. (This is not hard;  $\widehat{F}(B) \approx R^n \otimes_R B$ . See Exercise 4.) Also,  $\widehat{F}(R)$  is isomorphic to the usual column left ideals (which are isomorphic to each other), so that  $\widehat{R} \approx \widehat{F}(R)^n$  as  $\widehat{R}$ -modules. Hence,  $\widehat{F}(R)$  is projective as an  $\widehat{R}$ -module, so Theorem 5.1(a) says that  $\text{P-dim}_{\widehat{R}} \widehat{F}(B) \leq \text{P-dim}_R B$ .

But notice: For any  $B \in {}_R\mathbf{M}$ , we can combine these two inequalities, setting  $\widehat{B} = \widehat{F}(B)$ :

$$\begin{aligned} \text{P-dim}_R B &\geq \text{P-dim}_{\widehat{R}} \widehat{F}(B) = \text{P-dim}_{\widehat{R}} \widehat{B} \\ &\geq \text{P-dim}_R \widehat{B} = \text{P-dim}_R B^n = \text{P-dim}_R B. \end{aligned}$$

(The last is by Exercise 11, Chapter 4.) Thus  $\text{P-dim}_R B = \text{P-dim}_{\widehat{R}} \widehat{F}(B)$  for any  $B \in {}_R\mathbf{M}$ . Taking the supremum,  $\text{LG-dim } R \leq \text{LG-dim } M_n(R)$ .

To prove the reverse inequality, we use Corollary 5.5, with  $I_1, \dots, I_n$  being the column left ideals, each isomorphic to  $\widehat{F}(R)$ . We have that  $\text{LG-dim } M_n(R) = 1 + \text{SP-dim}_{\widehat{R}} \widehat{F}(R)$  when  $\text{LG-dim } M_n(R) > 0$ . (The case  $\text{LG-dim } R = 0$  is covered by the discussion earlier, so we assume  $0 < \text{LG-dim } R$ . But we know that  $\text{LG-dim } R \leq \text{LG-dim } M_n(R)$ .) If we knew that all submodules of  $\widehat{F}(R)$  had the form  $\widehat{F}(I)$  for some left ideal  $I$ , we would be done, since then

$$\begin{aligned} \text{LG-dim } M_n(R) &= 1 + \sup\{\text{P-dim}_{\widehat{R}} \widehat{F}(I) : I \text{ a left ideal in } R\} \\ &= 1 + \sup\{\text{P-dim}_R I : I \text{ a left ideal in } R\} \\ &= \text{LG-dim } R. \end{aligned}$$

To this end, let  $\widehat{B}$  be a submodule of  $\widehat{F}(R)$ . Let  $\Delta_{ij}$  be the  $n \times n$  matrix with 1 in the  $(i, j)$ -slot and all other entries zero. Observe that

$$\Delta_{1j} \begin{pmatrix} b_1 \\ b_2 \\ \vdots \\ b_n \end{pmatrix} = \begin{pmatrix} b_j \\ 0 \\ \vdots \\ 0 \end{pmatrix}.$$

Thus if  $I$  is the set of all entries from all elements of  $\widehat{B}$ , then

$$I = \left\{ b \in R : \begin{pmatrix} b \\ 0 \\ \vdots \\ 0 \end{pmatrix} \in \widehat{B} \right\},$$

an  $R$ -submodule of  $R$ , that is, a left ideal. The original definition of  $I$  shows that  $\widehat{F}(I) \supset \widehat{B}$ , while

$$\begin{pmatrix} b_1 \\ b_2 \\ \vdots \\ b_n \end{pmatrix} \in \widehat{F}(I) \Rightarrow \begin{pmatrix} b_1 \\ b_2 \\ \vdots \\ b_n \end{pmatrix} = \sum_{j=1}^n \Delta_{j1} \begin{pmatrix} b_j \\ 0 \\ \vdots \\ 0 \end{pmatrix} \in \widehat{B}.$$

Thus,  $\widehat{F}(I) = \widehat{B}$ . □

Finally, it should be noted that while the functor  $\widehat{F}$  is not an isomorphism of the category  ${}_R\mathbf{M}$  with  $M_n(R)\mathbf{M}$ , it is so close that it almost doesn't matter. It is an *equivalence* of categories, leading to a different approach to Theorem 5.7. See Exercise 4.

### 5.3 Polynomials

Like the last section, this one has a target result that is easy to state: If  $R$  is a ring, then  $\text{LG-dim } R[x] = 1 + \text{LG-dim } R$ . However, the scenery along the way will be a lot more interesting.

One big difference is that the formula does not assert the equality of two dimensions. The left global dimensions of  $R[x]$  and  $R$  differ (by one). Hence, we must develop some machinery that will allow formulas other than equalities.

A preliminary observation is worth isolating. Suppose  $I$  is a two-sided ideal in  $R$ , and suppose  $F$  is a free  $R$ -module.  $F$  is a direct sum,  $F = \bigoplus_{\mathcal{J}} R$ ; then  $IF = \bigoplus_{\mathcal{J}} I$ , and  $F/IF = \bigoplus_{\mathcal{J}} (R/I)$ . In particular,  $F/IF$  is  $R/I$ -free. If  $P$  is  $R$ -projective (say  $P \oplus Q = F$ , a free  $R$ -module), then  $F/IF = (P/IP) \oplus (Q/IQ)$ , so that  $P/IP$  is  $R/I$ -projective.

**Proposition 5.8** *Suppose  $a$  is central in  $R$ , and  $a$  is neither a unit nor a zero divisor. Set  $\widehat{R} = R/Ra$ . Suppose  $\widehat{B}$  is a nonzero left  $\widehat{R}$ -module with finite projective dimension as an  $\widehat{R}$ -module. Then*

$$\text{P-dim}_R \widehat{B} = 1 + \text{P-dim}_{\widehat{R}} \widehat{B}.$$

**Proof:** The proof is by induction on  $\text{P-dim}_{\widehat{R}} \widehat{B}$ ; by hypothesis this is finite. First observe that, by Theorem 5.1,  $\text{P-dim}_R \widehat{B} \leq \text{P-dim}_R \widehat{R} + \text{P-dim}_{\widehat{R}} \widehat{B}$ . Furthermore,  $0 \rightarrow Ra \rightarrow R \rightarrow \widehat{R} \rightarrow 0$  is an  $R$ -projective resolution of  $\widehat{R}$  (since  $a$  is not a zero divisor,  $R \approx Ra$  as  $R$ -modules). Hence,  $\text{P-dim}_R \widehat{R} \leq 1$ , and  $\text{P-dim}_R \widehat{B} \leq 1 + \text{P-dim}_{\widehat{R}} \widehat{B}$ .

Suppose  $\widehat{B}$  is a nonzero left  $\widehat{R}$ -module. Since  $a$  is not a zero divisor, multiplication by  $a$  is one-to-one on any free left  $R$ -module, hence on any



projective left  $R$ -module (since projective left  $R$ -modules are direct summands of free modules, hence are submodules of free modules). However,  $a\hat{B} = 0$ ; hence,  $\hat{B}$  cannot be  $R$ -projective. That is,  $1 \leq \text{P-dim}_R \hat{B}$  whenever  $\hat{B} \neq 0$ . Taking  $\hat{B} = \hat{R}$ , we have that  $\text{P-dim}_R \hat{R} = 1$ . Taking  $\hat{B}$  to be  $\hat{R}$ -projective, we have that  $1 \leq \text{P-dim}_R \hat{B} \leq 1 + \text{P-dim}_{\hat{R}} \hat{B} = 1$ ; this is the dimension zero case of the induction.

Like many inductions in homological algebra, we must separately check the  $\text{P-dim}_{\hat{R}} \hat{B} = 1$  case. This will be the most complicated part of the proof. Suppose  $\text{P-dim}_{\hat{R}} \hat{B} = 1$ . We have, by the earlier discussion, that  $1 \leq \text{P-dim}_R \hat{B} \leq 1 + \text{P-dim}_{\hat{R}} \hat{B} = 2$ . We must eliminate the possibility that  $\text{P-dim}_R \hat{B} = 1$ . This is done by showing that, in fact,  $\text{P-dim}_R \hat{B} = 1$  and  $\text{P-dim}_{\hat{R}} \hat{B} \leq 1 \Rightarrow \text{P-dim}_{\hat{R}} \hat{B} = 0$ .

Assume that  $\text{P-dim}_R \hat{B} = 1$  and  $\text{P-dim}_{\hat{R}} \hat{B} \leq 1$ . There is an exact sequence  $0 \rightarrow P \hookrightarrow F \rightarrow \hat{B} \rightarrow 0$  of  $R$ -modules, where  $F$  is  $R$ -free and  $P$  is  $R$ -projective by the projective dimension theorem.  $a\hat{B} = 0 \Rightarrow a(F/P) = 0 \Rightarrow aF \subset P$ , so that  $\hat{B} \approx F/P \approx (F/aF)/(P/aF)$  by the fundamental isomorphism theorems. This gives another short exact sequence  $0 \rightarrow P/aF \hookrightarrow F/aF \rightarrow \hat{B} \rightarrow 0$ . Since  $a$  kills each term, this is an exact sequence of  $\hat{R}$ -modules. Furthermore,  $F/aF$  is  $\hat{R}$ -free by the remarks preceding this proposition. Since  $\text{P-dim}_{\hat{R}} \hat{B} \leq 1$ ,  $P/aF$  is  $\hat{R}$ -projective by the projective dimension theorem.

But again,  $P/aF \approx (P/aP)/(aF/aP)$  by the fundamental isomorphism theorems, leading again to a short exact sequence  $0 \rightarrow aF/aP \rightarrow P/aP \rightarrow P/aF \rightarrow 0$  where  $P/aP$  is  $\hat{R}$ -projective by the remarks preceding this proposition. Also, this is again an exact sequence of  $\hat{R}$ -modules. Hence  $aF/aP$  is  $\hat{R}$ -projective by the projective dimension theorem. (More:  $0 \rightarrow aF/aP \rightarrow P/aP \rightarrow P/aF \rightarrow 0$  must split since  $P/aF$  is  $\hat{R}$ -projective.) But since  $a$  is not a zero divisor,  $aF/aP \approx F/P \approx \hat{B}$ , so  $\hat{B}$  is  $\hat{R}$ -projective. This completes the  $n = 1$  case.

The induction step  $n \rightarrow n + 1$  remains; assume  $\text{P-dim}_{\hat{R}} \hat{B} = n + 1$ , with  $n \geq 1$ . We have a short exact sequence  $0 \rightarrow \hat{C} \rightarrow \hat{F} \rightarrow \hat{B} \rightarrow 0$ , where  $\hat{F}$  is free over  $\hat{R}$ . Here,  $\text{P-dim}_{\hat{R}} \hat{C} = n$  by Exercise 2, Chapter 4. But  $\text{P-dim}_R \hat{F} = 1$  by the dimension zero case, while  $\text{P-dim}_R \hat{C} = n + 1$  by the induction hypothesis, so again using Exercise 2, Chapter 4,  $\text{P-dim}_R \hat{B} = 1 + \text{P-dim}_R \hat{C} = 1 + (n + 1) = 1 + \text{P-dim}_{\hat{R}} \hat{B}$ .  $\square$

The requirement that  $\text{P-dim}_{\hat{R}} \hat{B} < \infty$  is definitely necessary: If  $R = \mathbb{Z}$ ,  $a = 4$ ,  $\hat{B} = \mathbb{Z}_2$ , then  $\text{P-dim}_{\hat{R}} \hat{B} = \infty$ , while  $\text{P-dim}_R \hat{B} = 1$ . We have two corollaries:

**Corollary 5.9** *Suppose  $a$  is central in  $R$ , and  $a$  is neither a unit nor a zero divisor. Set  $\hat{R} = R/Ra$ , and suppose  $\text{LG-dim } \hat{R} < \infty$ . Then  $\text{LG-dim } R \geq 1 + \text{LG-dim } \hat{R}$ .*



**Proof:** Take the supremum over  $\widehat{R}\mathbf{M}$  in Proposition 5.8.  $\square$

**Corollary 5.10** *If  $\text{LG-dim } R < \infty$ , then  $\text{LG-dim } R[x] \geq 1 + \text{LG-dim } R$ .*

**Proof:** Take  $a = x \in \widehat{R} = R[x] : \widehat{R}/\widehat{R}x \approx R$ .  $\square$

To finish the discussion of polynomials, we define a functor from  $R$ -modules to  $R[x]$ -modules, often called the polynomial functor. If  $B \in {}_R\mathbf{M}$ , let  $B[x]$  denote all formal finite sums  $\sum_{k=0}^n b_k x^k$ . Let  $R[x]$  act on  $B[x]$  in the expected way:  $(\sum r_j x^j)(\sum b_k x^k) = \sum r_j b_k x^{j+k}$ . Set  $F(B) = B[x]$ . Note that  $F(B) \approx R[x] \otimes_R B$ , so  $F$  is strongly additive and exact (since  $R[x]$  is free, hence flat, in  $\mathbf{M}_R$ ).  $F(R) = R[x]$ , so  $\text{P-dim}_{R[x]} F(R) = 0$ , and  $\text{P-dim}_{R[x]} B[x] \leq \text{P-dim}_R B$  by Theorem 5.1. This is, in fact, an equality.

**Proposition 5.11** *For all  $B \in {}_R\mathbf{M}$ ,  $\text{P-dim}_{R[x]} B[x] = \text{P-dim}_R B$ .*

**Proof:** This is much like the two-functor argument of Theorem 5.7 in the last section. Let  $\widehat{R} = R[x]$ .  $\text{P-dim}_R \widehat{R} = 0$ , so by Theorem 5.1 we have that  $\text{P-dim}_R \widehat{B} \leq \text{P-dim}_{\widehat{R}} \widehat{B}$  for any  $\widehat{B} \in \widehat{R}\mathbf{M}$ . Setting  $\widehat{B} = B[x] = F(B)$ , where  $F$  is the polynomial functor,

$$\text{P-dim}_R B[x] \leq \text{P-dim}_{\widehat{R}} B[x] = \text{P-dim}_{R[x]} B[x] \leq \text{P-dim}_R B.$$

But  $\text{P-dim}_R B[x] = \text{P-dim}_R B$  by Exercise 11, Chapter 4. Hence  $\text{P-dim}_R B = \text{P-dim}_{\widehat{R}} B[x]$ .  $\square$

Proposition 5.11 arises from considering what happens when the polynomial functor  $F$  is followed by viewing  $\widehat{R}$ -modules as  $R$ -modules. Reverse the order in which these operations are done. That is, given an  $\widehat{R} = R[x]$ -module  $\widehat{B}$ , view it as an  $R$ -module, and apply the polynomial functor. The result is  $\widehat{B}[x] = R[x] \otimes_R \widehat{B}$ . We now define two maps on  $\widehat{B}[x]$ , defined via bilinear maps:

$$\begin{array}{ccc} R[x] \times \widehat{B} & \xrightarrow{\varphi} & R[x] \otimes \widehat{B} = \widehat{B}[x] \\ & \searrow \psi & \downarrow \pi \\ & & \widehat{B} \end{array} \quad \psi(f(x), \widehat{b}) = f(x) \cdot \widehat{b}$$

and

$$\begin{array}{ccc} R[x] \times \widehat{B} & \xrightarrow{\varphi} & R[x] \otimes \widehat{B} = \widehat{B}[x] \\ & \searrow \eta & \downarrow j \\ & & R[x] \otimes \widehat{B} = \widehat{B}[x] \end{array} \quad \eta(f(x), \widehat{b}) = f(x)x \otimes \widehat{b} - f(x) \otimes x\widehat{b}.$$

$\varphi$  is the bilinear map defining the tensor product.

**Lemma 5.12**  $0 \rightarrow \widehat{B}[x] \xrightarrow{j} \widehat{B}[x] \xrightarrow{\pi} \widehat{B} \rightarrow 0$  is short exact.

**Proof:** For any  $\widehat{b} \in \widehat{B}$ ,  $\pi(1 \otimes \widehat{b}) = \psi(1, \widehat{b}) = \widehat{b}$ , so  $\pi$  is onto. Also,  $\pi\eta(f(x), \widehat{b}) = f(x)x\widehat{b} - f(x)x\widehat{b} = 0$ , that is,  $\pi\eta = 0$ . Hence  $\pi j = 0$ , since  $\pi j$  is the unique filler in the diagram

$$\begin{array}{ccc} R[x] \times \widehat{B} & \xrightarrow{\varphi} & R[x] \otimes \widehat{B} = \widehat{B}[x] \\ & \searrow \pi\eta=0 & \downarrow \pi j \\ & & \widehat{B}. \end{array}$$

To show that  $j$  is one-to-one, and onto  $\ker \pi$ , it is clearest to work with a modified  $\widehat{B}[x]$  picture, treating  $\widehat{B}[x]$  as consisting of N-tuples:

$$\begin{aligned} (\widehat{b}_0, \widehat{b}_1, \widehat{b}_2, \dots, \widehat{b}_n, 0, 0, \dots) &\leftrightarrow \sum_{k=0}^n \widehat{b}_k x^k \in \widehat{B}[x] \\ &\leftrightarrow \sum_{k=0}^n x^k \otimes \widehat{b}_k \in R[x] \otimes_R \widehat{B} \end{aligned}$$

Note that

$$\pi((\widehat{b}_0, \widehat{b}_1, \dots, \widehat{b}_n, 0, \dots)) = \sum_{k=0}^n x^k \cdot \widehat{b}_k$$

and

$$j((\widehat{b}_0, \widehat{b}_1, \dots, \widehat{b}_n, 0, \dots)) = (-x\widehat{b}_0, \widehat{b}_0 - x\widehat{b}_1, \dots, \widehat{b}_{n-1} - x\widehat{b}_n, \widehat{b}_n, 0, \dots).$$

The fact that  $\ker j = 0$  follows quickly, since  $j((\widehat{b}_0, \widehat{b}_1, \dots, \widehat{b}_n, 0, \dots)) = 0 \Rightarrow \widehat{b}_n = 0 \Rightarrow \widehat{b}_{n-1} = 0 \Rightarrow \dots \Rightarrow \widehat{b}_0 = 0$ . That  $j$  maps onto  $\ker \pi$  takes more work.

$$\begin{aligned} \text{Suppose } \pi((\widehat{b}_0, \widehat{b}_1, \dots, \widehat{b}_n, 0, \dots)) = \sum_{k=0}^n x^k \widehat{b}_k = 0. \text{ Then } \widehat{b}_0 = -\sum_{k=1}^n x^k \widehat{b}_k = \\ -x \left( \sum_{k=1}^n x^{k-1} \widehat{b}_k \right). \text{ Set } \widehat{c}_0 = \sum_{k=1}^n x^{k-1} \widehat{b}_k; \text{ then } \widehat{b}_0 = -x\widehat{c}_0. \text{ Also, } \widehat{b}_1 - \widehat{c}_0 = \\ -\sum_{k=2}^n x^{k-1} \widehat{b}_k = -x \left( \sum_{k=2}^n x^{k-2} \widehat{b}_k \right). \text{ Set } \widehat{c}_1 = \sum_{k=2}^n x^{k-2} \widehat{b}_k; \text{ then } \widehat{b}_1 - \widehat{c}_0 = -x\widehat{c}_1, \end{aligned}$$

so that  $\widehat{b}_1 = \widehat{c}_0 - x\widehat{c}_1$ . In general, set  $\widehat{c}_l = \sum_{k=l+1}^n x^{k-l-1}\widehat{b}_k$ . Then

$$\begin{aligned}\widehat{c}_{l-1} - x\widehat{c}_l &= \sum_{k=l}^n x^{k-l}\widehat{b}_k - x \sum_{k=l+1}^n x^{k-l-1}\widehat{b}_k \\ &= \sum_{k=l}^n x^{k-l}\widehat{b}_k - \sum_{k=l+1}^n x^{k-l}\widehat{b}_k = \widehat{b}_l,\end{aligned}$$

as well as  $\widehat{c}_{n-1} = \widehat{b}_n$ . Hence,

$$(\widehat{b}_0, \widehat{b}_1, \dots, \widehat{b}_n, 0, \dots) = j((\widehat{c}_0, \widehat{c}_1, \dots, \widehat{c}_{n-1}, 0, \dots)).$$

Since  $(\widehat{b}_0, \widehat{b}_1, \dots, \widehat{b}_n, 0, \dots) \in \ker \pi$  was arbitrary,  $j$  is onto  $\ker \pi$ .  $\square$

We can now prove:

**Theorem 5.13** *If  $R$  is any ring, then  $\text{LG-dim } R[x] = 1 + \text{LG-dim } R$ .*

**Proof:** If  $\text{LG-dim } R = \infty$ , then  $\text{LG-dim } R[x] = \infty$ , too, by taking the supremum over  $B \in {}_R\mathbf{M}$  in Proposition 5.11. This verifies the theorem if  $\text{LG-dim } R = \infty$ , so suppose  $\text{LG-dim } R < \infty$ . Then  $\text{LG-dim } R[x] \geq 1 + \text{LG-dim } R$  by Corollary 5.10. It therefore suffices to show that  $1 + \text{LG-dim } R \geq \text{P-dim}_{\widehat{R}}\widehat{B}$  for all  $\widehat{B} \in \widehat{R}\mathbf{M}$  (with  $\widehat{R} = R[x]$ ).

Suppose  $\widehat{B} \in \widehat{R}\mathbf{M}$ . By Lemma 5.12, we have a short exact sequence of  $\widehat{R}$ -modules  $0 \rightarrow \widehat{B}[x] \rightarrow \widehat{B}[x] \rightarrow \widehat{B} \rightarrow 0$ . By Proposition 5.11,  $\text{P-dim}_{\widehat{R}}\widehat{B}[x] = \text{P-dim}_R\widehat{B} \leq \text{LG-dim } R$ . By Corollary 4.3 (with  $n = 1$  and  $d = \text{LG-dim } R$ ),  $\text{P-dim}_{\widehat{R}}\widehat{B} \leq 1 + \text{LG-dim } R$ .  $\square$

**Corollary 5.14 (Hilbert's Syzygy Theorem)** *If  $K$  is a field, then  $\text{LG-dim } K[x_1, \dots, x_n] = n$ .*

**Proof:** Induction on  $n$  :  $K[x_1, \dots, x_{n+1}] = K[x_1, \dots, x_n][x_{n+1}]$  for the induction step.  $\square$

## 5.4 Quotients and Localization

In this last section of Chapter 5, the ring  $R$  will be assumed to be commutative. An *admissible multiplicative subset* of  $R$  is a subset  $S$  that contains one, does not contain zero, and is closed under multiplication.  $S$  may contain zero divisors, but  $S$  cannot contain nilpotent elements. (If  $a \in S$ , then

$a^n \in S$  for all  $n \in \mathbb{N} \dots$ ) The most important case is when  $S$  is the complement of a prime ideal, but the situation is more general than that. One can form the ring of quotients  $S^{-1}R$ , which we recall shortly. The idea is that even though the ring  $S^{-1}R$  is typically larger, it is also “nicer,” in the sense that its internal structure is simpler. For example, if  $R$  is an integral domain and  $S = R - \{0\}$ , then  $S^{-1}R$  is the quotient field of  $R$ . One might expect that, upon forming  $S^{-1}R$ , the global dimension should go down, or at least not go up. This is indeed the case, as Theorem 5.18 asserts. But there is more as well, at least if the ring is Noetherian.

The ring of quotients is defined as follows. Form the product set  $S \times R$ ;  $S \times R$  is a commutative monoid, that is, a commutative semigroup with unit, where  $R$  is treated as a multiplicative semigroup. Define a relation  $\sim$  on  $S \times R$  as follows:

$$(s, r) \sim (s', r') \Leftrightarrow \exists s^* \in S : s^*(sr' - s'r) = 0.$$

(Note that if  $S$  contains no zero divisors, then  $(s, r) \sim (s', r') \Leftrightarrow sr' = s'r$ .) This is an equivalence relation. As usual, symmetry and reflexivity are more or less obvious. Transitivity goes as follows:

$$\begin{aligned} (s, r) \sim (s', r') &\Rightarrow s^*(sr' - s'r) = 0 \\ (s', r') \sim (s'', r'') &\Rightarrow s^{**}(s'r'' - s''r') = 0 \end{aligned}$$

Hence, adding and subtracting  $ss''r' = s''sr'$

$$\begin{aligned} s^*s^{**}s'(sr'' - s''r) &= s^*s^{**}(ss'r'' - s''s'r) \\ &= s^*s^{**}(ss'r'' - ss''r' + s''sr' - s''s'r) \\ &= s^*ss^{**}(s'r'' - s''r') + s^{**}s''s^*(sr' - s'r) \\ &= 0. \end{aligned}$$

Define  $S^{-1}R$  to be the set of equivalence classes in  $S \times R$  under the relation  $\sim$ . The equivalence class of the ordered pair  $(s, r)$  is written  $r/s$ , and  $S^{-1}R$  is made into a commutative ring by requiring what one expects, namely,  $r/s + \bar{r}/\bar{s} = (\bar{s}r + s\bar{r})/s\bar{s}$  and  $(r/s)(\bar{r}/\bar{s}) = r\bar{r}/s\bar{s}$ . A long, tedious calculation shows that  $S^{-1}R$  becomes a commutative ring, with  $0/1 = 0$  and  $1/1 = 1$ . Try it some night when you can't sleep. (The least obvious point, that addition is well-defined, may be found, for example, in Hungerford [37, p. 143].) Two little facts should be noted: If  $R$  is an integral domain, then so is  $S^{-1}R$ . (If  $(1, 0) \sim (s\bar{s}, r\bar{r})$ , then  $1 \cdot r\bar{r} - 0 \cdot s\bar{s} = 0$  [since  $S$  contains no zero divisors]  $\Rightarrow r = 0$  or  $\bar{r} = 0 \Rightarrow (s, r) \sim (1, 0)$  or  $(\bar{s}, \bar{r}) \sim (1, 0)$ .) Also,  $(s, r) \sim (s's, s'r)$ , that is,  $r/s = s'r/s's$ .

One has a homomorphism  $\phi$  from  $R$  to  $S^{-1}R$  which sends  $r$  to  $r/1$ ;  $\ker \phi$  consists of those  $r$  for which  $(1, r) \sim (1, 0)$ , that is, for which there is an  $s^* \in S$  such that  $s^*r = 0$ . Thus,  $\phi$  is one-to-one if and only if  $S$  contains no zero divisors.

All the above can also be carried out for  $R$ -modules. If  $B \in {}_R\mathbf{M}$ , one may define  $S^{-1}B$  in an entirely analogous way. Define a relation  $\sim$  on  $S \times B$  via

$$(s, b) \sim (s', b') \Leftrightarrow \exists s^* \in S : s^*(sb' - s'b) = 0.$$

The relation  $\sim$  is an equivalence relation, and  $S^{-1}B$ , the set of equivalence classes, becomes an  $S^{-1}R$ -module under  $b/s + \bar{b}/\bar{s} = (\bar{s}b + s\bar{b})/s\bar{s}$  and  $(r/s) \cdot (b/\bar{s}) = rb/s\bar{s}$ . The two most fundamental facts about  $S^{-1}B$  are contained in the following proposition.

**Proposition 5.15** *Suppose  $R$  is a commutative ring, and  $S$  is an admissible multiplicative subset of  $R$ . Suppose  $B \in {}_R\mathbf{M}$ . Then*

- a)  $S^{-1}B \approx S^{-1}R \otimes_R B$ .
- b)  $S^{-1}R$  is flat as an  $R$ -module.

**Proof:** (a) The technique is to show that  $S^{-1}B$  satisfies the universal property defining a tensor product. First of all, define  $\psi : S^{-1}R \times B \rightarrow S^{-1}B$  via  $\psi(r/s, b) = rb/s$ .  $\psi$  is easily checked to be well-defined; if  $(s, r) \sim (s', r')$ , and  $s^*(sr' - s'r) = 0$ , then  $s^*(sr'b - s'r'b) = 0$ , so that  $s^*(s(r'b) - s'(rb)) = 0$ , and  $rb/s = r'b/s'$ .  $\psi$  is also  $R$ -bilinear, since  $\psi((r/s)(\bar{r}/1), b) = \psi(r\bar{r}/s, b) = r\bar{r}b/s = \psi(r/s, \bar{r}b)$ . Further,  $\psi$  is onto, since  $\psi(1/s, b) = b/s$  for any  $s \in S, b \in B$ . Hence, any filler  $\tau$  for

$$\begin{array}{ccc} S^{-1}R \times B & \xrightarrow{\psi} & S^{-1}B \\ & \searrow \theta & \downarrow \tau \\ & & G \end{array}$$

will be unique. Suppose  $\theta : S^{-1}R \times B \rightarrow G$  is  $R$ -bilinear. Define  $\tau(b/s) = \theta(1/s, b)$ . Since  $\tau\psi(r/s, b) = \tau(rb/s) = \theta(1/s, rb) = \theta((1/s)(r/1), b) = \theta(r/s, b)$ , we will have that  $\tau$  is a filler provided  $\tau$  is well-defined (and is a homomorphism).

$\tau$  is well-defined: If  $(s, b) \sim (s', b')$ , then  $\exists s^* \in S$  with  $s^*(sb' - s'b) = 0$ , that is,  $s^*sb' = s^*s'b$ . Hence,

$$\begin{aligned} \theta(1/s, b) &= \theta(s^*s'/ss^*s', b) \\ &= \theta((1/ss^*s')(s^*s'/1), b) \\ &= \theta(1/ss^*s', s^*s'b) \\ &= \theta(1/s's^*s, s^*sb') \\ &= \theta((1/s's^*s)(s^*s/1), b') \\ &= \theta(s^*s/s's^*s, b') \\ &= \theta(1/s', b'). \end{aligned}$$



Hence, this value for  $\tau(b/s)$  is well-defined. To see that  $\tau$  is a homomorphism,

$$\begin{aligned}
 \tau(b/s + \bar{b}/\bar{s}) &= \tau((\bar{s}b + s\bar{b})/s\bar{s}) \\
 &= \theta(1/s\bar{s}, \bar{s}b + s\bar{b}) \\
 &= \theta(1/s\bar{s}, \bar{s}b) + \theta(1/s\bar{s}, s\bar{b}) \\
 &= \theta((1/s\bar{s})(\bar{s}/1), b) + \theta((1/s\bar{s})(s/1), \bar{b}) \\
 &= \theta(\bar{s}/s\bar{s}, b) + \theta(s/s\bar{s}, \bar{b}) \\
 &= \theta(1/s, b) + \theta(1/\bar{s}, \bar{b}) \\
 &= \tau(b/s) + \tau(\bar{b}/\bar{s}).
 \end{aligned}$$

(b) To show  $S^{-1}R$  is  $R$ -flat, suppose  $0 \rightarrow B \rightarrow B'$  is exact, that is,  $j : B \rightarrow B'$  is one-to-one. We must show that  $S^{-1}R \otimes_R B \rightarrow S^{-1}R \otimes_R B'$  is one-to-one, that is, that  $S^{-1}B \rightarrow S^{-1}B'$  is one-to-one. Suppose  $(S^{-1}R \otimes j)(b/s) = 0/1$ . Then  $\exists s^* \in S$  such that  $s^*j(b) = 0$ , that is,  $j(s^*b) = 0$ , from which  $s^*b = 0$  (so that  $b/s = 0/1$ ), since  $j$  is one-to-one.  $\square$

**Corollary 5.16** *Suppose  $R$  is a commutative ring and  $S$  is an admissible multiplicative subset of  $R$ . Then the map  $B \mapsto S^{-1}B$  is an exact, strongly additive covariant functor.*

**Proof:**  $S^{-1}B \approx S^{-1}R \otimes B$ . Tensor products are always right exact, strongly additive covariant functors. It is exact in this case since  $S^{-1}R$  is flat.  $\square$

To proceed further, we need a few technical results. Some are of considerable importance; some are little lemmas. One technical point comes from the fact that  $B \mapsto S^{-1}B$  is now a functor. If  $f \in \text{Hom}(A, B)$ , we have  $S^{-1}f \in \text{Hom}(S^{-1}A, S^{-1}B)$ ; of course,  $S^{-1}f \approx S^{-1}R \otimes_R f \in \text{Hom}(S^{-1}R \otimes_R A, S^{-1}R \otimes_R B)$ . One should note that, if  $\psi^A : A \rightarrow S^{-1}A$  and  $\psi^B : B \rightarrow S^{-1}B$  are the maps  $x \mapsto x/1$ , then the diagram

$$\begin{array}{ccc}
 A & \xrightarrow{f} & B \\
 \psi^A \downarrow & & \downarrow \psi^B \\
 S^{-1}A & \xrightarrow{S^{-1}f} & S^{-1}B
 \end{array}$$

commutes. (See Exercise 5.)

The following summarizes what can be said before specializing the quotient construction to localization.

**Proposition 5.17** *Suppose  $R$  is a commutative ring, and  $S$  is an admissible multiplicative subset. Set  $\hat{R} = S^{-1}R$ ,  $\phi : R \rightarrow \hat{R}$  the associated ring homomorphism.*

- a) If  $B \in {}_R\mathbf{M}$ , and  $\psi : B \rightarrow S^{-1}B$  is the associated module homomorphism, then  $b \in \ker \psi \Leftrightarrow S \cap \text{ann}(b) \neq \emptyset$ . If  $\psi$  is one-to-one, then  $b/s \in \psi(B) \Leftrightarrow b \in sB$ .
- b) If  $B \in {}_R\mathbf{M}$ , then the following are equivalent:
- i)  $B = \widehat{C}$  for some  $\widehat{C} \in {}_{\widehat{R}}\mathbf{M}$ .
  - ii)  $sB = B$  and  $\{b \in B : sb = 0\} = 0$  for all  $s \in S$ .
  - iii)  $B \approx S^{-1}B$ .
- c) If  $\widehat{A}, \widehat{B} \in {}_{\widehat{R}}\mathbf{M}$ , then  $\widehat{A} \otimes_R \widehat{B} \approx \widehat{A} \otimes_{\widehat{R}} \widehat{B}$ , and  $\text{Hom}_R(\widehat{A}, \widehat{B}) = \text{Hom}_{\widehat{R}}(\widehat{A}, \widehat{B})$ .
- d)  $S^{-1}(S^{-1}B) \approx S^{-1}B$  for all  $B \in {}_R\mathbf{M}$ .
- e)  $S^{-1}(A \otimes_R B) \approx (S^{-1}A) \otimes_R B \approx A \otimes_R (S^{-1}B) \approx (S^{-1}A) \otimes_R (S^{-1}B) \approx (S^{-1}A) \otimes_{S^{-1}R} (S^{-1}B)$  for all  $A \in \mathbf{M}_R$  and  $B \in {}_R\mathbf{M}$ .

**Proof:** (a)  $b \in \ker \psi \Leftrightarrow b/1 = 0 \Leftrightarrow \exists s^* \in S$  for which  $s^*b = 0 \Leftrightarrow \exists s^* \in S$  for which  $s^* \in \text{ann}(b)$ .  $b/s = \psi(c) \Leftrightarrow b/s = c/1 \Leftrightarrow \exists s^* \in S$  for which  $s^*(b - sc) = 0 \Leftrightarrow b = sc$  if  $\psi$  is one-to-one: By the first sentence,  $\ker \psi = 0 \Rightarrow (s^*(b - sc) = 0 \Rightarrow b - sc = 0)$ .

(b) (i) $\Rightarrow$ (ii) trivially, since all  $s/1$  ( $s \in S$ ) are invertible in  $S^{-1}R$ . (ii) $\Rightarrow$ (iii) by part (a). (iii) $\Rightarrow$ (i) by using the isomorphism of  $B$  with  $S^{-1}B$  to make  $B$  into a literal  $S^{-1}R$ -module  $\widehat{C}$ . This does (d) as well, since  $S^{-1}\widehat{C} \approx \widehat{C} \Rightarrow S^{-1}(S^{-1}B) \approx S^{-1}B$  when  $S^{-1}B = \widehat{C}$ .

(c)  $\widehat{A} \otimes_R \widehat{B} \approx \widehat{A} \otimes_{\widehat{R}} \widehat{B}$  follows from the fact that an  $R$ -bilinear map from  $\widehat{A} \times \widehat{B}$  to any  $G$  is  $\widehat{R}$ -bilinear (and trivially vice-versa), from which  $\widehat{A} \otimes_R \widehat{B}$  solves the universal mapping problem defining  $\widehat{A} \otimes_{\widehat{R}} \widehat{B}$ : If  $\psi : \widehat{A} \times \widehat{B} \rightarrow G$  is  $R$ -bilinear, then  $\forall r \in R, s \in S$ :

$$\begin{aligned} \psi(\widehat{a}(r/s), \widehat{b}) &= \psi(\widehat{a}(r/s), (s/1)(1/s)\widehat{b}) \\ &= \psi(\widehat{a}(r/s)(s/1), (1/s)\widehat{b}) \\ &= \psi(\widehat{a}(r/1), (1/s)\widehat{b}) \\ &= \psi(\widehat{a}, (r/1)(1/s)\widehat{b}) \\ &= \psi(\widehat{a}, (r/s)\widehat{b}). \end{aligned}$$

Similarly,  $\text{Hom}_{\widehat{R}}(\widehat{A}, \widehat{B}) \subset \text{Hom}_R(\widehat{A}, \widehat{B})$ ; however, if  $f \in \text{Hom}_R(\widehat{A}, \widehat{B})$ , then  $(s/1)f((r/s)\widehat{a}) = f((s/1)(r/s)\widehat{a}) = f((r/1)\widehat{a}) = (r/1)f(\widehat{a}) = (s/1)(r/s)f(\widehat{a})$ , so  $f((r/s)\widehat{a}) = (r/s)f(\widehat{a})$ .

Finally, (e). We have

$$\begin{aligned} S^{-1}(A \otimes_R B) &\approx S^{-1}R \otimes_R (A \otimes_R B) && \text{(Prop. 5.15)} \\ (*) &\approx (S^{-1}R \otimes_R A) \otimes_R B && \text{(Exercise 13, Chapter 2)} \\ &\approx (S^{-1}A) \otimes_R B. && \text{(Prop. 5.15)} \end{aligned}$$

Similarly,  $S^{-1}(A \otimes_R B) \approx A \otimes (S^{-1}B)$  by symmetry. Hence,

$$\begin{aligned}
 S^{-1}(A \otimes_R B) &\approx S^{-1}(S^{-1}(A \otimes_R B)) && (d) \\
 &\approx S^{-1}((S^{-1}A) \otimes_R B) && (*) \\
 &\approx (S^{-1}A) \otimes_R (S^{-1}B) && (*) \\
 &\approx (S^{-1}A) \otimes_{S^{-1}R} (S^{-1}B). && (c)
 \end{aligned}$$

□

It should be noted (see Exercise 6) that the isomorphisms of part (e) above are *natural*. That is, if one has, say, an  $f \in \text{Hom}(A, A')$ , then the various diagrams, with various modifications of  $f$  vertically and various isomorphisms horizontally, all commute. For example, for  $S^{-1}(A \otimes_R B) \approx (S^{-1}A) \otimes_R B$ :

$$\begin{array}{ccc}
 S^{-1}(A \otimes_R B) \approx (S^{-1}A) \otimes_R B & & \\
 \downarrow S^{-1}(f \otimes_R B) & & \downarrow (S^{-1}f) \otimes_R B \\
 S^{-1}(A' \otimes_R B) \approx (S^{-1}A') \otimes_R B. & & 
 \end{array}$$

A corollary to the above proposition appears next as one of the two theorems of this section. Part (b) can be improved upon (see Exercise 8).

**Theorem 5.18** *Suppose  $R$  is a commutative ring and  $S$  is an admissible multiplicative subset of  $R$ . We have*

- a)  $\text{P-dim}_{S^{-1}R} S^{-1}B \leq \text{P-dim}_R B$  for any  $B \in {}_R\mathbf{M}$ .
- b)  $\text{F-dim}_R \hat{B} \leq \text{P-dim}_{S^{-1}R} \hat{B}$  for any  $\hat{B} \in {}_{S^{-1}R}\mathbf{M}$ .
- c)  $\text{LG-dim}(S^{-1}R) \leq \text{LG-dim } R$ .

**Proof:** (a) Apply Theorem 5.1(a) to the functor

$$B \mapsto S^{-1}B : \text{P-dim}_{S^{-1}R} S^{-1}R = 0,$$

yielding the inequality.

(b) Apply Theorem 5.1(b) to the functor  $\hat{B}$ -as- $S^{-1}R$ -module  $\mapsto \hat{B}$ -as- $R$ -module.  $\text{F-dim}_R S^{-1}R = 0$ , yielding the inequality.

(c) If  $\hat{C} \in {}_{S^{-1}R}\mathbf{M}$ , then

$$\begin{aligned}
 \text{P-dim}_{S^{-1}R} \hat{C} &= \text{P-dim}_{S^{-1}R} S^{-1}\hat{C} && (\text{Prop. 5.17(b)}) \\
 &\leq \text{P-dim}_R \hat{C} && (\text{part (a) above}) \\
 &\leq \text{LG-dim } R.
 \end{aligned}$$

Take the supremum over  $S^{-1}R\mathbf{M}$ . □

To proceed further, it is necessary to restrict the situation. Suppose  $P$  is a prime ideal, and set  $S = R - P$ . The ring of quotients  $S^{-1}R$  is then called the *localization* of  $R$  at  $P$ , and is written  $R_P$ . The reason is that the ring  $R_P$  has just one maximal ideal, namely  $S^{-1}P$  (or  $P_P$  if you prefer). The usual definitions are as follows: A ring  $R$  will be called *quasilocal* if it has a unique maximal left ideal.  $R$  is *local* if  $R$  is quasilocal, commutative, and Noetherian. Some authors do not require commutative or Noetherian, and their “local” equals our “quasilocal.” However, there are good reasons for imposing the Noetherian condition. We shall shortly see one; more appear in Chapter 9. See also any good book on commutative algebra. The commutativity and Noetherian conditions impose limits that are hard to dispense with in most circumstances.

In general, if  $P$  is a prime ideal, with  $S = R - P$ , then a subscript of  $P$  will substitute for a prefix of  $S^{-1}$ . For example, if  $A \in {}_R\mathbf{M}$ , then  $A_P \in {}_{R_P}\mathbf{M}$ , and  $f \in \text{Hom}(A, B)$  yields  $f_P \in \text{Hom}(A_P, B_P)$ .

The following result makes no Noetherian assumptions (one of its virtues). Nevertheless, we shall have to impose the Noetherian condition to make use of it.

**Proposition 5.19** *Suppose  $R$  is commutative and  $A \in {}_R\mathbf{M}$ . Suppose  $A_M$  is  $R_M$ -flat for every maximal ideal  $M$ . Then  $A$  is flat.*

**Proof:** Suppose  $A$  is not flat. We must produce a maximal ideal  $M$  such that  $A_M$  is not  $R_M$ -flat.

To begin with, there is an exact sequence  $0 \rightarrow B \xrightarrow{j} C$  such that  $A \otimes j : A \otimes B \rightarrow A \otimes C$  is not one-to-one. Choose  $x \in \ker(A \otimes j)$ ,  $x \neq 0$ .  $A \otimes B$  is an  $R$ -module, and  $\text{ann}(x)$  is a proper ideal; choose a maximal ideal  $M \supset \text{ann}(x)$ . We shall show that  $M$  works.

First of all,  $B \mapsto B_M$  is an exact functor, so  $0 \rightarrow B_M \rightarrow C_M$  is exact, that is,  $j_M : B_M \rightarrow C_M$  is one-to-one. The diagram

$$\begin{array}{ccc}
 A \otimes_R B & \xrightarrow{A \otimes j} & A \otimes_R C \\
 \psi \downarrow & & \downarrow \psi' \\
 (A \otimes_R B)_M & \xrightarrow{(A \otimes j)_M} & (A \otimes_R C)_M \\
 \cong & & \cong \\
 A_M \otimes_{R_M} B_M & \xrightarrow{A_M \otimes j_M} & A_M \otimes_{R_M} C_M
 \end{array}$$

commutes by naturality of Proposition 5.17(e) (see Exercise 6). But  $\psi'(A \otimes j)(x) = 0 \Rightarrow (A \otimes j)_M \psi(x) = 0$ , and  $\psi(x) \neq 0$  by Proposition 5.17(a). Hence,  $A_M \otimes j_M$  is not one-to-one. Since  $A_M \otimes$  sends the exact sequence



$0 \rightarrow B_M \rightarrow C_M$  to the nonexact sequence  $0 \rightarrow A_M \otimes B_M \rightarrow A_M \otimes C_M$ ,  $A_M$  is not flat.  $\square$

We can now prove the second major theorem of this section. The Noetherian condition is required for it.

**Theorem 5.20** *Suppose  $R$  is commutative. Then  $\text{LG-dim } R \geq \text{LG-dim } R_P$  for every prime ideal  $P$ . Moreover, if  $R$  is Noetherian, then  $\text{LG-dim } R = \sup\{\text{LG-dim } R_M : M \text{ a maximal ideal}\}$ .*

**Proof:**  $\text{LG-dim } R \geq \text{LG-dim } R_P$  by Theorem 5.18. Hence,  $\text{LG-dim } R \geq \sup\{\text{LG-dim } R_M : M \text{ a maximal ideal}\}$ . Suppose  $R$  is Noetherian but this inequality is strict. Set  $n = \sup\{\text{LG-dim } R_M : M \text{ a maximal ideal}\}$ . Then  $n < \infty$ , and it suffices to show that, in fact,  $\text{LG-dim } R \leq n$ .

Let  $I$  be any (left) ideal. Let  $\cdots \rightarrow F_n \rightarrow F_{n-1} \rightarrow \cdots \rightarrow F_1 \rightarrow F_0 \rightarrow R/I \rightarrow 0$  be a free resolution of  $R/I$  consisting of finitely generated  $R$ -modules. If  $M$  is any maximal ideal, and  $F_j = \bigoplus_{\mathcal{J}} R$ , then  $(F_j)_M = \bigoplus_{\mathcal{J}} R_M$ , a free  $R_M$ -module. Since  $A \mapsto A_M$  is an exact functor,

$$\cdots \rightarrow (F_n)_M \rightarrow (F_{n-1})_M \rightarrow \cdots \rightarrow (F_1)_M \rightarrow (F_0)_M \rightarrow (R/I)_M \rightarrow 0$$

is an  $R_M$ -free, hence  $R_M$ -projective, resolution of  $(R/I)_M$ . Let  $K_n$  denote the  $n$ th kernel of  $\cdots \rightarrow F_n \rightarrow F_{n-1} \rightarrow \cdots \rightarrow F_1 \rightarrow F_0 \rightarrow R/I \rightarrow 0$ .  $K_n$  is finitely presented since  $R$  is Noetherian. Also,

$$0 \rightarrow (K_n)_M \rightarrow (F_{n-1})_M \rightarrow \cdots \rightarrow (F_1)_M \rightarrow (F_0)_M \rightarrow (R/I)_M \rightarrow 0$$

is exact, so  $(K_n)_M$  is isomorphic to the  $n$ th kernel of

$$\cdots \rightarrow (F_n)_M \rightarrow (F_{n-1})_M \rightarrow \cdots \rightarrow (F_1)_M \rightarrow (F_0)_M \rightarrow (R/I)_M \rightarrow 0.$$

Since  $n \geq \text{LG-dim } R_M \geq \text{P-dim}_{R_M}(R/I)_M$ ,  $(K_n)_M$  is projective by the projective dimension theorem.

Now let  $M$  vary over all maximal ideals.  $(K_n)_M$  is always projective, hence flat. Thus  $K_n$  is flat by Proposition 5.19. But now  $K_n$  is projective by Theorem 4.19. Thus,  $\text{P-dim } (R/I) \leq n$  by the projective dimension theorem.

Now let  $I$  vary:  $\text{P-dim } (R/I) \leq n$  for all (left) ideals  $I$ , so  $\text{LG-dim } R \leq n$  by the global dimension theorem.  $\square$

The moral is this: If  $R$  is commutative and Noetherian, then any particular localization may reduce the global dimension, but localizations taken together do not. In fact, if  $\text{LG-dim } R < \infty$ , then there must exist a localization  $R_M$  for which  $\text{LG-dim } R = \text{LG-dim } R_M$ .

By the way,  $\text{W-dim } R = \sup\{\text{W-dim } R_M : M \text{ a maximal ideal}\}$ , whether  $R$  is Noetherian or not. A proof of this can be recovered from the proof of Theorem 5.20 after using Exercise 8(d) to show that  $\text{W-dim } R \geq \text{W-dim } S^{-1}R$  for any admissible multiplicative set  $S$ .



A final comment on this chapter as a whole. Notice what has *not* appeared: This paragraph contains the first reference to  $\text{Tor}$  (and the second to  $\text{Ext}$ ) in this chapter. You can prove more when you use these functors (see Exercise 9b, for example), but contemplate what can be done with “just a theory of homological dimension,” as Kaplansky [45, Introduction] notes.)

## Exercises

1. Suppose  $K$  is a field. Unravel the induction in Hilbert's syzygy theorem and produce a module over  $K[x_1, \dots, x_n]$  with projective dimension  $n$ . (Try the  $n = 1$  and  $n = 2$  cases if you don't see how to proceed.)
2. Suppose  $R$  is a ring and suppose  $a$  is a central nonzero divisor. Let  $B$  be an  $R$ -module on which  $a$  acts simply, that is, such that  $ax = 0, x \in B \Rightarrow x = 0$ . Set  $\widehat{R} = R/Ra$ , and  $\widehat{B} = B/aB$ . Show that  $\text{P-dim}_{\widehat{R}}\widehat{B} \leq \text{P-dim}_R B$ . (Hint: Induction on  $\text{P-dim}_R B$ .)
3. a) Suppose  $F : {}_S\mathbf{M} \rightarrow {}_R\mathbf{M}$  is an additive covariant functor. If  $s \in S$ , define  $f_s(r) = rs$ .  $f_s \in \text{Hom}_S(S, S)$ , where  $S$  is viewed as a left  $S$ -module. Then  $F(f_s) \in \text{Hom}_R(F(S), F(S))$ . If  $x \in F(S)$ , define  $xs = F(f_s)(x)$ . Show that this turns  $F(S)$  into an  $R - S$  bimodule.  
 b) Suppose  $F$  is a right exact, strongly additive covariant functor from  ${}_S\mathbf{M}$  to  ${}_R\mathbf{M}$ . (It will be shown in the next chapter that strongly additive  $\Rightarrow$  additive.) Show that if we set  $A = F(S) \in {}_R\mathbf{M}_S$  (part (a)), then  $F(B) \approx A \otimes_S B$  for all  $B \in {}_S\mathbf{M}$  in such a way that the diagram

$$\begin{array}{ccc} F(B) & \approx & A \otimes_S B \\ \downarrow F(\phi) & & \downarrow A \otimes_S \phi \\ F(B') & \approx & A \otimes_S B' \end{array}$$

commutes for all  $\phi \in \text{Hom}_S(B, B')$ . (This result is *Watts' Theorem*.)

4. A functor  $F : {}_S\mathbf{M} \rightarrow {}_R\mathbf{M}$  is called an *equivalence* if
  - i) For all  $B, B' \in {}_S\mathbf{M}$ ,  $F : \text{Hom}(B, B') \rightarrow \text{Hom}(F(B), F(B'))$  is an isomorphism of groups (so  $F$  is additive), and
  - ii) For all  $C \in {}_R\mathbf{M}$ ,  $\exists B \in {}_S\mathbf{M}$  such that  $F(B) \approx C$ .
    - a) Show that an equivalence is exact.
    - b) Show that  $\text{P-dim}_R F(B) = \text{P-dim}_S B$  and  $\text{I-dim}_R F(B) = \text{I-dim}_S B$  for all  $B \in {}_S\mathbf{M}$  whenever  $F$  is an equivalence.
    - c) Show that  $\text{LG-dim } R = \text{LG-dim } S$  whenever an equivalence  $F$  exists as above.
    - d) Show that  $\widehat{F}(B) \approx R^n \otimes_R B$  if  $\widehat{F}$  is the functor in the proof of Theorem 5.7.
    - e) Show that the functor  $\widehat{F}$  in the proof of Theorem 5.7 is an equivalence.

For the remaining problems,  $R$  is commutative and  $S$  is an admissible multiplicative subset of  $R$ . Set  $\hat{R} = S^{-1}R$ .

5. Show that the diagram

$$\begin{array}{ccc} A & \xrightarrow{f} & B \\ \psi^A \downarrow & & \downarrow \psi^B \\ S^{-1}A & \xrightarrow{S^{-1}f} & S^{-1}B \end{array}$$

is commutative.

6. Define what it means for one of the isomorphisms in Proposition 5.17(e) to be natural, and prove it. (Your choice which one; commutativity of a certain diagram is the point here.)
7. Show that if we map  $\hat{B} \in {}_{S^{-1}R}\mathbf{M}$  to  $\hat{B}$ -as- $R$ -module, then this is an isomorphism of  ${}_{S^{-1}R}\mathbf{M}$  with a full subcategory of  ${}_R\mathbf{M}$ . In fact (see Proposition 5.17(b)), set

$$S^*B = \begin{cases} B, & \text{if } B = \hat{C} \text{ for some } \hat{C} \in \hat{R}\mathbf{M} \\ S^{-1}B, & \text{otherwise.} \end{cases}$$

Show that  $S^*$  is a retraction of  ${}_R\mathbf{M}$  onto a full subcategory isomorphic to  ${}_{S^{-1}R}\mathbf{M}$ .

8. Suppose  $B \in {}_R\mathbf{M}$ , and  $\hat{A} \in {}_{S^{-1}R}\mathbf{M}$ . Prove that

a)  $B$  is  $R$ -flat  $\Rightarrow S^{-1}B$  is  $R$ -flat.

b)  $\hat{A}$  is  $R$ -flat  $\Leftrightarrow \hat{A}$  is  $S^{-1}R$ -flat.

c)  $\text{F-dim}_R B \geq \text{F-dim}_{S^{-1}R} S^{-1}B$ .

d)  $\text{F-dim}_R \hat{A} = \text{F-dim}_{S^{-1}R} \hat{A}$ .

9. a) Show that  $S^{-1}\text{Tor}_n^R(A, B) \approx \text{Tor}_n^{S^{-1}R}(S^{-1}A, S^{-1}B)$  for all  $A \in {}_R\mathbf{M}$ ,  $B \in {}_R\mathbf{M}$ .
- b) Suppose  $R$  is an integral domain. Show that every element of  $\text{Tor}_n^R(A, B)$  is torsion when  $n \geq 1$ , that is,  $\text{ann}_R(x) \neq 0$  for all  $x \in \text{Tor}_n^R(A, B)$ .

Hint for (a): If  $B \rightarrow B' \rightarrow B''$  is underexact, homology  $H$  can be computed from the diagram

$$\begin{array}{ccccccc} & & & 0 & & & \\ & & & \downarrow & & & \\ & & & C & \longrightarrow & 0 & \\ & B \longrightarrow & & \downarrow & & & \\ & & & K & \longrightarrow & B' \longrightarrow & B'' \\ & 0 \longrightarrow & & \downarrow & & & \\ & & & H & & & \\ & & & \downarrow & & & \\ & & & 0 & & & \end{array}$$

where rows and columns are exact.





# 6

## Derived Functors

### 6.1 Additive Functors

The purpose of this chapter and the next is to generalize the earlier constructions of Ext and Tor. In this chapter, functors beyond Hom and  $\otimes$  will be applied to projective (and injective) resolutions in  ${}_R\mathbf{M}$ . In the next chapter, these constructions will be carried out in more general categories.

In order to say anything intelligent at all, our functors must be additive. That is,  $F(f+g) = F(f) + F(g)$  for  $f, g \in \text{Hom}(B, C)$ . Recall the discussion preceding and following Proposition 3.1: Additive functors send complexes to complexes and homotopies to homotopies. In this section we discuss additive functors. The first result clears up the parenthetical point in Exercise 3(b) of Chapter 5.

**Proposition 6.1** *Let  $F : {}_R\mathbf{M} \rightarrow {}_S\mathbf{M}$  be a covariant functor. The following are equivalent:*

- i)  $F$  is additive.*
- ii)  $F(B_1 \oplus B_2) \approx F(B_1) \oplus F(B_2)$  for all  $B_1, B_2 \in {}_R\mathbf{M}$ .*
- iii)  $F(B \oplus B) \approx F(B) \oplus F(B)$  for all  $B \in {}_R\mathbf{M}$ .*

**Remark:** Recall from Chapter 2, Proposition 2.1 and Exercise 1, that direct sums, direct products, and biproducts (of two objects) are identical objects. Hence, the second condition could just as well read " $F(B_1 \times B_2) \approx$

$F(B_1) \times F(B_2)$  for all  $B_1, B_2 \in {}_R\mathbf{M}$ ." Also, tacitly, " $F(A \oplus B) \approx F(A) \oplus F(B)$ " means that if

$$A \xrightarrow{\varphi} A \oplus B \xleftarrow{\psi} B$$

defines  $A \oplus B$  as a direct sum (i.e. coproduct), then

$$F(A) \xrightarrow{F(\varphi)} F(A \oplus B) \xleftarrow{F(\psi)} F(B)$$

defines  $F(A \oplus B)$  as a coproduct.

**Proof:** (i)  $\Rightarrow$  (ii): To show  $F(B_1 \oplus B_2)$  is a biproduct of  $F(B_1)$  with  $F(B_2)$ , suppose we have the arrows specifying a biproduct:

$$B_1 \xleftarrow{\pi_1} B_1 \oplus B_2 \xrightarrow{\pi_2} B_2 \qquad B_1 \xrightarrow{\varphi_1} B_1 \oplus B_2 \xleftarrow{\varphi_2} B_2.$$

Since  $F$  is covariant, we get arrows

$$F(B_1) \xleftarrow{F(\pi_1)} F(B_1 \oplus B_2) \xrightarrow{F(\pi_2)} F(B_2)$$

$$F(B_1) \xrightarrow{F(\varphi_1)} F(B_1 \oplus B_2) \xleftarrow{F(\varphi_2)} F(B_2).$$

Furthermore,  $F(\pi_j)F(\varphi_j) = F(\pi_j\varphi_j) = F(i_{B_j}) = i_{F(B_j)}$  for  $j = 1, 2$ ; also  $F(\varphi_1)F(\pi_1) + F(\varphi_2)F(\pi_2) = F(\varphi_1\pi_1) + F(\varphi_2\pi_2) = F(\varphi_1\pi_1 + \varphi_2\pi_2)$  since  $F$  is additive. But  $F(\varphi_1\pi_1 + \varphi_2\pi_2) = F(i_{B_1 \oplus B_2}) = i_{F(B_1 \oplus B_2)}$ .

(ii)  $\Rightarrow$  (iii) is trivial, so suppose (iii). Suppose  $f, g \in \text{Hom}(B, C)$ . We have diagrams

$$\begin{array}{ccccc} B & \xrightarrow{\varphi_1} & B \oplus B & \xleftarrow{\varphi_2} & B \\ & \searrow f & \downarrow f \oplus g & \swarrow g & \\ & & C & & \end{array}$$

$$B \xleftarrow{\pi_1} B \oplus B \xrightarrow{\pi_2} B$$

$$f \oplus g = f\pi_1 + g\pi_2.$$

(The formula for  $f \oplus g$  appears in the proof of Proposition 2.1.) Applying  $F$  yields diagrams

$$\begin{array}{ccccc} F(B) & \xrightarrow{F(\varphi_1)} & F(B \oplus B) & \xleftarrow{F(\varphi_2)} & F(B) \\ & \searrow F(f) & \downarrow F(f \oplus g) & \swarrow F(g) & \\ & & F(C) & & \end{array} \qquad F(B) \xleftarrow{F(\pi_1)} F(B \oplus B) \xrightarrow{F(\pi_2)} F(B)$$

$$F(f \oplus g) = F(f\pi_1 + g\pi_2).$$

But  $F(B \oplus B)$  is assumed to be a direct sum, hence must be the biproduct in  ${}_S\mathbf{M}$ . (Note: There is a technical point here that needs to be addressed. Exercise 1 does just that.)

Since  $F(f \oplus g)$  is the (one and only) filler,  $F(f \oplus g) = F(f)F(\pi_1) + F(g)F(\pi_2)$  (again by the formula in the proof of Proposition 2.1). Thus, we have that  $F(f\pi_1 + g\pi_2) = F(f)F(\pi_1) + F(g)F(\pi_2)$ . Applying  $F(\varphi_1 + \varphi_2)$  on the right,

$$\begin{aligned} F(f\pi_1 + g\pi_2)F(\varphi_1 + \varphi_2) &= F((f\pi_1 + g\pi_2)(\varphi_1 + \varphi_2)) \\ &= F(f\pi_1\varphi_1 + f\pi_1\varphi_2 + g\pi_2\varphi_1 + g\pi_2\varphi_2) \\ &= F(f\pi_1\varphi_1 + g\pi_2\varphi_2) \\ &= F(f + g) \end{aligned}$$

by Proposition 2.1, while

$$\begin{aligned} (F(f)F(\pi_1) + F(g)F(\pi_2))F(\varphi_1 + \varphi_2) &= F(f)F(\pi_1)F(\varphi_1 + \varphi_2) + F(g)F(\pi_2)F(\varphi_1 + \varphi_2) \\ &= F(f)F(\pi_1(\varphi_1 + \varphi_2)) + F(g)F(\pi_2(\varphi_1 + \varphi_2)) \\ &= F(f)F(\pi_1\varphi_1 + \pi_1\varphi_2) + F(g)F(\pi_2\varphi_1 + \pi_2\varphi_2) \\ &= F(f)F(i_B) + F(g)F(i_B) \\ &= F(f) + F(g), \end{aligned}$$

again by Proposition 2.1. Hence,  $F$  is additive.  $\square$

We close this section with a result that identifies some additive functors.

**Proposition 6.2** *Any half exact covariant functor from  ${}_R\mathbf{M}$  to  ${}_S\mathbf{M}$  is additive.*

**Proof:** Suppose  $F$  is any (not necessarily half exact) covariant functor from  ${}_R\mathbf{M}$  to  ${}_S\mathbf{M}$ . Suppose  $B_1, B_2 \in {}_R\mathbf{M}$ . We have short exact sequences

$$0 \longrightarrow B_1 \xrightarrow{\varphi_1} B_1 \oplus B_2 \xrightarrow{\pi_2} B_2 \longrightarrow 0$$

and

$$0 \longrightarrow B_2 \xrightarrow{\varphi_2} B_1 \oplus B_2 \xrightarrow{\pi_1} B_1 \longrightarrow 0$$

Now  $\pi_1\varphi_1 = i_{B_1}$ , so  $F(\pi_1)F(\varphi_1) = F(\pi_1\varphi_1) = F(i_{B_1}) = i_{F(B_1)}$ . Hence,  $F(\pi_1)$  is onto and  $F(\varphi_1)$  is one-to-one. Similarly,  $F(\pi_2)$  is onto and  $F(\varphi_2)$  is one-to-one. But this means that the sequences

$$0 \longrightarrow F(B_1) \xrightarrow{F(\varphi_1)} F(B_1 \oplus B_2) \xrightarrow{F(\pi_2)} F(B_2) \longrightarrow 0$$

and

$$0 \longrightarrow F(B_2) \xrightarrow{F(\varphi_2)} F(B_1 \oplus B_2) \xrightarrow{F(\pi_1)} F(B_1) \longrightarrow 0$$

are exact at every slot *except* the middle if  $F$  is *any* covariant functor. Thus, if  $F$  is half exact, these two sequences are exact. They are also split exact (both  $F(\pi_1)$  and  $F(\varphi_2)$  split the top sequence; both  $F(\pi_2)$  and  $F(\varphi_1)$  split the bottom sequence), so  $F(B_1 \oplus B_2) \approx F(B_1) \oplus F(B_2)$ . Hence,  $F$  is additive by Proposition 6.1.  $\square$

Contravariant functors from  ${}_R\mathbf{M}$  to  ${}_S\mathbf{M}$  are defined to be additive if  $F(f + g) = F(f) + F(g)$ . The above considerations apply in an analogous fashion to prove: A contravariant functor  $F$  is additive if and only if  $F(B \oplus C) \approx F(B) \times F(C)$  (or  $F(B \times C) \approx F(B) \oplus F(C)$ ); the point is that arrows are reversed (see Exercise 2). Also, a half exact functor is additive.

*From here on in this chapter all functors will be assumed to be additive.*

## 6.2 Derived Functors

Left derived functors are manufactured in the same way as Ext and Tor. One starts with a projective resolution, applies the functor, deletes the righthand term, and takes homology. Right derived functors use injective resolutions.

Suppose  $F : {}_R\mathbf{M} \rightarrow {}_S\mathbf{M}$  is an (additive) covariant functor. If  $B \in {}_R\mathbf{M}$ , form a projective resolution of  $B$ :

$$\cdots \longrightarrow P_{n+1} \xrightarrow{d_{n+1}} P_n \longrightarrow \cdots \longrightarrow P_1 \xrightarrow{d_1} P_0 \xrightarrow{\pi} B \longrightarrow 0.$$

Apply  $F$ , and delete  $F(B)$ , giving (with  $d_0 = 0$ )

$$\cdots \longrightarrow F(P_{n+1}) \xrightarrow{F(d_{n+1})} F(P_n) \xrightarrow{F(d_n)} \cdots \longrightarrow F(P_1) \xrightarrow{F(d_1)} F(P_0) \xrightarrow{F(d_0)} 0.$$

This is a complex, since  $F(d_{n-1})F(d_n) = F(d_{n-1}d_n) = F(0) = 0$ . The  $n$ th homology of this complex is isomorphic to the  $n$ th left derived functor  $\mathcal{L}_n F(B)$ . That is,

$$\mathcal{L}_n F(B) \approx \ker F(d_n) / \text{im} F(d_{n+1}).$$

The considerations here are essentially those involving the definition of Tor (it really is *deja vu* time). Simply replace “ $A \otimes$ ” with “ $F$ ” (and put in parentheses) and the definition of  $\text{Tor}_n(A, \bullet)$  yields the definition of  $\mathcal{L}_n F$ .

For concreteness, as in Chapter 3, one must choose for each  $B$  a specific projective resolution and make its homology equal to  $\mathcal{L}_n F(B)$ . Also, one must prove that the  $n$ th homology is (up to isomorphism) independent of the projective resolution. Finally, to get a functor, one must show how to define, using  $f \in \text{Hom}(B, B')$ , a homomorphism  $\mathcal{L}_n F(f) : \mathcal{L}_n F(B) \rightarrow \mathcal{L}_n F(B')$ .

Suppose  $\langle P_n, d_n \rangle$  is a projective resolution of  $B$ , and  $\langle P'_n, d'_n \rangle$  is a projective resolution of  $B'$ . Given  $\varphi \in \text{Hom}(B, B')$ , construct fillers as in Proposition 3.1:

$$\begin{array}{ccccccccccccccc} \cdots & \longrightarrow & P_{n+1} & \xrightarrow{d_{n+1}} & P_n & \xrightarrow{d_n} & \cdots & \longrightarrow & P_1 & \xrightarrow{d_1} & P_0 & \xrightarrow{\pi} & B & \longrightarrow & 0 \\ & & | & & | & & & & | & & | & & | & & \\ & & \downarrow \varphi_{n+1} & & \downarrow \varphi_n & & & & \downarrow \varphi_1 & & \downarrow \varphi_0 & & \downarrow \varphi & & \\ \cdots & \longrightarrow & P'_{n+1} & \xrightarrow{d'_{n+1}} & P'_n & \xrightarrow{d'_n} & \cdots & \longrightarrow & P'_1 & \xrightarrow{d'_1} & P'_0 & \xrightarrow{\pi'} & B' & \longrightarrow & 0 \end{array}$$

and apply  $F$ , deleting  $F(B)$  and  $F(B')$ :

$$\begin{array}{ccccccccccccccc} \cdots & \longrightarrow & F(P_{n+1}) & \xrightarrow{F(d_{n+1})} & F(P_n) & \xrightarrow{F(d_n)} & \cdots & \longrightarrow & F(P_1) & \xrightarrow{F(d_1)} & F(P_0) & \longrightarrow & 0 \\ & & \downarrow F(\varphi_{n+1}) & & \downarrow F(\varphi_n) & & & & \downarrow F(\varphi_1) & & \downarrow F(\varphi_0) & & \\ \cdots & \longrightarrow & F(P'_{n+1}) & \xrightarrow{F(d'_{n+1})} & F(P'_n) & \xrightarrow{F(d'_n)} & \cdots & \longrightarrow & F(P'_1) & \xrightarrow{F(d'_1)} & F(P'_0) & \longrightarrow & 0 \end{array}$$

Since the vertical arrows are chain maps of chain complexes, one obtains maps from the homology of the top complex to the homology of the bottom complex. These will be (isomorphic to)  $\mathcal{L}_n F(\varphi)$ .

The homotopy part of Proposition 3.1 guarantees that the homology homomorphisms will be independent of the choice of fillers  $\varphi_n$ . If  $\varphi'_n$  also serve as fillers:

$$\begin{aligned} F(\varphi_n) - F(\varphi'_n) &= F(\varphi_n - \varphi'_n) && (F \text{ is additive}) \\ &= F(d'_{n+1}D_n + D_{n-1}d_n) \\ &= F(d'_{n+1}D_n) + F(D_{n-1}d_n) && (\text{ditto}) \\ &= F(d'_{n+1})F(D_n) + F(D_{n-1})F(d_n). \end{aligned}$$

Hence, the  $F(\varphi_n)$  and  $F(\varphi'_n)$  are homotopic. Applying Proposition 3.1 twice to projective resolutions  $\langle P_n, d_n \rangle$  and  $\langle P'_n, d'_n \rangle$  of  $B$  yields

$$\begin{array}{ccccccccccccccc} \longrightarrow & P_{n+1} & \xrightarrow{d_{n+1}} & P_n & \xrightarrow{d_n} & \cdots & \longrightarrow & P_1 & \xrightarrow{d_1} & P_0 & \xrightarrow{\pi} & B & \longrightarrow & 0 \\ & \downarrow \varphi_{n+1} & & \downarrow \varphi_n & & & & \downarrow \varphi_1 & & \downarrow \varphi_0 & & \downarrow i_B & & \\ \longrightarrow & P'_{n+1} & \xrightarrow{d'_{n+1}} & P'_n & \xrightarrow{d'_n} & \cdots & \longrightarrow & P'_1 & \xrightarrow{d'_1} & P'_0 & \xrightarrow{\pi'} & B & \longrightarrow & 0 \\ & \downarrow \psi_{n+1} & & \downarrow \psi_n & & & & \downarrow \psi_1 & & \downarrow \psi_0 & & \downarrow i_B & & \\ \longrightarrow & P_{n+1} & \xrightarrow{d_{n+1}} & P_n & \xrightarrow{d_n} & \cdots & \longrightarrow & P_1 & \xrightarrow{d_1} & P_0 & \xrightarrow{\pi} & B & \longrightarrow & 0 \end{array}$$

Hence, both  $\langle \psi_n \varphi_n \rangle$  and  $\langle i_{P_n} \rangle$  serve as fillers for

$$\begin{array}{ccccccccccccccc} \longrightarrow & P_{n+1} & \xrightarrow{d_{n+1}} & P_n & \xrightarrow{d_n} & \cdots & \longrightarrow & P_1 & \xrightarrow{d_1} & P_0 & \xrightarrow{\pi} & B & \longrightarrow & 0 \\ & \downarrow \psi_{n+1} & & \downarrow \psi_n & & & & \downarrow \psi_1 & & \downarrow \psi_0 & & \downarrow i_B & & \\ \longrightarrow & P_{n+1} & \xrightarrow{d_{n+1}} & P_n & \xrightarrow{d_n} & \cdots & \longrightarrow & P_1 & \xrightarrow{d_1} & P_0 & \xrightarrow{\pi} & B & \longrightarrow & 0 \end{array}$$



and so are homotopic. Thus, the maps induced by  $\varphi_n$  and by  $\psi_n$  on homology (call them  $\varphi_{n*}$  and  $\psi_{n*}$ ) satisfy the equation  $\psi_{n*}\varphi_{n*} = i_{P_n*}$ . Reversing the roles of  $\langle P_n, d_n \rangle$  and  $\langle P'_n, d'_n \rangle$  yields that  $\varphi_{n*}\psi_{n*} = i_{P'_n*}$ . Thus, the homology of the complex

$$\longrightarrow F(P_{n+1}) \xrightarrow{F(d_{n+1})} F(P_n) \xrightarrow{F(d_n)} \cdots \longrightarrow F(P_1) \xrightarrow{F(d_1)} F(P_0) \xrightarrow{F(d_0)} 0$$

is independent of the projective resolution up to isomorphism.

Since fillers for consecutive resolutions can be composed, we get that  $\mathcal{L}_n F$  is a functor.

Now suppose  $F$  is a contravariant functor—again additive. Our construction of  $\mathcal{L}^n F$  now mimics the construction of  $\text{Ext}(\bullet, C)$ . (We use a superscript since  $\mathcal{L}^n F$  will be contravariant.) Apply  $F$  to a projective resolution of  $B$  and delete  $F(B)$ :

$$\cdots \longleftarrow F(P_{n+1}) \xleftarrow{F(d_{n+1})} F(P_n) \xleftarrow{F(d_n)} \cdots \longleftarrow F(P_1) \xleftarrow{F(d_1)} F(P_0) \xleftarrow{F(d_0)} 0.$$

The homology at  $F(P_n)$  is  $\mathcal{L}^n F$  (literally, if the projective resolution is the “chosen” one; up to isomorphism otherwise). The arguments parallel those for covariant functors, with arrows reversed.

Right derived functors are defined using injective resolutions. Suppose  $F$  is a covariant functor from  ${}_R\mathbf{M}$  to  ${}_S\mathbf{M}$ , and suppose  $B \in {}_R\mathbf{M}$ . Choose an injective resolution of  $B$ :

$$0 \rightarrow B \xrightarrow{\iota} E_0 \xrightarrow{d_1} E_1 \xrightarrow{d_2} E_2 \xrightarrow{d_3} \cdots$$

(The choice can be made as follows. For any  $B \in {}_R\mathbf{M}$ , there exists a smallest cardinal  $\tau$  such that  $B$  can be imbedded in an injective having cardinality  $\tau$ ; set  $\tau(B)$  equal to this  $\tau$ .  $\tau(B)$  is a set; using the axiom of choice from Gödel–Bernays–von Neumann class theory, in which a choice function is defined on the class of nonempty sets, choose a structure on the set  $\tau(B)$  itself making it into an injective left  $R$ -module  $E(B)$ , and choose a one-to-one homomorphism  $\iota : B \rightarrow E(B)$ . Set  $E_0 = E(B)$ ,  $E_1 = E(E_0/\iota(B))$ , etc.) Apply  $F$  and drop  $F(B)$ , giving the complex

$$0 \longrightarrow F(E_0) \xrightarrow{F(d_1)} F(E_1) \xrightarrow{F(d_2)} F(E_2) \xrightarrow{F(d_3)} \cdots$$

The homology at the  $n$ th entry  $F(E_n)$  will be  $\mathcal{R}_n F(B)$ . Thanks to Exercise 7 of Chapter 3, an argument can be constructed resembling that for  $\mathcal{L}_n F$  to show that  $\mathcal{R}_n F$  is, up to isomorphism, independent of the injective resolution; also,  $\mathcal{R}_n F$  is a covariant functor. Finally, if  $F$  is contravariant, one forms  $\mathcal{R}^n F$  from the homology at  $F(E_n)$  of

$$0 \longleftarrow F(E_0) \xleftarrow{F(d_1)} F(E_1) \xleftarrow{F(d_2)} F(E_2) \xleftarrow{F(d_3)} \cdots$$

It might be noted here that all derived functors are additive; fillers for sums  $\varphi + \psi : B \rightarrow C$  can be added. We will get this free in the next section, where the long exact sequence for derived functors appears. It will then follow that all derived functors are half exact, hence additive by Proposition 6.2 (and its contravariant version).

We close with the analog of Proposition 3.2, giving the elementary properties of derived functors.

**Proposition 6.3** *Suppose  $F$  is an additive functor from  ${}_R\mathbf{M}$  to  ${}_S\mathbf{M}$ .*

- a) *If  $F$  is covariant and right exact, then  $\mathcal{L}_0F(B) \approx F(B)$  for all  $B \in {}_R\mathbf{M}$ .*
- b) *If  $F$  is covariant and left exact, then  $\mathcal{R}_0F(B) \approx F(B)$  for all  $B \in {}_R\mathbf{M}$ .*
- c) *If  $F$  is contravariant and left exact, then  $\mathcal{L}^0F(B) \approx F(B)$  for all  $B \in {}_R\mathbf{M}$ .*
- d) *If  $F$  is contravariant and right exact, then  $\mathcal{R}^0F(B) \approx F(B)$  for all  $B \in {}_R\mathbf{M}$ .*
- e) *If  $F$  is covariant, then  $\mathcal{L}_nF(P) = 0$  for all projectives  $P \in {}_R\mathbf{M}$ ,  $n > 0$ .*
- f) *If  $F$  is covariant, then  $\mathcal{R}_nF(E) = 0$  for all injectives  $E \in {}_R\mathbf{M}$ ,  $n > 0$ .*
- g) *If  $F$  is contravariant, then  $\mathcal{L}^nF(P) = 0$  for all projectives  $P \in {}_R\mathbf{M}$ ,  $n > 0$ .*
- h) *If  $F$  is contravariant, then  $\mathcal{R}^nF(E) = 0$  for all injectives  $E \in {}_R\mathbf{M}$ ,  $n > 0$ .*

**Proof:** (Sketch) The proofs for Proposition 3.2 can be suitably modified for the covariant cases. To see this, consider (a). Since  $F$  is right exact,

$$F(P_1) \xrightarrow{F(d_1)} F(P_0) \xrightarrow{F(\pi)} F(B) \longrightarrow 0$$

is exact. Hence  $F(B) \approx F(P_0)/\text{im}F(d_1) = \mathcal{L}_0F(B)$ .

That was the first part of the proof of Proposition 3.2, with  $F$  replacing  $A \otimes$ , and  $\mathcal{L}_0F$  replacing  $\text{Tor}_0(A, \bullet)$ .

Contravariant functors work the same way, with some arrows reversed.  $\square$

The above proof outlines should be examined. Most (but not all) of the time, there will really be four results, one for left derived covariant functors, one for left derived contravariant functors, one for right derived covariant functors, and one for right derived contravariant functors. Most (but not all) of the time the proofs will be similar. Finally, in this section

the constructions resembled those for Ext and Tor; that will change in the next section. When forming derived functors, one usually does not have a second factor to resolve, a gimmick used in Chapter 3 to derive the long exact sequences.

### 6.3 Long Exact Sequences—I. Existence

The objective of this section is to obtain the long exact sequences for derived functors. This involves considerations that did not arise in Chapter 3, since now there is only one entry in our functor.

To start with, we want to assemble a short exact sequence of projective (or injective) resolutions from a short exact sequence of left  $R$ -modules. That is, given a short exact sequence  $0 \rightarrow B \rightarrow B' \rightarrow B'' \rightarrow 0$ , we want to manufacture (somehow) an exact array

$$\begin{array}{ccccccc}
 & & 0 & & 0 & & 0 & & 0 & & \\
 & & \downarrow & & \downarrow & & \downarrow & & \downarrow & & \\
 \cdots & \rightarrow & P_2 & \rightarrow & P_1 & \rightarrow & P_0 & \rightarrow & B & \rightarrow & 0 \\
 & & \downarrow & & \downarrow & & \downarrow & & \downarrow & & \\
 \cdots & \rightarrow & P'_2 & \rightarrow & P'_1 & \rightarrow & P'_0 & \rightarrow & B' & \rightarrow & 0 \\
 & & \downarrow & & \downarrow & & \downarrow & & \downarrow & & \\
 \cdots & \rightarrow & P''_2 & \rightarrow & P''_1 & \rightarrow & P''_0 & \rightarrow & B'' & \rightarrow & 0 \\
 & & \downarrow & & \downarrow & & \downarrow & & \downarrow & & \\
 & & 0 & & 0 & & 0 & & 0 & & 
 \end{array}$$

in such a way that when we apply  $F$  and delete, then

$$\begin{array}{ccccccc}
 & & 0 & & 0 & & 0 & & \\
 & & \downarrow & & \downarrow & & \downarrow & & \\
 \cdots & \rightarrow & F(P_2) & \rightarrow & F(P_1) & \rightarrow & F(P_0) & \rightarrow & 0 \\
 & & \downarrow & & \downarrow & & \downarrow & & \\
 \cdots & \rightarrow & F(P'_2) & \rightarrow & F(P'_1) & \rightarrow & F(P'_0) & \rightarrow & 0 \\
 & & \downarrow & & \downarrow & & \downarrow & & \\
 \cdots & \rightarrow & F(P''_2) & \rightarrow & F(P''_1) & \rightarrow & F(P''_0) & \rightarrow & 0 \\
 & & \downarrow & & \downarrow & & \downarrow & & \\
 & & 0 & & 0 & & 0 & & 
 \end{array}$$

will have exact columns. The long exact sequence of Theorem 3.1 will then give a long exact sequence:

$$\begin{array}{c}
 \cdots \\
 \longrightarrow \mathcal{L}_1 F(B) \longrightarrow \mathcal{L}_1 F(B') \longrightarrow \mathcal{L}_1 F(B'') \longrightarrow \\
 \longrightarrow \mathcal{L}_0 F(B) \longrightarrow \mathcal{L}_0 F(B') \longrightarrow \mathcal{L}_0 F(B'') \longrightarrow 0.
 \end{array}$$

To start with, note that since  $P_n''$  is projective,  $0 \rightarrow P_n \rightarrow P_n' \rightarrow P_n'' \rightarrow 0$  is split exact. Hence,  $0 \rightarrow F(P_n) \rightarrow F(P_n') \rightarrow F(P_n'') \rightarrow 0$  is split exact by Proposition 6.1, since  $F$  is additive. It follows that all we need to do is to manufacture a “simultaneous resolution” of  $B$ ,  $B'$ , and  $B''$ . Furthermore,  $P_n' \approx P_n \oplus P_n''$ , so given the resolutions of  $B$  and  $B''$ , we know what each  $P_n'$  must be.

It turns out that things will be built up recursively in the same way that projective resolutions of single objects are. The following result is the basic step in this direction for projective and injective resolutions.

**Proposition 6.4** *Suppose*

$$\begin{array}{ccc}
 0 & & 0 \\
 \downarrow & & \downarrow \\
 B_1 & \xrightarrow{\varphi_1} & C_1 \\
 \downarrow i & & \downarrow j \\
 B_2 & \xrightarrow{\varphi_2} & C_2 \\
 \downarrow p & & \downarrow q \\
 B_3 & \xrightarrow{\varphi_3} & C_3 \\
 \downarrow & & \downarrow \\
 0 & & 0
 \end{array}$$

*is commutative with exact columns. Set  $K_i = \ker \varphi_i$ , and  $L_i = C_i / \text{im } \varphi_i$ . One has an induced diagram with exact rows and columns:*

$$\begin{array}{ccccccc}
 0 & & 0 & & 0 & & \\
 \downarrow & & \downarrow & & \downarrow & & \\
 K_1 & \hookrightarrow & B_1 & \xrightarrow{\varphi_1} & C_1 & \xrightarrow{\pi_1} & L_1 \\
 \downarrow i' & & \downarrow i & & \downarrow j & & \downarrow \bar{j} \\
 K_2 & \hookrightarrow & B_2 & \xrightarrow{\varphi_2} & C_2 & \xrightarrow{\pi_2} & L_2 \\
 \downarrow p' & & \downarrow p & & \downarrow q & & \downarrow \bar{q} \\
 K_3 & \hookrightarrow & B_3 & \xrightarrow{\varphi_3} & C_3 & \xrightarrow{\pi_3} & L_3 \\
 & & \downarrow & & \downarrow & & \downarrow \\
 & & 0 & & 0 & & 0
 \end{array}$$

*Furthermore, the following are equivalent:*

- i)  $p'$  is onto.
- ii)  $\bar{j}$  is one-to-one.
- iii) There exists an extension of the original diagram to the left,

$$\begin{array}{ccccc}
 & 0 & & 0 & & 0 \\
 & \downarrow & & \downarrow & & \downarrow \\
 A_1 & \longrightarrow & B_1 & \longrightarrow & C_1 \\
 & \downarrow & & \downarrow & & \downarrow \\
 A_2 & \longrightarrow & B_2 & \longrightarrow & C_2 \\
 & \downarrow & & \downarrow & & \downarrow \\
 A_3 & \longrightarrow & B_3 & \longrightarrow & C_3 \\
 & \downarrow & & \downarrow & & \downarrow \\
 & 0 & & 0 & & 0
 \end{array}$$

having exact rows and columns.

- iv) There exists an extension of the original diagram to the right,

$$\begin{array}{ccccc}
 & 0 & & 0 & & 0 \\
 & \downarrow & & \downarrow & & \downarrow \\
 B_1 & \longrightarrow & C_1 & \longrightarrow & D_1 \\
 & \downarrow & & \downarrow & & \downarrow \\
 B_2 & \longrightarrow & C_2 & \longrightarrow & D_2 \\
 & \downarrow & & \downarrow & & \downarrow \\
 B_3 & \longrightarrow & C_3 & \longrightarrow & D_3 \\
 & \downarrow & & \downarrow & & \downarrow \\
 & 0 & & 0 & & 0
 \end{array}$$

having exact rows and columns.

**Proof:** Consider

$$\begin{array}{cccccccc}
 & 0 & & 0 & & 0 & & 0 & & 0 & & 0 \\
 & \downarrow & & \downarrow & & \downarrow & & \downarrow & & \downarrow & & \downarrow \\
 \dots & \longrightarrow & 0 & \longrightarrow & 0 & \longrightarrow & B_1 & \longrightarrow & C_1 & \longrightarrow & 0 & \longrightarrow & 0 & \longrightarrow & \dots \\
 & \downarrow & & \downarrow & & \downarrow & & \downarrow & & \downarrow & & \downarrow & & \downarrow & \\
 \dots & \longrightarrow & 0 & \longrightarrow & 0 & \longrightarrow & B_2 & \longrightarrow & C_2 & \longrightarrow & 0 & \longrightarrow & 0 & \longrightarrow & \dots \\
 & \downarrow & & \downarrow & & \downarrow & & \downarrow & & \downarrow & & \downarrow & & \downarrow & \\
 \dots & \longrightarrow & 0 & \longrightarrow & 0 & \longrightarrow & B_3 & \longrightarrow & C_3 & \longrightarrow & 0 & \longrightarrow & 0 & \longrightarrow & \dots \\
 & \downarrow & & \downarrow & & \downarrow & & \downarrow & & \downarrow & & \downarrow & & \downarrow & \\
 & 0 & & 0 & & 0 & & 0 & & 0 & & 0 & & 0 & 
 \end{array}$$

Rows are complexes and columns are short exact. Homology at  $B_j$  is  $K_j$ , while homology at  $C_j$  is  $L_j$ . The long homology exact sequence (Theorem



3.3) produces the exact sequence:

$$0 \longrightarrow K_1 \xrightarrow{i'} K_2 \xrightarrow{p'} K_3 \xrightarrow{\delta} L_1 \xrightarrow{\bar{j}} L_2 \xrightarrow{\bar{q}} L_3 \longrightarrow 0.$$

(This is sometimes called the *ker-coker exact sequence*.)

Implicit in all this is that  $i(K_1) \subset K_2$ , so that  $i'$  is defined;  $p(K_2) \subset K_3$  so that  $p'$  is defined; etc. We now have exactness of the columns containing  $K$ 's and  $L$ 's.

Furthermore,  $p'$  is onto  $\Leftrightarrow \delta = 0 \Leftrightarrow \bar{j}$  is one-to-one, so (i)  $\Leftrightarrow$  (ii). Clearly (i)  $\Rightarrow$  (iii) by setting  $A_j = K_j$ , and (ii)  $\Rightarrow$  (iv) by setting  $D_j = L_j$ . It remains to show (iii)  $\Rightarrow$  (ii) (and (iv)  $\Rightarrow$  (i)).

Suppose (iii), and extend again:

$$\begin{array}{cccccccccccc}
 & 0 & & 0 & & 0 & & 0 & & 0 & & 0 & & 0 & & 0 & & 0 & & 0 \\
 & \downarrow & & \downarrow & & \downarrow & & \downarrow & & \downarrow & & \downarrow & & \downarrow & & \downarrow & & \downarrow & & \downarrow \\
 \dots & \longrightarrow & 0 & \longrightarrow & 0 & \longrightarrow & A_1 & \longrightarrow & B_1 & \longrightarrow & C_1 & \longrightarrow & 0 & \longrightarrow & 0 & \longrightarrow & \dots & & \dots \\
 & \downarrow & & \downarrow & & \downarrow & & \downarrow & & \downarrow & & \downarrow & & \downarrow & & \downarrow & & \downarrow & & \downarrow \\
 \dots & \longrightarrow & 0 & \longrightarrow & 0 & \longrightarrow & A_2 & \longrightarrow & B_2 & \longrightarrow & C_2 & \longrightarrow & 0 & \longrightarrow & 0 & \longrightarrow & \dots & & \dots \\
 & \downarrow & & \downarrow & & \downarrow & & \downarrow & & \downarrow & & \downarrow & & \downarrow & & \downarrow & & \downarrow & & \downarrow \\
 \dots & \longrightarrow & 0 & \longrightarrow & 0 & \longrightarrow & A_3 & \longrightarrow & B_3 & \longrightarrow & C_3 & \longrightarrow & 0 & \longrightarrow & 0 & \longrightarrow & \dots & & \dots \\
 & \downarrow & & \downarrow & & \downarrow & & \downarrow & & \downarrow & & \downarrow & & \downarrow & & \downarrow & & \downarrow & & \downarrow \\
 & & & 0 & & 0 & & 0 & & 0 & & 0 & & 0 & & 0 & & 0 & & 0
 \end{array}$$

Homology at  $C_j$  is  $L_j$  and homology at  $B_j$  is now zero. A piece of the long homology exact sequence (Theorem 3.3) gives  $0 \rightarrow L_1 \rightarrow L_2 \rightarrow L_3 \rightarrow 0$ . Hence, (ii).

(iv)  $\Rightarrow$  (i) is similar, and is left to the reader. □

**Example 12**

$$\begin{array}{ccc}
 0 & & 0 \\
 \downarrow & & \downarrow \\
 \mathbb{Z} & \xrightarrow{\quad} & \mathbb{Q} \\
 \downarrow \times 2 & & \downarrow \times 2 \\
 \mathbb{Z} & \xrightarrow{\quad} & \mathbb{Q} \\
 \downarrow & & \downarrow \\
 \mathbb{Z}_2 & \xrightarrow{\quad} & 0 \\
 \downarrow & & \downarrow \\
 0 & & 0
 \end{array}$$

gives



is commutative with exact rows and columns. (The vertical maps are the obvious ones.)

b) Given injective resolutions of  $B$  and  $B''$ ,

$$\begin{array}{ccccccc}
 & & 0 & & & & \\
 & & \downarrow & & & & \\
 0 & \longrightarrow & B & \xrightarrow{\iota} & E_0 & \xrightarrow{d_1} & E_1 & \xrightarrow{d_2} & E_2 & \xrightarrow{d_3} & \cdots \\
 & & \downarrow & & & & & & & & \\
 & & B' & & & & & & & & \\
 & & \downarrow & & & & & & & & \\
 0 & \longrightarrow & B'' & \xrightarrow{\iota''} & E''_0 & \xrightarrow{d''_1} & E''_1 & \xrightarrow{d''_2} & E''_2 & \xrightarrow{d''_3} & \cdots \\
 & & \downarrow & & & & & & & & \\
 & & 0 & & & & & & & & 
 \end{array}$$

there exist maps  $\iota' : B' \rightarrow E_0 \oplus E''_0$  and  $d'_n : E_{n-1} \oplus E''_{n-1} \rightarrow E_n \oplus E''_n$  such that

$$\begin{array}{cccccccccccc}
 & & 0 & & 0 & & 0 & & 0 & & & & \\
 & & \downarrow & & \downarrow & & \downarrow & & \downarrow & & & & \\
 0 & \longrightarrow & B & \xrightarrow{\iota} & E_0 & \xrightarrow{d_1} & E_1 & \xrightarrow{d_2} & E_2 & \longrightarrow & \cdots & & \\
 & & \downarrow & & \downarrow & & \downarrow & & \downarrow & & & & \\
 0 & \longrightarrow & B' & \xrightarrow{\iota'} & E_0 \oplus E''_0 & \xrightarrow{d'_1} & E_1 \oplus E''_1 & \xrightarrow{d'_2} & E_2 \oplus E''_2 & \longrightarrow & \cdots & & \\
 & & \downarrow & & \downarrow & & \downarrow & & \downarrow & & & & \\
 0 & \longrightarrow & B'' & \xrightarrow{\iota''} & E''_0 & \xrightarrow{d''_1} & E''_1 & \xrightarrow{d''_2} & E''_2 & \longrightarrow & \cdots & & \\
 & & \downarrow & & \downarrow & & \downarrow & & \downarrow & & & & \\
 & & 0 & & 0 & & 0 & & 0 & & & & 
 \end{array}$$

is commutative with exact rows and columns. (The vertical maps are the obvious ones.)

**Proof:** We do (a); (b) is similar and is left as an exercise (Exercise 7). First,  $\pi'$ . We find a filler  $f$  using projectivity of  $P''_0$ :

$$\begin{array}{ccccc}
 & & 0 & & \\
 & & \downarrow & & \\
 P_0 & \xrightarrow{\pi} & B & \longrightarrow & 0 \\
 & & \downarrow j & & \\
 & & B' & & \\
 & & \downarrow p & & \\
 P''_0 & \xrightarrow{\pi''} & B'' & \longrightarrow & 0 \\
 & & \downarrow & & \\
 & & 0 & & 
 \end{array}$$

$f$  is a map from  $P''_0$  to  $B'$  such that  $f \circ \pi'' = j \circ \pi$ .

Set  $\pi'(x_0, x_0'') = j\pi(x_0) + f(x_0'')$ . In the diagram

$$\begin{array}{ccccc}
 0 & & 0 & & \\
 \downarrow & & \downarrow & & \\
 P_0 & \xrightarrow{\pi} & B & \longrightarrow & 0 \\
 \downarrow & & \downarrow j & & \\
 P_0 \oplus P_0'' & \xrightarrow{\pi'} & B' & & \\
 \downarrow & & \downarrow p & & \\
 P_0'' & \xrightarrow{\pi''} & B'' & \longrightarrow & 0 \\
 \downarrow & & \downarrow & & \\
 0 & & 0 & & 
 \end{array}$$

$\pi'(x_0, 0) = j\pi(x_0)$ , while  $p\pi'(x_0, x_0'') = p(j\pi(x_0) + f(x_0'')) = pj\pi(x_0) + pf(x_0'') = 0 + \pi''(x_0'') = \pi''(x_0'')$ . That is, the diagram commutes. Hence  $\pi'$  is onto by the short 5-lemma (Chapter 2, Exercise 14(b)).

To construct  $d'_n$  recursively, given  $\pi'$  and  $d'_0, \dots, d'_{n-1}$ , let  $K_n, K'_n, K''_n$  be the  $n$ th kernels:

$$\begin{array}{ccccccc}
 0 & & 0 & & 0 & & \\
 \downarrow & & \downarrow & & \downarrow & & \\
 K_n & \longrightarrow & P_{n-1} & \longrightarrow & P_{n-2} & & \\
 \downarrow & & \downarrow & & \downarrow & & \\
 K'_n & \longrightarrow & P_{n-1} \oplus P''_{n-1} & \longrightarrow & P_{n-2} \oplus P''_{n-2} & & \\
 \downarrow & & \downarrow & & \downarrow & & \\
 K''_n & \longrightarrow & P''_{n-1} & \longrightarrow & P''_{n-2} & & \\
 \downarrow & & \downarrow & & \downarrow & & \\
 0 & & 0 & & 0 & & 
 \end{array}$$

The left hand column is exact by Proposition 6.4 (condition(iv) is satisfied). We now have

$$\begin{array}{ccccc}
 0 & & 0 & & \\
 \downarrow & & \downarrow & & \\
 P_n & \xrightarrow{d_n} & K_n & \longrightarrow & 0 \\
 \downarrow & & \downarrow & & \\
 P_n \oplus P''_n & & K'_n & & \\
 \downarrow & \nearrow f & \downarrow & & \\
 P''_n & \xrightarrow{d'_n} & K''_n & \longrightarrow & 0 \\
 \downarrow & & \downarrow & & \\
 0 & & 0 & & 
 \end{array}$$

By the earlier argument constructing  $\pi'$ , the filler  $d'_n$  defined by  $d'_n(x, x'') = (d_n(x), 0) + f(x'')$  has the required properties. (See Exercise 6.)  $\square$

**Example 13**  $B = B'' = \mathbb{Z}_2$ ,  $R = B' = \mathbb{Z}_4$

$$\begin{array}{ccccccc}
 & & 0 & & 0 & & 0 \\
 & & \downarrow & & \downarrow & & \downarrow \\
 \cdots & \xrightarrow{\times 2} & \mathbb{Z}_4 & \xrightarrow{\times 2} & \mathbb{Z}_4 & \longrightarrow & \mathbb{Z}_2 \longrightarrow 0 \\
 & & \downarrow & & \downarrow & & \downarrow \\
 \cdots & \xrightarrow{d'_2} & \mathbb{Z}_4 \oplus \mathbb{Z}_4 & \xrightarrow{d'_1} & \mathbb{Z}_4 \oplus \mathbb{Z}_4 & \xrightarrow{\pi'} & \mathbb{Z}_4 \longrightarrow 0 \\
 & & \downarrow & & \downarrow & & \downarrow \\
 \cdots & \xrightarrow{\times 2} & \mathbb{Z}_4 & \xrightarrow{\times 2} & \mathbb{Z}_4 & \longrightarrow & \mathbb{Z}_2 \longrightarrow 0 \\
 & & \downarrow & & \downarrow & & \downarrow \\
 & & 0 & & 0 & & 0
 \end{array}$$

$\pi'(x, y) = 2x \pm y$ ;  $d'_n(x, y) = (2x \pm y, 2y)$  all  $n$ . (See Exercise 9.) The differentials down the middle are *not*  $d_n \oplus d''_n$ .

In general, if  $0 \rightarrow B \rightarrow B' \rightarrow B'' \rightarrow 0$  is not split, then the  $d'_n$  will not be "diagonal," that is,  $d'_n \neq d_n \oplus d''_n$ . (See Exercise 8.)

As a corollary to Proposition 6.5, we have the long exact sequences for derived functors. These results are too important to be called a corollary.

**Theorem 6.6** Suppose  $F: {}_R\mathbf{M} \rightarrow {}_S\mathbf{M}$  is a functor, and  $0 \rightarrow B \rightarrow B' \rightarrow B'' \rightarrow 0$  is short exact in  ${}_R\mathbf{M}$ .

a) If  $F$  is covariant, then there is a long exact sequence

$$\begin{array}{ccccccc}
 & & \cdots \longrightarrow \mathcal{L}_{n+1}F(B'') & \xrightarrow{\quad} & & & \delta_{n+1} \\
 & & & & & & \uparrow \\
 & & \mathcal{L}_nF(B) \longrightarrow \mathcal{L}_nF(B') \longrightarrow \mathcal{L}_nF(B'') & \xrightarrow{\quad} & & & \delta_n \\
 & & & & & & \uparrow \\
 & & \mathcal{L}_{n-1}F(B) \longrightarrow \cdots & & & & \\
 & & & & & & \uparrow \\
 & & \cdots \longrightarrow \mathcal{L}_1F(B'') & \xrightarrow{\quad} & & & \delta_1 \\
 & & & & & & \uparrow \\
 & & \mathcal{L}_0F(B) \longrightarrow \mathcal{L}_0F(B') \longrightarrow \mathcal{L}_0F(B'') \longrightarrow 0 & & & &
 \end{array}$$



b) If  $F$  is covariant, then there is a long exact sequence

$$\begin{array}{c}
 \longrightarrow \mathcal{R}_{n+1}F(B) \longrightarrow \dots \\
 \longleftarrow \delta_{n+1} \\
 \longrightarrow \mathcal{R}_nF(B) \longrightarrow \mathcal{R}_nF(B') \longrightarrow \mathcal{R}_nF(B'') \longrightarrow \\
 \longleftarrow \delta_n \\
 \dots \longrightarrow \mathcal{R}_{n-1}F(B'') \longrightarrow \\
 \longleftarrow \delta_1 \\
 \longrightarrow \mathcal{R}_1F(B) \longrightarrow \dots \\
 \longleftarrow \delta_1 \\
 0 \longrightarrow \mathcal{R}_0F(B) \longrightarrow \mathcal{R}_0F(B') \longrightarrow \mathcal{R}_0F(B'') \longrightarrow
 \end{array}$$

c) If  $F$  is contravariant, then there is a long exact sequence

$$\begin{array}{c}
 \dots \longleftarrow \mathcal{L}^{n+1}F(B'') \longleftarrow \\
 \longleftarrow \delta_{n+1} \\
 \longleftarrow \mathcal{L}^nF(B) \longleftarrow \mathcal{L}^nF(B') \longleftarrow \mathcal{L}^nF(B'') \longleftarrow \\
 \longleftarrow \delta_n \\
 \longleftarrow \mathcal{L}^{n-1}F(B) \longleftarrow \dots \longleftarrow \mathcal{L}^1F(B'') \longleftarrow \\
 \longleftarrow \delta_1 \\
 \longleftarrow \mathcal{L}^0F(B) \longleftarrow \mathcal{L}^0F(B') \longleftarrow \mathcal{L}^0F(B'') \longleftarrow 0.
 \end{array}$$

d) If  $F$  is contravariant, then there is a long exact sequence

$$\begin{array}{c}
 \longleftarrow \mathcal{R}^{n+1}F(B) \longleftarrow \dots \\
 \longleftarrow \delta_{n+1} \\
 \longleftarrow \mathcal{R}^nF(B) \longleftarrow \mathcal{R}^nF(B') \longleftarrow \mathcal{R}^nF(B'') \longleftarrow \\
 \longleftarrow \delta_n \\
 \dots \longleftarrow \mathcal{R}^{n-1}F(B'') \longleftarrow \\
 \longleftarrow \delta_1 \\
 \longleftarrow \mathcal{R}^1F(B) \longleftarrow \dots \\
 \longleftarrow \delta_1 \\
 0 \longleftarrow \mathcal{R}^0F(B) \longleftarrow \mathcal{R}^0F(B') \longleftarrow \mathcal{R}^0F(B'') \longleftarrow
 \end{array}$$

**Proof:** These all work out like the long exact sequences of Chapter 3; only (d), the right derived contravariant functors, are new, so we prove (d) only.

We have a commutative diagram by applying  $F$  to the array in Proposition 6.5(b), and deleting  $F(B)$ ,  $F(B')$ , and  $F(B'')$ :

$$\begin{array}{ccccccc}
 & & 0 & & 0 & & 0 \\
 & & \uparrow & & \uparrow & & \uparrow \\
 0 & \longleftarrow & F(E_0) & \longleftarrow & F(E_1) & \longleftarrow & F(E_2) \longleftarrow \dots \\
 & & \uparrow & & \uparrow & & \uparrow \\
 0 & \longleftarrow & F(E_0 \oplus E''_0) & \longleftarrow & F(E_1 \oplus E''_1) & \longleftarrow & F(E_2 \oplus E''_2) \longleftarrow \dots \\
 & & \uparrow & & \uparrow & & \uparrow \\
 0 & \longleftarrow & F(E''_0) & \longleftarrow & F(E''_1) & \longleftarrow & F(E''_2) \longleftarrow \dots \\
 & & \uparrow & & \uparrow & & \uparrow \\
 & & 0 & & 0 & & 0.
 \end{array}$$

Columns are (split) exact, since, for all  $n$ ,  $0 \rightarrow E_n \rightarrow E_n \oplus E''_n \rightarrow E''_n \rightarrow 0$  is split exact. Applying Theorem 3.1 yields the long exact sequence of part (d).  $\square$

**Corollary 6.7** Suppose  $F : {}_R\mathbf{M} \rightarrow {}_S\mathbf{M}$  is a functor. Then:

- If  $F$  is covariant, then  $\mathcal{L}_0 F$  is right exact, and  $\mathcal{L}_n F$  is half exact for all  $n$ .
- If  $F$  is covariant, then  $\mathcal{R}_0 F$  is left exact, and  $\mathcal{R}_n F$  is half exact for all  $n$ .
- If  $F$  is contravariant, then  $\mathcal{L}^0 F$  is left exact, and  $\mathcal{L}^n F$  is half exact for all  $n$ .
- If  $F$  is contravariant, then  $\mathcal{R}^0 F$  is right exact, and  $\mathcal{R}^n F$  is half exact for all  $n$ .

**Proof:** Again they all work out the same way; the first clause after “then” in each statement follows from the bottom row of the appropriate long exact sequence, and the second clause from the other rows.  $\square$

**Corollary 6.8** Suppose  $F : {}_R\mathbf{M} \rightarrow {}_S\mathbf{M}$  is a functor.

- If  $F$  is covariant, then  $\mathcal{L}_0 F \approx F$  if and only if  $F$  is right exact.

- b) If  $F$  is covariant, then  $\mathcal{R}_0F \approx F$  if and only if  $F$  is left exact.
- c) If  $F$  is contravariant, then  $\mathcal{L}^0F \approx F$  if and only if  $F$  is left exact.
- d) If  $F$  is contravariant, then  $\mathcal{R}^0F \approx F$  if and only if  $F$  is right exact.

**Proof:** The “only if” parts come from the left/right exactness of  $\mathcal{L}_0F/\mathcal{R}_0F$  in the preceding corollary; the “if” part restates a part of Proposition 6.3.  $\square$

For most purposes (but not all), the results of this section suffice as regards long exact sequences. There do remain two issues, however. First, naturality of the connecting homomorphisms should be established. Second, a comparison should be made with the long exact sequences of Chapter 3. These issues will occupy the next two sections.

## 6.4 Long Exact Sequences—II. Naturality

The objective of this section is to derive the naturality of the long exact sequences of Theorem 6.6. The idea is to produce a situation in which we can appeal to the naturality part of Theorem 3.3. This is accomplished by mimicking the construction in Proposition 3.1, but for short exact sequences of modules rather than individual modules. In fact, one can define a *category* of short exact sequences,  ${}_R\mathbf{Sh}$ , as follows: An object in  ${}_R\mathbf{Sh}$  is a short exact sequence  $0 \rightarrow B \rightarrow B' \rightarrow B'' \rightarrow 0$ . A morphism from  $0 \rightarrow B \rightarrow B' \rightarrow B'' \rightarrow 0$  to  $0 \rightarrow C \rightarrow C' \rightarrow C'' \rightarrow 0$  is a triplet  $(f, f', f'')$  of homomorphisms from  $\text{Hom}(B, C) \times \text{Hom}(B', C') \times \text{Hom}(B'', C'')$  such that

$$\begin{array}{ccccccccc} 0 & \longrightarrow & B & \longrightarrow & B' & \longrightarrow & B'' & \longrightarrow & 0 \\ & & \downarrow f & & \downarrow f' & & \downarrow f'' & & \\ 0 & \longrightarrow & C & \longrightarrow & C' & \longrightarrow & C'' & \longrightarrow & 0 \end{array}$$

commutes. Composition of morphisms is defined by  $(g, g', g'')(f, f', f'') = (gf, g'f', g''f'')$ . In this context, our main construction resembles (but does not coincide with) the idea that short exact sequences of projective modules behave like projectives in the category  ${}_R\mathbf{Sh}$ . We shall return to this circle of ideas in Chapter 7, as well as in the proof of Corollary 6.10.

In the next proposition, the labels on most arrows will be left out. The diagrams would almost be unreadable otherwise. Some care is needed; see Exercise 10, and the comment referring to it in the proof.

**Proposition 6.9** *Suppose given the commutative diagram*

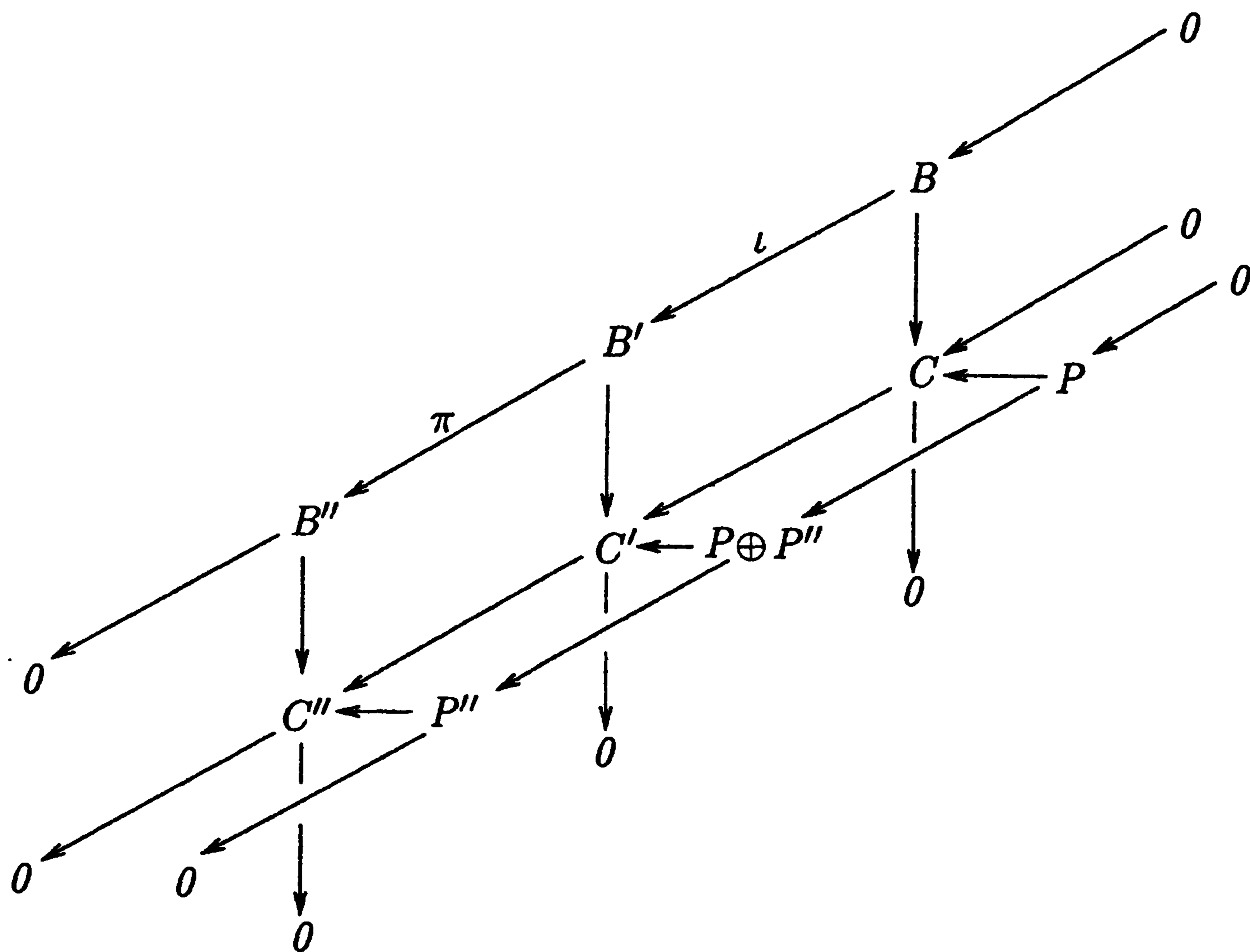

with exact columns and diagonals in  ${}_R\mathbf{M}$ , and with  $P$  and  $P''$  projective. Then there exist fillers

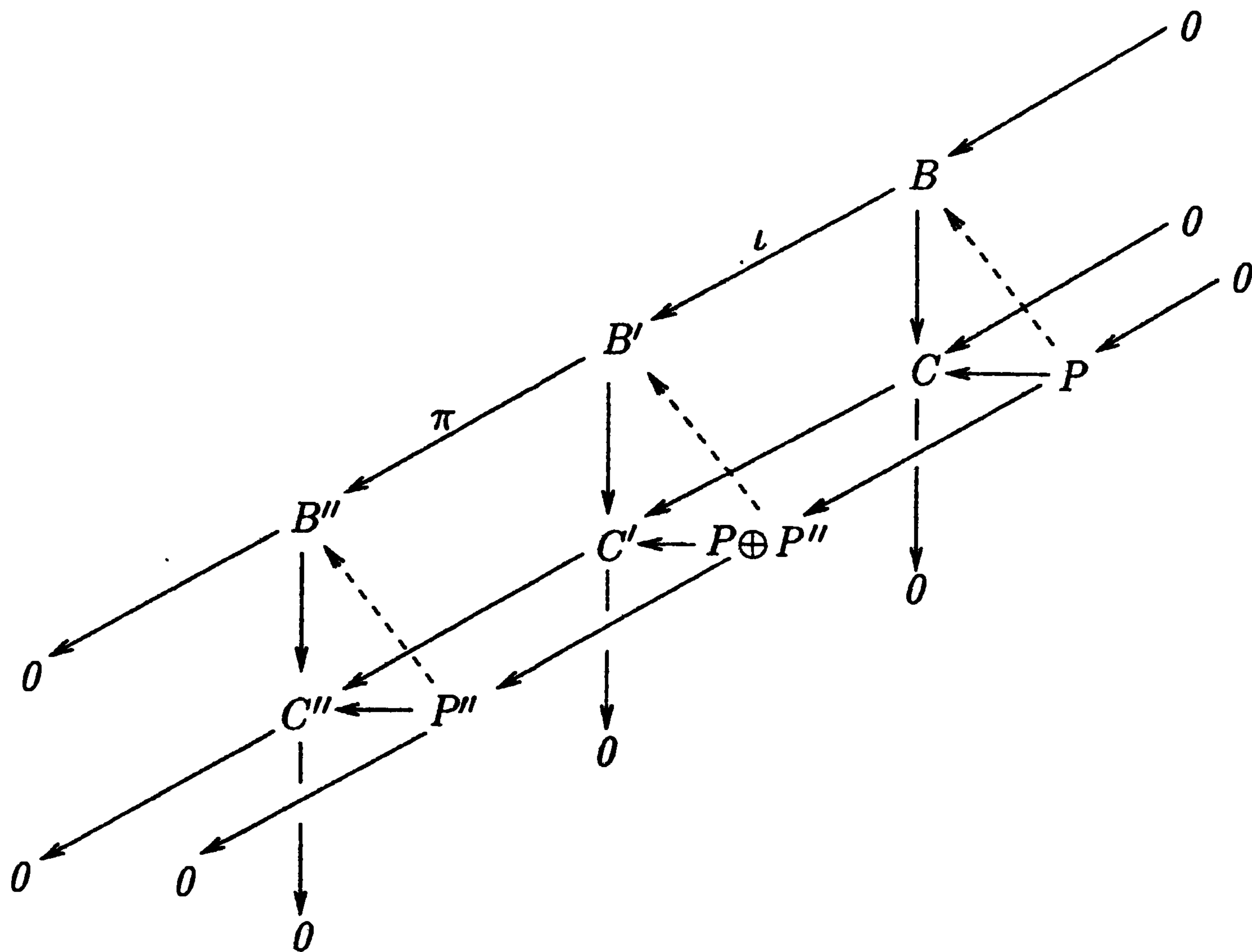

forming a commutative diagram.

**Proof:** Choose any fillers for

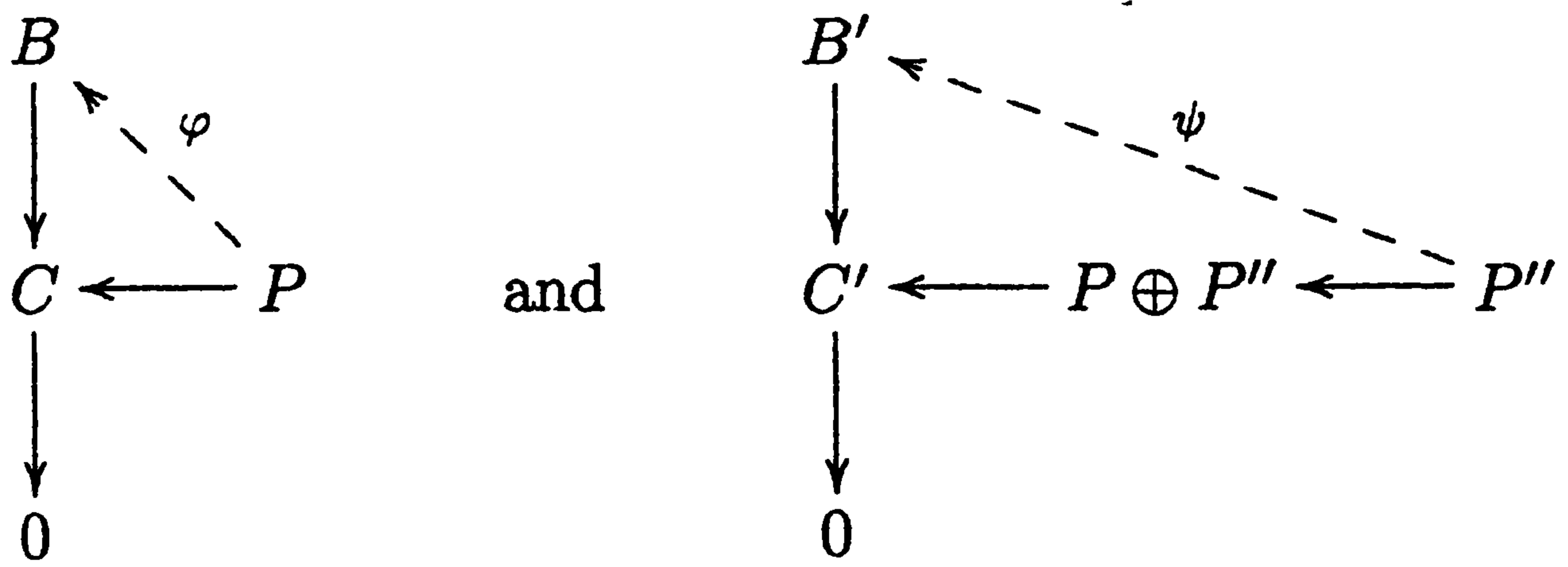

and define

$$\varphi'(x, x'') = \iota\varphi(x) + \psi(x'')$$

and

$$\varphi'' = \pi\psi.$$

Commutativity of the three-dimensional diagram follows from commutativity of the five faces containing purported fillers (three triangles and two “roof” squares).

First,



Next,

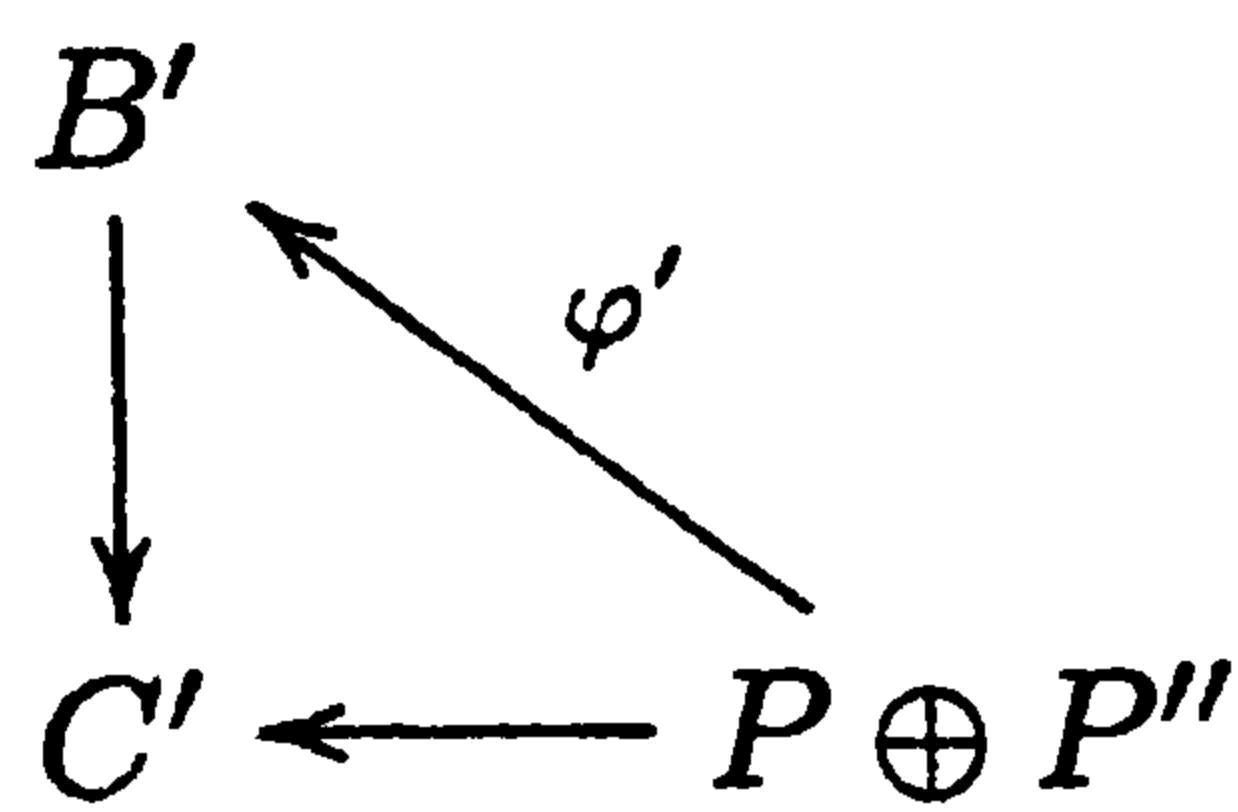

which translates into two subdiagrams,

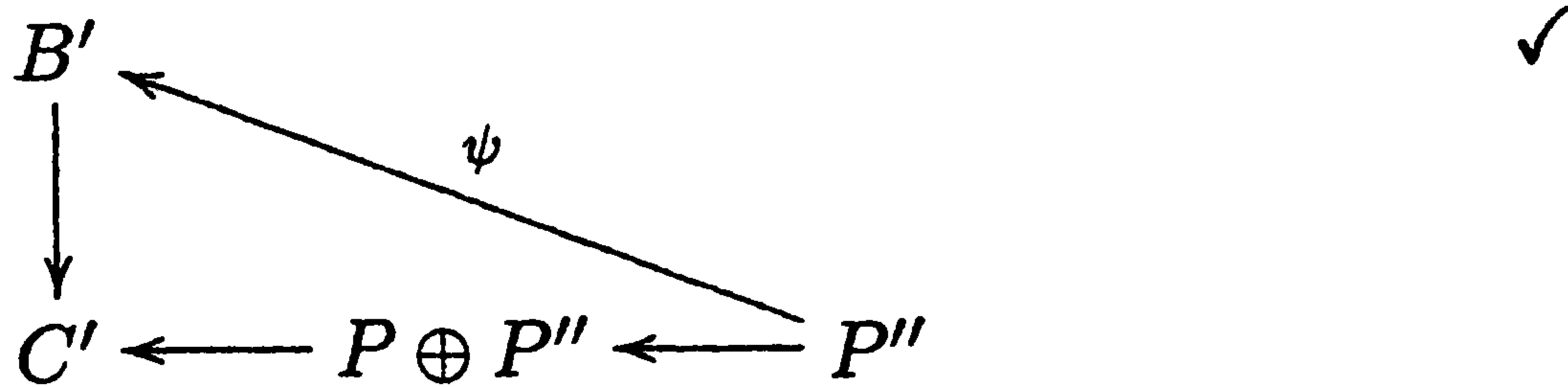

and

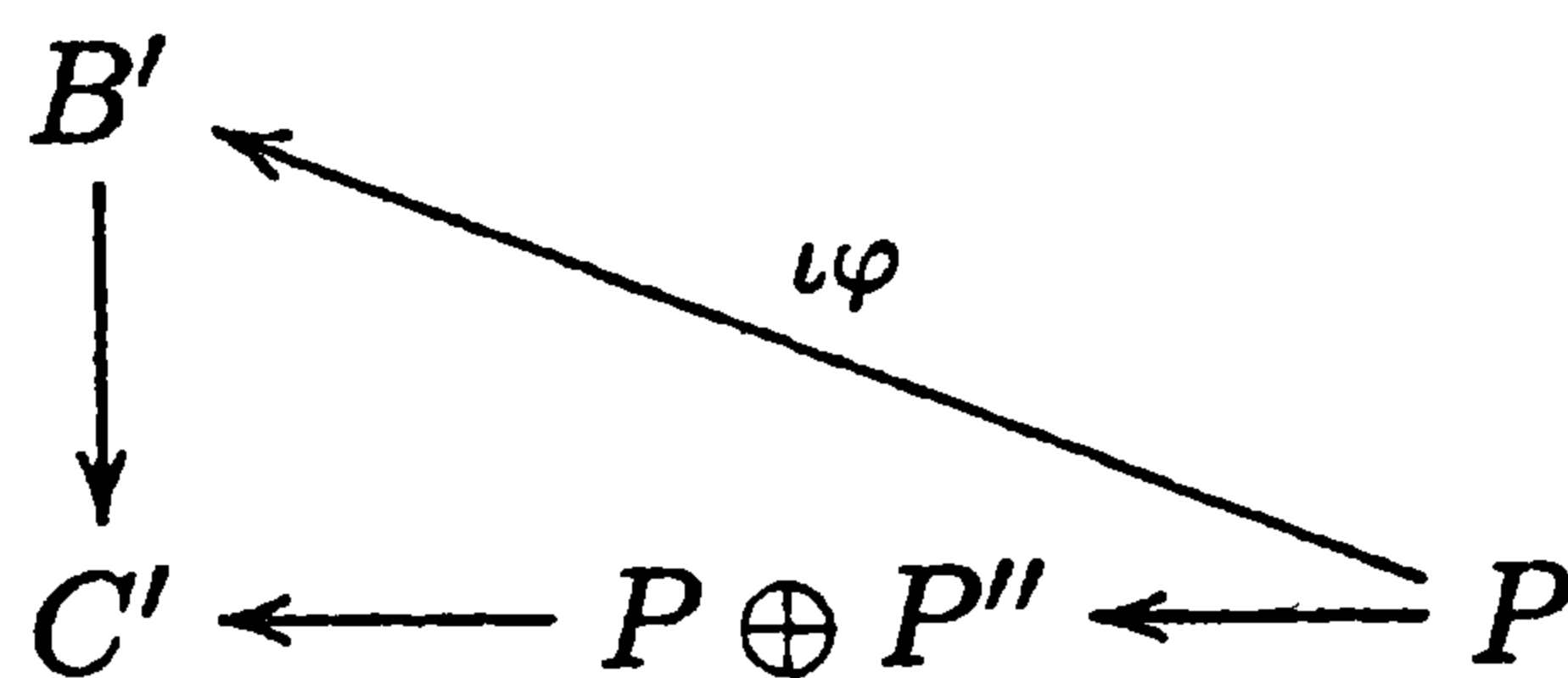





We also have the two “roof” squares,

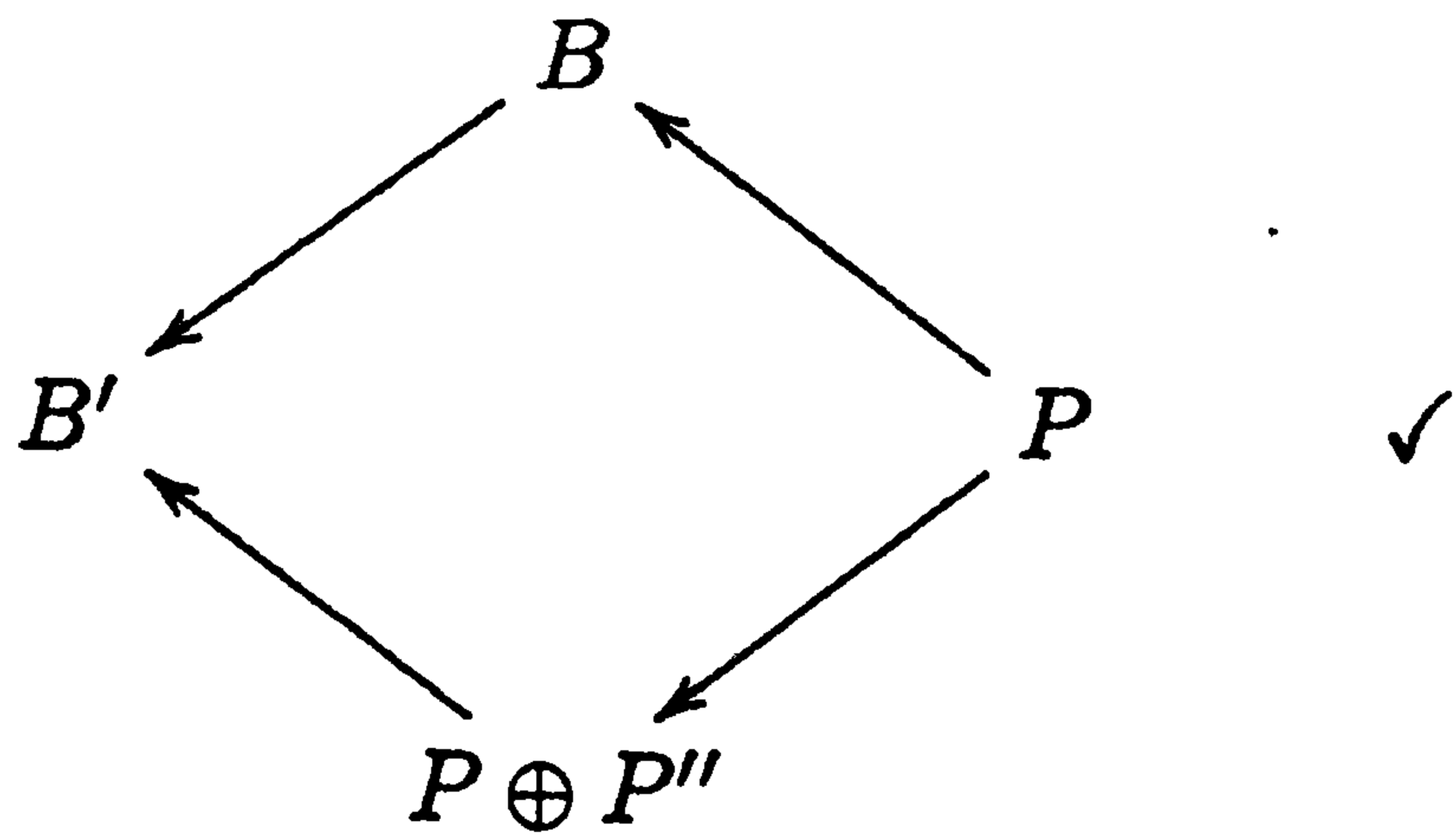

and

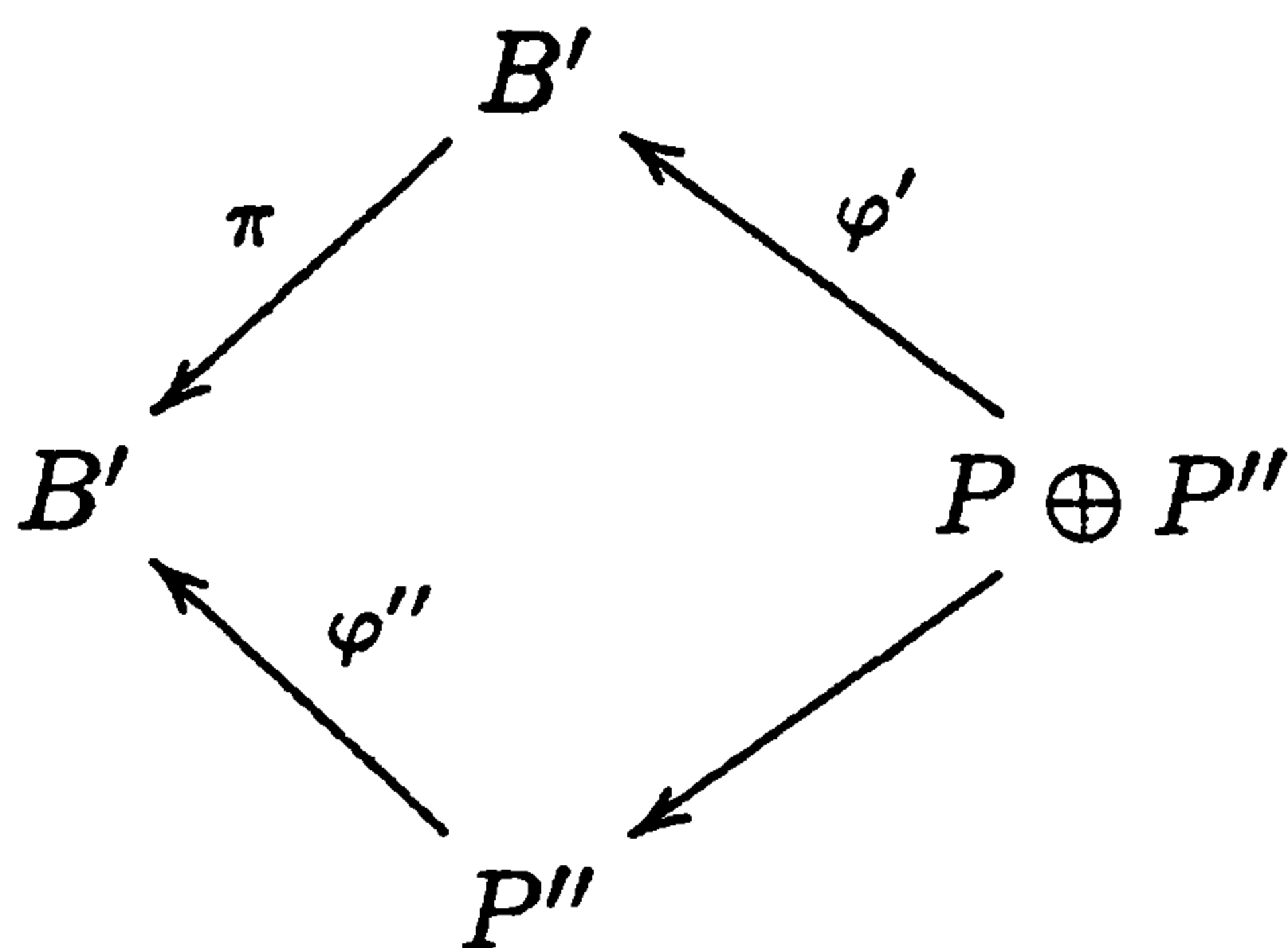

$$\pi\varphi'(x, x'') = \pi\iota\varphi(x) + \pi\psi(x'') = \pi\psi(x'') = \varphi''(x'').$$

□

**Corollary 6.10** *Suppose the diagram*

$$\begin{array}{ccccccc} 0 & \longrightarrow & B & \longrightarrow & B' & \longrightarrow & B'' & \longrightarrow & 0 \\ & & \downarrow & & \downarrow & & \downarrow & & \\ 0 & \longrightarrow & C & \longrightarrow & C' & \longrightarrow & C'' & \longrightarrow & 0 \end{array}$$

(with entries in  ${}_R\mathbf{M}$ ) is commutative, with exact rows. Then, given simultaneous projective resolutions of  $B, B', B''$  and  $C, C', C''$ , there exist fillers forming a commutative diagram with exact rows and columns:

$$\begin{array}{ccccccc}
 \vdots & & \vdots & & \vdots & & \vdots \\
 \downarrow & & \downarrow & & \downarrow & & \downarrow \\
 0 \longrightarrow & P_{n+1} & \longrightarrow & P_{n+1} \oplus P''_{n+1} & \longrightarrow & P''_{n+1} & \longrightarrow 0 \\
 & \downarrow & \searrow & \downarrow & \searrow & \downarrow & \searrow \\
 0 \longrightarrow & Q_{n+1} & \longrightarrow & Q_{n+1} \oplus Q''_{n+1} & \longrightarrow & Q''_{n+1} & \longrightarrow 0 \\
 & \downarrow & \searrow & \downarrow & \searrow & \downarrow & \searrow \\
 0 \longrightarrow & P_n & \longrightarrow & P_n \oplus P''_n & \longrightarrow & P''_n & \longrightarrow 0 \\
 & \downarrow & \searrow & \downarrow & \searrow & \downarrow & \searrow \\
 0 \longrightarrow & Q_n & \longrightarrow & Q_n \oplus Q''_n & \longrightarrow & Q''_n & \longrightarrow 0 \\
 & \downarrow & \searrow & \downarrow & \searrow & \downarrow & \searrow \\
 \vdots & & \vdots & & \vdots & & \vdots \\
 \downarrow & & \downarrow & & \downarrow & & \downarrow \\
 0 \longrightarrow & P_1 & \longrightarrow & P_1 \oplus P''_1 & \longrightarrow & P''_1 & \longrightarrow 0 \\
 & \downarrow & \searrow & \downarrow & \searrow & \downarrow & \searrow \\
 0 \longrightarrow & Q_1 & \longrightarrow & Q_1 \oplus Q''_1 & \longrightarrow & Q''_1 & \longrightarrow 0 \\
 & \downarrow & \searrow & \downarrow & \searrow & \downarrow & \searrow \\
 0 \longrightarrow & P_0 & \longrightarrow & P_0 \oplus P''_0 & \longrightarrow & P''_0 & \longrightarrow 0 \\
 & \downarrow & \searrow & \downarrow & \searrow & \downarrow & \searrow \\
 0 \longrightarrow & Q_0 & \longrightarrow & Q_0 \oplus Q''_0 & \longrightarrow & Q''_0 & \longrightarrow 0 \\
 & \downarrow & \searrow & \downarrow & \searrow & \downarrow & \searrow \\
 0 \longrightarrow & B & \longrightarrow & B' & \longrightarrow & B'' & \longrightarrow 0 \\
 & \downarrow & \searrow & \downarrow & \searrow & \downarrow & \searrow \\
 0 \longrightarrow & C & \longrightarrow & C' & \longrightarrow & C'' & \longrightarrow 0 \\
 & \downarrow & \searrow & \downarrow & \searrow & \downarrow & \searrow \\
 & 0 & & 0 & & 0 & & 0
 \end{array}$$

**Proof:** In  $R\text{Sh}$ , let a boldface letter (e.g.,  $\mathbf{C}$ ) denote a short exact sequence of left  $R$ -modules denoted with the plainface letter, with primes attached (e.g.,  $0 \rightarrow C \rightarrow C' \rightarrow C'' \rightarrow 0$ ). Also, FOR THIS PROOF ONLY, let " $\mathbf{A} \rightarrow \mathbf{B} \rightarrow \mathbf{C}$  is exact" mean that the commutative diagram

$$\begin{array}{ccccccc}
 0 & \longrightarrow & A & \longrightarrow & A' & \longrightarrow & A'' & \longrightarrow & 0 \\
 & & \downarrow & & \downarrow & & \downarrow & & \\
 0 & \longrightarrow & B & \longrightarrow & B' & \longrightarrow & B'' & \longrightarrow & 0 \\
 & & \downarrow & & \downarrow & & \downarrow & & \\
 0 & \longrightarrow & C & \longrightarrow & C' & \longrightarrow & C'' & \longrightarrow & 0
 \end{array}$$

has exact columns. **WARNING:** This is emphatically *not* the *categorical* meaning of exactness to be discussed in the next chapter. In fact,  $R\text{Sh}$  provides a nice example of how the categorical concepts in the next chapter

can produce peculiar consequences, and so will be discussed further at that point.

Setting  $P'_n = P_n \oplus P''_n$  and  $Q'_n = Q_n \oplus Q''_n$ , the corollary can be restated as asserting the existence of fillers:

$$\begin{array}{ccccccccccccccc}
 \cdots & \longrightarrow & \mathbf{P}_{n+1} & \longrightarrow & \mathbf{P}_n & \longrightarrow & \cdots & \longrightarrow & \mathbf{P}_1 & \longrightarrow & \mathbf{P}_0 & \longrightarrow & \mathbf{B} & \longrightarrow & \mathbf{0} \\
 & & \downarrow & & \downarrow & & & & \downarrow & & \downarrow & & \downarrow & & \\
 \cdots & \longrightarrow & \mathbf{Q}_{n+1} & \longrightarrow & \mathbf{Q}_n & \longrightarrow & \cdots & \longrightarrow & \mathbf{Q}_1 & \longrightarrow & \mathbf{Q}_0 & \longrightarrow & \mathbf{C} & \longrightarrow & \mathbf{0}
 \end{array}$$

if the simultaneous resolutions of  $\mathbf{B}$  and  $\mathbf{C}$  are treated as given (by Proposition 6.5). The construction is *identical* to that in the proof of Proposition 3.1, in boldface. For example, the arrow  $\mathbf{P}_0 \dashrightarrow \mathbf{Q}_0$  comes from

$$\begin{array}{ccccc}
 & & \mathbf{P}_0 & & \\
 & & \downarrow & & \\
 & \swarrow & & \downarrow & \\
 & & \mathbf{B} & & \\
 & \swarrow & \downarrow & & \\
 \mathbf{Q}_0 & \longrightarrow & \mathbf{C} & \longrightarrow & \mathbf{0}
 \end{array}$$

filled in via Proposition 6.9. The remainder of the argument also works, **bearing** in mind that, in the notation of Proposition 3.1,  $\text{im } d_{n+1} = \ker d_n$ : If  $K_n$  (respectively,  $K'_n, K''_n$ ) is the kernel of  $P_n \rightarrow P_{n-1}$  (respectively,  $P'_n \rightarrow P'_{n-1}, P''_n \rightarrow P''_{n-1}$ ), then  $0 \rightarrow K_n \rightarrow K'_n \rightarrow K''_n \rightarrow 0$  is short exact by Proposition 6.4 (condition (iv) is satisfied), so that  $\mathbf{K}_n$  is an object in  $\mathbf{RSh}$ . Finally, the homotopy part of Proposition 3.1 does not appear here.

□

The naturality of the connecting homomorphisms in the last section follow readily. More: We get that connecting homomorphisms are independent of the simultaneous resolution via an argument similar to the independence of resolutions in Section 3.1.

**Proposition 6.11** *Suppose*

$$\begin{array}{ccccccc}
 0 & \longrightarrow & B & \longrightarrow & B' & \longrightarrow & B'' & \longrightarrow & 0 \\
 & & \downarrow & & \downarrow & & \downarrow & & \\
 0 & \longrightarrow & C & \longrightarrow & C' & \longrightarrow & C'' & \longrightarrow & 0
 \end{array}$$

*is commutative in  $\mathbf{RM}$ , with exact rows. Letting  $\delta$  denote (generically) the connecting homomorphisms of the long exact sequences of Theorem 6.6, we have the following commutative diagrams for derived functors of an additive functor  $F : \mathbf{RM} \rightarrow \mathbf{SM}$ :*

$$\begin{array}{ccc}
 \text{a) If } F \text{ is covariant: } \mathcal{L}_{n+1}F(B'') & \xrightarrow{\delta} & \mathcal{L}_nF(B) \\
 \downarrow & & \downarrow \\
 \mathcal{L}_{n+1}F(C'') & \xrightarrow{\delta} & \mathcal{L}_nF(C)
 \end{array}$$

$$\begin{array}{ccc}
 \text{b) If } F \text{ is covariant: } \mathcal{R}_nF(B'') & \xrightarrow{\delta} & \mathcal{R}_{n+1}F(B) \\
 \downarrow & & \downarrow \\
 \mathcal{R}_nF(C'') & \xrightarrow{\delta} & \mathcal{R}_{n+1}F(C)
 \end{array}$$

$$\begin{array}{ccc}
 \text{c) If } F \text{ is contravariant: } \mathcal{L}^{n+1}F(B'') & \xleftarrow{\delta} & \mathcal{L}^nF(B) \\
 \uparrow & & \uparrow \\
 \mathcal{L}^{n+1}F(C'') & \xleftarrow{\delta} & \mathcal{L}^nF(C)
 \end{array}$$

$$\begin{array}{ccc}
 \text{d) If } F \text{ is contravariant: } \mathcal{R}^nF(B'') & \xleftarrow{\delta} & \mathcal{R}^{n+1}F(B) \\
 \uparrow & & \uparrow \\
 \mathcal{R}^nF(C'') & \xleftarrow{\delta} & \mathcal{R}^{n+1}F(C)
 \end{array}$$

**Proof:** For (a) or (c), apply  $F$  to the simultaneous resolution of Corollary 6.10, and delete. Upon taking homology, one has the situation of Theorem 3.3, from which our result here follows.

For (b) or (d), do the same, after stating and proving the analog of Proposition 6.9 (and its corollary) for [short exact sequences of] injectives. (See Exercise 11.)  $\square$

A closing comment: We shall wind up reproving this result in the next chapter, using slightly different means. Nevertheless, for pedagogical reasons, the present approach (and associated constructions) are worth studying.

## 6.5 Long Exact Sequences—III. Weirdness

We now have two ways of defining the long exact sequences for Tor and Ext. For this section we shall concentrate on Tor; Ext will be left to Exercises 12 and 13. One can use Theorem 6.6, or one can use Corollary 3.17.

Suppose  $0 \rightarrow B \rightarrow B' \rightarrow B'' \rightarrow 0$  is exact in  ${}_R\mathbf{M}$ , and  $A \in \mathbf{M}_R$ . Tracking it all down, the long exact sequence for  $\text{Tor}(A, \bullet)$  is obtained in Corollary 3.17 by using a flat resolution of  $A$  and tensoring with  $0 \rightarrow B \rightarrow$





denote a simultaneous resolution of  $0 \rightarrow B \rightarrow B' \rightarrow B'' \rightarrow 0$ , constructed via Proposition 6.5. Let  $\mathcal{D}$  denote the complex

$$\cdots \rightarrow A \otimes P_n \rightarrow A \otimes P_{n-1} \rightarrow \cdots \rightarrow A \otimes P_1 \rightarrow A \otimes P_0 \rightarrow 0 \rightarrow 0$$

(again with the dimension shift), and similarly let  $\mathcal{D}'$  (respectively,  $\mathcal{D}''$ ) denote the (deleted) complex obtained by tensoring the resolution of  $B'$  (respectively,  $B''$ ) with  $A$ .

Finally, let  $\mathcal{C}$  denote the complex  $\langle C_n, D_n \rangle$ , where we use the form described after the proof of Corollary 3.10:

$$\begin{aligned} C_{i,j} &= F_{i-1} \otimes P_{j-1} \\ C_n &= \bigoplus_{i=1}^n C_{i,n-i+1}, \quad n \geq 1 \\ D_n &= d_n + (-1)^{n+1} \partial_n : C_n \rightarrow C_{n-1}, \quad n \geq 2 \end{aligned}$$

with  $C_0 = 0$ ,  $D_1 = 0$ , and  $d_n$  and  $\partial_n$  as in Proposition 3.9. Note that we have chain maps  $\mathcal{C} \rightarrow \mathcal{D}$  (as well as  $\mathcal{C}' \rightarrow \mathcal{D}'$  and  $\mathcal{C}'' \rightarrow \mathcal{D}''$ ) thanks to incorporating the required dimension shifts into  $\mathcal{D}$ ,  $\mathcal{D}'$ , and  $\mathcal{D}''$ . (Consult the array preceding Proposition 3.9.) Also, since  $(-1)^{n+1} D_n = \partial_n + (-1)^{n+1} d_n$  corresponds to the flipped version of the array  $C_{i,j}$ , we have that  $\widehat{\mathcal{C}} \rightarrow \mathcal{A}$ , as well as  $\widehat{\mathcal{C}}' \rightarrow \mathcal{A}'$  and  $\widehat{\mathcal{C}}'' \rightarrow \mathcal{A}''$ , are chain maps, by the symmetry part of the proof of Proposition 3.9 (as well as the  $n$ -tuple  $(y_1, -y_2, \dots, -y_{n-1}, y_n) \mapsto d_{n,1}(y_n)$  being the zigzag correspondence, without any sign changes, when  $n$  is odd). Finally, note that the diagrams

$$\begin{array}{ccccc} \mathcal{C} & \longrightarrow & \mathcal{C}' & \longrightarrow & \mathcal{C}'' \\ \downarrow & & \downarrow & & \downarrow \\ \mathcal{D} & \longrightarrow & \mathcal{D}' & \longrightarrow & \mathcal{D}'' \end{array}$$

and

$$\begin{array}{ccccc} \widehat{\mathcal{C}} & \longrightarrow & \widehat{\mathcal{C}}' & \longrightarrow & \widehat{\mathcal{C}}'' \\ \downarrow & & \downarrow & & \downarrow \\ \mathcal{A} & \longrightarrow & \mathcal{A}' & \longrightarrow & \mathcal{A}'' \end{array}$$

commute: The first follows from the naturality part of the proof of the corollary to Proposition 3.9, letting  $\iota$  and  $\pi$  replace  $\varphi$  in the proof. The second diagram follows by symmetry.

Now, however, we have the diagrams

$$\begin{array}{ccccccc} 0 & \longrightarrow & \mathcal{C} & \longrightarrow & \mathcal{C}' & \longrightarrow & \mathcal{C}'' \longrightarrow 0 \\ & & \downarrow & & \downarrow & & \downarrow \\ 0 & \longrightarrow & \mathcal{D} & \longrightarrow & \mathcal{D}' & \longrightarrow & \mathcal{D}'' \longrightarrow 0 \end{array}$$

and

$$\begin{array}{ccccccc}
 0 & \longrightarrow & \hat{C} & \longrightarrow & \hat{C}' & \longrightarrow & \hat{C}'' \longrightarrow 0 \\
 & & \downarrow & & \downarrow & & \downarrow \\
 0 & \longrightarrow & \mathcal{A} & \longrightarrow & \mathcal{A}' & \longrightarrow & \mathcal{A}'' \longrightarrow 0
 \end{array}$$

with exact rows, yielding isomorphisms on homology via vertical arrows. (Note: The top rows are exact for the usual reasons: Each

$$0 \longrightarrow F_i \otimes P_j \longrightarrow F_i \otimes P'_j \longrightarrow F_i \otimes P''_j \longrightarrow 0$$

is exact.)

Using Theorem 3.3, especially the naturality part, it suffices to compare the connecting homomorphisms of

$$0 \longrightarrow \mathcal{C} \longrightarrow \mathcal{C}' \longrightarrow \mathcal{C}'' \longrightarrow 0$$

and

$$0 \longrightarrow \hat{\mathcal{C}} \longrightarrow \hat{\mathcal{C}}' \longrightarrow \hat{\mathcal{C}}'' \longrightarrow 0$$

for *any* short exact sequence of complexes. This is easy enough to do:  $\delta_n$  is constructed in the same way in each case, *except* that  $(-1)^{n+1}d'_n$  substitutes for  $d'_n$ :

$$\begin{array}{ccc}
 \begin{array}{ccc} C'_n & \longrightarrow & C''_n \\ \downarrow d'_n & & \\ C_{n-1} & \longrightarrow & C'_{n-1} \end{array} & \text{versus} & \begin{array}{ccc} C'_n & \longrightarrow & C''_n \\ \downarrow (-1)^{n+1}d'_n & & \\ C_{n-1} & \longrightarrow & C'_{n-1} \end{array}
 \end{array}$$

$$\begin{array}{ccc}
 & * & \longrightarrow * \\
 & \downarrow & \nearrow \\
 \delta_n z & \xrightarrow{\delta_n} & *
 \end{array}$$

Finally, we get a sign change of  $(-1)^n$  instead of  $(-1)^{n+1}$  due to the dimension shift incorporated into  $\mathcal{A}, \mathcal{A}', \mathcal{A}'', \mathcal{D}, \mathcal{D}',$  and  $\mathcal{D}''$ .  $\square$

It should be noted that one can modify the isomorphisms of Corollary 3.10 to get rid of the above sign discrepancy. The obvious modification (multiply the  $n$ th isomorphism by  $(-1)^n$  or  $(-1)^{n+1}$ ) does *not* work. (See Exercise 14.) Oh, if only life were so simple!

## 6.6 Universality of Ext

The following is an easy exercise: If  $F$  is a covariant functor from  ${}_R\mathbf{M}$  to  ${}_S\mathbf{M}$ , then  $\text{P-dim } B < k \Rightarrow \mathcal{L}_k F(B) = 0$ . In particular,

$$(\forall C \in {}_R\mathbf{M}, \text{Ext}^k(B, C) = 0) \Rightarrow \mathcal{L}_k F(B) = 0.$$

That is, in some sense  $\text{Ext}^k$  controls  $\mathcal{L}_k F$ . It is the aim of this section to be a lot more precise about this, but some fundamental set theoretic issues arise in formulating such a result.

Before beginning, we need some definitions. If  $F, G : {}_R\mathbf{M} \rightarrow {}_S\mathbf{M}$  are covariant, then a *natural transformation* from  $F$  to  $G$  is the assignment to each object  $B \in {}_R\mathbf{M}$  of a homomorphism  $\tau_B \in \text{Hom}_S(F(B), G(B))$  such that whenever  $f \in \text{Hom}_R(B, C)$ , the diagram

$$\begin{array}{ccc} F(B) & \xrightarrow{F(f)} & F(C) \\ \downarrow \tau_B & & \downarrow \tau_C \\ G(B) & \xrightarrow{G(f)} & G(C) \end{array}$$

commutes. (This definition is used, suitably modified, when  $F$  and  $G$  are two covariant functors or two contravariant functors from any category to any other. We shall return to this in Chapter 7.)

If  $\tau$  is a natural transformation from  $F$  to  $G$ , and  $\sigma$  is a natural transformation from  $E$  to  $F$ , then one may form the *composite*  $\tau\sigma$  from  $E$  to  $G$  via  $(\tau\sigma)_B = \tau_B\sigma_B$ . There is an *identity* transformation  $\iota$  from  $F$  to itself defined by  $\iota_B = i_{F(B)}$  for all  $B$ . If  $E = G$ , then  $\sigma$  is an *inverse* to  $\tau$  if  $\sigma\tau$  and  $\tau\sigma$  are the appropriate identity transformations.  $\tau$  is a *natural isomorphism* if  $\tau$  has an inverse, or equivalently (see Exercise 15), if  $\tau_B$  is an isomorphism for all  $B$ .  $F$  and  $G$  are *naturally isomorphic* if there is a natural isomorphism from  $F$  to  $G$ . Example:  $\text{Hom}(B, \bullet)$  and  $\text{Ext}^0(B, \bullet)$ .

Since our target category is  ${}_S\mathbf{M}$ , another operation exists. If  $\sigma$  and  $\tau$  are natural transformations from  $F$  to  $G$ , we can form the *sum* via  $(\sigma + \tau)_B = \sigma_B + \tau_B$ . This construction makes it look like natural transformations form an Abelian group, leading to the consideration of collections of natural transformations. But what kind of collection could it be? Any natural transformation is a function on  ${}_R\mathbf{M}$ , a proper class. Hence, (as a class of ordered pairs) any natural transformation from  $F$  to  $G$  will be a proper class, and so cannot belong to *any* class.

A way out of this dilemma, discussed in Herrlich & Strecker [31, esp. appendix on foundations], is to extend the set-class hierarchy one more step to what they (and we) call *conglomerates*.

The idea is that conglomerates should obey the *elementary* axioms of set theory, and furthermore, any class should be a conglomerate. A natural



transformation from  $F$  to  $G$  is a subclass of

$${}_R\mathbf{M} \times \left( \bigcup_{B \in {}_R\mathbf{M}} \text{Hom}_S(F(B), G(B)) \right)$$

as a class of ordered pairs, and so the natural transformations from  $F$  to  $G$  form a subconglomerate of the power conglomerate of this as a conglomerate.

The next question is consistency. First of all, to be explicit about what we assume, note what we do *not* assume. Exactly three axioms from ZFC (Zermello–Frankel set theory along with the axiom of Choice) are absent: foundation (or regularity), choice, and replacement. What we *do* assume are that conglomerates satisfy the remaining axioms of set theory. (See, e.g., Halmos [27] or Devlin [15].) They are: extension, pairing, powers, unions, and specification (sometimes called subset selection). While we do not need it, a weak replacement axiom is necessary for some purposes, in which the parameter space is assumed to be a set: “If  $A$  is a set, and  $S(a, x)$  is a sentence such that for all  $a \in A$ ,  $\{x : S(a, x)\}$  is a conglomerate, then  $\{x : S(a, x) \text{ for some } a \in A\}$  is a conglomerate.” One thing we do need is the final assumption that a subconglomerate of a class is a class. In particular, a subconglomerate of a set is a class, hence is a set. (A subclass of a set is a set.) This way, the power operation on conglomerates restricts to the usual power set operation on sets, but not on proper classes: If  $A$  is a proper class, then  $A$  belongs to the power conglomerate of  $A$ , since  $A$  is a conglomerate, but not to the power class of  $A$  since  $A$  is not a set. (See Chapter 1.) Call the resulting theory *conglomerate theory*, or *strong conglomerate theory* when conglomerates satisfy *all* the axioms of ZFC.

While it is not evident, we have now entered the realm of large cardinals. Recall that a cardinal is an ordinal with the property that all smaller ordinals have smaller cardinality. (That looks circular, but it isn’t; cardinality is defined first in terms of bijections.) A cardinal  $\kappa$  is called *regular* if it cannot be the cardinal supremum of a set  $A$  of smaller cardinals when  $|A| < \kappa$ .  $\kappa$  is called *strongly inaccessible* if  $\kappa$  is uncountable, regular, and  $\lambda < \kappa \Rightarrow 2^\lambda < \kappa$  for any cardinal  $\lambda$ . Basically, strong inaccessibility for  $\kappa$  means that  $\kappa$  cannot be obtained from lower cardinalities using the usual set theoretic operations.

Finally, recall the Zermello hierarchy. Set  $V_0 = \emptyset$ , and recursively define (for  $\alpha$  ordinal)  $V_{\alpha+1} = \mathcal{P}(V_\alpha)$ , with  $V_\alpha = \bigcup\{V_\beta : \beta < \alpha\}$  if  $\alpha$  is a limit ordinal. Note that  $V_\alpha$  grows via iterated exponentials:  $|V_0| = 0$ ,  $|V_1| = 1$ ,  $|V_2| = 2$ ,  $|V_3| = 4$ ,  $|V_4| = 16$ ,  $|V_5| = 65,536$ , and so on ( $|V_{n+1}| = 2^{|V_n|}$ ). In general, if  $\alpha^+$  is the successor ordinal to  $\alpha$ , then  $V_\alpha \subset V_{\alpha^+}$  (or equivalently,  $A \in V_\alpha \Rightarrow A \subset V_\alpha$ ), by transfinite induction on  $\alpha$ . Hence,  $\alpha < \beta \Rightarrow V_\alpha \subset V_\beta$ . Similarly,  $\alpha \subset V_\alpha$ , again by transfinite induction. Hence,  $|\alpha| \leq |V_\alpha|$ . Nevertheless, letting  $c = \text{continuum}$ ,  $\tau_0 = |V_c|$ , and (recursively)  $\tau_{n+1} = |V_{\tau_n}|$ , one can construct a monster cardinal  $\tau = \sup\{\tau_1, \tau_2, \dots\}$  for which



$|V_\tau| = \tau$ . ( $\aleph_\tau = \tau$  as well, since by transfinite induction  $|\omega + \alpha| \leq \aleph_\alpha \leq |V_{\omega+\alpha}|$  for any ordinal  $\alpha$ , where  $\omega =$  natural numbers; but  $\omega + \alpha = \alpha$  when  $\alpha \geq \omega^2$ , so that  $\omega + \tau = \tau$  and  $\tau \leq \aleph_\tau \leq |V_\tau|$ .) Nevertheless,  $\tau$  is not regular, and is much(!) too small to be strongly inaccessible.

The following is a standard result from set theory (see Devlin [15, p. 98] or Kanamori [42, p. 18]):

*If  $\kappa$  is a strongly inaccessible cardinal, then  $|V_\kappa| = \kappa$ , and  $\mathcal{P}(V_\kappa)$  is a model for Gödel–Bernays–von Neumann class theory, where  $V_\kappa = \{A \subset V_\kappa : |A| < \kappa\}$  is the associated class of sets.*

In particular, if  $\kappa$  is the *smallest* strongly inaccessible cardinal, the resulting model has *no* strongly inaccessible cardinals. (Note, too, that in this model, proper classes have “cardinality”  $\kappa$ , and so really are too big to be sets. This is a general phenomenon in Gödel–Bernays–von Neumann class theory, deducible from the global axiom of choice. In general, conglomerates can be large or small: If  $A$  is a proper class, then  $\{A\}$  is a conglomerate but not a class.) We have the following conclusion:

*If ZFC is consistent, then the existence of strongly inaccessible cardinals is either inconsistent with ZFC or is undecidable in ZFC.*

(Recall that a statement is undecidable if neither it nor its negation can be proven.)

Now back to conglomerate theory. We only assume “ordinary” conglomerate theory; the ability to restate (in rather cumbersome fashion) many results without it causes one to suspect consistency. For strong conglomerate theory, the situation is much more definitive.

**Proposition 6.13** *Suppose ZFC is consistent. Then strong conglomerate theory is consistent if and only if the existence of strongly inaccessible cardinals is undecidable in ZFC.*

**Proof:** For the if part, suppose the existence of strongly inaccessible cardinals is consistent with ZFC. There then exists a model  $M$  for ZFC which contains a strongly inaccessible cardinal  $\kappa$  by the consistency theorem of mathematical logic. For a model of strong conglomerate theory, let conglomerates be the universe of sets in the model  $M$ , while the collection of classes is  $\mathcal{P}(V_\kappa)$ , and the collection of sets is  $\{A \subset V_\kappa : |A| < \kappa\} = V_\kappa$ .

On the other hand, if strong conglomerate theory is consistent, let  $U$  be a universe of conglomerates in some model.  $U$  exists again by the consistency theorem. Let  $C$  be the conglomerate of classes, and  $S$  the class of sets in this model. Then  $U$  is a model of ZFC, so  $U$  has its own “collection” of ordinals and cardinals, which will include the class  $\alpha$  of all ordinals from  $S$ . (The von Neumann definition of an ordinal is consistent between  $U$  and  $S$ .) Furthermore, any conglomerate function between two classes (e.g.,

ordinals)  $A$  and  $B$  is a subconglomerate of the class  $A \times B$ , so it is a class, that is, it is a function relative to  $C$ . Thus the  $S$ -cardinals in  $\alpha$  are  $U$ -cardinals, and vice versa, since a set correspondence between an ordinal in  $S$  and a smaller ordinal is a conglomerate correspondence, and vice versa. If  $\beta$  is a  $U$ -ordinal below  $\alpha$ , then  $\beta \in \alpha$  (so that  $\beta$  is a set)  $\Rightarrow \beta$  and  $\alpha$  are not in one-to-one correspondence (otherwise  $\alpha$  would be a set by the axiom of replacement). That is,  $\alpha$  is a  $U$ -cardinal. If  $\beta$  is a cardinal and  $\beta < \alpha$ , then  $\mathcal{P}(\beta) \in S \Rightarrow |2^\beta| \in \alpha \Rightarrow |2^\beta| < \alpha$ . Finally, if a conglomerate  $A \subset \alpha$ ,  $A$  consists of cardinals, and  $|A| < \alpha$ , then (i)  $A$  is a class (since  $A \subset \alpha$  and  $\alpha$  is a class), and (ii)  $A$  is in 1-1 (conglomerate, hence class) correspondence with the set  $|A| \in \alpha$ . Since  $|A|$  is a set, it follows that  $A$  is a set by the axiom of replacement in  $C$  and  $S$ . Hence  $A$  has a cardinal supremum in  $S$ , which by definition is a member of  $\alpha$  and so is less than  $\alpha$  relative to  $U$ . The conclusion then is that  $\alpha$  is strongly inaccessible in the model  $U$  of ZFC.  $\square$

**Remark:** The following is left as an exercise for the set-theoretically inclined reader. In the proof of the “if” part, let  $\omega$  denote the countable infinite cardinal, and  $+$  denote ordinal sum. Then ordinary conglomerate theory has the much smaller model  $V_{\kappa+\omega}$ , or  $V_{\kappa+\kappa}$  if weak replacement is assumed.

It should be noted that strongly inaccessible cardinals are almost at the bottom(!) of the hierarchy of large cardinals contemplated by set theoreticians. See, for example, Kanamori [42] or Drake [16] for a discussion of all this. Certain of these assumptions lead to the existence of a large cardinality of large cardinals, allowing the extension here of set  $\rightarrow$  class  $\rightarrow$  conglomerate to proceed further through a large cardinality. The extent to which one believes in the existence of these large cardinals dissipates in the higher realms, but there does seem to be some consensus that strongly inaccessible cardinals, at least, can be assumed to exist. Since we don’t even need that for ordinary conglomerate theory, we shall proceed with assuming ordinary conglomerate theory. (By the way, the limited use we make here can be shown to be consistent with set theory; see the article by Lévy in [58].)

Specialize now to the case  $S = \mathbb{Z}$ , that is, let  $F$  and  $G$  be covariant functors from  ${}_R\mathbf{M}$  to  $\mathbf{Ab}$ . Let  $\text{Nat}(F, G)$  denote the conglomerate of natural transformations from  $F$  to  $G$ .  $\text{Nat}(F, G)$  is an Abelian *conglomerate group*, that is, an Abelian “group” whose underlying “set” is really a conglomerate.

**Proposition 6.14 (Yoneda Lemma)** *If  $F$  is a covariant functor from  ${}_R\mathbf{M}$  to  $\mathbf{Ab}$ , then for all  $B \in {}_R\mathbf{M}$ ,  $F(B) \approx \text{Nat}(\text{Hom}(B, \bullet), F)$ . The isomorphism sends  $\tau \in \text{Nat}(\text{Hom}(B, \bullet), F)$  to  $\tau_B(i_B)$ . (Note:  $\tau_C : \text{Hom}(B, C) \rightarrow F(C)$ .)*

**Remark:** A restatement not using conglomerate theory would read as

follows: "If  $F$  is a covariant functor from  ${}_R\mathbf{M}$  to  $\mathbf{Ab}$ , then for all  $B \in {}_R\mathbf{M}$  and all  $x \in F(B)$ , there exists a unique natural transformation  $\tau$  from  $\text{Hom}(B, \bullet)$  to  $F$  for which  $\tau(i_B) = x$ . All natural transformations from  $\text{Hom}(B, \bullet)$  to  $F$  arise in this way."

**Proof:** First, note that  $\tau \mapsto \tau_B(i_B)$  is a homomorphism, which is immediate from the definition of the sum of two natural transformations. Furthermore, for any  $C \in {}_R\mathbf{M}$  and  $f \in \text{Hom}_R(B, C)$ ,  $\text{Hom}_R(B, f)$  is post-composition by  $f$  (abbreviated  $f_*$ ) in  $\text{Hom}_{\mathbf{Z}}(\text{Hom}_R(B, B), \text{Hom}_R(B, C))$ . Hence,

$$\begin{array}{ccc} \text{Hom}(B, B) & \xrightarrow{f_*} & \text{Hom}(B, C) \\ \tau_B \downarrow & & \downarrow \tau_C \\ F(B) & \xrightarrow{F(f)} & F(C) \end{array}$$

commutes. But now suppose  $\tau_B(i_B) = 0$  and look where  $f$  goes:

$$0 = F(f)(0) = F(f)\tau_B(i_B) = \tau_C(f_*i_B) = \tau_C(f).$$

Since  $C$  and  $f$  are arbitrary,  $\tau \equiv 0$ . Hence the kernel of the homomorphism is trivial, so it is one-to-one. (The kernel is a conglomerate subgroup. Elementary theorems from group theory remain theorems for conglomerate groups.)

Finally, we must show that the homomorphism is onto. Given  $x \in F(B)$ , and  $C \in {}_R\mathbf{M}$ , define  $\tau_C^x(f) = F(f)(x)$  when  $f \in \text{Hom}(B, C)$ . (This has the right values.  $F(f) \in \text{Hom}(F(B), F(C))$ , so that  $\tau_C^x(f) \in F(C)$ . That is,  $\tau_C^x$  maps  $\text{Hom}(B, C)$  to  $F(C)$ .) Clearly  $\tau_B^x(i_B) = x$ ; we must check that  $\tau^x$  is natural. If  $C, D \in {}_R\mathbf{M}$  and  $g \in \text{Hom}(C, D)$ , we must check commutativity of

$$\begin{array}{ccc} \text{Hom}(B, C) & \xrightarrow{g_*} & \text{Hom}(B, D) \\ \tau_C^x \downarrow & & \downarrow \tau_D^x \\ F(C) & \xrightarrow{F(g)} & F(D) \end{array}$$

If  $f \in \text{Hom}(B, C)$ , then

$$F(g)\tau_C^x(f) = F(g)F(f)(x) = F(gf)(x) = \tau_D^x(gf) = \tau_D^x \circ g_*(f). \quad \square$$

The preceding, surprisingly, does not even use additivity of  $F$ . The next result, the final one of this chapter, requires even more than additivity.



**Proposition 6.15 (Universality of Ext, or the Derived Yoneda Lemma)** *Suppose  $F$  is a right exact covariant functor from  ${}_R\mathbf{M}$  to  $\mathbf{Ab}$ . Then for all  $B \in {}_R\mathbf{M}$  and  $n \geq 0$ ,  $\mathcal{L}_n F(B) \approx \text{Nat}(\text{Ext}^n(B, \bullet), F)$ .*

**Proof:** This is one of those homological algebra inductions on  $n$  requiring special discussion for  $n = 1$ . First, the easy parts. Since  $F$  is right exact,  $\mathcal{L}_0 F(B) \approx F(B) \approx \text{Nat}(\text{Hom}(B, \bullet), F) \approx \text{Nat}(\text{Ext}^0(B, \bullet), F)$ . This covers the  $n = 0$  case.

Suppose  $0 \rightarrow K \xrightarrow{\iota} P \rightarrow B \rightarrow 0$  is short exact, with  $P$  projective. If  $n > 1$ , then the induction step reads

$$\begin{aligned} \mathcal{L}_{n+1} F(B) &\approx \mathcal{L}_n F(K) \approx \text{Nat}(\text{Ext}^n(K, \bullet), F) \\ &\approx \text{Nat}(\text{Ext}^{n+1}(B, \bullet), F). \end{aligned}$$

(Here we use the fact that  $\text{Ext}^n(K, \bullet)$  and  $\text{Ext}^{n+1}(B, \bullet)$  are naturally isomorphic, as follows, for example, from Proposition 6.11(b).)

Finally, we must tackle the  $n = 1$  case. For this, we have an exact sequence

$$0 \rightarrow \mathcal{L}_1 F(B) \rightarrow \mathcal{L}_0 F(K) \rightarrow \mathcal{L}_0 F(P) \rightarrow \mathcal{L}_0 F(B) \rightarrow 0.$$

(The presence of  $\mathcal{L}_0 F(P)$  distinguishes the cases  $n = 1, n > 1$ .) Since  $F$  is right exact, we have as part of this

$$\begin{array}{ccccccc} 0 & \longrightarrow & \mathcal{L}_1 F(B) & \longrightarrow & F(K) & \longrightarrow & F(P) \\ & & & & \cong & & \cong \\ & & & & \text{Nat}(\text{Hom}(K, \bullet), F) & & \text{Nat}(\text{Hom}(P, \bullet), F). \end{array}$$

Clearly, we need an exact sequence of conglomerate groups

$$0 \rightarrow \text{Nat}(\text{Ext}^1(B, \bullet), F) \rightarrow \text{Nat}(\text{Hom}(K, \bullet), F) \rightarrow \text{Nat}(\text{Hom}(P, \bullet), F)$$

put into the bottom row. This requires some discussion.

First of all, for any  $C$ , we have an exact sequence

$$\text{Hom}(P, C) \rightarrow \text{Hom}(K, C) \rightarrow \text{Ext}^1(B, C) \rightarrow 0$$

which is natural; that is, we have natural transformations  $\tau$  from  $\text{Hom}(P, \bullet)$  to  $\text{Hom}(K, \bullet)$ , and  $\delta$  from  $\text{Hom}(K, \bullet)$  to  $\text{Ext}^1(B, \bullet)$ , such that

$$\text{Hom}(P, C) \xrightarrow{\tau_C} \text{Hom}(K, C) \xrightarrow{\delta_C} \text{Ext}^1(B, C) \longrightarrow 0$$

is exact.  $\tau_C = \iota^*$  in earlier notation. Furthermore, precomposition by  $\tau, \tau^*$ , yields the diagram

$$\begin{array}{ccc} F(K) & \xrightarrow{F(\iota)} & F(P) \\ \cong & & \cong \\ \text{Nat}(\text{Hom}(K, \bullet), F) & \xrightarrow{\tau^*} & \text{Nat}(\text{Hom}(P, \bullet), F). \end{array}$$

This diagram is commutative: If  $\sigma \in \text{Nat}(\text{Hom}(K, \bullet), F)$ , we must check that

$$(\sigma\tau)_P(i_P) = F(\iota)\sigma_K(i_K).$$

But

$$\begin{array}{ccc} \text{Hom}(K, K) & \xrightarrow{\iota_*} & \text{Hom}(K, P) \\ \downarrow \sigma_K & & \downarrow \sigma_P \\ F(K) & \xrightarrow{F(\iota)} & F(P) \end{array}$$

commutes by naturality of  $\sigma$ ; also,  $\iota_*(i_K) = \iota i_K = \iota$ , so

$$\sigma_P(\iota) = \sigma_P \iota_*(i_K) = F(\iota)\sigma_K(i_K)$$

while

$$(\sigma\tau)_P(i_P) = \sigma_P(\tau_P(i_P)) = \sigma_P(\iota^* i_P) = \sigma_P(i_P \iota) = \sigma_P(\iota).$$

In a similar fashion, precomposition by  $\delta$ ,  $\delta^*$  yields a homomorphism sending  $\sigma \in \text{Nat}(\text{Ext}^1(B, \bullet), F)$  to  $\sigma\delta \in \text{Nat}(\text{Hom}(K, \bullet), F)$ . Combining, we now have a commutative diagram

$$0 \longrightarrow \mathcal{L}_1 F(B) \longrightarrow F(K) \xrightarrow{F(\iota)} F(P)$$

$\cong \qquad \qquad \qquad \cong$

$$0 \longrightarrow \text{Nat}(\text{Ext}^1(B, \bullet), F) \xrightarrow{\delta^*} \text{Nat}(\text{Hom}(K, \bullet), F) \xrightarrow{\tau^*} \text{Nat}(\text{Hom}(P, \bullet), F)$$

with an exact top row. Once we know the bottom row is exact, we will be done, as then

$$\begin{aligned} \mathcal{L}_1 F(B) &\approx \ker F(\iota) \approx \ker(\tau^*) \\ &\approx \text{Nat}(\text{Ext}^1(B, \bullet), F). \end{aligned}$$

This is a general fact, a kind of left exactness, for the construction  $\eta \mapsto \eta^*$ . We state this as a lemma, the proof of which completes the proof of Proposition 6.15.  $\square$

**Lemma 6.16** *Suppose  $F, G, G', G''$  are covariant additive functors from  $\mathcal{R}\mathcal{M}$  to  $\text{Ab}$ . Suppose  $\tau \in \text{Nat}(G, G')$  and  $\delta \in \text{Nat}(G', G'')$  satisfy, for all  $C$ , exactness of*

$$G(C) \xrightarrow{\tau_C} G'(C) \xrightarrow{\delta_C} G''(C) \rightarrow 0.$$

Then

$$0 \longrightarrow \text{Nat}(G'', F) \xrightarrow{\delta^*} \text{Nat}(G', F) \xrightarrow{\tau^*} \text{Nat}(G, F)$$

is exact.



**Proof:** As usual, the easiest part is that for all  $\sigma \in \text{Nat}(G'', F)$ ,  $\tau^* \delta^*(\sigma) = 0 : \tau^* \delta^*(\sigma) = \tau^*(\sigma \delta) = \sigma \delta \tau$ , so that for any  $C$ ,  $[\tau^* \delta^*(\sigma)]_C = (\sigma \delta \tau)_C = \sigma_C \delta_C \tau_C = 0$ , since  $\delta_C \tau_C = 0$ . Also,  $\delta^*$  is one-to-one, since  $\delta^*(\sigma) = 0 \Rightarrow \sigma \delta = 0 \Rightarrow \sigma_C \delta_C = 0$  for all  $C \Rightarrow \sigma_C = 0$  for all  $C$  since all  $\delta_C$  are onto.

Finally, we must show that if  $\sigma \in \ker(\tau^*)$ , then  $\sigma \in \text{im}(\delta^*)$ . Suppose  $\sigma \in \ker(\tau^*)$ , i.e.  $\sigma_C \tau_C = (\sigma \tau)_C = 0$  for all  $C$ . Hence for each  $C$  a unique filler  $\sigma'_C$  exists for

$$\begin{array}{ccccc} G(C) & \xrightarrow{\tau_C} & G'(C) & \xrightarrow{\delta_C} & G''(C) & \longrightarrow & 0 \\ & & \downarrow \sigma_C & \swarrow \sigma'_C & & & \\ & & F(C) & & & & \end{array}$$

so that by definition  $\sigma'_C \delta_C = \sigma_C$ . (This is fairly easy, and will define cokernels in Chapter 7.) Once we show that  $\sigma'$  defines a natural transformation, we will be done, since then  $\sigma'_C \delta_C = (\sigma' \delta)_C = (\delta^*(\sigma'))_C$ . We must establish commutativity of

$$\begin{array}{ccc} G''(B) & \xrightarrow{G''(f)} & G''(C) \\ \sigma'_B \downarrow & & \downarrow \sigma'_C \\ F(B) & \xrightarrow{F(f)} & F(C) \end{array}$$

for all  $B, C \in \mathcal{R}\mathcal{M}$ ,  $f \in \text{Hom}(B, C)$ .

Suppose  $x \in G''(B)$ . Since  $\delta_B$  is surjective from  $G'(B)$  to  $G''(B)$ , there is a  $y \in G'(B)$  for which  $\delta_B(y) = x$ . Furthermore,  $\sigma'_B(x) = \sigma'_B \delta_B(y) = \sigma_B(y)$ . Since

$$\begin{array}{ccc} G'(B) \xrightarrow{G'(f)} G'(C) & & G'(B) \xrightarrow{G'(f)} G'(C) \\ \sigma_B \downarrow & \text{and} & \delta_B \downarrow \\ F(B) \xrightarrow{F(f)} F(C) & & G''(B) \xrightarrow{G''(f)} G''(C) \\ & & \delta_C \downarrow \end{array}$$

commute,

$$\delta_C G'(f)(y) = G''(f) \delta_B(y) = G''(f)(x).$$

But  $\sigma'_C \delta_C = \sigma_C$ , so

$$\begin{aligned} F(f) \sigma'_B(x) &= F(f) \sigma_B(y) = \sigma_C G'(f)(y) = \sigma'_C \delta_C G'(f)(y) \\ &= \sigma'_C G''(f)(x). \end{aligned}$$

Letting  $x$  float,  $F(f) \sigma'_B = \sigma'_C G''(f)$ . □

By the way, the last verification can be redone without elements by considering the diagram

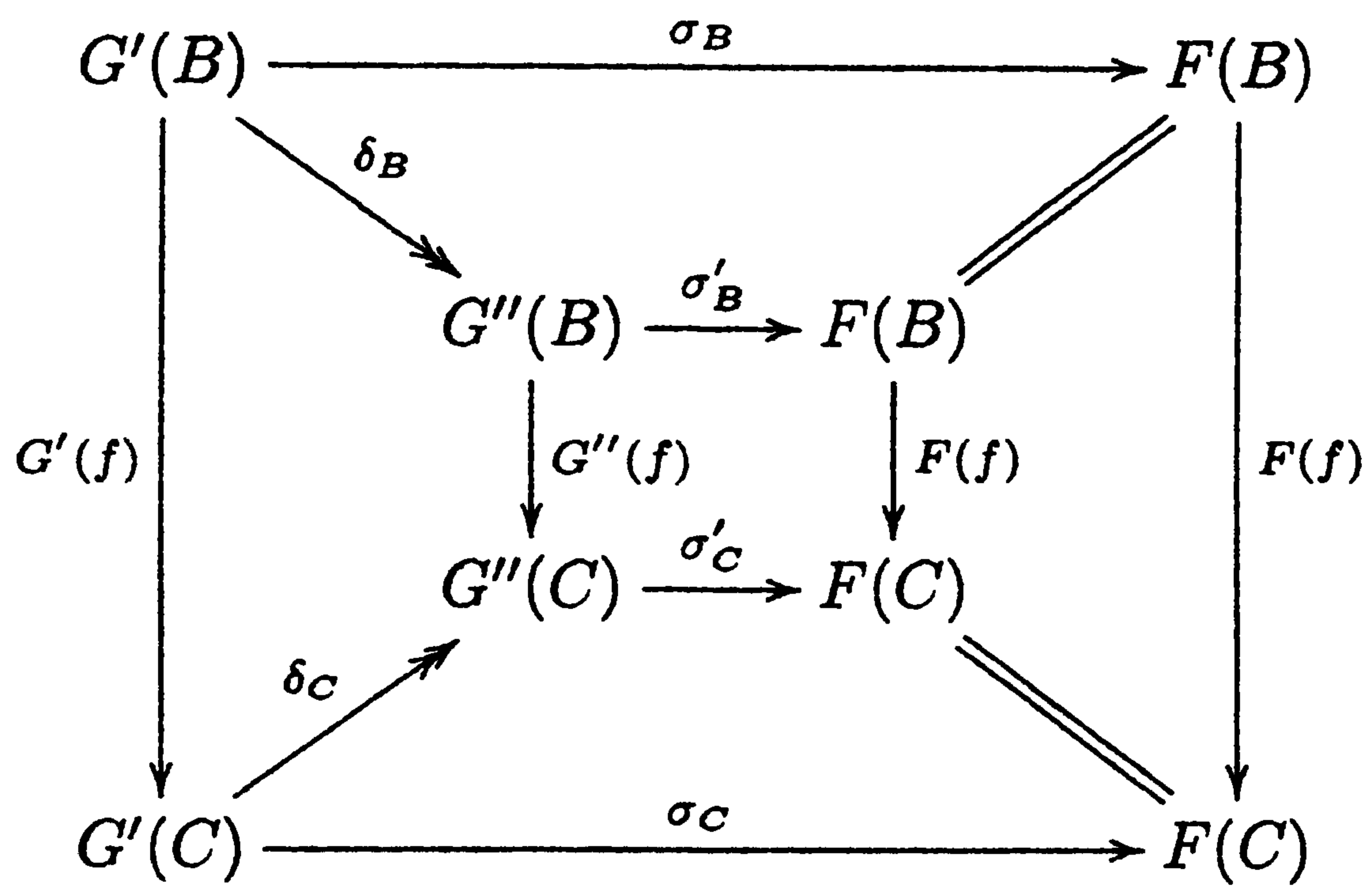

The interested reader is invited to pursue further ( $\rightarrow$  denotes a surjection).

## Exercises

1. Suppose  $F$  is a covariant functor from  ${}_R\mathbf{M}$  to  ${}_S\mathbf{M}$  satisfying condition (iii) of Proposition 6.1. Show that  $F(\text{zero object}) = \text{zero object}$ . Hence, show  $F(\text{zero homomorphism}) = \text{zero homomorphism}$ . From the biproduct construction of Chapter 2, Exercise 1, show that  $F(\pi_1)$  and  $F(\pi_2)$  are, in fact, the projections that (with  $F(\varphi_1)$  and  $F(\varphi_2)$ ) define  $F(B \oplus B)$  as a biproduct.

Remark: This clears up the technical point in the proof of Proposition 6.1, so Proposition 6.1 cannot be used here. Note that while the zero object is not the only module for which  $B \approx B \oplus B$  (think large), it is the only module for which

$$\begin{array}{ccccc}
 B & \xrightarrow{\quad\quad\quad} & B \oplus B & \xleftarrow{\quad\quad\quad} & B \\
 & & \uparrow \varphi & & \uparrow \varphi \\
 & & \text{same} & & 
 \end{array}$$

is a coproduct.

2. Suppose  $F$  is a contravariant functor from  ${}_R\mathbf{M}$  to  ${}_S\mathbf{M}$ . Show that  $F$  is additive if and only if  $F(B \times C) \approx F(B) \oplus F(C)$  for all  $B, C \in {}_R\mathbf{M}$ . (Same tacit assumption as that following Proposition 6.1.)
3. Suppose  $F$  is a covariant additive functor from  ${}_R\mathbf{M}$  to  ${}_S\mathbf{M}$ .
- Show that  $\mathcal{L}_n(\mathcal{L}_m F) \equiv 0$  if  $m > 0$ .
  - Show that  $\mathcal{L}_n(\mathcal{L}_0 F)(B) \approx \mathcal{L}_n F(B)$  for all  $B$ .

Hint: This is one of those inductions on  $n$  requiring special discussion when  $n = 1$ .

4. Suppose  $F$  is a covariant additive functor from  ${}_R\mathbf{M}$  to  ${}_S\mathbf{M}$ . If  $B \in {}_R\mathbf{M}$ , and if  $\langle P_i, d_i \rangle$  is the projective resolution chosen for  $B$ , then the map  $\pi : P_0 \rightarrow B$  induces  $F(\pi) : F(P_0) \rightarrow F(B)$ . Use this to construct a natural transformation  $\tau$  from  $\mathcal{L}_0 F$  to  $F$  such that  $\tau_B$  is an isomorphism whenever  $B$  is projective.
5. Set  $R = \mathbb{Z}_4$ ,  $S = \mathbb{Z}$ ,  $F : {}_R\mathbf{M} \rightarrow {}_S\mathbf{M}$ ,  $F(B) = \text{Hom}(\mathbb{Z}_2, B)$ .

- Using the exact sequence  $0 \rightarrow \mathbb{Z}_2 \rightarrow \mathbb{Z}_4 \rightarrow \mathbb{Z}_2 \rightarrow 0$ , show that  $\mathcal{L}_n F(\mathbb{Z}_2) \approx \mathcal{L}_{n+1} F(\mathbb{Z}_2)$  for  $n \geq 1$ . Also compute  $\mathcal{L}_0 F(\mathbb{Z}_2)$  and  $\mathcal{L}_1 F(\mathbb{Z}_2)$ . Hint: Setting  $\mathcal{L}_0 F(\mathbb{Z}_2) = X$ , one has an exact sequence

$$\begin{array}{ccccccc}
 0 & \longrightarrow & \mathcal{L}_1 F(\mathbb{Z}_2) & \longrightarrow & X & \longrightarrow & \mathbb{Z}_2 \longrightarrow X \longrightarrow 0 \\
 & & & & \uparrow & & \uparrow \\
 & & & & \text{same} & & 
 \end{array}$$

which determines everything.

- b) Show that if  $\tau$  is the natural transformation of Exercise 4, then  $\tau_{\mathbb{Z}_2} = 0$ . Hint: Exact sequences involving  $F(\mathbb{Z}_2)$  and  $\mathcal{L}_0 F(\mathbb{Z}_2)$  have very different homomorphisms.
- c) Write down a projective resolution of  $\mathbb{Z}_2$ , and directly compute  $\mathcal{L}_n F(\mathbb{Z}_2)$  and  $\tau_{\mathbb{Z}_2}$ .

- 6. Show that the maps  $d'_n$  defined in the proof of Proposition 6.5(a) have the required properties.
- 7. Prove part (b) of Proposition 6.5.
- 8. In Example 13 following Proposition 6.5, show that the definitions of  $\pi'$  and  $d'_n$  work, and that nothing else does.
- 9. In the construction of the maps  $d'_n$  in the proof of Proposition 6.5, show that the following are equivalent:
  - i)  $d'_n = d_n \oplus d''_n$  is an allowable choice for all  $n$ .
  - ii)  $d'_1 = d_1 \oplus d''_1$  is an allowable choice.
  - iii)  $0 \rightarrow B \rightarrow B' \rightarrow B'' \rightarrow 0$  splits.

10. Suppose

$$\begin{array}{ccccccc}
 0 & \longrightarrow & P & \longrightarrow & P \oplus P'' & \longrightarrow & P'' \longrightarrow 0 \\
 & & \downarrow \varphi & & \downarrow \varphi' & & \downarrow \varphi'' \\
 0 & \longrightarrow & C & \xrightarrow{\iota} & C' & \xrightarrow{\pi} & C'' \longrightarrow 0
 \end{array}$$

commutes and has exact rows. (The maps  $P \rightarrow P \oplus P'' \rightarrow P''$  are the obvious ones.) Show that

$$\begin{array}{ccc}
 C' & \xleftarrow{\varphi'} & P \oplus P'' \\
 \pi \downarrow & & \uparrow \\
 C'' & \xleftarrow{\varphi''} & P''
 \end{array}$$

commutes, but

$$\begin{array}{ccc} C & \xleftarrow{\varphi} & P \\ \downarrow \iota & & \uparrow \\ C' & \xleftarrow{\varphi'} & P \oplus P'' \end{array}$$

does not commute unless  $\varphi'$  is zero on  $0 \oplus P''$  (which cannot happen unless  $\varphi'' = 0$ ).

11. Prove parts (b) and (d) of Proposition 6.11. For this, formulate and prove the analog of Proposition 6.9 for short exact sequences of injectives. See also Exercise 10.
12. Suppose  $0 \rightarrow B \rightarrow B' \rightarrow B'' \rightarrow 0$  is short exact in  ${}_R\mathbf{M}$ , and  $C \in {}_R\mathbf{M}$ . Let  $\delta_n : \text{Ext}^{n-1}(B, C) \rightarrow \text{Ext}^n(B'', C)$  denote the connecting homomorphism of the long exact sequence of Proposition 3.13, obtained from an injective resolution of  $C$ . Let  $\tilde{\delta}_n : \text{Ext}^{n-1}(B, C) \rightarrow \text{Ext}^n(B'', C)$  denote the connecting homomorphism of Theorem 6.6(c), with  $\text{Ext}^n(\bullet, C) \approx \mathcal{L}^n \text{Hom}(\bullet, C)$ , obtained from a simultaneous projective resolution of  $0 \rightarrow B \rightarrow B' \rightarrow B'' \rightarrow 0$ . Show that  $\tilde{\delta}_n = (-1)^n \delta_n$ .
13. Suppose  $0 \rightarrow C \rightarrow C' \rightarrow C'' \rightarrow 0$  is short exact in  ${}_R\mathbf{M}$ , and  $B \in {}_R\mathbf{M}$ . Let  $\delta_n : \text{Ext}^{n-1}(B, C'') \rightarrow \text{Ext}^n(B, C)$  denote the connecting homomorphism of Theorem 3.4(b), obtained from a projective resolution of  $B$ . Let  $\tilde{\delta}_n : \text{Ext}^{n-1}(B, C'') \rightarrow \text{Ext}^n(B, C)$  denote the connecting homomorphism of Theorem 6.6(b), with  $\text{Ext}^n(B, \bullet) \approx \mathcal{R}_n \text{Hom}(B, \bullet)$ , obtained from a simultaneous injective resolution of  $0 \rightarrow C \rightarrow C' \rightarrow C'' \rightarrow 0$ . Show that  $\tilde{\delta}_n = (-1)^n \delta_n$ .
14. Suppose  $H_n$  and  $\tilde{H}_n$  are covariant functors from  ${}_R\mathbf{M}$  to  $\mathbf{Ab}$ , and suppose  $\tau_n$  is a natural isomorphism of  $H_n$  with  $\tilde{H}_n$ . Suppose  $H_0 = \tilde{H}_0$ , and  $\tau_{0,B} = i_{H_0(B)}$ . Suppose, given  $0 \rightarrow B \rightarrow B' \rightarrow B'' \rightarrow 0$ , we have  $\delta_n : H_{n+1}(B'') \rightarrow H_n(B)$  and  $\tilde{\delta}_n : \tilde{H}_{n+1}(B'') \rightarrow \tilde{H}_n(B)$  such that

$$\begin{array}{ccc} H_{n+1}(B'') & \xrightarrow{\tau_{n+1, B''}} & \tilde{H}_{n+1}(B'') \\ \delta_n \downarrow & & \downarrow (-1)^n \tilde{\delta}_n \\ H_n(B) & \xrightarrow{\tau_{n, B}} & \tilde{H}_n(B) \end{array}$$



commutes. Explain how to modify the  $\tau_n$  to  $\hat{\tau}_n$  (retaining  $\hat{\tau}_0 = \text{identity}$ ) so that

$$\begin{array}{ccc} H_{n+1}(B'') & \xrightarrow{\hat{\tau}_{n+1, B''}} & \tilde{H}_{n+1}(B'') \\ \delta_n \downarrow & & \downarrow \tilde{\delta}_n \\ H_n(B) & \xrightarrow{\hat{\tau}_{n, B}} & \tilde{H}_n(B) \end{array}$$

commutes.

15. Suppose  $\tau$  is a natural transformation from  $F$  to  $G$ , where  $F$  and  $G$  are covariant functors from  ${}_R\mathbf{M}$  to  ${}_S\mathbf{M}$ , and suppose  $\tau_B$  is an isomorphism for all  $B$ . Set  $\sigma_B = \tau_B^{-1}$ . Show that  $\sigma$  is a natural transformation from  $G$  to  $F$ . (It is the inverse of  $\tau$ .)



# 7

## Abstract Homological Algebra

### 7.1 Living Without Elements

A close look at much of the earlier material, especially in the last chapter, reveals the strong connection between projectives and injectives. The idea is this: Formulate your result purely in terms of arrows (morphisms), then reverse them. That is, work in the opposite category. Not everything can be done this way, but a surprising amount can.

The immediate objective is to produce category-theoretic analogs of some of the function-theoretic concepts of which we have already made use. Suppose  $\mathbf{C}$  is a category,  $A, B \in \mathbf{C}$ , and  $f \in \text{Mor}(A, B)$ .

- i)  $f$  is a **monomorphism** (adjective form being *monic*) if, whenever  $C \in \mathbf{C}$ , and  $g, h \in \text{Mor}(C, A)$ , then  $fg = fh \Rightarrow g = h$ . That is,  $f$  is left-cancellable.
- ii)  $f$  is an **epimorphism** (adjective form being *epic*) if, whenever  $C \in \mathbf{C}$ , and  $g, h \in \text{Mor}(B, C)$ , then  $gf = hf \Rightarrow g = h$ . That is,  $f$  is right-cancellable.
- iii)  $f$  is a **bimorphism** (no adjective form) if  $f$  is both a monomorphism and an epimorphism.

Observe that if  $f$  and  $g$  are monic, then so is  $fg$ ; and if  $fg$  is monic, then  $g$  is monic. Similarly, if  $f$  and  $g$  are epic, then so is  $fg$ ; and if  $fg$  is epic, then  $f$  is epic.

Suppose  $\mathbf{C}$  is a concrete category, and  $\sigma(A) =$  underlying set of  $A$ . Then for  $A, B \in \mathbf{C}$  and  $f \in \text{Mor}(A, B)$ : If  $f$  is one-to-one, then  $f$  is monic; if

$f$  is onto, then  $f$  is epic. Also, note that, in any category, isomorphisms are bimorphisms. A category is called *balanced* if all bimorphisms are isomorphisms.

**Example 14** Let **Haus** denote the category of Hausdorff topological spaces, with morphisms being continuous functions. If  $A, B \in \mathbf{Haus}$ , and  $f \in \text{Mor}(A, B)$ , then  $f$  is monic  $\Leftrightarrow f$  is one-to-one, while  $f$  is epic  $\Leftrightarrow f(A)$  is dense in  $B$ . Note also that if  $A = (\mathbb{R}, \text{discrete topology})$ ,  $B = (\mathbb{R}, \text{usual topology})$ , and  $f = i_{\mathbb{R}}$ , then  $f$  is a bimorphism (even a bijection), but not an isomorphism.

It should be noted that in **Top**, the category of all topological spaces, an epimorphism must be onto. (If  $f$  is not onto, let  $C = \{0, 1\}$  have the indiscrete topology, set  $g \equiv 0$ , and set  $h = 0$  on  $f(A)$ , but  $h = 1$  on  $B - f(A)$ .)

**Example 15**  $\text{obj}\mathbf{C} = \{\{0, 1\}, \{0, 1, 2\}\}$ ; set  $A = \{0, 1\}$  and  $B = \{0, 1, 2\}$ . Set  $\text{Mor}(A, A) = \{i_A\}$ ,  $\text{Mor}(B, B) = \{i_B\}$ ,  $\text{Mor}(B, A) = \emptyset$ , and  $\text{Mor}(A, B) = \text{all functions from } A \text{ to } B$ . **C** is a subcategory of **Set**, and is concrete, with  $\sigma(A) = A$ ,  $\sigma(B) = B$ . Every function in  $\text{Mor}(A, B)$ , whether one-to-one or not (none are onto), is a bimorphism.(!)

It should be remarked that the failure of bimorphisms to be isomorphisms is fairly common, even for algebraic categories;  ${}_R\mathbf{Sh}$  is an example to be discussed later. The failure of epimorphisms to be onto is rare in the algebraic setting but common for topological categories. The failure of monomorphisms to be one-to-one is rare, generally; most counterexamples have the odor of artificiality possessed by the last example. The reader is invited to examine the concepts in various categories. One final note: Epimorphisms in the category **Gr** of groups really are onto, and this is not obvious. See Exercise 1 for a description of how this goes.

Now some more concepts. Suppose **C** is a category, and  $A \in \mathbf{C}$ .

- i)  $A$  is an *initial object* if  $\text{Mor}(A, B)$  is a singleton for all  $B \in \mathbf{C}$ .
- ii)  $A$  is a *final object* if  $\text{Mor}(B, A)$  is a singleton for all  $B \in \mathbf{C}$ .
- iii)  $A$  is a *zero object* if  $A$  is both an initial object and a final object.

**Example 16** In **Set**,  $\emptyset$  is an initial object, and any singleton is a final object.

**Example 17** In **Gr**, the trivial group is a zero object.

**Example 18** Let **Top\*** denote the category of pointed topological spaces, that is, ordered pairs  $(X, x)$ , where  $X$  is a topological space and  $x \in X$ . A morphism from  $(X, x)$  to  $(Y, y)$  is a continuous  $f : X \rightarrow Y$  for which  $f(x) = y$ . Then any  $(\{x\}, x)$  is a zero object.

**Example 19** Let  $X$  be a topological space, and set  $\text{obj}\mathbf{C} =$  all open subsets of  $X$ , with  $\text{Mor}(U, V) = \{\text{inclusion } U \hookrightarrow V\}$  if  $U \subset V$ , and  $\text{Mor}(U, V) = \emptyset$  if  $U \not\subset V$ . Then  $\emptyset$  is an initial object and  $X$  is a final object.

Note that initial objects, final objects, and zero objects are unique up to isomorphism. The usual routine applies, once one recognizes that basically a final object is a product over an empty index set while an initial object is a coproduct over an empty set. For a final object  $A$ , for example, a unique filler  $B \rightarrow A$  must exist for each  $B$ , making the empty collection of diagrams

Intentionally

left blank

commute. Note also that any morphism *into* an initial object is epic, while any morphism *from* a final object is monic. Also, if  $A$  is either an initial object or a final object, then  $\text{Mor}(A, A) = \{i_A\}$ . Finally, if a zero object  $Z$  exists, then composing the elements of  $\text{Mor}(A, Z)$  and  $\text{Mor}(Z, B)$  yields a  $0 \in \text{Mor}(A, B)$ ; this definition of  $0$  is independent of the zero object  $Z$  (see Exercise 2).

We have one last sequence of definitions generalizing to arbitrary categories some of the module-theoretic concepts of Chapter 2.

i) An object  $P$  is *projective* if a filler exists for any diagram

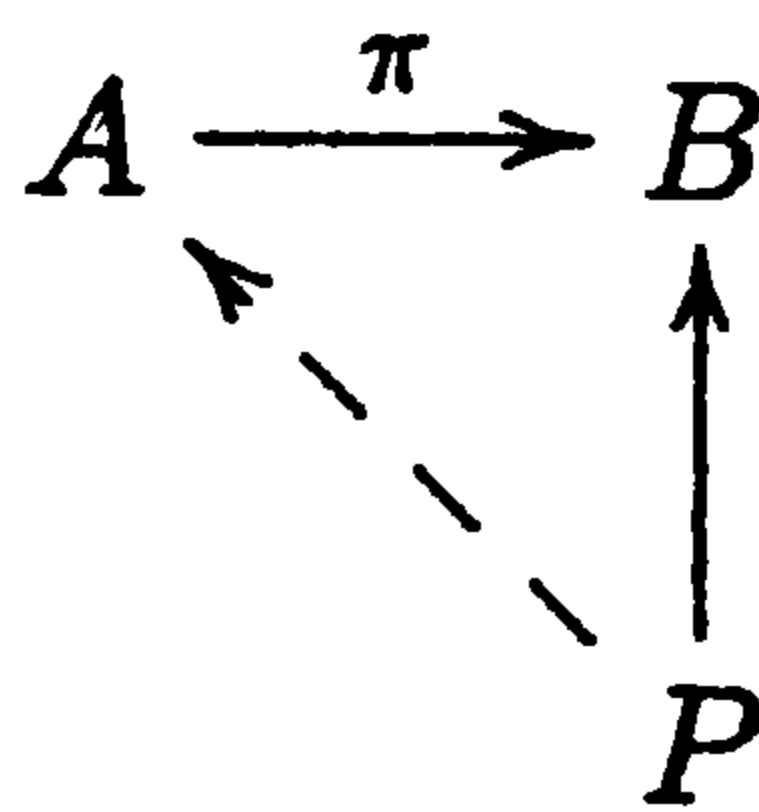

for which  $\pi$  is epic.

ii) An object  $E$  is *injective* if a filler exists for any diagram

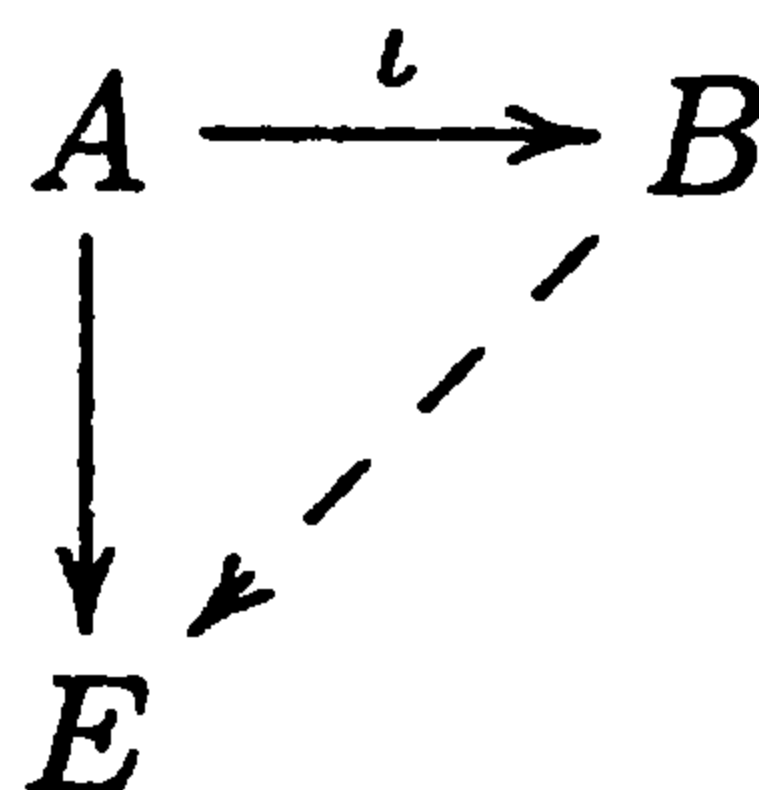

for which  $\iota$  is monic.



The main thing to note is that the definitions are purely category-theoretic. A category  $\mathbf{C}$  has a *separating class of projectives* if, given any pair of morphisms  $f, g \in \text{Mor}(A, B)$ , with  $f \neq g$ , there exist a projective  $P$  and  $h \in \text{Mor}(P, A)$  such that  $fh \neq gh$ .  $\mathbf{C}$  has *enough projectives* if, given any object  $A \in \mathbf{C}$ , there exists a projective  $P$  and an epimorphism  $\pi \in \text{Mor}(P, A)$ . Observe that “enough projectives”  $\implies$  “separating class of projectives”. Refining “separating class” further, a *separating set of projectives* is a set of projectives from which the  $P$ 's above can be selected. A [projective] *separator* is a single  $P$  which does the job. Reversing all arrows (i.e., working in  $\mathbf{C}^{\text{op}}$ ), one defines *coseparating class of injectives*, *enough injectives*, *coseparating set of injectives*, and [injective] *coseparator* analogously.

**Example 20** In  $\mathbf{Set}$ , any set is projective (axiom of choice), and any nonempty set is injective. (So it has global projective dimension zero and global injective dimension one. Arggh.)

**Example 21** In  $\mathbf{Haus}$ , only the empty space is projective, and only singletons are injective. (Exercise for the topologically inclined.)

One final example: In the category of compact Hausdorff spaces,  $[0, 1]$  is injective, thanks to the Tietze extension theorem.

Projectives can often be manufactured using free objects, but some care is needed. Recall that if  $\mathbf{C}$  is a concrete category, and if  $\sigma(A)$  denotes the underlying set of  $A$ , then “ $F$  is free on a set  $S$ ” means we have a set mapping  $\varphi : S \rightarrow \sigma(F)$  such that whenever  $\psi : S \rightarrow \sigma(A)$  is a set mapping (with  $A \in \mathbf{C}$ ), there exists a unique  $f$  such that the diagram

$$f \in \text{Mor}(F, A) \subset \sigma(A)^{\sigma(F)} : \begin{array}{ccc} & & \sigma(A) \\ & \nearrow \psi & \uparrow \\ S & & f \\ & \searrow \varphi & \downarrow \\ & & \sigma(F) \end{array}$$

is commutative.

*Let  $\mathbf{C}$  be a concrete category in which epimorphisms are onto as set mappings of the underlying sets. Then all free objects are projective.*

This is left as an exercise (Exercise 3) and we will not make any specific use of it. Nevertheless, it is suggestive. Note that in  $\mathbf{Haus}$ , the free object on  $S$  exists; it is just  $S$  with the discrete topology. Unless  $S$  is empty, it is not projective.

We seem to be ready to do homological algebra in *any* category having enough projectives, but we're not. What would a “kernel” be? For that we need more.

## 7.2 Additive Categories

In the closing paragraph of the last section, the possible significance of a category-theoretic notion of “kernel” arose. This would seem to suggest that we must stick to subcategories of  $\mathbf{Gr}$ , where kernels first arise. This turns out *not* to be the case, a fortunate circumstance. However, some kind of group structure is required. The point here is to place it on the morphism sets. That way it can interact with composition. Since the homomorphisms from one (non-Abelian) group to another do not form an appropriate algebraic object, we shall stick to Abelian groups. The result is called an *additive category*. It is not just a special type of category, any more than a group is a special type of set. It has additional structure, whose presence we shall emphasize (for a short while) by being disgustingly strict about notation.

If  $G$  is a group, let  $\sigma(G)$  denote the underlying set of  $G$ . An additive category  $\mathbf{A}$  consists of three things: a class  $\text{obj}\mathbf{A}$  of objects; a function  $\text{Hom} : \text{obj}\mathbf{A} \times \text{obj}\mathbf{A} \rightarrow \text{obj}\mathbf{A}^b$ ; and a composition rule, subject to the following (with  $\text{Mor} = \sigma \circ \text{Hom}$ ):

i)  $\text{obj}\mathbf{A}$ ,  $\text{Mor}$ , and the composition rule constitute a category.

ii) If  $A, B, C \in \text{obj}\mathbf{A}$ , then

$$\text{composition} : \text{Mor}(B, C) \times \text{Mor}(A, B) \rightarrow \text{Mor}(A, C)$$

is  $\mathbb{Z}$ -bilinear relative to the group structures that  $\text{Mor}(\bullet, \bullet)$  is endowed with via  $\text{Hom}(\bullet, \bullet)$ .

iii) The category defined by  $\text{obj}\mathbf{A}$ ,  $\text{Mor}$ , and the composition rule, contains a zero object.

Before returning to our usual terminological shorthand, note that the difference between  $\text{Hom}(A, B)$  and  $\text{Mor}(A, B)$  is *precisely* the difference between a group and its underlying set. Ordinarily in algebra, it is not dangerous to be sloppy about this distinction, and the same holds here. Ordinarily. But not always, so again the notation “Hom” will be used to emphasize the additional structure present.

It should be noted that what we have is a special example of an “augmented category,” a loose notion described as follows. Let  $\mathbf{C}$  be any concrete category, and let  $\sigma : \text{obj}\mathbf{C} \rightarrow \mathbf{Set}$  be the function that picks off the underlying set of an object of  $\mathbf{C}$ . A  $\mathbf{C}$ -augmented category  $\mathbf{D}$  consists of three things: a class of objects  $\text{obj}\mathbf{D}$ ; a function  $\text{Hom} : \text{obj}\mathbf{D} \times \text{obj}\mathbf{D} \rightarrow \text{obj}\mathbf{C}$ ; and a composition rule, subject to the following (setting  $\text{Mor} = \sigma \circ \text{Hom}$ ):

i)  $\text{obj}\mathbf{D}$ ,  $\text{Mor}$ , and the composition rule constitute a category.

ii) If  $A, B, C \in \text{obj}\mathbf{D}$ , then

- ii a) For all  $f \in \text{Mor}(A, B)$ , the map  $g \mapsto gf$  from  $\text{Mor}(B, C)$  to  $\text{Mor}(A, C)$  is the underlying set mapping of a  $\mathbf{C}$ -morphism.
- ii b) For all  $g \in \text{Mor}(B, C)$ , the map  $f \mapsto gf$  from  $\text{Mor}(A, B)$  to  $\text{Mor}(A, C)$  is the underlying set mapping of a  $\mathbf{C}$ -morphism.

iii) Whatever else is required.

(iii) varies with the situation. (“Augmented” is *loosely* defined!) Making (iii) read “ $\mathbf{D}$  has a zero object” defines an additive category as an **Ab**-augmented category. When  $\mathbf{C} = \mathbf{Top}$ , (iii) ordinarily requires joint continuity of composition. **LCH**, the category of locally compact Hausdorff spaces, then becomes a **Top**-augmented category if the morphism sets are equipped with the compact-open topology. Finally, if  $R$  is commutative, then  ${}_R\mathbf{M}$  is an  ${}_R\mathbf{M}$ -augmented category (!): (iii) includes the rest of  $R$ -bilinearity for composition (as well as existence of a zero object) for  ${}_R\mathbf{M}$ -augmented categories.

Now back to additive categories, with our usual notational shorthand. An additive category is now a triplet consisting of a class of objects  $\text{obj}\mathbf{A}$ , morphism Abelian groups  $\text{Hom}(A, B)$  for  $A, B \in \text{obj}\mathbf{A}$ , and a bilinear composition rule, which combine to form a category with a zero object. The first question leaping to mind is, “Why must there be a zero object?” Good question. To see the answer, look back at Exercise 1 in the last chapter. The zero homomorphism from one module to another is precisely the homomorphism that factors through the zero module. That is, the zero homomorphism can be identified purely in category-theoretic terms (aha!), since that is how the zero objects are defined. Bilinearity guarantees that this continues to hold in any additive category.

**Example 22**  ${}_R\mathbf{M}$  and  $\mathbf{M}_R$  are additive categories, any  $R$ . So is  ${}_R\mathbf{M}_S$ , for any two rings  $R$  and  $S$ .

**Example 23** If  $G$  is your favorite nontrivial Abelian group, then  $\{G\}$  and  $\text{Hom}_{\mathbf{Z}}(G, G)$  do *not* form an additive category, since it has no zero object. However,  $\{G, O\}$ , with  $O$  the trivial group, *is* an additive category (with “Hom” being  $\text{Hom}_{\mathbf{Z}}$ .)

Before going on to results, a few comments are in order about the overall drift. First, we introduced in the last section some categorical analogs of earlier concepts. There is a limit to how far this can go; the word “kernel” formed a stopping point. Next, we introduced further structure on the category, producing an additive category. After discussing some results and constructions, we shall define a pre-Abelian category to be an additive category in which certain universal constructions can be carried out. Finally, we shall make two technical assumptions about pre-Abelian categories in order to define Abelian categories. These technical assumptions are abstracted from known properties of  ${}_R\mathbf{M}$ . It is hoped that this will give some



coherence to the subject. By the way, the assumptions *do* restrict things:  $\mathbf{Gr}$  is not additive; the category in the last example above is additive but (usually) not pre-Abelian; and  ${}_R\mathbf{Sh}$  is pre-Abelian but not Abelian.

As for results, we start with products, biproducts, and direct sums (still the preferred term for a coproduct in an additive category). If  $\mathbf{A}$  is an additive category, then a *biproduct*  $(A; \varphi_1, \varphi_2, \pi_1, \pi_2)$  of two objects  $A_1, A_2$  in  $\mathbf{A}$  is a quintuplet, with  $\pi_j \in \text{Hom}(A, A_j)$  and  $\varphi_j \in \text{Hom}(A_j, A)$ ,  $j = 1, 2$ , satisfying  $\pi_1\varphi_1 = i_{A_1}$ ,  $\pi_2\varphi_2 = i_{A_2}$ , and  $\varphi_1\pi_1 + \varphi_2\pi_2 = i_A$ .

**Proposition 7.1** *Suppose  $\mathbf{A}$  is an additive category, and suppose  $(A; \varphi_1, \varphi_2, \pi_1, \pi_2)$  is a biproduct of  $A_1$  and  $A_2$ . Then  $\pi_1\varphi_2 = 0$ , and  $\pi_2\varphi_1 = 0$ . Also,*

$$A_1 \xrightarrow{\varphi_1} A \xleftarrow{\varphi_2} A_2$$

*defines a direct sum, and*

$$A_1 \xleftarrow{\pi_1} A \xrightarrow{\pi_2} A_2$$

*defines a (direct) product.*

**Proof:** Identical, word for word, with the proof of Proposition 2.1 (except that  $\mathbf{A}$  replaces  ${}_R\mathbf{M}$  and the letter  $A$  replaces  $B$ ).  $\square$

**Proposition 7.2** *Suppose  $\mathbf{A}$  is an additive category, and suppose*

$$A_1 \xrightarrow{\varphi_1} A \xleftarrow{\varphi_2} A_2$$

*defines a direct sum in  $\mathbf{A}$ . Then there exist unique  $\pi_j \in \text{Hom}(A, A_j)$ ,  $j = 1, 2$ , such that  $(A; \varphi_1, \varphi_2, \pi_1, \pi_2)$  is a biproduct of  $A_1$  and  $A_2$ .*

**Proof:** From Proposition 7.1 above,  $\pi_1$  and  $\pi_2$  are fillers for

$$\begin{array}{ccc} A_1 & \xrightarrow{\varphi_1} & A & \xleftarrow{\varphi_2} & A_2 \\ & \searrow & \downarrow & \swarrow & \\ & i_{A_1} & \psi & 0 & \\ & & \downarrow & & \\ & & A_1 & & \end{array} \quad \begin{array}{ccc} A_1 & \xrightarrow{\varphi_1} & A & \xleftarrow{\varphi_2} & A_2 \\ & \searrow & \downarrow & \swarrow & \\ & 0 & \psi & i_{A_2} & \\ & & \downarrow & & \\ & & A_2 & & \end{array}$$

and these fillers exist uniquely by the definition of a direct sum (coproduct). All we must now check is that  $\varphi_1\pi_1 + \varphi_2\pi_2 = i_A$ . Set  $\psi = \varphi_1\pi_1 + \varphi_2\pi_2$ . Note that

$$\begin{aligned} \psi\varphi_1 &= (\varphi_1\pi_1 + \varphi_2\pi_2)\varphi_1 \\ &= \varphi_1\pi_1\varphi_1 + \varphi_2\pi_2\varphi_1 \\ &= \varphi_1i_{A_1} + \varphi_20 \\ &= \varphi_1 \end{aligned}$$

Similarly,  $\psi\varphi_2 = \varphi_2$ . That is,  $\psi$  is a filler for

$$\begin{array}{ccccc}
 A_1 & \xrightarrow{\varphi_1} & A & \xleftarrow{\varphi_2} & A_2 \\
 & \searrow \varphi_1 & \downarrow \psi & \swarrow \varphi_2 & \\
 & & A & & 
 \end{array}$$

But this filler is unique, and  $i_A$  works, so  $\psi = i_A$ .  $\square$

**Corollary 7.3** *Suppose  $\mathbf{A}$  is an additive category, and suppose*

$$A_1 \xleftarrow{\pi_1} A \xrightarrow{\pi_2} A_2$$

*defines a product in  $\mathbf{A}$ . Then there exist unique  $\varphi_j \in \text{Hom}(A_j, A)$ ,  $j = 1, 2$ , such that  $(A; \varphi_1, \varphi_2, \pi_1, \pi_2)$  is a biproduct of  $A_1$  and  $A_2$ .*

**Proof:**  $A$ ,  $\pi_1$ , and  $\pi_2$  define a coproduct in the additive category  $\mathbf{A}^{\text{op}}$ ; use Proposition 7.2.  $\square$

At this point we note that many (perhaps most) authors require additive categories to possess biproducts of any two objects. Others do not. The following proposition provides evidence for both points of view.

**Proposition 7.4** *Suppose  $\mathbf{A}$  and  $\mathbf{A}'$  are two additive categories, and suppose  $\mathbf{A}$  contains a biproduct of any two objects. Suppose  $F : \mathbf{A} \rightarrow \mathbf{A}'$  is a covariant functor. Then the following are equivalent.*

- i)  $F$  is additive, that is,  $F(f + g) = F(f) + F(g)$  for any  $f, g \in \text{Hom}(A, B)$ ;  $A, B \in \mathbf{A}$ .
- ii)  $F(A_1 \oplus A_2) \approx F(A_1) \oplus F(A_2)$  for all  $A_1, A_2 \in \mathbf{A}$ .
- iii)  $F(A \oplus A) \approx F(A) \oplus F(A)$  for all  $A \in \mathbf{A}$ .

**Remark:** As with Proposition 6.1, tacitly " $F(A \oplus B) \approx F(A) \oplus F(B)$ " means that if

$$A \xrightarrow{\varphi} A \oplus B \xleftarrow{\psi} B$$

defines  $A \oplus B$  as a coproduct, then

$$F(A) \xrightarrow{F(\varphi)} F(A \oplus B) \xleftarrow{F(\psi)} F(B)$$

defines  $F(A \oplus B)$  as a coproduct.

**Proof:** (i)  $\Rightarrow$  (ii)  $\Rightarrow$  (iii)  $\Rightarrow$  (i) works the same way here as it did in Proposition 6.1. The technical point—that  $F(\pi_1)$  and  $F(\pi_2)$  are the  $\pi'_1$  and  $\pi'_2$  for which  $(F(A \oplus A); F(\varphi_1), F(\varphi_2), \pi'_1, \pi'_2)$  is a biproduct in  $\mathbf{A}'$ —is



even the same. To see this, we must establish that  $F(\pi_1)$  and  $F(\pi_2)$  are fillers for the appropriate diagrams in the proof of Proposition 7.2. That is, we must check that  $i_{F(A)} = F(\pi_1)F(\varphi_1) = F(\pi_2)F(\varphi_2)$ , while  $0 = F(\pi_1)F(\varphi_2) = F(\pi_2)F(\varphi_1)$ . But  $i_{F(A)} = F(i_A) = F(\pi_1\varphi_1) = F(\pi_1)F(\varphi_1)$ ; similarly,  $i_{F(A)} = F(\pi_2)F(\varphi_2)$ . Also,  $F(\pi_1)F(\varphi_2) = F(\pi_1\varphi_2) = F(0)$ , and similarly  $F(\pi_2)F(\varphi_1) = F(0)$ , so it suffices to show that  $F(0) = 0$ , that is,  $F(\text{zero morphism}) = \text{zero morphism}$ . Since the zero morphism is precisely the morphism which factors through “the” zero object (both in  $\mathbf{A}$  and  $\mathbf{A}'$ ), it suffices to show that  $F(\text{zero object}) = \text{zero object}$ .

Let  $O$  denote a zero object of  $\mathbf{A}$ . Note that  $(O; i, i, i, i)$  is a biproduct of  $O$  with  $O$  in  $\mathbf{A}$ , where  $i = i_O$  is the only element of  $\text{Hom}(O, O)$ . Hence

$$O \xrightarrow{i} O \xleftarrow{i} O$$

is a coproduct in  $\mathbf{A}$ , so

$$F(O) \xrightarrow{F(i)} F(O) \xleftarrow{F(i)} F(O)$$

is a coproduct in  $\mathbf{A}'$ . By Proposition 7.2, there exist unique  $\pi_1, \pi_2 \in \text{Hom}(F(O), F(O))$  such that  $(F(O); F(i), F(i), \pi_1, \pi_2)$  is a biproduct. Letting  $F(i)$  play the role of  $\varphi_1$ ,  $i_{F(O)} = \pi_1 F(i)$ . Letting  $F(i)$  play the role of  $\varphi_2$ ,  $\pi_1 F(i) = 0$ . Hence  $i_{F(O)} = 0$ , so  $F(O)$  is a zero object. (See Exercise 4.)  $\square$

Note that, in the above,  $\mathbf{A}'$  did not have to contain biproducts, but it did have to contain a zero object.

In the next section we shall describe two more constructions whose presence (with biproducts) specify a pre-Abelian category.

## 7.3 Kernels and Cokernels

We are now very close to what we need for homological algebra in the abstract, at least for the domain category. We start with an additive category  $\mathbf{A}$ . Suppose  $A, B \in \mathbf{A}$ , and  $f \in \text{Hom}(A, B)$ . What we need is some way of defining categorically the objects we are used to having around for modules. They are the kernel, the image, and the cokernel. The image will be a bit of a problem at this stage, so we shall stick to the kernel and cokernel for now.

A *kernel* of  $f$  is defined in category-theoretic terms as follows. A kernel consists of an object  $K \in \mathbf{A}$  and a morphism  $j \in \text{Hom}(K, A)$  such that  $fj = 0$  and, whenever  $C \in \mathbf{A}$  and  $g \in \text{Hom}(C, A)$  satisfies  $fg = 0$ ,

there exists a unique filler  $\bar{g}$

$$\begin{array}{ccccc}
 K & \xrightarrow{j} & A & \xrightarrow{f} & B \\
 & \swarrow \bar{g} & \uparrow g & & \\
 & & C & & 
 \end{array}
 \quad fg = 0$$

forming a commutative diagram. Note that since the definition is categorical, a kernel is only unique up to isomorphism (see below). This is a general phenomenon that one must simply get used to. Abusing the terminology a bit, we shall often say that  $j$  is a kernel for  $f$ .

A *cokernel* of  $f$  is defined similarly, with arrows reversed. A cokernel consists of an object  $D \in \mathbf{A}$  and a morphism  $p \in \text{Hom}(B, D)$  such that  $pf = 0$  and whenever  $C \in \mathbf{A}$  and  $g \in \text{Hom}(B, C)$  satisfies  $gf = 0$ , there exists a unique filler  $\bar{g}$

$$\begin{array}{ccccc}
 A & \xrightarrow{f} & B & \xrightarrow{p} & D \\
 & & \downarrow g & \swarrow \bar{g} & \\
 & & C & & 
 \end{array}
 \quad gf = 0$$

forming a commutative diagram. If  $\mathbf{A} = {}_R\mathbf{M}$ , some  $R$ , then  $D = B/f(A)$  works.

Note that a cokernel in  $\mathbf{A}$  is a kernel in  $\mathbf{A}^{\text{op}}$ . Also, one can use an “overcategory” to define a kernel: Given  $A, B$ , and  $f \in \text{Hom}(A, B)$ , consider the category of all pairs  $(C, g)$  such that  $C \in \mathbf{A}$ ,  $g \in \text{Hom}(C, A)$ , and  $fg = 0$ . A morphism from  $(C, g)$  to  $(D, h)$  is a  $\varphi \in \text{Hom}(C, D)$  such that  $g = h\varphi$ , that is,

$$\begin{array}{ccccc}
 & & D & & \\
 & & \uparrow \varphi & \searrow h & \\
 & & C & \xrightarrow{g} & A & \xrightarrow{f} & B
 \end{array}$$

commutes. Then a kernel is a final object in this category. (See Exercise 6.) In particular, any two kernels are isomorphic in this category, hence are isomorphic in  $\mathbf{A}$ . Similar considerations, with arrows reversed, apply to cokernels.

Suppose one has a commutative square

$$\begin{array}{ccc}
 A & \xrightarrow{f} & B \\
 \downarrow \varphi & & \downarrow \psi \\
 A' & \xrightarrow{f'} & B'
 \end{array}$$

If kernels are taken, one has a diagram

$$\begin{array}{ccccc} K & \xrightarrow{j} & A & \xrightarrow{f} & B \\ & & \downarrow \varphi & & \downarrow \psi \\ K' & \xrightarrow{j'} & A' & \xrightarrow{f'} & B'; \end{array}$$

in which  $f'(\varphi j) = f'\varphi j = \psi f j = 0$ . Hence  $\varphi j$  factors through  $K'$ :

$$\begin{array}{ccccc} K & \xrightarrow{j} & A & \xrightarrow{f} & B \\ \downarrow & & \downarrow \varphi & & \downarrow \psi \\ K' & \xrightarrow{j'} & A' & \xrightarrow{f'} & B'. \end{array}$$

Similarly, attaching cokernels produces a commutative rectangle

$$\begin{array}{ccccccc} K & \longrightarrow & A & \xrightarrow{f} & B & \longrightarrow & D \\ \downarrow & & \downarrow \varphi & & \downarrow \psi & & \downarrow \\ K' & \longrightarrow & A' & \xrightarrow{f'} & B' & \longrightarrow & D'. \end{array}$$

Given later developments, one can make a functorial interpretation of all this; this will be done in Section 7.5.

We now make a definition: An additive category  $\mathbf{A}$  is *pre-Abelian* if it contains a biproduct of any two objects, and if any morphism has both a kernel and a cokernel. It turns out that to make a start on abstract homological algebra, all we need for our domain category is a pre-Abelian category with enough projectives and/or enough injectives. Further conditions then force, for example,  $\text{Ext}^0 \approx \text{Hom}$ . (It should probably be noted that there are ways of manufacturing  $\text{Ext}$  without using projectives or injectives. They are less than transparent and are inappropriate for this book. See, for example, Hilton [33, Chapter 4].) When we abstract the range category, we shall need more.

A couple of quick remarks are in order. First of all, by the usual subtraction trickery, if  $f \in \text{Hom}(A, B)$ , then  $f$  is an epimorphism  $\iff (\forall C \in \mathbf{A}, g \in \text{Hom}(B, C) : gf = 0 \Rightarrow g = 0)$ , and  $f$  is a monomorphism  $\iff (\forall C \in \mathbf{A}, g \in \text{Hom}(C, A) : fg = 0 \Rightarrow g = 0)$ . That is, “right cancellable” means “right nonzero divisor”, and ditto on the left. More subtle is the fact that kernels are monic. Suppose  $f \in \text{Hom}(A, B)$ , with kernel  $j : K \rightarrow A$ . Then  $j$  is monic. To see this, suppose  $g \in \text{Hom}(C, K)$  and  $fg = 0$ . Then  $g$  is a filler for

$$\begin{array}{ccccc} & & K & \xrightarrow{j} & A & \xrightarrow{f} & B \\ & & \swarrow & & \uparrow & & \\ & & & & C & & \\ & & \searrow & & \uparrow & & \\ & & & & 0 & & \end{array}$$

But 0 is also a filler, so  $g = 0$  by uniqueness. Similarly, if  $p : B \rightarrow D$  is a cokernel of  $f$ , then  $p$  is epic. One of the simplest ways of defining an Abelian category (there are several) is to require of a pre-Abelian category that this be reversible: Monomorphisms should be kernels and epimorphisms should be cokernels. We shall return to this in a while.

**Example 24**  ${}_R\text{Sh}$ , the category of short exact sequences from  ${}_R\text{M}$ . This category is pre-Abelian. To see this, note that it is additive in the obvious way (adding components). Also,  $(0 \rightarrow A \rightarrow B \rightarrow C \rightarrow 0) \oplus (0 \rightarrow A' \rightarrow B' \rightarrow C' \rightarrow 0)$  is  $0 \rightarrow A \oplus A' \rightarrow B \oplus B' \rightarrow C \oplus C' \rightarrow 0$ . Finally, we have the diagram

$$\begin{array}{ccccccc}
 & & 0 & & 0 & & 0 \\
 & & \downarrow & & \downarrow & & \downarrow \\
 & & K_1 & \hookrightarrow & B_1 & \xrightarrow{f} & C_1 & \longrightarrow & D_1 \\
 & & \downarrow i' & & \downarrow i & & \downarrow j & & \downarrow \bar{j} \\
 & & K_2 & \hookrightarrow & B_2 & \xrightarrow{g} & C_2 & \longrightarrow & D_2 \\
 & & \downarrow p' & & \downarrow p & & \downarrow q & & \downarrow \bar{q} \\
 & & K_3 & \hookrightarrow & B_3 & \xrightarrow{h} & C_3 & \longrightarrow & D_3 \\
 & & & & \downarrow & & \downarrow & & \downarrow \\
 & & & & 0 & & 0 & & 0
 \end{array}$$

from Proposition 6.4. The fact that  $K_3$  connects to  $D_1$  rather than 0 makes it seem like we don't have a kernel (or cokernel). Certainly  $0 \rightarrow K_1 \rightarrow K_2 \rightarrow K_3$  will not do for the kernel, since it is not short exact. But  $0 \rightarrow K_1 \rightarrow K_2 \rightarrow p'(K_2) \rightarrow 0$  will. In fact, if  $0 \rightarrow A_1 \rightarrow A_2 \rightarrow A_3 \rightarrow 0$  maps into  $0 \rightarrow B_1 \rightarrow B_2 \rightarrow B_3 \rightarrow 0$ , with composite into  $0 \rightarrow C_1 \rightarrow C_2 \rightarrow C_3 \rightarrow 0$  being 0, then it factors (uniquely) through  $0 \rightarrow K_1 \rightarrow K_2 \rightarrow p'(K_2) \rightarrow 0$ . (See Exercise 7.) Similarly,  $0 \rightarrow \ker \bar{q} \rightarrow D_2 \rightarrow D_3 \rightarrow 0$  serves as a cokernel.

The category  ${}_R\mathbf{Sh}$  shows its bizarre nature in other ways. For example,

$$\begin{array}{ccc}
 0 & & 0 \\
 \downarrow & & \downarrow \\
 0 & \xrightarrow{0} & B_1 \\
 \downarrow & & \downarrow j \\
 B_2 & \xrightarrow{i_{B_2}} & B_2 \\
 \downarrow i_{B_2} & & \downarrow p \\
 B_2 & \xrightarrow{p} & B_3 \\
 \downarrow & & \downarrow \\
 0 & & 0
 \end{array}$$

is a bimorphism in  ${}_R\mathbf{Sh}$ , which is neither a kernel, a cokernel, nor an isomorphism (unless  $B_1 = 0$ ). Similarly,  $0 \rightarrow B_1 \rightarrow B_2 \rightarrow B_3 \rightarrow 0$  is projective  $\iff B_1 = 0$  and  $B_2 \approx B_3$  is projective in  ${}_R\mathbf{M}$ . This is nevertheless sufficient to provide enough projectives. (See Exercise 8.)

The following proposition lists the basic properties of kernels and cokernels.

**Proposition 7.5** *Suppose  $\mathbf{A}$  is a pre-Abelian category;  $A, B \in \mathbf{A}$ ;  $f \in \text{Hom}(A, B)$ . Let  $j : K \rightarrow A$  be a kernel of  $f$ , and  $p : B \rightarrow D$  a cokernel of  $f$ .*

- a)  $K$  and  $D$  are unique up to isomorphism.
- b)  $j$  is monic and  $p$  is epic.
- c) If  $\varphi \in \text{Hom}(B, C)$ , and  $\varphi$  is monic, then  $j : K \rightarrow A$  is a kernel for  $\varphi f$ . If  $\psi \in \text{Hom}(C, A)$ , and  $\psi$  is epic, then  $p : B \rightarrow D$  is a cokernel for  $f\psi$ .
- d)  $f$  is monic  $\iff K = 0$ ;  $f$  is epic  $\iff D = 0$ .

**Proof:** (a) and (b) were done earlier. For (c), note that  $\varphi f j = 0$ , and if  $g \in \text{Hom}(E, A)$ , then  $\varphi f g = 0 \iff f g = 0$ , so exactly the same morphisms are asked to factor through  $K$  as through  $\ker(\varphi f)$ . Again,  $D = \text{coker } f\psi$  works the same way in  $\mathbf{A}^{\text{op}}$ .

Finally, for (d),

$$\begin{aligned}
 f \text{ is monic} & \iff \forall C, \forall g \in \text{Hom}(C, A) : (fg = 0 \iff g = 0) \\
 & \iff \forall C, \forall g \in \text{Hom}(C, A) : (fg = 0 \iff g \text{ factors through } 0) \\
 & \iff 0 \text{ is a kernel of } f.
 \end{aligned}$$



By (a),  $K$  is a zero object. The result for  $D$  is the same in  $\mathbf{A}^{\text{op}}$ .  $\square$

We are now in a position to define what exactness means. Unfortunately, there are two distinct ways of doing this.

**Definition 7.6** *Suppose  $\mathbf{A}$  is pre-Abelian, and suppose*

$$A \xrightarrow{f} B \xrightarrow{g} C$$

*is a diagram in  $\mathbf{A}$ , with  $gf = 0$ .*

- a) *This diagram is kernel-exact if, letting  $j : K \rightarrow B$  denote a kernel of  $g$ , the factorization*

$$\begin{array}{ccc} A & \xrightarrow{f} & B \xrightarrow{g} C \\ \downarrow \bar{f} & \searrow & \uparrow j \\ K & & \end{array}$$

*has  $\bar{f}$  epic.*

- b) *This diagram is cokernel-exact if, letting  $p : B \rightarrow D$  denote a cokernel of  $f$ , the factorization*

$$\begin{array}{ccc} A \xrightarrow{f} B & \begin{array}{l} \nearrow g \\ \searrow p \end{array} & \begin{array}{c} C \\ \uparrow \bar{g} \\ D \end{array} \end{array}$$

*has  $\bar{g}$  monic.*

In general, these two definitions do not agree. However, some things do hold in both situations. Specifically, note that  $0 \rightarrow A \rightarrow B$  is kernel-exact if and only if it is cokernel-exact if and only if  $A \rightarrow B$  is monic; see Exercise 9. Similarly,  $A \rightarrow B \rightarrow 0$  is kernel-exact if and only if it is cokernel exact if and only if  $A \rightarrow B$  is epic.

We do need one observation. Suppose  $0 \rightarrow A \rightarrow B \rightarrow C$  is kernel-exact. In the notation of part (a) of the definition,  $\bar{f}$  is epic. Since  $f = j\bar{f}$  is monic (preceding paragraph), it follows that  $\bar{f}$  is monic as well. That is,  $\bar{f}$  is a bimorphism. We thus have:

*Suppose  $\mathbf{A}$  is balanced and pre-Abelian. Then  $0 \rightarrow A \rightarrow B \rightarrow C$  is kernel-exact if and only if  $A \rightarrow B$  is a kernel for  $B \rightarrow C$ . Similarly,  $A \rightarrow B \rightarrow C \rightarrow 0$  is cokernel-exact if and only if  $B \rightarrow C$  is a cokernel for  $A \rightarrow B$ .*

(The “if” parts can be read from the definitions:  $\bar{f} = i_A$ . Recall that a category is balanced when bimorphisms are isomorphisms.)

The above properties are what one needs for the exactness properties of Hom; we shall return to this in Section 7.8. Furthermore, kernel-exactness is exactly what we need when working with projectives. Similarly, cokernel-exactness is what works well for injectives.

**Definition 7.7** Suppose  $\mathbf{A}$  is pre-Abelian, and  $B \in \mathbf{A}$ . A **projective resolution** of  $B$  is a semi-infinite kernel-exact sequence

$$\cdots \rightarrow P_2 \rightarrow P_1 \rightarrow P_0 \rightarrow B \rightarrow 0$$

with all  $P_j$  projective. An **injective resolution** of  $B$  is a semi-infinite cokernel-exact sequence

$$0 \rightarrow B \rightarrow E_0 \rightarrow E_1 \rightarrow E_2 \rightarrow \cdots$$

with all  $E_j$  injective.

The following is the analog of Proposition 3.1. It is exactly what one needs in the domain to define left derived functors in the abstract.

**Proposition 7.8** Suppose  $\mathbf{A}$  is a pre-Abelian category with enough projectives. Then any object in  $\mathbf{A}$  has a projective resolution which can be chosen with a choice function. If  $B, B' \in \mathbf{A}$  and  $\varphi \in \text{Hom}(B, B')$ , and if  $\langle P_n, d_n \rangle$  is a projective resolution of  $B$  and  $\langle P'_n, d'_n \rangle$  is a projective resolution of  $B'$ , then there exist fillers  $\varphi_n \in \text{Hom}(P_n, P'_n)$  making

$$\begin{array}{ccccccccccccccc} \cdots & \longrightarrow & P_{n+1} & \xrightarrow{d_{n+1}} & P_n & \xrightarrow{d_n} & \cdots & \longrightarrow & P_1 & \xrightarrow{d_1} & P_0 & \xrightarrow{\pi} & B & \longrightarrow & 0 \\ & & | & & | & & & & | & & | & & | & & \\ & & | \varphi_{n+1} & & | \varphi_n & & & & | \varphi_1 & & | \varphi_0 & & \downarrow \varphi & & \\ & & \Downarrow & & \Downarrow & & & & \Downarrow & & \Downarrow & & \downarrow & & \\ \cdots & \longrightarrow & P'_{n+1} & \xrightarrow{d'_{n+1}} & P'_n & \xrightarrow{d'_n} & \cdots & \longrightarrow & P'_1 & \xrightarrow{d'_1} & P'_0 & \xrightarrow{\pi'} & B' & \longrightarrow & 0 \end{array}$$

commutative. Further, if  $\varphi'_n \in \text{Hom}(P_n, P'_n)$  also serve as fillers, then  $\varphi_n$  and  $\varphi'_n$  are homotopic, that is, there exist  $D_n \in \text{Hom}(P_n, P'_{n+1})$  (with  $D_{-1} = 0$ ) such that  $\varphi_n - \varphi'_n = d'_{n+1}D_n + D_{n-1}d_n$ .

**Proof:** This goes much like Proposition 3.1, without the images (or elements). It turns out that all this does is make things more inductive.

To begin with, projective resolutions do exist. Choose a projective  $P_0$  and an epimorphism  $\pi : P_0 \rightarrow B$ . Let  $j_1 : K_1 \rightarrow P_0$  be a kernel for  $\pi$ . Choose a projective  $P_1$  and an epimorphism  $p_1 : P_1 \rightarrow K_1$ ; set  $d_1 = j_1 p_1$ . Let  $j_2 : K_2 \rightarrow P_1$  be a kernel for  $d_1$ . (Note: Since  $j_1$  is monic,  $j_2 : K_2 \rightarrow P_1$  is a kernel for  $p_1$  as well, by Proposition 7.5(c).) Choose a projective  $P_2$  and an epimorphism  $p_2 : P_2 \rightarrow K_2$ ; set  $d_2 = j_2 p_2$ . *Et cetera.*

True, an infinite number of choices from (possibly) proper classes are made, something that cannot be accomplished directly using a choice function. Nevertheless, one can bypass this using the Zermelo hierarchy (Section 6.6). If  $B \in \mathbf{A}$ , let  $\sigma(B)$  be the smallest ordinal  $\sigma$  such that  $V_\sigma \cap \mathbf{A}$  contains a projective  $P$  for which  $\text{Hom}(P, B)$  contains an epimorphism. Using the axiom of choice, choose  $P(B) \in V_{\sigma(B)} \cap \mathbf{A}$  (a set) and  $\pi^B$  an epimorphism in  $\text{Hom}(P(B), B)$ . Similarly, choose a kernel for  $\pi^B$  from a smallest  $V_\sigma \cap \mathbf{A}$ . Note that, by recursion, the above constructions actually choose (using a function) a specific projective resolution for any  $B \in \mathbf{A}$ .

Next, fillers. To begin with, recall that " $P'_0 \rightarrow B' \rightarrow 0$  is kernel-exact" means " $P'_0 \rightarrow B'$  is epic." (See Exercise 9.) Hence, projectivity of  $P_0$  produces a filler  $\varphi_0$ :

$$\begin{array}{ccc}
 & & P_0 \\
 & & \downarrow \pi \\
 & \swarrow \varphi_0 & B \\
 & & \downarrow \varphi \\
 P'_0 & \xrightarrow{\pi'} & B'
 \end{array}$$

Now we have to start being more careful. In general, let  $j_n : K_n \rightarrow P_{n-1}$  (respectively,  $j'_n : K'_n \rightarrow P'_{n-1}$ ) denote a kernel of  $d_{n-1}$  (respectively,  $d'_{n-1}$ ), or of  $\pi$  (respectively,  $\pi'$ ) if  $n = 1$ . Let  $p_n : P_n \rightarrow K_n$  (respectively,  $p'_n : P'_n \rightarrow K'_n$ ) denote the corresponding factorization, with  $d_n = j_n p_n$  (respectively,  $d'_n = j'_n p'_n$ ). This notation is consistent with what we had earlier.

Suppose  $\varphi_0, \dots, \varphi_n$  have been defined:

$$\begin{array}{ccccccc}
 & & P_{n+1} & \xrightarrow{d_{n+1}} & P_n & \xrightarrow{d_n} & P_{n-1} \\
 & & & & \downarrow \varphi_n & & \downarrow \varphi_{n-1} \\
 P'_{n+1} & \xrightarrow{p'_{n+1}} & K'_{n+1} & \xrightarrow{j'_{n+1}} & P'_n & \xrightarrow{d'_n} & P_{n-1}
 \end{array}$$

(The righthand column is replaced by  $B \rightarrow B'$  if  $n = 0$ .) Note that  $d'_n \varphi_n d_{n+1} = \varphi_{n-1} d_n d_{n+1} = 0$ , so that  $\varphi_n d_{n+1}$  factors (uniquely) through  $K'_{n+1}$  since  $j'_{n+1} : K'_{n+1} \rightarrow P'_n$  is a kernel for  $d'_n$ :

$$\begin{array}{ccccccc}
 & & P_{n+1} & \xrightarrow{d_{n+1}} & P_n & \xrightarrow{d_n} & P_{n+1} \\
 & & \downarrow & & \downarrow \varphi_n & & \downarrow \varphi_{n+1} \\
 P'_{n+1} & \xrightarrow{p'_{n+1}} & K'_{n+1} & \xrightarrow{j'_{n+1}} & P'_n & \xrightarrow{d'_n} & P'_{n-1}
 \end{array}$$

Finally, since  $p'_{n+1}$  is epic and  $P_{n+1}$  is projective, this dotted arrow has a filler through  $P'_{n+1}$ :

$$\begin{array}{ccccc}
 & & P_{n+1} & \xrightarrow{d_{n+1}} & P_n & \xrightarrow{d_n} & P_{n-1} \\
 & \nearrow \varphi_{n+1} & \downarrow & & \downarrow \varphi_n & & \downarrow \varphi_{n-1} \\
 P'_{n+1} & \xrightarrow{p'_{n+1}} & K'_{n+1} & \xrightarrow{j'_{n+1}} & P'_n & \xrightarrow{d'_n} & P'_{n-1}
 \end{array}$$

Homotopies work in a similar fashion. Suppose  $\langle \varphi_n \rangle$  and  $\langle \varphi'_n \rangle$  provide fillers. Note that  $\pi' \varphi_0 = \varphi \pi = \pi' \varphi'_0$ , so that  $\pi'(\varphi_0 - \varphi'_0) = 0$ . Hence  $\varphi_0 - \varphi'_0$  factors through  $K'_1$  since  $j'_1 : K'_1 \rightarrow P'_0$  is a kernel of  $\pi'$ . That is, we have

$$\begin{array}{ccc}
 & P_0 & \\
 & \searrow & \downarrow \varphi_0 - \varphi'_0 \\
 K'_1 & \xrightarrow{j'_1} & P'_0
 \end{array}$$

Since  $P'_1 \rightarrow K'_1$  is epic, we further get

$$\begin{array}{ccccc}
 & & & & P_0 \\
 & & \nearrow D_0 & \searrow & \downarrow \varphi_0 - \varphi'_0 \\
 P'_1 & \xrightarrow{p'_1} & K_1 & \xrightarrow{j'_1} & P'_0
 \end{array}$$

By definition,  $\varphi_0 - \varphi'_0 = d'_1 D_0 = d'_1 D_0 + D_{-1} d_0$  (since  $D_{-1} = 0$ ).

Now suppose we have  $D_0, \dots, D_n$ , so that  $\varphi_n - \varphi'_n = d'_{n+1} D_n + D_{n-1} d_n$ . We have

$$\begin{aligned}
 d'_{n+1}(\varphi_{n+1} - \varphi'_{n+1} - D_n d_{n+1}) &= d'_{n+1} \varphi_{n+1} - d'_{n+1} \varphi'_{n+1} - d'_{n+1} D_n d_{n+1} \\
 &= \varphi_n d_{n+1} - \varphi'_n d_{n+1} - d'_{n+1} D_n d_{n+1} \\
 &= (\varphi_n - \varphi'_n - d'_{n+1} D_n) d_{n+1} \\
 &= D_{n-1} d_n d_{n+1} \\
 &= 0.
 \end{aligned}$$

Hence,  $\varphi_{n+1} - \varphi'_{n+1} - D_n d_{n+1}$  factors through  $K'_{n+2}$ , and hence ( $P_{n+1}$  being projective) through  $P'_{n+2}$ :

$$\begin{array}{ccccc}
 & & & & P_{n+1} \\
 & & \nearrow D_{n+1} & \searrow & \downarrow \varphi_{n+1} - \varphi'_{n+1} - D_n d_{n+1} \\
 P'_{n+2} & \xrightarrow{p'_{n+2}} & K'_{n+2} & \xrightarrow{j_{n+2}} & P'_{n+1}
 \end{array}$$

As required,  $\varphi_{n+1} - \varphi'_{n+1} - D_n d_{n+1} = d'_{n+2} D_{n+1}$ . □

**Corollary 7.9** *Suppose  $\mathbf{A}$  is a pre-Abelian category with enough injectives. Then any object in  $\mathbf{A}$  has an injective resolution which can be chosen with a choice function. If  $B, B' \in \mathbf{A}$  and  $\varphi \in \text{Hom}(B, B')$ , and if  $\langle E_n, \partial_n \rangle$  is an injective resolution of  $B$  and  $\langle E'_n, \partial'_n \rangle$  is an injective resolution of  $B'$ , then there exist fillers  $\varphi_n \in \text{Hom}(E_n, E'_n)$  making*

$$\begin{array}{ccccccc} 0 & \longrightarrow & B & \xrightarrow{\iota} & E_0 & \xrightarrow{\partial_1} & E_1 & \xrightarrow{\partial_2} & \cdots \\ & & \downarrow \varphi & & \downarrow \varphi_0 & & \downarrow \varphi_1 & & \\ 0 & \longrightarrow & B' & \xrightarrow{\iota'} & E'_0 & \xrightarrow{\partial'_1} & E'_1 & \xrightarrow{\partial'_2} & \cdots \end{array}$$

*commutative. Further, any two collections of fillers are homotopic.*

**Proof:** Quote Proposition 7.8 for  $\mathbf{A}^{\text{op}}$ . □

If  $\mathbf{A}$  is pre-Abelian with enough projectives (or respectively, injectives), and  $F$  is an additive covariant functor from  $\mathbf{A}$  to  $\mathbf{Ab}$ , we can now define  $\mathcal{L}_n F$  (or respectively,  $\mathcal{R}_n F$ ) via our chosen projective (or respectively, injective) resolution of any  $B \in \mathbf{A}$ . Apply  $F$ , delete  $F(B)$ , and take homology, just like in Chapter 6. Ditto  $\mathcal{L}^n F$  (or  $\mathcal{R}^n F$ ) if  $F$  is contravariant. However, recovering the right properties requires more. The same is true if we want to change the target category from  $\mathbf{Ab}$  to something more general. For all this, we need to examine the conditions defining an Abelian category. We also need to examine projectives and injectives.

To start with, consider the following two conditions on a pre-Abelian category  $\mathbf{A}$ .

**Ab-monic.** If  $A, B \in \mathbf{A}$ , and if  $f \in \text{Hom}(A, B)$  is monic, then there exist  $C$  and  $g \in \text{Hom}(B, C)$  such that  $f : A \rightarrow B$  is a kernel of  $g$ .

**Ab-epic.** If  $A, B \in \mathbf{A}$ , and if  $f \in \text{Hom}(A, B)$  is epic, then there exist  $C$  and  $g \in \text{Hom}(C, A)$  such that  $f : A \rightarrow B$  is a cokernel of  $g$ .

**Definition 7.10** *A pre-Abelian category is Abelian if it satisfies both Ab-monic and Ab-epic.*

A surprising amount happens with just one condition.

**Proposition 7.11** *Let  $\mathbf{A}$  be a pre-Abelian category that satisfies either Ab-monic or Ab-epic. Then*

a)  $\mathbf{A}$  is balanced.

b) If  $A, B \in \mathbf{A}$ , and  $f \in \text{Hom}(A, B)$ , then there exist  $C \in \mathbf{A}$ ,  $p \in \text{Hom}(A, C)$ , and  $j \in \text{Hom}(C, B)$  such that  $f = jp$ , where  $j$  is monic and  $p$  is epic.





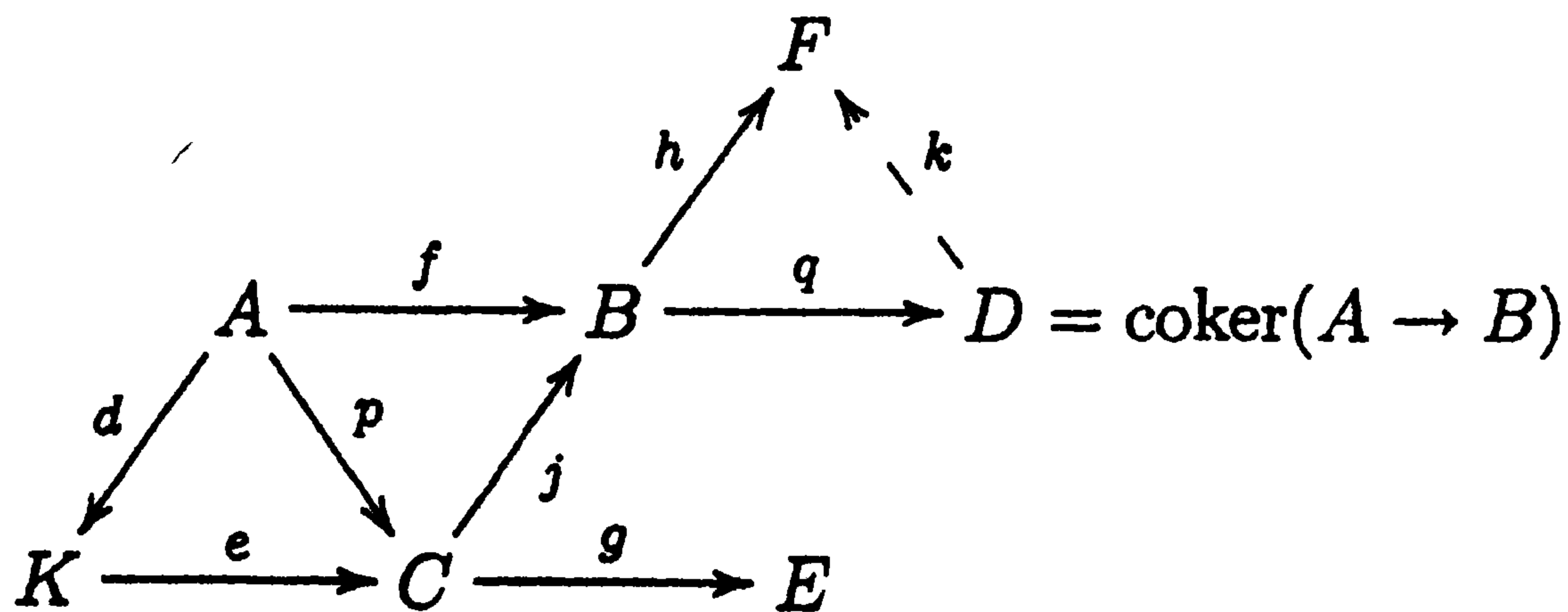

In this diagram,  $hj = kqj = 0$  since  $qj = 0$ . ( $j : C \rightarrow B$  is a kernel for  $q$ .) It follows that  $j$  factors through  $je : K \rightarrow B$  since  $je$  is a kernel of  $h : B \rightarrow F$ :

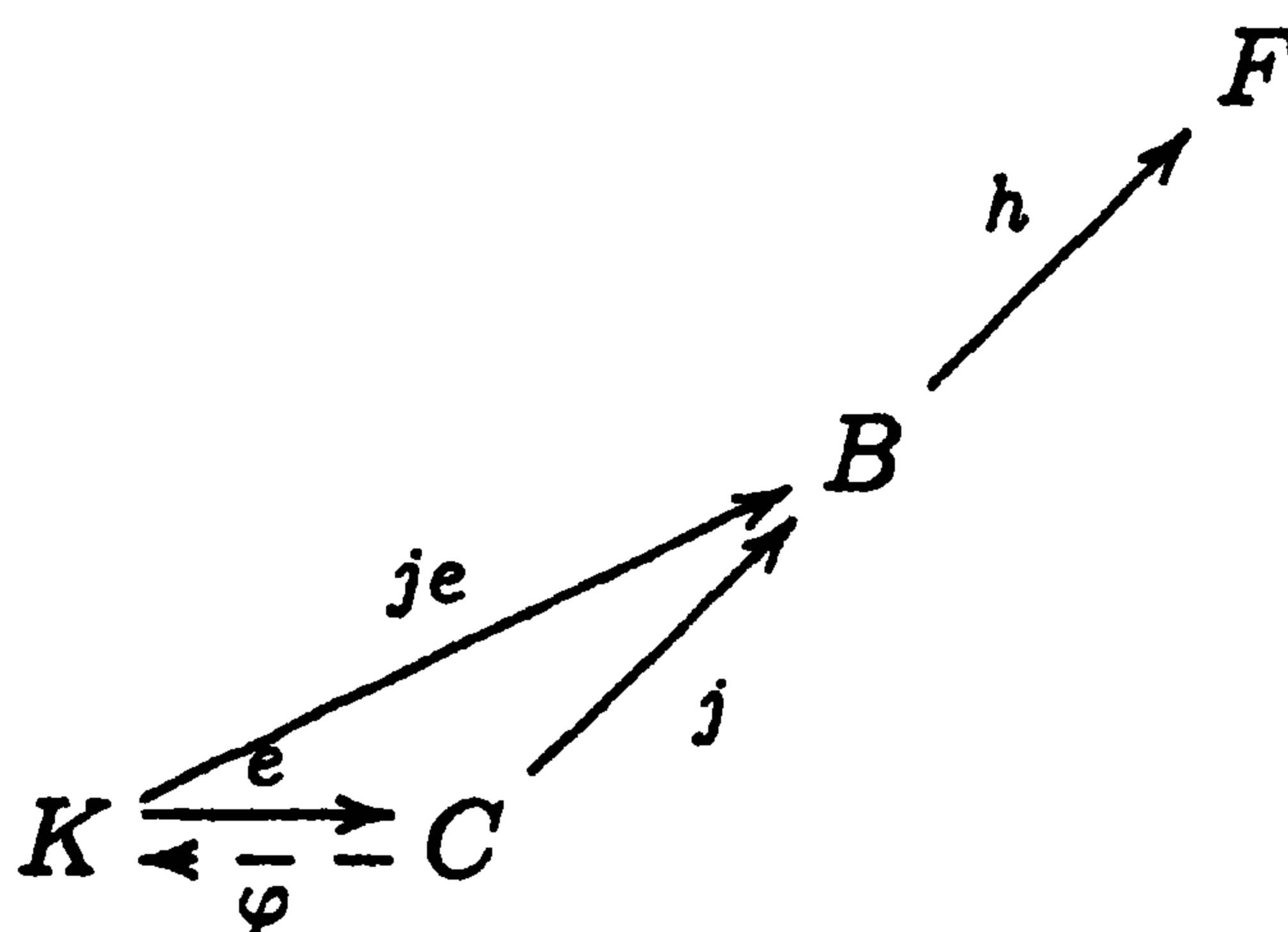

Now we have that  $j = je\varphi \Rightarrow e\varphi = i_C$  since  $j$  is monic. Also,  $e\varphi e = i_C e = ei_K$ , so  $\varphi e = i_K$  since  $e$  is monic. That is,  $e$  is an isomorphism with inverse  $\varphi$ . But  $e : K \rightarrow C$  was a kernel for  $g : C \rightarrow E$ , so  $g = 0$ . Since  $g$  was arbitrary with  $gp = 0$ ,  $p$  is epic.  $\square$

The oddball proof of (b) may make it appear that (b) is unusual. In fact, pre-Abelian categories not satisfying (b) are hard to come by. Condition (b) also holds if there is a separating class of projectives, or a coseparating class of injectives; this is shown in Section 7.4.

If  $\mathbf{A}$  is pre-Abelian and satisfies Ab-monic, then the intermediate object in any factorization (b) is unique up to isomorphism. (See Exercise 10.) It is referred to as the *image* of  $f$ . (If  $\mathbf{A}$  satisfies Ab-epic, it is called the *coimage*. If  $\mathbf{A}$  is Abelian, go back to “image.”) We will not really need this concept until Section 7.7.

The proof of (b) in the presence of Ab-monic is in a sense “generic.” (See Exercise 11.) Consequently, it is no surprise that the proof of (b) is appealed to for the following.

**Proposition 7.12** *Suppose  $\mathbf{A}$  is a pre-Abelian category. Then the following are equivalent:*

- i)  $\mathbf{A}$  satisfies Ab-monic.
- ii)  $\mathbf{A}$  is balanced, and cokernel-exact sequences are kernel-exact.
- iii) If  $0 \rightarrow A \rightarrow B \rightarrow C$  is cokernel-exact, then  $A \rightarrow B$  is a kernel for  $B \rightarrow C$ .

iv) If  $A \rightarrow B$  is monic, with cokernel  $B \rightarrow D$ , then  $B \rightarrow D$  has kernel  $A \rightarrow B$ .

**Proof:** (i)  $\Rightarrow$  (ii). If  $\mathbf{A}$  satisfies Ab-monic, then bimorphisms are isomorphisms by Proposition 7.11(a). To show that cokernel-exact sequences are kernel-exact, we appeal to the construction in the proof of Proposition 7.11(b). Suppose

$$A \xrightarrow{f} B \xrightarrow{g} C$$

is cokernel-exact. Filling in  $K = \ker(B \rightarrow C)$  and  $D = \text{coker}(A \rightarrow B)$  yields

$$\begin{array}{ccccc} A & \xrightarrow{f} & B & \xrightarrow{g} & C \\ & \searrow p & \nearrow j & \searrow q & \nearrow l \\ & & K & & D \end{array}$$

Since  $l$  is monic,  $q$  and  $lq = g$  have the same kernel, namely  $K$ . By the proof of Proposition 7.11(b),  $p$  is epic, so  $A \rightarrow B \rightarrow C$  is kernel-exact.

(ii)  $\Rightarrow$  (iii). If  $0 \rightarrow A \rightarrow B \rightarrow C$  is cokernel-exact, then in the presence of (ii) it is kernel-exact, so that  $A \rightarrow B$  is a kernel for  $B \rightarrow C$  (since also bimorphisms are isomorphisms).

(iii)  $\Rightarrow$  (iv). If  $A \rightarrow B$  is monic with cokernel  $B \rightarrow D$ , then by definition  $A \rightarrow B \rightarrow D$  is cokernel-exact.  $0 \rightarrow A \rightarrow B$  is also cokernel-exact, so  $0 \rightarrow A \rightarrow B \rightarrow D$  is cokernel-exact; assuming (iii),  $A \rightarrow B$  is a kernel for  $B \rightarrow D$ .

Finally, (iv)  $\Rightarrow$  (i) is trivial. □

Condition (iv) is sometimes written " $f = \ker(\text{coker } f)$  if  $f$  is monic," being sloppy about equality.

**Corollary 7.13** Suppose  $\mathbf{A}$  is a pre-Abelian category. Then the following are equivalent:

- i)  $\mathbf{A}$  satisfies Ab-epic.
- ii)  $\mathbf{A}$  is balanced, and kernel-exact sequences are cokernel-exact.
- iii) If  $A \rightarrow B \rightarrow C \rightarrow 0$  is kernel-exact, then  $B \rightarrow C$  is a cokernel for  $A \rightarrow B$ .
- iv) If  $A \rightarrow B$  is epic with kernel  $K \rightarrow A$ , then  $K \rightarrow A$  has cokernel  $A \rightarrow B$ .

**Proof:** Apply Proposition 7.12 to  $\mathbf{A}^{\text{op}}$ . □

It should be noted that in any pre-Abelian category, if  $f : A \rightarrow B$  is a cokernel—that is, if there exist a  $C$  and a  $g : C \rightarrow A$  such that  $f$  is a cokernel of  $g$ —then necessarily  $f$  is a cokernel of  $j : K \rightarrow A$ , where  $j$  is a kernel for  $f$ . (That is, any cokernel is a cokernel of its kernel.) Exercise 13 covers this, and the corresponding result for kernels. We shall not need this in all generality until Section 7.8.

We can now be explicit about what we should have in a domain for homological algebra.

*Suppose  $\mathbf{A}$  is a pre-Abelian category.*

- a) *If  $\mathbf{A}$  has enough injectives, then one can form right derived functors (including  $\text{Ext}$ , by resolving the second variable in  $\text{Hom}$ ).  $\text{Ext}^0$  is isomorphic to  $\text{Hom}$ , provided  $\mathbf{A}$  satisfies Ab-monic (Section 7.8).*
- b) *If  $\mathbf{A}$  has enough projectives, then one can form left derived functors (including  $\text{Ext}$ , by resolving the first variable in  $\text{Hom}$ ).  $\text{Ext}^0$  is isomorphic to  $\text{Hom}$  provided  $\mathbf{A}$  satisfies Ab-epic (Section 7.8).*

(At this point, the functors to be derived take values in  $\mathbf{Ab}$ . The target category will be generalized in Section 7.6. If (a) and (b) both apply, there is no guarantee that the two  $\text{Ext}$  groups coincide.)

In case (a), one always uses cokernel-exact sequences (which will imply kernel-exact; this is Proposition 7.15 below in  $\mathbf{A}^{\text{op}}$ ). In case (b), one always uses kernel-exact sequences. If  $\mathbf{A}$  is actually Abelian, then kernel-exact sequences are cokernel-exact and vice versa (thus, simply called *exact*); furthermore  $0 \rightarrow A \rightarrow B \rightarrow C \rightarrow 0$  is exact if and only if  $A \rightarrow B$  is monic with cokernel  $B \rightarrow C$  if and only if  $B \rightarrow C$  is epic with kernel  $A \rightarrow B$ . See Exercise 15 for more about all this.

In the next section we shall further investigate the detailed consequences of the presence of projectives and injectives.

## 7.4 Cheating with Projectives

### Cheating?

In certain situations, with some categories, one can prove many statements about arrows by pretending that the objects are sets and the morphisms are functions. That is, one pretends the category is concrete. This is usually called “cheating” when the category is not known to be concrete. It can be carried out if enough of the category is equivalent to a concrete category; the usual case of Abelian categories is discussed in Appendix C. Nevertheless, a form of cheating can be carried out in any pre-Abelian category with a separating class of projectives. This is not very well known;



it is also good “diagram practice,” although overindulgence leads to sloppiness. (Various standard results about Abelian categories will be proved in Section 7.6 with no cheating.)

The idea behind “cheating with projectives” in a pre-Abelian category with a separating class of projectives is this: Make the arrows do the work that elements do in concrete categories. Before getting into this, we need a few results which tighten the analogy between “elements” and “arrows from a projective.” Keep in the back of your mind the case where the category is concrete, and the separating class of projectives consists of one object: a free object  $P$  on one generator,  $*$ . A function  $f$  from  $\{*\}$  into the underlying set of an object  $A$  just means the element  $x = f(*)$ ;  $f$  corresponds to a unique arrow  $P \rightarrow A$ . If the category is  ${}_R\mathbf{M}$ , then the phrase “choose  $x \in A$ ” will correspond to “choose  $f \in \text{Hom}(R, A)$ ,” with the correspondence being “ $x = f(1)$ .”

Consider the following three statements for  ${}_R\mathbf{M}$ :

- Given  $f : A \rightarrow B$  in  ${}_R\mathbf{M}$ :  $f$  is monic if and only if  $\forall x \in A, f(x) = 0 \Rightarrow x = 0$ .
- Given  $f : A \rightarrow B$  in  ${}_R\mathbf{M}$ :  $f$  is epic if and only if  $\forall x \in B, \exists y \in A$  for which  $f(y) = x$ .
- Given  $f : A \rightarrow B$  and  $g : B \rightarrow C$  in  ${}_R\mathbf{M}$ , with  $gf = 0$ :  $A \rightarrow B \rightarrow C$  is exact if and only if  $\forall x \in B$  with  $g(x) = 0, \exists y \in A$  for which  $f(y) = x$ .

The following result corresponds to these statements, given a separating class of projectives.

**Proposition 7.14** *Suppose  $\mathbf{A}$  is a pre-Abelian category with a separating class of projectives.*

- Given  $f : A \rightarrow B$  in  $\mathbf{A}$ :  $f$  is monic if and only if for all projectives  $P$  and all  $\varphi : P \rightarrow A$ ,  $f\varphi = 0 \Rightarrow \varphi = 0$ .
- Given  $f : A \rightarrow B$  in  $\mathbf{A}$ :  $f$  is epic if and only if for all projectives  $P$  and all  $\varphi : P \rightarrow B$ , there exists a filler

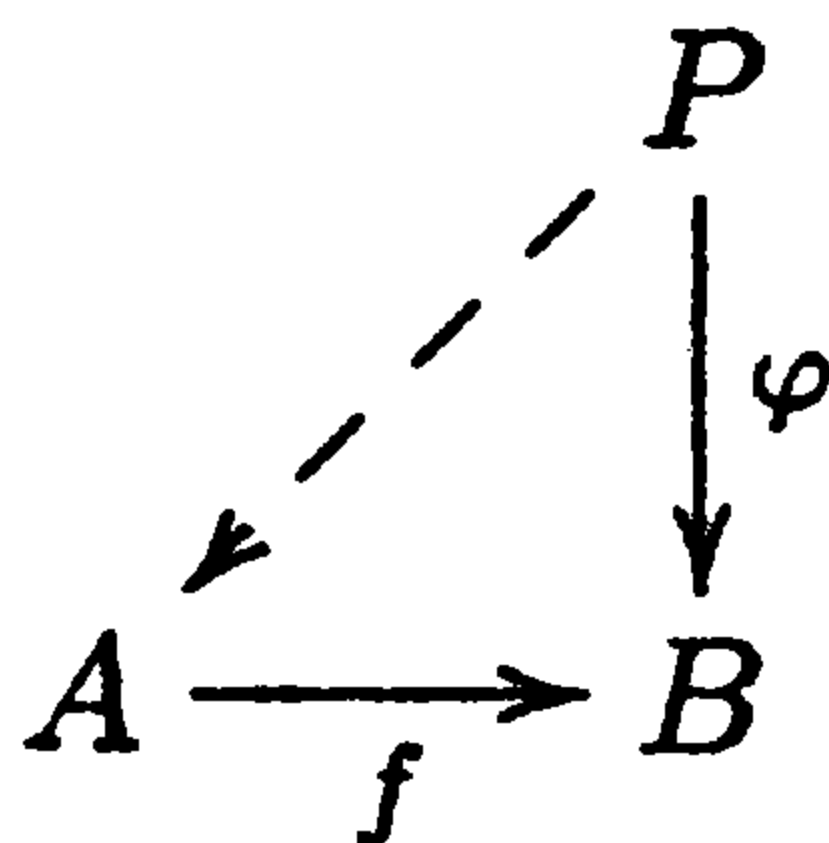

- Given  $f : A \rightarrow B$  and  $g : B \rightarrow C$  in  $\mathbf{A}$ , with  $gf = 0$ :  $A \rightarrow B \rightarrow C$  is kernel-exact if and only if for all projectives  $P$  and  $\varphi : P \rightarrow B$  with



$g\varphi = 0$ , there exists a filler

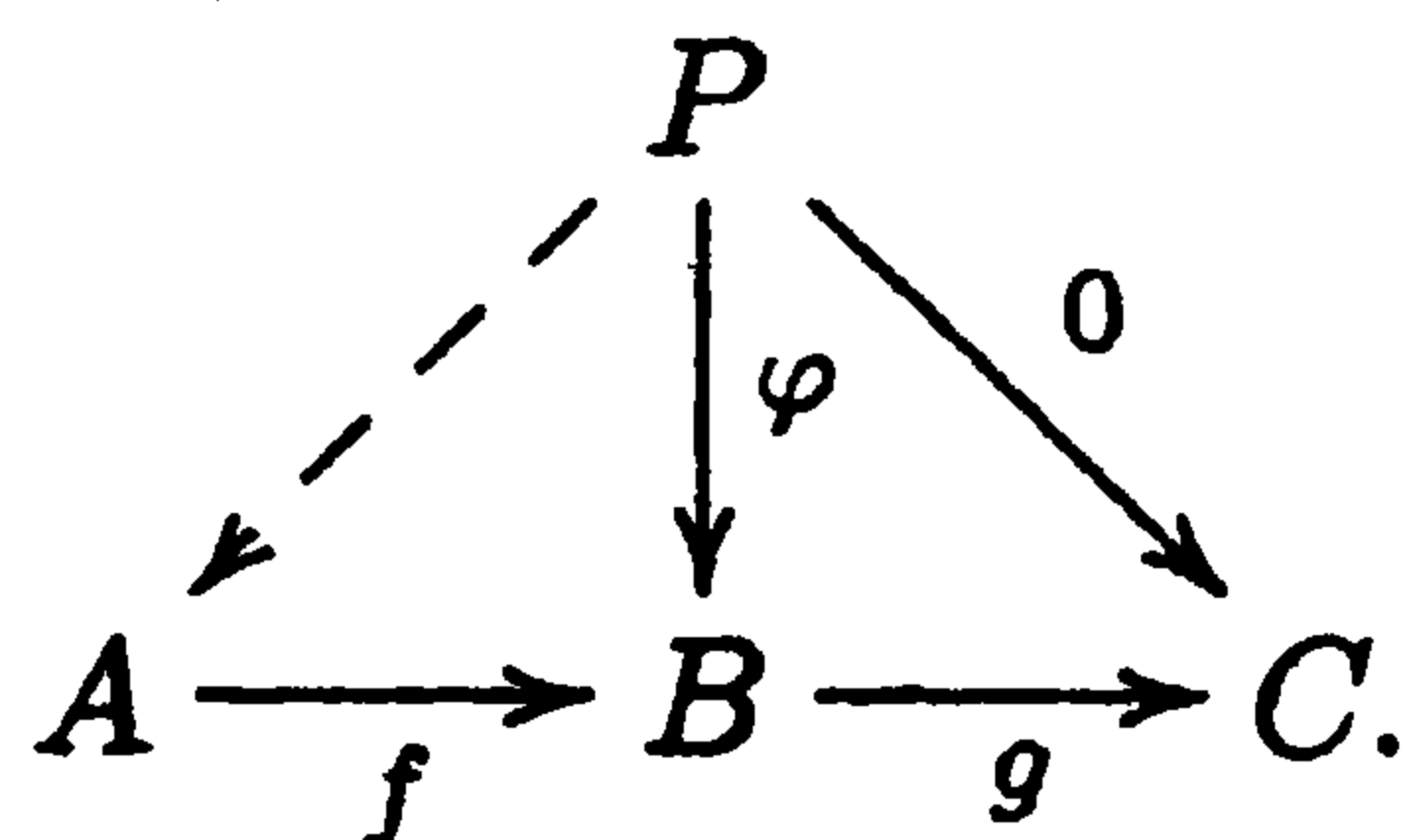

**Proof:**

(a) If  $f$  is monic, then  $f\varphi = 0 \Rightarrow \varphi = 0$  by definition. Suppose  $f$  is not monic. Let  $j : K \rightarrow A$  be a kernel for  $f$ . There exists a projective  $P$  and  $\psi : P \rightarrow K$  for which  $j\psi \neq 0\psi = 0$ , since  $j \neq 0$ . Set  $\varphi = j\psi$ . Then  $f\varphi = fj\psi = 0\psi = 0$ , but  $\varphi \neq 0$ .

(b) If  $f$  is epic, then fillers exist by definition of the term "projective." Suppose  $f$  is not epic. Let  $\pi : B \rightarrow D$  be a cokernel for  $f$ .  $D \neq 0$ , so there exist a projective  $P$  and  $\psi : P \rightarrow D$ ,  $\psi \neq 0$ . (The reason is quite general:  $i_D \neq 0$ , so there exist  $P$  and  $\psi$  with  $i_D\psi \neq 0\psi$ , i.e.,  $\psi \neq 0$ .) Let  $\varphi$  be a filler for

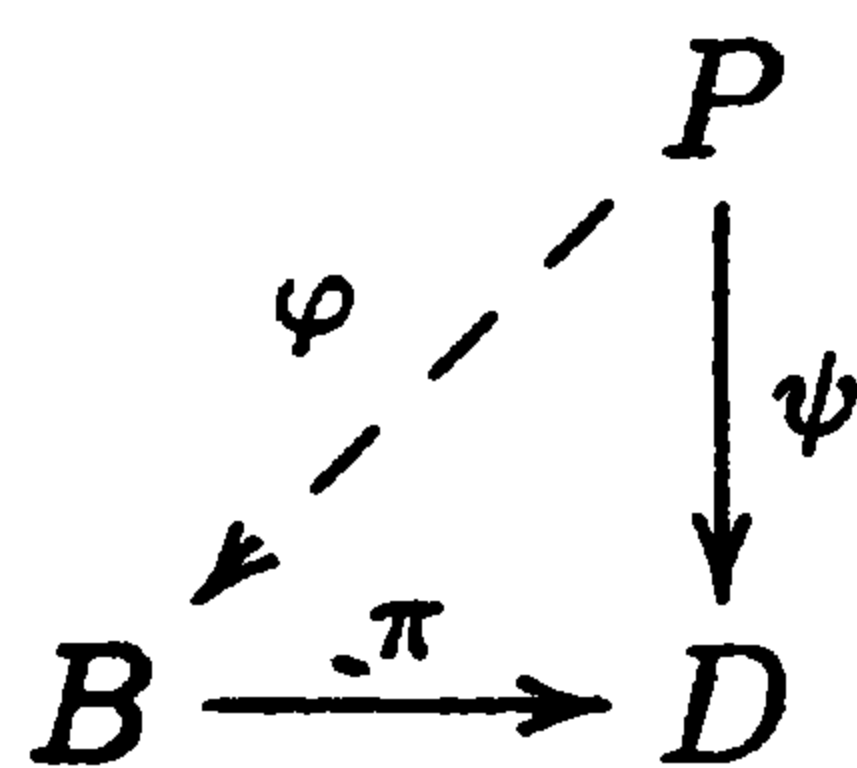

Then for any  $\eta : P \rightarrow A$ ,  $\pi f\eta = 0\eta = 0$ , while  $\pi\varphi = \psi \neq 0$ , so  $f\eta \neq \varphi$ , and no filler exists for

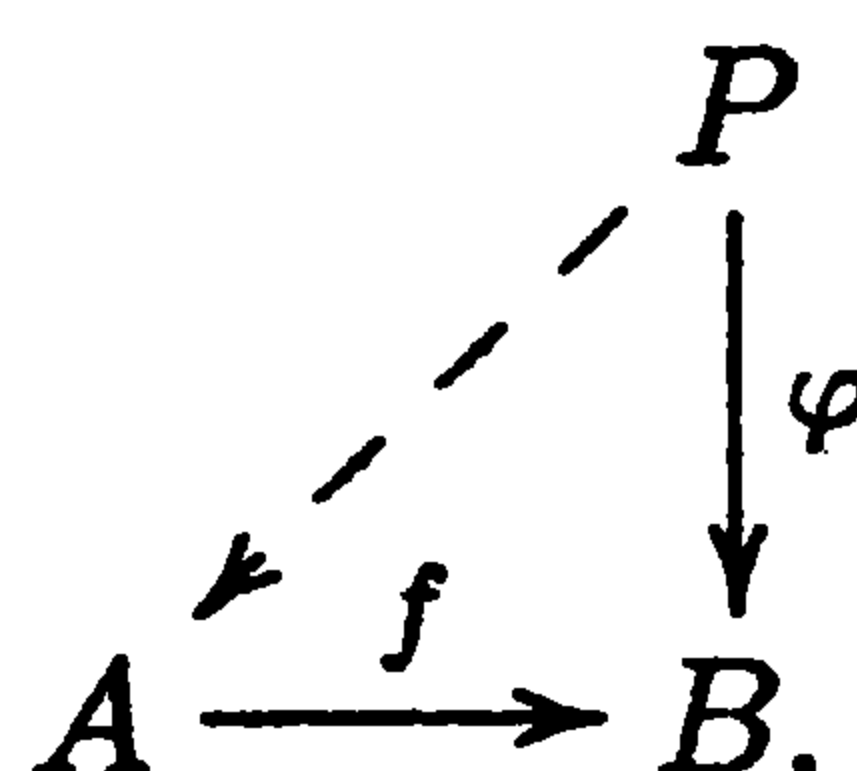

(c) Suppose  $A \rightarrow B \rightarrow C$  is kernel-exact, and suppose  $\varphi : P \rightarrow B$  satisfies  $g\varphi = 0$ . Let  $j : K \rightarrow B$  be a kernel for  $g$ , and let  $\pi : A \rightarrow K$  satisfy  $f = j\pi$ . Also, let  $\psi : P \rightarrow K$  satisfy  $\varphi = j\psi$ . Since  $\pi$  is epic, a filler  $\eta$  exists for

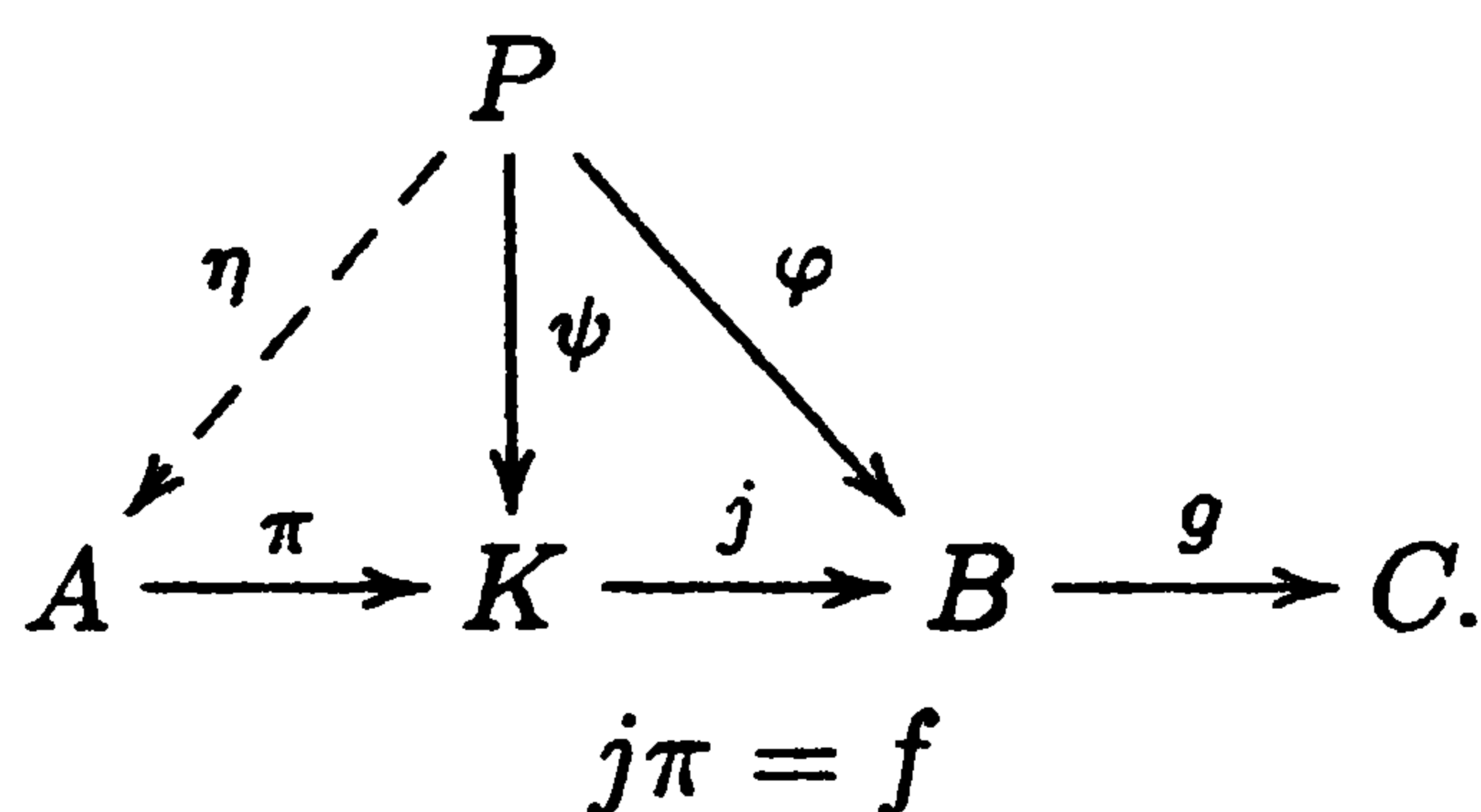

On the other hand, suppose  $A \rightarrow B \rightarrow C$  is not kernel-exact. Again let  $j : K \rightarrow B$  be a kernel for  $g$ , and let  $\pi : A \rightarrow K$  satisfy  $f = j\pi$ . Then  $\pi$  is

not epic, so by part (b), there exists a projective  $P$  and  $\psi : P \rightarrow K$  such that no filler for

$$\begin{array}{ccc} & & P \\ & \nearrow & \downarrow \psi \\ A & \xrightarrow{\pi} & K \end{array}$$

exists. Set  $\varphi = j\psi$ . Note that  $g\varphi = gj\psi = 0\psi = 0$ .

If a filler  $\eta$  existed for

$$\begin{array}{ccccc} & & P & & \\ & \nearrow & \downarrow \varphi & & \\ A & \xrightarrow{f} & B & \xrightarrow{g} & C \end{array}$$

we would have  $j\psi = \varphi = f\eta = j\pi\eta \Rightarrow \psi = \pi\eta$  since  $j$  is monic, giving

$$\begin{array}{ccc} & & P \\ & \nearrow \eta & \downarrow \psi \\ A & \xrightarrow{\pi} & K \end{array}$$

commutative, a contradiction. □

**Remark:** In the above, (c) is easily the strongest, since (a) and (b) can be derived from it.

This proposition has a number of uses; we start with the result alluded to after Proposition 7.11. It is a corollary to the following.

**Proposition 7.15** *Suppose  $\mathbf{A}$  is pre-Abelian with a separating class of projectives, and suppose  $f : A \rightarrow B$  and  $g : B \rightarrow C$  in  $\mathbf{A}$ , with  $A \rightarrow B \rightarrow C$  kernel-exact. Then  $A \rightarrow B \rightarrow C$  is cokernel-exact.*

**Proof:** Let  $\pi : B \rightarrow D$  denote a cokernel for  $f$ , and  $h : D \rightarrow C$  satisfy  $h\pi = g$ . Let  $P$  be projective, and suppose  $\psi : P \rightarrow D$  satisfies  $h\psi = 0$ . A filler  $\varphi$  exists for

$$\begin{array}{ccccc} A & \xrightarrow{f} & B & \xrightarrow{g} & C \\ & & \searrow \pi & & \nearrow h \\ & & D & & \\ & \nearrow \varphi & \downarrow \psi & & \\ & P & \xrightarrow{\psi} & D & \end{array}$$

since  $\pi$  is epic, and a filler  $\eta$  exists for

$$\begin{array}{ccccc} A & \xrightarrow{f} & B & \xrightarrow{g} & C \\ & \nearrow \eta & \nearrow \varphi & & \nearrow h \\ & P & \xrightarrow{\psi} & D & \end{array}$$

since  $A \rightarrow B \rightarrow C$  is kernel-exact (Proposition 7.14(c)). But now  $\psi = \pi\varphi = \pi f\eta = 0\eta = 0$ . Since  $P$  and  $\psi$  are arbitrary,  $h$  is monic by Proposition 7.14(a).  $\square$

If  $\mathbf{A}$  were  ${}_R\mathbf{M}$ , we might have said, “If  $h(\bar{x}) = 0$ , then (writing  $\bar{x} = x + \text{im}f$ ),  $g(x) = h(\bar{x}) = 0$ , so  $x \in \ker g \Rightarrow x = f(y)$  for some  $y$  (since  $A \rightarrow B \rightarrow C$  is exact). But then  $\bar{x} = f(y) + \text{im}f = \bar{0}$ .” Elements would correspond to arrows out of projectives.

**Corollary 7.16** *Suppose  $\mathbf{A}$  is pre-Abelian with a separating class of projectives. Suppose  $f : A \rightarrow B$  in  $\mathbf{A}$ . Let  $j : K \rightarrow A$  denote a kernel for  $f$ , and  $\pi : A \rightarrow D$  a cokernel for  $j$ . Let  $g : D \rightarrow B$  satisfy  $g\pi = f$  (possible since  $fj = 0$ ).*

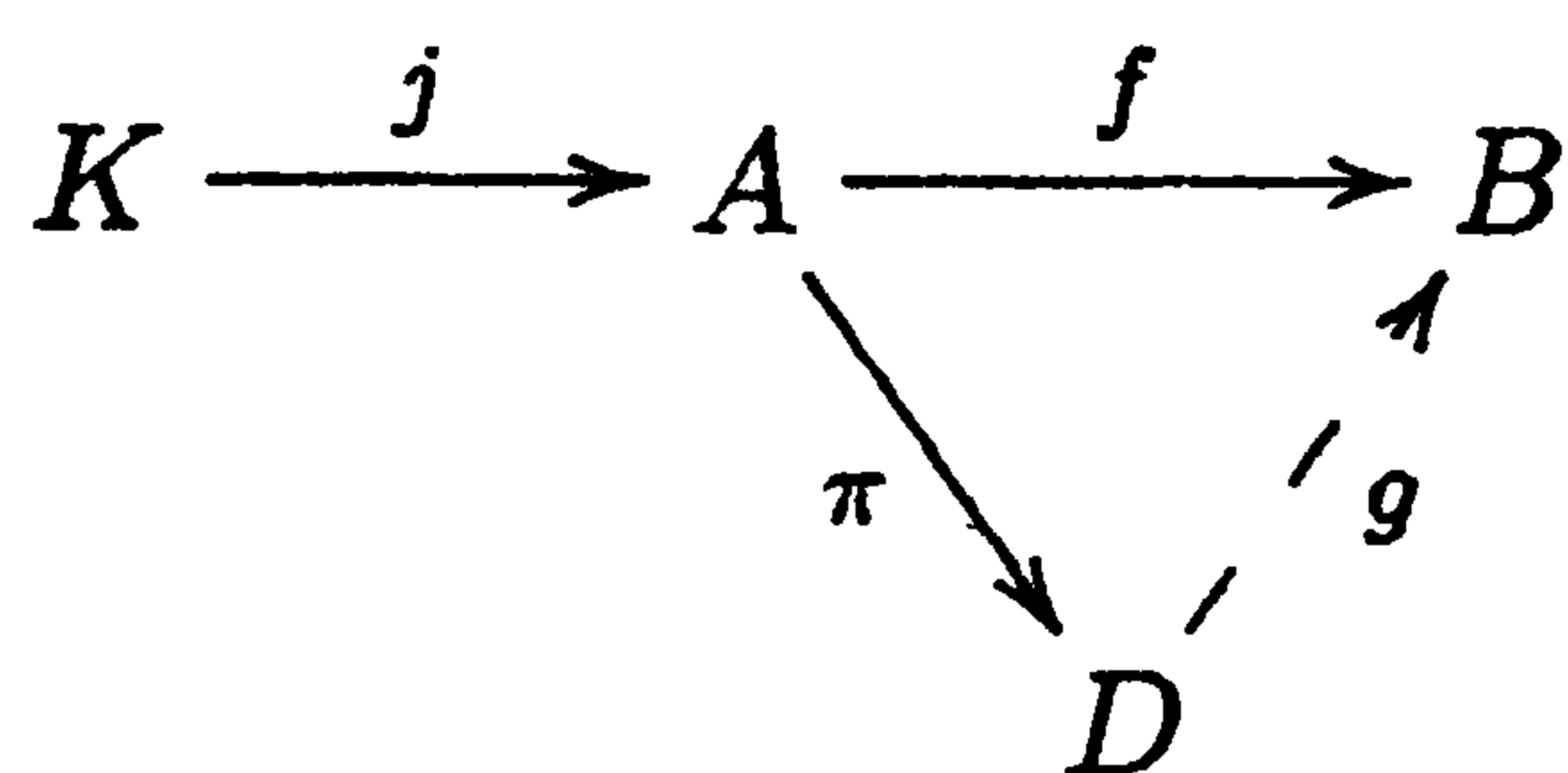

*Then  $g$  is monic. Hence,  $f = g\pi$  is a composite of an epimorphism followed by a monomorphism.*

**Proof:**  $K \rightarrow A \rightarrow B$  is kernel-exact by definition, so it is cokernel-exact. This just means that  $g$  is monic.  $\square$

Combining with Corollary 7.13, we have:

**Proposition 7.17** *Suppose  $\mathbf{A}$  is a balanced pre-Abelian category with a separating class of projectives. Then  $\mathbf{A}$  satisfies Ab-epic.*

**Proof:**  $\mathbf{A}$  satisfies condition (ii) in Corollary 7.13.  $\square$

**Corollary 7.18** *Suppose  $\mathbf{A}$  is a balanced pre-Abelian category with a separating class of projectives and a coseparating class of injectives. Then  $\mathbf{A}$  is Abelian.*

**Proof:** Both  $\mathbf{A}$  and  $\mathbf{A}^{\text{op}}$  satisfy Ab-epic by Proposition 7.17, since a coseparating class of injectives in  $\mathbf{A}$  becomes a separating class of projectives in  $\mathbf{A}^{\text{op}}$ . But if  $\mathbf{A}^{\text{op}}$  satisfies Ab-epic, then  $\mathbf{A}$  satisfies Ab-monic, so  $\mathbf{A}$  satisfies both Ab-monic and Ab-epic.  $\square$

The above result helps to explain why most pre-Abelian categories that fail to be Abelian, do so because they are not balanced. A separating class of projectives and a coseparating class of injectives are just too often present.

We next present a particularly transparent example of cheating, the 5-lemma. The method follows Proposition 2.5 *very* closely—so closely that we can actually convert the proof of Proposition 2.5 into arrows.

**Proposition 7.19 (5-Lemma)** *Suppose  $\mathbf{A}$  is a pre-Abelian category with a separating class of projectives. Suppose that, in  $\mathbf{A}$ ,*

$$\begin{array}{ccccccccc}
 A_1 & \xrightarrow{f_1} & A_2 & \xrightarrow{f_2} & A_3 & \xrightarrow{f_3} & A_4 & \xrightarrow{f_4} & A_5 \\
 \varphi_1 \downarrow & & \varphi_2 \downarrow & & \varphi_3 \downarrow & & \varphi_4 \downarrow & & \varphi_5 \downarrow \\
 B_1 & \xrightarrow{g_1} & B_2 & \xrightarrow{g_2} & B_3 & \xrightarrow{g_3} & B_4 & \xrightarrow{g_4} & B_5
 \end{array}$$

*is commutative with kernel-exact rows, and suppose*

- i)  $\varphi_2$  and  $\varphi_4$  are bimorphisms,*
- ii)  $\varphi_1$  is epic, and*
- iii)  $\varphi_5$  is monic.*

*Then  $\varphi_3$  is a bimorphism.*

**Proof:** To emphasize the manner in which this mimics the proof of Proposition 2.5, the latter's proof will be written on the right, while Proposition 7.19's proof appears on the left. Illustrations of the overall diagram chase appear after the proof and may be consulted to maintain perspective.

$\varphi_3$  is monic:

Suppose  $P$  is projective and  $\alpha : P \rightarrow A_3$  with  $\varphi_3\alpha = 0$ .

Then  $0 = g_3\varphi_3\alpha = \varphi_4f_3\alpha \Rightarrow f_3\alpha = 0$ , since  $\varphi_4$  is monic.

Hence, a filler  $\alpha'$  exists for

$$\begin{array}{ccccc}
 & & P & & \\
 & \swarrow \alpha' & \downarrow \alpha & & \\
 A_2 & \xrightarrow{f_2} & A_3 & \xrightarrow{f_3} & A_4
 \end{array}$$

by Proposition 7.14(c).

Hence,  $0 = \varphi_3f_2\alpha' = g_2\varphi_2\alpha'$ .

$\varphi_3$  is one-to-one:

Suppose  $\varphi_3(a) = 0$ .

Then  $0 = g_3\varphi_3(a) = \varphi_4f_3(a) \Rightarrow f_3(a) = 0$ , since  $\varphi_4$  is one-to-one.

Hence,  $a = f_2(a')$  for some  $a' \in A_2$ , by exactness of the bottom row.

Hence,  $0 = \varphi_3f_2(a') = g_2\varphi_2(a')$ .

Hence, a filler  $\beta'$  exists for

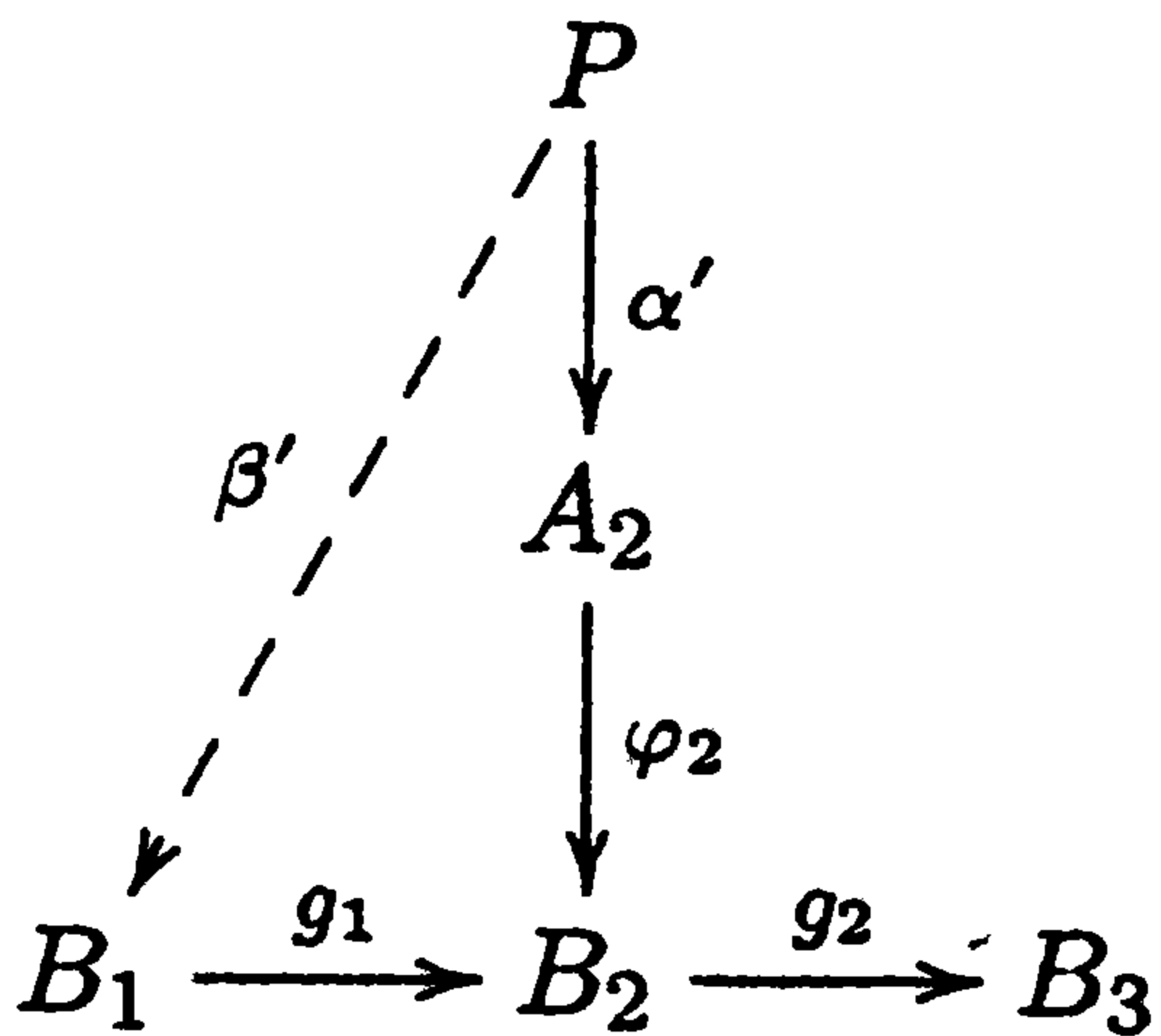

by Proposition 7.14(c).

Finally, a filler  $\alpha''$  exists for

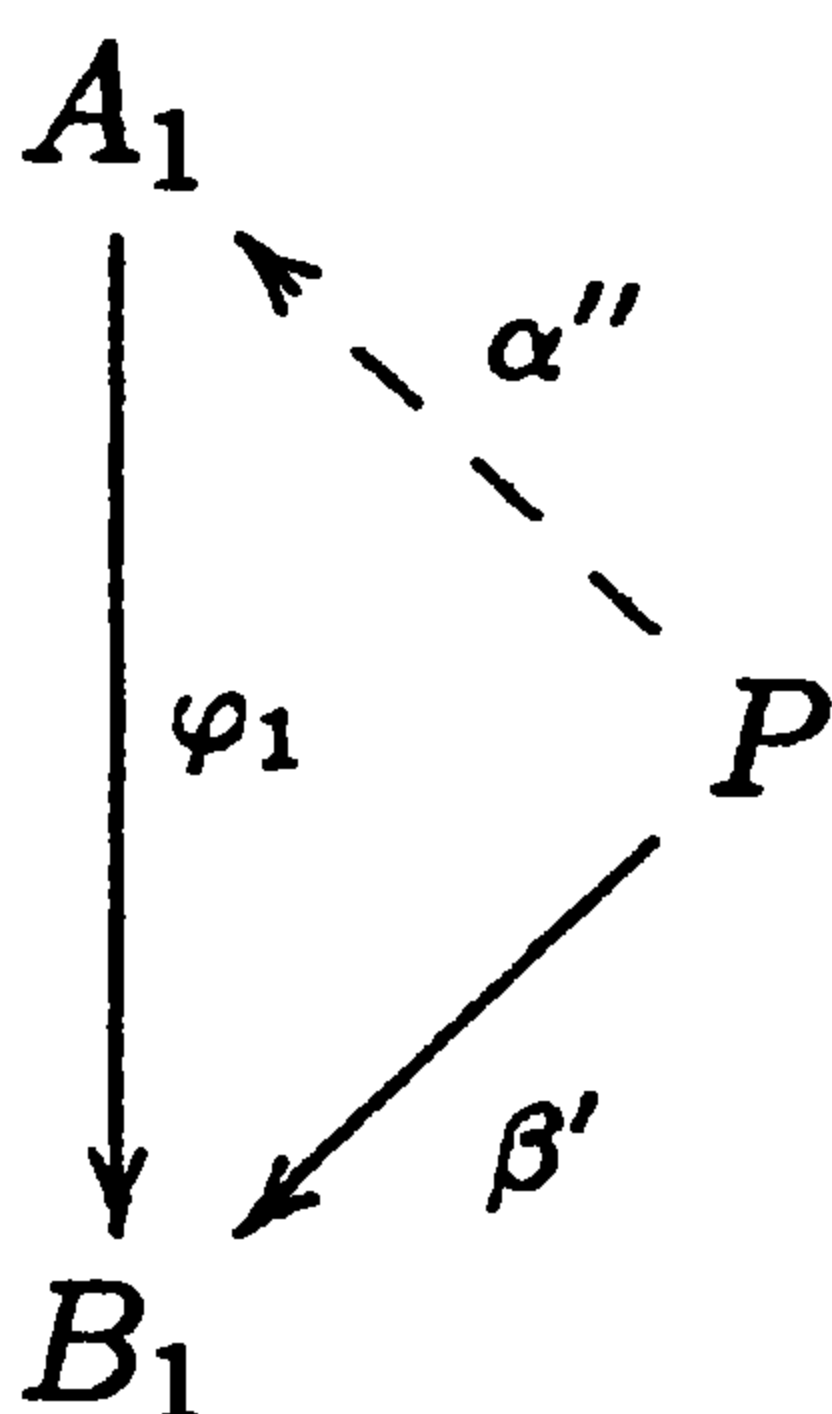

since  $P$  is projective and  $\varphi_1$  is epic.

But now  $\varphi_2\alpha' = g_1\beta' = g_1\varphi_1\alpha'' = \varphi_2f_1\alpha''$ , so  $f_1\alpha'' = \alpha'$ , since  $\varphi_2$  is monic.

But *that* means that  $\alpha = f_2\alpha' = f_2f_1\alpha'' = 0$ , since  $f_2f_1 = 0$ .

We now have that the original (arbitrary)  $\alpha$  was 0, so  $\varphi_3$  is monic by Proposition 7.14(a).

$\varphi_3$  is epic:

This breaks into two parts.

Suppose  $P$  is projective, and  $\beta \in \text{Hom}(P, B_3)$ . We shall show that  $\beta$  factors through  $A_3$ .  $\varphi_3$  will then be epic by Proposition 7.14(b).

Suppose first that  $g_3\beta = 0$ .

Hence,  $\varphi_2(a') = g_1(b')$  for some  $b' \in B_1$  by exactness of the bottom row.

Finally,  $b' = \varphi_1(a'')$  for some  $a'' \in A_1$ , since  $\varphi_1$  is onto.

But now  $\varphi_2(a') = g_1(b') = g_1\varphi_1(a'') = \varphi_2f_1(a'')$ , so  $f_1(a'') = a'$  since  $\varphi_2$  is one-to-one

But *that* means that  $a = f_2(a') = f_2f_1(a'') = 0$  by exactness of the top row.

$\varphi_3$  is onto:

This breaks into two parts.

First,  $\text{im } g_2 \subset \text{im } \varphi_3$ :



There is a filler  $\beta'$  for

$$\begin{array}{ccccc} B_2 & \xrightarrow{g_2} & B_3 & \xrightarrow{g_3} & B_4 \\ & \nearrow \beta' & \uparrow \beta & & \\ & & P & & \end{array}$$

by Proposition 7.14(c), since  $B_2 \rightarrow B_3 \rightarrow B_4$  is kernel-exact.

Then a filler  $\alpha$  exists for

$$\begin{array}{ccc} A_2 & & \\ \varphi_2 \downarrow & \nearrow \alpha & \\ B_2 & \xleftarrow{\beta'} & P \end{array}$$

since  $\varphi_2$  is epic.

But now  $g_2\beta' = g_2\varphi_2\alpha = \varphi_3f_2\alpha$ , so  $f_2\alpha$  is a filler for

$$\begin{array}{ccc} & A_3 & \\ f_2\alpha \nearrow & \downarrow \varphi_3 & \\ P \xrightarrow{\beta} & B_3 & \end{array}$$

Finally, suppose  $\beta : P \rightarrow B_3$  is arbitrary.

Then a filler  $\alpha$  exists for

$$\begin{array}{ccccc} & & & A_4 & \\ & & \alpha \nearrow & \downarrow \varphi_4 & \\ P \xrightarrow{\beta} & B_3 & \xrightarrow{g_3} & B_4 & \end{array}$$

since  $\varphi_4$  is epic.

Now  $0 = g_4g_3\beta = g_4\varphi_4\alpha = \varphi_5f_4\alpha$  (since  $g_4g_3 = 0$ ), so  $f_4\alpha = 0$ , since  $\varphi_5$  is monic.

Suppose  $b' \in B_2$ .

Then  $b' = \varphi_2(a)$  for some  $a \in A_2$ , since  $\varphi_2$  is onto.

But now  $g_2(b') = g_2\varphi_2(a) = \varphi_3f_2(a) \in \text{im } \varphi_3$ .

Finally, suppose  $b \in B_3$ .

Then  $g_3(b) \in B_4 = \text{im } \varphi_4$ , so  $\exists a \in A_4$  with  $g_3(b) = \varphi_4(a)$ .

Now  $0 = g_4g_3(b) = g_4\varphi_4(a) = \varphi_5f_4(a)$  by exactness of the bottom row, so  $f_4(a) = 0$ , since  $\varphi_5$  is one-to-one.

Hence, a filler  $\alpha'$  exists for

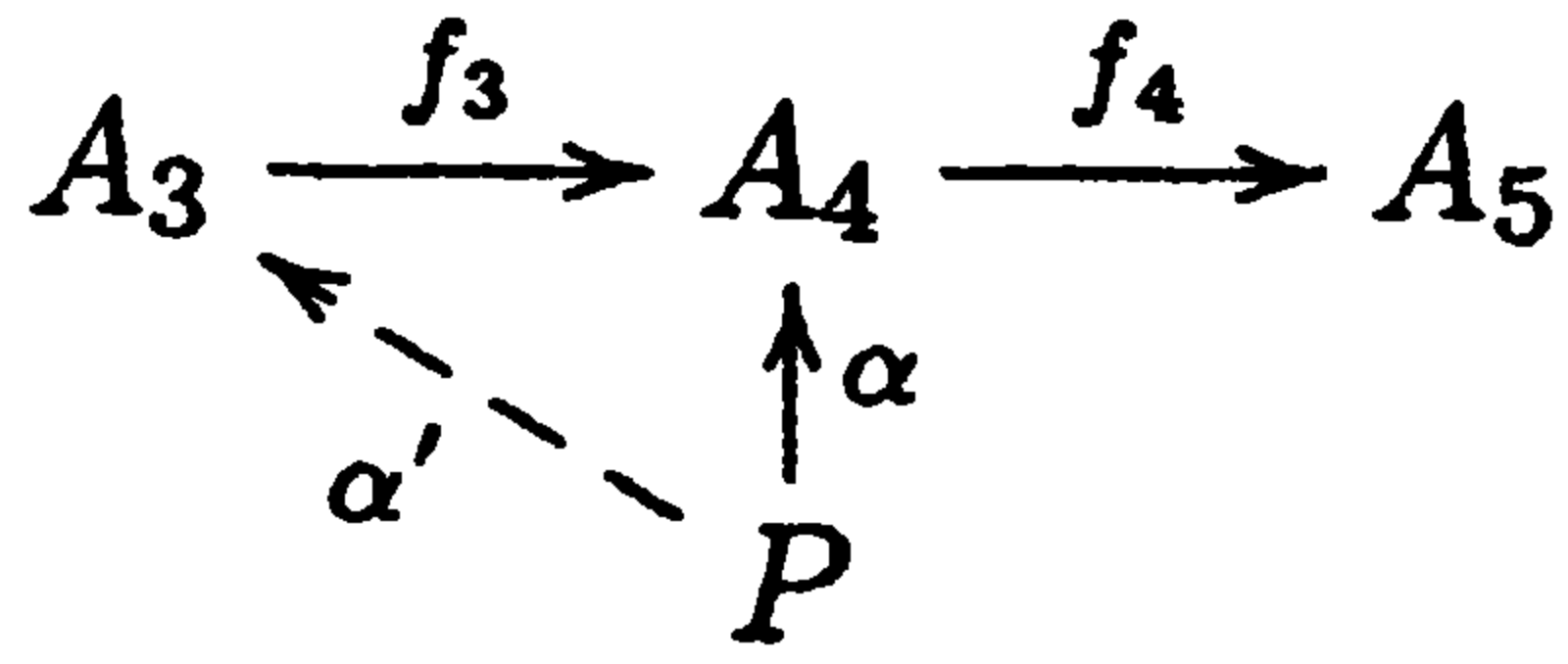

by Proposition 7.14(c).

Hence,  $g_3\beta = \varphi_4\alpha = \varphi_4f_3\alpha' = g_3\varphi_3\alpha'$ ; that is,  $g_3(\beta - \varphi_3\alpha') = 0$ .

Hence, by the first part of the “ $\varphi_3$  is epic” portion of the proof, a filler  $\alpha''$  exists for

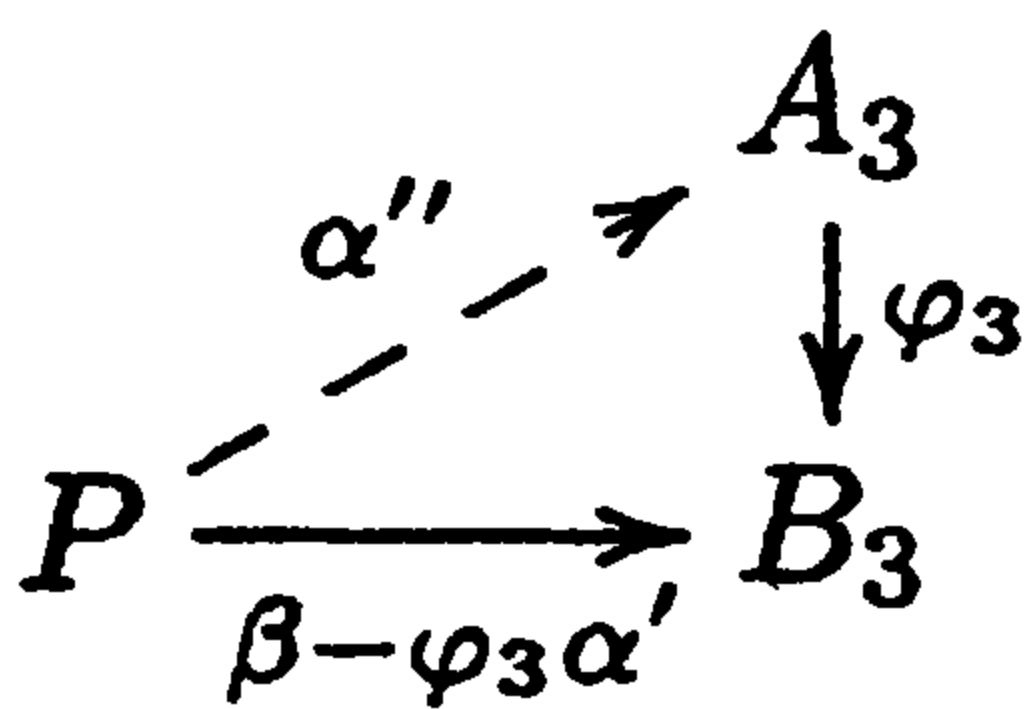

from which  $\beta = \varphi_3(\alpha' + \alpha'')$ .

Hence,  $a = f_3(a')$  for some  $a' \in A_3$  by exactness of the top row.

Hence,  $g_3(b) = \varphi_4(a) = \varphi_4f_3(a') = g_3\varphi_3(a')$ , that is,  $b - \varphi_3(a') \in \ker g_3 = \text{im } g_2 \subset \text{im } \varphi_3$ .

That is,  $b - \varphi_3(a') = \varphi_3(a'')$  for some  $a'' \in A_3$ , so  $b = \varphi_3(a' + a'')$ .

□

The individual parts of the proof can be diagrammed as follows.  
**Monic:**

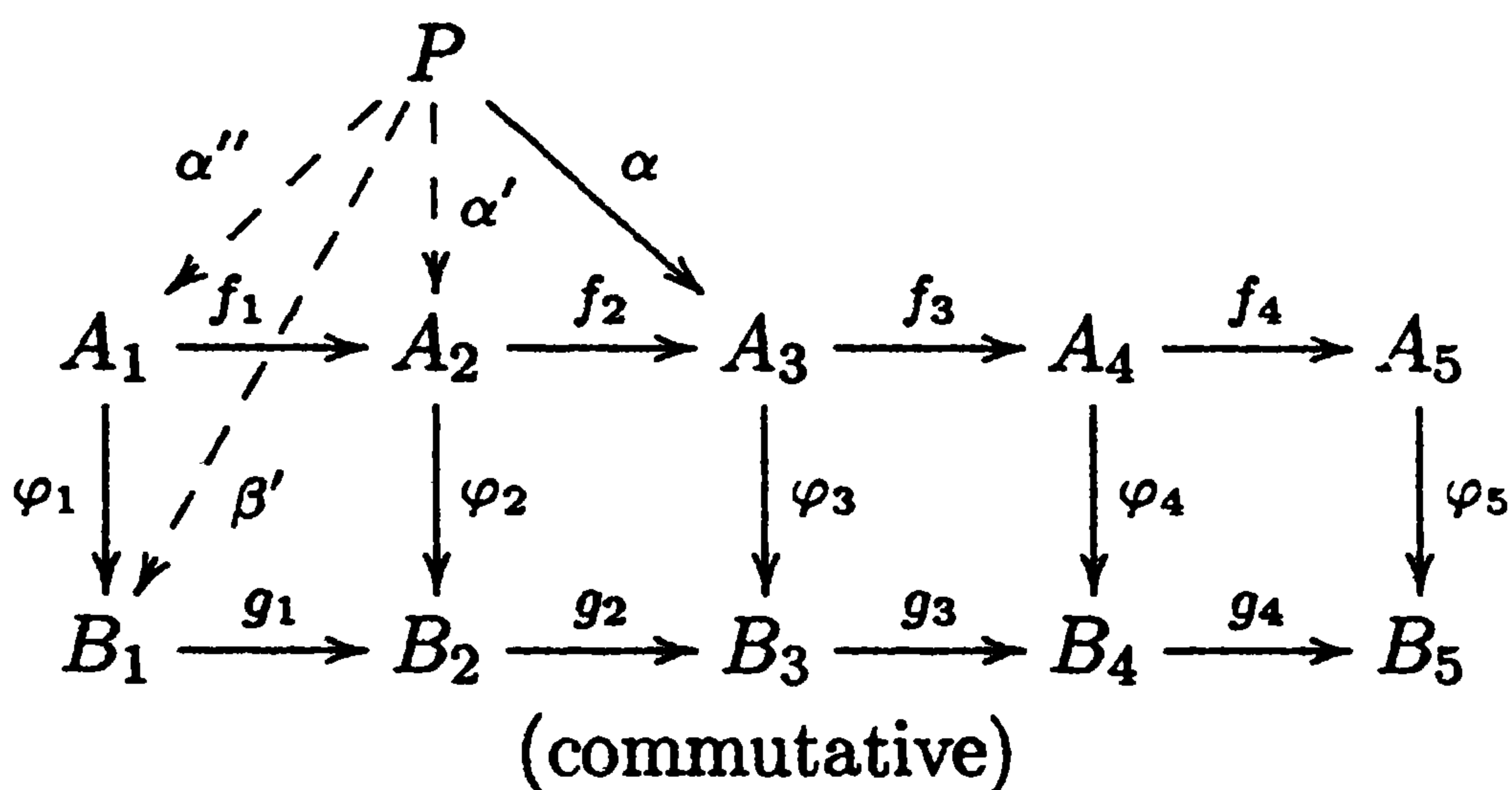

Epic, first part:

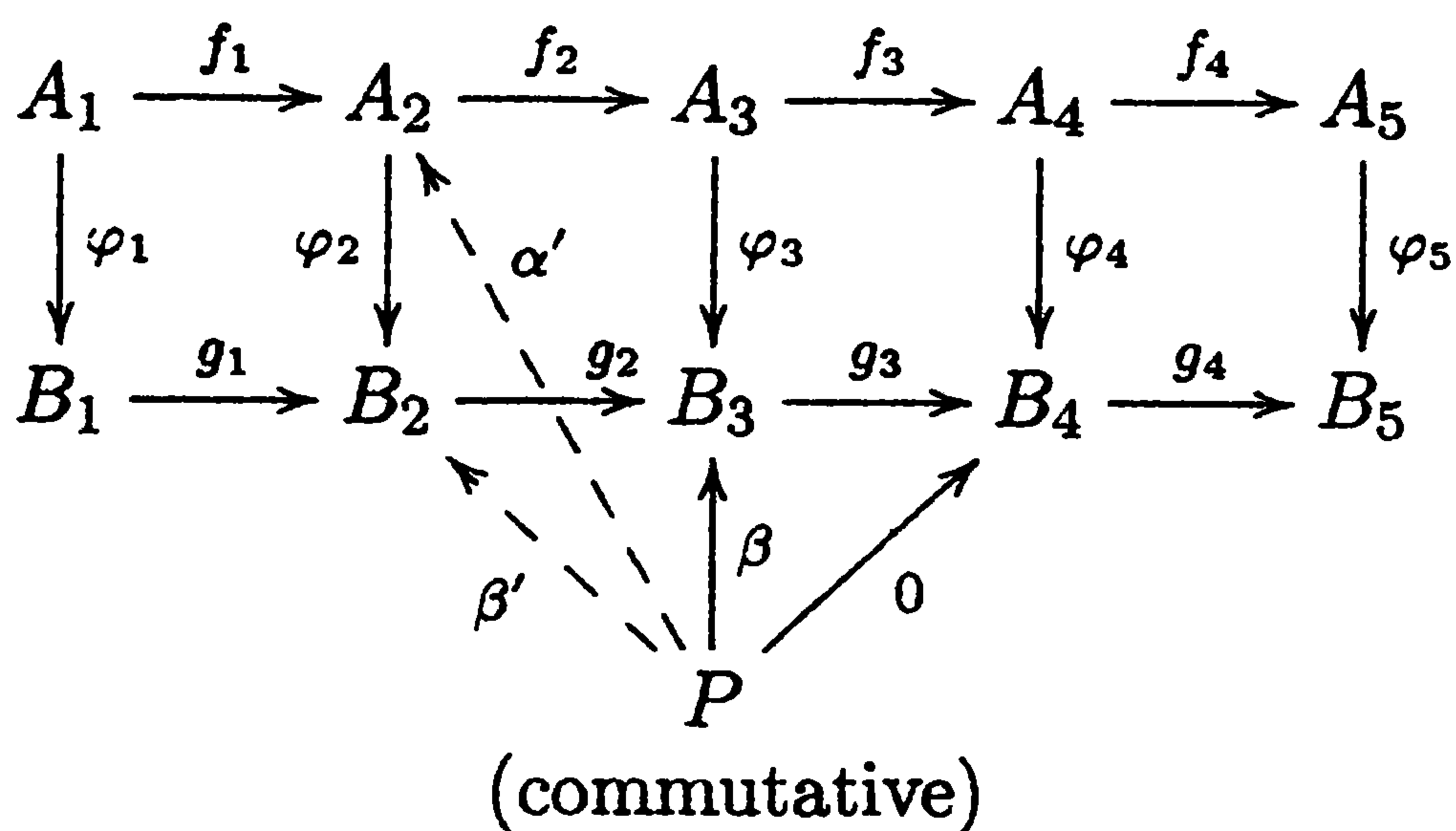

Epic, second part:

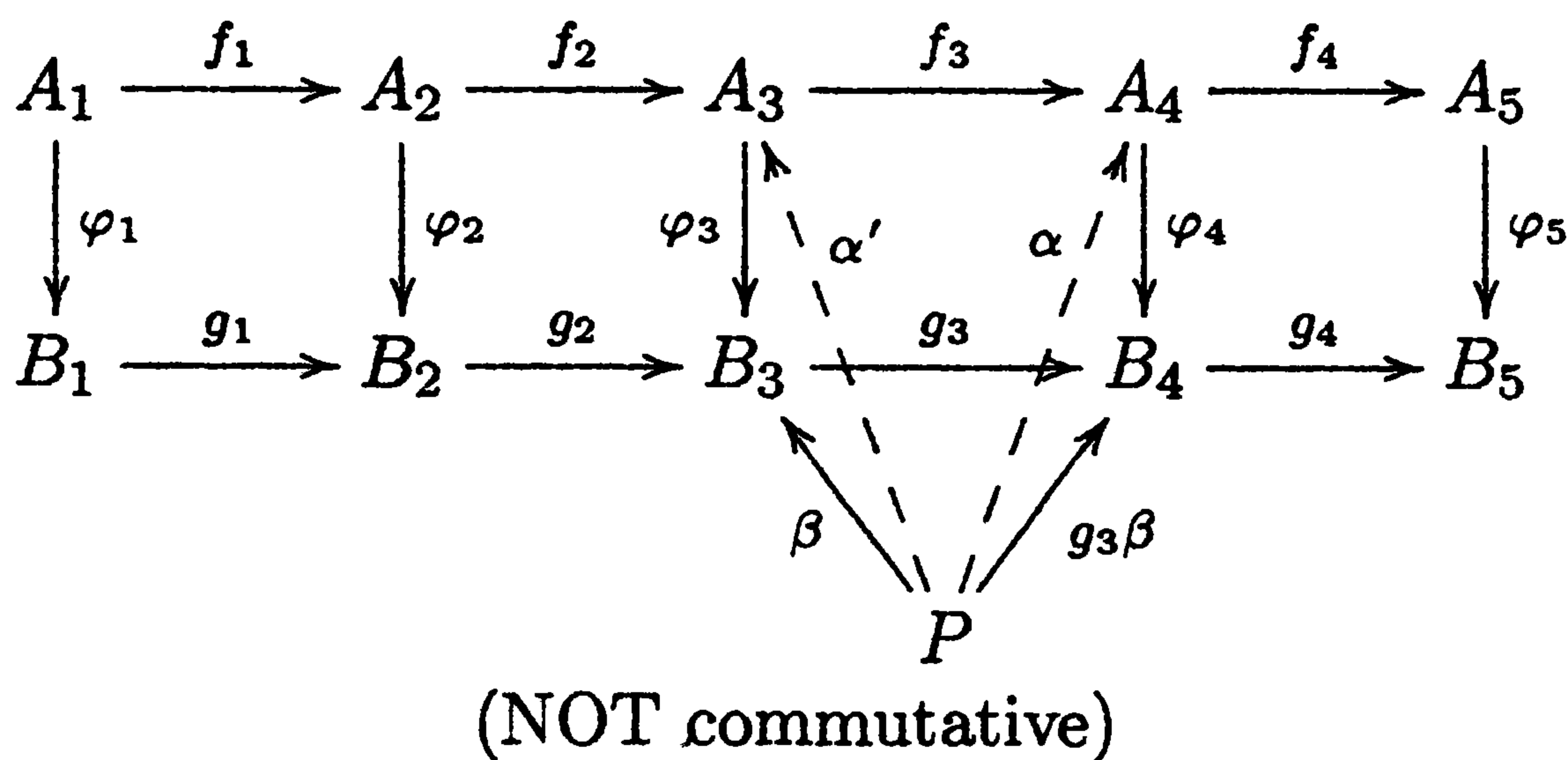

The first two diagrams are commutative. The third is commutative *except* that  $\beta \neq \varphi_3\alpha'$  in general. The morphism  $\alpha'$  is only designed to make the triangle involving  $\alpha$ ,  $f_3$ , and  $\alpha'$  commutative.

The final issue is the subject of simultaneous resolutions. To start with, we need an analog of Proposition 6.4 (which provided for proper behavior of kernels) suitable for our limited purposes.

**Proposition 7.20** *Suppose  $\mathcal{A}$  is a pre-Abelian category with a separating class of projectives. Suppose*

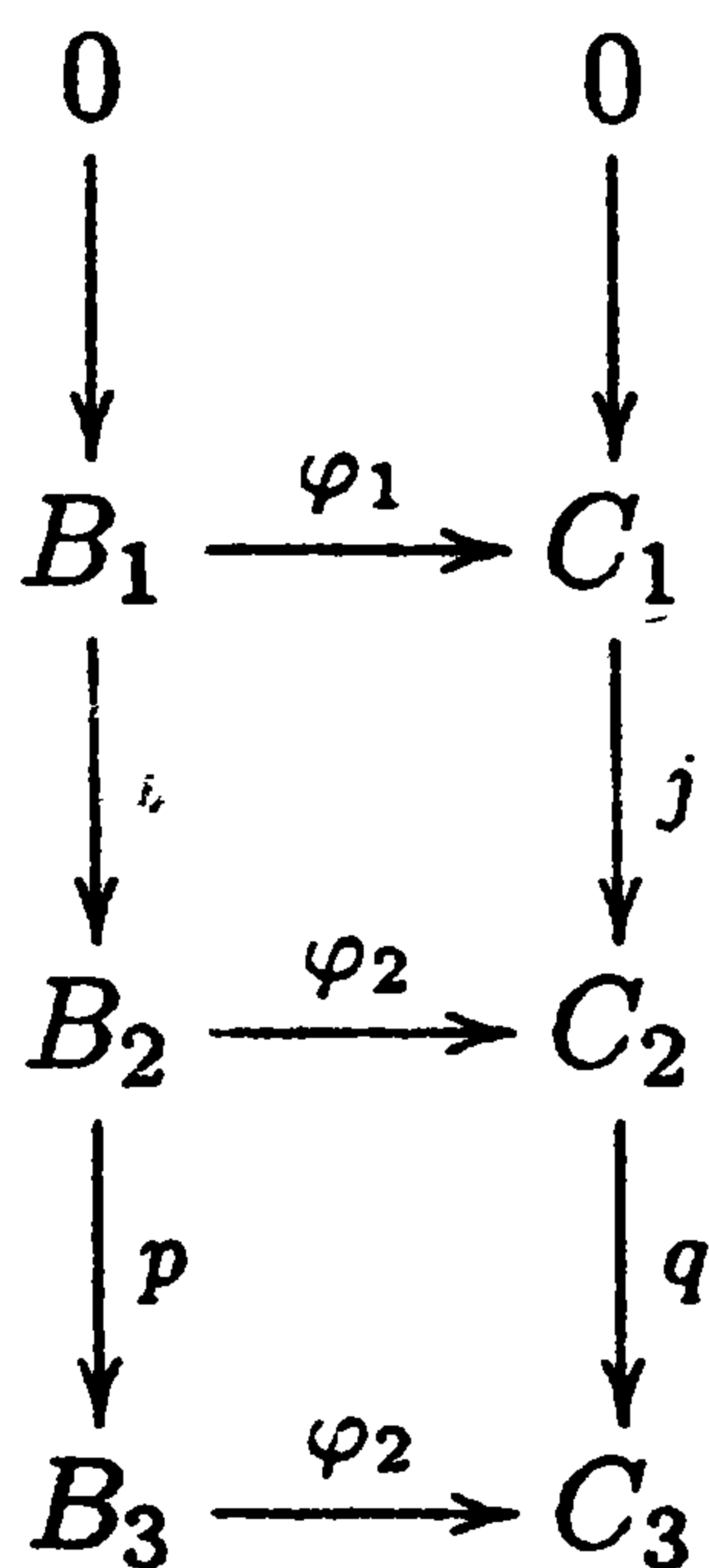

is commutative in  $\mathbf{A}$  with kernel-exact columns. Let  $\psi_i : K_i \rightarrow B_i$  denote a kernel of  $\varphi_i$ . Then the diagram

$$\begin{array}{ccccc}
 & 0 & & 0 & & 0 \\
 & \downarrow & & \downarrow & & \downarrow \\
 & K_1 & \xrightarrow{\psi_1} & B_1 & \xrightarrow{\varphi_1} & C_1 \\
 & \downarrow \iota' & & \downarrow \iota & & \downarrow j \\
 & K_2 & \xrightarrow{\psi_2} & B_2 & \xrightarrow{\varphi_2} & C_2 \\
 & \downarrow p' & & \downarrow p & & \downarrow q \\
 & K_3 & \xrightarrow{\psi_3} & B_3 & \xrightarrow{\varphi_3} & C_3
 \end{array}$$

has kernel-exact columns. Moreover,  $p'$  is epic provided  $\varphi_1$  and  $p$  are epic.

**Proof:** First of all, note that  $\psi_2 \iota' = \iota \psi_1$  is monic, so  $\iota'$  is monic directly. Furthermore,  $\psi_3 p' \iota' = p \psi_2 \iota' = p \iota \psi_1 = 0$ , so  $p' \iota' = 0$ , since  $\psi_3$  is monic. Now suppose  $P$  is projective, and  $\theta : P \rightarrow K_2$  satisfies  $p' \theta = 0$ . Then  $p \psi_2 \theta = \psi_3 p' \theta = 0$ , so we get a filler  $\lambda$  for

$$\begin{array}{ccc}
 & & B_1 \\
 & \nearrow \lambda & \downarrow \iota \\
 P & \xrightarrow{\psi_2 \theta} & B_2 \\
 & \searrow 0 & \downarrow p \\
 & & B_3
 \end{array}$$

by Proposition 7.14(c). Now  $j \varphi_1 \lambda = \varphi_2 \iota \lambda = \varphi_2 \psi_2 \theta = 0$ , so  $\varphi_1 \lambda = 0$ , since  $j$  is monic. But that means that  $\lambda$  factors through  $K_1$ :

$$\begin{array}{ccccc}
 & & K_1 & \xrightarrow{\psi_1} & B_1 & \xrightarrow{\varphi_1} & C_1 \\
 & \nearrow \mu & \downarrow \iota' & & \downarrow \iota & & \downarrow j \\
 P & \xrightarrow{\theta} & K_2 & \xrightarrow{\psi_2} & B_2 & \xrightarrow{\varphi_2} & C_2 \\
 & & \downarrow p' & & \downarrow p & & \downarrow q \\
 & & K_3 & \xrightarrow{\psi_3} & B_3 & \xrightarrow{\varphi_3} & C_3
 \end{array}$$

In this diagram, we know that  $\mu$  satisfies  $\psi_1 \mu = \lambda$ ; we want that  $\iota' \mu = \theta$ . But  $\psi_2 \iota' \mu = \iota \psi_1 \mu = \iota \lambda = \psi_2 \theta$ , so  $\iota' \mu = \theta$ , since  $\psi_2$  is monic. Since our original  $\theta : P \rightarrow K_2$  was arbitrary,  $K_1 \rightarrow K_2 \rightarrow K_3$  is kernel-exact by Proposition 7.14(c).

Now suppose  $\varphi_1$  and  $p$  are epic, and suppose  $\theta : P \rightarrow K_3$  is given, with  $P$  projective. Since  $p$  is epic, we have a filler  $\eta$  for

$$\begin{array}{ccc} & & B_2 \\ & \nearrow \eta & \downarrow p \\ P & \xrightarrow{\theta} & K_3 \xrightarrow{\psi_3} B_3 \end{array}$$

Since  $0 = \varphi_3\psi_3\theta = \varphi_3p\eta = q\varphi_2\eta$ , there is a filler  $\lambda$  for

$$\begin{array}{ccc} & & C_1 \\ & \nearrow \lambda & \downarrow j \\ P & \xrightarrow{\varphi_2\eta} & C_2 \\ & & \downarrow q \\ & & C_3 \end{array}$$

by Proposition 7.14(c). Finally, since  $\varphi_1$  is epic, there is a filler  $\mu$  for

$$\begin{array}{ccc} B_1 & \xrightarrow{\varphi_1} & C_1 \\ \uparrow \mu & \nearrow \lambda & \\ P & & \end{array}$$

since  $P$  is projective. Now  $\varphi_2\eta = j\lambda = j\varphi_1\mu = \varphi_2\iota\mu$ , so  $\varphi_2(\eta - \iota\mu) = 0$ , and  $\eta - \iota\mu$  factors through  $K_2$

$$\begin{array}{ccc} K_2 & \xrightarrow{\psi_2} & B_2 \xrightarrow{\varphi_2} C_2 \\ \uparrow \nu & \nearrow \eta - \iota\mu & \\ P & & \end{array}$$

since  $\psi_2$  is a kernel for  $\varphi_2$ . We have that

$$\psi_3p'\nu = p\psi_2\nu = p(\eta - \iota\mu) = p\eta - p\iota\mu = p\eta = \psi_3\theta.$$

Since  $\psi_3$  is monic,  $\theta = p'\nu$ , and  $\nu$  is a filler for

$$\begin{array}{ccc} & & K_2 \\ & \nearrow \nu & \downarrow p' \\ P & \xrightarrow{\theta} & K_3 \end{array}$$

Since  $\theta : P \rightarrow K_3$  was arbitrary,  $p'$  is epic by Proposition 7.14(b).  $\square$

We can now obtain simultaneous resolutions by following the recipe in Proposition 6.5, suitably modified.



**Proposition 7.21** *Suppose  $0 \rightarrow B \rightarrow B' \rightarrow B'' \rightarrow 0$  is kernel-exact in a pre-Abelian category  $\mathbf{A}$  with enough projectives. Given projective resolutions of  $B$  and  $B''$ :*

$$\begin{array}{ccccccc}
 & & & & & 0 & \\
 & & & & & \downarrow & \\
 \cdots & \longrightarrow & P_2 & \xrightarrow{d_2} & P_1 & \xrightarrow{d_1} & P_0 \xrightarrow{\pi} B \longrightarrow 0 \\
 & & & & & \downarrow & \\
 & & & & & B' & \\
 & & & & & \downarrow & \\
 \cdots & \longrightarrow & P_2'' & \xrightarrow{d_2''} & P_1'' & \xrightarrow{d_1''} & P_0'' \xrightarrow{\pi''} B'' \longrightarrow 0 \\
 & & & & & \downarrow & \\
 & & & & & 0 & 
 \end{array}$$

there exist morphisms  $\pi' : P_0 \oplus P_0'' \rightarrow B'$  and  $d_n' : P_n \oplus P_n'' \rightarrow P_{n-1} \oplus P_{n-1}''$  such that

$$\begin{array}{cccccccc}
 & & 0 & & 0 & & 0 & & 0 & \\
 & & \downarrow & & \downarrow & & \downarrow & & \downarrow & \\
 \cdots & \longrightarrow & P_2 & \xrightarrow{d_2} & P_1 & \xrightarrow{d_1} & P_0 & \xrightarrow{\pi} & B & \longrightarrow 0 \\
 & & \downarrow & & \downarrow & & \downarrow & & \downarrow & \\
 \cdots & \longrightarrow & P_2 \oplus P_2'' & \xrightarrow{d_2'} & P_1 \oplus P_1'' & \xrightarrow{d_1'} & P_0 \oplus P_0'' & \xrightarrow{\pi'} & B' & \longrightarrow 0 \\
 & & \downarrow & & \downarrow & & \downarrow & & \downarrow & \\
 \cdots & \longrightarrow & P_2'' & \xrightarrow{d_2''} & P_1'' & \xrightarrow{d_1''} & P_0'' & \xrightarrow{\pi''} & B'' & \longrightarrow 0 \\
 & & \downarrow & & \downarrow & & \downarrow & & \downarrow & \\
 & & 0 & & 0 & & 0 & & 0 & 
 \end{array}$$

is commutative with kernel-exact rows and columns. (The vertical morphisms are the obvious ones.)

**Remark:**  $P_j \oplus P_j''$  is projective (see Exercise 21), and consequently the middle row is a projective resolution of  $B'$ .

**Proof:** First, find a filler  $f$  for

$$\begin{array}{ccc}
 & & B' \\
 & \nearrow f & \downarrow p \\
 P_0'' & \xrightarrow{\pi''} & B''
 \end{array}$$

using the fact that  $P_0''$  is projective. Now suppose  $(P_0'; \varphi, \varphi'', \rho, \rho'')$  is a biproduct of  $P_0$  with  $P_0''$  (so that  $P_0'$  can serve as  $P_0 \oplus P_0''$ ). The first two

columns now are

$$\begin{array}{ccc}
 0 & & 0 \\
 \downarrow & & \downarrow \\
 P_0 & \xrightarrow{\pi} & B \\
 \downarrow \varphi & & \downarrow j \\
 P'_0 & & B' \\
 \downarrow \rho'' & \nearrow f & \downarrow p \\
 P''_0 & \xrightarrow{\pi''} & B'' \\
 \downarrow & & \downarrow \\
 0 & & 0
 \end{array}$$

and these columns are exact. (Exactness of the  $P_0$  column is easily checked; we shall return to this in Section 7.8.) We now set  $\pi' = f\rho'' + j\pi\rho$ . Note that  $\pi'\varphi = f\rho''\varphi + j\pi\rho\varphi = 0 + j\pi = j\pi$ , while  $p\pi' = pf\rho'' + pj\pi\rho = \pi''\rho'' + 0 = \pi''\rho''$ ; thus,

$$\begin{array}{ccc}
 0 & & 0 \\
 \downarrow & & \downarrow \\
 P_0 & \xrightarrow{\pi} & B \\
 \downarrow \varphi & & \downarrow j \\
 P'_0 & \xrightarrow{\pi'} & B' \\
 \downarrow \rho'' & & \downarrow p \\
 P''_0 & \xrightarrow{\pi''} & B'' \\
 \downarrow & & \downarrow \\
 0 & & 0
 \end{array}$$

is commutative. Observe that  $\pi'$  is epic by the “epic 4-lemma” (see Exercise 16; it is buried inside Proposition 7.19), since we have

$$\begin{array}{ccc}
 P_0 & \xrightarrow{\text{epic}} & B \\
 \downarrow & & \downarrow \\
 P'_0 & \xrightarrow{\pi'} & B' \\
 \downarrow & & \downarrow \\
 P''_0 & \xrightarrow{\text{epic}} & B'' \\
 \downarrow & & \downarrow \\
 0 & \xrightarrow{\text{monic}} & 0
 \end{array}$$

To construct  $d'_n$  recursively, given  $\pi'$  and  $d'_0, \dots, d'_{n-1}$ , and  $K_n, K'_n, K''_n$  kernels of  $d_{n-1}, d'_{n-1}$ , and  $d''_{n-1}$  (or  $\pi, \pi',$  and  $\pi''$  if  $n = 1$ ) we construct  $d'_n$  via its factorization through  $K'_n$ :

$$\begin{array}{ccccc}
 0 & & 0 & & 0 \\
 \downarrow & & \downarrow & & \downarrow \\
 K_n & \xrightarrow{j_n} & P_{n-1} & \xrightarrow{\pi_{n-1}} & K_{n-1} \\
 \downarrow & & \downarrow & & \downarrow \\
 K'_n & \xrightarrow{j'_n} & P'_{n-1} & \xrightarrow{\pi'_{n-1}} & K'_{n-1} \\
 \downarrow & & \downarrow & & \downarrow \\
 K''_n & \xrightarrow{j''_n} & P''_{n-1} & \xrightarrow{\pi''_{n-1}} & K''_{n-1} \\
 \downarrow & & \downarrow & & \downarrow \\
 0 & & 0 & & 0
 \end{array}$$

Note that things start with  $n = 1$ , and in that circumstance  $0 \rightarrow B \rightarrow B' \rightarrow B'' \rightarrow 0$  replaces  $0 \rightarrow K_0 \rightarrow K'_0 \rightarrow K''_0 \rightarrow 0$ . By induction on  $n$ , the lefthand column is kernel-exact (using Proposition 7.20).

At this point we have

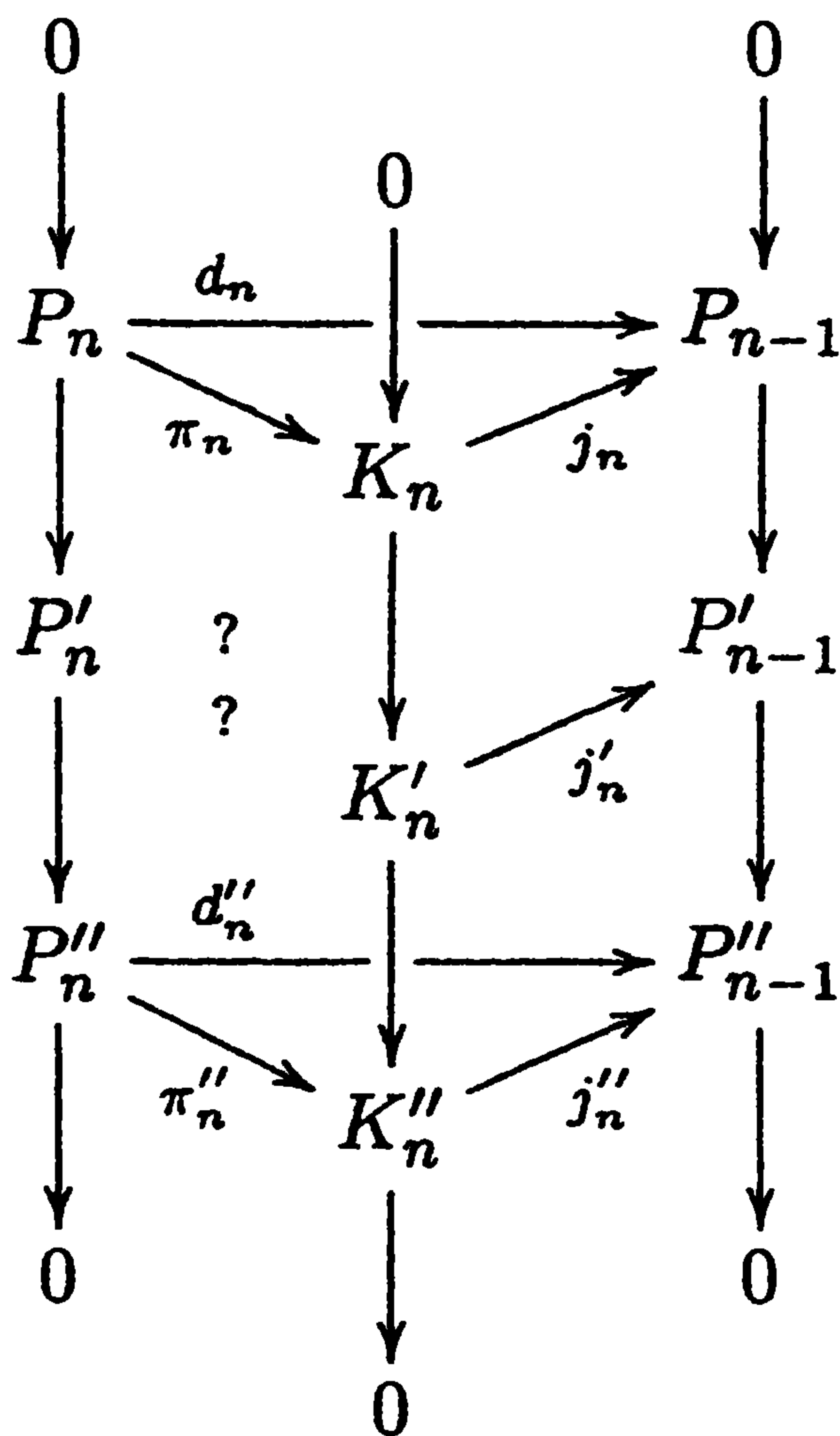

in which the missing fillers are marked with “?”. Now construct  $\pi'_n$  (and thereby  $d'_n = j'_n \pi'_n$ ) inside

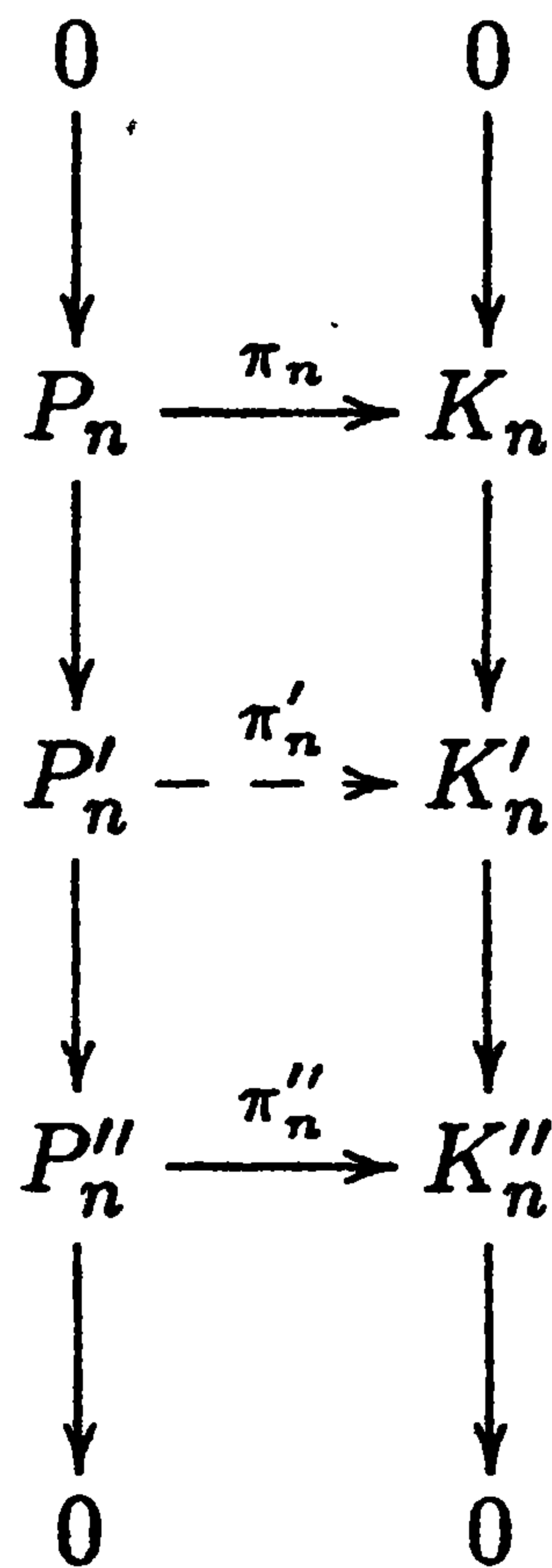

in *exactly* the same way as  $\pi'$  was constructed. Kernel-exactness of the middle row will follow from the fact that  $\pi'_n$  is epic.  $\square$

The above construction now produces long exact sequences when we form derived functors of an additive functor  $F : \mathbf{A} \rightarrow \mathbf{Ab}$ , where  $\mathbf{A}$  is pre-Abelian with enough projectives. Applying  $F$  to a resolution such as the one in Proposition 7.21 yields an array in  $\mathbf{Ab}$  with rows that are complexes and split-exact columns (by Proposition 7.4, using  $\mathbf{Ab}^{\text{op}}$  if  $F$  is contravariant). The appropriate long exact sequences then follow; this is Theorem 7.48 of Section 7.7. Ext, which is obtained by setting  $F = \text{Hom}(\bullet, C)$ , is covered by this, compliments of the management.

## 7.5 (Interlude) Arrow Categories

The subject of this section is a construction that turns most discussions of naturality into trivialities. We shall need the results of this in the next two sections, but the subject itself is a bit of an orphan, not really belonging in any specific place. The construction itself is admittedly a gimmick, but it is a surprisingly useful one. It is called the *arrow category* of a given category. If  $\mathbf{C}$  is a category, then the arrow category  $\mathbf{C}(\rightarrow)$  of  $\mathbf{C}$  is defined as follows.

The *objects* of  $\mathbf{C}(\rightarrow)$  are the morphisms  $f : A \rightarrow A'$  in  $\mathbf{C}$ . A *morphism* from  $f : A \rightarrow A'$  to  $g : B \rightarrow B'$  is a pair of morphisms  $\varphi : A \rightarrow B$  and  $\varphi' : A' \rightarrow B'$  such that the square

$$\begin{array}{ccc} A & \xrightarrow{\varphi} & B \\ \downarrow f & & \downarrow g \\ A' & \xrightarrow{\varphi'} & B' \end{array}$$

commutes. In order to sort things out, in this section (at least until the last paragraph) Roman letters will be used to denote the morphisms from  $\mathbf{C}$  that define objects in  $\mathbf{C}(\rightarrow)$ , while Greek letters will (in pairs) denote morphisms from  $\mathbf{C}(\rightarrow)$ . Also, whenever possible, the morphisms which define objects in  $\mathbf{C}(\rightarrow)$  will be written vertically, while the  $\mathbf{C}(\rightarrow)$  morphisms will be written horizontally. For concreteness, objects in  $\mathbf{C}(\rightarrow)$  are denoted as triples  $(A, f, A')$ ; the pair  $(\varphi, \varphi')$  denotes a morphism. Abbreviations like “ $f$ ” or “ $A \rightarrow A'$ ” sometimes will be used.

The connection with opposite categories is both obvious (in statement) and subtle (for an unconfusing proof).

**Proposition 7.22** *Suppose  $\mathbf{C}$  is any category. Then the correspondence*

$$\begin{aligned} (A, f, A') &\leftrightarrow (A', f, A) \\ (\varphi, \varphi') &\leftrightarrow (\varphi', \varphi) \end{aligned}$$

*gives an isomorphism of  $(\mathbf{C}(\rightarrow))^{\text{op}}$  with  $(\mathbf{C}^{\text{op}})(\rightarrow)$ .*

**Proof:** Recall that  $\mathbf{C}^{\text{op}}$  is literally obtained as follows:

$$\begin{array}{ll} \text{obj } \mathbf{C}^{\text{op}} = \text{obj } \mathbf{C} & \text{(objects)} \\ \text{Mor}_{\mathbf{C}^{\text{op}}}(A, B) = \text{Mor}_{\mathbf{C}}(B, A) & \text{(morphisms)} \\ \varphi \bullet_{\mathbf{C}^{\text{op}}} \psi = \psi \bullet_{\mathbf{C}} \varphi & \text{(composition rule)} \end{array}$$

For clarity, if we start with a  $\mathbf{C}$ -morphism  $f$  or  $\varphi$ , we shall write  $f^{\text{op}}$  or  $\varphi^{\text{op}}$  to denote this same  $f$  or  $\varphi$  considered as a  $\mathbf{C}^{\text{op}}$ -morphism. The



correspondence can be viewed then as

$$\begin{aligned}(A, f, A') &\mapsto (A', f^{\text{op}}, A) \\ (\varphi, \varphi') &\mapsto (\varphi'^{\text{op}}, \varphi^{\text{op}}).\end{aligned}$$

Note that

$$\begin{aligned}(A, f, A') \in \text{obj } \mathbf{C}(\rightarrow) = \text{obj}(\mathbf{C}(\rightarrow))^{\text{op}} &\Leftrightarrow f : A \rightarrow A' \text{ in } \mathbf{C} \\ &\Leftrightarrow f^{\text{op}} : A' \rightarrow A \text{ in } \mathbf{C}^{\text{op}} \\ &\Leftrightarrow (A', f^{\text{op}}, A) \in \mathbf{C}^{\text{op}}(\rightarrow).\end{aligned}$$

Furthermore, the reversibility of this shows that  $\text{obj}(\mathbf{C}(\rightarrow))^{\text{op}} \rightarrow \text{obj}(\mathbf{C}^{\text{op}})(\rightarrow)$  is a bijection.

Suppose  $(\varphi, \varphi') \in \text{Mor}_{\mathbf{C}(\rightarrow)}((A, f, A'), (B, g, B'))$  so that

$$\begin{array}{ccc} A & \xrightarrow{\varphi} & B \\ \downarrow f & & \downarrow g \\ A' & \xrightarrow{\varphi'} & B' \end{array}$$

is a commutative square in  $\mathbf{C}$ . Then

$$\begin{array}{ccc} A & \xleftarrow{\varphi^{\text{op}}} & B \\ \uparrow f^{\text{op}} & & \uparrow g^{\text{op}} \\ A' & \xleftarrow{\varphi'^{\text{op}}} & B' \end{array}$$

is a commutative square in  $\mathbf{C}^{\text{op}}$ , that is,

$$(\varphi'^{\text{op}}, \varphi^{\text{op}}) \in \text{Mor}_{(\mathbf{C}^{\text{op}})(\rightarrow)}((B', g^{\text{op}}, B), (A', f^{\text{op}}, A)).$$

This too is reversible, so the morphism correspondence is also a bijection. Finally, if also  $(\psi, \psi') \in \text{Mor}_{\mathbf{C}(\rightarrow)}((B, g, B'), (C, h, C'))$ , we get a commutative rectangle in  $\mathbf{C}$ :

$$\begin{array}{ccccc} A & \xrightarrow{\varphi} & B & \xrightarrow{\psi} & C \\ \downarrow f & & \downarrow g & & \downarrow h \\ A' & \xrightarrow{\varphi'} & B' & \xrightarrow{\psi'} & C' \end{array}$$

which transforms into

$$\begin{array}{ccccc} A & \xleftarrow{\varphi^{\text{op}}} & B & \xleftarrow{\psi^{\text{op}}} & C \\ \uparrow f^{\text{op}} & & \uparrow g^{\text{op}} & & \uparrow h^{\text{op}} \\ A' & \xleftarrow{\varphi'^{\text{op}}} & B' & \xleftarrow{\psi'^{\text{op}}} & C' \end{array}$$

in  $\mathbf{C}^{\text{op}}$ . The composition in  $\mathbf{C}^{\text{op}}(\rightarrow)$  is

$$\begin{aligned} (\varphi'^{\text{op}}, \varphi^{\text{op}}) \bullet_{\mathbf{C}^{\text{op}}(\rightarrow)} (\psi'^{\text{op}}, \psi^{\text{op}}) &= (\varphi'^{\text{op}} \bullet_{\mathbf{C}^{\text{op}}} \psi'^{\text{op}}, \varphi^{\text{op}} \bullet_{\mathbf{C}^{\text{op}}} \psi^{\text{op}}) \\ &= ((\psi' \bullet_{\mathbf{C}} \varphi')^{\text{op}}, (\psi \bullet_{\mathbf{C}} \varphi)^{\text{op}}) \end{aligned}$$

while the composition in  $\mathbf{C}(\rightarrow)^{\text{op}}$  is

$$\begin{aligned} (\varphi, \varphi')^{\text{op}} \bullet_{\mathbf{C}(\rightarrow)^{\text{op}}} (\psi, \psi')^{\text{op}} &= [(\psi, \psi') \bullet_{\mathbf{C}(\rightarrow)} (\varphi, \varphi')]^{\text{op}} \\ &= (\psi \bullet_{\mathbf{C}} \varphi, \psi' \bullet_{\mathbf{C}} \varphi')^{\text{op}}. \end{aligned}$$

Dropping the superscript “op” in the morphisms produces the needed result (while making interpretation of the formulas more difficult).  $\square$

In our situation, we start with an additive category. Note that if  $\mathbf{A}$  is an additive category, then so is  $\mathbf{A}(\rightarrow)$ : If  $(\varphi, \varphi')$  and  $(\psi, \psi')$  are in  $\text{Hom}((A, f, A'), (B, g, B'))$ , then  $(\varphi + \psi, \varphi' + \psi')$  is also in  $\text{Hom}((A, f, A'), (B, g, B'))$ . Furthermore,  $0 : O \rightarrow O$  is a zero object in  $\mathbf{A}(\rightarrow)$ . Finally, to reduce notation,  $\text{Hom}((A, f, A'), (B, g, B'))$  will be abbreviated as  $\text{Hom}(f, g)$ .

**Proposition 7.23** *Suppose  $\mathbf{A}$  is an additive category, and  $(\varphi, \varphi') \in \text{Hom}(f, g)$  in  $\mathbf{A}(\rightarrow)$ . Suppose  $\iota : K \rightarrow A$  is a kernel for  $\varphi$ , and  $\iota' : K' \rightarrow A'$  is a kernel for  $\varphi'$ . Let  $\bar{f} : K \rightarrow K'$  denote the induced morphism*

$$\begin{array}{ccccc} K & \xrightarrow{\iota} & A & \xrightarrow{\varphi} & B \\ \downarrow \bar{f} & & \downarrow f & & \downarrow g \\ K' & \xrightarrow{\iota'} & A' & \xrightarrow{\varphi'} & B' \end{array}$$

Then  $(\iota, \iota') : (K, \bar{f}, K') \rightarrow (A, f, A')$  is a kernel for  $(\varphi, \varphi')$ .

**Proof:** Suppose  $(\psi, \psi')$  maps  $(C, h, C')$  to  $(A, f, A')$  in  $\mathbf{A}(\rightarrow)$ , with  $(\varphi, \varphi')$   $(\psi, \psi') = (0, 0)$ . Then  $\psi$  factors through  $K$  and  $\psi'$  through  $K'$ , yielding the diagram

$$\begin{array}{ccccccc} C & \xrightarrow{\bar{\psi}} & K & \xrightarrow{\iota} & A & \xrightarrow{\varphi} & B \\ \downarrow h & & \downarrow \bar{f} & & \downarrow f & & \downarrow g \\ C' & \xrightarrow{\bar{\psi}'} & K' & \xrightarrow{\iota'} & A' & \xrightarrow{\varphi'} & B \end{array} \quad \begin{array}{l} \psi = \iota \bar{\psi} \\ \psi' = \iota' \bar{\psi}' \end{array}$$

This diagram is commutative, since  $\iota' \bar{f} \bar{\psi} = f \iota \bar{\psi} = f \psi = \psi' h = \iota' \bar{\psi}' h$ , so that  $\bar{f} \bar{\psi} = \bar{\psi}' h$  since  $\iota'$  is monic. (The lefthand square is the only one at issue.) Finally,  $\bar{\psi}$  and  $\bar{\psi}'$  are each unique, so that the pair  $(\bar{\psi}, \bar{\psi}')$  is unique.  $\square$

There are three corollaries:

**Corollary 7.24** *Suppose  $\mathbf{A}$  is an additive category, and  $(\varphi, \varphi') \in \text{Hom}(f, g)$  in  $\mathbf{A}(\rightarrow)$ . Suppose  $\pi : B \rightarrow D$  is a cokernel for  $\varphi$ , and  $\pi' : B' \rightarrow D'$  is a cokernel for  $\varphi'$ . Let  $\tilde{g} : D \rightarrow D'$  denote the induced morphism*

$$\begin{array}{ccccc} A & \xrightarrow{\varphi} & B & \xrightarrow{\pi} & D \\ \downarrow f & & \downarrow g & & \downarrow \tilde{g} \\ A' & \xrightarrow{\varphi'} & B' & \xrightarrow{\pi'} & D' \end{array}$$

*Then  $(\pi, \pi') : (B, g, B') \rightarrow (D, \tilde{g}, D')$  is a cokernel for  $(\varphi, \varphi')$ .*

**Proof:** Essentially the same as Proposition 7.23, with arrows reversed. (Look in  $\mathbf{A}(\rightarrow)^{\text{op}} \approx \mathbf{A}^{\text{op}}(\rightarrow)$ .)  $\square$

**Corollary 7.25** *Suppose  $\mathbf{A}$  is a pre-Abelian category, and suppose  $(\varphi, \varphi') \in \text{Hom}(f, g)$  in  $\mathbf{A}(\rightarrow)$ . Then  $(\varphi, \varphi')$  is monic in  $\mathbf{A}(\rightarrow)$  if and only if  $\varphi$  and  $\varphi'$  are each monic in  $\mathbf{A}$ .*

**Proof:**  $(\varphi, \varphi')$  is monic if and only if its kernel  $(\ker \varphi, \bar{f}, \ker \varphi')$  is zero (using earlier notation); this happens if and only if  $\varphi$  and  $\varphi'$  are each monic.  $\square$

**Corollary 7.26** *Suppose  $\mathbf{A}$  is a pre-Abelian category, and suppose  $(\varphi, \varphi') \in \text{Hom}(f, g)$ . Then  $(\varphi, \varphi')$  is epic in  $\mathbf{A}(\rightarrow)$  if and only if  $\varphi$  and  $\varphi'$  are each epic in  $\mathbf{A}$ .*

**Proof:**  $(\varphi, \varphi')$  is epic if and only if its cokernel  $(\text{coker} \varphi, \tilde{g}, \text{coker} \varphi')$  is zero (again using earlier notation); this happens if and only if  $\varphi$  and  $\varphi'$  are each epic.  $\square$

Next, consider biproducts. Suppose  $(A; \varphi_1, \varphi_2, \pi_1, \pi_2)$  is a biproduct of  $A_1$  and  $A_2$ , and  $(B; \psi_1, \psi_2, \rho_1, \rho_2)$  is a biproduct of  $B_1$  and  $B_2$ . Suppose  $f_1 : A_1 \rightarrow B_1$  and  $f_2 : A_2 \rightarrow B_2$ . There is an induced  $f : A \rightarrow B$  defined by  $f = \psi_1 f_1 \pi_1 + \psi_2 f_2 \pi_2$  making the diagrams

$$\begin{array}{ccccc} A_1 & \xrightarrow{\varphi_1} & A & \xleftarrow{\varphi_2} & A_2 \\ \downarrow f_1 & & \downarrow f & & \downarrow f_2 \\ B_1 & \xrightarrow{\psi_1} & B & \xleftarrow{\psi_2} & B_2 \end{array}$$

and

$$\begin{array}{ccccc} A_1 & \xleftarrow{\pi_1} & A & \xrightarrow{\pi_2} & A_2 \\ \downarrow f_1 & & \downarrow f & & \downarrow f_2 \\ B_1 & \xleftarrow{\rho_1} & B & \xrightarrow{\rho_2} & B_2 \end{array}$$

commutative:

$$f\varphi_1 = \psi_1 f_1 \pi_1 \varphi_1 + \psi_2 f_2 \pi_2 \varphi_1 = \psi_1 f_1 i_{A_1} + 0 = \psi_1 f_1$$

etc.

Now  $(\pi_1, \rho_1)(\varphi_1, \psi_1) = (i_{A_1}, i_{B_1})$ ,  $(\pi_2, \rho_2)(\varphi_2, \psi_2) = (i_{A_2}, i_{B_2})$ , and  $(\varphi_1, \psi_1)(\pi_1, \rho_1) + (\varphi_2, \psi_2)(\pi_2, \rho_2) = (\varphi_1 \pi_1 + \varphi_2 \pi_2, \psi_1 \rho_1 + \psi_2 \rho_2) = (i_A, i_B)$ . This just says:

**Proposition 7.27** *Suppose  $\mathbf{A}$  is an additive category. Suppose  $A_1$  and  $A_2$  have a biproduct in  $\mathbf{A}$ , and  $B_1$  and  $B_2$  have a biproduct in  $\mathbf{A}$ . If  $f_1 : A_1 \rightarrow B_1$  and  $f_2 : A_2 \rightarrow B_2$  are given, then  $f_1$  and  $f_2$  have a biproduct in  $\mathbf{A}(\rightarrow)$ .*

We can now quickly prove:

**Proposition 7.28** *Suppose  $\mathbf{A}$  is a pre-Abelian category. Then  $\mathbf{A}(\rightarrow)$  is pre-Abelian. Furthermore, if  $\mathbf{A}$  is Abelian, then so is  $\mathbf{A}(\rightarrow)$ .*

**Proof:** If  $\mathbf{A}$  is pre-Abelian, then  $\mathbf{A}(\rightarrow)$  has biproducts (Proposition 7.27), kernels (Proposition 7.23), and cokernels (Corollary 7.24). Hence,  $\mathbf{A}(\rightarrow)$  is pre-Abelian.

Suppose  $\mathbf{A}$  is Abelian. If  $(\varphi, \psi)$  is monic, then  $\varphi$  and  $\psi$  are each monic (Corollary 7.25). Let  $\pi$  denote a cokernel for  $\varphi$ , and  $\rho$  a cokernel for  $\psi$ . Then  $(\pi, \rho)$  is a cokernel for  $(\varphi, \psi)$  (Corollary 7.24). Furthermore,  $\varphi$  is a kernel for  $\pi$ , and  $\psi$  is a kernel for  $\rho$  (Proposition 7.12(iv)) since  $\varphi$  and  $\psi$  are monic. Hence,  $(\varphi, \psi)$  is a kernel for  $(\pi, \rho)$  (Proposition 7.23). All put together,  $\mathbf{A}(\rightarrow)$  satisfies Ab-monic; Ab-epic is similar.  $\square$

Now projectives. Suppose  $\mathbf{A}$  is pre-Abelian, and suppose  $P$  and  $P'$  are projective in  $\mathbf{A}$ . Then  $P \oplus P'$  is projective (Exercise 21).

**Proposition 7.29** *Suppose  $\mathbf{A}$  is pre-Abelian, and suppose  $P$  and  $P'$  are projective in  $\mathbf{A}$ . Then  $P \rightarrow P \oplus P'$  is projective in  $\mathbf{A}(\rightarrow)$ .*

**Proof:** This is done in two stages. First,  $0 \rightarrow P'$  is shown to be projective, then  $P \rightarrow P$  is shown to be projective. Their coproduct  $P \rightarrow P \oplus P'$  is then projective (see Exercise 21).

Suppose  $(\rho, \rho')$  is epic in  $\mathbf{A}(\rightarrow)$ :

$$\begin{array}{ccc} C & \xrightarrow{\rho} & A \\ \downarrow g & & \downarrow f \\ C' & \xrightarrow{\rho'} & A' \end{array}$$

Given  $\psi' : P' \rightarrow A'$ , we need fillers for

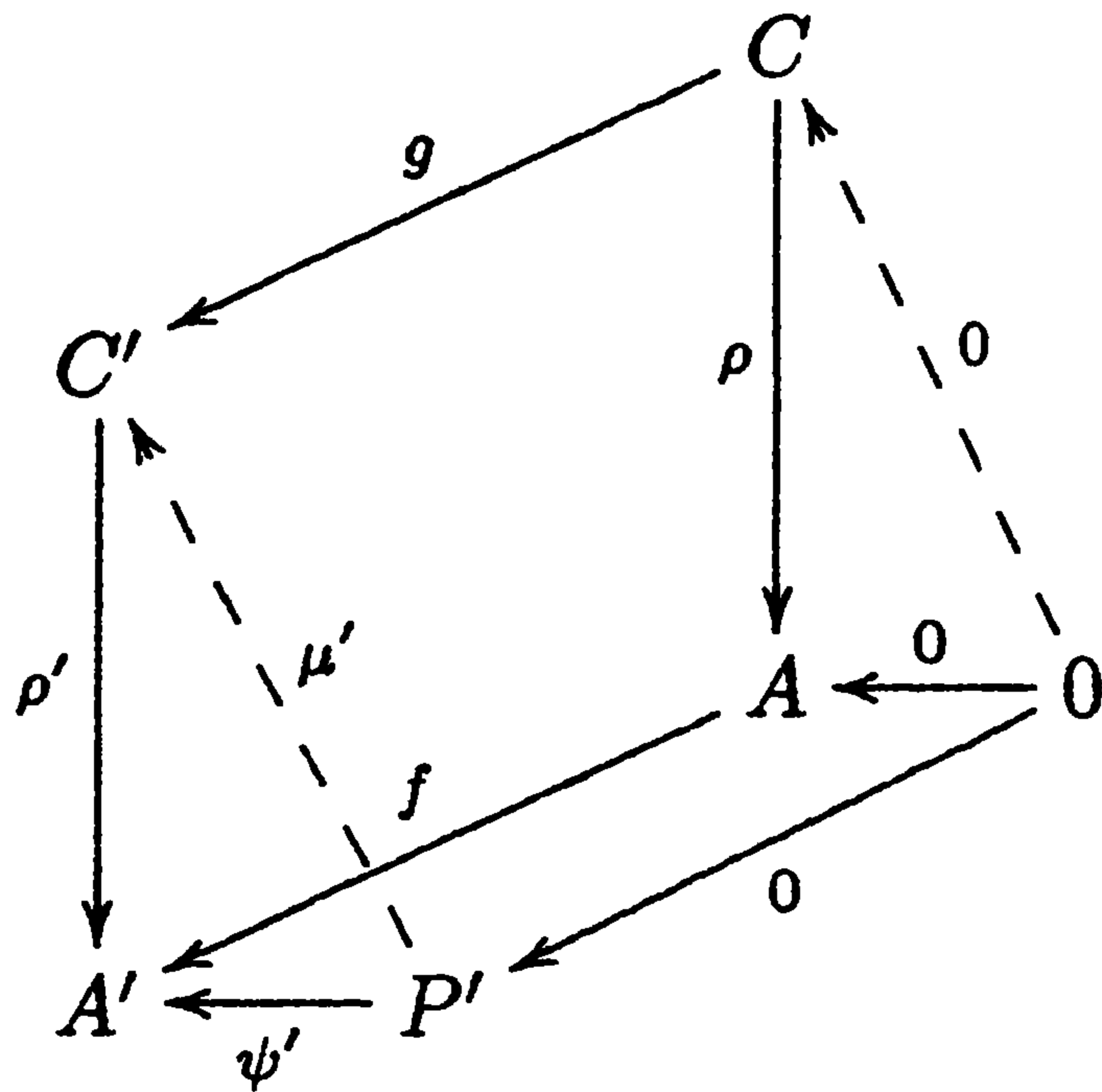

producing a commutative diagram. Any  $\mu'$  serving as a filler for

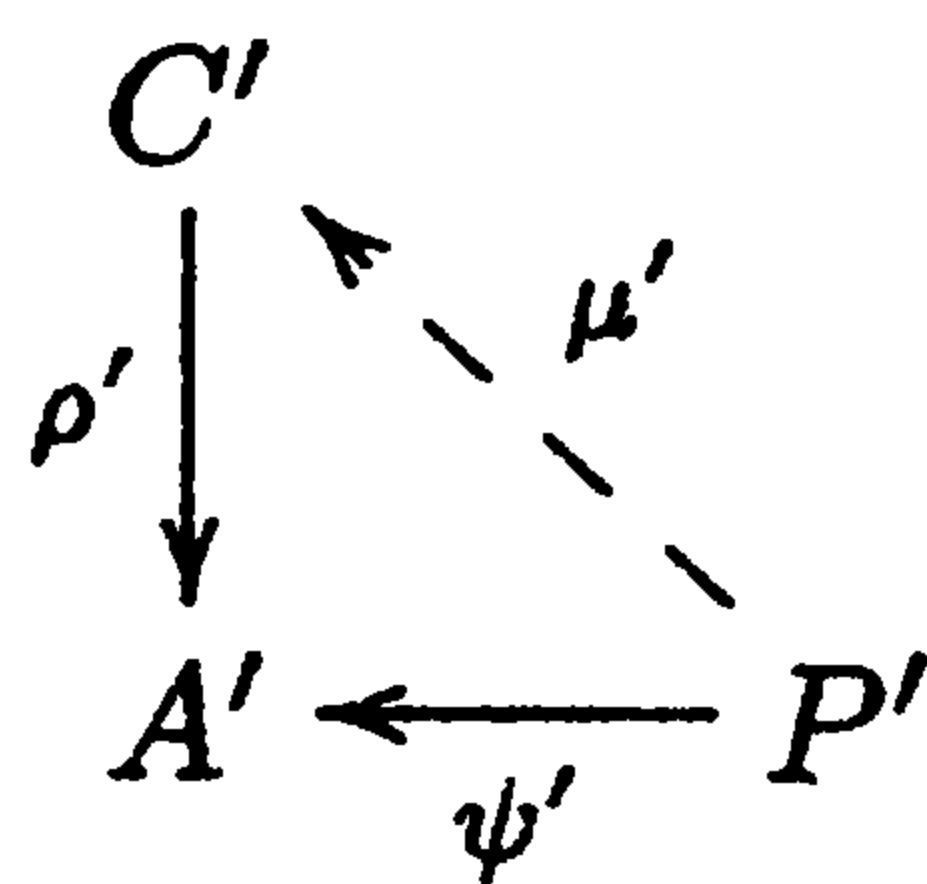

will do. ( $P'$  is projective, and this triangle is the only nontrivial part.) This takes care of  $0 \rightarrow P'$ .

Again, suppose  $(\rho, \rho')$  is epic in  $\mathbf{A}(\rightarrow)$ . Given  $(\psi, \psi') : i_P \rightarrow f$ , we need fillers  $\mu$  and  $\mu'$  such that

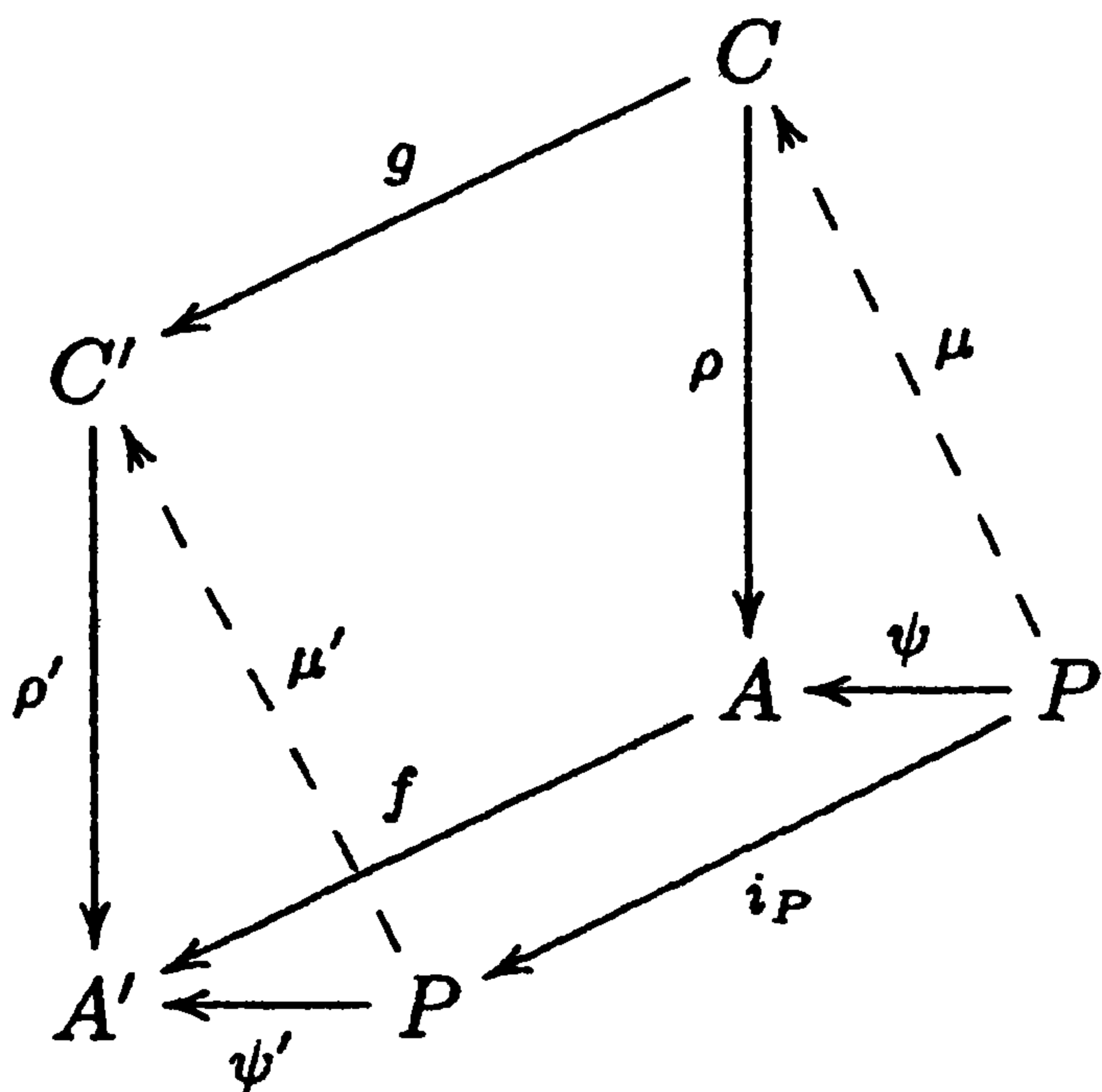

gives a commutative diagram. To do this, find a filler  $\mu$  for

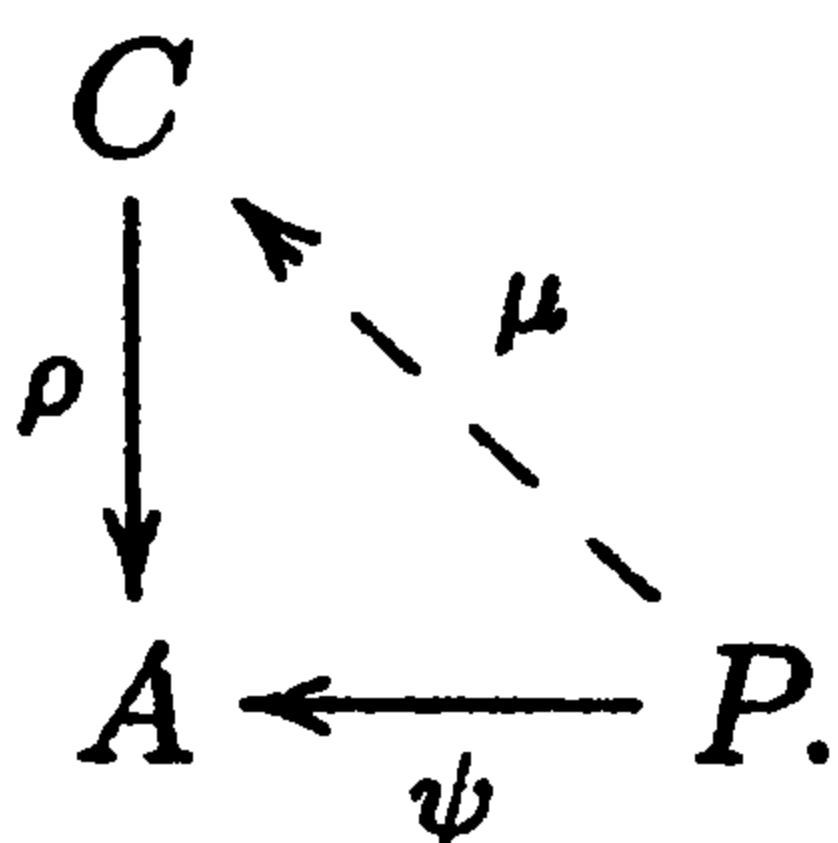



The far triangle is commutative. Setting  $\mu' = g\mu$  makes the top rectangle

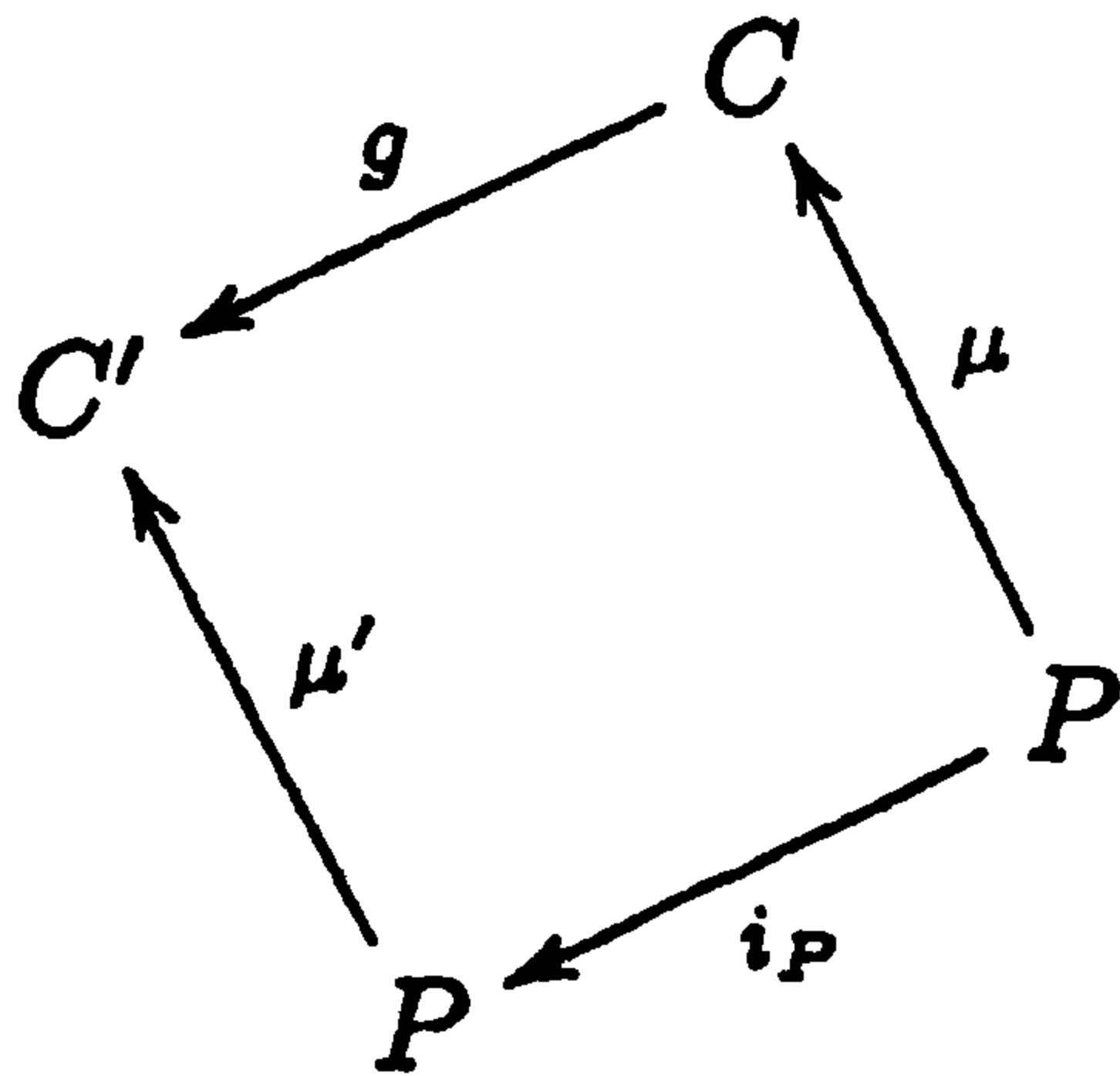

commutative. Finally, for the near triangle

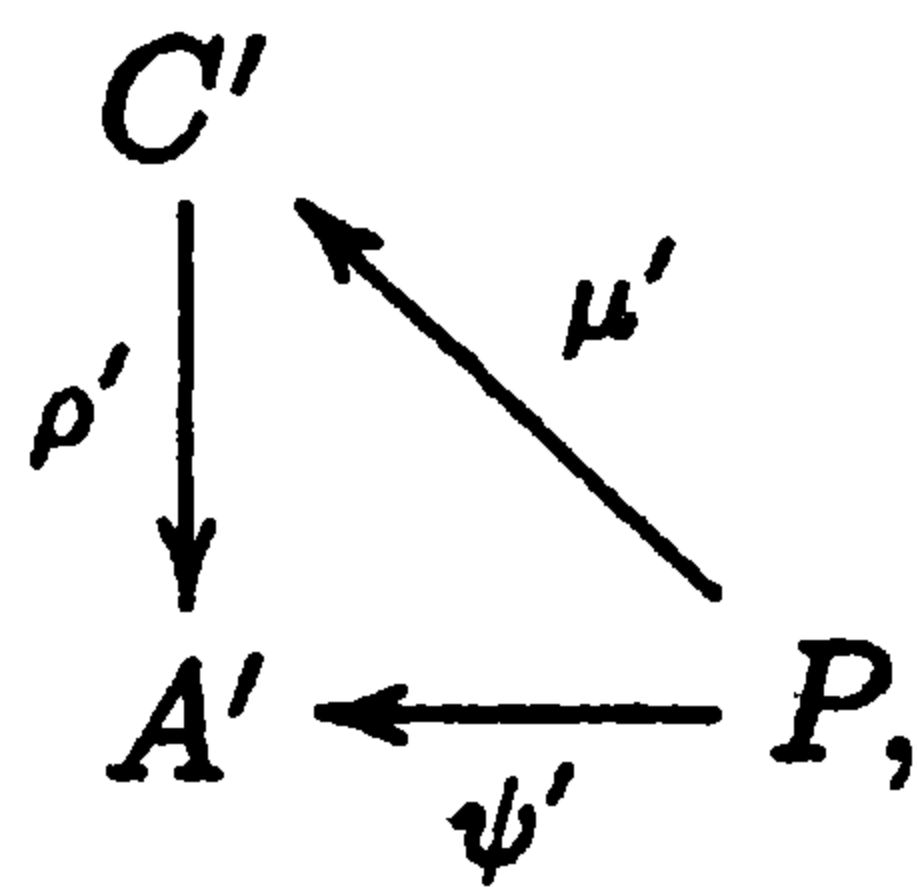

note that  $\rho'\mu' = \rho'g\mu = f\rho\mu = f\psi = \psi'$ , so this triangle is also commutative. □

This has a corollary, which is a technical result needed in Section 7.7.

**Corollary 7.30** (to proof of Proposition 7.29) *Suppose  $\mathcal{A}$  is a pre-Abelian category in which  $P, P',$  and  $P''$  are projective. Suppose the diagram*

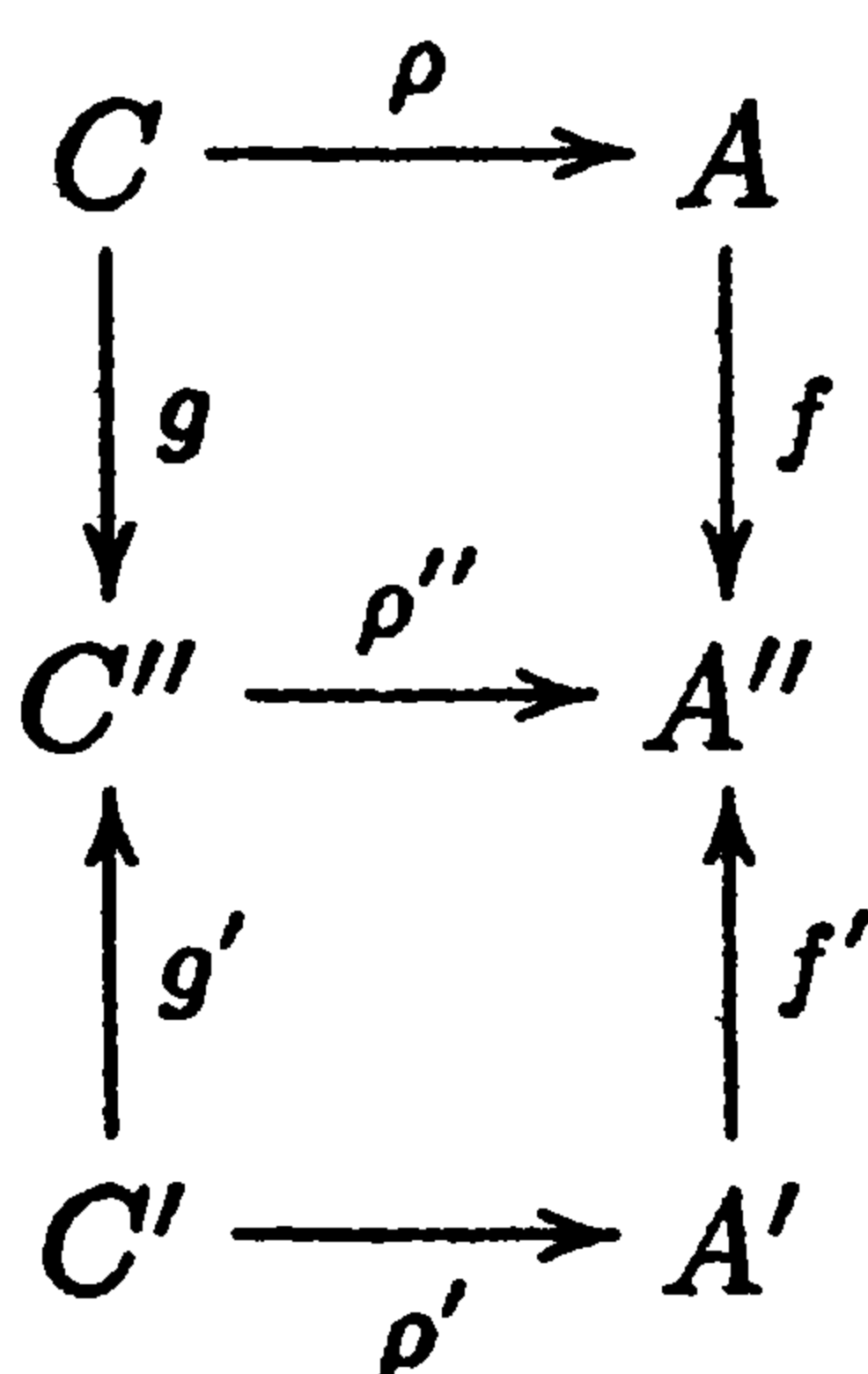

is given in  $\mathbf{A}$  with  $\rho$ ,  $\rho'$ , and  $\rho''$  all epic. Finally, suppose the commutative diagram (with fillers  $\mu$ ,  $\mu'$  chosen)

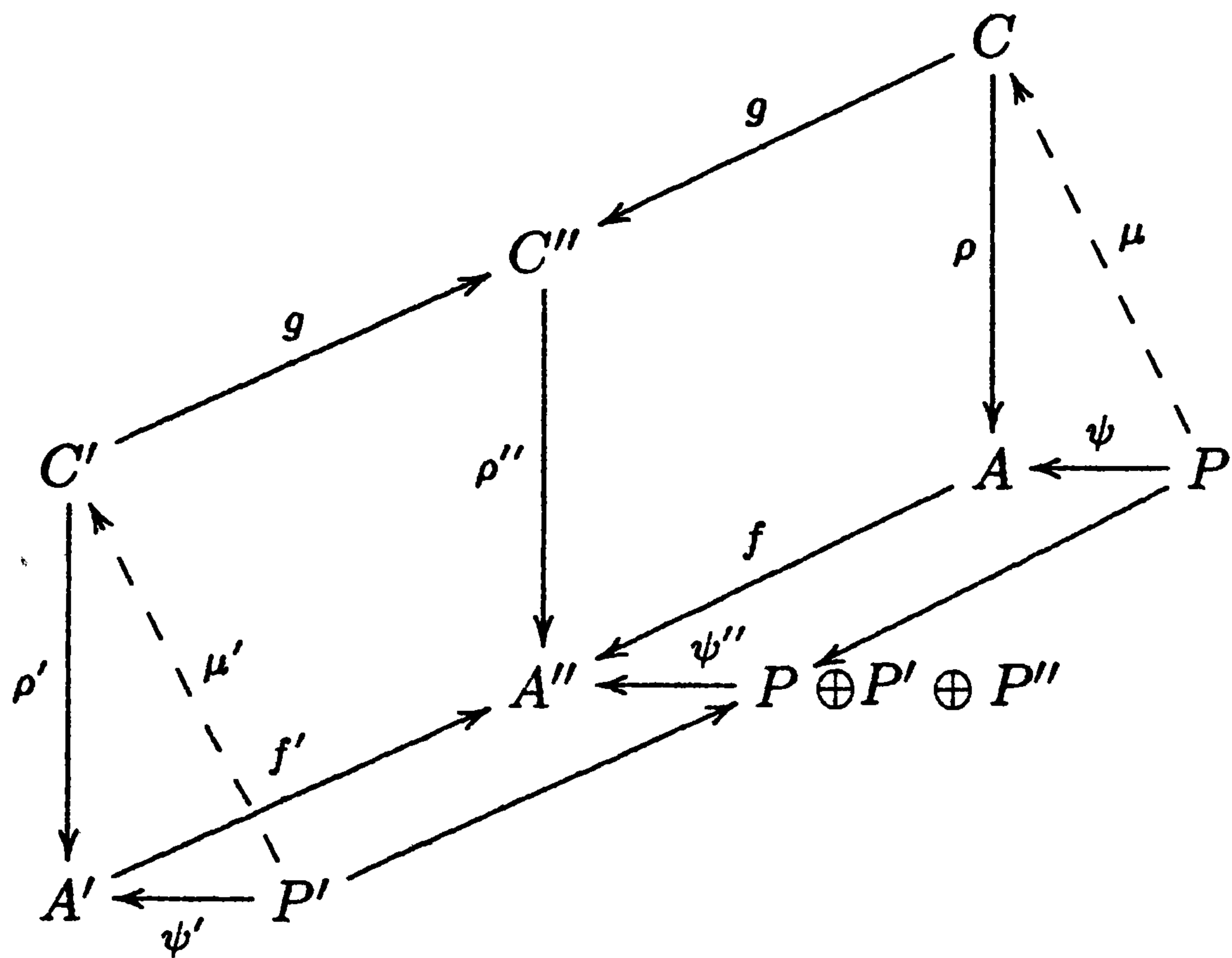

is given. Then there exists a filler  $\mu''$  for

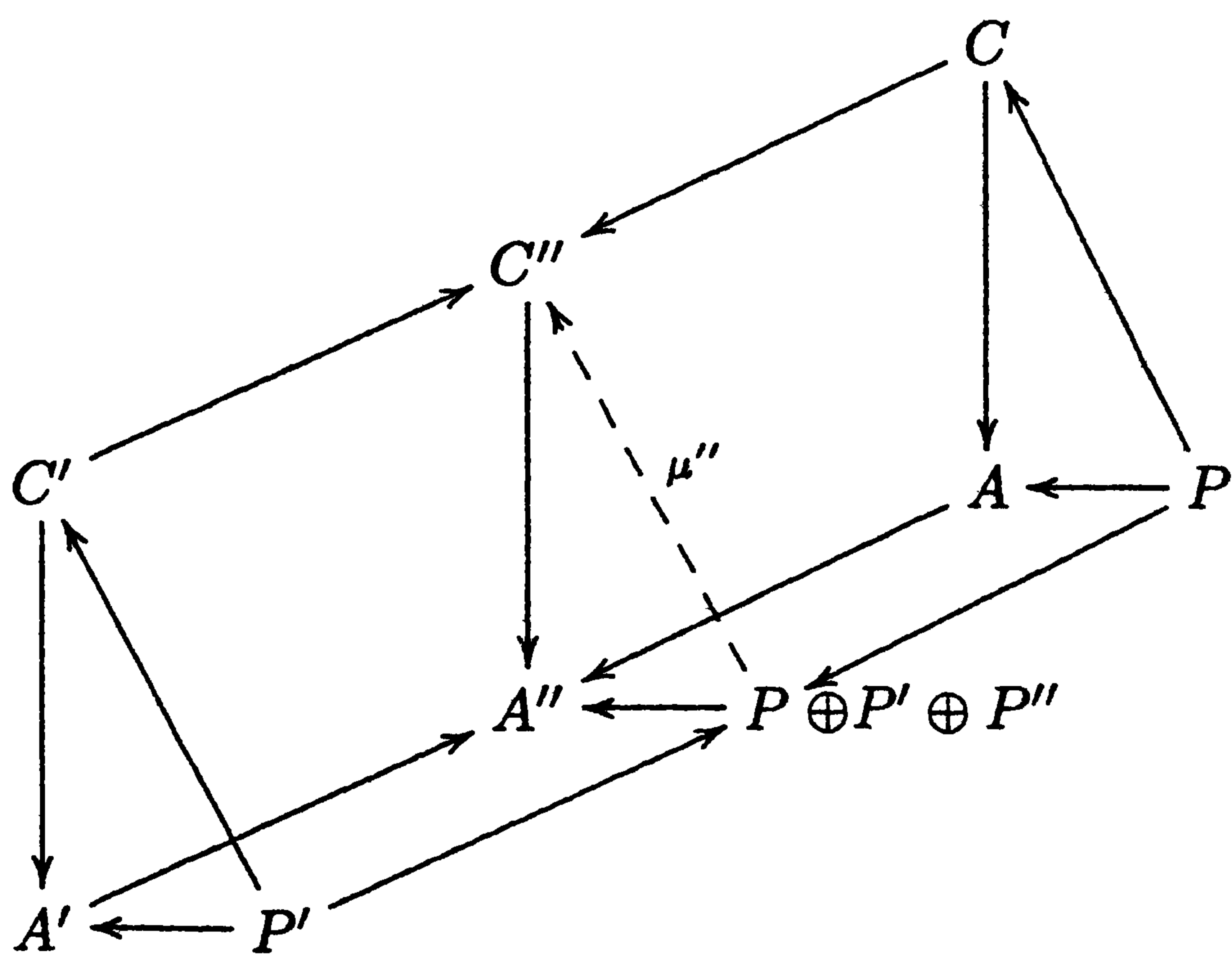

giving a commutative diagram.

**Proof:** From the point of view of the far wedge, this consists of lifting two things. First, given  $\mu$ , the morphism  $g\mu$  makes

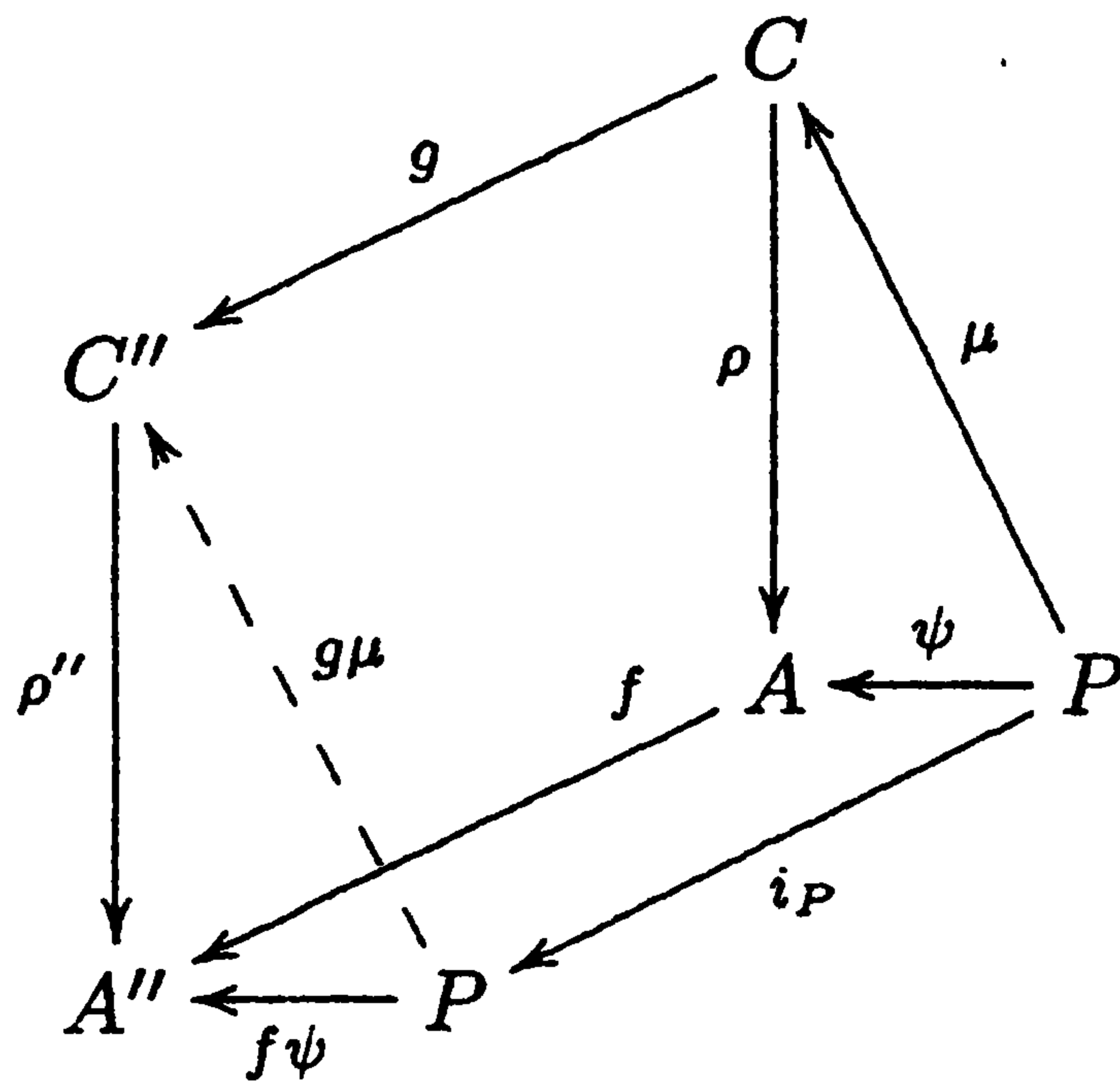

commutative (as noted in the earlier proof), so  $g\mu$  is the filler for this wedge. Furthermore, from the proof of Proposition 7.29, any filler  $\mu''$  for

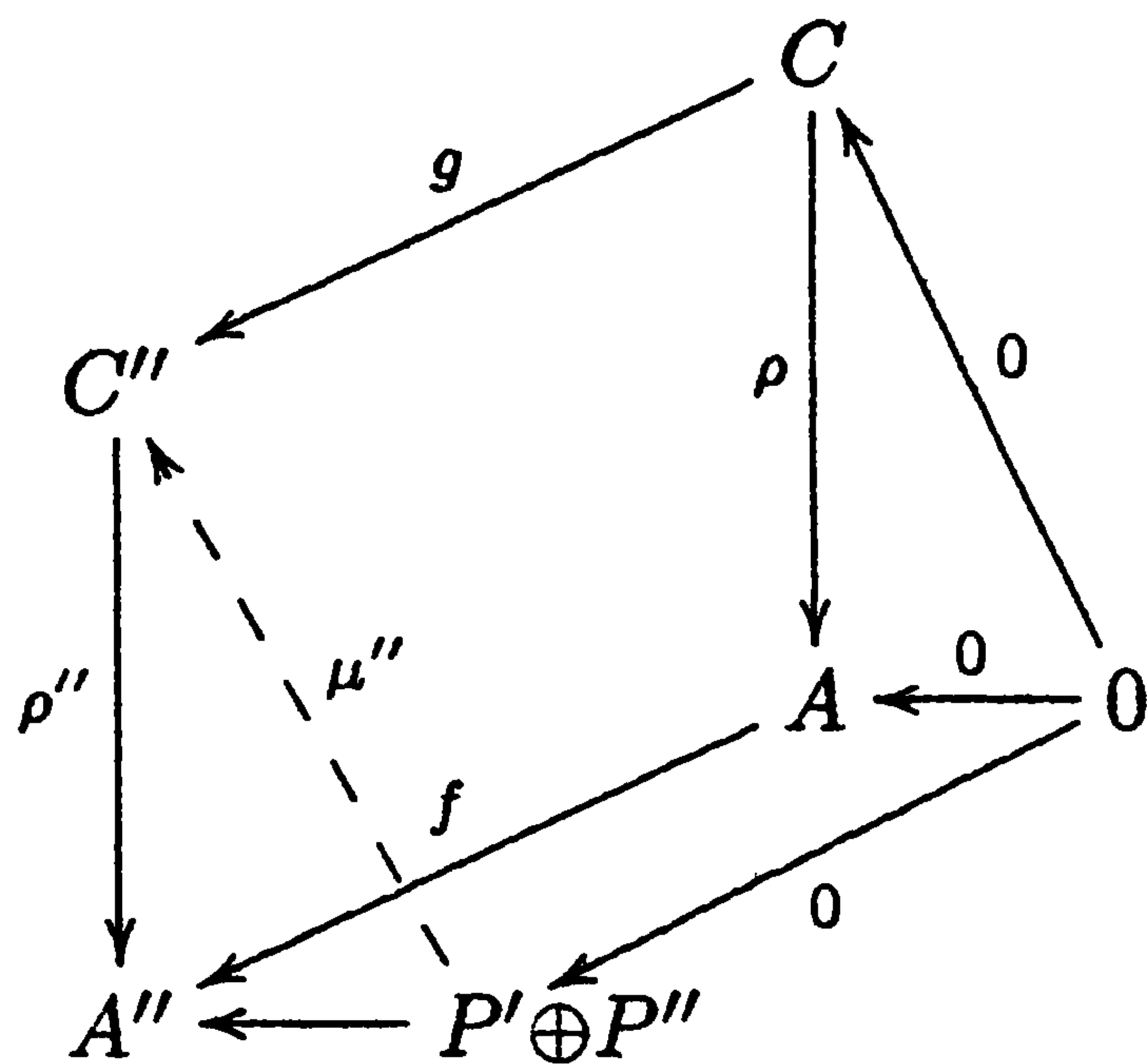

yields a commutative diagram. The filler to use is  $g'\mu'$  from

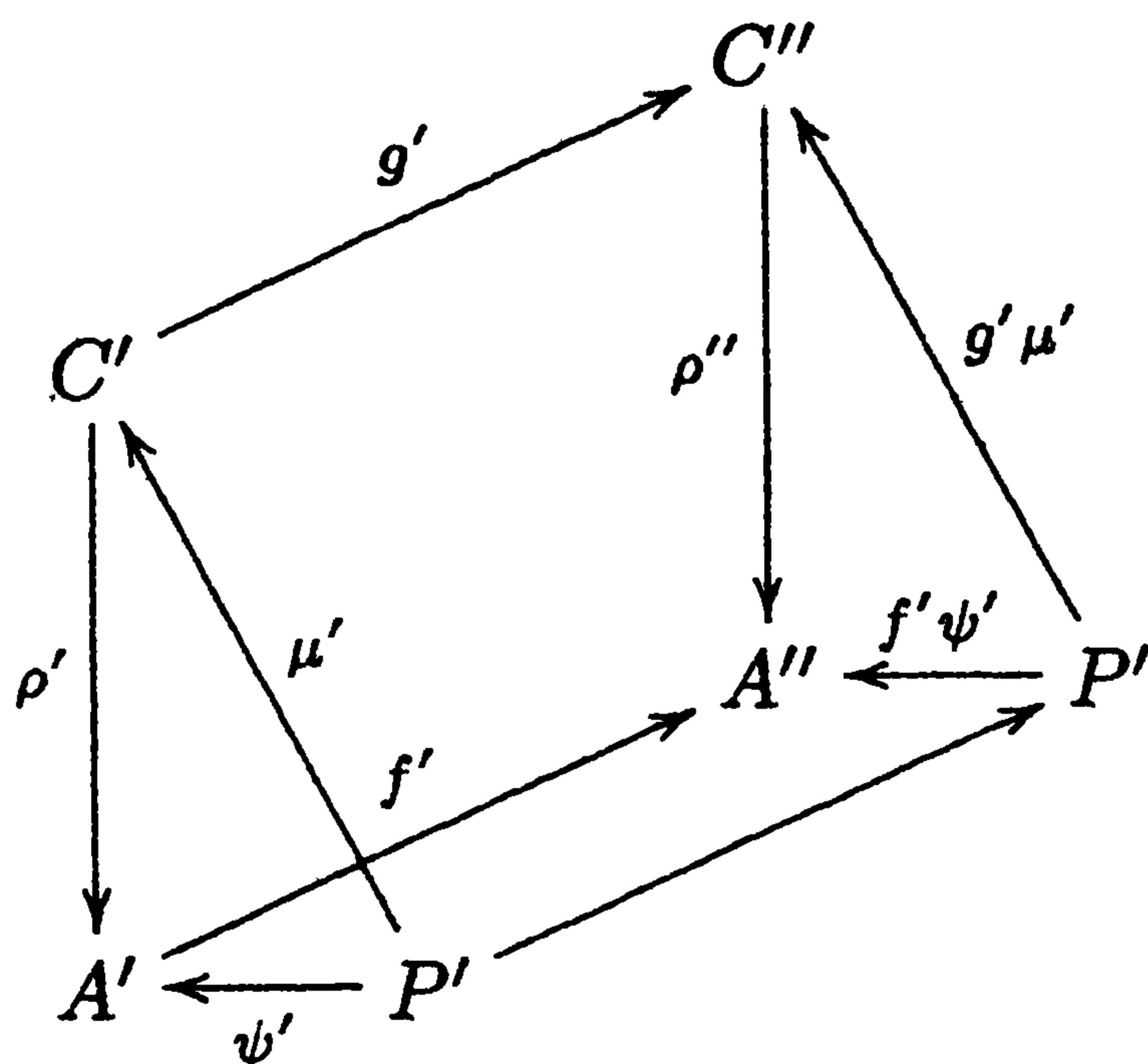

combined with any filler for

$$\begin{array}{ccc}
 & C'' & \\
 & \downarrow \rho'' & \nearrow \\
 & A'' & \longleftarrow P''
 \end{array}$$

This will make the far wedge (and, by symmetry, the near one as well) commute.  $\square$

Proposition 7.29 is both helpful and a disappointment. It does produce plenty of projectives, but the hoped for doesn't fall out (and isn't even true—see Exercise 20), that  $P \rightarrow Q$  would be projective when  $P$  and  $Q$  were projective. Nevertheless, our “plenty” is sufficient.

**Proposition 7.31** *Suppose  $\mathbf{A}$  is a pre-Abelian category.*

- If  $\mathbf{A}$  has enough projectives, then so does  $\mathbf{A}(\rightarrow)$ .*
- If  $\mathbf{A}$  has a separating class of projectives, then so does  $\mathbf{A}(\rightarrow)$ .*
- If  $\mathbf{A}$  has a separating set of projectives, then so does  $\mathbf{A}(\rightarrow)$ .*
- If  $\mathbf{A}$  has a projective separator, then so does  $\mathbf{A}(\rightarrow)$ .*

**Proof:** For starters, suppose  $P \xrightarrow{h} P \oplus P' \xleftarrow{l} P'$  is a coproduct, and  $\pi' : P' \rightarrow A'$  and  $\varphi : A' \rightarrow D$  satisfy  $\varphi\pi' \neq 0$ . Suppose  $\rho : P \rightarrow A'$  is any morphism, and form a filler  $\theta$  using the coproduct construction:

$$\begin{array}{ccccc}
 P & & \xrightarrow{\rho} & & A' & \xrightarrow{\varphi} & D \\
 h \downarrow & & & \searrow \theta & & & \\
 P \oplus P' & & \xrightarrow{\theta} & & A' & & \\
 l \uparrow & & & \nearrow \pi' & & & \\
 P' & & & & & & 
 \end{array}$$

In this,  $0 \neq \varphi\pi' = \varphi\theta l$ , so  $\varphi\theta \neq 0$ , too. In particular, if  $\pi'$  is epic, then (letting  $\varphi$  float among all nonzero morphisms)  $\theta$  is also epic.

To use this in proving (a), let  $f : A \rightarrow A'$  be given in  $\mathbf{A}(\rightarrow)$ , and suppose  $\pi : P \rightarrow A$  is epic, while  $\pi' : P' \rightarrow A'$  is epic, with  $P$  and  $P'$  projective. Then (setting  $\rho = f\pi$ )

$$\begin{array}{ccc}
 P & \xrightarrow{\pi} & A \\
 h \downarrow & & \downarrow f \\
 P \oplus P' & \xrightarrow{\theta} & A'
 \end{array}$$

is (horizontally) epic in  $\mathbf{A}(\rightarrow)$ .

To use this in proving (b), (c), and (d), let  $\mathcal{P}$  be a separating class of projectives. Given a nonzero morphism  $(\varphi, \varphi')$  in  $\mathbf{A}(\rightarrow)$ :

$$\begin{array}{ccc} A & \xrightarrow{\varphi} & B \\ \downarrow f & & \downarrow g \\ A' & \xrightarrow{\varphi'} & B' \end{array}$$

choose  $P, P' \in \mathcal{P}$  and  $\pi : P \rightarrow A$ ,  $\pi' : P' \rightarrow A'$  such that either  $\varphi\pi \neq 0$  or  $\varphi'\pi' \neq 0$ . Then (again setting  $\rho = f\pi$ ), either  $\varphi\pi \neq 0$  or  $\varphi'\theta \neq 0$ , so the morphism

$$\begin{array}{ccc} P & \xrightarrow{\pi} & A \\ \downarrow h & & \downarrow f \\ P \oplus P' & \xrightarrow{\theta} & A' \end{array}$$

satisfies  $(\varphi, \varphi')(\pi, \theta) \neq (0, 0)$ . This proves (b). Taking  $\mathcal{P}$  to be a set proves (c). Taking  $\mathcal{P}$  to be a singleton proves (d).  $\square$

**Corollary 7.32** *Suppose  $\mathbf{A}$  is a pre-Abelian category.*

- a) *If  $\mathbf{A}$  has enough injectives, then so does  $\mathbf{A}(\rightarrow)$ .*
- b) *If  $\mathbf{A}$  has a coseparating class of injectives, then so does  $\mathbf{A}(\rightarrow)$ .*
- c) *If  $\mathbf{A}$  has a coseparating set of injectives, then so does  $\mathbf{A}(\rightarrow)$ .*
- d) *If  $\mathbf{A}$  has an injective coseparator, then so does  $\mathbf{A}(\rightarrow)$ .*

**Proof:** Quote Proposition 7.31 in  $\mathbf{A}(\rightarrow)^{\text{op}} \approx (\mathbf{A}^{\text{op}})(\rightarrow)$ . (Proposition 7.22).  $\square$

There are two more things before leaving the subject. First of all, arrow categories are particular examples of *functor categories*. If  $\mathbf{C}_0$  is a small category and  $\mathbf{C}$  is any category, one may define a functor category  $[\mathbf{C}_0, \mathbf{C}]$  whose objects are covariant functors from  $\mathbf{C}_0$  to  $\mathbf{C}$  and whose morphisms are natural transformations.  $\mathbf{C}(\rightarrow)$  is obtained by taking  $\mathbf{C}_0$  so that

$$\begin{aligned} \text{obj } \mathbf{C}_0 &= \{0, 1\} \\ \text{Mor}(0, 0) &= \{i_0\} \\ \text{Mor}(1, 1) &= \{i_1\} \\ \text{Mor}(0, 1) &= \{z\} \\ \text{Mor}(1, 0) &= \emptyset. \end{aligned}$$



A triple  $(A, f, A')$  corresponds to the functor

$$\begin{aligned} 0 &\mapsto A \\ 1 &\mapsto A' \\ i_0 &\mapsto i_A \\ i_1 &\mapsto i_{A'} \\ z &\mapsto f. \end{aligned}$$

The pair  $(\varphi, \varphi')$  corresponds to the natural transformation  $\sigma$ , where

$$\begin{aligned} \sigma_0 &= \varphi \\ \sigma_1 &= \varphi'. \end{aligned}$$

Naturality of this translates to the required commutative square. Details are left to the interested reader.

Finally, dropping the Roman letter-Greek letter convention,  $\mathbf{A}(\rightarrow)$  concepts can be applied to horizontal arrows as well. For example, the diagram of Proposition 7.23 can now be interpreted as asserting that the “map” which sends  $(A, \varphi, B)$  to  $(K, \iota, A)$  is a covariant functor from  $\mathbf{A}(\rightarrow)$  to itself. As usual, we must choose (using the Zermello hierarchy and the axiom of choice in the same way that projectives are chosen in a pre-Abelian category with enough projectives) a particular kernel  $\iota : K \rightarrow A$  for each  $\varphi : A \rightarrow B$ ; write  $\text{Ker}((A, \varphi, B))$  for this particular kernel. Then  $\text{Ker}$  yields a covariant functor from  $\mathbf{A}(\rightarrow)$  to itself. One may similarly define a cokernel functor  $\text{Coker}$ . These provide the “functorial interpretation” of the kernel and cokernel arrows on the first two pages of Section 7.3; there is more on this in Section 7.7.

## 7.6 Homology in Abelian Categories

The domain category for homological algebra has already been broadened to include any pre-Abelian category with, for example, enough projectives. Preferably such a category will satisfy Ab-epic, so that, for example,  $\text{Ext}^0 \approx \text{Hom}$ . (One can often produce a variant with this property even if Ab-epic is not satisfied; this is discussed in Section 7.8.) When working with projectives, Ab-monic recedes into the background. In generalizing the range category, however, we shall have to be more particular.

There is a lot to do in this section, so as in Section 4.3 we will have several lemmas. There is an underlying theme which should be kept in mind: Define homology for a complex in an arbitrary Abelian category, and prove the basic results one expects to need in order to exploit this definition, for example, 4-lemmas and the 5-lemma (long exact sequences will be the subject of the next section). We start with an analog of Exercise 14(a) of Chapter 2 for pre-Abelian categories.

**Lemma 7.33** *Suppose  $\mathbf{A}$  is pre-Abelian, and suppose*

$$\begin{array}{ccccc} K & \xrightarrow{j} & B & \xrightarrow{g} & C \\ \downarrow \varphi & & \downarrow \psi & & \downarrow \eta \\ A' & \xrightarrow{f'} & B' & \xrightarrow{g'} & C' \end{array}$$

*is a commutative diagram in  $\mathbf{A}$  with*

- i)  $j : K \rightarrow B$  a kernel for  $g : B \rightarrow C$ ,*
- ii)  $f'$  monic, and*
- iii)  $\varphi$  and  $\eta$  monic.*

*Then  $\psi$  is monic.*

**Proof:** Let  $l : L \rightarrow B$  denote a kernel for  $\psi : B \rightarrow B'$ ; we shall show that  $l = 0$ , which will imply that  $L = 0$  and  $\psi$  is monic. The relevant diagram is

$$\begin{array}{ccccc} & & L & & \\ & & \downarrow l & & \\ K & \xrightarrow{j} & B & \xrightarrow{g} & C \\ \downarrow \varphi & & \downarrow \psi & & \downarrow \eta \\ A' & \xrightarrow{f'} & B' & \xrightarrow{g'} & C' \end{array}$$

Now  $\psi l = 0 \Rightarrow 0 = g' \psi l = \eta g l \Rightarrow g l = 0$  since  $\eta$  is monic. Hence,  $l$  factors through  $K$ , since  $j : K \rightarrow B$  is a kernel for  $g : B \rightarrow C$ :

$$\begin{array}{ccccc} & & L & & \\ & \swarrow \tau & \downarrow l & & \\ K & \xrightarrow{j} & B & \xrightarrow{g} & C \\ \downarrow \varphi & & \downarrow \psi & & \downarrow \eta \\ A' & \xrightarrow{f'} & B' & \xrightarrow{g'} & C' \end{array}$$

But now  $l = j\tau \Rightarrow 0 = \psi l = \psi j\tau = f'\varphi\tau \Rightarrow \varphi\tau = 0$ , since  $f'$  is monic  $\Rightarrow \tau = 0$ , since  $\varphi$  is monic. Hence,  $l = j\tau = 0$ .  $\square$

Note that we did not need projectives for the above factorization like we did for Proposition 7.19. This is because  $K \rightarrow B$  actually is the kernel of

$B \rightarrow C$ , rather than just having  $K \rightarrow B \rightarrow C$  kernel-exact. This suggests, correctly, that the key to results like the 5-lemma for Abelian categories lies in breaking up exact sequences into short exact pieces. There is more involved, but that's the key.

Before continuing, we record the main consequence, stated for Abelian categories. It is sometimes called the "short 5-lemma."

**Proposition 7.34** *Suppose  $\mathbf{A}$  is an Abelian category, and suppose*

$$\begin{array}{ccccccccc} 0 & \longrightarrow & A & \xrightarrow{j} & B & \xrightarrow{\pi} & C & \longrightarrow & 0 \\ & & \downarrow \varphi & & \downarrow \psi & & \downarrow \eta & & \\ 0 & \longrightarrow & A' & \xrightarrow{j'} & B' & \xrightarrow{\pi'} & C' & \longrightarrow & 0 \end{array}$$

*commutes and has exact rows in  $\mathbf{A}$ . Then*

- a) *If  $\varphi$  and  $\eta$  are monic, then so is  $\psi$ .*
- b) *If  $\varphi$  and  $\eta$  are epic, then so is  $\psi$ .*
- c) *If  $\varphi$  and  $\eta$  are isomorphisms, then so is  $\psi$ .*

**Proof:** For (a), note that Lemma 7.33 applies. (Proposition 7.12(iii) guarantees that  $A \rightarrow B$  is the kernel of  $B \rightarrow C$ .) For (b), apply (a) to  $\mathbf{A}^{\text{op}}$ . For (c), use (a) and (b) together with the fact that  $\mathbf{A}$  is balanced (Proposition 7.11(a)).  $\square$

Situations like the one in Proposition 7.34 sometimes reverse; that is, a condition on the middle term of a short exact sequence is equivalent to simultaneous occurrence on the ends. (The Noetherian condition in  ${}_R\mathbf{M}$  comes to mind.) That happens partly here: If  $\psi$  is monic, then so is  $\varphi$ ; and if  $\psi$  is epic, then so is  $\eta$ . To see this, just examine

$$\begin{array}{ccc} A & \xrightarrow{j} & B \\ \downarrow \varphi & & \downarrow \psi \\ A' & \xrightarrow{j'} & B' \end{array}$$

in which  $j$  and  $j'$  are already monic; if  $\psi$  is monic, then  $\psi j = j' \varphi$  is monic, so that  $\varphi$  is monic.  $\psi$  epic  $\Rightarrow \eta$  epic is just as immediate. This, however, is as far as it goes for conditions on  $\psi$  alone, as

$$\begin{array}{ccccccccc} 0 & \longrightarrow & 0 & \longrightarrow & B & \longrightarrow & B & \longrightarrow & 0 \\ & & \downarrow & & \parallel & & \downarrow & & \\ 0 & \longrightarrow & B & \longrightarrow & B & \longrightarrow & 0 & \longrightarrow & 0 \end{array}$$

shows rather graphically. To do more, we need some more preparation.

**Lemma 7.35** *Suppose  $A$  is pre-Abelian,  $j : K \rightarrow A$  and  $f : A \rightarrow B$  are monic, and  $\varphi \in \text{Hom}(B, C)$ , producing*

$$K \xrightarrow{j} A \xrightarrow{f} B \xrightarrow{\varphi} C.$$

*Suppose  $fj$  is a kernel for  $\varphi$ . Then  $j$  is a kernel for  $\varphi f$ .*

**Proof:** We show  $j$  has the required universal property. Suppose  $g : D \rightarrow A$  has the property that  $(\varphi f)g = 0$ . Then  $\varphi(fg) = 0$ , so  $fg$  factors through  $K$

$$\begin{array}{ccc} K & \xrightarrow{fj} & B & \xrightarrow{\varphi} & C \\ & \swarrow \psi & \nearrow fg & & \\ & & D & & \end{array}$$

via some morphism  $\psi$ . Thus  $fj\psi = fg \Rightarrow j\psi = g$  since  $f$  is monic, and

$$\begin{array}{ccc} K & \xrightarrow{j} & A & \xrightarrow{\varphi f} & C \\ & \swarrow \psi & \nearrow g & & \\ & & D & & \end{array}$$

commutes. Finally,  $\psi$  is unique since  $j$  is monic. □

The next bit of preparation is interesting in its own right. When asked to prove that a morphism is monic, the nerve is hit and the knee jerks: "Show that the kernel is 0." While often appropriate, this is sometimes useless. The following result may get one past such difficult straits.

**Proposition 7.36** *Suppose  $A$  is an Abelian category,  $\pi : A \rightarrow B$  is epic, and  $\varphi \in \text{Hom}(B, C)$ . If  $\pi$  and  $\varphi\pi$  have the same kernel(s), then  $\varphi$  is monic.*

**Proof:** Suppose first that  $\varphi$  is epic. Let  $j : K \rightarrow A$  denote a kernel for both  $\pi$  and  $\varphi\pi$ . Then  $\pi$  and  $\varphi\pi$  are both cokernels for  $j$  by part (iv) of Corollary 7.13. Hence, there is an isomorphism  $\psi : B \rightarrow C$  such that

$$\begin{array}{ccc} & & B \\ & \nearrow \pi & \downarrow \psi \\ K & \xrightarrow{j} & A \\ & \searrow \varphi\pi & \downarrow \\ & & C \end{array}$$

commutes, by uniqueness of cokernels. But  $\varphi\pi = \psi\pi \Rightarrow \varphi = \psi$ , since  $\pi$  is epic, so  $\varphi$  is an isomorphism.

For general  $\varphi$ , write  $\varphi = fp$  according to Proposition 7.11(b), where  $f$  is monic and  $p$  is epic. Then kernels of  $\varphi\pi = fp\pi$  coincide with kernels of  $p\pi$  since  $f$  is monic, so the first part of the proof applies (with  $p$  replacing  $\varphi$ ). Thus,  $p$  is an isomorphism, and  $\varphi = fp$  is monic.  $\square$

One major consequence of all this is a reversed variation on the short 5-lemma.

**Proposition 7.37** *Suppose  $\mathbf{A}$  is an Abelian category, and suppose*

$$\begin{array}{ccccccccc} 0 & \longrightarrow & A & \xrightarrow{j} & B & \xrightarrow{\pi} & C & \longrightarrow & 0 \\ & & \parallel & & \downarrow \psi & & \downarrow \eta & & \\ 0 & \longrightarrow & A & \xrightarrow{j'} & B' & \xrightarrow{\pi'} & C' & \longrightarrow & 0 \end{array}$$

*commutes and has exact rows in  $\mathbf{A}$ . Then  $\psi$  monic  $\Rightarrow \eta$  monic.*

**Proof:** Assume  $\psi$  is monic. Note that  $j : A \rightarrow B$  is a kernel for  $\pi : B \rightarrow C$  by Proposition 7.12(iii), and likewise  $\psi j = j'$  is a kernel for  $\pi'$ . By Lemma 7.35,  $j$  is a kernel for  $\pi'\psi = \eta\pi$ . Thus,  $j : A \rightarrow B$  is a kernel for both  $\eta\pi$  and  $\pi$ , so  $\eta$  is monic by Proposition 7.36.  $\square$

**Corollary 7.38** *Suppose  $\mathbf{A}$  is an Abelian category, and suppose*

$$\begin{array}{ccccccccc} 0 & \longrightarrow & A & \xrightarrow{j} & B & \xrightarrow{\pi} & C & \longrightarrow & 0 \\ & & \downarrow \varphi & & \downarrow \psi & & \parallel & & \\ 0 & \longrightarrow & A' & \xrightarrow{j'} & B' & \xrightarrow{\pi'} & C & \longrightarrow & 0 \end{array}$$

*commutes and has exact rows in  $\mathbf{A}$ . Then  $\psi$  epic  $\Rightarrow \varphi$  epic.*

**Proof:** Apply Proposition 7.37 to  $\mathbf{A}^{\text{op}}$ .  $\square$

To go further, we need images. Suppose  $f : A \rightarrow B$  is a morphism in an Abelian category. Then by Proposition 7.11(b),  $f$  can be factored  $f = jp$ , where  $p \in \text{Hom}(A, I)$  and  $j \in \text{Hom}(I, B)$ , with  $j$  epic and  $p$  monic:

$$A \xrightarrow{p} I \xrightarrow{j} B \quad f = jp.$$

Furthermore, this factorization is unique up to isomorphism of  $I$  (Exercise 10), and  $I$  is a kernel of a cokernel of  $f$  by the proof of Proposition 7.11(b).



$I$  is called the *image* of  $f$ ; more properly,  $j : I \rightarrow B$  is the image of  $f$  (and  $p : A \rightarrow I$  is the *coimage*).

Suppose we have a commutative square

$$\begin{array}{ccc} A & \xrightarrow{f} & B \\ \downarrow \varphi & & \downarrow \psi \\ A' & \xrightarrow{f'} & B' \end{array}$$

in our Abelian category. Let  $\kappa : K \rightarrow A$  denote a kernel for  $f$ , and  $\kappa' : K' \rightarrow A'$  a kernel for  $f'$ . Similarly, let  $\pi : B \rightarrow D$  be a cokernel for  $f$ , and  $\pi' : B' \rightarrow D'$  a cokernel for  $f'$ . We get a commutative rectangle:

$$\begin{array}{ccccccc} K & \xrightarrow{\kappa} & A & \xrightarrow{f} & B & \xrightarrow{\pi} & D \\ \tau \downarrow & & \downarrow \varphi & & \downarrow \psi & & \downarrow \eta \\ K' & \xrightarrow{\kappa'} & A' & \xrightarrow{f'} & B' & \xrightarrow{\pi'} & D' \end{array}$$

Taking kernels of  $\pi$  and  $\pi'$  in the righthand rectangle, we get (in obvious notation)

$$\begin{array}{ccccccccc} K & \xrightarrow{\kappa} & A & \xrightarrow{p} & I & \xrightarrow{j} & B & \xrightarrow{\pi} & D \\ \tau \downarrow & & \downarrow \varphi & & \downarrow \theta & & \downarrow \psi & & \downarrow \eta \\ K' & \xrightarrow{\kappa'} & A' & \xrightarrow{p'} & I' & \xrightarrow{j'} & B' & \xrightarrow{\pi'} & D' \end{array}$$

Note that, by construction,  $\psi j = j' \theta$ , so that  $j' p' \varphi = f' \varphi = \psi f = \psi j p = j' \theta p$ ; hence,  $p' \varphi = \theta p$ , since  $j'$  is monic. It follows that this diagram is commutative.

The next result is almost an observation, but it is a major producer of isomorphic entries in the situation of Proposition 7.37 and its corollary.

**Lemma 7.39** *Suppose  $\mathbf{A}$  is Abelian, and*

$$\begin{array}{ccc} A & \xrightarrow{f} & B \\ \downarrow \varphi & & \downarrow \psi \\ A' & \xrightarrow{f'} & B' \end{array}$$

*is a commutative square in  $\mathbf{A}$  with  $\varphi$  epic and  $\psi$  monic. Then  $f$  and  $f'$  have isomorphic images.*

**Proof:** Consider

$$\begin{array}{ccccc} A & \xrightarrow{p} & I & \xrightarrow{j} & B \\ \downarrow \varphi & & \downarrow \theta & & \downarrow \psi \\ A' & \xrightarrow{p'} & I' & \xrightarrow{j'} & B' \end{array}$$

In the righthand square,  $j$ ,  $j'$ , and  $\psi$  are all monic, so  $\theta$  is monic by the discussion following Proposition 7.35. Similarly, consideration of the lefthand square shows that  $\theta$  is epic. Hence,  $\theta$  is an isomorphism since  $\mathbf{A}$  is balanced (Proposition 7.11(a)).  $\square$

The relationship between exactness and images is just what one expects.

**Lemma 7.40** *In an Abelian category,*

$$A \xrightarrow{f} B \xrightarrow{g} C$$

*is exact if and only if “the” image of  $f$  coincides with “the” kernel of  $g$ .*

**Proof:** Suppose  $j : K \rightarrow B$  is a kernel for  $g$ , and suppose it is also an image for  $f$ . Then by definition of image, the  $A \rightarrow K$  part is epic. (The proof of Proposition 7.11(b) is used in making the definition.) Conversely, if  $A \rightarrow B \rightarrow C$  is exact, again let  $j : K \rightarrow B$  be a kernel for  $g$ , and  $p : A \rightarrow K$  satisfy  $jp = f$ . By definition of (kernel-) exactness,  $p$  is epic. Hence,  $f = jp$  is a factorization of  $f$  as a monomorphism following an epimorphism. Since this is unique (Exercise 10), the intermediate object  $K$  must be the image of  $f$ .  $\square$

**Corollary 7.41** *In an Abelian category,*

$$A \xrightarrow{f} B \xrightarrow{g} C$$

*is exact if and only if “the” cokernel of  $f$  coincides with “the” coimage of  $g$ .*

**Proof:** Apply Lemma 7.40 to  $\mathbf{A}^{\text{op}}$ .  $\square$

This corollary should give us pause. The conditions in the corollary and lemma suggest that homology will have two definitions that will have to be proven isomorphic. This is indeed the case. Before opening that can of worms, we now have all we need for the 4-lemma and 5-lemma, and it seems best to get that out of the way.

**Lemma 7.42 (Monic 4-Lemma)** *Suppose  $\mathbf{A}$  is an Abelian category, and suppose*

$$\begin{array}{ccccccc} A_1 & \xrightarrow{f_1} & A_2 & \xrightarrow{f_2} & A_3 & \xrightarrow{f_3} & A_4 \\ \downarrow \varphi_1 & & \downarrow \varphi_2 & & \downarrow \varphi_3 & & \downarrow \varphi_4 \\ B_1 & \xrightarrow{g_1} & B_2 & \xrightarrow{g_2} & B_3 & \xrightarrow{g_3} & B_4 \end{array}$$

*is commutative in  $\mathbf{A}$  with exact rows. Assume  $\varphi_1$  is epic, while  $\varphi_2$  and  $\varphi_4$  are monic. Then  $\varphi_3$  is monic.*

**Proof:** Let  $K_j = \text{kernel of } f_{j+1} \approx \text{image of } f_j$  (Lemma 7.40), and  $K'_j = \text{kernel of } g_{j+1}$ . Note that by Lemma 7.39,  $K_1 \approx K'_1$ , so we have a diagram

$$\begin{array}{ccccccccc} 0 & \longrightarrow & K_1 & \longrightarrow & A_2 & \longrightarrow & K_2 & \longrightarrow & 0 \\ & & \parallel & & \downarrow \varphi_2 & & \downarrow \psi & & \\ 0 & \longrightarrow & K_1 & \longrightarrow & B_2 & \longrightarrow & K'_2 & \longrightarrow & 0 \end{array}$$

with short exact rows (since  $K_2 \approx \text{image } f_2$ , and  $K'_2 \approx \text{image of } g_2$ ). Since  $\varphi_2$  is monic,  $\psi$  is also monic by Proposition 7.37. Finally, we now have

$$\begin{array}{ccccccc} 0 & \longrightarrow & K_2 & \longrightarrow & A_3 & \xrightarrow{f_3} & A_4 \\ & & \downarrow \psi & & \downarrow \varphi_3 & & \downarrow \varphi_4 \\ 0 & \longrightarrow & K'_2 & \longrightarrow & A_3 & \xrightarrow{g_3} & A_4 \end{array}$$

with exact rows, in which the hypotheses of Lemma 7.33 are satisfied. Hence,  $\varphi_3$  is monic.  $\square$

**Corollary 7.43 (Epic 4-Lemma)** *Suppose  $\mathbf{A}$  is an Abelian category, and suppose*

$$\begin{array}{ccccccc} A_1 & \xrightarrow{f_1} & A_2 & \xrightarrow{f_2} & A_3 & \xrightarrow{f_3} & A_4 \\ \downarrow \varphi_1 & & \downarrow \varphi_2 & & \downarrow \varphi_3 & & \downarrow \varphi_4 \\ B_1 & \xrightarrow{g_1} & B_2 & \xrightarrow{g_2} & B_3 & \xrightarrow{g_3} & B_4 \end{array}$$

*is commutative in  $\mathbf{A}$  with exact rows. Assume  $\varphi_4$  is monic, while  $\varphi_1$  and  $\varphi_3$  are epic. Then  $\varphi_2$  is epic.*

**Proof:** Apply Lemma 7.42 to  $\mathbf{A}^{\text{op}}$ .  $\square$

**Remark:** Both versions can be combined to say: If  $\varphi_1$  is epic and  $\varphi_4$  is monic, then  $\varphi_2$  monic  $\Rightarrow \varphi_3$  monic, and  $\varphi_3$  epic  $\Rightarrow \varphi_2$  epic.

**Proposition 7.44 (5-Lemma for Abelian categories)** *Suppose  $\mathbf{A}$  is an Abelian category, suppose*

$$\begin{array}{ccccccccc} A_1 & \xrightarrow{f_1} & A_2 & \xrightarrow{f_2} & A_3 & \xrightarrow{f_3} & A_4 & \xrightarrow{f_4} & A_5 \\ \downarrow \varphi_1 & & \downarrow \varphi_2 & & \downarrow \varphi_3 & & \downarrow \varphi_4 & & \downarrow \varphi_5 \\ B_1 & \xrightarrow{g_1} & B_2 & \xrightarrow{g_2} & B_3 & \xrightarrow{g_3} & B_4 & \xrightarrow{g_4} & B_5 \end{array}$$

*is commutative in  $\mathbf{A}$  with exact rows, and suppose*

- i)  $\varphi_2$  and  $\varphi_4$  are isomorphisms,*
- ii)  $\varphi_1$  is epic, and*
- iii)  $\varphi_5$  is monic.*

*Then  $\varphi_3$  is an isomorphism.*

**Proof:**  $\varphi_3$  is monic by Lemma 7.42, and epic by Corollary 7.43, so  $\varphi_3$  is an isomorphism, since  $\mathbf{A}$  is balanced (Proposition 7.11(a)).  $\square$

We now tackle the two possible definitions for the homology of

$$A \xrightarrow{f} B \xrightarrow{g} C$$

when  $gf = 0$ . Let  $j : K \rightarrow B$  denote a kernel for  $g$ , and  $\pi : B \rightarrow D$  a cokernel for  $f$ .

We have factorizations:

$$A \xrightarrow{\bar{f}} K \xrightarrow{j} B \xrightarrow{\pi} D \xrightarrow{\bar{g}} C$$

$$j\bar{f} = f \qquad \bar{g}\pi = g.$$

Let  $p : K \rightarrow H$  denote a cokernel for  $\bar{f}$ , and  $\kappa : \bar{H} \rightarrow D$  a kernel for  $\bar{g}$ ;  $H$  and  $\bar{H}$  will be our two definitions of “homology.” First note that in any pre-Abelian category,  $H = 0 \Leftrightarrow A \rightarrow B \rightarrow C$  is kernel-exact, while  $\bar{H} = 0 \Leftrightarrow A \rightarrow B \rightarrow C$  is cokernel-exact.<sup>3</sup> Since these concepts coincide in an Abelian category (i.e.,  $H = 0 \Leftrightarrow \bar{H} = 0$ ), it should come as no surprise that  $H \approx \bar{H}$ .

<sup>3</sup>What we call “kernel-exact” is often called “exact”, while what we call “cokernel-exact” is often called “coexact”. Our terminology is used partly to keep the two notions on an equal footing, and partly to avoid having to now call  $H$  “homology” and  $\bar{H}$  “cohomology” for the sake of notational consistency. This is definitely *not* what the “co” in “cohomology” refers to in general.

To expand further, let  $I$  denote an image for  $f$ , so that  $f$  factors

$$A \xrightarrow{\rho} I \xrightarrow{k} B.$$

Now  $gf = 0 \Rightarrow gk\rho = 0 \Rightarrow gk = 0$  since  $\rho$  is epic. Hence,  $k$  factors through  $K$ , giving

$$A \xrightarrow{\rho} I \xrightarrow{\varphi} K \xrightarrow{j} B$$

$$f = j\varphi\rho.$$

Now  $j\bar{f} = f = j\varphi\rho$ , so  $\bar{f} = \varphi\rho$ , since  $j$  is monic. Furthermore,  $j\varphi = k$  is monic, so  $\varphi$  is monic. Hence,  $\bar{f} = \varphi\rho$  is the monic-after-epic factorization of  $\bar{f}$ , so that  $I$  (or rather,  $\varphi : I \rightarrow K$ ) is the image of  $\bar{f}$ . Now  $p : K \rightarrow H$  is a cokernel for  $\bar{f} = \varphi\rho$ , hence is a cokernel for  $\varphi$  since  $\rho$  is epic (Proposition 7.5(c)). Thus the definition of  $H$  coincides with the usual definition of homology in  $\mathcal{R}\mathbf{M}$  as the cokernel of  $\text{im } f \rightarrow \ker g$ .

**Theorem 7.45** Suppose  $\mathbf{A}$  is an Abelian category in which  $f : A \rightarrow B$  and  $g : B \rightarrow C$  satisfy  $gf = 0$ . Let  $j : K \rightarrow B$  denote a kernel for  $g$ , and  $\pi : B \rightarrow D$  a cokernel for  $f$ . Let

$$\begin{array}{ccccc} A & \xrightarrow{f} & B & \xrightarrow{g} & C \\ & \searrow \bar{f} & \nearrow j & \searrow \pi & \nearrow \bar{g} \\ & & K & & D \\ & & \downarrow p & & \uparrow \kappa \\ & & H & \xrightarrow{\tau} & \bar{H} \end{array}$$

denote the resulting factorization, with  $p : K \rightarrow H$  a cokernel for  $\bar{f}$  and  $\kappa : \bar{H} \rightarrow D$  a kernel for  $\bar{g}$ . Then the induced  $\tau$  is an isomorphism.

**Proof:** A construction similar to the one preceding the theorem (actually the same in  $\mathbf{A}^{\text{op}}$ ) yields a diagram

$$\begin{array}{ccccc} A & \xrightarrow{f} & B & \xrightarrow{g} & C \\ & \searrow \rho & \nearrow j & \searrow \pi & \nearrow k \\ & & I & \xrightarrow{\varphi} & K \\ & & \downarrow p & & \uparrow \kappa \\ & & H & & \bar{H} \end{array}$$



where  $p : K \rightarrow H$  is a cokernel for  $\varphi\rho$  and for  $\varphi$ , and  $\kappa : \overline{H} \rightarrow D$  is a kernel for  $k\psi$  and for  $\psi$ . Using this, we may delete  $f$  and  $g$  to get

$$\begin{array}{ccccccc} I & \xrightarrow{\varphi} & K & \xrightarrow{j} & B & \xrightarrow{\pi} & D \xrightarrow{\psi} J \\ & & \downarrow p & & & & \uparrow \kappa \\ & & H & & & & \overline{H} \end{array}$$

This diagram contains enough information to produce the isomorphism  $\tau$  of  $H$  with  $\overline{H}$ .

To start in this direction, note that we have the following:

$$\begin{aligned} \pi &= \text{coker } f = \text{coker}(j\varphi\rho) = \text{coker}(j\varphi) \text{ so that } j\varphi = \ker \pi, \\ j &= \ker g = \ker(k\psi\pi) = \ker(\psi\pi) \text{ so that } \psi\pi = \text{coker}(j), \\ p &= \text{coker } \varphi, \text{ and} \\ \kappa &= \ker \psi. \end{aligned}$$

Now  $\pi j\varphi = 0 \Rightarrow \pi j$  factors through  $\text{coker } \varphi$ , that is, through  $H$ :

$$\begin{array}{ccccccc} I & \xrightarrow{\varphi} & K & \xrightarrow{j} & B & \xrightarrow{\pi} & D \xrightarrow{\psi} J \\ & & \downarrow p & & & & \uparrow \kappa \\ & & H & \xrightarrow{\sigma} & & & \overline{H} \end{array}$$

**Claim:** In the preceding diagram, in an Abelian category,  $\sigma$  is monic.

**Proof of claim:** Twist the diagram to

$$\begin{array}{ccccccc} 0 & \longrightarrow & I & \xrightarrow{\varphi} & K & \xrightarrow{p} & H \longrightarrow 0 \\ & & \parallel & & \downarrow j & & \downarrow \sigma \\ 0 & \longrightarrow & I & \xrightarrow{j\varphi} & B & \xrightarrow{\pi} & D \longrightarrow 0 \end{array}$$

From earlier remarks, the rows are short exact, so that  $\sigma$  is monic by Proposition 7.37. End of proof of claim.

Continuing, note that  $0 = \psi\pi j = \psi\sigma p$ , so that  $\psi\sigma = 0$ , since  $p$  is epic. Hence,  $\sigma$  factors through  $\overline{H} = \ker \psi$ :

$$\begin{array}{ccccccc} I & \xrightarrow{\varphi} & K & \xrightarrow{j} & B & \xrightarrow{\pi} & D \xrightarrow{\psi} J \\ & & \downarrow p & & & & \uparrow \kappa \\ & & H & \xrightarrow{\sigma} & & & \overline{H} \\ & & & \dashrightarrow \tau \dashrightarrow & & & \end{array}$$

Now  $\sigma = \kappa\tau$  is monic, so  $\tau$  is monic. Similarly, looking in  $\mathbf{A}^{\text{op}}$ ,  $\tau p$  (which corresponds to  $\sigma$ ) is epic, so  $\tau$  is epic. That is,  $\tau$  is a bimorphism, hence is an isomorphism (Abelian categories are balanced).  $\square$

We can now be explicit about what we mean when we form the derived functor of, for example, an additive covariant functor  $F : \mathbf{A} \rightarrow \mathbf{B}$ , where  $\mathbf{B}$  is Abelian and  $\mathbf{A}$  is pre-Abelian (and preferably balanced) and has, for example, enough projectives. Take an object  $A$  in  $\mathbf{A}$ , and choose a projective resolution of  $A$  in  $\mathbf{A}$ :

$$\cdots \longrightarrow P_2 \longrightarrow P_1 \longrightarrow P_0 \longrightarrow A \longrightarrow 0.$$

Apply  $F$  and delete  $F(A)$ , yielding a complex in  $\mathbf{B}$ :

$$\cdots \longrightarrow F(P_2) \longrightarrow F(P_1) \longrightarrow F(P_0) \longrightarrow 0.$$

Take homology (i.e., choose a representative) using either definition from **Theorem 7.45**. The result is independent of the resolution, since homotopies still do in  $\mathbf{B}$  what they did in  ${}_R\mathbf{M}$  (see Exercise 17). The result will be the *left derived functors* of  $F$ ,  $\mathcal{L}_n F$ . (It's *deja vu* all over again!) They are functors, using the fillers in Proposition 7.8, together with the following construction. Suppose

$$\begin{array}{ccccc} A & \xrightarrow{f} & B & \xrightarrow{g} & C \\ \downarrow \varphi & & \downarrow \psi & & \downarrow \theta \\ A' & \xrightarrow{f'} & B' & \xrightarrow{g'} & C' \end{array}$$

is commutative, with  $gf = 0$  and  $g'f' = 0$ . We have, with  $j : K \rightarrow B$  a kernel for  $g$  and  $j' : K' \rightarrow B'$  a kernel for  $g'$ , a diagram

$$\begin{array}{ccccccc} A & \xrightarrow{\bar{f}} & K & \xrightarrow{j} & B & \xrightarrow{g} & C \\ \downarrow \varphi & & \downarrow \alpha & & \downarrow \psi & & \downarrow \theta \\ A' & \xrightarrow{\bar{f}'} & K' & \xrightarrow{j'} & B' & \xrightarrow{g'} & C' \end{array}$$

Taking cokernels of the lefthand square yields the homology map

$$\begin{array}{ccccc} A & \xrightarrow{f'} & K & \longrightarrow & H \\ \downarrow \varphi & & \downarrow \alpha & & \downarrow \psi_* \\ A' & \xrightarrow{\bar{f}'} & K' & \longrightarrow & H' \end{array}$$

The homology map can be defined using  $\bar{H}$  as well. The result is the same, as an examination of **Theorem 7.45** in  $\mathbf{A}(\rightarrow)$  shows rather quickly.

Similarly, one may define  $\mathcal{L}^n F$  if  $F$  is an additive contravariant functor: It is the  $n$ th homology of

$$\cdots \longleftarrow F(P_2) \longleftarrow F(P_1) \longleftarrow F(P_0) \longleftarrow 0$$

Using injective resolutions, one may define the right derived functors, symbolized using  $\mathcal{R}_n$  and  $\mathcal{R}^n$ . If  $\mathbf{A}$  has enough injectives, one may choose for each  $A$  in  $\mathbf{A}$  an injective resolution

$$0 \longrightarrow A \longrightarrow E_0 \longrightarrow E_1 \longrightarrow E_2 \longrightarrow \cdots$$

If  $F$  is covariant, then  $\mathcal{R}_n F$  is the  $n$ th homology of

$$0 \longrightarrow F(E_0) \longrightarrow F(E_1) \longrightarrow F(E_2) \longrightarrow \cdots$$

while if  $F$  is contravariant, then  $\mathcal{R}^n F$  is the  $n$ th homology of

$$0 \longleftarrow F(E_0) \longleftarrow F(E_1) \longleftarrow F(E_2) \longleftarrow \cdots$$

It should be noted that these three cases are covered by the original  $\mathcal{L}_n F$  by replacing  $\mathbf{B}$  with  $\mathbf{B}^{\text{op}}$  (producing  $\mathcal{L}^n F$ ) and/or replacing  $\mathbf{A}$  with  $\mathbf{A}^{\text{op}}$  (producing  $\mathcal{R}_n F$  and  $\mathcal{R}^n F$ ).

At this point we really have all we need to make the definitions, but we lack properties. Looking back at Chapter 6 for left derived functors, for example, what we lack are the analogs of Proposition 6.3 and Theorem 6.6. If, say,  $F$  is covariant, then Proposition 6.3(e) is almost trivial, while Proposition 6.3(a) requires discussion of what it means for a functor to be right exact. This is actually a bit subtle, and we shall return to it in Section 7.8. As for the analog of Theorem 6.6, that is the subject of the next section.

## 7.7 Long Exact Sequences

By far, the most useful gadget in computing homology in general, and derived functors (including Ext and Tor) in particular, are the long exact sequences connecting homology at different levels. Homology in Abelian categories would be barren without them, and the objective of this section is to derive long exact sequences for homology in Abelian categories (with application to derived functors).

The starting point is the ker-coker exact sequence. It is important in its own right, and the more general homology long exact sequence is mostly derived from it. The proofs of these two results are interconnected and a bit convoluted, so a description of how this goes is in order. The ker-coker exact sequence (Proposition 7.47) is proved first, except for the exactness of the

parts of the sequence involving the connecting morphism. A special case is done by hand. Then we move on to the long homology exact sequence (Theorem 7.48), which is proven from the ker-coker exact sequence, which at that point is not completely proven. However, the known special case of the ker-coker exact sequence yields a special case of the long homology exact sequence, from which we finish the proof of the exactness of ker-coker exact sequence. At this point, the proofs of both Proposition 7.47 and Theorem 7.48 are completed. Along the way, we shall be explicit about what is known and what is needed.

Before starting on all this, we need a preliminary result (really a generalization of Proposition 7.37), which will be used twice.

**Proposition 7.46** *Suppose  $\mathbf{A}$  is an Abelian category.*

a) *Given a diagram*

$$\begin{array}{ccccc} A & \xrightarrow{f} & B_1 & \xrightarrow{\pi_1} & D_1 \\ & & \downarrow \varphi & & \downarrow \bar{\varphi} \\ & & B_2 & \xrightarrow{\pi_2} & D_2 \end{array}$$

*in which  $\pi_1$  is a cokernel for  $f$ ,  $\pi_2$  is a cokernel for  $\varphi f$ , and  $\varphi$  is monic, then the induced morphism  $\bar{\varphi}$  is also monic.*

b) *Given a diagram*

$$\begin{array}{ccccc} K_2 & \xrightarrow{j_2} & A_2 & \xrightarrow{f} & B \\ \uparrow \bar{\varphi} & & \uparrow \varphi & & \\ K_1 & \xrightarrow{j_1} & A_1 & & \end{array}$$

*in which  $j_2$  is a kernel for  $f$ ,  $j_1$  is a kernel for  $f\varphi$ , and  $\varphi$  is epic; then the induced morphism  $\bar{\varphi}$  is also epic.*

**Remark:** In, for example, (a),  $\bar{\varphi}$  is induced by the fact that  $(\pi_2\varphi)f = 0 \Rightarrow \pi_2\varphi$  factors (uniquely) through  $D_1$ .

**Proof:** For (a), consider the diagram

$$\begin{array}{ccccccc} A & \xrightarrow{f} & B_1 & \xrightarrow{\pi_1} & D_1 & \longrightarrow & 0 \\ \downarrow i_A & & \downarrow \varphi & & \downarrow \bar{\varphi} & & \downarrow i_0 \\ A & \xrightarrow{\varphi f} & B_2 & \xrightarrow{\pi_2} & D_2 & \longrightarrow & 0 \end{array}$$

$i_A$  is epic, and  $\varphi$  and  $i_0$  are monic, so  $\bar{\varphi}$  is monic by the monic 4-lemma.

(b) follows by applying (a) to  $\mathbf{A}^{\text{op}}$ , or by using the epic 4-lemma in a similar fashion.  $\square$

**Proposition 7.47 (Ker-Coker Exact Sequence)** *Suppose  $\mathbf{A}$  is an Abelian category in which*

$$\begin{array}{ccccccc} & & A_1 & \xrightarrow{\varphi} & A_2 & \xrightarrow{\pi} & A_3 & \longrightarrow & 0 \\ & & \downarrow f_1 & & \downarrow f_2 & & \downarrow f_3 & & \\ 0 & \longrightarrow & B_1 & \xrightarrow{\psi} & B_2 & \xrightarrow{\rho} & B_3 & & \end{array}$$

*is commutative and has exact rows. Extend to include kernels and cokernels of the vertical arrows:*

$$\begin{array}{ccccccc} & & K_1 & \xrightarrow{\bar{\varphi}} & K_2 & \xrightarrow{\bar{\pi}} & K_3 & & \\ & & \downarrow j_1 & & \downarrow j_2 & & \downarrow j_3 & & \\ & & A_1 & \xrightarrow{\varphi} & A_2 & \xrightarrow{\pi} & A_3 & \longrightarrow & 0 \\ & & \downarrow f_1 & & \downarrow f_2 & & \downarrow f_3 & & \\ 0 & \longrightarrow & B_1 & \xrightarrow{\psi} & B_2 & \xrightarrow{\rho} & B_3 & & \\ & & \downarrow q_1 & & \downarrow q_2 & & \downarrow q_3 & & \\ & & D_1 & \xrightarrow{\bar{\psi}} & D_2 & \xrightarrow{\bar{\rho}} & D_3 & & \end{array}$$

*Then this diagram has exact rows. Furthermore, there is a naturally defined  $\delta : K_3 \rightarrow D_1$  such that*

$$K_1 \xrightarrow{\bar{\varphi}} K_2 \xrightarrow{\bar{\pi}} K_3 \xrightarrow{\delta} D_1 \xrightarrow{\bar{\psi}} D_2 \xrightarrow{\bar{\rho}} D_3$$

*is exact. Finally,  $\bar{\varphi}$  is monic if  $\varphi$  is monic, and  $\bar{\rho}$  is epic if  $\rho$  is epic.*

**Remark:** “Naturally defined” for  $\delta$  means here (and everywhere else) that if we have a similarly defined primed diagram, with morphisms between the



two diagrams:

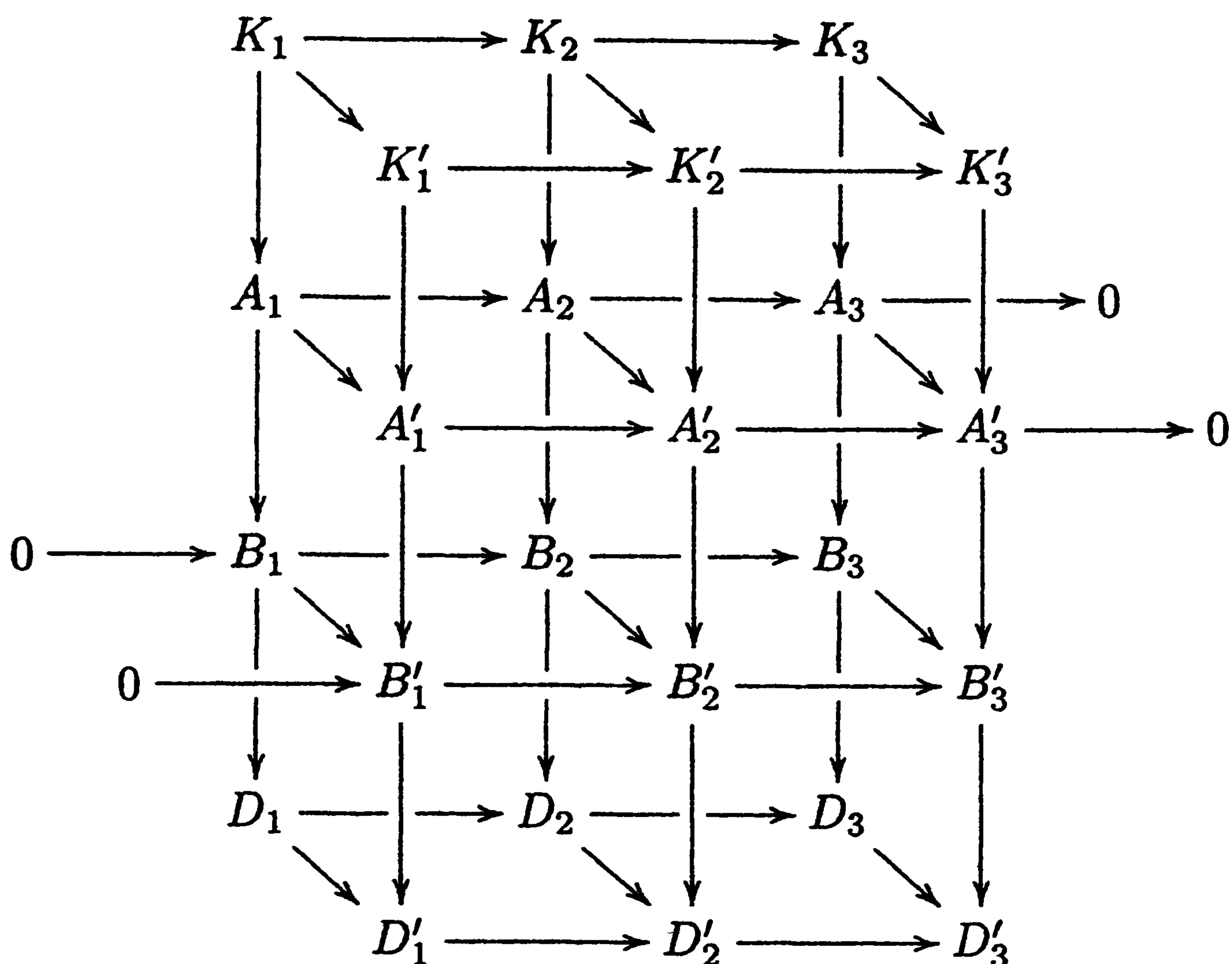

then the resulting diagram involving  $\delta$  and  $\delta'$

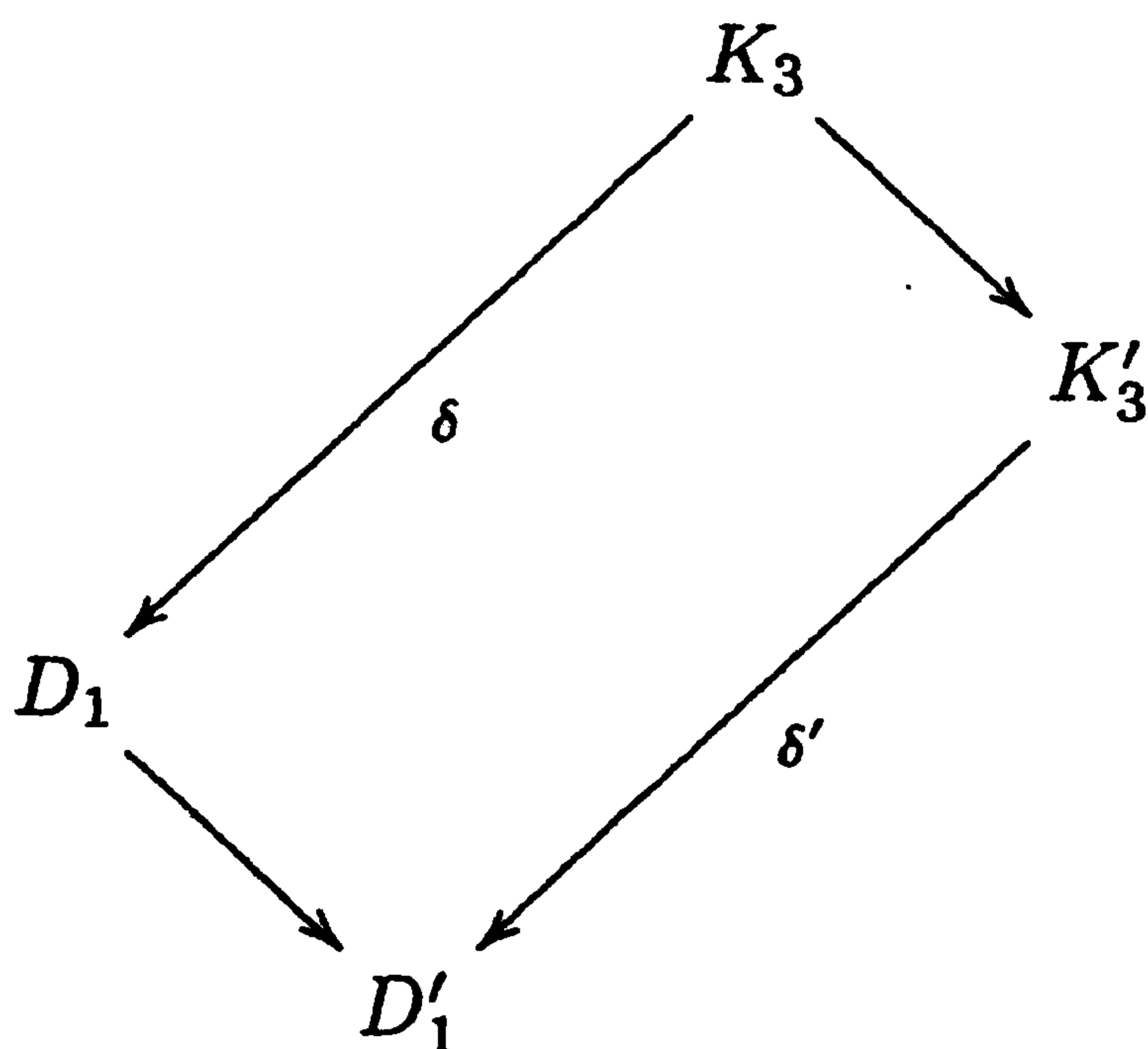

commutes.

**Proof:** First of all, let  $\varphi' : A'_1 \rightarrow A_2$  denote a kernel for  $\pi$ ; one has induced fillers  $f'_1$  and  $\varphi^*$ :

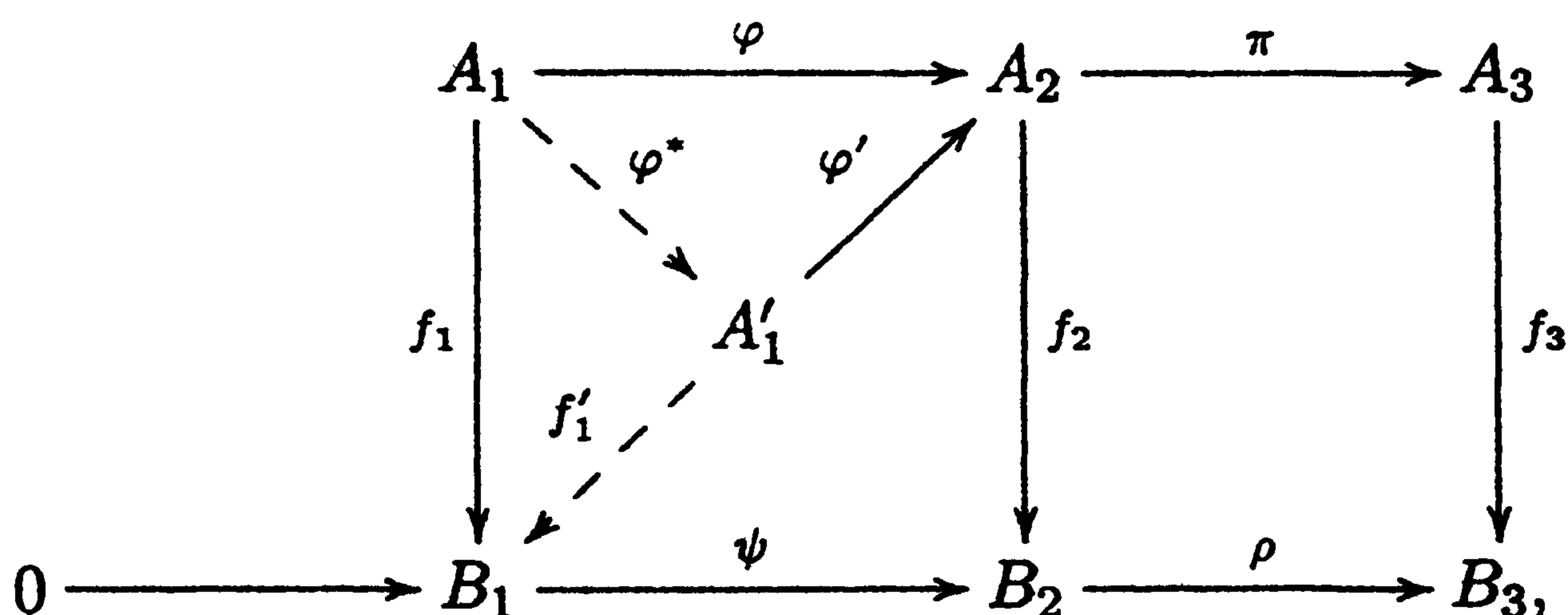

where  $f'_1$  occurs since  $\psi : B_1 \rightarrow B_2$  is a kernel for  $\rho$ , (and  $\rho f_2 \varphi' = f_3 \pi \varphi' = 0$ , so that  $f_2 \varphi'$  factors through  $B_1$ ) and  $\varphi^*$  is induced because  $\pi \varphi = 0$ . This is really the induced diagram for images discussed in Section 7.6 and is commutative. Letting  $j'_1 : K'_1 \rightarrow A'_1$  denote a kernel for  $f'_1$ , we also get induced kernel maps  $\bar{\varphi}^*$  and  $\bar{\varphi}'$ :

$$\begin{array}{ccccc}
 K_1 & \xrightarrow{\bar{\varphi}^*} & K'_1 & \xrightarrow{\bar{\varphi}'} & K_2 \\
 \downarrow j_1 & & \downarrow j'_1 & & \downarrow j_2 \\
 A_1 & \xrightarrow{\varphi^*} & A'_1 & \xrightarrow{\varphi'} & A_2 \\
 \searrow f_1 & & \searrow f'_1 & & \downarrow f_2 \\
 & & B_1 & \xrightarrow{\psi} & B_2
 \end{array}$$

Since  $\bar{\varphi}'\bar{\varphi}^* : K_1 \rightarrow K_2$  fills in where  $\bar{\varphi}$  did, and  $\bar{\varphi}$  is unique, we get that  $\bar{\varphi} = \bar{\varphi}'\bar{\varphi}^*$ . Now  $\bar{\varphi}^*$  is epic by Proposition 7.46(b), since  $\varphi^*$  is epic (kernel-exactness of  $A_1 \rightarrow A_2 \rightarrow A_3$ ),  $j'_1$  is a kernel for  $f'_1$ , and  $j_1$  is a kernel for  $f_1 = f'_1\varphi^*$ . Thus, if we show that  $\bar{\varphi}'$  is a kernel for  $\bar{\pi}$ , we obtain kernel-exactness of  $K_1 \rightarrow K_2 \rightarrow K_3$  by definition. Furthermore, if  $\varphi$  is monic, we can take  $A'_1 = A_1$ , and  $K'_1 = K_1$ , giving  $\bar{\varphi} = \bar{\varphi}'$  monic.

$\bar{\pi}\bar{\varphi}' = 0$  since  $j_3\bar{\pi}\bar{\varphi}' = \pi\varphi'j'_1 = 0$ , and  $j_3$  is monic. To show that  $\bar{\varphi}'$  is a kernel for  $\bar{\pi}$ , let  $g : C \rightarrow K_2$  be such that  $\bar{\pi}g = 0$ . It suffices to show that  $g$  factors uniquely through  $K'_1$ . Now  $0 = j_3\bar{\pi}g = \pi j_2g$ , so  $j_2g$  factors through  $A'_1$ , since  $\varphi'$  is a kernel for  $\pi$ :

$$\begin{array}{ccccccc}
 & & C & & & & \\
 & & \swarrow h & & \searrow g & & \\
 & & K'_1 & \xrightarrow{\bar{\varphi}'} & K_2 & \xrightarrow{\bar{\pi}} & K_3 \\
 & & \downarrow j'_1 & & \downarrow j_2 & & \downarrow j_3 \\
 0 & \longrightarrow & A'_1 & \xrightarrow{\varphi'} & A_2 & \xrightarrow{\pi} & A_3 \\
 & & \downarrow f'_1 & & \downarrow f_2 & & \downarrow f_3 \\
 0 & \longrightarrow & B_1 & \xrightarrow{\psi} & B_2 & \xrightarrow{\rho} & B_3
 \end{array}$$

Furthermore,  $0 = f_2j_2g = f_2\varphi'h = \psi f'_1h$ , so  $f'_1h = 0$ , since  $\psi$  is monic.

Consequently,  $h$  factors through  $K'_1$  since  $j'_1$  is a kernel for  $f'_1$ :

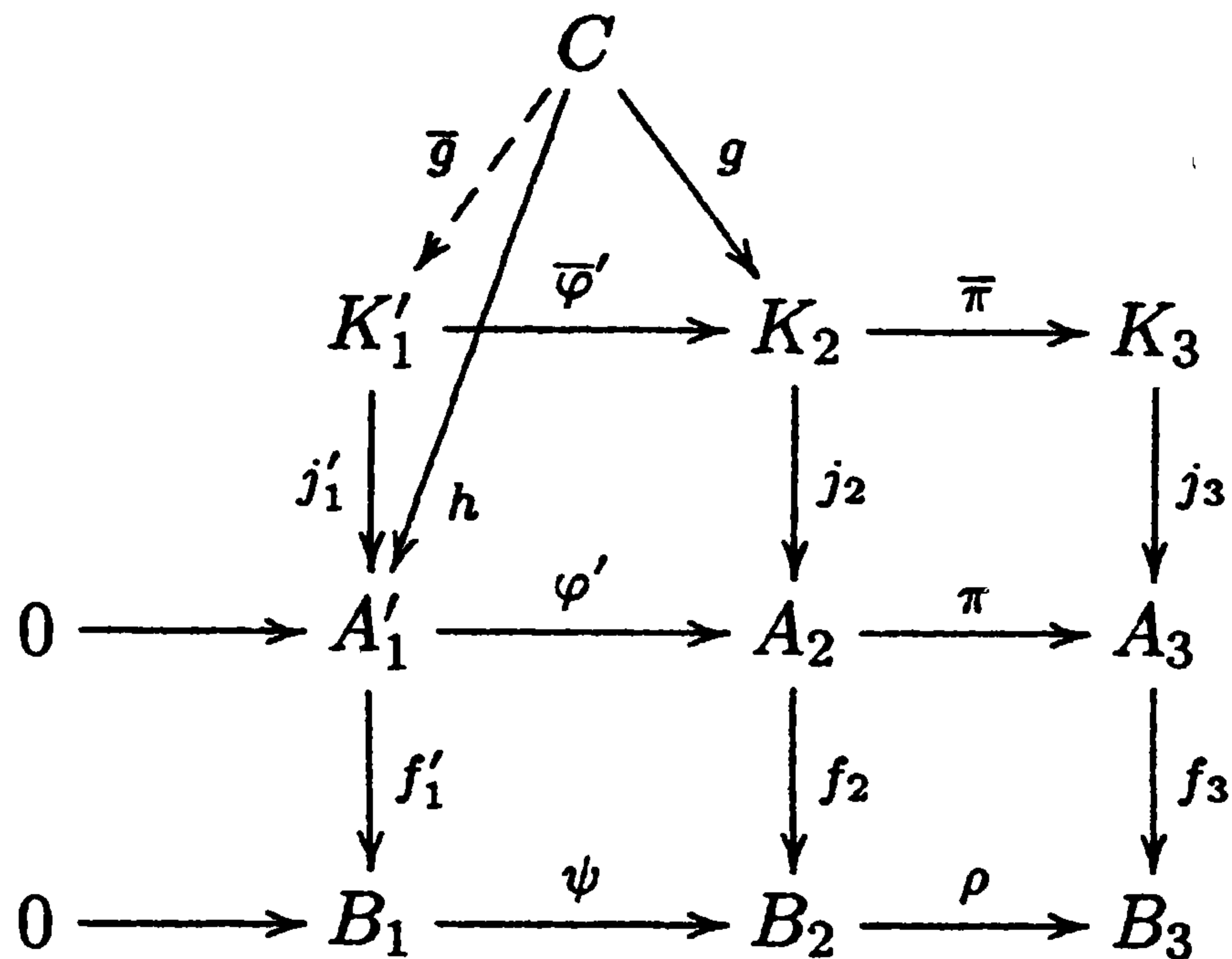

In this diagram,

$$j_2 \bar{\varphi}' \bar{g} = \varphi' j'_1 \bar{g} = \varphi' h = j_2 g \Rightarrow \bar{\varphi}' \bar{g} = g, \text{ since } j_2 \text{ is monic.}$$

This says that  $\bar{g}$  gives the required factorization through  $K_1$ . It is unique, since  $\bar{\varphi}'$  is monic. ( $j_2 \bar{\varphi}' = \varphi' j'_1$  is monic.)

$D_1 \rightarrow D_2 \rightarrow D_3$  is exact for similar reasons—actually the same reasons applied in  $\mathbf{A}^{\text{op}}$ . Also,  $D_2 \rightarrow D_3$  is epic if  $B_2 \rightarrow B_3$  is epic, again looking in  $\mathbf{A}^{\text{op}}$ .

A special case needs to be isolated:

**Special Case:** If  $B_1 = 0$ , then  $K_1 \rightarrow K_2 \rightarrow K_3 \rightarrow 0$  is exact.

The reason is that all we have to check now is that  $\bar{\pi}$  is epic, and this follows from Proposition 7.46(b):  $\rho$  is now monic, so that  $j_2$  is a kernel for  $\rho f_2 = f_3 \pi$ .

There remains the definition of  $\delta$  and its exactness properties. The definition is surprisingly easy; all the work was done in proving Theorem 7.45.

Consider first the complex

$$A_1 \xrightarrow{\varphi} A_2 \xrightarrow{f_3 \pi} B_3,$$

and consider how the homology referred to as  $\bar{H}$  was computed in Theorem 7.45. One takes the cokernel of  $\varphi$  (which is just  $\pi$ ), and factors:

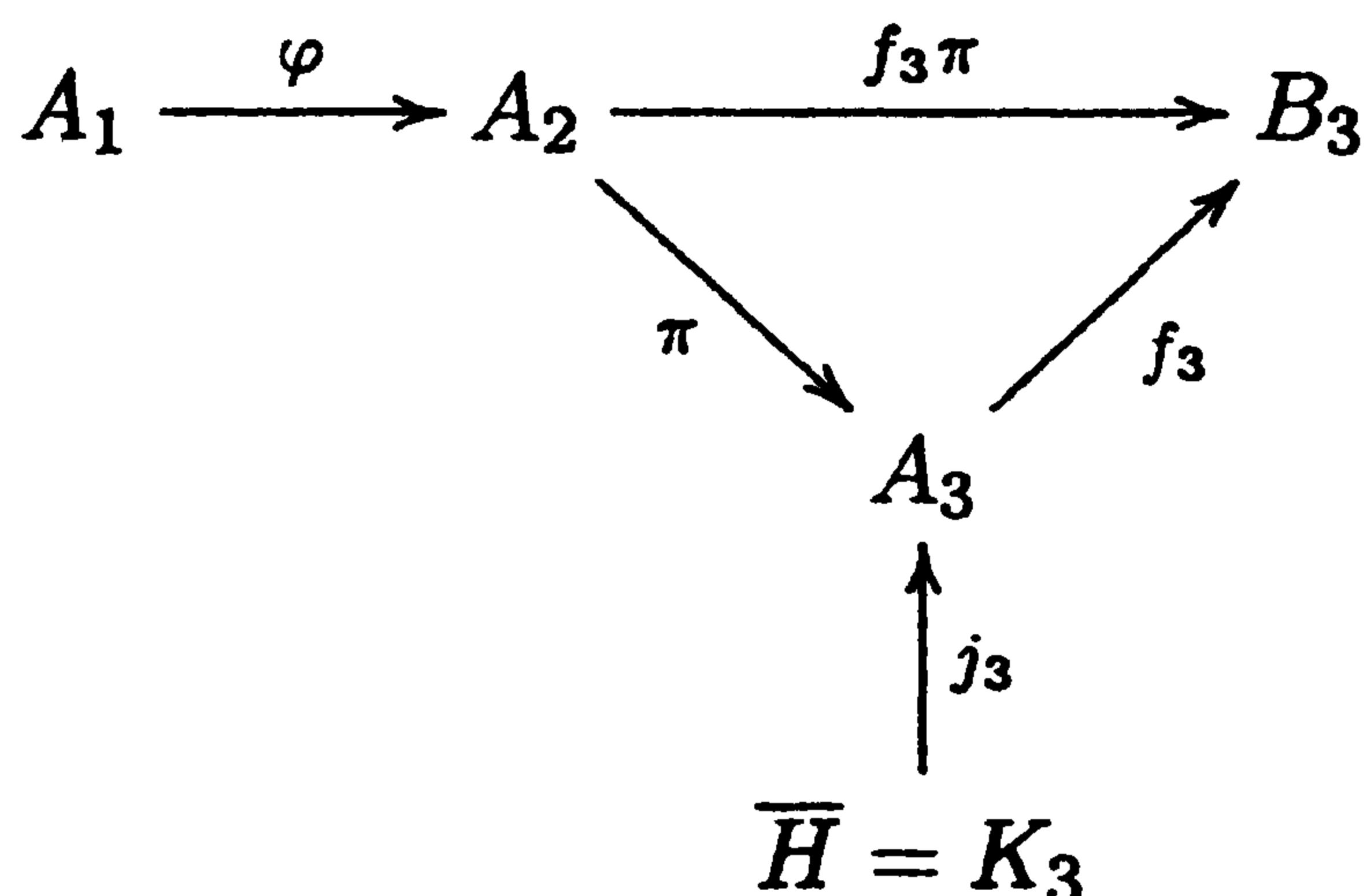

The homology is  $K_3$ , since  $j_3 : K_3 \rightarrow A_3$  is a kernel for  $f_3$ . Similarly, the homology referred to as  $H$  in Theorem 7.45 for the complex

$$A_1 \xrightarrow{\psi f_1} B_2 \xrightarrow{\rho} B_3$$

comes from the diagram

$$\begin{array}{ccccc} A_1 & \xrightarrow{\psi f_1} & B_2 & \xrightarrow{\rho} & B_3 \\ & \searrow f_1 & \nearrow \psi & & \\ & & B_1 & & \\ & & \downarrow q_1 & & \\ & & H = D_1 & & \end{array}$$

so that its homology is isomorphic to  $D_1$ . The “connecting morphism”  $\delta$  is defined as the homology map:

$$\begin{array}{ccccccc} A_1 & \xrightarrow{\varphi} & A_2 & \xrightarrow{f_3 \pi} & B_3 & : \text{homology} = & K_3 \\ \downarrow i_{A_1} & & \downarrow f_2 & & \downarrow i_{B_3} & & \downarrow (f_2)_* = \delta \\ A_1 & \xrightarrow{\psi f_1} & B_2 & \xrightarrow{\rho} & B_3 & : \text{homology} = & D_1. \end{array}$$

Naturality of  $\delta$  comes simply from examining this construction in  $\mathbf{A}(\rightarrow)$ .

Also, observe that  $\bar{\pi} : K_2 \rightarrow K_3$  is the induced homology map

$$\begin{array}{ccccccc} 0 & \xrightarrow{0} & K_2 & \xrightarrow{0} & 0 & : \text{homology} = & K_2 \\ \downarrow 0 & & \downarrow j_2 & & \downarrow 0 & & \downarrow (j_2)_* = \bar{\pi} \\ A_1 & \xrightarrow{\varphi} & A_2 & \xrightarrow{f_3 \pi} & B_3 & : \text{homology} = & K_3 \end{array}$$

since we factor through cokernels

$$\begin{array}{ccccccc} 0 & \xrightarrow{0} & K_2 & \xrightarrow{i_{K_2}} & K_2 & & \\ \downarrow 0 & & \downarrow j_2 & & \downarrow \pi j_2 = j_3 \bar{\pi} & & \\ A_1 & \xrightarrow{\varphi} & A_2 & \xrightarrow{\pi} & A_3 & & \end{array}$$

then take kernels

$$\begin{array}{ccccccc} K_2 & \xrightarrow{i_{K_2}} & K_2 & \xrightarrow{0} & 0 & & \\ \downarrow \bar{\pi} & & \downarrow j_3 \bar{\pi} & & \downarrow 0 & & \\ K_3 & \xrightarrow{j_3} & A_3 & \xrightarrow{f_3} & B_3 & & \end{array}$$

We now factor  $\delta$  as follows. Let  $f_2 = f_m f_e$  denote a monic-after-epic factorization for  $f_2$ , with  $f_e : A_2 \rightarrow I$  and  $f_m : I \rightarrow B_2$ . Let  $H_\bullet$  denote the homology of

$$A_1 \xrightarrow{f_e \varphi} I \xrightarrow{\rho f_m} B_3 : \text{homology} = H_\bullet$$

and factor

$$\begin{array}{ccccc} A_1 & \xrightarrow{\varphi} & A_2 & \xrightarrow{f_3 \pi} & B_3 : \text{homology} = K_3 \\ \downarrow i_{A_1} & & \downarrow f_e & & \downarrow i_{B_3} \\ A_1 & \xrightarrow{f_e \varphi} & I & \xrightarrow{\rho f_m} & B_3 : \text{homology} = H_\bullet \\ \downarrow i_{A_1} & & \downarrow f_m & & \downarrow i_{B_3} \\ A_1 & \xrightarrow{f_2 \varphi} & B_2 & \xrightarrow{\rho} & B_3 : \text{homology} = D_1 \end{array} \quad \begin{array}{c} \downarrow (f_e)_* = \delta_e \\ \downarrow (f_m)_* = \delta_m \end{array}$$

We can now isolate what we need to complete the proof of the ker-coker exact sequence.

**Needed Result:**  $K_2 \xrightarrow{\bar{\pi}} K_3 \xrightarrow{\delta_e} H_\bullet \longrightarrow 0$  is exact.

Observe that once we know this,  $\delta_e$  will be epic, and (in  $\mathbf{A}^{\text{op}}$ )  $0 \rightarrow H_\bullet \xrightarrow{\delta_m} D_1 \xrightarrow{\bar{\psi}} D_2$  will be exact. Thus,  $K_2 \rightarrow K_3 \rightarrow D_1 \rightarrow D_2$  will be, by definition, kernel-exact at  $D_1$  and cokernel-exact at  $K_3$ . (Also,  $\delta = \delta_m \delta_e$  will be the monic-after-epic factorization of  $\delta$ .)

At this point, we break off the proof and proceed to the long homology exact sequence, which will be used to establish the needed result.

**Theorem 7.48** *Suppose  $\mathbf{A}$  is an Abelian category in which the array*

$$\begin{array}{ccccccc} & & \vdots & & \vdots & & \vdots \\ & & \downarrow & & \downarrow & & \downarrow \\ 0 & \longrightarrow & B_{n+1} & \xrightarrow{\varphi_{n+1}} & B'_{n+1} & \xrightarrow{\pi_{n+1}} & B''_{n+1} \longrightarrow 0 \\ & & \downarrow d_{n+1} & & \downarrow d'_{n+1} & & \downarrow d''_{n+1} \\ 0 & \longrightarrow & B_n & \xrightarrow{\varphi_n} & B'_n & \xrightarrow{\pi_n} & B''_n \longrightarrow 0 \\ & & \downarrow d_n & & \downarrow d'_n & & \downarrow d''_n \\ 0 & \longrightarrow & B_{n-1} & \xrightarrow{\varphi_{n-1}} & B'_{n-1} & \xrightarrow{\pi_{n-1}} & B''_{n-1} \longrightarrow 0 \\ & & \downarrow & & \downarrow & & \downarrow \\ & & \vdots & & \vdots & & \vdots \end{array}$$





monic). Note that by definition,  $H_n$  is the cokernel of  $\alpha_{n+1} = \bar{d}_{n+1}\sigma_{n+1}$ , which is the cokernel of  $\bar{d}_{n+1}$ , since  $\sigma_{n+1}$  is epic. Similarly,  $H_{n+1}$  is isomorphic (via Theorem 7.45) to the kernel of  $j_n\bar{d}_{n+1}$ , which is the kernel of  $\bar{d}_{n+1}$ , since  $j_n$  is monic. Defining  $\bar{d}'_{n+1}$  and  $\bar{d}''_{n+1}$  (as well as  $\beta'_{n+1}, \beta''_{n+1}, \gamma_n, \gamma''_n$ ), we get the array

$$\begin{array}{ccccccc}
 H_{n+1} & \xrightarrow{(\varphi_{n+1})_*} & H'_{n+1} & \xrightarrow{(\pi_{n+1})_*} & H''_{n+1} & & \\
 \downarrow \beta_{n+1} & & \downarrow \beta'_{n+1} & & \downarrow \beta''_{n+1} & & \\
 D_{n+1} & \xrightarrow{\bar{\varphi}_{n+1}} & D'_{n+1} & \xrightarrow{\bar{\pi}_{n+1}} & D''_{n+1} & \longrightarrow & 0 \\
 \downarrow \bar{d}_{n+1} & & \downarrow \bar{d}_{n+1} & & \downarrow \bar{d}''_{n+1} & & \\
 0 \longrightarrow & K_n & \xrightarrow{\bar{\varphi}_n} & K'_n & \xrightarrow{\bar{\pi}_n} & K''_n & \\
 \downarrow \gamma_n & & \downarrow \gamma'_n & & \downarrow \gamma''_n & & \\
 H_n & \xrightarrow{(\varphi_n)_*} & H'_n & \xrightarrow{(\pi_n)_*} & H''_n & & 
 \end{array}$$

The middle two rows are exact by what we already know from the ker-coker exact sequence. Carrying out the construction of  $\alpha_{n+1}, \beta_{n+1}, \gamma_n$ , and  $\bar{d}_{n+1}$  in  $\mathbf{A}(\rightarrow)$  shows that the morphisms in the bottom and top rows really are  $(\varphi_\bullet)_*$  and  $(\pi_\bullet)_*$ . From the ker-coker exact sequence, we will get a naturally defined  $\delta_{n+1}$  and an exact sequence

$$H_{n+1} \xrightarrow{(\varphi_{n+1})_*} H'_{n+1} \xrightarrow{(\pi_{n+1})_*} H''_{n+1} \xrightarrow{\delta_{n+1}} H_n \xrightarrow{(\varphi_n)_*} H'_n \xrightarrow{(\pi_n)_*} H''_n$$

which (letting  $n$  vary now) will complete the proof once we know “Needed Result.” We obtain that from the special case there.

Suppose  $B_n = 0$ . We get that  $K_n = 0$ , so that from the special case in the ker-coker exact sequence,  $H_{n+1} \rightarrow H'_{n+1} \rightarrow H''_{n+1} \rightarrow 0$  is exact. In the notation of the ker-coker exact sequence, the following diagram, with short

exact rows and columns that are complexes

$$\begin{array}{ccccccc}
 & \vdots & & \vdots & & \vdots & \\
 & \downarrow & & \downarrow & & \downarrow & \\
 0 & \longrightarrow & 0 & \longrightarrow & 0 & \longrightarrow & 0 \\
 & & \downarrow & & \downarrow & & \downarrow \\
 0 & \longrightarrow & 0 & \longrightarrow & A_1 & \longrightarrow & A_1 \longrightarrow 0 \\
 & & \downarrow & & \downarrow \varphi & & \downarrow f_e \varphi \\
 n+1 \text{ level : } & 0 & \longrightarrow & K_2 & \xrightarrow{j_2} & A_2 & \xrightarrow{f_e} & I \longrightarrow 0 \\
 & & \downarrow & & \downarrow \rho f_2 & & \downarrow \rho f_m \\
 & 0 & \longrightarrow & 0 & \longrightarrow & B_3 & \longrightarrow & B_3 \longrightarrow 0 \\
 & & \downarrow & & \downarrow & & \downarrow \\
 & 0 & \longrightarrow & 0 & \longrightarrow & 0 & \longrightarrow & 0 \longrightarrow 0 \\
 & & \downarrow & & \downarrow & & \downarrow \\
 & \vdots & & \vdots & & \vdots & & 
 \end{array}$$

yields (from the homology calculations in the proof of the ker-coker exact sequence) the exactness of  $K_2 \xrightarrow{\bar{\pi}} K_3 \xrightarrow{\delta_e} H_\bullet \longrightarrow 0$ . The proofs of Proposition 7.47 and Theorem 7.48 are now complete.  $\square$

Our main consequence is the analog of Theorem 6.6 for derived functors.

**Theorem 7.49** *Suppose  $\mathbf{A}$  is a pre-Abelian category,  $\mathbf{A}'$  is an Abelian category, and  $F : \mathbf{A} \rightarrow \mathbf{A}'$  is an additive functor.*

- a) *If  $F$  is covariant,  $\mathbf{A}$  has enough projectives, and  $0 \rightarrow B \rightarrow B' \rightarrow B'' \rightarrow 0$  is kernel-exact, then there is a naturally defined long exact sequence for the left derived functors of  $F$ :*

$$\begin{array}{c}
 \cdots \longrightarrow \mathcal{L}_{n+1}F(B'') \longrightarrow \cdots \\
 \longrightarrow \mathcal{L}_nF(B) \longrightarrow \mathcal{L}_nF(B') \longrightarrow \mathcal{L}_nF(B'') \longrightarrow \cdots \\
 \longrightarrow \mathcal{L}_{n-1}F(B) \longrightarrow \cdots \\
 \cdots \longrightarrow \mathcal{L}_1F(B'') \longrightarrow \cdots \\
 \longrightarrow \mathcal{L}_0F(B) \longrightarrow \mathcal{L}_0F(B') \longrightarrow \mathcal{L}_0F(B'') \longrightarrow 0
 \end{array}$$

b) If  $F$  is covariant,  $\mathbf{A}$  has enough injectives, and  $0 \rightarrow B \rightarrow B' \rightarrow B'' \rightarrow 0$  is cokernel-exact, then there is a naturally defined long exact sequence for the right derived functors of  $F$ :

$$\begin{array}{c}
 \cdots \longrightarrow \mathcal{R}_{n+1}F(B) \longrightarrow \cdots \\
 \longrightarrow \mathcal{R}_nF(B) \longrightarrow \mathcal{R}_nF(B') \longrightarrow \mathcal{R}_nF(B'') \longrightarrow \cdots \\
 \cdots \longrightarrow \mathcal{R}_{n-1}F(B'') \longrightarrow \cdots \\
 \longrightarrow \mathcal{R}_1F(B) \longrightarrow \cdots \\
 0 \longrightarrow \mathcal{R}_0F(B) \longrightarrow \mathcal{R}_0F(B') \longrightarrow \mathcal{R}_0F(B'') \longrightarrow 0
 \end{array}$$

c) If  $F$  is contravariant,  $\mathbf{A}$  has enough projectives, and  $0 \rightarrow B \rightarrow B' \rightarrow B'' \rightarrow 0$  is kernel-exact, then there is a naturally defined long exact sequence for the left derived functors of  $F$ :

$$\begin{array}{c}
 \dots \longleftarrow \mathcal{L}^{n+1}F(B'') \longleftarrow \\
 \longleftarrow \mathcal{L}^n F(B) \longleftarrow \mathcal{L}^n F(B') \longleftarrow \mathcal{L}^n F(B'') \longleftarrow \\
 \longleftarrow \mathcal{L}^{n-1}F(B) \longleftarrow \dots \longleftarrow \mathcal{L}^1 F(B'') \longleftarrow \\
 \longleftarrow \mathcal{L}^0 F(B) \longleftarrow \mathcal{L}^0 F(B') \longleftarrow \mathcal{L}^0 F(B'') \longleftarrow 0
 \end{array}$$

d) If  $F$  is contravariant,  $\mathbf{A}$  has enough injectives, and  $0 \rightarrow B \rightarrow B' \rightarrow B'' \rightarrow 0$  is cokernel-exact, then there is a naturally defined long exact sequence for the right derived functors of  $F$ :

$$\begin{array}{c}
 \mathcal{R}^{n+1}F(B) \longleftarrow \dots \\
 \mathcal{R}^n F(B) \longleftarrow \mathcal{R}^n F(B') \longleftarrow \mathcal{R}^n F(B'') \longleftarrow \\
 \dots \longleftarrow \mathcal{R}^{n-1}F(B'') \longleftarrow \\
 \mathcal{R}^1 F(B) \longleftarrow \dots \\
 0 \longleftarrow \mathcal{R}^0 F(B) \longleftarrow \mathcal{R}^0 F(B') \longleftarrow \mathcal{R}^0 F(B'') \longleftarrow
 \end{array}$$

**Proof:** We do (a); (c) follows by replacing  $\mathbf{A}'$  by  $(\mathbf{A}')^{\text{op}}$ , (d) follows by replacing  $\mathbf{A}$  with  $\mathbf{A}^{\text{op}}$ , and (b) follows by making both replacements.

The crucial point, once again, is a simultaneous projective resolution of  $0 \rightarrow B \rightarrow B' \rightarrow B'' \rightarrow 0$  using Proposition 7.21. Since  $F$  is additive, each



column (obtained by applying  $F$  to the projectives of Proposition 7.21)

$$\begin{array}{c}
 0 \\
 \downarrow \\
 F(P_n) \\
 \downarrow \\
 F(P_n \oplus P_n'') \\
 \downarrow \\
 F(P_n'') \\
 \downarrow \\
 0
 \end{array}$$

is split exact by Proposition 7.4. This gives everything except naturality and independence of the simultaneous resolution used. Naturality follows directly from the usual  $\mathbf{A}(\rightarrow)$  business once independence of the simultaneous resolution is known, but (alas) independence of the simultaneous resolution does not follow directly from working in  $\mathbf{A}(\rightarrow)$ , since a typical  $P_n \rightarrow P_n'$ , as it appears in Proposition 7.8, is *not* projective in  $\mathbf{A}(\rightarrow)$ . (See Exercise 20.) This is where that obscure Corollary 7.30 comes in.

Suppose we have two projective resolutions of  $B$ , say,

$$\cdots \longrightarrow P_2 \longrightarrow P_1 \longrightarrow P_0 \longrightarrow B \longrightarrow 0$$

and

$$\cdots \longrightarrow \bar{P}_2 \longrightarrow \bar{P}_1 \longrightarrow \bar{P}_0 \longrightarrow B \longrightarrow 0.$$

One can choose  $Q_n$  projective so that

$$\cdots \longrightarrow P_2 \oplus \bar{P}_2 \oplus Q_2 \longrightarrow P_1 \oplus \bar{P}_1 \oplus Q_1 \longrightarrow P_0 \oplus \bar{P}_0 \oplus Q_0 \longrightarrow B \longrightarrow 0$$

is a projective resolution, and (in fact)

$$\begin{array}{ccccccc}
 \cdots & \longrightarrow & P_2 & \longrightarrow & P_1 & \longrightarrow & P_0 & \longrightarrow & B & \longrightarrow & 0 \\
 & & \downarrow & & \downarrow & & \downarrow & & \parallel & & \\
 \cdots & \longrightarrow & P_2 \oplus \bar{P}_2 \oplus Q_2 & \longrightarrow & P_1 \oplus \bar{P}_1 \oplus Q_1 & \longrightarrow & P_0 \oplus \bar{P}_0 \oplus Q_0 & \longrightarrow & B & \longrightarrow & 0 \\
 & & \uparrow & & \uparrow & & \uparrow & & \parallel & & \\
 \cdots & \longrightarrow & \bar{P}_2 & \longrightarrow & \bar{P}_1 & \longrightarrow & \bar{P}_0 & \longrightarrow & B & \longrightarrow & 0
 \end{array}$$

commutes. To do this, set  $Q_0 = 0$ , and choose  $Q_n$  so large that the required morphism to the next kernel is epic. We can now work in  $\mathbf{A}(\rightarrow)$  since the vertical arrows are projective. Using a diagram like that in Corollary 7.30 (with  $\widehat{K}_n$  denoting  $n$ th kernels of the middle resolution above):

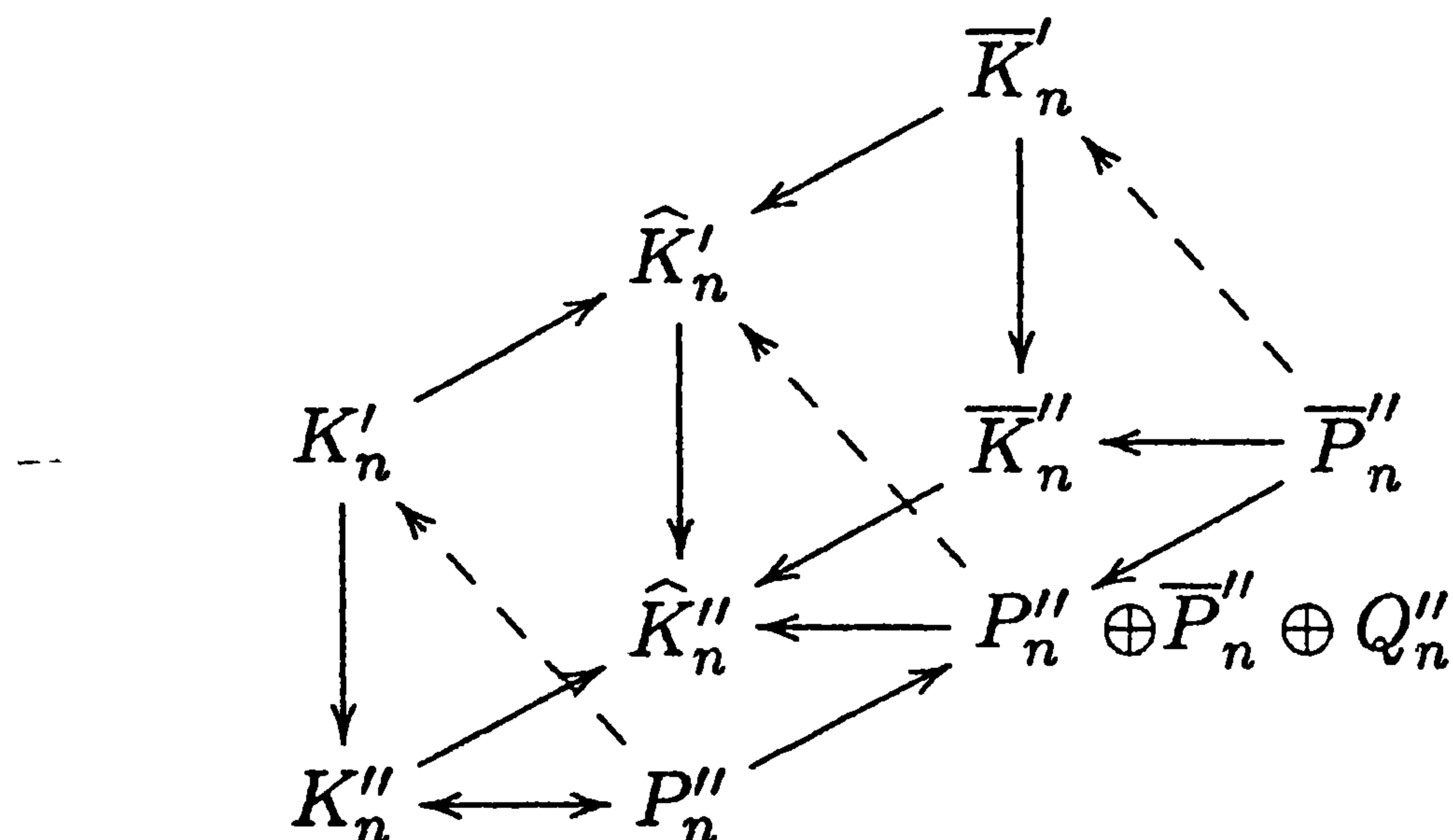

we observe that the diagonal arrows from projectives into primed kernels yield the morphism called  $f$  in the proof of Proposition 7.21. (Here,  $P''_n$ ,  $\bar{P}''_n$ , and  $Q''_n$  replace  $P_n$ ,  $\bar{P}_n$ , and  $Q_n$ , respectively, with  $B''$  replacing  $B$ .) Looking in  $\mathbf{A}(\rightarrow)$  twice (once for the near wedge and once for the far wedge) we get that the connecting morphisms are the same for

- (i) the  $P_n$  and  $P_n \oplus \bar{P}_n \oplus Q_n$  resolutions from the near wedges; and
- (ii) the  $\bar{P}_n$  and  $P_n \oplus \bar{P}_n \oplus Q_n$  resolutions, from the far wedges.  $\square$

An oddity: We now have the “deep” results, the long exact sequences (and even their naturality). What we don’t have is the most basic, that, for example, for  $F = \text{Hom}(\bullet, C) : \mathbf{A} \rightarrow \mathbf{Ab}$ ,  $\mathcal{L}^0 F \approx F$ . Unless  $\mathbf{A}$  is balanced, we won’t get it either. A way around this is the subject of the next (and last) section.

## 7.8 An Alternative for Unbalanced Categories

When working with Abelian categories, most of what needs to be said has been said. It is not hard to show by hand, for example, that  $\mathcal{L}^0 \text{Hom}(\bullet, C) \approx \text{Hom}(\bullet, C)$  for Abelian categories. As for more general pre-Abelian categories, we haven’t even defined left/right exactness. This is more subtle than it looks. We will definitely want  $\text{Hom}(\bullet, C)$  to be left exact (the analog of Proposition 2.6), even in the most perverse pre-Abelian categories. We would also like (but won’t get)  $\mathcal{L}^0 F \approx F$  for left exact functors.

There are two subjects in this section. The first covers the various kinds of exactness for functors from pre-Abelian categories to Abelian categories, and it is limited to the situation at hand.  $\text{Hom}(\bullet, C)$  will turn out to be left exact. The second is a replacement for  $\mathcal{L}^n F$ , for example, labeled  $Q\mathcal{L}^n F$ ,

for which  $QL^0F \approx F$  whenever  $F$  is contravariant and left exact. If  $\mathbf{A}$  is pre-Abelian and balanced, and has enough projectives, then  $\mathbf{A}$  satisfies Ab-epic and  $QL^n$  will equal  $\mathcal{L}^n$ , so nothing new will appear. The difference will come with pre-Abelian categories that are not balanced. It may well be the case that a specific application dictates using  $\mathcal{L}^n$ . In other applications, it may be possible to use  $QL^n$  instead, and  $QL^n$  will behave better.

To see directly what the problem is, suppose  $\mathbf{A}$  is pre-Abelian and has enough projectives, but is not balanced. Suppose  $f : A \rightarrow B$  is a bimorphism, but not an isomorphism. Then by Exercise 23 there is a  $C$  for which  $f^* : \text{Hom}(B, C) \rightarrow \text{Hom}(A, C)$  is not an isomorphism. Set  $F = \text{Hom}(\bullet, C)$ . Let  $\cdots \rightarrow P_1 \rightarrow P_0 \xrightarrow{\pi} A \rightarrow 0$  be a projective resolution of  $A$ . Then  $f\pi$  is also epic (since  $f$  and  $\pi$  are epic), while a kernel for  $\pi$  is a kernel for  $f\pi$  (since  $f$  is monic). Thus  $\cdots \rightarrow P_1 \rightarrow P_0 \xrightarrow{f\pi} B \rightarrow 0$  is a projective resolution of  $B$ . Since only the projectives survive into the definition of  $\mathcal{L}^n F$ , we get  $\mathcal{L}^n F(A) = \mathcal{L}^n F(B)$ , all  $n$ . But that means that  $\mathcal{L}^0 F(A) = \mathcal{L}^0 F(B)$ , a group which cannot possibly reproduce both  $F(A)$  (via  $\pi^*$ ) and  $F(B)$  (via  $(f\pi)^* = \pi^* f^*$ ). Ouch.

We start with the kind of exactness we need. The following proposition tells us most of that.

**Proposition 7.50** *Suppose  $\mathbf{A}$  is a pre-Abelian category in which  $\varphi : A \rightarrow B$  and  $\psi : B \rightarrow D$  are given. Then*

$$0 \rightarrow \text{Hom}(D, C) \xrightarrow{\psi^*} \text{Hom}(B, C) \xrightarrow{\varphi^*} \text{Hom}(A, C)$$

*is exact for all  $C$  if and only if  $\psi$  is a cokernel for  $\varphi$ .*

**Proof:** Suppose first that  $\psi$  is a cokernel for  $\varphi$ . Fix  $C$ . Then  $\psi$  is epic, so  $\forall f \in \text{Hom}(D, C)$ ,  $\psi^* f = 0 \Rightarrow f\psi = 0 \Rightarrow f = 0$ . That is,  $\psi^*$  is one-to-one. Next,  $\varphi^* \psi^* = (\psi\varphi)^* = 0^* = 0$ . Finally, if  $\varphi^* f = 0$  for  $f \in \text{Hom}(B, C)$ , then  $f\varphi = 0 \Rightarrow f = \bar{f}\psi$  for a (unique)  $\bar{f}$ , since  $\psi$  is a cokernel for  $\varphi$ :

$$\begin{array}{ccccc} A & \xrightarrow{\varphi} & B & \xrightarrow{\psi} & D \\ & & \searrow f & & \nearrow \bar{f} \\ & & C & & \end{array}$$

But now  $f = \bar{f}\psi = \psi^*(\bar{f})$ .

For the converse, suppose

$$0 \longrightarrow \text{Hom}(D, C) \xrightarrow{\psi^*} \text{Hom}(B, C) \xrightarrow{\varphi^*} \text{Hom}(A, C)$$

is exact for all  $C$ . Setting  $C = D$ ,  $0 = \varphi^* \psi^*(i_D) = i_D \psi \varphi = \psi \varphi$ , so  $\psi \varphi = 0$ . But we also have that for any  $C$ , and any  $f \in \text{Hom}(B, C)$ ,  $0 = f\varphi =$

$\varphi^*(f) \Rightarrow \exists$  a unique  $\bar{f} \in \text{Hom}(D, C)$  such that  $f = \psi^*(\bar{f}) = \bar{f}\psi$ . This is just the definition of a cokernel.  $\square$

Now for exactness. Peeking ahead, we make one modification to the above.

**Definition 7.51** Suppose  $F : \mathbf{A} \rightarrow \mathbf{A}'$  is a covariant functor, where  $\mathbf{A}$  is pre-Abelian and  $\mathbf{A}'$  is Abelian.  $F$  is (i) exact, (ii) left exact, (iii) right exact, or (iv) half exact, provided that whenever

$$A \xrightarrow{\varphi} B \xrightarrow{\psi} C$$

satisfies both  $\varphi = \text{kernel of } \psi$ , and  $\psi = \text{cokernel of } \varphi$ , we have exactness in  $\mathbf{A}'$  of

- i)  $0 \rightarrow F(A) \rightarrow F(B) \rightarrow F(C) \rightarrow 0$ ,
- ii)  $0 \rightarrow F(A) \rightarrow F(B) \rightarrow F(C)$ ,
- iii)  $F(A) \rightarrow F(B) \rightarrow F(C) \rightarrow 0$ ,
- iv)  $F(A) \rightarrow F(B) \rightarrow F(C)$ .

If  $F$  is contravariant then  $F$  is defined to have the same exactness as the covariant functor  $F^{\text{op}} : \mathbf{A}^{\text{op}} \rightarrow \mathbf{A}'$ . Again, note that

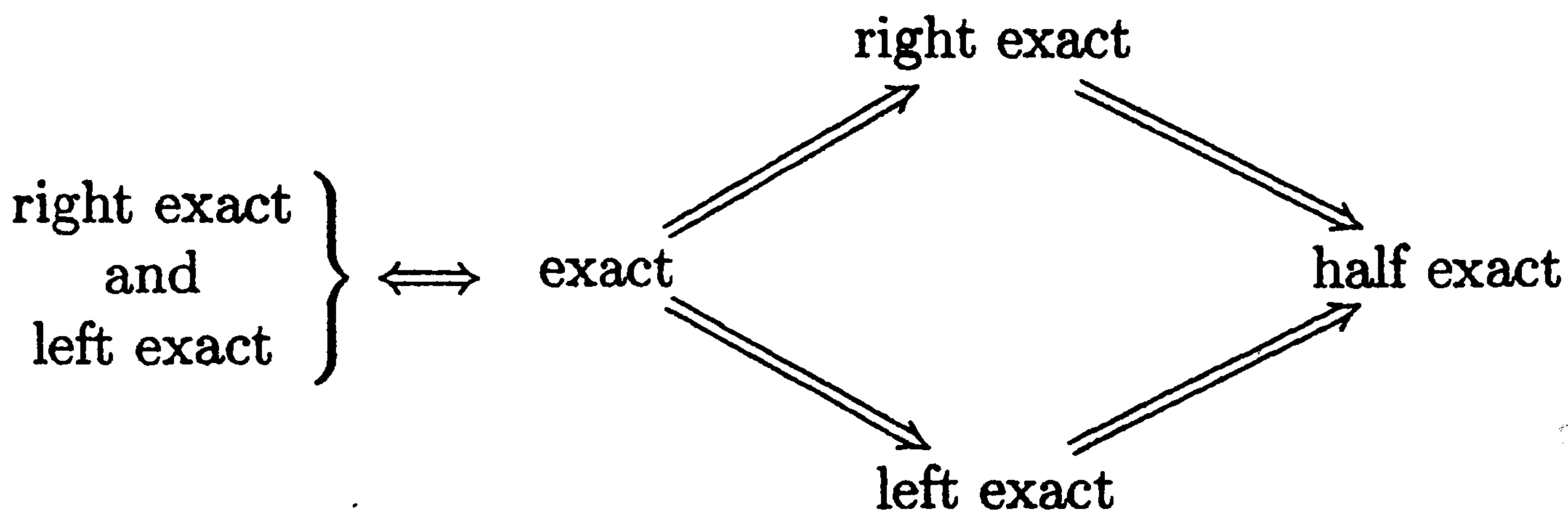

and (from Proposition 7.50)  $\text{Hom}(\bullet, C)$  is left exact.

In this section, with the focus on  $\text{Hom}(\bullet, C)$ , we shall concentrate on contravariant functors and left exactness. Making the substitution of  $\mathbf{A}^{\text{op}}$  for  $\mathbf{A}$  and/or  $(\mathbf{A}')^{\text{op}}$  for  $\mathbf{A}'$  will give the appropriate generalizations of the to-be-defined  $Q\mathcal{L}^n$  (i.e.,  $Q\mathcal{L}_n$ ,  $Q\mathcal{R}^n$ , and  $Q\mathcal{R}_n$ ) for covariant/contravariant functors. The routine should be clear by now.

Suppose  $F$  is a half exact contravariant functor from a pre-Abelian category  $\mathbf{A}$  to an Abelian category  $\mathbf{A}'$ . If  $(A \oplus B; \varphi, \psi; \pi, q)$  is a biproduct of  $A$  with  $B$  in  $\mathbf{A}$ , then  $q$  is a cokernel for  $\varphi$ :

$$\begin{array}{ccccc}
 A & \xrightarrow{\varphi} & A \oplus B & \xrightarrow{q} & B & f\varphi = 0 \\
 & & \searrow f & & \swarrow \bar{f} = f\psi \\
 & & & & C
 \end{array}$$



since  $f\psi q = f\psi q + 0 = f\psi q + f\varphi\pi = f(\psi q + \varphi\pi) = f$ . (This  $\bar{f}$  is unique, since  $q\psi = i_B \Rightarrow q$  is epic.) Similarly,  $\varphi$  is a kernel for  $q$ . (No surprise so far.) Furthermore, suppose

$$0 \longrightarrow A_1 \xrightarrow{\varphi_1} A \xrightarrow{\pi_2} A_2 \longrightarrow 0$$

is split exact in  $\mathbf{A}'$ , say  $\exists \varphi_2 : A_2 \rightarrow A$  for which  $\pi_2\varphi_2 = i_{A_2}$ . Then  $\pi_2(i_A - \varphi_2\pi_2) = \pi_2 - \pi_2\varphi_2\pi_2 = \pi_2 - i_{A_2}\pi_2 = 0$ , so  $i_A - \varphi_2\pi_2$  factors through  $A_1$  (since  $\varphi_1$  is a kernel for  $\pi_2$ ):  $i_A - \varphi_2\pi_2 = \varphi_1\pi_1$  for a unique  $\pi_1$ . Well.  $i_A = \varphi_1\pi_1 + \varphi_2\pi_2$  and  $i_{A_2} = \pi_2\varphi_2$ . How about  $\pi_1\varphi_1$ ?  $\varphi_1\pi_1\varphi_1 = (i_A - \varphi_2\pi_2)\varphi_1 = \varphi_1 - \varphi_2\pi_2\varphi_1 = \varphi_1 = \varphi_1 i_{A_1}$ , since  $\pi_2\varphi_1 = 0$ , so  $\pi_1\varphi_1 = i_{A_1}$ , since  $\varphi_1$  is monic. Moral:  $(A; \varphi_1, \varphi_2, \pi_1, \pi_2)$  is a biproduct of  $A_1$  with  $A_2$ . That is, a split exact sequence is a biproduct in any Abelian category.

Suppose  $F$  is half exact and, say, contravariant. If  $(A; \varphi_1, \varphi_2, \pi_1, \pi_2)$  is a biproduct, then

$$0 \longrightarrow F(A_2) \xrightarrow{F(\pi_2)} F(A) \xrightarrow{F(\varphi_1)} F(A_1) \longrightarrow 0$$

is exact at  $F(A_2)$  ( $i_{F(A_2)} = F(i_{A_2}) = F(\pi_2\varphi_2) = F(\varphi_2)F(\pi_2) \Rightarrow F(\pi_2)$  is monic),  $F(A)$  (half exactness) and  $F(A_1)$  ( $i_{F(A_1)} = F(i_{A_1}) = F(\pi_1\varphi_1) = F(\varphi_1)F(\pi_1) \Rightarrow F(\varphi_1)$  is epic). It is split exact since  $F(\varphi_1)F(\pi_1) = F(\pi_1\varphi_1) = F(i_{A_1}) = i_{F(A_1)}$ . Hence, by Proposition 7.4,  $F$  is additive. (Note: We learn from this that the abstractly existing fourth map from  $F(A)$  to  $F(A_2)$  constructed earlier is actually  $F(\varphi_2)$ .)

*Any half exact functor is additive.*

So much for our discussion of functors. The real departure from earlier material comes in deriving them. The replacement for projectives is dictated now by the cokernel business in the definition of exactness.

**Definition 7.52** *Let  $\mathbf{A}$  be a pre-Abelian category. An object  $Q$  in  $\mathbf{A}$  is quasiprojective if a filler exists in any diagram*

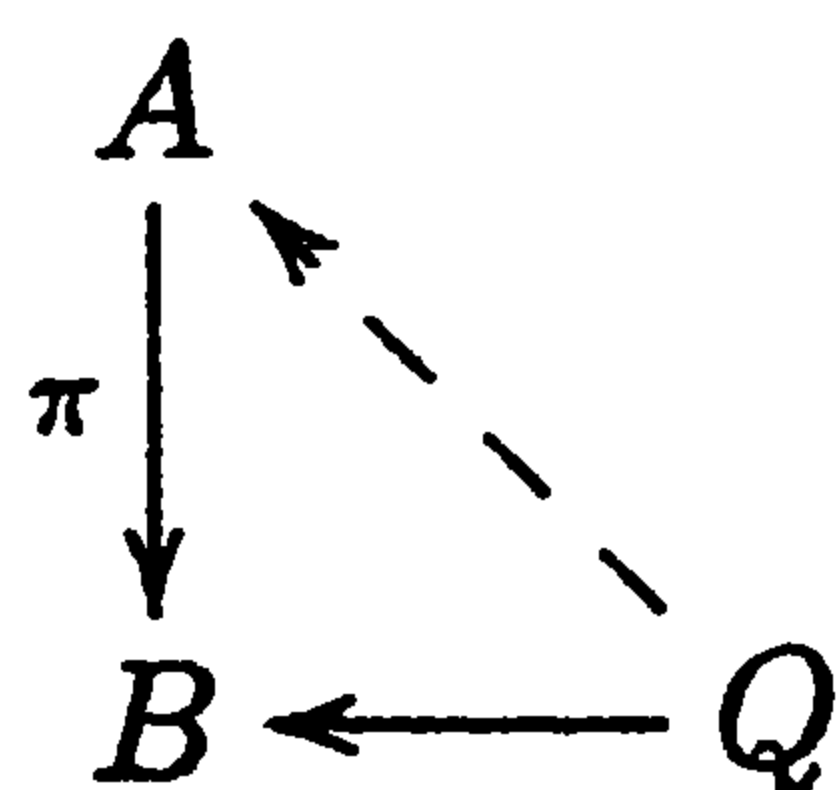

in which  $\pi$  is a cokernel, that is, is a cokernel for some morphism into  $A$ .  $\mathbf{A}$  has enough quasiprojectives provided that, for any object  $A$ , there exists a quasiprojective  $Q$  and a cokernel  $\pi : Q \rightarrow A$ .

**Remark:** Note that projective  $\Rightarrow$  quasiprojective. It is easier to be quasiprojective than projective, but harder to have enough of them (since the



epimorphism  $\pi : Q \rightarrow A$  must actually be a cokernel). Note, also, that if  $\mathbf{A}$  has the property that, for each object  $A$ , there is a projective  $P$  and a cokernel  $\pi : P \rightarrow A$ , then  $\mathbf{A}$  is balanced (see Exercise 23). The weakening of the condition on  $Q$  matches the strengthening of the condition on  $\pi$ . Finally, any cokernel is a cokernel for its kernel (see Exercise 13); similarly, any kernel (= kernel of some morphism) is a kernel for its cokernel.

As in Section 7.4, we shall need a mechanism for cheating. Here, we do it with a definition.

**Definition 7.53 (temporary)** *Suppose  $\mathbf{A}$  is a pre-Abelian category with enough quasiprojectives. A morphism  $\pi : A \rightarrow B$  will be called a cokernel<sup>•</sup> if a filler exists in any diagram*

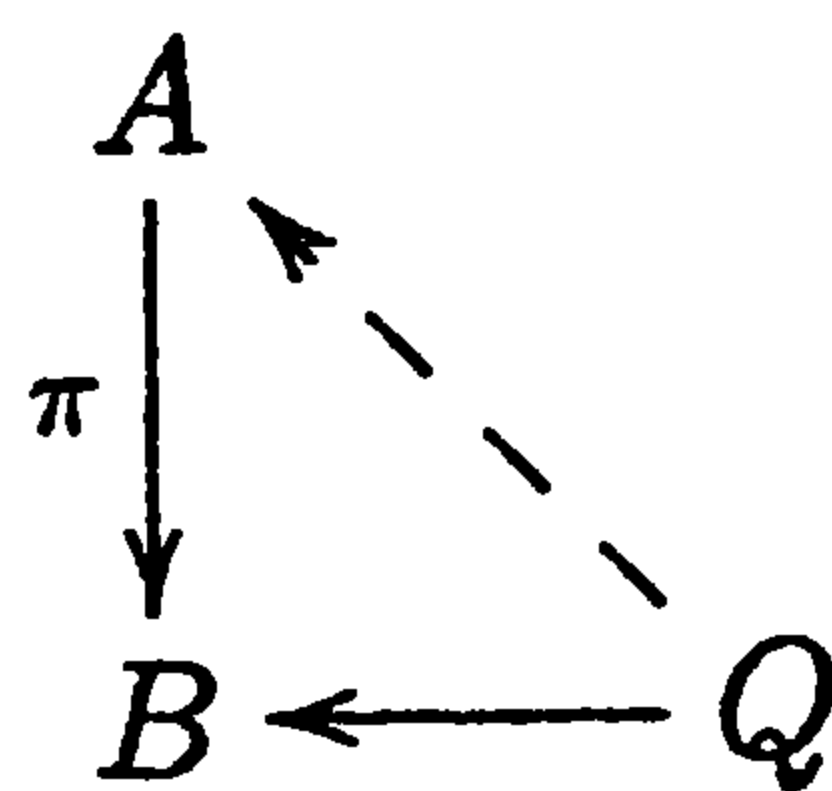

in which  $Q$  is quasiprojective.

**Remark:** It will turn out that cokernel<sup>•</sup> is the same as cokernel. While a direct proof is possible, it seems simpler to let this be an almost trivial consequence of the theory to be developed. Note that cokernel  $\Rightarrow$  cokernel<sup>•</sup> trivially, while cokernel<sup>•</sup>  $\Rightarrow$  epimorphism by selecting  $Q$  and the horizontal arrow above to be epic (e.g. a cokernel).

A *quasiprojective resolution* of an object  $A$  will be a sequence

$$\dots \longrightarrow Q_2 \xrightarrow{d_2} Q_1 \xrightarrow{d_1} Q_0 \xrightarrow{\pi} B$$

of morphisms in which each  $Q_j$  is quasiprojective,  $d_j d_{j+1} = 0$  for  $j \geq 1$ ,  $\pi d_1 = 0$ , and, if  $p_n$  is the factorization of  $d_n$  through a kernel  $j_n : K_n \rightarrow Q_{n-1}$  of  $d_{n-1}$  (or of  $\pi$  if  $n = 1$ ) so that  $d_n = j_n p_n$ , then each  $p_n$  (as well as  $\pi$ ) is a cokernel<sup>•</sup>.

**Proposition 7.54** *Suppose  $\mathbf{A}$  is a pre-Abelian category with enough quasiprojectives. Then any object in  $\mathbf{A}$  has a quasiprojective resolution, which can be chosen using a choice function. If  $B, B' \in \mathbf{A}$  and  $\varphi \in \text{Hom}(B, B')$ , and if  $\langle Q_n, d_n \rangle$  is a quasiprojective resolution of  $B$ , and  $\langle Q'_n, d'_n \rangle$  is a quasiprojective resolution of  $B'$ , then there exist fillers  $\varphi_n \in \text{Hom}(Q_n, Q'_n)$  making*

$$\begin{array}{ccccccccccc}
 \dots & \longrightarrow & Q & \xrightarrow{d_{n+1}} & Q_n & \xrightarrow{d_n} & \dots & \longrightarrow & Q_1 & \xrightarrow{d_1} & Q_0 & \xrightarrow{\pi} & B \\
 & & | & & | & & & & | & & | & & \downarrow \varphi \\
 & & \varphi_{n+1} & & \varphi_n & & & & \varphi_1 & & \varphi_0 & & \\
 & & \downarrow & & \downarrow & & & & \downarrow & & \downarrow & & \\
 \dots & \longrightarrow & Q'_{n+1} & \xrightarrow{d'_{n+1}} & Q'_n & \xrightarrow{d'_n} & \dots & \longrightarrow & Q'_1 & \xrightarrow{d'_1} & Q'_0 & \xrightarrow{\pi'} & B'
 \end{array}$$

commutative. Further, if  $\varphi'_n \in \text{Hom}(Q_n, Q'_n)$  also serve as fillers, then  $\varphi_n$  and  $\varphi'_n$  are homotopic, that is, there exist  $D_n \in \text{Hom}(Q_n, Q'_{n+1})$  (with  $D_{-1} = 0$ ) such that  $\varphi_n - \varphi'_n = d'_{n+1}D_n + D_{n-1}d_n$ .

**Proof:** Virtually identical to the proof of Proposition 7.8, with the letter  $Q$  replacing  $P$ , “quasiprojective” replacing “projective,” and “cokernel<sup>•</sup>” replacing “epimorphism.” In particular, each  $p'_n$  is a cokernel<sup>•</sup>, allowing the proof to proceed.  $\square$

For each object  $A$  in  $\mathbf{A}$ , choose once and for all a quasiprojective resolution of  $A$ , but not just any old quasiprojective resolution: Choose it in such a way that  $\pi$  and each  $p_n$  are actually cokernels. (This can be done by the first part of the above “proof”, transported over from Proposition 7.8.) The  $n$ th left quasiderived functor of an additive contravariant functor  $F$  from  $\mathbf{A}$  to an Abelian category is defined to be the  $n$ th homology of

$$\cdots \longleftarrow F(Q_2) \xleftarrow{F(d_2)} F(Q_1) \xleftarrow{F(d_1)} F(Q_0) \longleftarrow 0,$$

homology at  $F(Q_n) : Q\mathcal{L}^n F(B)$ .

For the usual reasons, the definition of  $Q\mathcal{L}^n F$  is independent (up to isomorphism) of the quasiprojective resolution, and does yield a sequence of contravariant functors. Furthermore, as with  $\text{Ext}$  back in Chapter 3, there is a natural transformation  $\pi^*$  from  $F$  to  $Q\mathcal{L}^0 F$  defined by applying  $F(\pi)$  to any  $F(B)$ :

$$\begin{array}{ccccc} F(B) & \xrightarrow{F(\pi)} & F(Q_0) & \xrightarrow{F(d_1)} & F(Q_1) \\ & \searrow (\pi^*)_B & \nearrow & & \\ & & Q\mathcal{L}^0 F(B) & = \text{a kernel for } F(d_1) & \end{array}$$

$Q\mathcal{L}^0$  has the missing property.

**Proposition 7.55** *If  $\mathbf{A}$  is a pre-Abelian category with enough quasiprojectives, and  $F$  is a left exact contravariant functor from  $\mathbf{A}$  to an Abelian category, then  $\pi^*$  is a natural isomorphism of  $F$  with  $Q\mathcal{L}^0 F$ .*

**Proof:** Recall that we selected  $\pi$  to be a real live cokernel; it is a cokernel for  $j_1$ , and  $j_1$  is a kernel for  $\pi$ , so

$$0 \longrightarrow F(B) \xrightarrow{F(\pi)} F(Q_0) \xrightarrow{F(j_1)} F(K_1)$$

is exact in the (target) Abelian category. Similarly,

$$0 \longrightarrow F(K_1) \xrightarrow{F(p_1)} F(Q_1) \xrightarrow{F(j_2)} F(K_2)$$

is exact, so  $F(p_1)$  is monic. Hence,  $F(j_1)$  and  $F(p_1)F(j_1) = F(j_1p_1) = F(d_1)$  have the same kernel, namely  $F(B)$ . This is the zeroth homology.  $\square$

**Corollary 7.56** *Suppose  $\mathbf{A}$  is a balanced pre-Abelian category and  $\mathbf{A}'$  is Abelian. Suppose  $F : \mathbf{A} \rightarrow \mathbf{A}'$  is a functor.*

- a) *If  $F$  is contravariant and left exact, and  $\mathbf{A}$  has enough projectives, then  $\mathcal{L}^0 F \approx F$ .*
- b) *If  $F$  is covariant and right exact, and  $\mathbf{A}$  has enough projectives, then  $\mathcal{L}_0 F \approx F$ .*
- c) *If  $F$  is contravariant and right exact, and  $\mathbf{A}$  has enough injectives, then  $\mathcal{R}^0 F \approx F$ .*
- d) *If  $F$  is covariant and left exact, and  $\mathbf{A}$  has enough injectives, then  $\mathcal{R}_0 F \approx F$ .*

**Proof:** (b), (c), and (d) follow from (a) by making substitutions of opposite categories for  $\mathbf{A}$  and/or  $\mathbf{A}'$ .

For (a), note that  $\mathbf{A}$  satisfies Ab-epic by Proposition 7.17. But this means that projective = quasiprojective, and epimorphism = cokernel = cokernel $^\bullet$  (Proposition 7.14(b)). Hence,  $\mathcal{L}^0 F \approx Q\mathcal{L}^0 F \approx F$ .  $\square$

So. The results we want are falling right and left. There remains the business of long exact sequences. We need an analog of Proposition 7.20.

**Proposition 7.57** *Suppose  $\mathbf{A}$  is a pre-Abelian category that has enough quasi-projectives. Suppose we have the diagram*

$$\begin{array}{ccccc}
 K_1 & \xrightarrow{\psi_1} & B_1 & \xrightarrow{\varphi_1} & C_1 \\
 \downarrow \iota' & & \downarrow \iota & & \downarrow j \\
 K_2 & \xrightarrow{\psi_2} & B_2 & \xrightarrow{\varphi_2} & C_2 \\
 \downarrow p' & & \downarrow p & & \downarrow q \\
 K_3 & \xrightarrow{\psi_3} & B_3 & \xrightarrow{\varphi_3} & C_3
 \end{array}$$

*in which  $\iota$  is a kernel for  $p$ ,  $j$  is a kernel for  $q$ , and  $\psi_i$  is a kernel for  $\varphi_i$ ,  $i = 1, 2, 3$ . Suppose that each of  $\varphi_1$ ,  $\varphi_3$ , and  $p$  is a cokernel $^\bullet$ . Then  $\varphi_2$  is a cokernel $^\bullet$ ,  $\iota'$  is a kernel for  $p'$ , and  $p'$  is also a cokernel $^\bullet$ .*

**Remark about English Usage:** In the above, one strains to avoid the plural of "cokernel $^\bullet$ ."

**Proof:**  $\varphi_2$  is a cokernel<sup>•</sup>: Suppose  $f : Q \rightarrow C_2$  is a morphism, with  $Q$  quasiprojective. There is a filler  $g$ :

$$\begin{array}{ccc} B_3 & & \\ \varphi_3 \downarrow & \nearrow g & \\ C_3 & \xleftarrow{qf} & Q \end{array}$$

since  $\varphi_3$  is a cokernel<sup>•</sup>. There is a filler  $h$ :

$$\begin{array}{ccc} B_2 & & \\ p \downarrow & \nearrow h & \\ B_3 & \xleftarrow{g} & Q \end{array}$$

since  $p$  is a cokernel<sup>•</sup>. Now  $qf = \varphi_3g = \varphi_3ph = q\varphi_2h$ , that is,  $q(f - \varphi_2h) = 0$ . Hence,  $f - \varphi_2h = j\theta$  for some  $\theta : Q \rightarrow C_1$ , since  $j$  is a kernel for  $q$ . Finally, there is a filler  $\alpha$ :

$$\begin{array}{ccc} B_1 & & \\ \varphi_1 \downarrow & \nearrow \alpha & \\ C_1 & \xleftarrow{\theta} & Q \end{array}$$

since  $\varphi_1$  is a cokernel<sup>•</sup>. But now

$$\begin{aligned} \varphi_2(h + \iota\alpha) &= \varphi_2h + \varphi_2\iota\alpha \\ &= \varphi_2h + j\varphi_1\alpha \\ &= \varphi_2h + j\theta \\ &= \varphi_2h + f - \varphi_2h \\ &= f. \end{aligned}$$

$p'$  is a cokernel<sup>•</sup>: Suppose  $f : Q \rightarrow K_3$  is a morphism, with  $Q$  quasiprojective. There is a filler  $g$ :

$$\begin{array}{ccc} B_2 & & \\ p \downarrow & \nearrow g & \\ B_3 & \xleftarrow{\psi_3f} & Q \end{array}$$

since  $p$  is a cokernel<sup>•</sup>. Now  $q\varphi_2g = \varphi_3pg = \varphi_3\psi_3f = 0$ , since  $\varphi_3\psi_3 = 0$ , so  $\varphi_2g$  factors through  $C_1$ , since  $j$  is a kernel for  $q : \varphi_2g = jh, h : Q \rightarrow C_1$ . Finally, there is a filler  $\alpha$ :

$$\begin{array}{ccc} B_1 & & \\ \varphi_1 \downarrow & \nearrow \alpha & \\ C_1 & \xleftarrow{h} & Q \end{array}$$

since  $\varphi_1$  is a cokernel<sup>\*</sup>: Now  $\varphi_2\iota\alpha = j\varphi_1\alpha = jh = \varphi_2g$ , so  $\varphi_2(g - \iota\alpha) = 0$ . Hence,  $g - \iota\alpha$  factors through  $K_2$ , since  $\psi_2$  is a kernel for  $\varphi_2$ :  $g - \iota\alpha = \psi_2\bar{f}$ . But now  $\psi_3p'\bar{f} = p\psi_2\bar{f} = p(g - \iota\alpha) = pg - p\iota\alpha = pg - 0 = \psi_3f$ , so  $p'\bar{f} = f$ , since  $\psi_3$  is monic.

$\iota'$  is a kernel for  $p'$ : Suppose  $f : D \rightarrow K_2$  satisfies  $p'f = 0$ . Then  $0 = \psi_3p'f = p\psi_2f$ , so  $\psi_2f$  factors through  $B_1$  since  $\iota$  is a kernel for  $p$ :  $\psi_2f = \iota\bar{f}$ . Now  $j\varphi_1\bar{f} = \varphi_2\iota\bar{f} = \varphi_2\psi_2f = 0f = 0$ , so  $\varphi_1\bar{f} = 0$ , since  $j$  is monic. Hence,  $\bar{f}$  factors through  $K_1$ , since  $\psi_1$  is a kernel for  $\varphi_1$ :  $\bar{f} = \psi_1\tilde{f}$ . But now  $\psi_2\iota'\tilde{f} = \iota\psi_1\tilde{f} = \iota\bar{f} = \psi_2f$ , so  $\iota'\tilde{f} = f$ , since  $\psi_2$  is monic. Finally, this  $\tilde{f}$  is unique, since  $\psi_2\iota' = \iota\psi_1$  is monic  $\Rightarrow \iota'$  is monic.  $\square$

We have a few corollaries.

**Corollary 7.58** *Suppose  $\mathbf{A}$  is a pre-Abelian category with enough quasiprojectives. Suppose  $j : B \rightarrow B'$  is a kernel for the cokernel<sup>\*</sup>  $p : B' \rightarrow B''$ . Given quasiprojective resolutions of  $B$  and  $B''$ :*

$$\begin{array}{ccccccc} \cdots & \longrightarrow & Q_2 & \xrightarrow{d_2} & Q_1 & \xrightarrow{d_1} & Q_0 & \xrightarrow{\pi} & B \\ & & & & & & & & \downarrow j \\ & & & & & & & & B' \\ & & & & & & & & \downarrow p \\ \cdots & \longrightarrow & Q_2'' & \xrightarrow{d_2''} & Q_1'' & \xrightarrow{d_1''} & Q_0'' & \xrightarrow{\pi''} & B'' \end{array}$$

there exist morphisms  $\pi' : Q_0 \oplus Q_0'' \rightarrow B'$  and  $d'_n : Q_n \oplus Q_n'' \rightarrow Q_{n-1} \oplus Q_{n-1}''$  such that

$$\begin{array}{ccccccc} \cdots & \longrightarrow & Q_2 & \xrightarrow{d_2} & Q_1 & \xrightarrow{d_1} & Q_0 & \xrightarrow{\pi} & B \\ & & \downarrow & & \downarrow & & \downarrow & & \downarrow j \\ \cdots & \longrightarrow & Q_2 \oplus Q_2'' & \xrightarrow{d_2'} & Q_1 \oplus Q_1'' & \xrightarrow{d_1'} & Q_0 \oplus Q_0'' & \xrightarrow{\pi'} & B' \\ & & \downarrow & & \downarrow & & \downarrow & & \downarrow p \\ \cdots & \longrightarrow & Q_2'' & \xrightarrow{d_2''} & Q_1'' & \xrightarrow{d_1''} & Q_0'' & \xrightarrow{\pi''} & B'' \end{array}$$

is commutative and consists (horizontally) of quasiprojective resolutions. (The vertical morphisms are the obvious ones.)

**Proof:** Virtually identical to the proof of Proposition 7.21. The “ $\varphi_2$  is a cokernel<sup>\*</sup>” part of Proposition 7.57 replaces the “epic 4-lemma,” and the filler  $f$  from  $Q_0''$  to  $B'$  arises because  $Q_0''$  is quasiprojective and  $p$  is a cokernel<sup>\*</sup>. Finally, the rest of Proposition 7.57 guarantees that the sequence  $K_n \rightarrow K_n' \rightarrow K_n''$  inductively has the same properties that  $B \rightarrow B' \rightarrow B''$  did.  $\square$





**Proof:** Corollary 7.60 plus Proposition 7.55. □

**Corollary 7.62** *If  $\mathbf{A}$  is a pre-Abelian category with enough quasiprojectives, then every cokernel<sup>\*</sup> is a cokernel.*

**Proof:** Suppose  $\mathbf{A}$  is pre-Abelian with enough quasiprojectives. Suppose  $p : B' \rightarrow B''$  is a cokernel<sup>\*</sup>, and suppose  $j : B \rightarrow B'$  is a kernel for  $p$ . We shall show that  $p$  is a cokernel by appealing to Proposition 7.50.

Suppose  $F = \text{Hom}(\bullet, C)$ ,  $C$  an object in  $\mathbf{A}$ .  $F$  is left exact, so  $F$  is naturally isomorphic to  $QL^0F$  by Proposition 7.55. Now  $0 \rightarrow QL^0F(B'') \rightarrow QL^0F(B') \rightarrow QL^0F(B)$  is exact by Corollary 7.59, so  $0 \rightarrow F(B'') \rightarrow F(B') \rightarrow F(B)$  is exact, thus (letting  $C$  vary),  $B' \rightarrow B''$  is a cokernel for  $B \rightarrow B'$  by Proposition 7.50. □

**Example 25**  $R\text{Sh}$ . Note that in

$$\begin{array}{ccc}
 0 & & 0 \\
 \downarrow & & \downarrow \\
 A_1 & \xrightarrow{f_1} & B_1 \\
 \downarrow \varphi & & \downarrow \psi \\
 A_2 & \xrightarrow{f_2} & B_2 \\
 \downarrow \pi & & \downarrow q \\
 A_3 & \xrightarrow{f_3} & B_3 \\
 \downarrow & & \downarrow \\
 0 & & 0
 \end{array}$$

$(f_1, f_2, f_3)$  is a cokernel if and only if  $f_1$ ,  $f_2$ , and  $f_3$  are each epic. (See Exercise 7.) Hence, any (necessarily split) short exact sequence of projectives is quasiprojective by Proposition 6.9. It follows that  $R\text{Sh}$  has enough quasi-projectives, and all the preceding applies.

One not-so-trivial consequence of Corollary 7.62 stands out. It is not hard to see directly from the definition that the composite of two cokernels is a cokernel<sup>\*</sup>, hence a cokernel. Thus, as with “enough projectives,” a balanced pre-Abelian category with enough quasiprojectives must satisfy Ab-epic (see Exercise 11).

## Exercises

1. Suppose  $G$  is a group, and  $H$  is a subgroup. Let  $G/H$  denote the set of left cosets of  $H$ , and let  $*$  denote anything that is not a member of  $G/H$ . Let  $A((G/H) \cup \{*\})$  denote the group of bijections of  $(G/H) \cup \{*\}$ , and define  $\Phi : G \rightarrow A((G/H) \cup \{*\})$  by  $\Phi(x)$  sending  $yH$  to  $xyH$  and  $*$  to itself. Let  $\sigma \in A((G/H) \cup \{*\})$ , exchange  $*$  with the coset  $H$ , and let  $\Psi$  denote the inner automorphism of  $A((G/H) \cup \{*\})$  determined by  $\sigma$ . Show that  $\Phi(x) = \Psi \circ \Phi(x)$  if and only if  $x \in H$ . Use this to show that an epimorphism in the category  $\mathbf{Gr}$  of groups is necessarily onto.
2. Suppose  $\mathbf{C}$  is a category with a zero object  $O$ . Define  $0 \in \text{Hom}(A, B)$  to be the composite  $A \rightarrow O \rightarrow B$ . Show that the definition of  $0$  is independent of the choice of the zero object  $O$ .
3. Suppose  $\mathbf{C}$  is a concrete category in which epimorphisms are onto. Show that free objects in  $\mathbf{C}$  are projective.
4. Let  $\mathbf{C}$  be a category with a zero object  $O$ . Zero morphisms are defined as in Exercise 2. Show for an object  $A$  the following are equivalent:
  - i)  $A$  is a zero object.
  - ii)  $i_A = 0$ .
  - iii)  $O \rightarrow A$  is epic.
  - iv)  $A \rightarrow O$  is monic.
5. (More on why additive categories are often required to contain biproducts.) Suppose  $\mathbf{A}$  is an additive category that contains a biproduct for any two objects. Show that the additive structure on each  $\text{Hom}$  set is unique.

Hint: Let  $\mathbf{A}'$  denote the category  $\mathbf{A}$  with the additive structure perhaps altered. Let  $F : \mathbf{A} \rightarrow \mathbf{A}'$  denote the “identity” functor. Show that  $F$  is additive.

6. Suppose  $\mathbf{A}$  is an additive category, and suppose  $f : A \rightarrow B$  in  $\mathbf{A}$ . Define the category  $\mathbf{B}$ , whose objects are pairs  $(C, g)$  for which  $g : C \rightarrow A$  satisfies  $fg = 0$ , with a morphism from  $(C, g)$  to  $(D, h)$  being a  $\varphi : C \rightarrow D$ , making

$$\begin{array}{ccccc}
 & D & & & \\
 & \nearrow h & & & \\
 & & A & \xrightarrow{f} & B \\
 \varphi \uparrow & & \nearrow g & & \\
 & C & & & 
 \end{array}$$

commute. Show that a kernel of  $f$  is a final object in this category and vice versa.

7. Show that the kernel and cokernel defined for  $R\mathbf{Sh}$  in Section 7.3 actually work. Show that if

$$\begin{array}{ccc}
 0 & & 0 \\
 \downarrow & & \downarrow \\
 B_1 & \xrightarrow{f_1} & C_1 \\
 \downarrow \varphi & & \downarrow \psi \\
 B_2 & \xrightarrow{f_2} & C_2 \\
 \downarrow \pi & & \downarrow \rho \\
 B_3 & \xrightarrow{f_3} & C_3 \\
 \downarrow & & \downarrow \\
 0 & & 0
 \end{array}$$

defines a morphism  $(f_1, f_2, f_3)$  in  $R\mathbf{Sh}$ , then  $(f_1, f_2, f_3)$  is epic  $\Leftrightarrow f_2$  and  $f_3$  are epic, while  $(f_1, f_2, f_3)$  is the cokernel of some other morphism  $\Leftrightarrow f_1, f_2,$  and  $f_3$  are all epic.

8. Show that  $0 \rightarrow P \rightarrow P' \rightarrow P'' \rightarrow 0$  is projective in  $R\mathbf{Sh}$  if and only if  $P = 0$  and  $P' \approx P''$  is projective in  $R\mathbf{M}$ .
9. Suppose  $\mathbf{A}$  is a pre-Abelian category. Show that  $0 \rightarrow A \rightarrow B$  is kernel-exact  $\Leftrightarrow 0 \rightarrow A \rightarrow B$  is cokernel-exact  $\Leftrightarrow A \rightarrow B$  is monic. Also show that  $A \rightarrow B \rightarrow 0$  is kernel-exact  $\Leftrightarrow A \rightarrow B \rightarrow 0$  is cokernel-exact  $\Leftrightarrow A \rightarrow B$  is epic.
10. See Proposition 7.11(b) and its proof. Suppose  $\mathbf{A}$  is a pre-Abelian category that satisfies Ab-monic. If  $f : A \rightarrow B$  is a morphism with cokernel  $q : B \rightarrow D$ , and, if  $f = \widehat{j}\widehat{p}$ , with  $\widehat{p} : A \rightarrow \widehat{C}$  epic and  $\widehat{j} : \widehat{C} \rightarrow B$  monic, show that  $\widehat{j}$  is a kernel for  $q$ , and hence that  $(C, j)$  and  $(\widehat{C}, \widehat{j})$  are isomorphic in the category of Exercise 6.
11. Suppose  $\mathbf{A}$  is a pre-Abelian category. Show that  $\mathbf{A}$  satisfies Ab-monic if and only if  $\mathbf{A}$  is balanced and the composite of two kernels is a kernel. Also show that  $\mathbf{A}$  satisfies Ab-epic if and only if  $\mathbf{A}$  is balanced and the composite of two cokernels is a cokernel.
12. Suppose  $\mathbf{A}$  is an additive category. Show that  $\text{Hom}(A, A)$  is a ring for any object  $A$  in  $\mathbf{A}$ .

13. Suppose  $\mathbf{A}$  is a pre-Abelian category in which  $\varphi : A \rightarrow B$  is a kernel for some morphism. Show that  $\varphi$  is a kernel for any  $\pi : B \rightarrow D$  that is a cokernel for  $\varphi$ . Formulate and prove the corresponding result for cokernels.
14. (Essay question.) Formulate a result which is proven by the proof of Proposition 7.11(b), and which applies directly to Proposition 7.11(b) and to Proposition 7.12, (i)  $\Rightarrow$  (ii).
15. Show that in an Abelian category, the following are equivalent:
- i)  $0 \rightarrow A \rightarrow B \rightarrow C \rightarrow 0$  is exact.
  - ii)  $A \rightarrow B$  is monic, with cokernel  $B \rightarrow C$ .
  - iii)  $B \rightarrow C$  is epic, with kernel  $A \rightarrow B$ .
16. Suppose  $\mathbf{A}$  is a pre-Abelian category with a separating class of projectives. Given a commutative diagram

$$\begin{array}{ccccccc}
 A_1 & \xrightarrow{f_1} & A_2 & \xrightarrow{f_2} & A_3 & \xrightarrow{f_3} & A_4 \\
 \downarrow \varphi_1 & & \downarrow \varphi_2 & & \downarrow \varphi_3 & & \downarrow \varphi_4 \\
 B_1 & \xrightarrow{g_1} & B_2 & \xrightarrow{g_2} & B_3 & \xrightarrow{g_3} & B_4
 \end{array}$$

in  $\mathbf{A}$  with kernel-exact rows, in which  $\varphi_4$  is monic and  $\varphi_1$  is epic, show that  $\varphi_2$  monic  $\Rightarrow \varphi_3$  monic (the monic 4-lemma) and  $\varphi_3$  epic  $\Rightarrow \varphi_2$  epic (the epic 4-lemma).

17. Suppose  $\mathbf{A}$  is an Abelian category in which

$$\begin{array}{ccccc}
 A_1 & \xrightarrow{\varphi} & A_2 & \xrightarrow{\pi} & A_3 \\
 \downarrow f_1 & & \downarrow f_2 & & \downarrow f_3 \\
 B_1 & \xrightarrow{\psi} & B_2 & \xrightarrow{\rho} & B_3
 \end{array}$$

is commutative with underexact rows. Suppose there exists  $D_3 : A_3 \rightarrow B_2$  and  $D_2 : A_2 \rightarrow B_1$  for which  $f_2 = \psi D_2 + D_3 \pi$ . Show that the induced homology map  $(f_2)_*$  is zero.

18. Suppose  $\mathbf{A}$  is an Abelian category in which the diagram

$$\begin{array}{ccccc}
 K & \xrightarrow{j'} & A' & & \\
 \downarrow j & & \downarrow \varphi' & & \\
 A & \xrightarrow{\varphi} & B & \xrightarrow{\psi} & C \\
 & & \downarrow \psi' & & \\
 & & C' & & 
 \end{array}$$



satisfies

- i)  $\varphi$  is a kernel of  $\psi$ ,
- ii)  $\varphi'$  is a kernel of  $\psi'$ , and
- iii)  $j$  is a kernel of  $\psi'\varphi$ .

$j'$  exists since  $\psi'(\varphi j) = 0 \Rightarrow \varphi j$  factors through  $A'$ . Show that  $j' : K \rightarrow A'$  is a kernel for  $\psi\varphi'$ .

Note:  $\varphi j = \varphi' j'$  is often interpreted as the *intersection* of  $\varphi$  and  $\varphi'$ .

Additional exercise. If  $\mathbf{A} = {}_R\mathbf{M}$ , and if  $j, \varphi$ , and  $\varphi'$  are inclusion maps, show that  $K = A \cap A'$ .

19. Prove the 9-lemma: Suppose  $\mathbf{A}$  is an Abelian category in which the diagram

$$\begin{array}{ccccccc}
 & & 0 & & 0 & & 0 \\
 & & \downarrow & & \downarrow & & \downarrow \\
 0 & \longrightarrow & A_{11} & \longrightarrow & A_{12} & \longrightarrow & A_{13} \longrightarrow 0 \\
 & & \downarrow & & \downarrow & & \downarrow \\
 0 & \longrightarrow & A_{21} & \longrightarrow & A_{22} & \longrightarrow & A_{23} \longrightarrow 0 \\
 & & \downarrow & & \downarrow & & \downarrow \\
 0 & \longrightarrow & A_{31} & \longrightarrow & A_{32} & \longrightarrow & A_{33} \longrightarrow 0 \\
 & & \downarrow & & \downarrow & & \downarrow \\
 & & 0 & & 0 & & 0
 \end{array}$$

is commutative, in which all but one of the rows and columns is short exact, and in which all rows and columns are complexes. Show that all rows and columns are exact.

20. Suppose  $\mathbf{A}$  is an Abelian category. Define functors  $\text{Ker}$  and  $\text{Coker}$  as in Section 7.5. If  $\text{Coker}(A, f, B) = (B, \pi, D)$ , set  $\text{Co}(A, f, B) = D$ . That is,  $\text{Co}$  picks off the chosen cokernel object. Similarly, if  $\text{Ker}(A, f, B) = (K, j, A)$ , set  $\text{Ke}(A, f, B) = K$ .

- a) Show that  $\text{Co}$  is right exact from  $\mathbf{A}(\rightarrow)$  to  $\mathbf{A}$ , while  $\text{Ke}$  is left exact.
- b) Suppose  $\mathbf{A}$  has enough projectives. Show that

$$\mathcal{L}_n \text{Co} \approx \left\{ \begin{array}{l} \text{Co, if } n = 0 \\ \text{Ke, if } n = 1 \\ 0, \text{ if } n > 1 \end{array} \right\}.$$

Hence, show that  $(P, f, P')$  cannot possibly be projective in  $\mathbf{A}$  unless  $f$  is monic.

Hint: Dimension shift.

21. a) Show that in any category, coproducts of projectives are projective.  
 b) Show that in a pre-Abelian category, the coproduct of quasiprojectives is quasiprojective.
22. Suppose  $\mathbf{A}$  is a pre-Abelian category. State precisely and prove:  $\mathbf{A}$  is Abelian if and only if for every morphism  $f$ ,  $\ker(\operatorname{coker}(f)) = \operatorname{coker}(\ker(f))$ .
23. Suppose  $\mathbf{A}$  is a pre-Abelian category, and suppose  $f : A \rightarrow B$  is a bimorphism in  $\mathbf{A}$ .
- a) Show that  $f$  is an isomorphism if and only if  $f^* : \operatorname{Hom}(B, C) \rightarrow \operatorname{Hom}(A, C)$  is an isomorphism in  $\mathbf{Ab}$  for all  $C$ .  
 b) Suppose there is a cokernel  $\pi : P \rightarrow B$ , with  $P$  being projective. Show that  $f$  is an isomorphism.  
 c) Compute  $\operatorname{Ext}^0(B, C)$  for  $\mathbf{A} = {}_R\mathbf{Sh}$ . ( $\operatorname{Ext}^n(\bullet, C) = \mathcal{L}^n\operatorname{Hom}(\bullet, C)$ .)
24. Suppose  $\mathbf{A}$  denotes the full subcategory of  $\mathbf{Ab}$  consisting of finitely generated free Abelian groups. Prove that:
- a) A kernel for  $f : A \rightarrow B$  in  $\mathbf{Ab}$  is a kernel for  $f$  in  $\mathbf{A}$ .  
 b) If  $\pi : B \rightarrow C$  is a cokernel for  $f$  in  $\mathbf{Ab}$ , then  $\bar{\pi} : B \rightarrow \bar{C}$  is a cokernel for  $f$  in  $\mathbf{A}$ , where  $\bar{C} = C/T(C)$ . ( $T(C)$  = torsion subgroup.)  
 c)  $f$  is monic  $\Leftrightarrow f$  is one-to-one.  
 d)  $f : A \rightarrow B$  is epic  $\Leftrightarrow B/f(A)$  is finite.  
 e)  $f : A \rightarrow B$  is a kernel  $\Leftrightarrow f$  is one-to-one and  $f(A)$  is a direct summand of  $B$ .  
 f)  $f$  is a cokernel  $\Leftrightarrow f$  is onto.  
 g) Only the zero object is projective or injective.  
 h) Every object is quasiprojective (and quasiinjective, that is, quasiprojective in  $\mathbf{A}^{\text{op}}$ ).
25. Given the situation of Proposition 7.37, that

$$\begin{array}{ccccccc}
 0 & \longrightarrow & A & \xrightarrow{j} & B & \xrightarrow{\pi} & C \longrightarrow 0 \\
 & & \parallel & & \downarrow \psi & & \downarrow \eta \\
 0 & \longrightarrow & A & \xrightarrow{j'} & B' & \xrightarrow{\pi'} & C' \longrightarrow 0
 \end{array}$$

is commutative with short exact rows and monic columns in an Abelian category, prove that  $\psi$  and  $\eta$  have isomorphic cokernels, that is, the natural morphism from a cokernel of  $\psi$  to a cokernel of  $\eta$  is an isomorphism.

Hint: If you set it up right, you can read it off from the 9-lemma, Exercise 19.

26. (Long essay question).

Some results can be interpreted in terms of the “Noether isomorphisms/correspondences.” These are (stated for left  $R$ -modules):

- I. If  $f : A \rightarrow B$  is onto, then  $B \approx A/\ker f$ .
- II. If  $K$  is a submodule of  $A$ , then the correspondence  $H \mapsto H/K$  sets up a bijection between the submodules of  $A$  containing  $K$  and the submodules of  $A/K$ .
- III. If  $H$  is a submodule of  $A$  and  $K$  is a submodule of  $H$ , then  $A/H \approx (A/K)/(H/K)$ .
- IV. If  $H$  and  $K$  are any two submodules of  $A$ , then  $(H + K)/K \approx H/H \cap K$ .

Now in an Abelian category, Ab-epic just interprets I, since if  $f$  is onto, then  $A/\ker f$  is a cokernel (by definition in  ${}_R\mathbf{M}$ ), so  $B \approx A/\ker f$  is also a cokernel.

Interpret II partially in terms of Proposition 7.37 and III in terms of Exercise 25. The rest of II, and an interpretation for IV, appears in Appendix D.

Note: A submodule is interpreted as a monomorphism.



# 8

## Colimits and Tor

### 8.1 Limits and Colimits

Of the two functors defined in Chapter 3,  $\text{Ext}$  is the more “universal”; Section 6.6 describes how  $\text{Tor}$  can, in principle at least, be defined using  $\text{Ext}$ . On the other hand,  $\text{Tor}$  has more properties. Up to now, this has only been reflected in the fact that  $\text{Tor}$  mixes right  $R$ -modules with left  $R$ -modules. But there’s more.  $\text{Tor}$  behaves well with respect to certain colimits, and that is the general subject of this chapter.

A bit about terminology is in order. The terms “limit” and “colimit” replace the older compound terms “inverse limit” and “direct limit,” respectively. There is method to this: Given a concept in a category  $\mathbf{C}$ , the “coconcept” should be the corresponding thing in  $\mathbf{C}^{\text{op}}$ . Moreover, the prefix “co” should be attached to “corresponding” objects; speaking frivolously, “co” should commute with adjectives. To see what this means, consider  $\mathbf{Set}$  and  $\mathbf{Ab}$ . A product in  $\mathbf{Set}$  or  $\mathbf{Ab}$  is an ordinary product, while a coproduct in  $\mathbf{Set}$  is a not-so-ordinary disjoint union, not at all like a direct sum in  $\mathbf{Ab}$ . Consequence: “Product” (without the prefix), the familiar term, has precedence. “Coproduct,” the not-so-familiar term, denotes the direct sum in  $\mathbf{Ab}$  and the disjoint union in  $\mathbf{Set}$ . So far, so good. Now for limits and colimits. The product is a special case of an inverse limit, using old terminology; specifically, it is an unordered inverse limit. In current terminology, the old “inverse limit” is termed a *limit*, and the old direct limit becomes a *colimit*. That way, a product is an unordered limit, while a coproduct is an unordered colimit (rather than a co-unordered limit). “Co” commutes



with “unordered.” (Okay, “Co” commutes with participles.)

Now to what limits and colimits are. The form we use involves a partially ordered index set  $\mathcal{I}$ . (More generally,  $\mathcal{I}$  can be replaced by a small category; see most any book on category theory.) For limits, we assume that we have a function  $i \mapsto A_i$  from  $\mathcal{I}$  to  $\text{obj}\mathbf{C}$ , as well as a  $\phi_{ij} \in \text{Mor}(A_j, A_i)$  whenever  $i < j$ , subject to  $\phi_{ij}\phi_{jk} = \phi_{ik}$  whenever  $i < j < k$ . The pair  $\langle A_i, \phi_{ij} \rangle$  will denote this limiting system. A *limit* (if it exists)  $L = \lim_{\mathcal{I}} A_i$  is defined as follows. There are  $\psi_i \in \text{Mor}(L, A_i)$  such that all diagrams

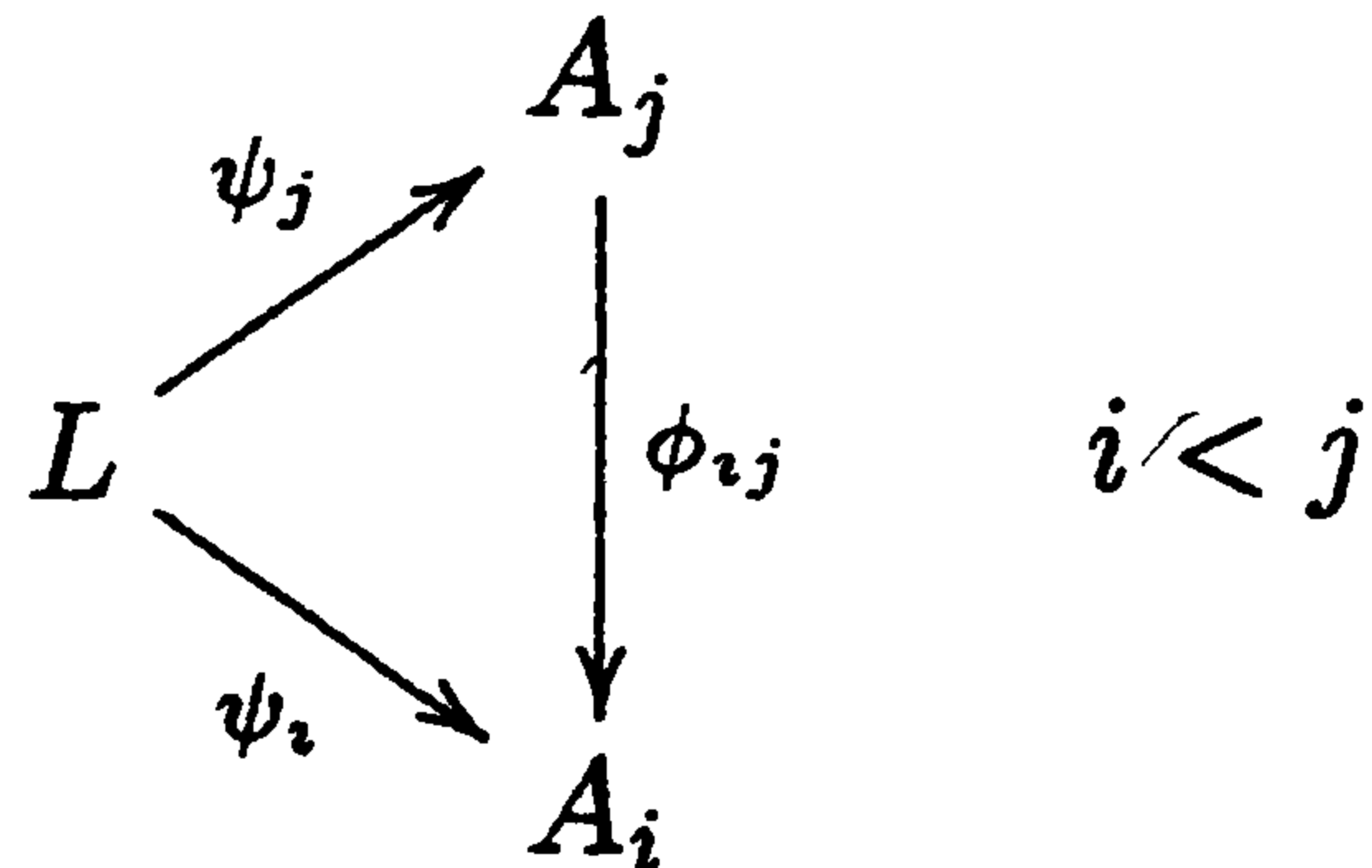

commute, and  $L$  is “universally terminal” with this property: If  $\psi'_i \in \text{Mor}(L', A_i)$  are such that all diagrams

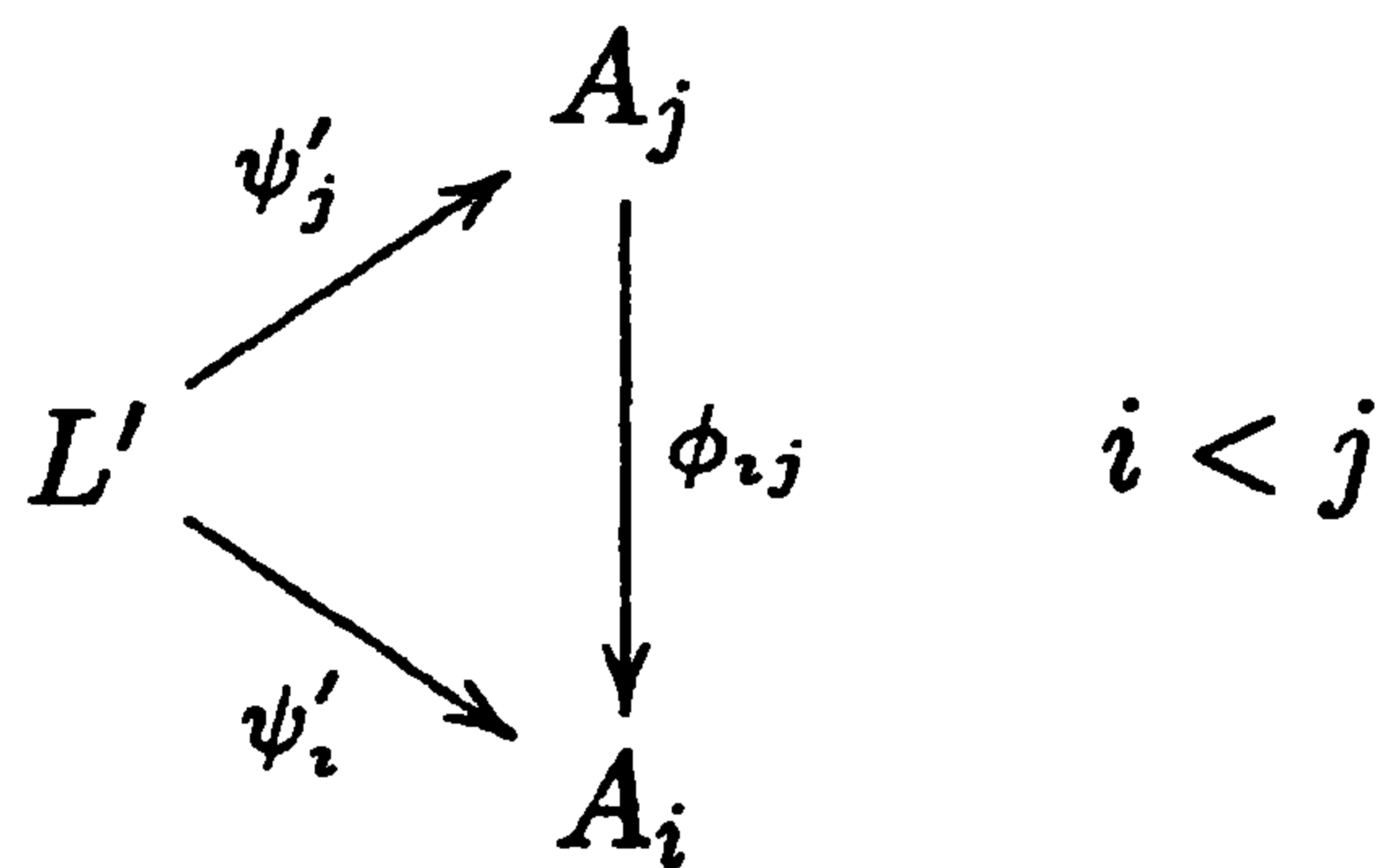

commute, then there is a unique filler  $\Phi \in \text{Mor}(L', L)$  making all diagrams

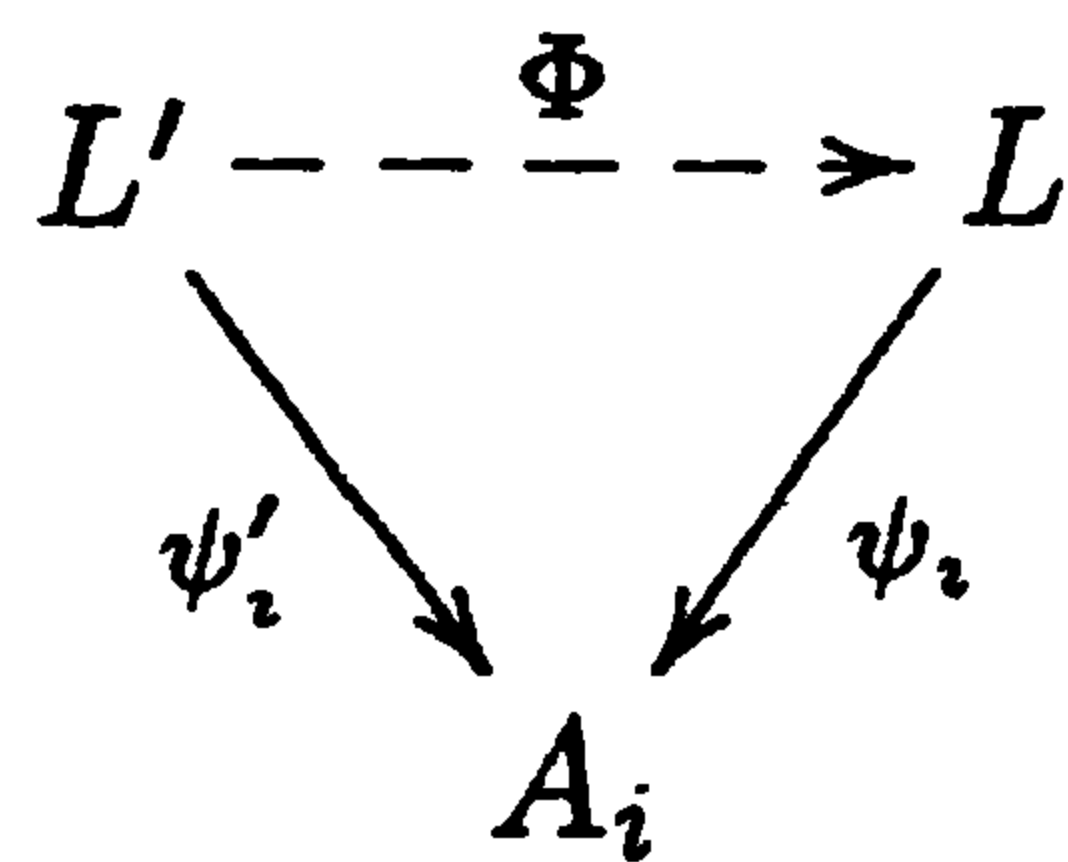

commute. Limits are unique up to isomorphism for the usual reasons.

**Example 26** If  $\mathcal{I}$  is *unordered*, that is, if “ $i < j$ ” is always false, then  $\lim_{\mathcal{I}} A_i = \prod_{\mathcal{I}} A_i$ .

**Example 27** If  $\mathbf{C} = {}_R\mathbf{M}$ ,  $\mathcal{I}$  is totally ordered (“directed” is actually sufficient; see below and Exercise 1), and  $\phi_{ij}$  is set inclusion, where  $i \leq j$  iff  $A_j \subset A_i$ , then  $\lim_{\mathcal{I}} A_i = \bigcap_{\mathcal{I}} A_i$ .

**Definition 8.1**  $\mathcal{I}$  is *directed* when  $\forall i, i' \in \mathcal{I}, \exists j \in \mathcal{I}$  with  $j \geq i, j \geq i'$ . An element  $i \in \mathcal{I}$  is *maximal* if “ $i < j$ ” is false for all  $j \in \mathcal{I}$ .  $i_0$  is *largest* if  $i_0 \geq j$  is true  $\forall j \in \mathcal{I}$ .

Note that if  $\mathcal{I}$  is directed, then any maximal element is largest. Also, in general, if  $\mathcal{I}$  has a largest element  $i_0$ , then  $\lim_{\mathcal{I}} A_i = A_{i_0}$  (see Corollary 8.4).

Now for colimits. Here, we wish  $\operatorname{colim}_{\mathcal{I}}$  in  $\mathbf{C}$  to coincide with  $\lim_{\mathcal{I}}$  in  $\mathbf{C}^{\text{op}}$ .  $\mathcal{I}$  is unchanged; we have a function  $i \mapsto A_i$  from  $\mathcal{I}$  to  $\operatorname{obj} \mathbf{C}$ , as well as a  $\phi_{ij} \in \operatorname{Mor}(A_i, A_j)$  whenever  $i < j$  (Take particular notice! The positions of  $A_i$  and  $A_j$  are reversed from their positions for limits.) subject to  $\phi_{jk}\phi_{ij} = \phi_{ik}$  whenever  $i < j < k$ . Again, the pair  $\langle A_i, \phi_{ij} \rangle$  will denote a “colimiting system.” A *colimit* (if it exists)  $C = \operatorname{colim}_{\mathcal{I}} A_i$  is defined as follows. There are  $\psi_i \in \operatorname{Mor}(A_i, C)$  such that all diagrams

$$\begin{array}{ccc}
 & A_j & \\
 \psi_j \swarrow & & \uparrow \phi_{ij} \\
 C & & A_i \\
 \psi_i \swarrow & & \\
 & & 
 \end{array} \quad i < j$$

commute, and  $C$  is “universally initial” with this property: If  $\psi'_i \in \operatorname{Mor}(A_i, C')$  are such that all diagrams

$$\begin{array}{ccc}
 & A_j & \\
 \psi'_j \swarrow & & \uparrow \phi_{ij} \\
 C' & & A_i \\
 \psi'_i \swarrow & & \\
 & & 
 \end{array} \quad i < j$$

commute, then there is a unique filler  $\Phi \in \operatorname{Mor}(C, C')$  making all diagrams

$$\begin{array}{ccc}
 C' & \xleftarrow{\Phi} & C \\
 \psi'_i \swarrow & & \swarrow \psi_i \\
 & A_i & 
 \end{array}$$

commute. Colimits are unique up to isomorphism for the usual reasons.

By the way, the term “ $\mathcal{I}$ -cotarget” will be used for  $\langle C', \psi'_i \rangle$  as well as  $\langle C, \psi_i \rangle$ . For limits,  $\langle L', \psi'_i \rangle$  and  $\langle L, \psi_i \rangle$  will be called “ $\mathcal{I}$ -targets.” These terms are not standard, but we need words for them.

**Example 28** If  $\mathcal{I}$  is unordered, then  $\operatorname{colim}_{\mathcal{I}} A_i$  is the coproduct of the  $A_i$ .

**Example 29** If  $C = {}_R\mathbf{M}$ ,  $\mathcal{I}$  is directed, and  $\phi_{ij}$  is set inclusion, where  $i \leq j$  when  $A_i \subset A_j$  (and all  $A_i \subset$  some fixed  $A$ ), then  $\operatorname{colim}_{\mathcal{I}} A_i = \bigcup_{\mathcal{I}} A_i$ .

A point worth remarking on. For both limits and colimits, the direction in which the limits are taken is  $+\infty$ , that is, things *increase*. This is particularly the case with our limits once called “inverse limits,” which do not go

to  $-\infty$ ; they do, however, go toward the “tails” of the  $\phi_{ij}$  arrows. Also, our focus eventually will be on *directed colimits*, that is, colimits over directed sets. In the old terminology, these were “direct limits over directed sets,” a phrase to which the mind reacts at first sight with a profound “Huh? Isn’t that redundant?”

Recall that if  $\mathcal{J}$  is a subset of a partially ordered set  $\mathcal{I}$ , then  $\mathcal{J}$  is *cofinal* if  $\forall i \in \mathcal{I}, \exists j \in \mathcal{J}$  with  $j \geq i$ . Also, for notational convenience, set  $\psi_{ii} = i_{A_i}$ , when  $i \in \mathcal{I}$ .

**Proposition 8.2** *Suppose  $\mathcal{I}$  is directed, and suppose  $\mathcal{J}$  is cofinal in  $\mathcal{I}$ . Then  $\mathcal{J}$  is directed, and for any limiting system  $\langle A_i, \phi_{ij} \rangle$  on  $\mathcal{I}$ ,*

$$\lim_{\mathcal{I}} A_i = \lim_{\mathcal{J}} A_i,$$

*that is, if either exists, then it is a model for the other.*

**Proof:** First,  $\mathcal{J}$  is directed: If  $i, j \in \mathcal{J}$ , then  $\exists k \in \mathcal{I}$  with  $k \geq i, k \geq j$ , since  $\mathcal{I}$  is directed. But  $\exists l \in \mathcal{J}$  with  $l \geq k$ , since  $\mathcal{J}$  is cofinal. But now  $l \geq i, l \geq j$ .

Next, any  $\mathcal{J}$ -target extends uniquely to an  $\mathcal{I}$ -target. Suppose we are given  $L \in \text{obj}\mathbf{C}$ , and  $\psi_j \in \text{Mor}(L, A_j)$  whenever  $j \in \mathcal{J}$ , with  $\psi_j = \phi_{jk}\psi_k$  when  $j < k$  in  $\mathcal{J}$ ; that is, suppose  $\langle L, \psi_j \rangle$  is a  $\mathcal{J}$ -target. Suppose  $i \in \mathcal{I}$ . Define  $\psi_i$  as  $\phi_{ij}\psi_j$  for any  $j \in \mathcal{J}, j \geq i$ . (This is forced.) The first claim is that this definition is independent of the choice of  $j$ . (This is the point where “ $\mathcal{I}$  is directed” is used.) The reason is this. Suppose also  $i \leq k, k \in \mathcal{J}$ . Since  $\mathcal{J}$  is directed,  $\exists l \in \mathcal{J}, l \geq j, l \geq k$ . But now

$$\phi_{ij}\psi_j = \phi_{ij}\phi_{jl}\psi_l = \phi_{il}\psi_l = \phi_{ik}\phi_{kl}\psi_l = \phi_{ik}\psi_k.$$

The second claim is that these  $\psi_i$  satisfy  $\psi_i = \phi_{ij}\psi_j$  for any  $i < j, i, j \in \mathcal{I}$ . To this end, choose  $k \in \mathcal{J}, k \geq j$ . Then

$$\phi_{ij}\psi_j = \phi_{ij}\phi_{jk}\psi_k = \phi_{ik}\psi_k = \psi_i.$$

Now suppose  $L = \lim_{\mathcal{I}} A_i$  exists, and suppose  $\langle L', \psi'_j \rangle$  is a  $\mathcal{J}$ -target. Define  $\psi'_i, i \in \mathcal{I}$  as above, via  $\psi'_i = \phi_{ij}\psi'_j, j \in \mathcal{J}, j \geq i$ , extending  $\langle L', \psi'_j \rangle$  to an  $\mathcal{I}$ -target. Note that the  $\psi'_i$  are data that produce a (unique)  $\Phi \in \text{Mor}(L', L)$  such that  $\psi'_i = \psi_i\Phi$  for  $i \in \mathcal{I}$ . This  $\Phi$  is also unique subject to  $\psi'_j = \psi_j\Phi$  for  $j \in \mathcal{J}$ , since if  $\Phi' \in \text{Mor}(L', L)$  satisfied  $\psi'_j = \psi_j\Phi'$  for  $j \in \mathcal{J}$ , then one would have  $\psi'_i = \phi_{ij}\psi'_j = \phi_{ij}\psi_j\Phi' = \psi_i\Phi'$  for all  $i \in \mathcal{I}$  (choosing, for each  $i$ , a  $j \in \mathcal{J}, j \geq i$ ), from which  $\Phi' = \Phi$ .

Finally, suppose  $L = \lim_{\mathcal{J}} A_i$  exists. Extend the  $\mathcal{J}$ -target  $\langle L, \psi_j \rangle$  to an  $\mathcal{I}$ -target  $\langle L, \psi_i \rangle$ . The claim is that these define  $L$  to be  $\lim_{\mathcal{I}} A_i$ . Suppose  $\psi'_i \in \text{Mor}(L', A_i), i \in \mathcal{I}$ . There is a unique  $\Phi$  satisfying  $\psi_j\Phi = \psi'_j$  for  $j \in \mathcal{J}$ . It suffices to show that  $\psi_i\Phi = \psi'_i$  for  $i \in \mathcal{I}$ , since  $\Phi$  will then be the unique morphism satisfying this broader class of formulas. But if  $i \in \mathcal{I}$ , choose  $j \in \mathcal{J}, j \geq i$ :  $\psi_i\Phi = \phi_{ij}\psi_j\Phi = \phi_{ij}\psi'_j = \psi'_i$ .  $\square$

**Corollary 8.3** *Suppose  $\mathcal{I}$  is directed, and suppose  $\mathcal{J}$  is cofinal in  $\mathcal{I}$ . Then  $\mathcal{J}$  is directed, and for any colimiting system  $\langle A_i, \phi_{ij} \rangle$  on  $\mathcal{I}$ ,*

$$\operatorname{colim}_{\mathcal{I}} A_i = \operatorname{colim}_{\mathcal{J}} A_i,$$

*that is, if either exists, then it is a model for the other.*

**Proof:** Proposition 8.2 in  $\mathbf{C}^{\text{op}}$ . □

**Corollary 8.4** *Suppose  $\mathcal{I}$  has a largest element  $i_0$ . Then  $\lim_{\mathcal{I}} A_i = A_{i_0}$ .*

**Proof:**  $\mathcal{I}$  is directed, since if  $i, j \in \mathcal{I}$ , then  $i_0 \geq i$  and  $i_0 \geq j$ . Set  $\mathcal{J} = \{i_0\}$ ; this  $\mathcal{J}$  is cofinal. □

**Proposition 8.5** *Arbitrary limits and colimits exist in  $\mathbf{RM}$ .*

**Proof:** One may define  $\lim_{\mathcal{I}} A_i$  to be a submodule  $L$  of  $\prod_{\mathcal{I}} A_i$  defined as

$$L = \{ \langle a_i \rangle \in \prod_{i \in \mathcal{I}} A_i : \phi_{ij}(a_j) = a_i \text{ for } i < j \}.$$

Set  $\psi_j(\langle a_i \rangle) = a_j$ . By definition of  $L$ ,  $\phi_{jk}\psi_k(\langle a_i \rangle) = \phi_{jk}(a_k) = a_j = \psi_j(\langle a_i \rangle)$ . Also, given an  $\mathcal{I}$ -target  $\langle L', \psi'_i \rangle$ , one notes that  $\langle \psi'_i(x) \rangle \in L$  for all  $x \in L'$  (since  $\psi'_i = \phi_{ij}\psi'_j$  for  $i < j$ ), so one may set  $\Phi(x) = \langle \psi'_i(x) \rangle$ .

As for colimits, set  $C$  to be the quotient module

$$C = (\bigoplus_{i \in \mathcal{I}} A_i) / B$$

where  $B$  is generated by all  $\delta_{jk}(x)$ , where one defines for  $j < k$  and  $x \in A_j$ ,

$$\delta_{jk}(x) \in \bigoplus_{i \in \mathcal{I}} A_i$$

$$\delta_{jk}(x) = \langle a_i \rangle, \text{ and } a_i = \begin{cases} x, & \text{if } i = j \\ -\phi_{jk}(x), & \text{if } i = k \\ 0, & \text{otherwise.} \end{cases}$$

One defines  $\hat{\psi}_j \in \operatorname{Mor}(A_j, \bigoplus_{\mathcal{I}} A_i)$  as the natural map  $A_j \rightarrow \bigoplus_{\mathcal{I}} A_i$ , and  $\psi_j = \pi \hat{\psi}_j$ , where  $\pi : \bigoplus_{\mathcal{I}} A_i \rightarrow C$  is the quotient map. Note that if  $j < k$ , and  $x \in A_j$ , then  $\hat{\psi}_j(x) - \hat{\psi}_k \phi_{jk}(x) = \delta_{jk}(x) \in B$ , so that  $\psi_j(x) - \psi_k \phi_{jk}(x) = 0$ , that is,  $\psi_j(x) = \psi_k \phi_{jk}(x)$ . Given  $\psi'_j : A_j \rightarrow C'$  subject to  $\psi'_j \phi_{ij} = \psi'_i$ , we have simply from the  $\psi'_j$  alone a unique  $\hat{\Phi} : \bigoplus_{\mathcal{I}} A_i \rightarrow C'$  defined by  $\hat{\Phi}(\langle a_i \rangle) = \sum_{\mathcal{I}} \psi'_i(a_i)$ . It suffices, since  $\bigoplus_{\mathcal{I}} A_i \rightarrow C$  is onto, to show that this  $\hat{\Phi}$  kills  $B$ , that is, that  $\hat{\Phi}(\delta_{jk}(x)) = 0$  for all  $j < k$ ,  $x \in A_j$ . But  $\hat{\Phi}(\delta_{jk}(x)) = \psi'_j(x) + \psi'_k(-\phi_{jk}(x)) = \psi'_j(x) - \psi'_k \phi_{jk}(x) = 0$ . □

There is a corollary to the above construction which isolates why directed colimits are of such special significance, but we shall have to wait until the next section to see how tensor products interact with them.



**Proposition 8.6** *Suppose  $\mathcal{I}$  is directed, and suppose  $\langle A_i, \phi_{ij} \rangle$  is a colimiting system on  $\mathcal{I}$  in  $R\mathbf{M}$ . Form  $C = \text{colim}_{\mathcal{I}} A_i$  as in the proof of Proposition 8.5, as  $(\bigoplus_{\mathcal{I}} A_i)/B$ . Suppose  $\langle a_i \rangle \in \bigoplus_{\mathcal{I}} A_i$ . Set  $S(\langle a_i \rangle) = \{i : a_i \neq 0\}$ . Then  $\langle a_i \rangle \in B$  if and only if  $\exists k \in \mathcal{I}$  such that  $k \geq i$  for all  $i \in S(\langle a_i \rangle)$ , and  $\sum_{i \in S(\langle a_i \rangle)} \phi_{ik}(a_i) = 0$  in  $A_k$ .*

**Remark:** The set  $S(\langle a_i \rangle)$  is finite; the ability to even produce  $k$  requires  $\mathcal{I}$  to be directed. Also, there is no version of this for  $\text{lim}_{\mathcal{I}}$  since it is not defined as a quotient.

**Proof:** The proof is most easily completed by making a series of observations. For this purpose, given  $\langle a_i \rangle \in \bigoplus_{\mathcal{I}} A_i$ , say that  $\langle a_i \rangle$  has property  $P$  if  $\exists k \geq i$  for all  $i \in S(\langle a_i \rangle)$  such that  $\sum_{i \in S(\langle a_i \rangle)} \phi_{ik}(a_i) = 0$  in  $A_k$ .

1. Every  $\delta_{jk}(x)$  has property  $P$ .

This is because  $S(\langle a_i \rangle) \subset \{j, k\}$ , and one may use  $k$  for the top index:  $\phi_{jk}(a_j) + \phi_{kk}(-\phi_{jk}(a_j)) = 0$ .

2. The set of  $\langle a_i \rangle$  satisfying property  $P$  forms a submodule of  $\bigoplus_{\mathcal{I}} A_i$ .

This is where “directed” comes in. First note that  $\sum \phi_{ik}(a_i) = 0 \Rightarrow \sum \phi_{ik}(ra_i) = 0$  for  $r \in R$ , so the set of  $\langle a_i \rangle$  satisfying property  $P$  is closed under  $R$ -multiplication. It therefore suffices to show that it is closed under addition, that is, if  $\langle a_i \rangle$  and  $\langle a'_i \rangle$  satisfy property  $P$ , then so does  $\langle a_i + a'_i \rangle$ . Choose  $k \geq i$  for all  $i \in S(\langle a_i \rangle)$ , so that  $\sum_{i \in S(\langle a_i \rangle)} \phi_{ik}(a_i) = 0$ , and choose  $l \geq i$  for all  $i \in S(\langle a'_i \rangle)$ , so that  $\sum_{i \in S(\langle a'_i \rangle)} \phi_{il}(a'_i) = 0$ . Finally, choose  $m \in \mathcal{I}$ ,  $m \geq k$ ,  $m \geq l$  (possible since  $\mathcal{I}$  is directed). Note that  $S(\langle a_i + a'_i \rangle) \subset S(\langle a_i \rangle) \cup S(\langle a'_i \rangle)$ , and  $m \geq i$  for all  $i \in S(\langle a_i \rangle) \cup S(\langle a'_i \rangle)$ . Also,

$$\begin{aligned} \sum_{i \in S(\langle a_i \rangle) \cup S(\langle a'_i \rangle)} \phi_{im}(a_i + a'_i) &= \sum_{i \in S(\langle a_i \rangle)} \phi_{im}(a_i) + \sum_{i \in S(\langle a'_i \rangle)} \phi_{im}(a'_i) \\ &= \phi_{km} \left( \sum_{i \in S(\langle a_i \rangle)} \phi_{ik}(a_i) \right) \\ &\quad + \phi_{lm} \left( \sum_{i \in S(\langle a'_i \rangle)} \phi_{il}(a'_i) \right) \\ &= 0. \end{aligned}$$

3. Every  $\langle a_i \rangle$  having property  $P$  is a finite sum of elements of the form  $\delta_{jk}(x)$ .

To see this, note that if  $j$  is such that  $\sum_{i \in S(\langle a_i \rangle)} \phi_{ij}(a_i) = 0$ , then one can set  $S' = S(\langle a_i \rangle) - \{j\}$ , for which  $a_j + \sum_{i \in S'} \phi_{ij}(a_i) = 0$  whether  $a_j = 0$  or not. But this means that  $a_j = -\sum_{i \in S'} \phi_{ij}(a_i)$ , so that  $\langle a_i \rangle = \sum_{i \in S'} \delta_{ij}(a_i)$ .

But now we're done. Set

$$B' = \{ \langle a_i \rangle \in \bigoplus_{\mathcal{I}} A_i : \langle a_i \rangle \text{ has property } P \}.$$

Statement 2 says that  $B'$  is a submodule, in view of which Statement 1 says that  $B \subset B'$ . But Statement 3 says that  $B' \subset B$ .  $\square$



While on the subject of limits and colimits, two examples should be defined for later use. Suppose  $\mathcal{I} = \{0, a, b\}$ , where  $0 < a, 0 < b$ , and  $a$  is unrelated to  $b$ . A limiting system on  $\mathcal{I}$  looks like

$$\begin{array}{ccc} & & A_a \\ & & \downarrow \phi_{0a} \\ A_b & \xrightarrow{\phi_{0b}} & A_0 \end{array}$$

The limit in this case is called a *pullback*:

$$\begin{array}{ccc} L & \xrightarrow{\psi_a} & A_a \\ \psi_b \downarrow & \searrow \psi_0 & \downarrow \phi_{0a} \\ A_b & \xrightarrow{\phi_{0b}} & A_0 \end{array}$$

Since  $\psi_0 = \phi_{0a}\psi_a = \phi_{0b}\psi_b$ , the morphism  $\psi_0$  is usually left out.  $L$  is universal, in the sense that, given  $\psi'_i : L' \rightarrow A_i$  such that  $\phi_{0a}\psi'_a = \psi'_0 = \phi_{0b}\psi'_b$  (so  $\psi'_0$  can also be deleted), there is a unique filler from  $L'$  to  $L$ :

$$\begin{array}{ccccc} L' & & & & \\ & \searrow \psi'_a & & & \\ & & L & \xrightarrow{\psi_a} & A_0 \\ & \searrow \psi'_b & \downarrow \psi_b & & \downarrow \phi_{0a} \\ & & A_b & \xrightarrow{\phi_{0b}} & A_0 \end{array}$$

When this happens, the limit  $L$  is called a *pullback*, and

$$\begin{array}{ccc} L & \xrightarrow{\psi_a} & A_a \\ \psi_b \downarrow & & \downarrow \phi_{0a} \\ A_b & \xrightarrow{\phi_{0b}} & A_0 \end{array}$$

is called a *pullback square*.

Similarly, for colimits, a copullback is called a *pushout*:

$$\begin{array}{ccc} A_0 & \xrightarrow{\phi_{0a}} & A_a \\ \phi_{0b} \downarrow & & \downarrow \psi_a \\ A_b & \xrightarrow{\psi_b} & C \end{array}$$

and this square is called a *pushout square*.

Again, specialize to  $R\mathbf{M}$ . For later use, we record here that

$$A \xrightarrow{\phi} B \xrightarrow{\pi} C \rightarrow 0$$

is exact if and only if

$$\begin{array}{ccc} A & \xrightarrow{\phi} & B \\ \downarrow 0 & & \downarrow \pi \\ 0 & \xrightarrow{0} & C \end{array}$$

is a pushout square. (See Exercise 2.) Consequently, any covariant functor that preserves all colimits must necessarily be right exact, as well as additive. In the next section, we shall see a condition that guarantees this.

## 8.2 Adjoint Functors

Adjoint functors constitute an abstraction of such things as free objects, or tensor products in Theorem 2.4. Consider free objects first. Suppose  $\mathbf{C}$  is a concrete category, with  $\sigma(A)$  denoting the underlying set of  $A$ , where any  $f \in \text{Mor}_{\mathbf{C}}(A, B)$  is a function from  $\sigma(A)$  to  $\sigma(B)$ . The first step is to observe that

$$\begin{aligned} A &\mapsto \sigma(A) \\ f &\mapsto f \end{aligned}$$

constitutes a functor, in fact a *faithful* (i.e., one-to-one on each morphism set) functor from  $\mathbf{C}$  to  $\mathbf{Set}$ . Furthermore, one could *define* a concrete category to be a category pre-equipped with a faithful functor  $\sigma$  to  $\mathbf{Set}$ . MacLane [52] does this. One may then replace each morphism set with its image under  $\sigma$ . (Some even define a concrete category to be a category  $\mathbf{C}$  for which there exists a faithful functor to  $\mathbf{Set}$ , but this has the unpleasant side effect that any small category would be concrete: If  $\mathbf{C}$  is a small category in which morphism sets have been arranged to be disjoint, then one can send any object  $A$  to  $\bigcup_{X \in \mathbf{C}} \text{Mor}(X, A)$  and  $f \in \text{Mor}(A, B)$  to  $f_*$ .)

Now suppose to each  $S$  we can associate a free object  $F(S)$  in  $\mathbf{C}$ . The defining characteristic of  $F(S)$  is that morphisms from  $F(S)$  to any  $B$  correspond to functions from  $S$  to  $\sigma(B)$ , that is,

$$\text{Mor}_{\mathbf{C}}(F(S), B) \approx \text{Mor}_{\mathbf{Set}}(S, \sigma(B)).$$

This is the property that adjoint functors have. In what follows there are two covariant functors, say  $F$  and  $\widehat{F}$ , which stand in a similar relationship.

Before going into detail, the order is significant:  $F$  will be a left adjoint, and  $\widehat{F}$  will be a right adjoint. (This is *not* like adjoint matrices. Exercise 4 exhibits a particularly transparent example.) Traditionally (and a bit deceptively),  $(F, \widehat{F})$  will be called an *adjoint pair*. Furthermore,  $F$  and  $\widehat{F}$  (and later  $\widehat{C}$  and  $C$ ) need have no particular relationship other than adjointness; this notation is chosen so the reader can see at a glance where objects and morphisms lie: If it wears a hat, it's in  $\widehat{C}$ ; if not . . . .

The situation is this. We have two categories  $\widehat{C}$  and  $C$ . (Note the order.) There are actually three pieces of data, two of which are  $F$  and  $\widehat{F}$ . We assume we are given:

- i) A covariant functor  $F : \widehat{C} \rightarrow C$ ,
- ii) A covariant functor  $\widehat{F} : C \rightarrow \widehat{C}$ , and
- iii) A naturally defined bijection between

$$\text{Mor}_{\widehat{C}}(\widehat{B}, \widehat{F}(C)) \quad \text{and} \quad \text{Mor}_C(F(\widehat{B}), C)$$

that is, a function  $(\widehat{B}, C) \mapsto \sigma_{\widehat{B}, C}$ , with domain  $\text{obj}\widehat{C} \times \text{obj}C$  such that

$$\sigma_{\widehat{B}, C} : \text{Mor}_{\widehat{C}}(\widehat{B}, \widehat{F}(C)) \rightarrow \text{Mor}_C(F(\widehat{B}), C)$$

is a bijection, and

- iii a)  $\forall \widehat{f} \in \text{Mor}_{\widehat{C}}(\widehat{B}, \widehat{B}')$ , the diagram

$$\begin{array}{ccc} \text{Mor}_{\widehat{C}}(\widehat{B}, \widehat{F}(C)) & \xrightarrow{\sigma_{\widehat{B}, C}} & \text{Mor}_C(F(\widehat{B}), C) \\ \widehat{f}^* \uparrow & & \uparrow F(\widehat{f})^* \\ \text{Mor}_{\widehat{C}}(\widehat{B}', \widehat{F}(C)) & \xrightarrow{\sigma_{\widehat{B}', C}} & \text{Mor}_C(F(\widehat{B}'), C) \end{array}$$

commutes.

- iii b)  $\forall g \in \text{Mor}_C(C, C')$ , the diagram

$$\begin{array}{ccc} \text{Mor}_{\widehat{C}}(\widehat{B}, \widehat{F}(C)) & \xrightarrow{\sigma_{\widehat{B}, C}} & \text{Mor}_C(F(\widehat{B}), C) \\ \widehat{F}(g)_* \downarrow & & \downarrow g_* \\ \text{Mor}_{\widehat{C}}(\widehat{B}, \widehat{F}(C')) & \xrightarrow{\sigma_{\widehat{B}, C'}} & \text{Mor}_C(F(\widehat{B}), C') \end{array}$$

commutes.

**Example 30** Suppose  $\widehat{C} = {}_R M$ , and  $C = \text{Ab}$ . Fix  $A \in M_R$ . Define

$$F : {}_R M \rightarrow \text{Ab} \text{ via } F(B) = A \otimes_R B$$

and

$$\widehat{F} : \mathbf{Ab} \rightarrow {}_R\mathbf{M} \text{ via } \widehat{F}(G) = \text{Hom}_{\mathbf{Z}}(A, G).$$

Theorem 2.4 says that  $\text{Hom}_{\mathbf{Z}}(F(B), G) \approx \text{Hom}_R(B, \widehat{F}(G))$ , while Theorem 2.4(a) verifies condition (iii a) and Theorem 2.4(c) verifies condition (iii b).

By the way, there is a hidden symmetry in all this. If  $(F, \widehat{F})$  is an adjoint pair of functors between  $\widehat{\mathbf{C}}$  and  $\mathbf{C}$ , then  $(\widehat{F}, F)$  is an adjoint pair of functors between  $\mathbf{C}^{\text{op}}$  and  $\widehat{\mathbf{C}}^{\text{op}}$ . (See Exercise 3.) One may thus obtain results about right adjoints from results about left adjoints. In general, a covariant functor  $F : \widehat{\mathbf{C}} \rightarrow \mathbf{C}$  will be called a *left adjoint* if there exists a covariant functor  $\widehat{F} : \mathbf{C} \rightarrow \widehat{\mathbf{C}}$  for which  $(F, \widehat{F})$  is an adjoint pair. Similarly,  $\widehat{F}$  is called a *right adjoint* if  $(F, \widehat{F})$  is an adjoint pair for some  $F$ .

At this point, we know that  $A \otimes_R$  is a left adjoint from  ${}_R\mathbf{M}$  to  $\mathbf{Ab}$ , and the focus is on the consequences for  $\otimes$  and  $\text{Tor}$ . The main result is the following.

**Proposition 8.7** *Suppose  $F$  is a left adjoint functor from a category  $\widehat{\mathbf{C}}$  to a category  $\mathbf{C}$ . Suppose that  $\mathcal{I}$  is partially ordered, and  $\langle \widehat{B}_i, \widehat{\phi}_{ij} \rangle$  is a colimiting system in  $\widehat{\mathbf{C}}$  on  $\mathcal{I}$  which has a colimit  $\widehat{B} = \text{colim}_{\mathcal{I}} \widehat{B}_i$ , with morphisms  $\widehat{\psi}_i \in \text{Mor}(\widehat{B}_i, \widehat{B})$ . Then  $F(\widehat{B})$  (with the morphisms  $F(\widehat{\psi}_i)$ ) constitute a colimit for  $\langle F(\widehat{B}_i), F(\widehat{\phi}_{ij}) \rangle$ , that is,*

$$F(\text{colim}_{\mathcal{I}} \widehat{B}_i) = \text{colim}_{\mathcal{I}} F(\widehat{B}_i).$$

**Proof:** We have commutative diagrams

$$\begin{array}{ccc}
 & & F(\widehat{B}_j) \\
 & \swarrow^{F(\widehat{\psi}_j)} & \uparrow^{F(\widehat{\phi}_{ij})} \\
 F(\widehat{B}) & & \\
 & \nwarrow_{F(\widehat{\psi}_i)} & \\
 & & F(\widehat{B}_i)
 \end{array}$$

so that given commutative diagrams

$$\begin{array}{ccc}
 & & F(\widehat{B}_j) \\
 & \swarrow^{\psi_j} & \uparrow^{F(\widehat{\phi}_{ij})} \\
 \mathbf{C} & & \\
 & \nwarrow_{\psi_i} & \\
 & & F(\widehat{B}_i)
 \end{array}$$

all we have to do is find a unique filler  $\Phi$  for all diagrams

$$\begin{array}{ccc}
 C & \xleftarrow{\quad \Phi \quad} & F(\widehat{B}) \\
 \psi_i \swarrow & & \nearrow F(\widehat{\psi}_i) \\
 & F(\widehat{B}_i) &
 \end{array}$$

To do this, note that (including  $\widehat{F}$  and  $\sigma$  in our data) we have from (iii a) a commutative diagram

$$\begin{array}{ccc}
 \text{Mor}_C(F(\widehat{B}_j), C) & \xrightarrow{\sigma_{\widehat{B}_j, C}^{-1}} & \text{Mor}_{\widehat{C}}(\widehat{B}_j, \widehat{F}(C)) \\
 F(\widehat{\phi}_{ij})^* \downarrow & & \downarrow \widehat{\phi}_{ij}^* \\
 \text{Mor}_C(F(\widehat{B}_i), C) & \xrightarrow{\sigma_{\widehat{B}_i, C}^{-1}} & \text{Mor}_{\widehat{C}}(\widehat{B}_i, \widehat{F}(C))
 \end{array}$$

so that

$$\sigma_{\widehat{B}_i, C}^{-1} F(\widehat{\phi}_{ij})^*(\psi_j) = \widehat{\phi}_{ij}^* \sigma_{\widehat{B}_j, C}^{-1}(\psi_j)$$

that is,

$$\sigma_{\widehat{B}_i, C}^{-1}(\psi_j F(\widehat{\phi}_{ij})) = (\sigma_{\widehat{B}_j, C}^{-1}(\psi_j)) \widehat{\phi}_{ij}.$$

Now  $\psi_j F(\widehat{\phi}_{ij}) = \psi_i$ , so we get

$$\sigma_{\widehat{B}_i, C}^{-1}(\psi_i) = \sigma_{\widehat{B}_j, C}^{-1}(\psi_j) \widehat{\phi}_{ij},$$

that is, the diagrams

$$\begin{array}{ccc}
 & \widehat{B}_j & \\
 \sigma_{\widehat{B}_j, C}^{-1}(\psi_j) \swarrow & & \nearrow \widehat{\phi}_{ij} \\
 \widehat{F}(C) & & \\
 \sigma_{\widehat{B}_i, C}^{-1}(\psi_i) \swarrow & & \nearrow \\
 & \widehat{B}_i &
 \end{array}$$

all commute. Hence, there is a unique  $\widehat{\Psi}_0 \in \text{Mor}_{\widehat{C}}(\widehat{B}, \widehat{F}(C))$  making all

$$\begin{array}{ccc}
 \widehat{F}(C) & \xleftarrow{\quad \widehat{\Psi}_0 \quad} & \widehat{B} \\
 \sigma_{\widehat{B}_i, C}^{-1}(\psi_i) \swarrow & & \nearrow \widehat{\psi}_i \\
 & \widehat{B}_i &
 \end{array}$$



commute. Our final claim is that for any  $\widehat{\Psi} \in \text{Mor}_{\widehat{C}}(\widehat{B}, \widehat{F}(C))$ ,

$$\begin{array}{ccc}
 \widehat{F}(C) & \xleftarrow{\widehat{\Psi}} & \widehat{B} \\
 \sigma_{\widehat{B}_i, C}^{-1}(\psi_i) \swarrow & & \nearrow \widehat{\psi}_i \\
 & \widehat{B}_i &
 \end{array}$$

commutes for all  $i$  if and only if

$$\begin{array}{ccc}
 C & \xleftarrow{\sigma_{B, C}(\widehat{\Psi})} & F(\widehat{B}) \\
 \psi_i \swarrow & & \nearrow F(\widehat{\psi}_i) \\
 & F(\widehat{B}_i) &
 \end{array}$$

commutes for all  $i$ . This will complete the proof since  $\sigma_{\widehat{B}, C}$  is a bijection, giving  $\Phi = \sigma_{\widehat{B}, C}(\widehat{\Psi}_0)$  as the unique filler in  $C$ .

To see this final claim, we use (iii a) again. We have a commutative diagram

$$\begin{array}{ccc}
 \text{Mor}_{\widehat{C}}(\widehat{B}, \widehat{F}(C)) & \xrightarrow{\sigma_{\widehat{B}, C}} & \text{Mor}_C(F(\widehat{B}), C) \\
 \widehat{\psi}_i^* \downarrow & & \downarrow F(\widehat{\psi}_i)^* \\
 \text{Mor}_{\widehat{C}}(\widehat{B}_i, \widehat{F}(C)) & \xrightarrow{\sigma_{\widehat{B}_i, C}} & \text{Mor}_C(F(\widehat{B}_i), C)
 \end{array}$$

which sends  $\widehat{\Psi} \in \text{Mor}_{\widehat{C}}(\widehat{B}, \widehat{F}(C))$  to

$$F(\widehat{\psi}_i)^* \sigma_{\widehat{B}, C}(\widehat{\Psi}) = \sigma_{\widehat{B}_i, C}(\widehat{\psi}_i^* \widehat{\Psi}),$$

that is, to

$$\sigma_{\widehat{B}, C}(\widehat{\Psi}) F(\widehat{\psi}_i) = \sigma_{\widehat{B}_i, C}(\widehat{\Psi} \widehat{\psi}_i).$$

Now  $\widehat{\Psi} \widehat{\psi}_i = \sigma_{\widehat{B}_i, C}^{-1}(\psi_i)$  if and only if  $\sigma_{\widehat{B}_i, C}(\widehat{\Psi} \widehat{\psi}_i) = \psi_i$ , that is, if and only if  $\psi_i = \sigma_{\widehat{B}, C}(\widehat{\Psi}) F(\widehat{\psi}_i)$ , which is what we wished to prove.  $\square$

**Corollary 8.8** *Suppose  $R$  is a ring, and  $A \in M_R$ . Then for any partially ordered set  $\mathcal{I}$  and colimiting system  $\langle B_i, \phi_{ij} \rangle$  in  ${}_R M$ ,  $\text{colim}_{\mathcal{I}}(A \otimes B_i) \approx A \otimes (\text{colim}_{\mathcal{I}} B_i)$ .*

**Proof:**  $A \otimes$  is a left adjoint.  $\square$

**Remark:** This leads to an alternate proof of Proposition 2.3 (strong additivity of  $A \otimes$ ), since direct sums are coproducts, as well as an alternate proof of Proposition 2.6(b) (right exactness of  $A \otimes$ ) since right exactness can be checked using pushouts (which are colimits).

After a while, one gets used to changing diagrams

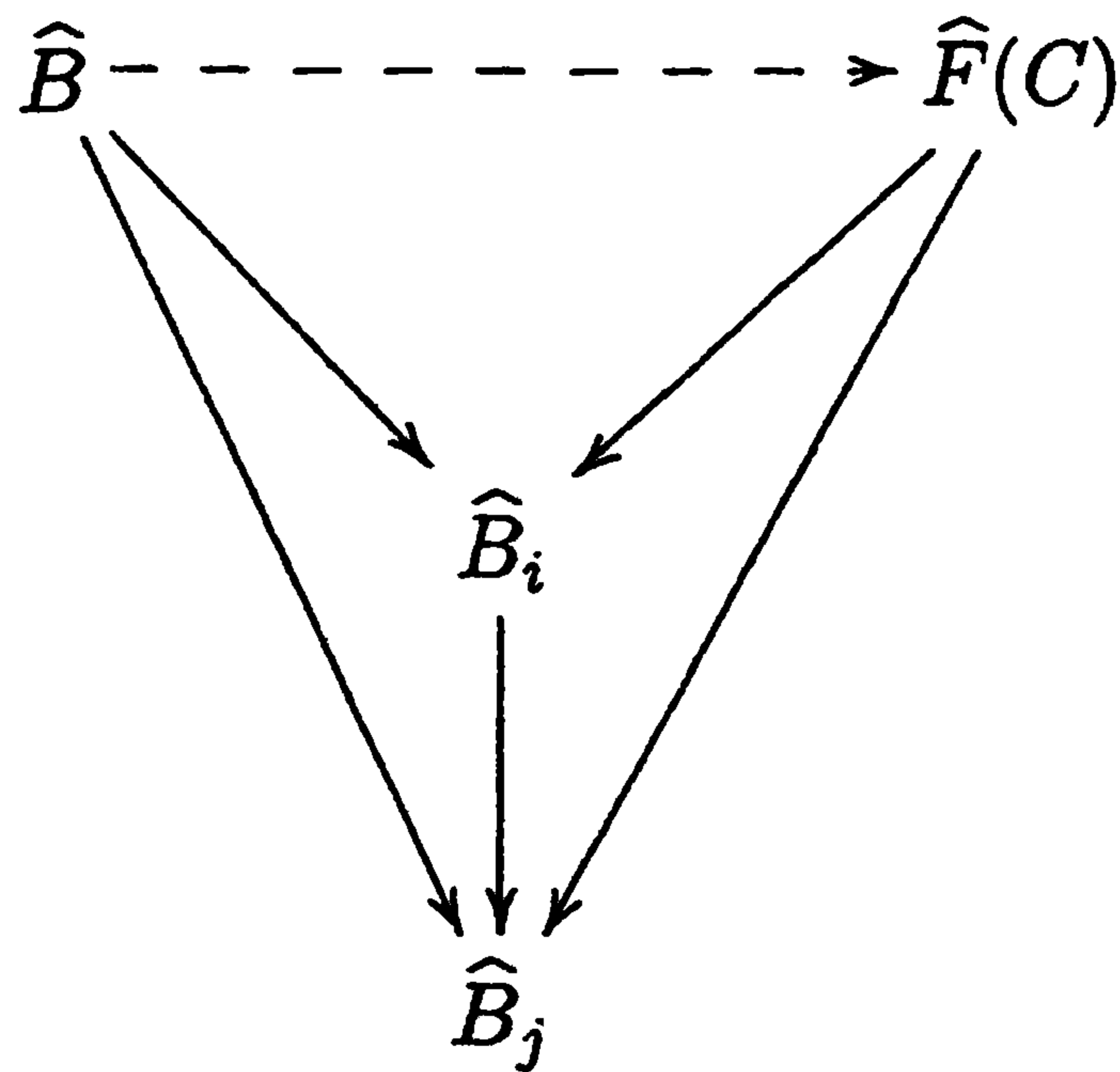

into diagrams

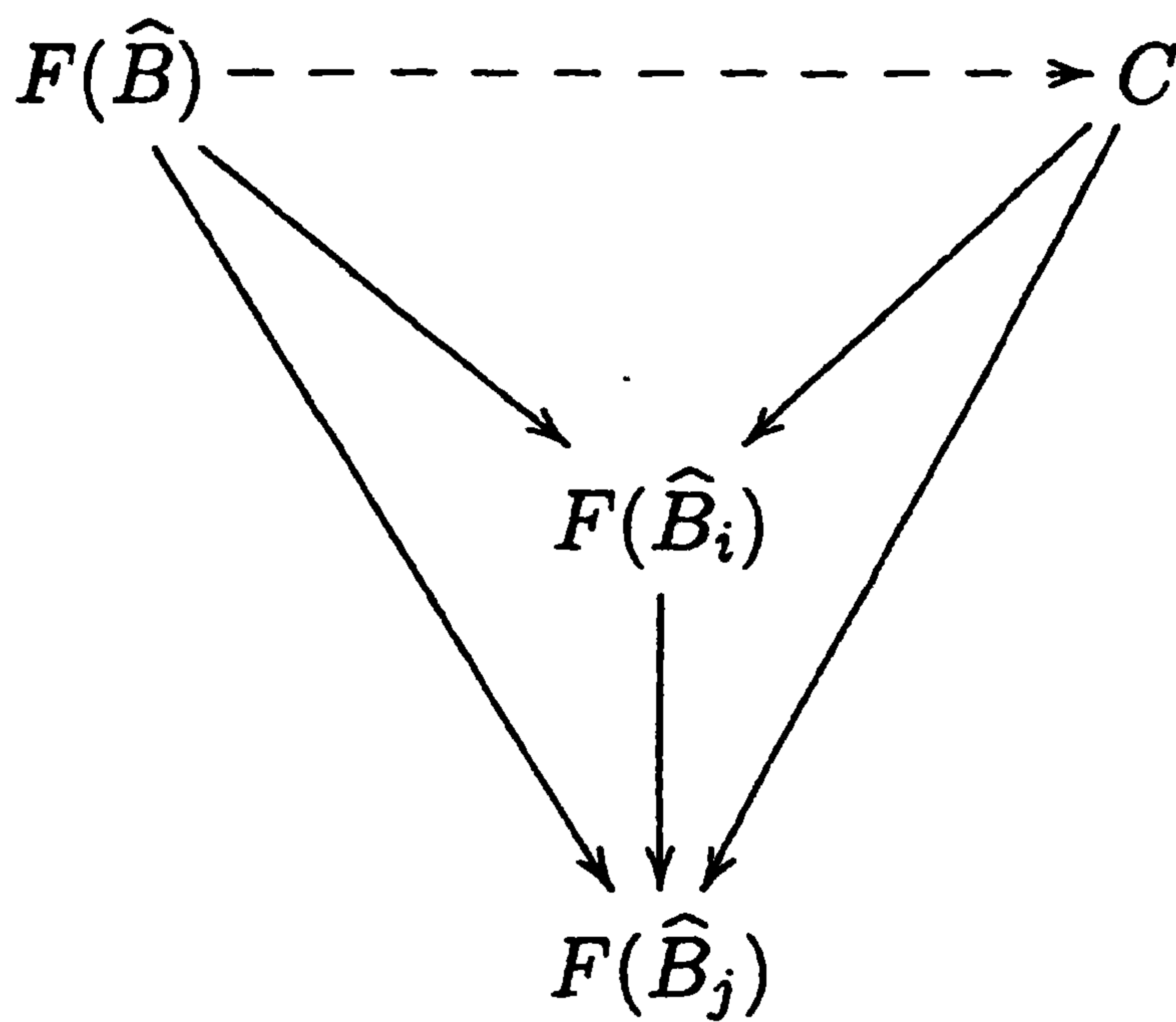

but one must be careful about the morphisms:

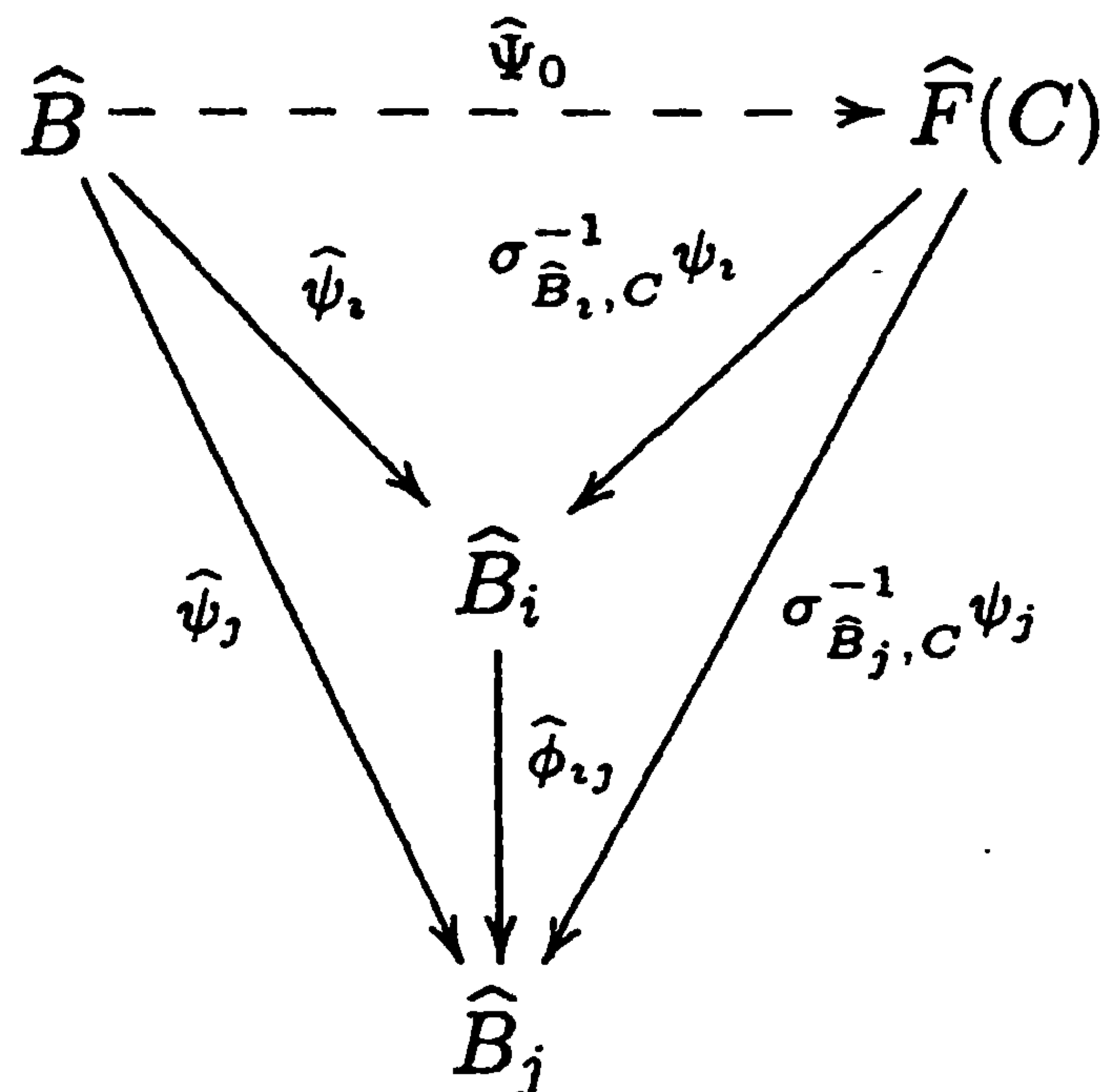

becomes

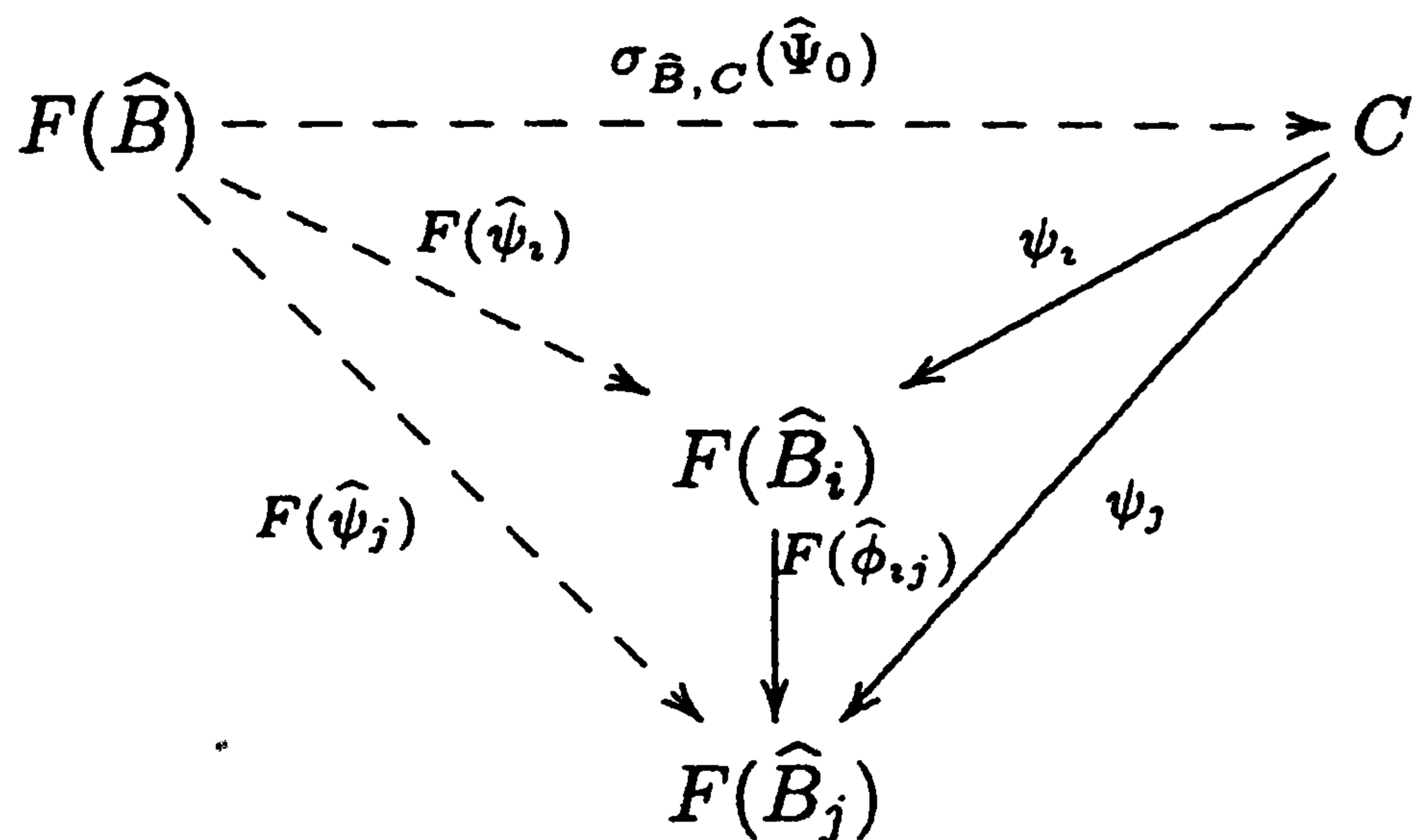

in which replacements of morphisms are not made by an obviously uniform prescription. (They are made by a subtly uniform prescription, which suggests caution until one gets used to them.)

### 8.3 Directed Colimits, $\otimes$ , and Tor

When working with Tor, the main property we gain over Ext is that, for each  $A \in \mathbf{M}_R$ ,  $\text{Tor}(A, \bullet)$  commutes with directed colimits. It is too much to ask that  $\text{Tor}(A, \bullet)$  commute with *all* colimits, since this would imply right exactness (see Exercise 2), a property  $\text{Tor}(A, \bullet)$  lacks. Nevertheless, directed colimits are enough.

The preliminaries we need are almost all completed; a consequence of Proposition 8.6 needs to be stated, and this requires a bit of discussion.

Suppose we have a partially ordered set  $\mathcal{I}$ , and two colimiting systems  $\langle A_i, \phi_{ij} \rangle$  and  $\langle A'_i, \phi'_{ij} \rangle$  in a category  $\mathbf{C}$ . Suppose we have  $f_i \in \text{Mor}(A_i, A'_i)$  for all  $i$  such that

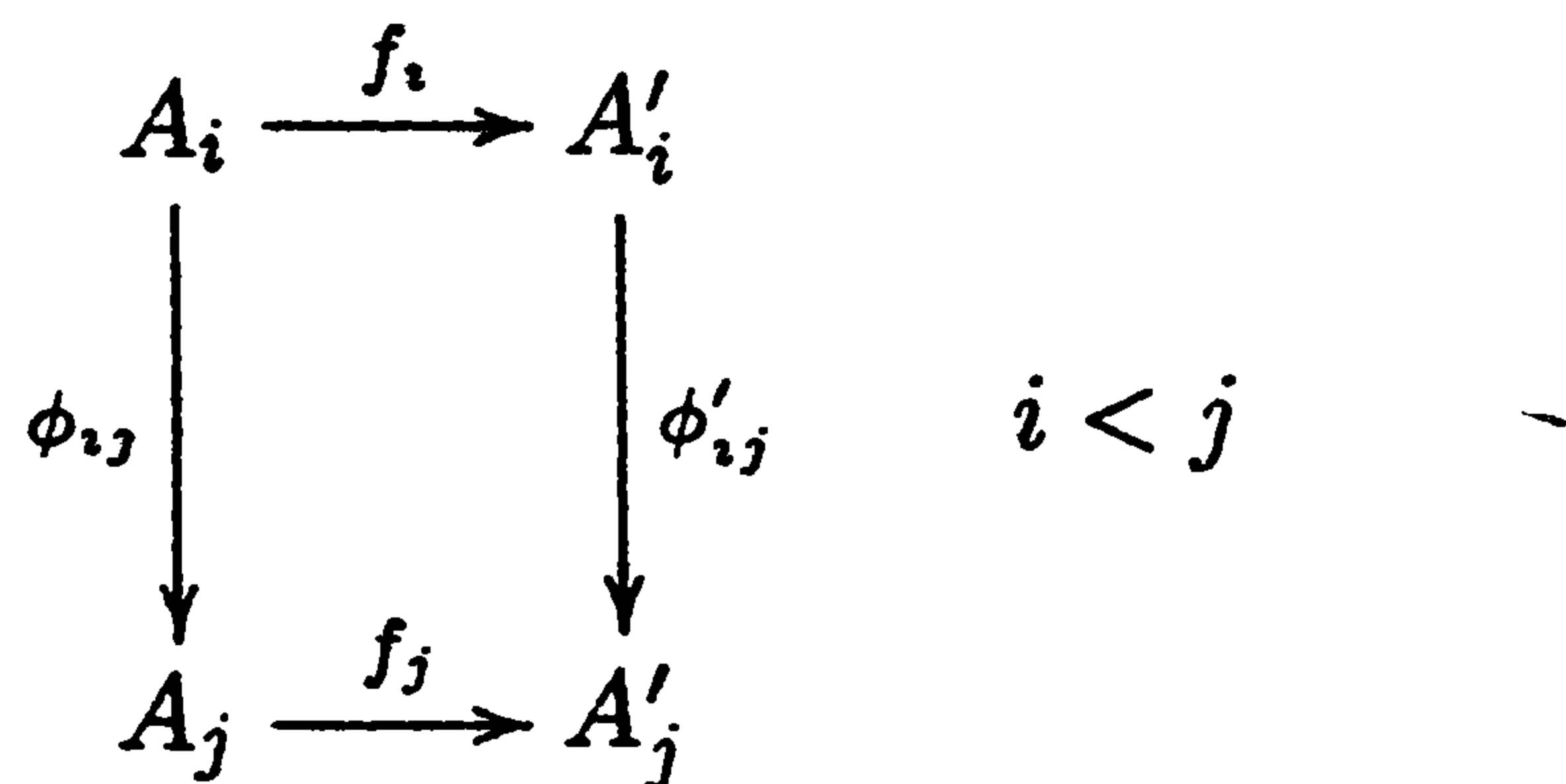

commutes. Suppose  $C = \text{colim}_{\mathcal{I}} A_i$  and  $C' = \text{colim}_{\mathcal{I}} A'_i$  both exist using morphisms  $\psi_i \in \text{Mor}(A_i, C)$  and  $\psi'_i \in \text{Mor}(A'_i, C')$ . We have a commutative diagram

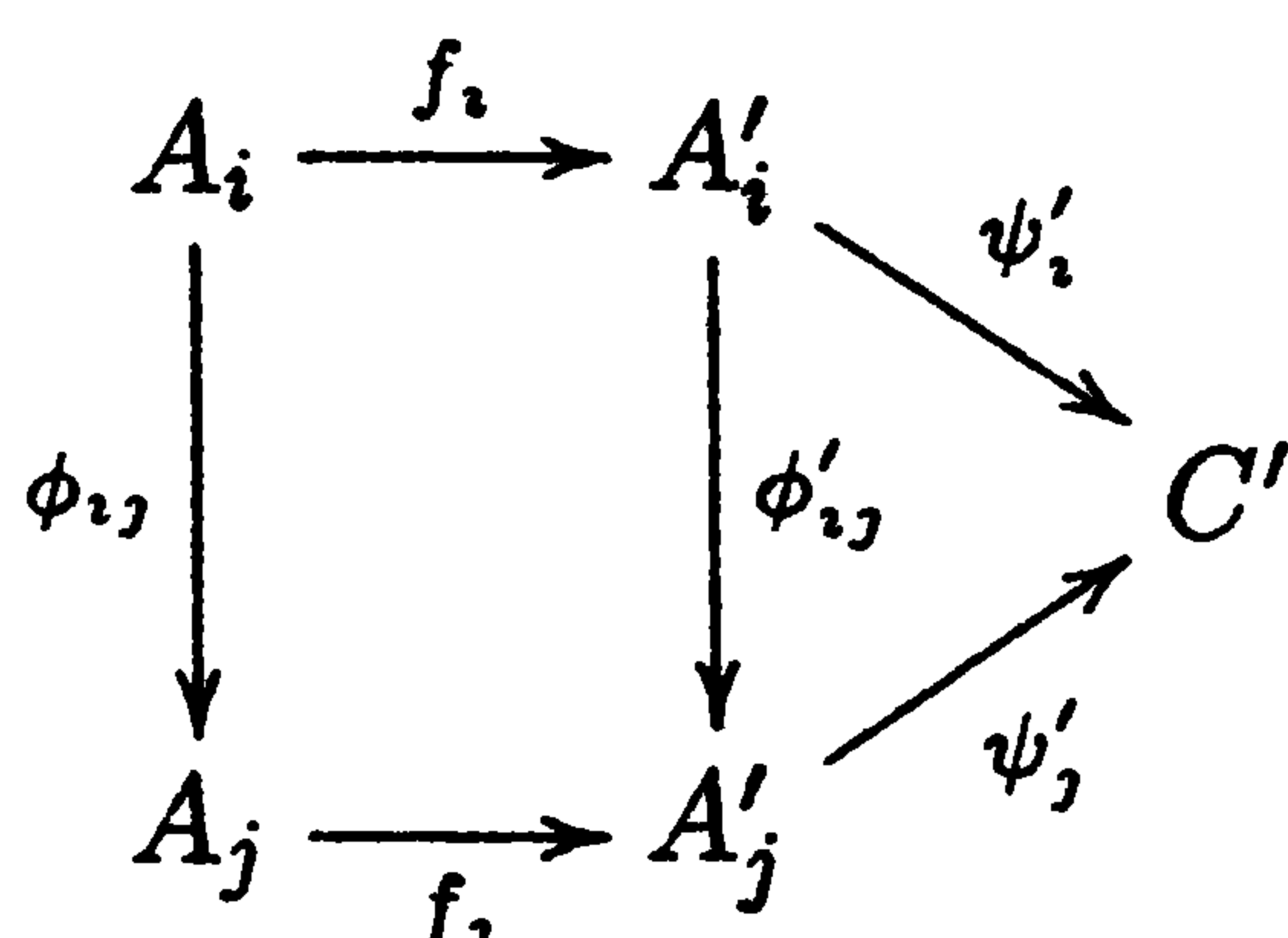

which leads to the simpler commutative diagram

$$\begin{array}{ccc}
 & & A_j \\
 & \swarrow \psi'_j f_j & \uparrow \phi_{ij} \\
 C' & & A_i \\
 & \nwarrow \psi'_i f_i & \\
 & & 
 \end{array}$$

This diagram, in turn, leads to a unique filler :

$$\begin{array}{ccc}
 C' & \xleftarrow{\text{colim}_{\mathcal{I}} f_i} & C \\
 \swarrow \psi'_i f_i & & \nearrow \psi_i \\
 & A_i & 
 \end{array}$$

(appropriately labeled  $\text{colim}_{\mathcal{I}} f_i$ ). One can interpret this category theoretically (see Exercise 5). At any rate, we shall call  $\langle f_i \rangle$  a *morphism* from the colimiting system  $\langle A_i, \phi_{ij} \rangle$  to the colimiting system  $\langle A'_i, \phi'_{ij} \rangle$ . Similar considerations apply to limiting systems (see Exercise 6).

We can now state the result we need.

**Proposition 8.9** *Suppose  $R$  is a ring, and suppose  $\mathcal{I}$  is a directed set. Let  $\langle A_i, \phi_{ij} \rangle$ ,  $\langle A'_i, \phi'_{ij} \rangle$ , and  $\langle A''_i, \phi''_{ij} \rangle$  be colimiting systems on  $\mathcal{I}$  in  $R\mathbf{M}$ , and suppose  $\langle f_i \rangle$  is a morphism from  $\langle A_i, \phi_{ij} \rangle$  to  $\langle A'_i, \phi'_{ij} \rangle$ , and  $\langle g_i \rangle$  is a morphism from  $\langle A'_i, \phi'_{ij} \rangle$  to  $\langle A''_i, \phi''_{ij} \rangle$ . Finally, suppose*

$$A_i \xrightarrow{f_i} A'_i \xrightarrow{g_i} A''_i$$

*is exact for all  $i$ . Then*

$$\text{colim}_{\mathcal{I}} A_i \xrightarrow{\text{colim}_{\mathcal{I}} f_i} \text{colim}_{\mathcal{I}} A'_i \xrightarrow{\text{colim}_{\mathcal{I}} g_i} \text{colim}_{\mathcal{I}} A''_i$$

*is exact.*

**Proof:** We use the construction appearing in Propositions 8.5 and 8.6. To simplify matters, copy the notation, with primes applied:  $C = \text{colim}_{\mathcal{I}} A_i = (\bigoplus_{\mathcal{I}} A_i)/B$ ,  $C' = \text{colim}_{\mathcal{I}} A'_i = (\bigoplus_{\mathcal{I}} A'_i)/B'$ , and so on. Note that the previously defined morphism  $\text{colim}_{\mathcal{I}} f_i$ , for example, sends

$$\langle a_i \rangle + B \in \left( \bigoplus_{\mathcal{I}} A_i \right) / B$$

to

$$\langle f_i(a_i) \rangle + B' \in \left( \bigoplus_{\mathcal{I}} A'_i \right) / B'.$$

(See Exercise 7; this is really the naturality of Proposition 8.5 in the categorical context of  $\mathcal{I}$ -colimiting systems.) It is clear from this that since  $g_i f_i$  sends  $\langle a_i \rangle + B$  to  $\langle g_i f_i(a_i) \rangle + B'' = \langle 0 \rangle + B''$ , one has  $(\operatorname{colim}_{\mathcal{I}} g_i) \circ (\operatorname{colim}_{\mathcal{I}} f_i) = 0$ .

Suppose  $\langle a'_i \rangle + B' \in C'$ , and suppose  $\operatorname{colim}_{\mathcal{I}} g_i(\langle a'_i \rangle + B') = \langle 0 \rangle + B''$ , that is, suppose for  $S''(\langle g_i(a'_i) \rangle) = \{i : g_i(a'_i) \neq 0\}$  we have a  $j \geq i$  for all  $i \in S''(\langle g_i(a'_i) \rangle)$  such that  $\sum \phi''_{ij}(g_i(a'_i)) = 0$ .  $S'(\langle a'_i \rangle) \supset S''(\langle g_i(a'_i) \rangle)$ . Choose  $k \geq j$ ,  $k \geq$  all  $i \in S'(\langle a'_i \rangle)$  (possible by induction on  $\#S'(\langle a'_i \rangle)$ , since  $\mathcal{I}$  is directed). We have that

$$\begin{aligned} 0 &= \phi''_{jk} \left( \sum_{i \in S''(\langle g_i(a'_i) \rangle)} \phi''_{ij}(g_i(a'_i)) \right) \\ &= \sum_{i \in S''(\langle g_i(a'_i) \rangle)} \phi''_{ik}(g_i(a'_i)) \\ &= \sum_{i \in S'(\langle a'_i \rangle)} \phi''_{ik}(g_i(a'_i)) \\ &= \sum_{i \in S'(\langle a'_i \rangle)} g_k(\phi'_{ik}(a'_i)) \\ &= g_k \left( \sum_{i \in S'(\langle a'_i \rangle)} \phi'_{ik}(a'_i) \right). \end{aligned}$$

It follows from exactness of  $A_k \rightarrow A'_k \rightarrow A''_k$  that  $\exists a_k \in A_k$  such that

$$f_k(a_k) = \sum_{i \in S'(\langle a'_i \rangle)} \phi'_{ik}(a'_i).$$

Extend  $a_k$  to an  $\mathcal{I}$ -tuple by setting  $a_i = 0$  if  $i \neq k$ . The claim is that  $\operatorname{colim}_{\mathcal{I}} f_i(\langle a_i \rangle + B) = \langle a'_i \rangle + B'$ , that is,  $\langle a'_i - f_i(a_i) \rangle \in B'$ . But this is immediate: Set  $T' = S'(\langle a'_i \rangle) - \{k\}$ . Then  $f_k(a_k) = a'_k + \sum_{i \in T'} \phi'_{ik}(a'_i)$ , so  $a'_k - f_k(a_k) = -\sum_{i \in T'} \phi'_{ik}(a'_i)$  and

$$\langle a'_i - f_i(a_i) \rangle = \sum_{i \in T'} \delta_{ik}(a'_i). \quad \square$$

We can now state, and prove, the main theorem of this chapter.

**Theorem 8.10** *Suppose  $R$  is a ring, and suppose  $A \in \mathbf{M}_R$ . Let  $\mathcal{I}$  be a directed set, and suppose  $\langle B_i, \phi_{ij} \rangle$  is a colimiting system on  $\mathcal{I}$  in  ${}_R\mathbf{M}$ . Then for all  $n$ ,*

$$\operatorname{colim}_{\mathcal{I}} \operatorname{Tor}_n^R(A, B_i) \approx \operatorname{Tor}_n^R(A, \operatorname{colim}_{\mathcal{I}} B_i)$$

where the colimit on the left is computed in  $\mathbf{Ab}$  and the colimit on the right is computed in  ${}_R\mathbf{M}$ .



**Proof:** Induction on  $n$ ;  $n = 0$  is Corollary 8.8. As usual, the  $n = 1$  case requires special discussion, relevant to the induction step.

Suppose

$$0 \rightarrow K \xrightarrow{\theta} F \xrightarrow{\pi} A \rightarrow 0$$

is exact in  $M_R$ , with  $F$  flat. For each  $i$ , we have exact sequences

$$0 \rightarrow \text{Tor}_1(A, B_i) \xrightarrow{\delta_i} K \otimes B_i \xrightarrow{\theta \otimes B_i} F \otimes B_i \xrightarrow{\pi \otimes B_i} A \otimes B_i \rightarrow 0$$

from which we have a diagram

$$\begin{array}{ccccc} 0 \triangleright \text{colim}_{\mathcal{I}} \text{Tor}_1(A, B_i) & \xrightarrow{\text{colim}_{\mathcal{I}} \delta_i} & \text{colim}_{\mathcal{I}} (K \otimes B_i) & \xrightarrow{\text{colim}_{\mathcal{I}} \theta \otimes B_i} & \text{colim}_{\mathcal{I}} (F \otimes B_i) \\ & & \cong & & \cong \\ 0 \triangleright \text{Tor}_1(A, \text{colim}_{\mathcal{I}} B_i) & \xrightarrow{\delta} & K \otimes (\text{colim}_{\mathcal{I}} B_i) & \xrightarrow{\theta \otimes \text{colim}_{\mathcal{I}} B_i} & F \otimes (\text{colim}_{\mathcal{I}} B_i) \end{array}$$

with exact rows by Proposition 8.9. Hence

$$\begin{aligned} \text{colim}_{\mathcal{I}} \text{Tor}_1(A, B_i) &\approx \ker(\text{colim}_{\mathcal{I}}(\theta \otimes B_i)) \\ &\approx \ker(\theta \otimes \text{colim}_{\mathcal{I}} B_i) \\ &\approx \text{Tor}_1(A, \text{colim}_{\mathcal{I}} B_i). \end{aligned}$$

The induction step is easy; for  $n \geq 1$ ,

$$\begin{aligned} \text{colim}_{\mathcal{I}} \text{Tor}_{n+1}(A, B_i) &\approx \text{colim}_{\mathcal{I}} \text{Tor}_n(K, B_i) \\ &\approx \text{Tor}_n(K, \text{colim}_{\mathcal{I}} B_i) \\ &\approx \text{Tor}_{n+1}(A, \text{colim}_{\mathcal{I}} B_i). \end{aligned} \quad \square$$

**Remark:** One can be more explicit if one desires. There is, for any  $\mathcal{I}$ , a homomorphism defined from  $\text{colim}_{\mathcal{I}} \text{Tor}_n(A, B_i)$  to  $\text{Tor}_n(A, \text{colim}_{\mathcal{I}} B_i)$  using the universal colimit property; see Exercise 8. This homomorphism will be an isomorphism when  $\mathcal{I}$  is directed, by the 5-lemma. Also, one really should check, for example, that  $\langle \delta_i \rangle : \text{Tor}_1(A, B_i) \rightarrow K \otimes B_i$  is a morphism of colimiting systems, which follows easily from naturality of the connecting homomorphisms. (See also Exercise 5.)

**Corollary 8.11** *Suppose  $R$  is any ring, and suppose  $B_i \in {}_R M$  satisfy  $\text{F-dim } B_i \leq n$  for  $i \in \mathcal{I}$ ,  $\mathcal{I}$  a directed set. Suppose  $\langle B_i, \phi_{ij} \rangle$  is a colimiting system on  $\mathcal{I}$ . Then  $\text{F-dim } \text{colim}_{\mathcal{I}} B_i \leq n$ . In particular, a directed colimit of flat  $R$ -modules is flat.*

**Proof:** Apply  $\text{Tor}_{n+1}$ ;  $\text{Tor}_{n+1}$  of each entry in the colimit is zero.  $\square$

This generalizes (see Exercise 9).

**Example 31**  $\mathbb{Q}$  is flat as a  $\mathbb{Z}$ -module; it is also the colimit (morphisms are set inclusion, ordering is “ $m \leq n$  when  $m$  divides  $n$ ”) over the positive integers  $\mathbb{N}^+$  of  $\frac{1}{n} \cdot \mathbb{Z}$ , that is,

$$\mathbb{Q} = \text{colim}_{\mathbb{N}^+} \frac{1}{n} \cdot \mathbb{Z}.$$

Note that  $\mathbb{Q}$  is not projective, although it is now a colimit of projectives. This is quite general and is the subject of the next section.

## 8.4 Lazard’s Theorem

Lazard’s theorem is part of the lore of homological algebra. From Corollary 8.11, and the example  $\mathbb{Q}$  following it, we can conclude that a directed colimit of projective modules need not be projective, but it must be flat. Lazard’s theorem [51] turns this on its head: Any flat module is, in fact, a directed colimit of finitely generated free modules.

At first glance, this isn’t even plausible. Suppose  $R$  is a direct sum of two left ideals,  $R = I \oplus J$ .  $I$  is projective, hence flat. How is  $I$  a directed colimit of free modules? Aren’t free modules too big?

This example can be done directly. The index set is the natural numbers  $\mathbb{N}$  with the usual ordering. Let  $\pi : R \rightarrow I$  denote the projection, and set  $F_n = R$ ,  $n \in \mathbb{N}$ . Set  $\psi_n = \pi$ , and  $\phi_{nm} = \pi$  when  $n < m$ . This gives a colimiting system, in which  $I = \text{colim}_{\mathbb{N}} F_n$ . (See Exercise 10.)

Doing all this systematically will require a much larger indexing set. To start the colimit discussion, we describe a general situation where colimits can be “read off.”

Suppose  $C \in {}_R\mathbf{M}$ , and suppose  $D$  is a submodule of  $C$ . Let  $\mathcal{A}$  and  $\mathcal{B}$  be nonempty families of submodules of  $C$ . These data will be said to constitute a “ $(C, D)$ -subquotient system” provided the following conditions hold:

- i)  $\mathcal{A}$  and  $\mathcal{B}$  are directed under set inclusion.
- ii)  $C = \bigcup_{A \in \mathcal{A}} A$  and  $D = \bigcup_{B \in \mathcal{B}} B$ .
- iii)  $\forall B \in \mathcal{B}, \exists A \in \mathcal{A}$  with  $A \supset B$ .

Given a  $(C, D)$ -subquotient system, set

$$\mathcal{I} = \{(A, B) \in \mathcal{A} \times \mathcal{B} : A \supset B\}.$$

Partially order  $\mathcal{I}$  by

$$(A, B) \leq (A', B') \Leftrightarrow A \subset A' \text{ and } B \subset B'.$$

For notational convenience, we shall denote a typical index by an italic letter, such as  $i = (A, B) \in \mathcal{I}$ , and set  $A = A_i$ ,  $B = B_i$ . That way, subscripts won't be written as ordered pairs, sometimes with primes (e.g.,  $A = A_{(A, B)}$ ). In this notation,  $i = (A_i, B_i)$ , which looks peculiar. Nevertheless, the index will always be  $i, j, k, \dots$ ; the modules  $A_i, B_i, A_j, B_j$ , etc. That is, as often happens, we forget the messy world where  $\mathcal{I}$  originated, and denote a typical member as  $i$ , which parametrizes the pair  $(A_i, B_i)$ . Observe that  $i \leq j \Leftrightarrow A_i \subset A_j$  and  $B_i \subset B_j$ .

Our first result, and the reason for the terminology “ $(C, D)$ -subquotient system” is the following.

**Proposition 8.12** *Suppose  $\mathcal{A}$  and  $\mathcal{B}$  give a  $(C, D)$ -subquotient system. Form  $\mathcal{I}$ ,  $A_i, B_i$  as above. Then  $\mathcal{I}$  is directed and*

$$\operatorname{colim}_{\mathcal{I}} A_i/B_i \approx C/D.$$

**Remark:** The morphisms are the obvious ones: If  $i \leq j$ , then  $\phi_{ij} : A_i/B_i \rightarrow A_j/B_j$  is defined by  $\phi_{ij}(x + B_i) = x + B_j$ . Also, for all  $i$ ,  $\psi_i : A_i/B_i \rightarrow C/D$  is defined by  $\psi_i(x + B_i) = x + D$ .

**Proof:** Suppose  $i, j \in \mathcal{I}$ .  $\exists B \in \mathcal{B}$  with  $B \supset B_i$  and  $B \supset B_j$ , since  $\mathcal{B}$  is directed.  $\exists A \in \mathcal{A}$  with  $A \supset B$  by condition (iii). Finally,  $\exists A' \in \mathcal{A}$  with  $A' \supset A$ ,  $A' \supset A_i$ ,  $A' \supset A_j$ , since  $\mathcal{A}$  is directed. Setting  $k = (A', B)$ , we have that  $k \geq i$  and  $k \geq j$ . All this says that  $\mathcal{I}$  is directed.

To finish, suppose  $E \in {}_R\mathbf{M}$ , and suppose  $\psi'_i : A_i/B_i \rightarrow E$  satisfy  $\psi'_j \phi_{ij} = \psi'_i$  when  $j > i$ . We must produce a unique  $\Phi : C/D \rightarrow E$  for which  $\psi'_i = \Phi \psi_i$  for all  $i$ .

Notice what is forced. Choose  $x \in C$ .  $\exists A \in \mathcal{A}$  with  $x \in A$ . Choose any  $B \in \mathcal{B}$ , and any  $A' \in \mathcal{A}$  with  $A' \supset B$ . Finally, choose any  $A'' \in \mathcal{A}$  with  $A'' \supset A'$  and  $A'' \supset A$ . Set  $i = (A'', B)$ . Then for this  $i$  (shifting notation),  $x \in A_i$ . Among other things, this shows that  $\cup_{\mathcal{I}} A_i = C$ . But we also know that  $\psi'_i(x + B_i) = \Phi \psi_i(x + B_i) = \Phi(x + D)$ , so we are forced to set  $\Phi(x + D) = \psi'_i(x + B_i)$ . We will be finished if we show that this does define  $\Phi$ , since this definition is then unique.

First of all, for  $x \in C$ , set  $\widehat{\Phi}(x) = \psi'_i(x + B_i)$  for any  $i$  for which  $x \in A_i$ .

1.  $\widehat{\Phi}$  is well-defined: If also  $x \in A_j$ , choose  $k \in \mathcal{I}$ ,  $k \geq i$ ,  $k \geq j$ . Then

$$\begin{aligned} \psi'_j(x + B_j) &= \psi'_k \phi_{jk}(x + B_j) \\ &= \psi'_k(x + B_k) \\ &= \psi'_k \phi_{ik}(x + B_i) \\ &= \psi'_i(x + B_i). \end{aligned}$$

2.  $\widehat{\Phi}$  is an  $R$ -module homomorphism: If  $r \in R$ , then  $\widehat{\Phi}(rx) = \psi'_i(rx + B_i) = r\psi'_i(x + B_i) = r\widehat{\Phi}(x)$ . If  $x, y \in C$ , choose  $i, j$  with  $x \in A_i$ ,  $y \in A_j$ .

Choose  $k \in \mathcal{I}$ ,  $k \geq i$ ,  $k \geq j$ . Then  $x \in A_i \subset A_k$  and  $y \in A_j \subset A_k$ , so  $x, y \in A_k$ , and  $\widehat{\Phi}(x + y) = \psi'_k(x + y + B_k) = \psi'_k(x + B_k) + \psi'_k(y + B_k) = \widehat{\Phi}(x) + \widehat{\Phi}(y)$ .

3.  $\widehat{\Phi}$  is zero on  $D$ : If  $x \in D$ , then  $\exists B \in \mathcal{B}$  with  $x \in B$ . Choose  $A \in \mathcal{A}$  with  $A \supset B$ , and set  $i = (A, B)$ . Then  $x \in B_i \subset A_i$ , so  $\widehat{\Phi}(x) = \psi'_i(x + B_i) = 0$ .

Combining all these, we can now set  $\Phi(x + D) = \widehat{\Phi}(x) = \psi'_i(x + B_i)$  (when  $x \in A_i$ ), as required.  $\square$

There are direct consequences to this, for example, if  $\mathcal{B} = \{0\}$  or  $\mathcal{A} = \{C\}$  (see Exercise 11). However, we shall focus on a particular example devised by Lazard. We need a structural lemma.

**Lemma 8.13** *Suppose  $A \in {}_R\mathbf{M}$ , with  $A = A_1 \oplus A_2$ , an internal direct sum. Suppose  $B_1$  is a submodule of  $A_1$ , and  $B_2$  is a submodule of  $A_2$ . Suppose  $\theta : A_1/B_1 \rightarrow A_2/B_2$  is a homomorphism, and suppose  $A_1$  is generated by  $\{x_1, \dots, x_n\}$ . For each  $k = 1, \dots, n$ , choose  $y_k \in A_2$  such that  $\theta(x_k + B_1) = y_k + B_2$ . Let  $B$  be the submodule of  $A$  generated by  $B_1, B_2$ , and  $\{x_1 - y_1, \dots, x_n - y_n\}$ . Let  $\psi_i : A_i/B_i \rightarrow A/B$  be the natural maps  $\psi_i(x + B_i) = x + B$ . Then  $\psi_2$  is an isomorphism, and the triangle*

$$\begin{array}{ccc}
 & & A/B \\
 & \nearrow \psi_1 & \uparrow \psi_2 \\
 A_1/B_1 & & \\
 & \searrow \theta & \\
 & & A_2/B_2
 \end{array}$$

*is commutative.*

**Proof:** Note that  $\psi_2\theta(x_j + B_1) = \psi_2(y_j + B_2) = y_j + B = x_j + B = \psi_1(x_j + B_1)$ , since all  $x_j - y_j \in B$ . Since  $\psi_2\theta$  and  $\psi_1$  agree on a set of generators of  $A_1/B_1$ ,  $\psi_2\theta = \psi_1$ .

If  $y \in A_2$ , then  $y + B$  is in the image of  $\psi_2$ . If  $x \in A_1$ , then  $x + B \in \text{im}\psi_1 = \text{im}\psi_2\theta \subset \text{im}\psi_2$ . Combining, all of  $A/B = (A_1 \oplus A_2)/B$  is in the image of  $\psi_2$ , so  $\psi_2$  is onto.

Finally,  $\psi_2(y + B_2) = y + B$  for  $y \in A_2$ , so  $\psi_2(y + B_2) = 0 + B \Leftrightarrow y \in A_2 \cap B$ . If  $y \in A_2 \cap B$ , then  $y = b_1 + b_2 + \sum_{j=1}^n r_j(x_j - y_j)$ , with  $b_1 \in B_1$  and  $b_2 \in B_2$ . But then  $y = (b_1 + \sum r_j x_j) + (b_2 - \sum r_j y_j)$ , so that since  $y \in A_2$  and  $A_1 \cap A_2 = 0$ ,  $b_1 + \sum r_j x_j = 0$ . This means that  $\sum r_j x_j = -b_1 \in B_1$ , so that  $\sum r_j y_j + B_2 = \sum r_j \theta(x_j + B_1) = \theta(\sum r_j x_j + B_1) = \theta(0) = 0$ , so  $\sum r_j y_j \in B_2$  as well. Hence  $y = b_2 - \sum r_j y_j \in B_2$ , and  $y + B_2 = 0 + B_2$ . This says that  $\psi_2$  is one-to-one.  $\square$

**Remark:** This proof can be simplified slightly by forming a quotient with  $B_1 \oplus B_2$  at the outset. Also,  $B$  can be generated by  $B_1, B_2$ , and the graph



of  $-\theta$ . The form we have is selected to match its application as closely as possible.

Lazard's theorem is based on the following result about the existence of a subquotient system which is universal, at least as far as finitely presented modules are concerned.

**Proposition 8.14 (Lazard)** *Suppose  $E \in {}_R\mathcal{M}$ . There exists a  $(C, D)$ -subquotient system with the following properties (index set  $\mathcal{I}$  and all  $A_i, B_i, \psi_i, \phi_{ij}$  as in Proposition 8.12):*

a)  $C/D \approx E$ .

b)  $A_i/B_i$  is finitely presented for all  $i \in \mathcal{I}$ .

c) If  $F$  is finitely presented, and if  $\eta : F \rightarrow C/D$  is a homomorphism, then  $\exists i \in \mathcal{I}$  and an isomorphism  $\eta' : F \rightarrow A_i/B_i$  such that the triangle

$$\begin{array}{ccc} A_i/B_i & & \\ \uparrow \eta' & \searrow \psi_i & \\ F & \xrightarrow{\eta} & C/D \end{array}$$

commutes.

d) If  $i \in \mathcal{I}$ , and if  $\psi_i = \rho\sigma$ , where  $\sigma : A_i/B_i \rightarrow F$  and  $\rho : F \rightarrow C/D$  with  $F$  finitely presented, then  $\exists j \in \mathcal{I}, j \geq i$ , and an isomorphism  $\tau : F \rightarrow A_j/B_j$  such that the diagram

$$\begin{array}{ccccc} & & A_j/B_j & & \\ & \nearrow \phi_{ij} & & \searrow \psi_j & \\ A_i/B_i & & & & C/D \\ & \searrow \sigma & \uparrow \tau & \nearrow \rho & \\ & & F & & \end{array}$$

commutes.

**Remark:** (d) is the crucial point. This colimiting system is universal for finitely presented modules and their homomorphisms.

**Proof:** Let  $C$  be the free module on the set  $E \times \mathbb{N}$ ,  $\mathbb{N} =$  natural numbers. Define a map  $\pi$  from  $C$  onto  $E$  by sending each  $(e, n) \in E \times \mathbb{N}$  to  $e$ . Let  $D$  be the kernel of this map, and let  $\mathcal{A}$  be the family of submodules of  $C$  generated by finite subsets of  $E \times \mathbb{N}$  (hence, free on finite sets) and let



$\mathcal{B}$  be the family of finitely generated submodules of  $D$ . With this setup, we have a  $(C, D)$ -subquotient system, and  $C/D \approx E$ , while each  $A_i/B_i$  is finitely presented (since each  $A_i$  is free on a finite set and each  $B_i$  is finitely generated). There remain the universality properties (c) and (d).

For (c), note that  $(0, 0) \in \mathcal{I}$ , so the zero module appears as an  $A_i/B_i$ . But then (d)  $\Rightarrow$  (c), by taking (given  $F$  and  $\eta$ )  $A_i/B_i = 0$ ,  $\sigma = 0$ ,  $\rho = \eta$ , and setting  $\eta' = \tau$ . Hence, we focus on (d). Let  $\sigma$ ,  $F$ , and  $\rho$  be as stated in (d).

Choose  $N \geq$  all  $n_k$ , where  $A_i$  is generated by  $\{(e_1, n_1), \dots, (e_l, n_l)\}$ . Since  $F$  is finitely presented, it is generated by  $\{x_1, \dots, x_m\}$ , where the kernel of the homomorphism from the free module on  $\{x_1, \dots, x_m\}$  to  $F$  is finitely generated. For each  $j = 1, \dots, m$ , choose  $y_j \in C$  such that  $\rho(x_j) = y_j + D$ , and let  $A$  be the member of  $\mathcal{A}$  which is free on  $\{(\pi(y_1), N + 1), \dots, (\pi(y_m), N + m)\}$ . Define  $\alpha : A \rightarrow F$  by setting  $\alpha((\pi(y_j), N + j)) = x_j$ ;  $\alpha$  is onto by construction, and its kernel  $B$  will be finitely generated. Note that  $\pi((\pi(y_j), N + j)) = \pi(y_j)$ , so that  $(\pi(y_j), N + j) + D = y_j + D$ . But then  $\rho\alpha((\pi(y_j), N + j)) = \rho(x_j) = y_j + D = (\pi(y_j), N + j) + D$ . Thus,  $\rho\alpha(x) = x + D$  for all  $x \in A$ , since this equation holds for generators of  $A$ . If  $x \in B$ , then  $x + D = \rho\alpha(x) = 0 + D$ , since  $\alpha(x) = 0$ . That is,  $B \subset D$ , so  $(A, B) = (A_k, B_k)$  for an index  $k$ . Letting  $\bar{\alpha}$  denote the induced isomorphism:  $A_k/B_k \rightarrow F$ , we have a commutative diagram

$$\begin{array}{ccc} A_k/B_k & \xrightarrow{\psi_k} & C/D \\ \downarrow \bar{\alpha} & & \uparrow \rho \\ F & & \end{array}$$

(which, by the way, establishes (c) already).

Now use the lemma, with  $\theta : A_i/B_i \rightarrow A_k/B_k$  defined by  $\theta = \bar{\alpha}^{-1}\sigma$ . The resulting  $A_i \oplus A_k$  will be  $A_j$  (note that this sum is direct, and the resulting  $A_j \in \mathcal{A}$ ), while the “ $B$ ” in the lemma will be  $B_j$ . This  $B_j$  is finitely generated; we need to know that  $B_j \subset D$ . Since  $B_i \subset D$  and  $B_k \subset D$ , we need to know that when  $\alpha(y) = \sigma(x + B_i)$  then, necessarily,  $x - y \in D$  (since then  $\theta(x + B_i) = y + B_k$ , and the elements called “ $x_j - y_j$ ” in the lemma will all be in  $D$ ). But  $\alpha(y) = \sigma(x + B_i) \Rightarrow x + D = \psi_i(x + B_i) = \rho\sigma(x + B_i) = \rho\alpha(y) = \rho\bar{\alpha}(y + B_k) = \psi_k(y + B_k) = y + D$ . Hence, we can, in fact, define this  $(A_j, B_j)$ ,  $j \in \mathcal{I}$ .

We now have a commutative diagram

$$\begin{array}{ccc} & & A_j/B_j \\ & \nearrow \phi_{ij} & \uparrow \approx \phi_{kj} \\ A_i/B_i & & \\ & \searrow \bar{\alpha}^{-1}\sigma & A_k/B_k \end{array}$$

with  $\phi_{kj}$  an isomorphism, assembling into the commutative diagram

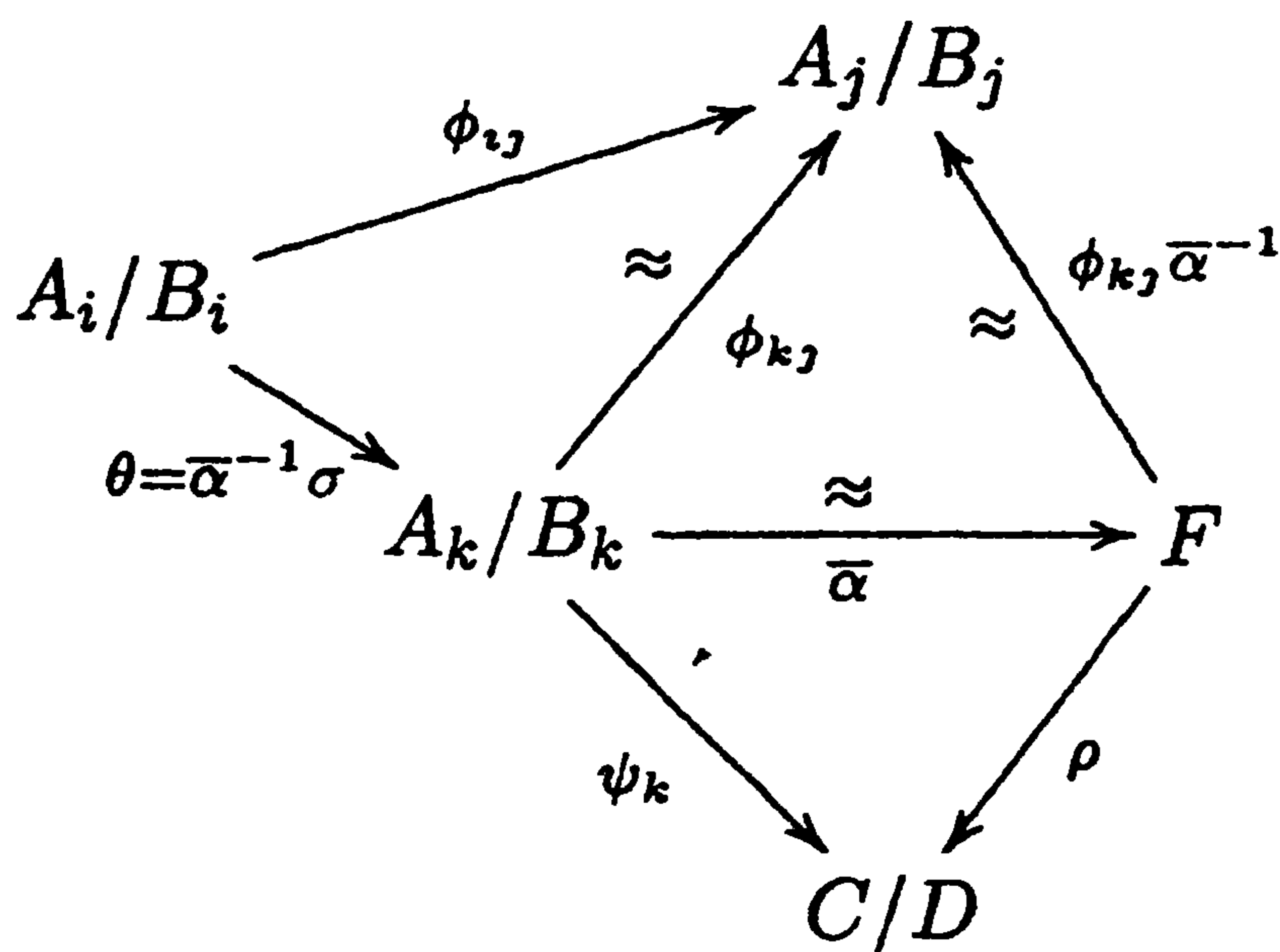

from which  $\rho = \psi_k \bar{\alpha}^{-1} = \psi_j \phi_{kj} \bar{\alpha}^{-1}$  so that

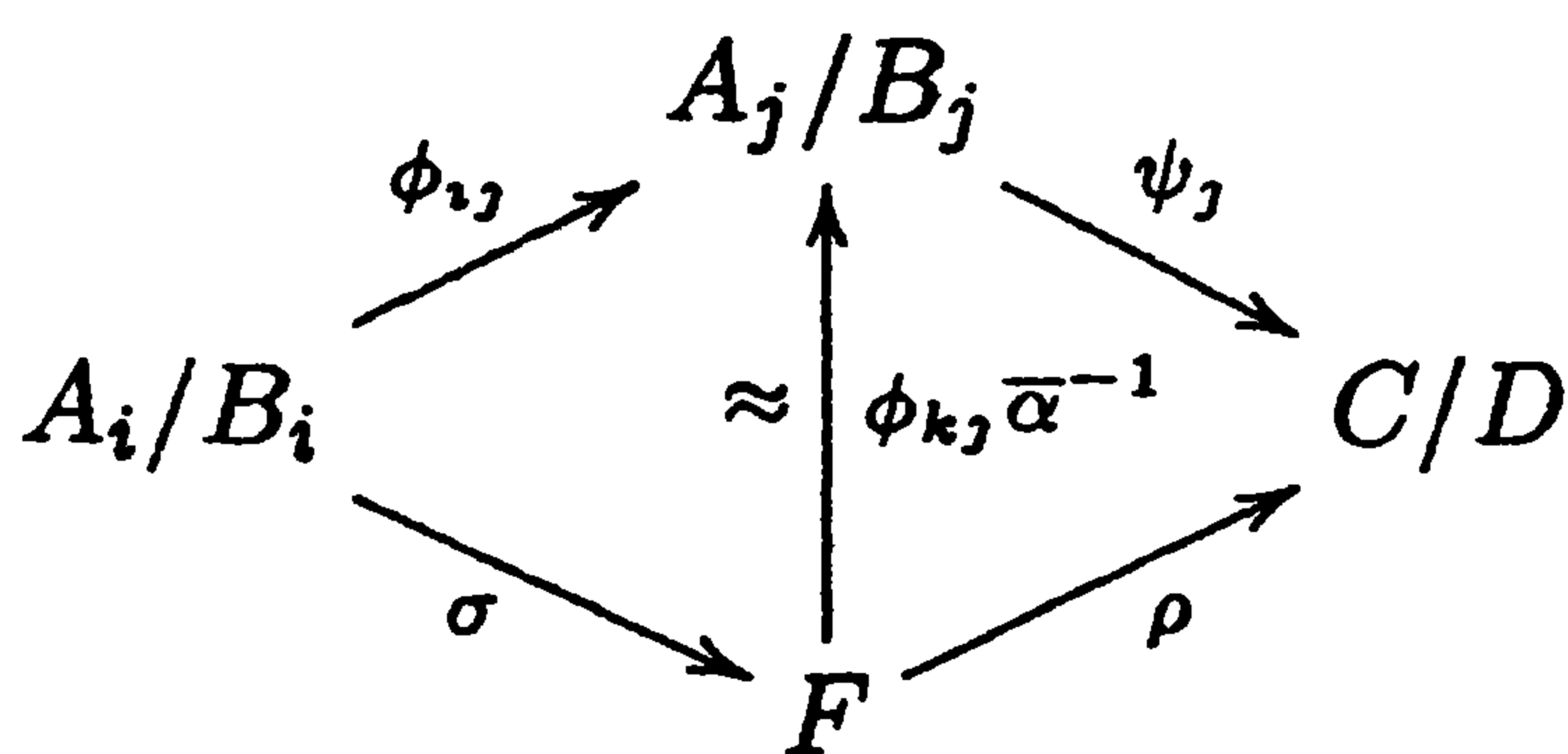

is commutative. Set  $\tau = \phi_{kj} \bar{\alpha}^{-1}$ . □

**Corollary 8.15** *Every left  $R$ -module is a directed colimit of finitely presented left  $R$ -modules.*

Actually, more holds. We are nearly finished; just recall some ideas from Section 4.2. If  $F \in {}_R\mathbf{M}$ , set  $F^* = \text{Hom}(F, R)$ .  $F^* \otimes E$  maps naturally to  $\text{Hom}(F, E)$  by sending  $\sum g_i \otimes e_i$  to  $\Phi$ , where  $\Phi(x) = \sum g_i(x) \cdot e_i$ .

**Theorem 8.16 (Lazard's Theorem)** *Suppose  $R$  is a ring, and  $E \in {}_R\mathbf{M}$ . The following are equivalent:*

- i)  $E$  is flat.
- ii) For all finitely presented  $F$ ,  $F^* \otimes E \rightarrow \text{Hom}(F, E)$  is an isomorphism.
- iii) For all finitely presented  $F$ ,  $F^* \otimes E \rightarrow \text{Hom}(F, E)$  is onto.
- iv)  $E$  is a directed colimit of finitely generated free modules.

**Proof:** (iv)  $\Rightarrow$  (i) follows from Corollary 8.11, since free modules are flat. (i)  $\Rightarrow$  (ii) is Proposition 4.18. (ii)  $\Rightarrow$  (iii) is trivial. Finally, (iii)  $\Rightarrow$  (iv):

Assume (iii). Let  $\mathcal{I}$ ,  $A_i$ ,  $B_i$ ,  $\psi_i$ ,  $\phi_{ij}$  be as in Proposition 8.14. Set

$$\mathcal{J} = \{j \in \mathcal{I} : A_j/B_j \text{ is free}\}.$$

Suppose  $i \in \mathcal{I}$ . Then  $\psi_i \in \text{Hom}(A_i/B_i, C/D)$  lies in the image of  $(A_i/B_i)^* \otimes (C/D)$ , so  $\exists \sigma_1, \dots, \sigma_n \in \text{Hom}(A_i/B_i, R)$ , and  $\bar{y}_1, \dots, \bar{y}_n \in C/D$ , with  $\psi_i(\bar{x}) = \sum \sigma_k(\bar{x})\bar{y}_k$ . Define  $\sigma = (\sigma_1, \dots, \sigma_n) : A_i/B_i \rightarrow R^n$ , and  $\rho : R^n \rightarrow C/D$  by  $\rho(r_1, \dots, r_n) = \sum r_k \bar{y}_k$ . Then  $\psi_i = \rho\sigma$ , so by Proposition 8.14,  $\exists j \in \mathcal{I}$ ,  $j \geq i$ , and an isomorphism  $\tau : R^n \rightarrow A_j/B_j$ , for which the diagram

$$\begin{array}{ccccc}
 & & A_j/B_j & & \\
 & \nearrow \phi_{ij} & \uparrow \tau & \searrow \psi_j & \\
 A_i/B_i & & \approx & & C/D \\
 & \searrow \sigma & \uparrow & \nearrow \rho & \\
 & & R^n & & 
 \end{array}$$

is commutative. But observe:  $j \in \mathcal{J}$ , since  $A_j/B_j \approx R^n$  is free. This just says that  $\mathcal{J}$  is cofinal in  $\mathcal{I}$ . Hence, by Corollary 8.3 (and Proposition 8.12),  $\mathcal{J}$  is directed, and

$$E \approx C/D \approx \text{colim}_{\mathcal{I}} A_i/B_i \approx \text{colim}_{\mathcal{J}} A_j/B_j. \quad \square$$

Lazard's theorem has some consequences. One major result is discussed in the next section.

## 8.5 Weak Dimension Revisited

This section requires results from Chapter 5.

In Chapter 5, the focus was on projective dimension, and through it, global dimension. The problem was that flats could not be handled definitively, and the deficiency appeared right up front in Theorem 5.1(b). Lazard's theorem allows us to fix that.

Adopt the situation that started Chapter 5, that is, suppose  $R$  and  $S$  are rings, and suppose  $F : {}_S\mathbf{M} \rightarrow {}_R\mathbf{M}$  is an exact, strongly additive functor. The functors appearing in Chapter 5 were basically of two varieties. In the first case, there was an  $A \in {}_R\mathbf{M}_S$  for which  $F(B) \approx A \otimes_S B$  for  $B \in {}_S\mathbf{M}$ . In the second case, there was a homomorphism  $\phi : R \rightarrow S$  which turned any  $B \in {}_S\mathbf{M}$  into an  $R$ -module via  $r \cdot b = \phi(r)b$ ,  $r \in R, b \in B$ . But this  $F(B)$  was really  $S \otimes_S B$ , where  $S \in {}_R\mathbf{M}_S$  via  $r \cdot s = \phi(r)s$ ,  $r \in R, s \in S$ .

All exact, strongly additive functors from  ${}_S\mathbf{M}$  to  ${}_R\mathbf{M}$  arise in this way—this follows from Watts' theorem (Chapter 5, Exercise 3), which states that whenever  $F : {}_S\mathbf{M} \rightarrow {}_R\mathbf{M}$  is a strongly additive right exact functor, necessarily  $F(B) \approx A \otimes_S B$ , where  $A = F(S) \in {}_R\mathbf{M}_S$ . Here,  $F(S)$  is flat as a right  $S$ -module since  $F$  is actually exact. This isomorphism is also "natural" in that morphisms are preserved. In what follows, we will replace

the abstract functor  $F$  with the concrete functor  $A \otimes_S$  when necessary, with the proviso that  $A$  is flat as a right  $S$ -module. The opening step, however, does not require this proviso, and is the key point in generalizing Theorem 5.1(b).

**Proposition 8.17** *Suppose  $R$  and  $S$  are rings, and suppose  $A \in {}_R\mathbf{M}_S$ . Then for all flat  $B \in {}_S\mathbf{M}$ ,  $F\text{-dim}_R A \otimes_S B \leq F\text{-dim}_R A$ .*

**Proof:** Write  $B \approx \text{colim}_{\mathcal{I}} B_i$ , where each  $B_i$  is free and finitely generated. Lazard's theorem says that we can do this. Then  $A \otimes_S B \approx A \otimes_S (\text{colim}_{\mathcal{I}} B_i) \approx \text{colim}_{\mathcal{I}} (A \otimes_S B_i)$ .

**Interlude:** There is a technical point here.  $A \otimes_S$  preserves colimits as a functor from  ${}_S\mathbf{M}$  to  ${}_R\mathbf{M}$  (Note: It is  ${}_R\mathbf{M}$  here, not  $\mathbf{Ab}$ .) by Proposition 8.7, since  $A \otimes_S$  is a left adjoint; the right adjoint functor from  ${}_R\mathbf{M}$  to  ${}_S\mathbf{M}$  is  $C \mapsto \text{Hom}_R(A, C)$  by Chapter 2, Exercise 15, the generalization to our situation of Theorem 2.4.

Now, each  $A \otimes_S B_i$  is a direct sum of a finite number of copies of  $A$ , so  $F\text{-dim}_R A \otimes_S B_i = F\text{-dim}_R A$  (or 0 if  $B_i = 0$ ). Hence,  $F\text{-dim}_R A \otimes_S B = F\text{-dim}_R (\text{colim}_{\mathcal{I}} (A \otimes_S B_i)) \leq F\text{-dim}_R A$  by Corollary 8.11.  $\square$

**Corollary 8.18** *Suppose  $R$  and  $S$  are rings, and suppose  $A \in {}_R\mathbf{M}_S$  and  $B \in {}_S\mathbf{M}$ . Suppose  $A$  is flat as a left  $R$ -module, and suppose  $B$  is flat as a left  $S$ -module. Then  $A \otimes_S B$  is flat as a left  $R$ -module.*

**Proof:**  $F\text{-dim } A = 0$  in Proposition 8.17.  $\square$

**Remark:** There is an elementary, Chapter 2-level proof of this (see Exercise 12). In fact, there is a Chapter 4-level proof of Proposition 8.17 as well, although it involves an auxiliary concept (see Exercise 15).

The generalization of Theorem 5.1(b) is as follows.

**Proposition 8.19** *Suppose  $R$  and  $S$  are rings, and suppose  $F : {}_S\mathbf{M} \rightarrow {}_R\mathbf{M}$  is an exact, strongly additive covariant functor. Then  $\forall B \in {}_S\mathbf{M}$ ,*

$$F\text{-dim}_R F(B) \leq F\text{-dim}_S B + F\text{-dim}_R F(S).$$

**Proof:** Replace  $F$  with  $A \otimes_S$ , where  $A \in {}_R\mathbf{M}_S$  and  $A$  is flat as a right  $S$ -module; this is possible by Watts' theorem, where  $A = F(S)$ . If  $F\text{-dim}_S B = \infty$ , there is nothing to prove, so assume  $F\text{-dim}_S B < \infty$ . There is a flat resolution of  $B$ :

$$0 \rightarrow D_n \rightarrow D_{n-1} \rightarrow \cdots \rightarrow D_1 \rightarrow D_0 \rightarrow B \rightarrow 0$$



which, after applying  $A \otimes_S$ , yields

$$0 \rightarrow A \otimes_S D_n \rightarrow A \otimes_S D_{n-1} \rightarrow \cdots \rightarrow A \otimes_S D_1 \rightarrow A \otimes_S D_0 \rightarrow A \otimes_S B \rightarrow 0$$

since  $A$  is flat as a right  $S$ -module. But  $\text{F-dim}_R(A \otimes_S D_k) \leq \text{F-dim}_R A = \text{F-dim}_R F(S)$  by Proposition 8.17, so  $\text{F-dim}_R(A \otimes_S B) \leq n + \text{F-dim}_R F(S)$  by Corollary 4.3.  $\square$

There is a corollary, which improves Theorem 5.18(b). For this,  $S$  is an admissible multiplicative set (one reason why we have been so explicit about  $R$  and  $S$ ), that is, a nonempty subset of  $R - \{0\}$  which is closed under multiplication. The following redoes Exercise 8(a & b), Chapter 5.

**Corollary 8.20** *Suppose  $R$  is a commutative ring and  $S$  is an admissible multiplicative subset of  $R$ .*

a) *For all  $B \in {}_R\mathbf{M}$ ,  $\text{F-dim}_{S^{-1}R} S^{-1}B \leq \text{F-dim}_R B$ .*

b) *For all  $\widehat{B} \in {}_{S^{-1}R}\mathbf{M}$ ,  $\text{F-dim}_{S^{-1}R} \widehat{B} = \text{F-dim}_R \widehat{B}$ .*

**Proof:** For (a), let  $F(B) = S^{-1}B \approx S^{-1}R \otimes_R B$ . Then  $\text{F-dim}_{S^{-1}R} F(R) = \text{F-dim}_{S^{-1}R} S^{-1}R = 0$ , so  $\text{F-dim}_{S^{-1}R} S^{-1}B \leq \text{F-dim}_R B$  by Proposition 8.19.

For (b), let  $F(\widehat{B}) = \widehat{B}$ -as- $R$ -module. Then  $\text{F-dim}_R F(S^{-1}R) = \text{F-dim}_R S^{-1}R = 0$ , so  $\text{F-dim}_R \widehat{B} \leq \text{F-dim}_{S^{-1}R} \widehat{B}$  by Proposition 8.19. But by part (a),  $\text{F-dim}_{S^{-1}R} \widehat{B} = \text{F-dim}_{S^{-1}R} S^{-1}\widehat{B} \leq \text{F-dim}_R \widehat{B}$ , since  $\widehat{B} \approx S^{-1}\widehat{B}$  by Proposition 5.17(b).  $\square$

One can now redo much of Chapter 5, with flat dimensions replacing projective dimensions, but there are limits. A good example is Proposition 5.8. An attempt to simply replace “projective” with “flat” is doomed. Nevertheless, it is possible to revise the argument (including the preliminary observation). (See Exercise 14.)



## Exercises

1. Suppose  $\langle A_i, \phi_{ij} \rangle$  is a limiting system on an index set  $\mathcal{I}$  with the  $A_i \in {}_R\mathbf{M}$ , where  $i \leq j \Leftrightarrow A_j \subset A_i$ . Suppose  $\mathcal{I}$  is directed. Show that  $\lim_{\mathcal{I}} A_i = \bigcap_{\mathcal{I}} A_i$ .
2. In  ${}_R\mathbf{M}$ , show that  $A \rightarrow B \rightarrow C \rightarrow 0$  is exact if and only if

$$\begin{array}{ccc} A & \longrightarrow & B \\ \downarrow & & \downarrow \\ 0 & \longrightarrow & C \end{array}$$

is a pushout square. Hence, show that any covariant functor  $F : {}_R\mathbf{M} \rightarrow {}_S\mathbf{M}$ , which commutes with all finite colimits, is necessarily right exact. (Warning! There is one small, subtle point.)

3. Suppose  $(F, \widehat{F})$  is an adjoint pair of functors between  $\widehat{\mathbf{C}}$  and  $\mathbf{C}$ . Show that  $(\widehat{F}, F)$  is an adjoint pair of functors between  $\mathbf{C}^{\text{op}}$  and  $\widehat{\mathbf{C}}^{\text{op}}$ . Be explicit about the map playing the role of  $\sigma$ .
4. You may have noticed that both limits and colimits in  ${}_R\mathbf{M}$  coincide with their constructions in  $\mathbf{Ab}$ . This is no accident. Let  $F : {}_R\mathbf{M} \rightarrow \mathbf{Ab}$  be the forgetful functor, which sends any  $B \in {}_R\mathbf{M}$  to its underlying Abelian group. Show that  $F$  is both a left adjoint ( $(F, \text{Hom}_{\mathbf{Z}}(R, \bullet))$  is the adjoint pair) and a right adjoint ( $(R \otimes_{\mathbf{Z}}, F)$  is the adjoint pair).

Hint: Chapter 2, Exercise 15, will help here.

5. Suppose  $\mathcal{I}$  is a partially ordered set, and  $\mathbf{C}$  is a category having all colimits from  $\mathcal{I}$ . Manufacture a category of colimiting systems on  $\mathcal{I}$  in  $\mathbf{C}$ , and show that (after choosing a specific model)  $\text{colim}_{\mathcal{I}}$  is a covariant functor from this category to  $\mathbf{C}$ .
6. Reformulate Exercise 5 for limiting systems, and give a one-sentence solution.
7. In the proof of Proposition 8.9, show that the category-theoretically constructed  $\text{colim}_{\mathcal{I}} f_i$  really does send  $\langle a_i \rangle + B$  to  $\langle f_i(a_i) \rangle + B'$ .
8. Suppose  $\mathcal{I}$  is any partially ordered index set (not necessarily directed), and suppose  $\langle B_i, \phi_{ij} \rangle$  is a colimiting system on  $\mathcal{I}$  in  ${}_R\mathbf{M}$ . Show that there is always a naturally defined homomorphism from  $\text{colim}_{\mathcal{I}} \text{Tor}_n(A, B_i)$  to  $\text{Tor}_n(A, \text{colim}_{\mathcal{I}} B_i)$  for each  $A \in {}_R\mathbf{M}$ .

Hint: There is a homomorphism from each  $\text{Tor}_n(A, B_j)$  to  $\text{Tor}_n(A, \text{colim}_{\mathcal{I}} B_i)$ .

9. Prove the “Fatou lemma” for flat dimensions: Suppose  $\mathcal{I}$  is directed, and  $\langle B_i, \phi_{ij} \rangle$  is a colimiting system on  $\mathcal{I}$  in  ${}_R\mathbf{M}$ . Show that

$$\text{F-dim}(\text{colim}_{\mathcal{I}} B_i) \leq \liminf_{\mathcal{I}} (\text{F-dim} B_i)$$

where, for  $r_i$  in the extended real numbers,

$$\liminf_{\mathcal{I}} r_i = \sup_{i \in \mathcal{I}} (\inf \{r_j : j \geq i\}).$$

10. Verify that  $I = \lim_{\mathbf{N}} F_n$  for the example in the second and third paragraphs of Section 8.4.
11. Give quick proofs that if  $A \in {}_R\mathbf{M}$  and if  $\mathcal{B}$  is a nonempty directed family of submodules of  $A$ , then  $\text{colim}_{\mathcal{B}} B = \bigcup \mathcal{B}$  and  $\text{colim}_{\mathcal{B}} A/B = A/\bigcup \mathcal{B}$ .
12. Give an elementary, Chapter 2-level proof of Corollary 8.18.
- Hint: See Chapter 2, Exercise 13.
13. Countable directed colimits are easy: Show that any countable directed set either has a largest element, or has a cofinal subset which is order-isomorphic to  $\mathbf{N}$ , the natural numbers.
14. Suppose  $R$  is a ring and  $a$  is a central element of  $R$  which is neither a unit nor a zero divisor. Set  $\widehat{R} = R/Ra$ . Suppose  $\widehat{B}$  is a nonzero left  $\widehat{R}$ -module with finite flat dimension as an  $\widehat{R}$ -module. Show that

$$\text{F-dim}_R \widehat{B} = 1 + \text{F-dim}_{\widehat{R}} \widehat{B}.$$

Hint: Mimic Proposition 5.8 as much as you can, including the preliminary observation preceding the proposition. Some things will definitely have to change. For example, in the second paragraph of the proof, flats are not always direct summands of free modules. Nevertheless, multiplication by  $a$  is one-to-one on any flat left  $R$ -module. Why is that?

15. (Absolute continuity for modules). Suppose  $B, B' \in {}_R\mathbf{M}$ . Write  $B \leq B'$  if  $\forall A \in \mathbf{M}_R, \text{Tor}_1(A, B') = 0 \Rightarrow \text{Tor}_1(A, B) = 0$ .
- Show that  $B \leq B'$  if and only if the following happens: Whenever  $0 \rightarrow K \rightarrow F$  is exact in  $\mathbf{M}_R$  with  $F$  flat, then  $0 \rightarrow K \otimes B' \rightarrow F \otimes B'$  exact  $\Rightarrow 0 \rightarrow K \otimes B \rightarrow F \otimes B$  exact.
  - Show that if  $B \leq B'$ , then  $\forall n \geq 1: \forall A \in \mathbf{M}_R, \text{Tor}_n(A, B') = 0 \Rightarrow \text{Tor}_n(A, B) = 0$ .
  - Show that if  $B \leq B'$ , then  $\text{F-dim} B \leq \text{F-dim} B'$ .
  - Given the situation in Proposition 8.17, show that  $A \otimes_S B \leq A$ .

# 9

## Odds and Ends

### 9.1 Injective Envelopes

This section uses material from Chapters 1 and 2.

The enough injectives theorem asserts that any left  $R$ -module can be imbedded in an injective module. An injective envelope is basically a smallest injective with this property. More specifically, if  $B \in {}_R\mathbf{M}$  with injective envelope  $E(B)$ , then any injective extension  $D$  of  $B$  contains an isomorphic copy of  $E(B)$  in the following sense:  $B \subset E(B)$ , and there is a one-to-one homomorphism  $\sigma : E(B) \rightarrow D$  such that the diagram

$$E(B) \xrightarrow{\sigma} D$$

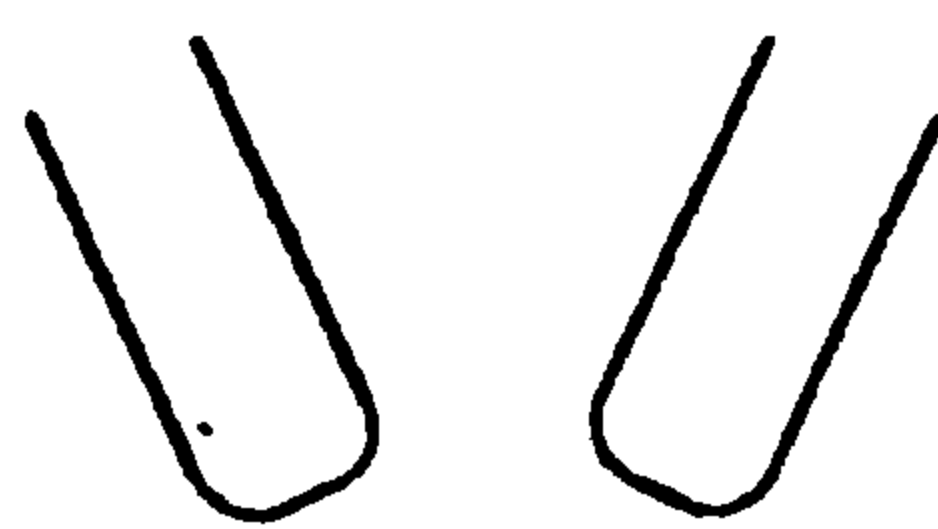

$B$

is commutative. (In what follows, this will always be the meaning of the phrase “contains an isomorphic copy of.”)  $E(B)$  also has the property that it is an “essential” extension: If  $B$  is a submodule of  $C$ , that is, if  $C$  is an extension of  $B$ , then  $C$  is an *essential* extension of  $B$  when every nonzero submodule of  $C$  has a nonzero intersection with  $B$ .

The proof that injective envelopes exist is carried out backwards. Injective envelopes are constructed as certain maximal essential extensions. Consequently, the term “injective envelope” will have an oddball definition.

Injective envelopes then turn out to be smallest injectives, as well as actually being largest essential extensions. Also, all injective envelopes of  $B$  are isomorphic as extensions of  $B$ . We start with the maximality business.

**Lemma 9.1** *Suppose  $C$  is a left  $R$ -module, and suppose  $B$  is a submodule of  $C$ . Then the set of essential extensions of  $B$  within  $C$  has a maximal element.*

**Proof:** Partially order the set of essential extensions of  $B$  within  $C$  by set inclusion. This set is nonempty since  $B$  is an essential extension of itself. To complete the proof, we need only verify that the hypotheses of Zorn's lemma are satisfied. Let  $\mathbf{C}$  be a nonempty chain (under set inclusion) of essential extensions of  $B$ , and let  $C_0$  be the union of the members of  $\mathbf{C}$ .  $C_0$  is a submodule of  $C$ , since  $\mathbf{C}$  is a chain, and  $C_0$  is an extension of  $B$  within  $C$ . It remains to show that  $C_0$  is an essential extension of  $B$ .

Suppose  $A$  is a nonzero submodule of  $C_0$ , and choose any  $a \in A$ ,  $a \neq 0$ . Choose a  $D \in \mathbf{C}$  with  $a \in D$ . Then  $Ra \subset D$ , so  $Ra \cap B \neq 0$ , since  $D$  is an essential extension of  $B$ . But now  $0 \neq Ra \cap B \subset A \cap B$ .  $\square$

We have one more Zorn's-lemma argument, concerning the opposite situation.

**Lemma 9.2** *Suppose  $C$  is a left  $R$ -module, and suppose  $B$  is a submodule of  $C$ . Then there is a submodule  $D$  of  $C$  which is maximal with respect to the property that  $D \cap B = 0$ .*

**Proof:** Partially order the set of submodules of  $C$  having trivial intersection with  $B$  by set inclusion. This set is nonempty since it includes the zero submodule. The union of a nonempty chain (under set inclusion) of submodules of  $C$  having trivial intersection with  $B$ , yields a submodule having trivial intersection with  $B$ , so every chain has an upper bound. By Zorn's lemma, there is a maximal submodule  $D$  with respect to the property that  $D \cap B = 0$ .  $\square$

The connection between this and essential extensions is the following.

**Lemma 9.3** *Suppose  $C$  is a left  $R$ -module, and suppose  $B$  is a submodule of  $C$ . Let  $D$  be any submodule of  $C$  that is maximal with respect to the property that  $D \cap B = 0$ . Let  $\pi : C \rightarrow C/D$  denote the canonical surjection. Then  $\pi$  yields an isomorphism of  $B$  with  $\pi(B)$ , and  $C/D$  is an essential extension of  $\pi(B)$ .*

**Proof:** The kernel of  $\pi$  is  $D$ , so the kernel of  $\pi|_B$  is  $D \cap B = 0$ . Hence,  $\pi$  is one-to-one on  $B$  and yields an isomorphism of  $B$  with  $\pi(B)$ .

Suppose  $D'/D$  is any nonzero submodule of  $C/D$ . Then  $D' \cap B \neq 0$ , since  $D$  is maximal with respect to having trivial intersection with  $B$ . But



if  $0 \neq x \in D' \cap B$ , then  $\pi(x) = x + D \neq 0$ , since  $\pi$  is one-to-one on  $B$ , while  $\pi(x) = x + D \in (D'/D) \cap \pi(B)$ . Hence,  $0 \neq \pi(B) \cap (D'/D)$ . Since all submodules of  $C/D$  have the form  $D'/D$ ,  $C/D$  is an essential extension of  $\pi(B) = (B + D)/D$ .  $\square$

We can now prove our first proposition, which makes the connection between essential extensions and injective modules.

**Proposition 9.4** *Suppose  $E \in {}_R\mathbf{M}$ . Then  $E$  is injective if and only if  $E$  has no nontrivial essential extensions.*

**Proof:** The proof is based on the result from Chapter 2 that injectives are absolute direct summands, and vice versa. First, suppose  $E$  is injective, and suppose  $E$  is a submodule of  $C$ . Then  $E$  is a direct summand of  $C$ , since injectives are absolute direct summands. If  $C = E \oplus F$ , then  $F \cap E = 0$ . If  $C$  is also an essential extension of  $E$ , then this implies that  $F = 0$ , that is,  $C = E$ . That is,  $C$  cannot be an essential extension of  $E$  unless  $C = E$ .

Now suppose  $E$  has no nontrivial essential extensions. This property can be restated as follows. Suppose  $B$  is a submodule of  $C$ ; make a temporary definition that  $B$  is *inessential* in  $C$  when the only essential extension of  $B$  in  $C$  is  $B$  itself. Then “ $E$  has no nontrivial essential extensions” can be restated as “ $E$  is absolutely inessential.” But absolute properties are invariant under isomorphism, thanks to the pulltab theorem in the appendix to Chapter 1. Consequently, any isomorphic copy of  $E$  also has no nontrivial essential extensions.

Now let  $C$  be any extension of  $E$ . Let  $D$  be a submodule of  $C$  that is maximal with respect to the property that  $D \cap E = 0$ . Then  $C/D$  is an essential extension of  $\pi(E)$  in accordance with Lemma 9.3, so that  $C/D = \pi(E) = (E + D)/D$ , since  $\pi(E)$  has no nontrivial essential extensions. But this just says that  $C = E + D$ . Since  $E \cap D = 0$ ,  $C = E \oplus D$ , and  $E$  is a direct summand of  $C$ . Since  $C$  was arbitrary,  $E$  is an absolute direct summand, and so is injective.  $\square$

There is one other connection between essential extensions and injectives, and it is almost an observation. We record it as a lemma for concreteness.

**Lemma 9.5** *Suppose  $B \in {}_R\mathbf{M}$ , and suppose  $B$  is a submodule of both  $C$  and  $E$ , where otherwise  $C$  and  $E$  are unrelated. Suppose  $C$  is an essential extension of  $B$ , and  $E$  is injective. Then  $E$  contains an isomorphic copy of  $C$ .*

**Proof:** Define  $\sigma : C \rightarrow E$  as any filler:

$$\begin{array}{ccccc} 0 & \longrightarrow & B & \hookrightarrow & C \\ & & \downarrow & \nearrow \sigma & \\ & & E & & \end{array}$$



defined via injectivity of  $E$ . Then  $\sigma(b) = b$  for  $b \in B$ , so  $\ker \sigma \cap B = 0$ . Since  $C$  is an essential extension of  $B$ ,  $\ker \sigma = 0$ . Thus,  $\sigma(C)$  is an isomorphic copy of  $C$  inside  $E$ .  $\square$

We can now define what we will mean by an *injective envelope*.

**Definition 9.6** *If  $B \in {}_R\mathbf{M}$ , then an injective envelope of  $B$  is an injective essential extension of  $B$ .*

From Lemma 9.5, any injective envelope will contain an isomorphic copy of any other essential extension. We're getting close to the main theorem for injective envelopes. There is one more result needed; it constructs injective envelopes.

**Proposition 9.7** *Suppose  $E$  is an injective left  $R$ -module, and  $B$  is a submodule of  $E$ . Let  $C$  be any maximal essential extension of  $B$  in  $E$ . Then  $C$  is an injective envelope of  $B$ .*

**Proof:** First, observe that  $C$  has no nontrivial essential extensions  $C'$  in  $E$ , since  $C'$  would then be an essential extension of  $B$  (contradicting maximality):  $0 \neq A \subset C' \Rightarrow 0 \neq A \cap C \Rightarrow 0 \neq (A \cap C) \cap B = A \cap B$ .

Now if  $D$  is any essential extension of  $C$  at all, then by Lemma 9.5,  $E$  contains an isomorphic copy  $D'$  of  $D$ , from which  $D' = C$  and then  $D = C$ . That is,  $C$  has no nontrivial essential extensions, so  $C$  is injective by Proposition 9.4. Since  $C$  is by definition an essential extension of  $B$ ,  $C$  is an injective envelope of  $B$ .  $\square$

**Corollary 9.8** *Any  $B \in {}_R\mathbf{M}$  has an injective envelope.*

**Proof:** In Proposition 9.7,  $E$  and  $C$  exist by the enough injectives theorem and Lemma 9.1.  $\square$

The main theorem reads as follows.

**Theorem 9.9** *Suppose  $B \in {}_R\mathbf{M}$ . Then*

- a)  *$B$  has an injective envelope, and any two injective envelopes of  $B$  are isomorphic.*
- b) *If  $E(B)$  (respectively,  $E(C)$ ) is an injective envelope of  $B$  (respectively,  $C$ ), then any  $\sigma \in \text{Hom}(B, C)$  has an extension  $\tau \in \text{Hom}(E(B), E(C))$ . Furthermore, if  $\sigma$  is one-to-one or bijective, then so are all such  $\tau$ .*
- c) *Any injective envelope  $E(B)$  of  $B$  is a largest essential extension of  $B$  in that  $E(B)$  contains an isomorphic copy of any other essential extension of  $B$ .*

d) Any injective envelope  $E(B)$  of  $B$  is a smallest injective extension of  $B$  in that any other injective extension of  $B$  contains an isomorphic copy of  $E(B)$ .

**Proof:** First, the quick deductions. (c) follows directly from Lemma 9.5, as remarked following the proof. (d) follows from the uniqueness part of (a) since any injective extension of  $B$  contains, via Lemma 9.1 and Proposition 9.7, an injective envelope. Finally, (a) follows from Lemma 9.5 and the “bijective” part of (b), by setting  $C = B$  and  $\sigma = i_B$ . There remains (b).  $\tau$  is constructed as a filler:

$$\begin{array}{ccccc}
 0 & \longrightarrow & B & \longrightarrow & E(B) \\
 & & \downarrow \sigma & & \nearrow \tau \\
 & & C & & \\
 & & \downarrow & & \\
 & & E(C) & & 
 \end{array}$$

and may *not* be unique. As in the proof of Lemma 9.5,  $\tau$  is one-to-one when  $\sigma$  is, since  $\ker \sigma = \ker \tau \cap B$  so that  $\ker \sigma = 0 \Rightarrow \ker \tau = 0$ , since  $E(B)$  is an essential extension of  $B$ . If additionally  $\sigma$  is bijective, then  $\tau(E(B)) \approx E(B)$ , so  $\tau(E(B))$  is an injective submodule of  $E(C)$ , forcing  $E(C) = \tau(E(B)) \oplus A$  for some  $A$ , since  $\tau(E(B))$  is injective and so is an absolute direct summand. But now  $A \cap C = A \cap \sigma(B) = A \cap \tau(B) \subset A \cap \tau(E(B)) = 0$  so that  $A = 0$  (and  $\tau(E(B)) = E(C)$ ), since  $E(C)$  is an essential extension of  $C$ .  $\square$

The possibility acknowledged in (b) actually happens, and the extensions ( $\tau$ 's) are not unique. This prevents  $B \mapsto E(B)$  from being used to define a functor, and is much more serious than the easily solved “For each  $B$ , choose a particular injective envelope and call it  $E(B)$ .”

**Example 32** The injective envelope of  $\mathbb{Z}$  is  $\mathbb{Q}$  (exercise). The injective envelope of  $\mathbb{Z}_p$  is the  $p$ -quasicyclic group  $C_p = \mathbb{Z}[1/p]/\mathbb{Z}p$  (exercise). The natural map  $n \mapsto n + \mathbb{Z}p$  has *lots* of extensions to  $\mathbb{Q}$ . For instance  $1/p$  may go to  $1/p + \mathbb{Z}p$ , or it may go to  $1 + 1/p + \mathbb{Z}p$ , or  $2 + 1/p + \mathbb{Z}p$ , or ...

So much for injectives. How about projectives? What happens if we reverse the arrows? To see what is needed, it is best to find first an interpretation of “essential extension” that involves only categorical concepts.

The first thing to go is “ $B$  is a submodule of  $C$ ,” which is replaced by “ $\iota : B \rightarrow C$  is one-to-one.” The  $A \subset C$  for which we have “ $A \neq 0 \Rightarrow A \cap \iota(B) \neq 0 \Leftrightarrow \iota^{-1}(A) \neq 0$ ” is replaced by an arrow  $f : C \rightarrow D$  with kernel  $A$ : “ $f$  is not one-to-one  $\Rightarrow f\iota$  is not one-to-one,” or “ $f\iota$  is one-to-one  $\Rightarrow f$  is one-to-one.”

The opposite notion to an essential extension can now be defined. A homomorphism  $\pi : C \rightarrow B$  is called a *cover* if  $\pi$  is onto, and for all  $f \in \text{Hom}(D, C)$ ,  $\pi f$  is onto  $\Rightarrow f$  is onto. The analog of an injective envelope is then a projective cover. If one exists, it will have properties similar to injective envelopes: Any projective which maps onto our module will factor through the projective cover, and so on.

The problem is existence. We shall return to all this in Section 9.6, since one situation when they do exist is for finitely generated modules over quasilocal rings. In general, however, the problem is with Lemma 9.1. The analogous construction for quotients does not Zornify.<sup>4</sup>

**Example 33**  $\mathbb{Z}_2 \in {}_{\mathbb{Z}}\mathbf{M}$  does not have a projective cover. Suppose  $P$  is projective and  $\pi : P \rightarrow \mathbb{Z}_2$  is a cover. ( $P$  is free, but we don't need that.) If  $g : \mathbb{Z} \rightarrow \mathbb{Z}_2$  is the usual map, then any filler  $f$ :

$$\begin{array}{ccc} & & \mathbb{Z} \\ & \swarrow f & \downarrow g \\ P & \xrightarrow{\pi} & \mathbb{Z}_2 \longrightarrow 0 \end{array}$$

would have to be onto, that is,  $P \approx \mathbb{Z}$  ( $\mathbb{Z}_n$  is not allowed since  $\mathbb{Z}_n$  is not projective) so that  $f$  will be an isomorphism. But then  $\tilde{f}(n) = 3f(n)$  is a filler which isn't onto.

## 9.2 Universal Coefficients

This section requires material discussed in Chapters 1, 2, 3, and 4.

The universal coefficient theorems in algebraic topology are results that allow the computation of cohomology from homology, as well as allowing the coefficient group in homology to change. There are two universal coefficient theorems, one of which is a corollary to the Künneth theorem in the next section. The other is the subject of this section. Both are really homological algebra results in disguise.

The usual starting situation is a chain complex

$$\cdots \rightarrow P_{n+1} \xrightarrow{d_{n+1}} P_n \xrightarrow{d_n} P_{n-1} \rightarrow \cdots$$

consisting of projective modules over a left hereditary ring  $R$ . That is, the ring  $R$  has left global dimension less than or equal to one, so that submodules of projective modules are projective, and quotient modules of injective modules are injective. In the application to algebraic topology,  $R$  is

<sup>4</sup>I first heard this lovely verb from George Seligman, when I was a graduate student.



The universal coefficient theorem “computes” the result if  $\text{Hom}(\bullet, C)$  is applied to the complex  $\langle P_i, d_i \rangle$  and homology is then taken.

One such result can be obtained directly without any assumptions on  $R$  or on the  $P_i$ .

**Proposition 9.10** *Suppose  $R$  is any ring for which  $\langle P_i, d_i \rangle$  is a chain complex in  ${}_R\mathbf{M}$ . Denote the homology at  $P_n$  by  $H_n$ . Suppose  $C$  is an injective left  $R$ -module. Then the homology of  $\langle \text{Hom}(P_i, C), d_i^* \rangle$  at  $\text{Hom}(P_n, C)$  is  $\text{Hom}(H_n, C)$ .*

**Proof:** Apply  $\text{Hom}(\bullet, C)$  to the unstandard picture for  $H_n$ :

$$\begin{array}{ccccccc}
 & & & & 0 & & \\
 & & & & \uparrow & & \\
 & & & & \text{Hom}(H_n, C) & & \\
 & & & & \uparrow & & \\
 \text{Hom}(P_{n+1}, C) & \xleftarrow{d_{n+1}^*} & \text{Hom}(P_n, C) & \xleftarrow{} & \text{Hom}(P_n/B_n, C) & \xleftarrow{} & 0 \\
 & & & & \uparrow & & \\
 & & & & \text{Hom}(P_n/Z_n, C) & \xleftarrow{\bar{d}_n^*} & \text{Hom}(P_{n-1}, C) \\
 & & & & \uparrow & & \\
 & & & & 0 & & 
 \end{array}$$

in which all rows and columns are exact, since  $\text{Hom}(\bullet, C)$  is an exact functor ( $C$  being injective). This is just the standard picture for the homology of  $\langle \text{Hom}(P_n, C), d_n^* \rangle$ , except that it's upside down. That is,

$$\begin{aligned}
 \text{Hom}(P_n/Z_n, C) &= \text{image of } \bar{d}_n^* \\
 &\approx \text{image of } d_n^*
 \end{aligned}$$

and

$$\text{Hom}(P_n/B_n, C) \approx \text{kernel of } d_{n+1}^*$$

so that  $\text{Hom}(H_n, C) \approx$  homology of  $\langle \text{Hom}(P_n, C), d_n^* \rangle$ . □

Proposition 9.10 serves both as a special case and as a lemma. Our main result weaves together two results (Propositions 9.11 and 9.12 below) which partially overlap. To prepare for the details, we need a bit more notation, also to be used in the rest of this section. If  $\langle P_i, d_i \rangle$  is a chain complex of left  $R$ -modules, and  $C \in {}_R\mathbf{M}$ , consider the complex introduced above:

$$\dots \leftarrow \text{Hom}(P_{n+1}, C) \xleftarrow{d_{n+1}^*} \text{Hom}(P_n, C) \xleftarrow{d_n^*} \text{Hom}(P_{n-1}, C) \leftarrow \dots$$



Denote its homology by  $H^n(C)$ . Suppose  $g \in \ker(d_{n+1}^*)$ . Then  $g \in \text{Hom}(P_n, C)$ , and  $gd_{n+1} = d_{n+1}^*(g) = 0$ . That is,  $g$  is zero on  $\text{im } d_{n+1} = B_n$ . Consequently,  $g$  induces a homomorphism from  $P_n/B_n$  to  $C$ , which restricts to a homomorphism  $\widehat{g} : H_n \rightarrow C$ , since  $H_n = Z_n/B_n \subset P_n/B_n$ . Now if  $g \in \text{im } d_n^*$ , that is,  $g = d_n^*(h) = hd_n$ , then  $g$  is zero on  $Z_n = \ker d_n$ , so that  $\widehat{g} = 0$ . That is, one may set

$$\begin{aligned} \rho : H^n(C) &\rightarrow \text{Hom}(H_n, C), \\ \rho(g + \text{im}(d_n^*)) &= \widehat{g}, \end{aligned}$$

and the resulting function  $\rho$  is well-defined. It is also a homomorphism virtually by inspection, and coincides with the isomorphism of Proposition 9.10 (exercise).

Furthermore, again virtually by inspection,  $\rho$  has the right "naturality" properties. For example, if  $\psi : C \rightarrow C'$  in  ${}_R\mathbf{M}$ , then there are induced  $\psi^n : H^n(C) \rightarrow H^n(C')$ , as well as  $\psi_* : \text{Hom}(H_n, C) \rightarrow \text{Hom}(H_n, C')$ . After putting subscripts on  $\rho$  to refer to the modules  $C$  and  $C'$ , we have a diagram

$$\begin{array}{ccc} H^n(C) & \xrightarrow{\rho_C} & \text{Hom}(H_n, C) \\ \psi^n \downarrow & & \downarrow \psi_* \\ H^n(C') & \xrightarrow{\rho_{C'}} & \text{Hom}(H_n, C') \end{array}$$

which is commutative. (This is an easy diagram chase, left as an exercise.) There is a similar naturality when the chain complex  $\langle P_i, d_i \rangle$  is mapped to a new chain complex  $\langle P'_i, d'_i \rangle$  using a chain map; details are left as an exercise.

Our first result concerning  $\rho$  in the abstract is the following.

**Proposition 9.11** *Suppose  $\langle P_i, d_i \rangle$  is a chain complex of left  $R$ -modules, and suppose that for a particular  $n$ ,  $Z_n$  is a direct summand of  $P_n$ . Then  $\rho : H^n(C) \rightarrow \text{Hom}(H_n, C)$  is onto and splits.*

**Remark:** The splitting is not asserted to be natural, as the way in which  $Z_n$  is a direct summand of  $P_n$  is not asserted to be natural.

**Proof:** The point is to define a homomorphism  $\sigma : \text{Hom}(H_n, C) \rightarrow H^n(C)$ , so that  $\rho\sigma$  is the identity on  $\text{Hom}(H_n, C)$ . We will then have  $\text{im } \rho \supset \text{im } \rho\sigma = \text{Hom}(H_n, C)$ , so that  $\rho$  is onto; also  $\sigma$  will provide the splitting.

To this end, let  $\pi : P_n \rightarrow Z_n$  denote the projection associated with  $Z_n$  as a direct summand of  $P_n$ . Suppose  $f \in \text{Hom}(H_n, C)$ . Then since  $H_n = Z_n/B_n$ , we get a unique  $\bar{f} \in \text{Hom}(Z_n, C)$  such that  $\bar{f}$  is zero on  $B_n$ , and  $\bar{f}(x) = f(x + B_n)$ . Set  $g = \bar{f}\pi \in \text{Hom}(P_n, C)$ . Now  $\pi$  is the identity

on  $Z_n$ , so  $g$  and  $\bar{f}$  agree on  $Z_n$ . In particular,  $g$  is zero on  $B_n$ , and the  $\hat{g}$  defined in the discussion of  $\rho$  agrees with  $f$ . So: Set

$$\sigma(f) = \bar{f}\pi + \text{im } d_n^* \in H^n(C).$$

$\sigma$  is again a homomorphism virtually by inspection, and  $\rho\sigma$  is the identity on  $\text{Hom}(H_n, C)$ .  $\square$

The next result is the universal coefficient exact sequence in its most general form. It overlaps with Proposition 9.11 in giving a circumstance when  $\rho$  is onto, but otherwise it is entirely separate.

**Proposition 9.12** *Suppose  $\langle P_i, d_i \rangle$  is a chain complex of left  $R$ -modules, and  $C \in {}_R\mathbf{M}$ . Suppose each  $P_i$  is projective and  $\text{I-dim } C \leq 1$ . Then there is a naturally defined exact sequence*

$$0 \rightarrow \text{Ext}_R^1(H_{n-1}, C) \rightarrow H^n(C) \xrightarrow{\rho} \text{Hom}(H_n, C) \rightarrow 0.$$

**Remark:** “Naturally defined” means that what was said above about  $\rho$  also applies to  $\text{Ext}_R^1(H_{n-1}, C) \rightarrow H^n(C)$ . The details are a little more complicated than for  $\rho$ , but only in that the idea behind functoriality of  $\text{Ext}_R^1(H_{n-1}, \bullet)$  is used. Details are left as an exercise.

**Proof:** There is a short exact injective resolution of  $C$

$$0 \rightarrow C \xrightarrow{\iota} E_0 \xrightarrow{\pi} E_1 \rightarrow 0,$$

since  $\text{I-dim } C \leq 1$  (Proposition 4.8). Put these in the second factor of  $\text{Hom}(\bullet, \bullet)$ , and the  $P_i$  in the first factor, yielding the diagram

$$\begin{array}{ccccccc}
 & & 0 & & 0 & & \\
 & & \downarrow & & \downarrow & & \\
 \cdots & \longleftarrow & \text{Hom}(P_n, C) & \xleftarrow{\text{Hom}(d_n, C)} & \text{Hom}(P_{n-1}, C) & \longleftarrow & \cdots \\
 & & \downarrow \text{Hom}(P_n, \iota) & & \downarrow \text{Hom}(P_{n-1}, \iota) & & \\
 \cdots & \longleftarrow & \text{Hom}(P_n, E_0) & \xleftarrow{\text{Hom}(d_n, E_0)} & \text{Hom}(P_{n-1}, E_0) & \longleftarrow & \cdots \\
 & & \downarrow \text{Hom}(P_n, \pi) & & \downarrow \text{Hom}(P_{n-1}, \pi) & & \\
 \cdots & \longleftarrow & \text{Hom}(P_n, E_1) & \xleftarrow{\text{Hom}(d_n, E_1)} & \text{Hom}(P_{n-1}, E_1) & \longleftarrow & \cdots \\
 & & \downarrow & & \downarrow & & \\
 & & 0 & & 0 & & 
 \end{array}$$

with exact columns since each  $P_n$  is projective. The long homology exact sequence is then



All that remains is the task of showing that the induced homomorphism  $H^n(C) \rightarrow \ker(\pi_n)_* \approx \text{Hom}(H_n, C)$  is  $\rho$ , which is left as an exercise. (Use the naturality of  $\rho$ .)  $\square$

The universal coefficient theorem is now a corollary of this.

**Theorem 9.13 (Universal Coefficient Theorem Involving Ext)** *Suppose  $R$  is a left hereditary ring, that is, suppose  $\text{LG-dim } R \leq 1$ . Suppose  $\langle P_i, d_i \rangle$  is a complex of projective left  $R$ -modules with homology  $H_n$  at  $P_n$ . Let  $C \in {}_R\mathbf{M}$ , and suppose the homology of  $\langle \text{Hom}(P_i, C), d_i^* \rangle$  is  $H^n(C)$  at  $\text{Hom}(P_n, C)$ . Then there is a naturally defined short exact sequence*

$$0 \rightarrow \text{Ext}_R^1(H_{n-1}, C) \rightarrow H^n(C) \rightarrow \text{Hom}(H_n, C) \rightarrow 0$$

*which splits (although the splitting is not asserted to be natural).*

**Proof:**  $\text{I-dim } C \leq \text{LG-dim } R \leq 1$ , so Proposition 9.12 applies, giving the short exact sequence. To see that Proposition 9.11 also applies, observe that  $B_{n-1}$  is a submodule of the projective module  $P_{n-1}$ , so  $B_{n-1}$  is projective by the projective dimension theorem ( $P_{n-1} \rightarrow P_{n-1}/B_{n-1} \rightarrow 0$  extends to a projective resolution of  $P_{n-1}/B_{n-1}$ , where first kernel is  $B_{n-1}$ , and  $\text{P-dim } (P_{n-1}/B_{n-1}) \leq \text{LG-dim } R \leq 1$ ). Consequently,  $0 \rightarrow Z_n \rightarrow P_n \rightarrow B_{n-1} \rightarrow 0$  splits (see Section 2.3), and  $Z_n$  is a direct summand of  $P_n$ .  $\square$

A slightly frivolous corollary ...

**Corollary 9.14 (Universal Coefficient Formula)** *Suppose  $R$  is a left hereditary ring,  $\langle P_i, d_i \rangle$  is a complex of projective left  $R$ -modules with homology  $H_n$  at  $P_n$ , and  $C \in {}_R\mathbf{M}$ . Then the homology  $H^n(C)$  of  $\langle \text{Hom}(P_i, C), d_i^* \rangle$  at  $\text{Hom}(P_n, C)$  is unnaturally isomorphic to*

$$\text{Ext}_R^1(H_{n-1}, C) \oplus \text{Hom}(H_n, C).$$

### 9.3 The Künneth Theorems

This section uses material from Chapters 1, 2, 3, and 4. Furthermore, the next two paragraphs, which are introductory and may be omitted, refer to Section 9.2 (the previous section).

The universal coefficient theorem of the last section is an island of homological algebra in the sea of algebraic topology. Another island is the Künneth formula, except that what one has in the homological algebra setting is not so definitive. As in Corollary 9.14 in the last section, there

is a Künneth formula; it is a consequence of a more general short exact sequence (the Künneth exact sequence) which splits under certain circumstances. One major difference is that here the splitting will require more from the ring. In Corollary 9.14, the assumption that  $R$  was left hereditary did two things. First, it forced  $\text{I-dim } (C) \leq 1$ . Next, it forced  $Z_n$  to be a direct summand of  $P_n$ , which caused the splitting. Here, the natural condition on  $R$  is that  $\text{W-dim } R \leq 1$ . This no longer forces the second conclusion, nor the splitting. As a result, there is a slight irony in the way the phrases roll off the algebraic topologist's tongue: *universal coefficient theorem* and *Künneth formula*. They should be the other way around, at least from the homological algebraist's perspective.

There is another difference. There is no analog of Proposition 9.11. Furthermore, in the analog of Proposition 9.12, the assumption " $\text{I-dim } C \leq 1$ " will be replaced: We shall jump immediately to the assumption that  $\text{W-dim } R \leq 1$ .

The Künneth exact sequence, as well as the Künneth formula, are used in algebraic topology to compute the homology of product spaces. The Eilenberg–Zilber theorem (which is topological) sets up the algebraic picture, and the Künneth theorems (which are algebraic) knock it down. The approach we follow is modeled on Greenberg and Harper [26, pp. 253–257], at least in part. The setting is one where we have two chain complexes  $\langle F_i, d_i \rangle$  and  $\langle F'_i, d'_i \rangle$ , where  $F_i \in \mathbf{M}_R$  and  $F'_i \in {}_R\mathbf{M}$ . Form the tensor array as in Section 3.3 ( $1_j = i_{F_j}; 1'_j = i_{F'_j}$ ):

$$\begin{array}{ccccccc}
 & & \vdots & & \vdots & & \\
 & & \downarrow & & \downarrow & & \\
 \cdots & \longrightarrow & F_i \otimes F'_j & \xrightarrow{1_i \otimes d'_j} & F_i \otimes F'_{j-1} & \longrightarrow & \cdots \\
 & & \downarrow d_i \otimes 1'_j & & \downarrow d_i \otimes 1'_{j-1} & & \\
 \cdots & \longrightarrow & F_{i-1} \otimes F'_j & \xrightarrow{1_{i-1} \otimes d'_j} & F_{i-1} \otimes F'_{j-1} & \longrightarrow & \cdots \\
 & & \downarrow & & \downarrow & & \\
 & & \vdots & & \vdots & & 
 \end{array}$$

Make the following definitions (establishing notation):

$$Z_n = \ker d_n$$

$$B_n = \text{im } d_{n+1}$$

$$H_n = Z_n / B_n$$

$$Z'_n = \ker d'_n$$



$$B'_n = \text{im } d'_{n+1}$$

$$H'_n = Z'_n / B'_n$$

$$C_{i,j} = F_i \otimes F'_j$$

$$d_{i,j} = 1_i \otimes d'_j$$

$$\partial_{i,j} = d_i \otimes 1'_j$$

$$\bar{F}_n = \bigoplus_{i+j=n} C_{i,j}$$

$$\bar{d}_n : \bar{F}_n \rightarrow \bar{F}_{n-1} \text{ via}$$

$$\bar{d}_n = \left( \bigoplus_{i+j=n} d_{i,j} \right) + \left( \bigoplus_{i+j=n} (-1)^j \partial_{i,j} \right)$$

$$\bar{Z}_n = \ker \bar{d}_n$$

$$\bar{B}_n = \text{im } \bar{d}_{n+1}$$

$$\bar{H}_n = \bar{Z}_n / \bar{B}_n.$$

In defining  $\bar{d}_n$ , we treat, for example,  $d_{i,j}$  as mapping  $C_{i,j}$  to  $C_{i,j-1}$  and then into  $\bar{F}_{n-1}$ . By replacing each  $C_{i,j}$  with its image in  $\bar{F}_{i+j}$ , we can also assume that  $C_{i,j} \subset \bar{F}_{i+j}$ .

The above conventions define the tensor product of complexes  $\langle \bar{F}_i, \bar{d}_i \rangle = \langle F_i, d_i \rangle \otimes \langle F'_i, d'_i \rangle$ . Take particular notice that the sign convention for  $\bar{d}_n$  is *not* the one in the discussion following Corollary 3.10. That convention fits the requirements of Proposition 6.12 later, but has the peculiar vice of not being associative. Nevertheless, the old signs arise when we take  $\langle F_i, d_i \rangle \otimes \langle F'_i, (-1)^{i+1} d'_i \rangle$ , and  $\langle F'_i, (-1)^{i+1} d'_i \rangle$  has the same homology as  $\langle F'_i, d'_i \rangle$  does. Consequently, the data we enter into the Künneth exact sequence (and formula) are unaffected. (Slightly messy exercise: The homology of the tensor product is also unaffected.)

There is a homomorphism, the Künneth homomorphism, which is defined as follows. Let  $i$  and  $j$  denote fixed indices. The bilinear map  $\otimes : F_i \times F'_j \rightarrow F_i \otimes F'_j = C_{i,j} \subset \bar{F}_{i+j}$  has the following properties:

i) If  $u \in B_i$ ,  $v \in Z'_j$ , then  $u \otimes v \in \bar{B}_{i+j}$ . Reason: If  $u = d_{i+1} \hat{u}$ , then

$$\bar{d}_{i+j+1}((-1)^j \hat{u} \otimes v) = u \otimes v \text{ (where } \hat{u} \otimes v \in C_{i+1,j}),$$

since  $d_{i+1} \otimes 1'_j(\hat{u} \otimes v) = u \otimes v$ , while  $1_{i+1} \otimes d'_j(\hat{u} \otimes v) = 0$ .

ii) Similarly, if  $u \in Z_i$ ,  $v \in B'_j$ , then  $u \otimes v \in \bar{B}_{i+j}$ .

iii) If  $u \in Z_i$ ,  $v \in Z'_j$ , then  $u \otimes v \in \bar{Z}_{i+j}$  by a direct calculation, since both  $d_i \otimes 1'_j$  and  $1_i \otimes d'_j$  kill  $u \otimes v$ .

We can now define  $\phi_{i,j} : Z_i \times Z'_j \rightarrow \overline{H}_{i+j}$  by

$$\phi_{i,j}(u, v) = u \otimes v + \overline{B}_{i+j}.$$

(iii) says that  $\phi_{i,j}$  does take values in  $\overline{H}_{i+j}$ , while the fact that  $\phi_{i,j}$  kills  $B_i \times Z'_j$  and  $Z_i \times B'_j$  says that we can successively produce fillers  $\widehat{\phi}_{i,j}$  and  $\overline{\phi}_{i,j}$

$$\begin{array}{ccccc} (Z_i/B_i) \times (Z'_j/B'_j) & \longrightarrow & Z_i \times (Z'_j/B'_j) & \longrightarrow & Z_i \times Z'_j \\ & \searrow \widehat{\phi}_{i,j} & & \searrow \widehat{\phi}_{i,j} & \downarrow \phi_{i,j} \\ & & & & \overline{H}_{i+j} \\ & \searrow \overline{\phi}_{i,j} & & \searrow \overline{\phi}_{i,j} & \nearrow \\ & & & & \end{array}$$

Now  $\overline{\phi}_{i,j} : H_i \times H'_j \rightarrow \overline{H}_{i+j}$  is bilinear, so we get a filler  $\psi_{i,j}$

$$\begin{array}{ccc} H_i \times H'_j & \longrightarrow & H_i \otimes H'_j \\ & \searrow \overline{\phi}_{i,j} & \downarrow \psi_{i,j} \\ & & \overline{H}_{i+j} \end{array}$$

The Künneth homomorphism is

$$\begin{aligned} \kappa &: \bigoplus_{i+j=n} H_i \otimes H_j \rightarrow \overline{H}_n \\ \kappa &= \sum_{i+j=n} \psi_{i,j} \end{aligned}$$

$$\text{or } \kappa\left(\bigoplus_{i+j=n} (u_i + B_i) \otimes (v_j + B'_j)\right) = \left(\sum_{i+j=n} u_i \otimes v_j\right) + \overline{B}_n.$$

The objective is to say something intelligent about the homology  $\overline{H}_n$  of the chain complex  $\langle \overline{F}_i, \overline{d}_i \rangle$  at  $\overline{F}_n$ . We start this by proving a theorem whose hypotheses seem almost dopey.

**Proposition 9.15** *Suppose  $\langle F_i, d_i \rangle$  and  $\langle F'_i, d'_i \rangle$  are chain complexes in  $\mathbf{M}_R$  and  ${}_R\mathbf{M}$ , respectively, where  $R$  is any ring. Suppose that for all  $j$ ,  $d'_j = 0$ , and  $F'_j$  is flat. Then the Künneth homomorphism is an isomorphism.*

**Proof:** If  $d'_j = 0$  for all  $j$ , then  $d_{i,j} = 0$  for all  $i$  and  $j$  so that

$$\overline{d}_n = \bigoplus_{i+j=n} (-1)^j \partial_{i,j},$$

and consequently

$$\begin{aligned}\bar{Z}_n &\approx \bigoplus_{i+j=n} (Z_i \otimes F'_j), \\ \bar{B}_n &\approx \bigoplus_{i+j=n} (B_i \otimes F'_j), \text{ and} \\ \bar{H}_n &\approx \bigoplus_{i+j=n} (Z_i/B_i) \otimes F'_j,\end{aligned}$$

since each  $\otimes F'_j$  is an exact functor ( $F'_j$  being flat). Since  $F'_j \approx H'_j$ , the Künneth homomorphism yields an isomorphism.  $\square$

At this point we make our standing assumption for the rest of this section, namely

$$\text{W-dim } R \leq 1.$$

Hence, if  $F$  is flat, and if  $A$  is a submodule of  $F$ , then  $\text{F-dim } F/A \leq \text{W-dim } R \leq 1$ , so that  $A$  is flat by the flat dimension theorem ( $F \rightarrow F/A \rightarrow 0$  extends to a flat resolution of  $F/A$  having  $A$  as its first kernel). That is, every submodule of a flat  $R$ -module (left or right) is flat.

As an example of how this works, suppose that  $F'_n$  is flat. Then so are  $Z'_n$  and  $B'_n$ . In fact,  $0 \rightarrow B'_n \rightarrow Z'_n \rightarrow H'_n \rightarrow 0$  is a flat resolution of  $H'_n$ .

To get a reduction to the case in Proposition 9.15, define  $B_n^* = B'_{n-1}$ . Then  $\langle Z'_n, 0 \rangle$  and  $\langle B_n^*, 0 \rangle$  are chain complexes of the type discussed in Proposition 9.15. Furthermore, the vertical arrows in

$$\begin{array}{ccccccc} & & 0 & & 0 & & 0 \\ & & \downarrow & & \downarrow & & \downarrow \\ \cdots & \longrightarrow & Z'_{n+1} & \xrightarrow{0} & Z'_n & \xrightarrow{0} & Z'_{n-1} \longrightarrow \cdots \\ & & \downarrow & & \downarrow & & \downarrow \\ \cdots & \longrightarrow & F'_{n+1} & \xrightarrow{d'_{n+1}} & F'_n & \xrightarrow{d'_n} & F'_{n-1} \longrightarrow \cdots \\ & & \downarrow d'_{n+1} & & \downarrow d'_n & & \downarrow d'_{n-1} \\ \cdots & \longrightarrow & B_{n+1}^* & \xrightarrow{0} & B_n^* & \xrightarrow{0} & B_{n-1}^* \longrightarrow \cdots \\ & & \downarrow & & \downarrow & & \downarrow \\ & & 0 & & 0 & & 0 \end{array}$$

give a short exact sequence of chain complexes. If the  $F_i$  are also flat, then we get complexes

$$\begin{aligned}\bar{F}'_n &= \bigoplus_{i+j=n} F_i \otimes Z'_j & \bar{d}'_n &= \bigoplus_{i+j=n} (-1)^j d_i \otimes i_{Z'_j} \\ \bar{F}_n &= \bigoplus_{i+j=n} C_{i,j} \\ \bar{F}^*_n &= \bigoplus_{i+j=n} F_i \otimes B^*_j & \bar{d}^*_n &= \bigoplus_{i+j=n} (-1)^j d_i \otimes i_{B^*_j}\end{aligned}$$

and we get a short exact sequence of chain complexes

$$\begin{array}{ccccccc} & & 0 & & 0 & & 0 \\ & & \downarrow & & \downarrow & & \downarrow \\ \cdots & \longrightarrow & \bar{F}'_{n+1} & \longrightarrow & \bar{F}'_n & \longrightarrow & \bar{F}'_{n-1} \longrightarrow \cdots \\ & & \downarrow & & \downarrow & & \downarrow \\ \cdots & \longrightarrow & \bar{F}_{n+1} & \longrightarrow & \bar{F}_n & \longrightarrow & \bar{F}_{n-1} \longrightarrow \cdots \\ & & \downarrow & & \downarrow & & \downarrow \\ \cdots & \longrightarrow & \bar{F}^*_{n+1} & \longrightarrow & \bar{F}^*_n & \longrightarrow & \bar{F}^*_{n-1} \longrightarrow \cdots \\ & & \downarrow & & \downarrow & & \downarrow \\ & & 0 & & 0 & & 0 \end{array}$$

(since all  $F_i$  are flat), which can be exploited to give the Künneth exact sequence.

**Theorem 9.16 (Künneth Exact Sequence)** *Suppose  $R$  is a ring, with  $\text{W-dim } R \leq 1$ . Suppose  $\langle F_i, d_i \rangle$  is a chain complex of flat right  $R$ -modules, while  $\langle F'_i, d'_i \rangle$  is a chain complex of flat left  $R$ -modules. Let  $H_n$  denote the homology of  $\langle F_i, d_i \rangle$  at  $F_n$ , and  $H'_n$  the homology of  $\langle F'_i, d'_i \rangle$  at  $F'_n$ . Form the tensor complex*

$$\langle \bar{F}_i, \bar{d}_i \rangle = \langle F_i, d_i \rangle \otimes \langle F'_i, d'_i \rangle.$$

*Then the homology  $\bar{H}_n$  of  $\langle \bar{F}_i, \bar{d}_i \rangle$  at  $\bar{F}_n$  fits naturally into a short exact sequence*

$$0 \rightarrow \bigoplus_{i+j=n} H_i \otimes H'_j \xrightarrow{\kappa} \bar{H}_n \rightarrow \bigoplus_{i+j=n-1} \text{Tor}_1^R(H_i, H'_j) \rightarrow 0.$$

**Proof:** Adopt the notation in the discussion preceding Proposition 9.15. Let  $\bar{H}'_n$  denote the homology at  $\bar{F}'_n$  of the complex  $\langle \bar{F}'_i, \bar{d}'_i \rangle$ , and  $\bar{H}^*_n$  the homology at  $\bar{F}^*_n$  of the complex  $\langle \bar{F}^*_i, \bar{d}^*_i \rangle$ . We get a long exact sequence

$$\begin{array}{c}
 \dots \xrightarrow{\hspace{10em}} \delta_{n+1} \\
 \xrightarrow{\hspace{10em}} \overline{H}'_n \longrightarrow \overline{H}_n \longrightarrow \overline{H}_n^* \xrightarrow{\hspace{10em}} \delta_n \\
 \xrightarrow{\hspace{10em}} \overline{H}'_{n-1} \longrightarrow \overline{H}_{n-1} \longrightarrow \dots
 \end{array}$$

from which we get for each  $n$  a short exact sequence

$$0 \rightarrow \overline{H}'_n / \text{im } \delta_{n+1} \rightarrow \overline{H}_n \rightarrow \ker \delta_n \rightarrow 0.$$

We know that

$$\overline{H}'_n \approx \bigoplus_{i+j=n} H_i \otimes Z'_j$$

and

$$\overline{H}_n^* \approx \bigoplus_{i+j=n} H_i \otimes B_j^* = \bigoplus_{i+j=n} H_i \otimes B'_{j-1}$$

by Proposition 9.15. We need to analyze

$$\delta_{n+1} : \overline{H}_{n+1}^* \rightarrow \overline{H}'_n$$

to identify the kernel and image. Now

$$\overline{H}_{n+1}^* = \bigoplus_{i+j=n+1} H_i \otimes B_j^* = \bigoplus_{i+j=n} H_i \otimes B'_j.$$

Given  $\Sigma u_i \otimes b'_j \in \overline{H}_{n+1}^*$ , we compute  $\delta_{n+1}(\Sigma u_i \otimes b'_j)$  as follows. Find for each  $j$ , a  $v'_j \in F'_{j+1}$  such that  $d'_{j+1}(v'_j) = b'_j$ ; this pulls  $\Sigma u_i \otimes b'_j$  back to  $\Sigma u_i \otimes v'_j \in \overline{F}_{n+1}$  with each  $u_i \otimes v'_j \in C_{i,j+1}$ . Now each  $u_i$  represents a member of  $H_i$ , so  $d_i u_i = 0$  and  $\bar{d}_{n+1}(\Sigma u_i \otimes v'_j) = \Sigma u_i \otimes d'_{j+1} v'_j = \Sigma u_i \otimes b'_j$ ; we're back where we started. The map  $\delta_{n+1}$  simply looks at this inside  $\bigoplus H_i \otimes Z'_j$ , since the  $\overline{F}'_n \rightarrow \overline{F}_n$  maps are obtained from the set inclusions  $Z'_j \hookrightarrow F'_j$ . That is,

$$\begin{aligned}
 \delta_{n+1} & : \bigoplus_{i+j=n} H_i \otimes B'_j \rightarrow \bigoplus_{i+j=n} H_i \otimes Z'_j \\
 \delta_{n+1} & = \bigoplus_{i+j=n} H_i \otimes (B'_j \hookrightarrow Z'_j).
 \end{aligned}$$



But  $0 \rightarrow B'_j \hookrightarrow Z'_j \rightarrow H'_j \rightarrow 0$  is a flat resolution of  $H'_j$ , so the kernel of  $\delta_{n+1}$  is

$$\bigoplus_{i+j=n} \operatorname{Tor}_1^R(H_i, H'_j)$$

while  $\bigoplus(H_i \otimes Z'_j)/\operatorname{im} \delta_{n+1}$  is

$$\bigoplus_{i+j=n} H_i \otimes H'_j.$$

Furthermore, the injection  $Z'_j \hookrightarrow F'_j$  leads directly to the Künneth homomorphism  $\kappa$ . Since  $\ker \delta_n$  ( $\delta_n$ , not  $\delta_{n+1}$ ) is now

$$\bigoplus_{i+j=n-1} \operatorname{Tor}_1^R(H_i, H'_j)$$

we are down to the naturality question.

Naturality is most easily seen, for example, from chain maps  $\langle \varphi_n \rangle$  from  $F'_n$  to  $F_n^+$ , by drawing all the diagrams preceding Proposition 9.15 in two layers, for example,

$$\begin{array}{ccccccc}
 & & 0 & & 0 & & 0 \\
 & & \downarrow & & \downarrow & & \downarrow \\
 \cdots & \longrightarrow & Z'_{n+1} & \longrightarrow & Z'_n & \longrightarrow & \cdots \\
 & & \downarrow & \searrow & \downarrow & \searrow & \downarrow \\
 \cdots & \longrightarrow & Z_{n+1}^+ & \longrightarrow & Z_n^+ & \longrightarrow & \cdots \\
 & & \downarrow & \searrow & \downarrow & \searrow & \downarrow \\
 \cdots & \longrightarrow & F'_{n+1} & \longrightarrow & F'_n & \longrightarrow & \cdots \\
 & & \downarrow & \searrow & \downarrow & \searrow & \downarrow \\
 \cdots & \longrightarrow & F_{n+1}^+ & \longrightarrow & F_n^+ & \longrightarrow & \cdots \\
 & & \downarrow & \searrow & \downarrow & \searrow & \downarrow \\
 \cdots & \longrightarrow & B_{n+1}^* & \longrightarrow & B_n^* & \longrightarrow & \cdots \\
 & & \downarrow & \searrow & \downarrow & \searrow & \downarrow \\
 \cdots & \longrightarrow & B_{n+1}^{+*} & \longrightarrow & B_n^{+*} & \longrightarrow & \cdots \\
 & & \downarrow & & \downarrow & & \downarrow \\
 & & 0 & & 0 & & 0
 \end{array}$$

Tensor with  $F_j$  and add. Chain maps on  $\langle F_i, d_i \rangle$  are even easier; details are left to the reader.  $\square$

**Corollary 9.17 (Universal Coefficient Sequence Involving Tor)**  
 Suppose  $R$  is a ring with  $W\text{-dim } R \leq 1$ . Suppose  $\langle F_i, d_i \rangle$  is a chain complex of flat right  $R$ -modules, and  $B \in {}_R\mathbf{M}$ . Let  $H_n$  denote the homology

of  $\langle F_i, d_i \rangle$  at  $F_n$ , and  $H_n(B)$  the homology of  $\langle F_i \otimes B, d_i \otimes B \rangle$  at  $F_n \otimes B$ . Then there is a natural short exact sequence

$$0 \rightarrow H_n \otimes B \rightarrow H_n(B) \rightarrow \text{Tor}_1^R(H_{n-1}, B) \rightarrow 0.$$

**Proof:** Let  $0 \rightarrow F'_1 \xrightarrow{d'_1} F'_0 \rightarrow B \rightarrow 0$  denote a flat resolution of  $B$ , possible by the flat dimension theorem since  $\text{F-dim } B \leq 1$ . Let  $F'_n = 0$  for  $n \neq 0, 1$ , and  $d'_n = 0$  for  $n \neq 1$ . We now get a complex  $\langle F'_i, d'_i \rangle$  whose homology is  $B$  at  $F'_0$  and zero everywhere else, that is,  $H'_0 = B$ , and  $H'_j = 0$  if  $j \neq 0$ . Applying the Künneth exact sequence, only the terms where  $j = 0$  survive giving the sequence

$$0 \rightarrow H_n \otimes B \rightarrow \bar{H}_n \rightarrow \text{Tor}_1^R(H_{n-1}, B) \rightarrow 0.$$

Now consider the following short exact sequence of complexes:

$$\begin{array}{ccccccc}
 & & \vdots & & \vdots & & \vdots \\
 & & \downarrow & & \downarrow & & \downarrow \\
 0 & \longrightarrow & 0 & \longrightarrow & 0 & \longrightarrow & 0 \longrightarrow 0 \\
 & & \downarrow & & \downarrow & & \downarrow \\
 0 & \longrightarrow & 0 & \longrightarrow & 0 & \longrightarrow & 0 \longrightarrow 0 \\
 & & \downarrow & & \downarrow & & \downarrow \\
 0 & \longrightarrow & F'_1 & \xrightarrow{=} & F'_1 & \longrightarrow & 0 \longrightarrow 0 \\
 & & \downarrow & & \downarrow & & \downarrow \\
 & & = & & \downarrow & & \downarrow \\
 0 & \longrightarrow & F'_1 \hookrightarrow & \longrightarrow & F'_0 & \longrightarrow & B \longrightarrow 0 \\
 & & \downarrow & & \downarrow & & \downarrow \\
 & & 0 & & 0 & & 0
 \end{array}$$

The righthand column complex, tensored with  $\langle F_i, d_i \rangle$ , is  $\langle F_i \otimes B, d_i \otimes 1_B \rangle$ . Unfortunately, the Künneth exact sequence does not apply to the righthand column, but it does apply to the middle and lefthand columns, tensored with  $\langle F_i, d_i \rangle$ . The middle column is the one just discussed. Furthermore, we get a short exact sequence of complexes after tensoring with  $\langle F_i, d_i \rangle$  since all  $F_n$  are flat. When the Künneth exact sequence is applied to the lefthand column, the result is identically zero; consequently, by the long exact sequence for homology of complexes,  $H_n(B) \approx \bar{H}_n$ , so that

$$0 \rightarrow H_n \otimes B \rightarrow H_n(B) \rightarrow \text{Tor}_1^R(H_{n-1}, B) \rightarrow 0$$

is exact.

Naturality in morphisms of chain complexes is direct. As for naturality in morphisms  $\varphi : B \rightarrow B^+$ , replace  $F'_0$  with a projective;  $F'_1$  is still flat but may not be projective. Similarly, we may choose a flat resolution  $0 \rightarrow F_1^{+'} \rightarrow F_0^{+'} \rightarrow B^+ \rightarrow 0$  with  $F_0^{+'}$  projective, and we also get fillers  $\varphi'_0$  and  $\varphi'_1$ :

$$\begin{array}{ccccccc} 0 & \longrightarrow & F'_1 & \xrightarrow{\quad} & F'_0 & \xrightarrow{\pi} & B \longrightarrow 0 \\ & & \downarrow \varphi'_1 & & \downarrow \varphi'_0 & & \downarrow \varphi \\ 0 & \longrightarrow & F_1^{+'} & \xrightarrow{\quad} & F_0^{+'} & \xrightarrow{\pi^+} & B^+ \longrightarrow 0 \end{array}$$

as follows

$$\varphi'_0 : \begin{array}{ccc} & & F'_0 \\ & \swarrow \varphi'_0 & \downarrow \pi \\ & & B \\ & \searrow \varphi'_0 & \downarrow \varphi \\ F_0^{+'} & \xrightarrow{\pi^+} & B^+ \longrightarrow 0 \end{array}$$

$$\varphi'_1 : \begin{cases} \pi^+ \varphi'_0(F'_1) = \varphi \pi(F'_1) = 0, & \text{so} \\ \varphi'_0(F'_1) \subset \ker \pi^+ = F_1^{+'} \\ \varphi'_1 = \varphi'_0|_{F'_1} \end{cases}$$

This leads to a chain map  $\langle \varphi'_n \rangle$  once we set  $\varphi'_n = 0$ ,  $n \neq 0, 1$ . The chain map sets up the appropriate homomorphisms by naturality of the Künneth sequence.  $\square$

There remains the question of when the Künneth sequence actually splits, leading to the Künneth *formula* with  $\bar{H}_n$  being isomorphic to the direct sum of the two ends. For this we need the Künneth homomorphism  $\kappa$  to split, that is, we need a map  $\pi : \bar{H}_n \rightarrow \bigoplus H_i \otimes H'_j$  for which  $\pi\kappa$  is the identity. This requires a lot more than weak dimension one can provide.

**Proposition 9.18** *Suppose  $R$  is a ring, with  $\text{RG-dim } R \leq 1$  and  $\text{LG-dim } R \leq 1$ . Suppose  $\langle F_i, d_i \rangle$  is a chain complex of projective right  $R$ -modules, while  $\langle F'_i, d'_i \rangle$  is a chain complex of projective left  $R$ -modules. Then the Künneth exact sequence splits (although the splitting is not asserted to be natural).*

**Proof:** Again adopt the notation preceding Proposition 9.15. Then  $\text{P-dim } (F_{n-1}/B_{n-1}) \leq \text{RG-dim } R \leq 1$ , so  $B_{n-1}$  is projective by the projective dimension theorem ( $F_{n-1} \rightarrow F_{n-1}/B_{n-1} \rightarrow 0$  extends to a projective resolution of  $F_{n-1}/B_{n-1}$  whose first kernel is  $B_{n-1}$ ). Consequently,

$0 \rightarrow Z_n \rightarrow F_n \rightarrow B_{n-1} \rightarrow 0$  is split exact, giving a homomorphism  $\pi_n : F_n \rightarrow H_n$  as the composite of the quotient following the splitting  $F_n \rightarrow Z_n \rightarrow H_n$ . Similarly, there is a homomorphism  $\pi'_n : F'_n \rightarrow H'_n$ . We thus get

$$\pi = \bigoplus_{i+j=n} \pi_i \otimes \pi'_j : \bigoplus_{i+j=n} F_i \otimes F'_j \rightarrow \bigoplus_{i+j=n} H_i \otimes H'_j$$

or  $\pi : \bar{F}_n \rightarrow \bigoplus_{i+j=n} H_i \otimes H'_j$ .

Almost by inspection,  $\pi \kappa(u_i \otimes v'_j) = u_i \otimes v'_j$ ; we need only show that  $\pi$  is actually well-defined on  $\bar{H}_n$ , that is, that  $\pi$  sends  $\bar{B}_n$  to zero. But  $\pi_i$  sends  $B_i$  to zero and  $\pi'_j$  sends  $B'_j$  to zero. It follows that  $\pi_i \otimes \pi'_j$  sends  $F_i \otimes B'_j$  and  $B_i \otimes F'_j$  to zero. However,

$$\begin{aligned} \bar{d}_{n+1} \left( \bigoplus_{i+j=n+1} \left( \sum_k u_{i,j,k} \otimes v'_{i,j,k} \right) \right) &= \bigoplus_{i+j=n} \left( \sum_k u_{i,j+1,k} \otimes d'_{j+1}(v'_{i,j+1,k}) \right) \\ &+ (-1)^j d_{i+1}(u_{i+1,j,k}) \otimes v'_{i+1,j,k} \in \bigoplus_{i+j=n} (F_i \otimes B'_j + B_i \otimes F'_j), \end{aligned}$$

that is,

$$\bar{B}_n \subset \bigoplus_{i+j=n} (F_i \otimes B'_j + B_i \otimes F'_j) \subset \bigoplus_{i+j=n} \ker(\pi_i \otimes \pi'_j). \quad \square$$

**Remark:** In the above,  $F_i \otimes B'_j$  is treated as a submodule of  $F_i \otimes F'_j$ . This is allowed since  $F_i$  is flat: Apply  $F_i \otimes$  to  $0 \rightarrow B'_j \rightarrow F'_j$ . Similarly,  $B_i \otimes F'_j$  can be viewed as a submodule of  $F_i \otimes F'_j$ .

The Künneth theorem has some algebraic consequences; Hilton and Stammach [34, pp. 180–183] present some examples, and the next proposition is a variant of what they have. One is tempted to call the second part, “the bizarre exact sequence.”

**Proposition 9.19** *Suppose  $\text{W-dim } R \leq 1$ , and suppose  $R$  is flat as a  $\mathbb{Z}$ -module. Suppose  $A \in \mathbf{M}_R$ ,  $B \in {}_R\mathbf{M}$ , and  $G \in \mathbf{Ab}$ . Then  $\text{Tor}_1^{\mathbb{Z}}(B, G) \in {}_R\mathbf{M}$ , and*

$$\text{Tor}_1^R(A, \text{Tor}_1^{\mathbb{Z}}(B, G)) \approx \text{Tor}_1^{\mathbb{Z}}(\text{Tor}_1^R(A, B), G).$$

Furthermore, if  $R$  is projective as a  $\mathbb{Z}$ -module, then there is a short exact sequence

$$\begin{aligned} 0 &\rightarrow A \otimes_R \text{Tor}_1^{\mathbb{Z}}(B, G) \\ &\rightarrow (\text{Tor}_1^R(A, B) \otimes_{\mathbb{Z}} G) \oplus (\text{Tor}_1^{\mathbb{Z}}(A \otimes_R B, G)) \\ &\rightarrow \text{Tor}_1^R(A, B \otimes_{\mathbb{Z}} G) \\ &\rightarrow 0 \end{aligned}$$

which splits if  $\text{LG-dim } R \leq 1$  and  $\text{RG-dim } R \leq 1$ .

**Remark:** As will be seen from the proof, only the first isomorphism is natural. One more thing: Don't think about that short exact sequence while operating heavy machinery.

**Proof:** The idea is to use the Künneth theorem twice, once with  $R$  and once with  $\mathbb{Z}$ . The complexes are the ones appearing in Proposition 3.9 and its corollary. To this end, let

$$\cdots \xrightarrow{d_2} P_1 \xrightarrow{d_1} P_0 \rightarrow A \rightarrow 0$$

denote a free resolution of  $A$ , and

$$\cdots \xrightarrow{d'_2} P'_1 \xrightarrow{d'_1} P_0 \rightarrow B \rightarrow 0$$

a free resolution of  $B$ . (Free objects are easiest to handle here.) Furthermore, let

$$0 \rightarrow Q_1 \xrightarrow{\partial_1} Q_0 \rightarrow G \rightarrow 0$$

denote a projective (i.e., free) resolution of  $G$  as a  $\mathbb{Z}$ -module.

To start the game, set

$$F_n = \bigoplus_{i+j=n} P_i \otimes_R P'_j$$

and

$$D_n = \bigoplus_{i+j=n} (i_{P_i} \otimes d'_j + (-1)^j d_i \otimes i_{P'_j}).$$

$\langle F_n, D_n \rangle$  is now a complex whose homology is  $\text{Tor}_n^R(A, B)$  at  $F_n$ , by the proof of Proposition 3.9 and its corollary, since  $\langle F_n, D_n \rangle = \langle P_i, d_i \rangle \otimes \langle P'_j, d'_j \rangle$ .

Next, set  $F'_n = Q_n$ . Only  $H'_0$  is nonzero; it is  $G$ . Now apply the Künneth theorem to the tensor product over  $\mathbb{Z}$ , yielding the exact sequences

$$0 \rightarrow 0 \rightarrow \bar{H}_2 \rightarrow \text{Tor}_1^{\mathbb{Z}}(\text{Tor}_1^R(A, B), G) \rightarrow 0,$$

$$0 \rightarrow \text{Tor}_1^R(A, B) \otimes_{\mathbb{Z}} G \rightarrow \bar{H}_1 \rightarrow \text{Tor}_1^{\mathbb{Z}}(A \otimes_R B, G) \rightarrow 0,$$

and

$$0 \rightarrow (A \otimes_R B) \otimes_{\mathbb{Z}} G \rightarrow \bar{H}_0 \rightarrow 0 \rightarrow 0.$$



This is allowed since each  $F_n$  is a direct sum of  $P_i \otimes_R P'_j$ , which are in turn direct sums of  $R \otimes_R R$  since each  $P_i$  and  $P'_j$  is free. But  $R \otimes_R R \approx R$ , which is flat as a  $\mathbb{Z}$ -module by assumption, so each  $F_n$  is flat as a  $\mathbb{Z}$ -module, and Theorem 9.16 applies. Furthermore, if  $R$  is actually projective as a  $\mathbb{Z}$ -module, then each  $F_n$  will be  $\mathbb{Z}$ -projective, so that Proposition 9.18 will apply to split the sequence for  $\overline{H}_1$ , yielding

$$\overline{H}_1 \approx (\mathrm{Tor}_1^R(A, B) \otimes_{\mathbb{Z}} G) \oplus \mathrm{Tor}_1^{\mathbb{Z}}(A \otimes_R B, G) \quad (R \text{ projective}/\mathbb{Z}).$$

At any rate, we have  $\overline{H}_2 \approx \mathrm{Tor}_1^{\mathbb{Z}}(\mathrm{Tor}_1^R(A, B), G)$ .

Now what we did was form  $(\langle P_i, d_i \rangle \otimes_R \langle P'_i, d'_i \rangle) \otimes_{\mathbb{Z}} \langle Q_i, d_i \rangle$ , with that grouping. Suppose instead we work with  $\langle P_i, d_i \rangle \otimes_R (\langle P'_i, d'_i \rangle \otimes_{\mathbb{Z}} \langle Q_i, d_i \rangle)$ . Thanks to our changed sign conventions, we get the same complex, and thus the same homology. (Easy exercise: With the new sign convention, tensoring of complexes is associative.)

In the new picture, we have  $F_n = P_n$ , and

$$F'_n = \bigoplus_{i+j=n} P'_i \otimes_{\mathbb{Z}} Q_j$$

$$D'_n = \bigoplus_{i+j=n} (i_{P'_i} \otimes d_j + (-1)^j d'_i \otimes i_{Q_j}).$$

Since

$$\cdots \rightarrow P'_3 \xrightarrow{d'_3} P'_2 \xrightarrow{d'_2} P'_1 \xrightarrow{d'_1} P'_0 \rightarrow B \rightarrow 0$$

is still a free resolution of  $B$ , it is a flat resolution of  $B$  as a  $\mathbb{Z}$ -module, so the homology of  $\langle F'_i, D'_i \rangle$  is  $\mathrm{Tor}_n^{\mathbb{Z}}(B, G)$  at  $F'_n$ , again by Proposition 3.9 and its corollary. The homology of  $\langle F_n, d_n \rangle$  is  $A$  at  $F_0$  and zero everywhere else, so the Künneth theorem for  $R$  yields the exact sequences

$$0 \rightarrow 0 \rightarrow \overline{H}_2 \rightarrow \mathrm{Tor}_1^R(A, \mathrm{Tor}_1^{\mathbb{Z}}(B, G)) \rightarrow 0,$$

$$0 \rightarrow A \otimes_R \mathrm{Tor}_1^{\mathbb{Z}}(B, G) \rightarrow \overline{H}_1 \rightarrow \mathrm{Tor}_1^R(A, B \otimes_{\mathbb{Z}} G) \rightarrow 0,$$

and

$$0 \rightarrow A \otimes_R (B \otimes_{\mathbb{Z}} G) \rightarrow \overline{H}_0 \rightarrow 0 \rightarrow 0.$$

The groups  $\overline{H}_0$ ,  $\overline{H}_1$ , and  $\overline{H}_2$  are the same as we had before, and  $\overline{H}_2 \approx \mathrm{Tor}_1^R(A, \mathrm{Tor}_1^{\mathbb{Z}}(B, G))$  now. Also, if  $R$  is  $\mathbb{Z}$ -projective we get  $\overline{H}_1 \approx (\mathrm{Tor}_1^R(A, B) \otimes_{\mathbb{Z}} G) \oplus \mathrm{Tor}_1^{\mathbb{Z}}(A \otimes_R B, G)$ , with splitting occurring when Proposition 9.18 also applies to tensor products over  $R$ .  $\square$

## 9.4 Do Connecting Homomorphisms Commute?

This section uses material from Chapters 1, 2, 3, and 6.

At first sight, the question seems a bit strange, since diagrams containing connecting homomorphisms only are, well, unusual. The situation is easiest to describe for Tor.

Suppose  $0 \rightarrow B \rightarrow B' \rightarrow B'' \rightarrow 0$  is a short exact sequence in  ${}_R\mathbf{M}$ . For each  $A \in \mathbf{M}_R$ , we have connecting homomorphisms  $\delta_n : \text{Tor}_n(A, B'') \rightarrow \text{Tor}_{n-1}(A, B)$ . Now suppose  $0 \rightarrow A \rightarrow A' \rightarrow A'' \rightarrow 0$  is also short exact in  $\mathbf{M}_R$ . We also have connecting homomorphisms  $\widehat{\delta}_n : \text{Tor}_n(A'', B) \rightarrow \text{Tor}_{n-1}(A, B)$ .

The question is whether the diagram

$$\begin{array}{ccc} \text{Tor}_{n+1}(A'', B'') & \xrightarrow{\delta_{n+1}} & \text{Tor}_n(A'', B) \\ \widehat{\delta}_{n+1} \downarrow & & \downarrow \widehat{\delta}_n \\ \text{Tor}_n(A, B'') & \xrightarrow{\delta_n} & \text{Tor}_{n-1}(A, B) \end{array}$$

is commutative. The answer is “yes,” *provided* the connecting homomorphisms are the ones defined in Chapter 3. These are not necessarily the same as the ones defined in other books, thanks to Proposition 6.12. In fact, the proof is somewhat roundabout, depending on Proposition 6.12 for the coup de grâce.

It is probably best to start with a generality, concerning a truly awesome diagram constructed as follows. We start with a  $3 \times 3$  lattice

$$\begin{array}{ccccccc} & & 0 & & 0 & & 0 \\ & & \downarrow & & \downarrow & & \downarrow \\ 0 & \longrightarrow & C^{11} & \xrightarrow{f^1} & C^{12} & \xrightarrow{p^1} & C^{13} \longrightarrow 0 \\ & & \downarrow g^1 & & \downarrow g^2 & & \downarrow g^3 \\ 0 & \longrightarrow & C^{21} & \xrightarrow{f^2} & C^{22} & \xrightarrow{p^2} & C^{23} \longrightarrow 0 \\ & & \downarrow q^1 & & \downarrow q^2 & & \downarrow q^3 \\ 0 & \longrightarrow & C^{31} & \xrightarrow{f^3} & C^{32} & \xrightarrow{p^3} & C^{33} \longrightarrow 0 \\ & & \downarrow & & \downarrow & & \downarrow \\ & & 0 & & 0 & & 0 \end{array}$$

with short exact rows and columns, whose entries are themselves chain complexes:  $C^{ij} = \langle C_n^{ij}, d_n^{ij} \rangle$  has homology  $H_n^{ij}$  at  $C_n^{ij}$ , and the  $f^j, g^i, p^j,$

$q^i$  are chain maps for which

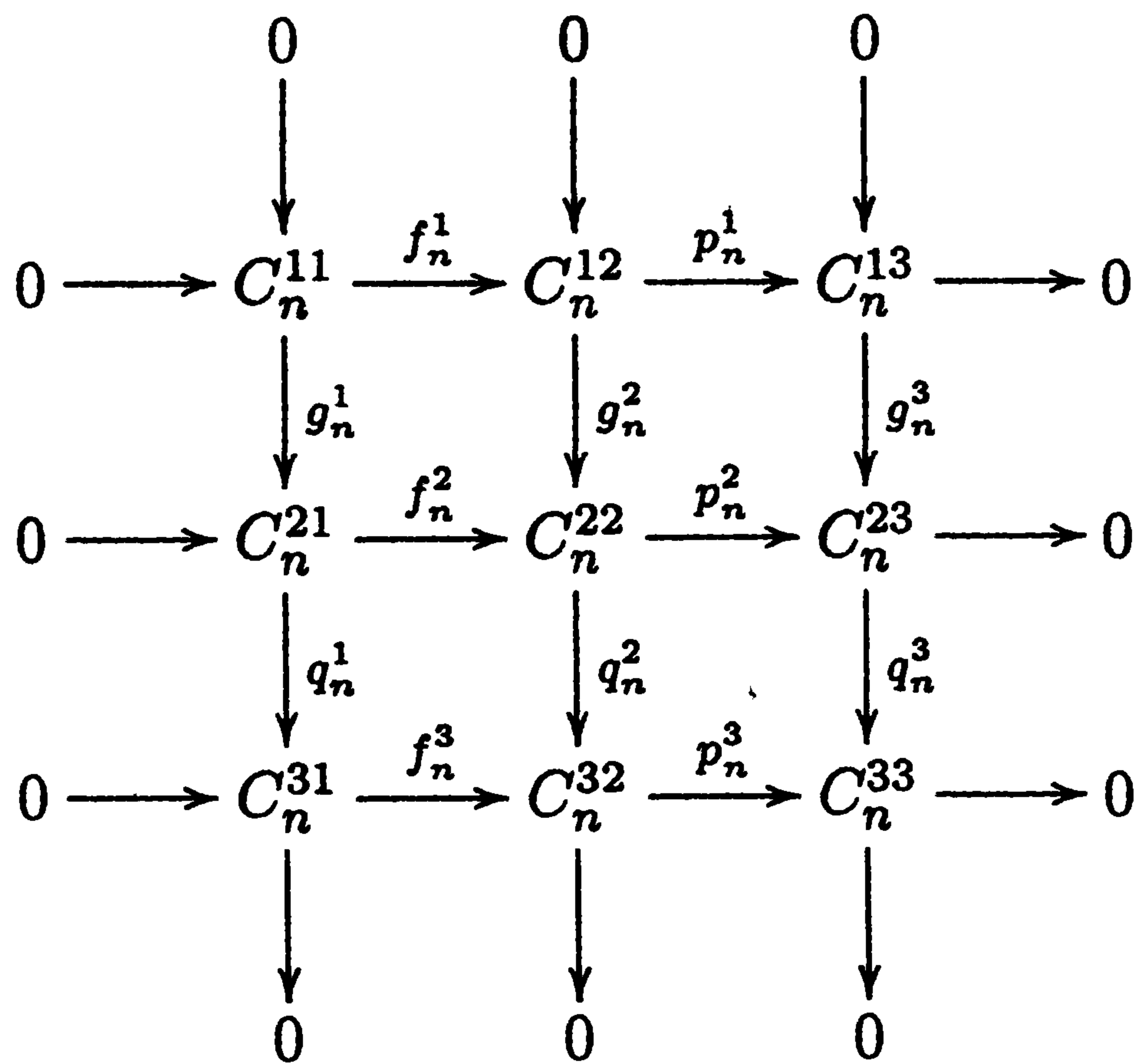

has short exact rows and columns for each  $n$ . To see what this “really” looks like, tilt and delete the names of the maps:

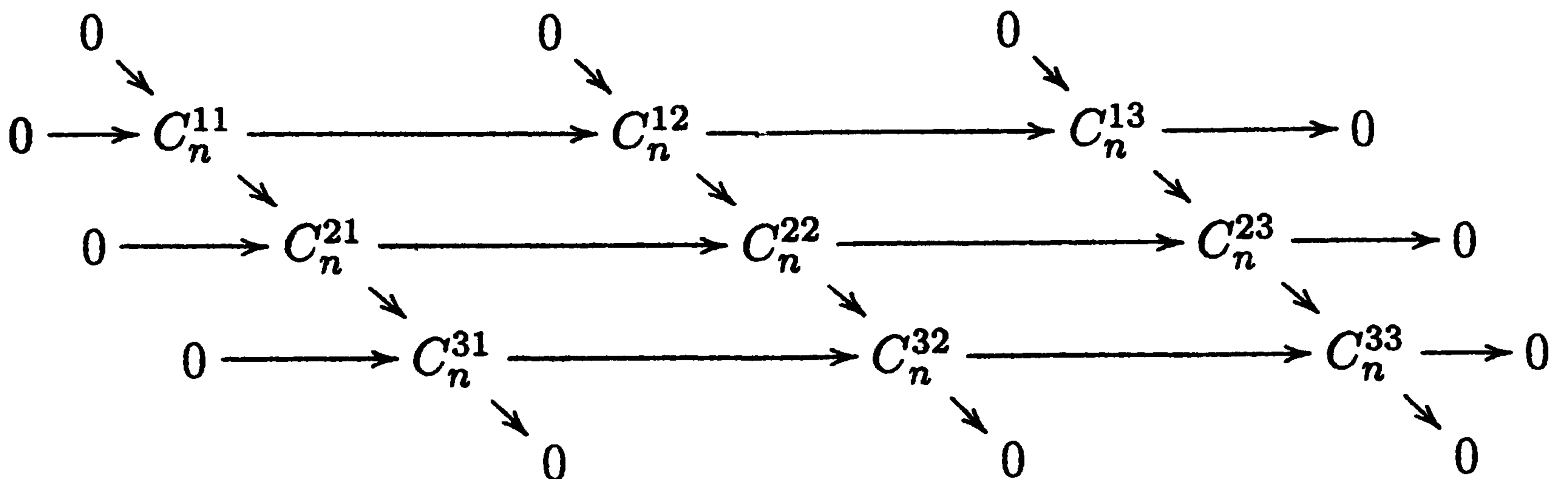

and finally, delete the zeros and put the  $C_n^{ij}$  in their chain complex verti-

cally:

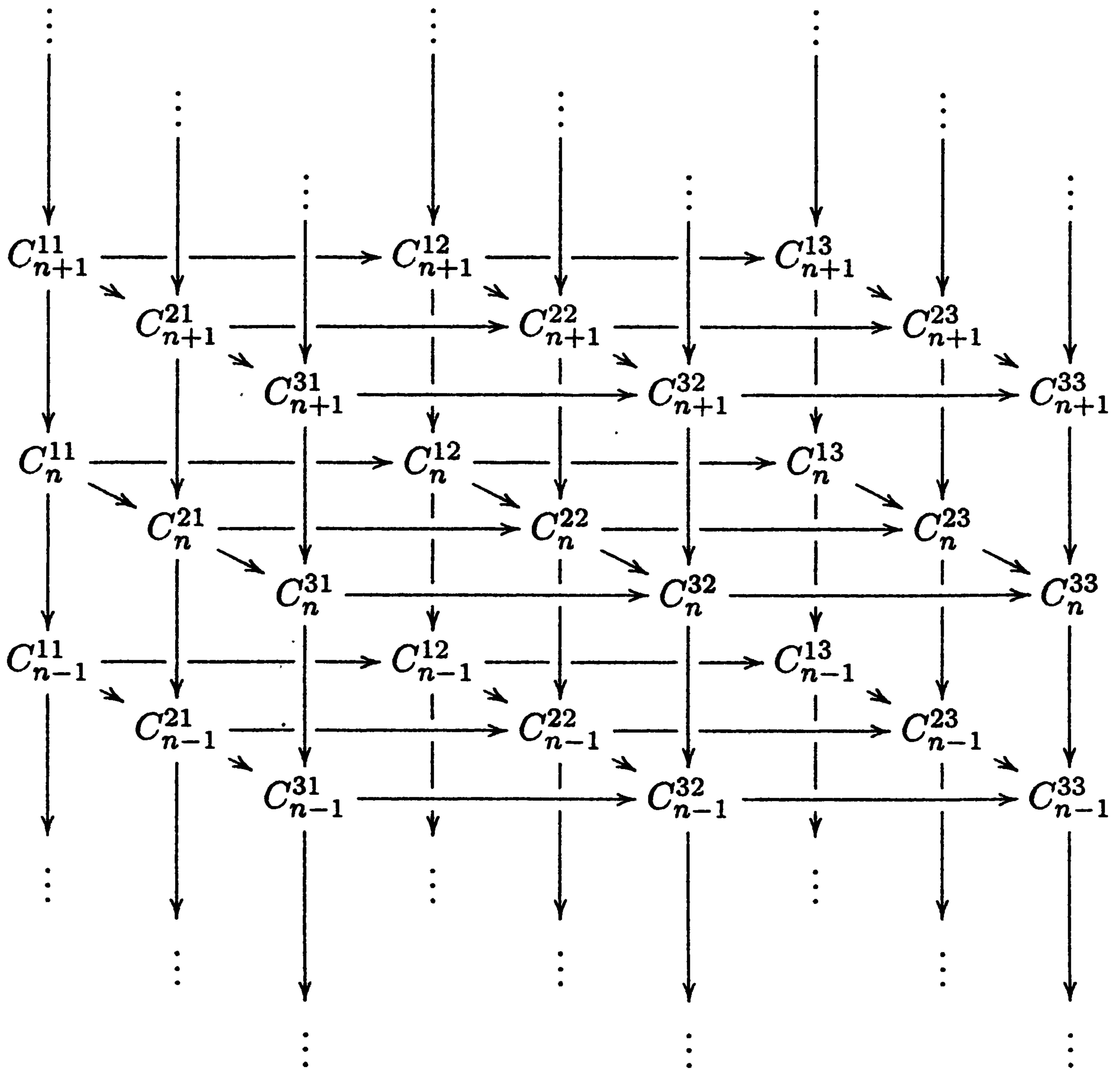

Gadzooks! Masochistic readers are invited to visualize morphisms of such diagrams. We shall call this situation a “post.” There are connecting homomorphisms associated to the various short exact sequences; we need a notation for four of them, the ones along the outside:

$$\begin{aligned} \delta_n^{32} : H_n^{33} &\rightarrow H_{n-1}^{31} & \delta_n^{21} : H_n^{31} &\rightarrow H_{n-1}^{11} \\ \delta_n^{23} : H_n^{33} &\rightarrow H_{n-1}^{13} & \delta_n^{12} : H_n^{13} &\rightarrow H_{n-1}^{11} \end{aligned}$$

In  $\delta_n^{ij}$ , the index “ $ij$ ” coincides with that on the differential employed in defining  $\delta_n^{ij}$ , just as the index  $n$  is defined. For example,  $\delta_n^{32}$  is defined via the three-step chase:

$$\begin{array}{ccc} C_n^{32} & \longrightarrow & C_n^{33} \\ & \searrow d_n^{32} & \\ C_{n-1}^{31} & \longrightarrow & C_{n-1}^{32} \end{array}$$

The construction is as follows. Pick  $u \in C_n^{33}$  representing a homology class, so that  $d_n^{33}(u) = 0$ .  $p_n^3$  is onto, so  $u = p_n^3(v)$  for some  $v \in C_n^{32}$ . Now  $0 = d_n^{33}(u) = d_n^{33}p_n^3(v) = p_{n-1}^3d_n^{32}(v)$ , so  $d_n^{32}(v) \in \ker p_{n-1}^3 = \text{im } f_{n-1}^3$ , and  $d_n^{32}(v) = f_{n-1}^3(w)$ .  $\delta_n^{32}(u + \text{im } d_{n+1}^{33})$  is defined as the homology class determined by  $w$ .

The question now is whether

$$\begin{array}{ccc} H_{n+1}^{33} & \xrightarrow{\delta_{n+1}^{32}} & H_n^{31} \\ \delta_{n+1}^{23} \downarrow & & \downarrow \delta_n^{21} \\ H_n^{13} & \xrightarrow{\delta_n^{12}} & H_{n-1}^{11} \end{array}$$

commutes. The answer is a resounding "No!" In fact, it *anticommutes*.

**Proposition 9.20** *In the post diagram above,  $\delta_n^{21}\delta_{n+1}^{32} = -\delta_n^{12}\delta_{n+1}^{23}$ .*

**Proof:** The proof is a bit involved, and very messy. Nevertheless, it does break up into four digestible chunks. The first of these is a lemma which applies to all the layers of our post.

**Lemma 9.21** *Suppose*

$$\begin{array}{ccccccc} & & 0 & & 0 & & 0 \\ & & \downarrow & & \downarrow & & \downarrow \\ 0 & \longrightarrow & C^{11} & \xrightarrow{f^1} & C^{12} & \xrightarrow{p^1} & C^{13} \longrightarrow 0 \\ & & \downarrow g^1 & & \downarrow g^2 & & \downarrow g^3 \\ 0 & \longrightarrow & C^{21} & \xrightarrow{f^2} & C^{22} & \xrightarrow{p^2} & C^{23} \longrightarrow 0 \\ & & \downarrow q^1 & & \downarrow q^2 & & \downarrow q^3 \\ 0 & \longrightarrow & C^{31} & \xrightarrow{f^3} & C^{32} & \xrightarrow{p^3} & C^{33} \longrightarrow 0 \\ & & \downarrow & & \downarrow & & \downarrow \\ & & 0 & & 0 & & 0 \end{array}$$

*is commutative with short exact rows and columns. Suppose  $y \in C^{22}$  satisfies  $p^2(y) = 0$  and  $q^2(y) = 0$ . Then  $\exists v \in C^{11}$  such that  $y = g^2f^1(v) = f^2g^1(v)$ .*

**Remark:** It is left to the reader to check that

$$0 \longrightarrow C^{11} \xrightarrow{g^2f^1} C^{22} \xrightarrow{\begin{pmatrix} p^2 \\ q^2 \end{pmatrix}} C^{23} \oplus C^{32}$$



is actually exact; we shall not need this much.

**Proof of Lemma 9.21** Since  $p^2(y) = 0$ , exactness of the middle row says that  $y = f^2(z)$  for some  $z \in C^{21}$ . Furthermore,  $f^3 q^1(z) = q^2 f^2(z) = q^2(y) = 0$ , so  $q^1(z) = 0$  since  $f^3$  is one-to-one. But now  $z = g^1(v)$  for some  $v \in C^{11}$  by exactness of the lefthand column, and  $y = f^2(z) = f^2 g^1(v) = g^2 f^1(v)$  by commutativity of the diagram.  $\square$

**Return to Proof of Proposition 9.20** Before getting down to the details, a few words about the overall strategy. Let  $u \in C_{n+1}^{33}$  with  $d_{n+1}^{33} u = 0$ . Let  $\bar{u}$  denote the homology class of  $u$ . (We shall make this convention: A bar denotes a homology class.)  $\delta_n^{21} \delta_{n+1}^{32} \bar{u}$  and  $\delta_n^{12} \delta_{n+1}^{23} \bar{u}$  are calculated by chasing along the post diagram as follows:

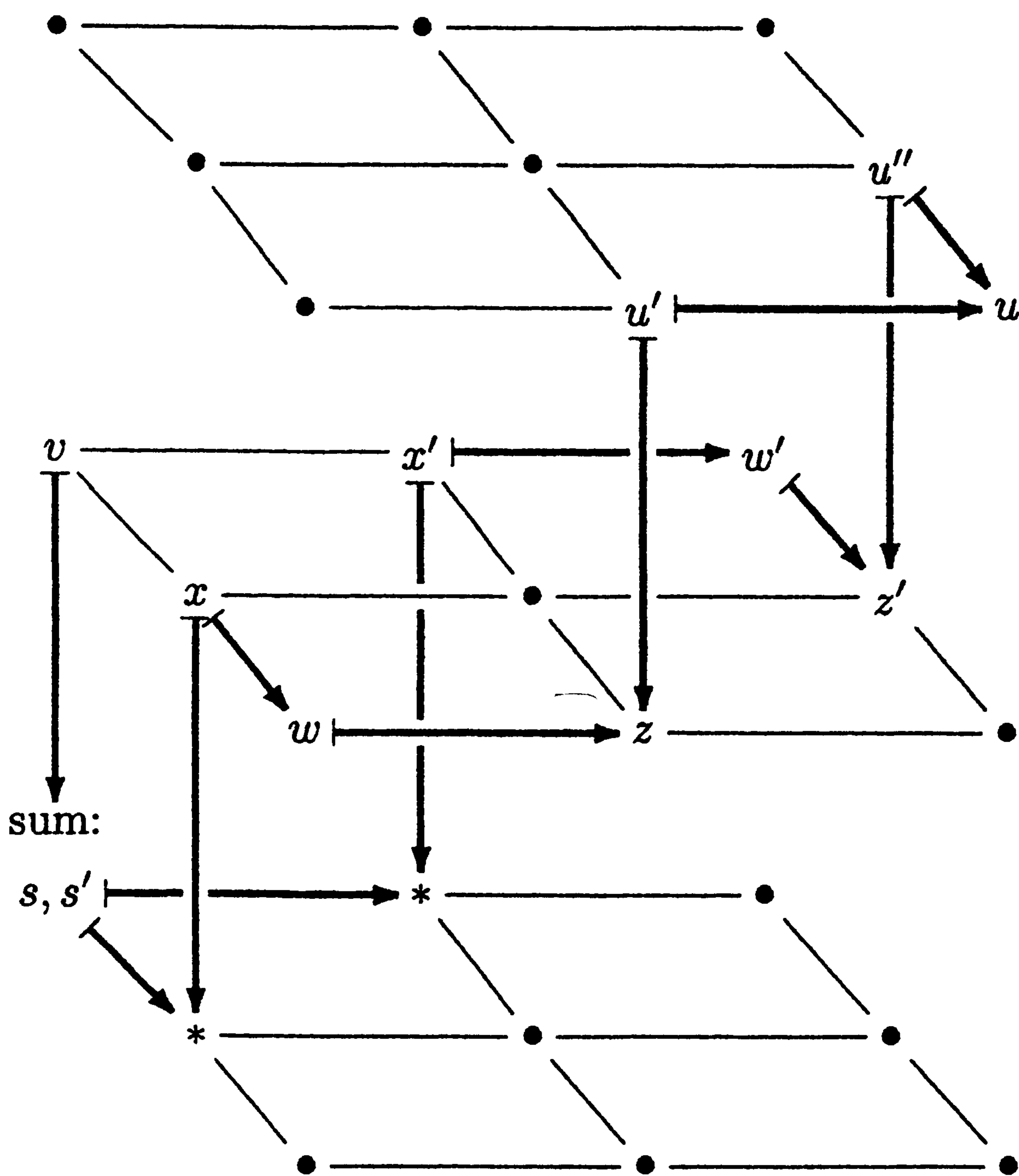

$$\begin{aligned} \delta_{n+1}^{32}(\bar{u}) &= \bar{w} & \delta_n^{21}(\bar{w}) &= \bar{s} \\ \delta_{n+1}^{23}(\bar{u}) &= \bar{w}' & \delta_n^{12}(\bar{w}') &= \bar{s}' \end{aligned}$$

The letters in this diagram will correspond to their appearance in the proof. The whole point of the construction is to produce a  $v \in C_n^{11}$  for which  $s + s' = d_n^{11}(v)$  so that  $\bar{s} + \bar{s}' = 0$ , or  $\bar{s} = -\bar{s}'$ . When all the elements used in the proof are labeled, the overall diagram is as follows, where elements separated by commas lie in the same space:

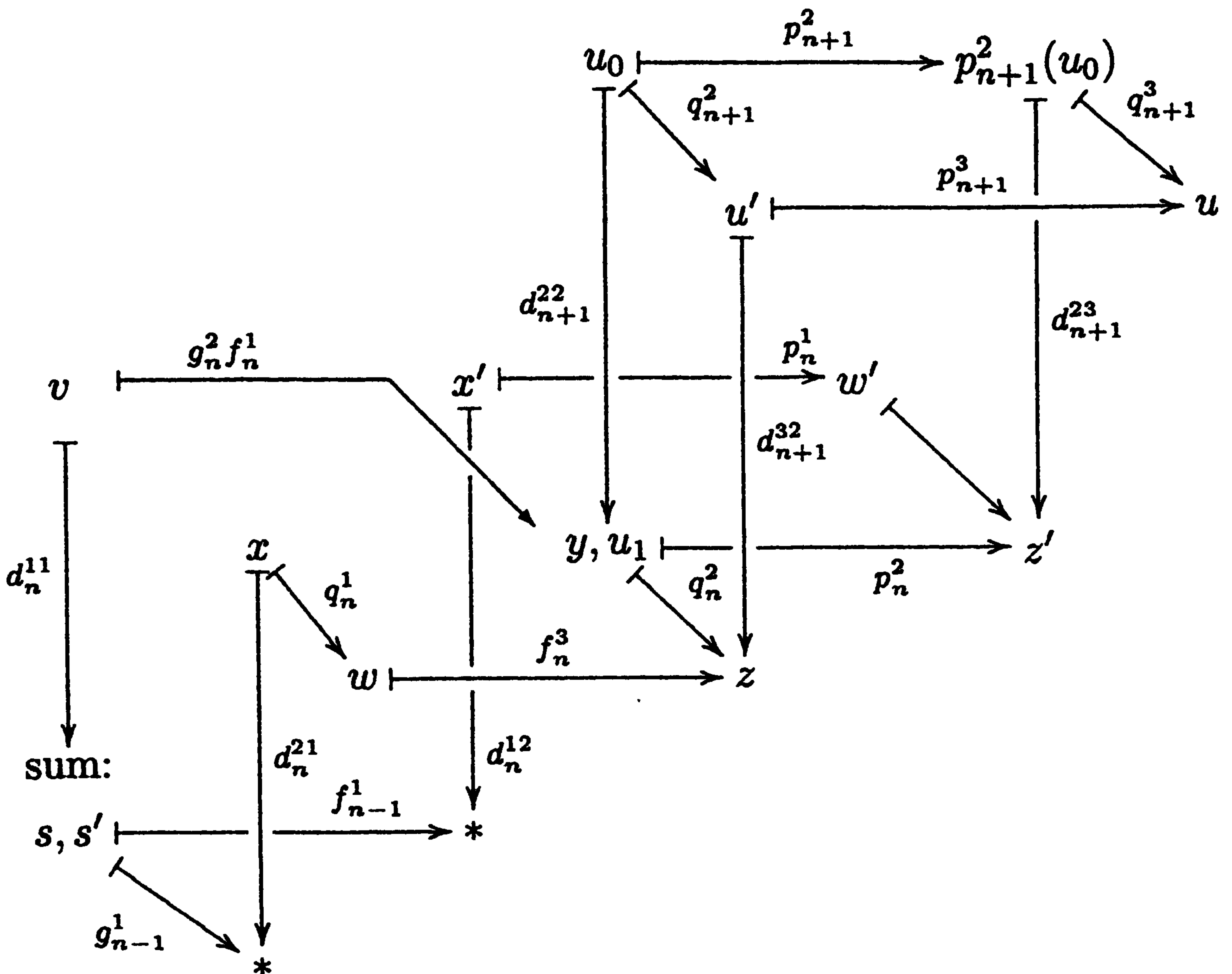

The first chunk of the proof was Lemma 9.21. The second concerns the upper right (partial) cube:

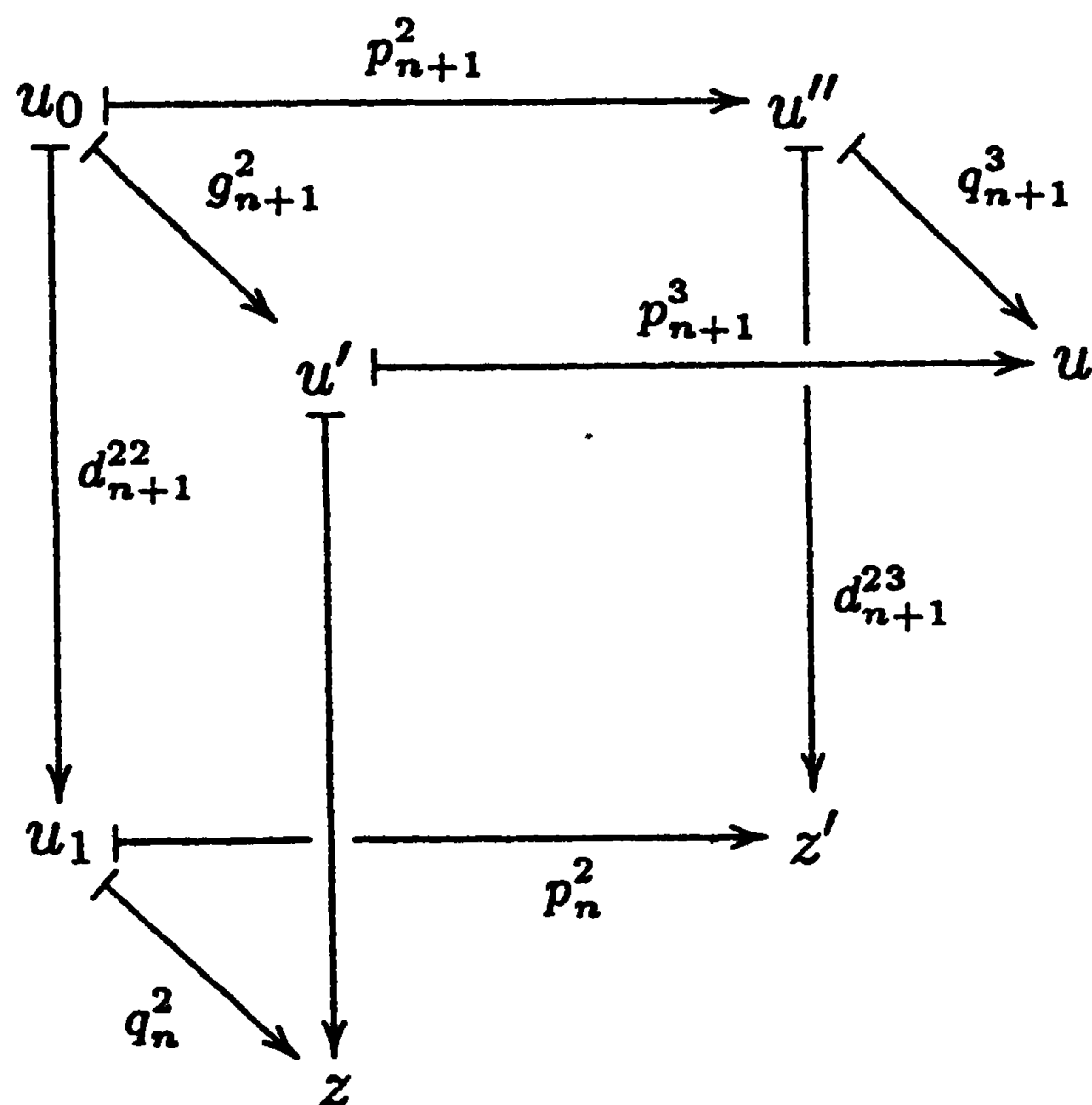

The point is that two-thirds of the way through the construction of  $\delta_{n+1}^{23}(\bar{u})$  and  $\delta_{n+1}^{32}(\bar{u})$ , the objects  $z$  and  $z'$  come from the same  $u_1 \in C_n^{22}$ , for which  $d_n^{22}(u_1) = 0$ . Here is how this goes.

Start with  $u'$ .  $p_{n+1}^3$  is onto, so  $\exists u' \in C_{n+1}^{32}$  for which  $p_{n+1}^3(u') = u$ . This is how the first step of the construction of  $\delta_{n+1}^{32}$  goes; the next step takes  $z = d_{n+1}^{32}(u')$ . How about  $\delta_{n+1}^{23}$ ?

Well,  $q_{n+1}^2$  is onto, so  $u' = q_{n+1}^2(u_0)$  for some  $u_0 \in C_{n+1}^{22}$ . But now  $u = p_{n+1}^3(u') = p_{n+1}^3 q_{n+1}^2(u_0) = q_{n+1}^3 p_{n+1}^2(u_0)$  by commutativity of the  $(n+1)$ -layer of the post, so if we set  $u'' = p_{n+1}^2(u_0)$ , we get  $u = q_{n+1}^3(u'')$ . That is, we can (and will) use this  $u''$  in the first step of the construction of  $\delta_{n+1}^{23}$ . For the next step, set  $z' = d_{n+1}^{23}(u'')$ .

But now, setting  $u_1 = d_{n+1}^{22}(u_0)$ :

$$\begin{aligned} z &= d_{n+1}^{32}(u') = d_{n+1}^{32} q_{n+1}^2(u_0) = q_n^2 d_{n+1}^{22}(u_0) = q_n^2(u_1), \\ z' &= d_{n+1}^{23}(u'') = d_{n+1}^{23} p_{n+1}^2(u_0) = p_n^2 d_{n+1}^{22}(u_0) = p_n^2(u_1), \end{aligned}$$

and

$$d_n^{22}(u_1) = d_n^{22} d_{n+1}^{22}(u_0) = 0.$$

We now have what we want for the second part of the proof.

For the third part, the relevant diagram is only two-dimensional, but it is bigger: Almost the whole  $n$ th layer. The top view is:

$$\begin{array}{ccccc} v & \xrightarrow{\quad} & & x' & \xrightarrow{p_n^1} & w' \\ & \searrow^{g_n^2 f_n^1} & & & & \downarrow g_n^3 \\ & & & y, u_1 & \xrightarrow{p_n^2} & z' \\ & & x & & & \\ & & \downarrow q_n^1 & & & \\ & & w & \xrightarrow{f_n^3} & z & \\ & & & & & \downarrow q_n^2 \end{array}$$

The element  $y$  will be defined in due course, and  $v$  (produced from Lemma 9.21) will be the  $v$  referred to earlier. Now to the details. We already have  $u_1$ ,  $z$ , and  $z'$  from the last part. Furthermore,  $z = f_n^3(w)$  for some  $w \in C_n^{31}$ , and  $\delta_{n+1}^{32}(\bar{u}) = \bar{w}$  by the construction of  $\delta_{n+1}^{32}$ . Similarly,  $z' = g_n^3(w')$  for some  $w' \in C_n^{13}$ , and  $\delta_{n+1}^{23}(\bar{u}) = \bar{w}'$ .

Proceeding on to  $\delta_n^{21}(\bar{w})$  and  $\delta_n^{12}(\bar{w}')$ , choose  $x \in C_n^{21}$  so that  $q_n^1(x) = w$ , and  $x' \in C_n^{12}$  so that  $p_n^1(x') = w'$ . This is the first part of the construction of  $\delta_n^{21}(\bar{w})$  and  $\delta_n^{12}(\bar{w}')$ . We now define

$$y = f_n^2(x) + g_n^2(x') - u_1.$$

We have that

$$\begin{aligned}
 q_n^2(y) &= q_n^2 f_n^2(x) + q_n^2 g_n^2(x') - q_n^2(u_1) \\
 &= f_n^3 q_n^1(x) + 0 - z \\
 &= f_n^3(w) - z \\
 &= 0.
 \end{aligned}$$

Similarly,  $p_n^2(y) = 0$ . By Lemma 9.21,  $y = g_n^2 f_n^1(v)$  for some  $v \in C_n^{11}$ . This is the  $v$  described in the discussion of strategy.

Finally, the last part. This concerns the cube

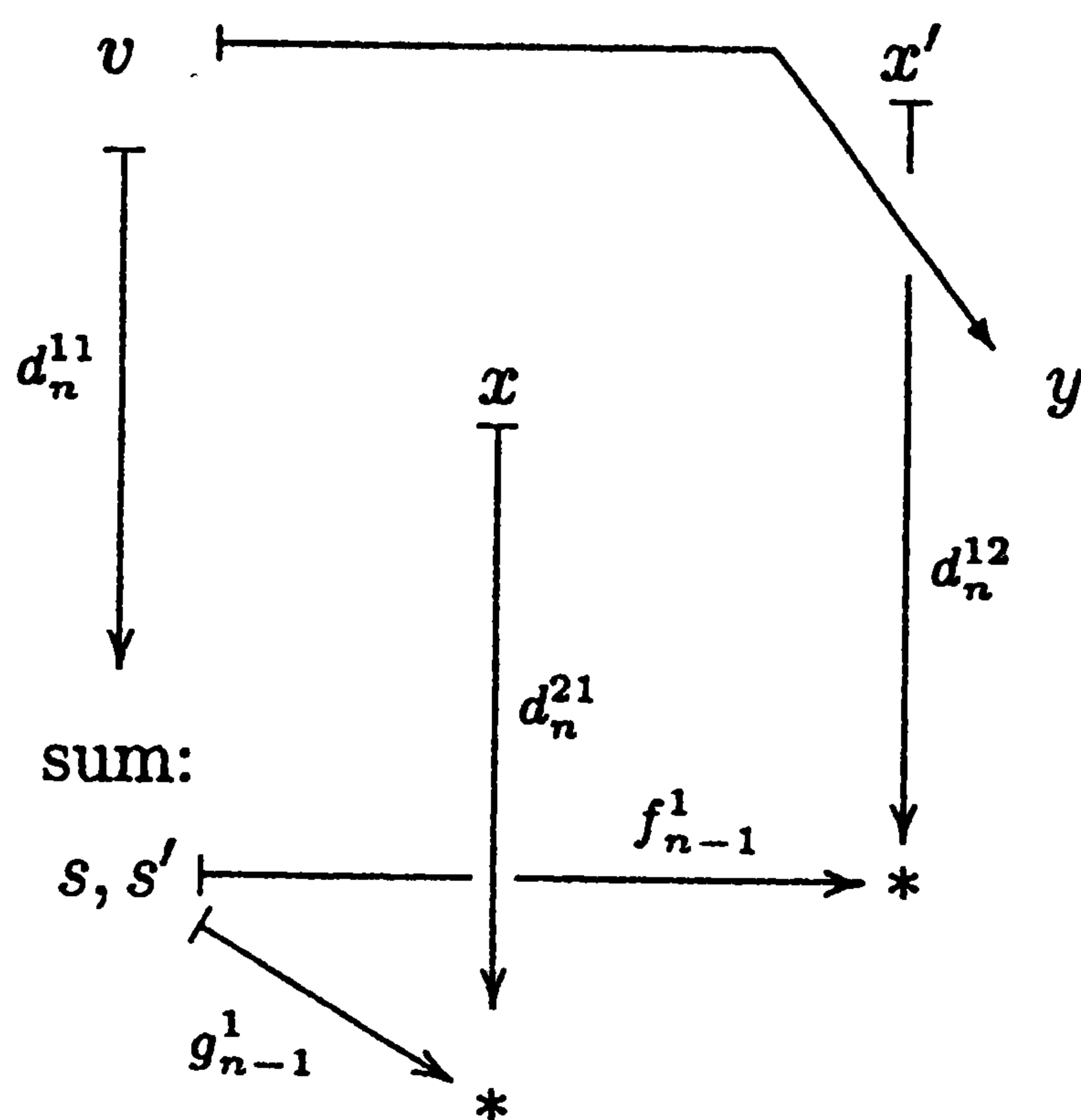

where the construction of  $\delta_n^{21}(\bar{w})$  is completed by finding  $s \in C_{n-1}^{11}$  for which  $g_{n-1}^1(s) = d_n^{21}(x)$ ;  $\delta_n^{21}(\bar{w}) = \bar{s}$  for this  $s$ . Similarly, one finds  $s' \in C_{n-1}^{11}$  for which  $f_{n-1}^1(s') = d_n^{12}(x')$ ;  $\delta_n^{12}(\bar{w}') = \bar{s}'$  for this  $s'$ . But now  $\delta_n^{21} \delta_{n+1}^{32}(\bar{u}) = \delta_n^{21}(\bar{w}) = \bar{s}$ , and  $\delta_n^{12} \delta_{n+1}^{23}(\bar{u}) = \delta_n^{12}(\bar{w}') = \bar{s}'$ , so  $\delta_n^{21} \delta_{n+1}^{32}(\bar{u}) + \delta_n^{12} \delta_{n+1}^{23}(\bar{u}) = \bar{s} + \bar{s}'$ . To complete the proof, it suffices to show that  $s + s' = d_n^{11}(v)$ . To see that this is the case, apply  $g_{n-1}^2 f_{n-1}^1$ :

$$\begin{aligned}
 g_{n-1}^2 f_{n-1}^1 d_n^{11}(v) &= g_{n-1}^2 d_n^{12} f_n^1(v) \\
 &= d_n^{22} g_n^2 f_n^1(v) \\
 &= d_n^{22}(y) \\
 &= d_n^{22} f_n^2(x) + d_n^{22} g_n^2(x') - d_n^{22}(u_1) \\
 &= f_{n-1}^2 d_n^{21}(x) + g_{n-1}^2 d_n^{12}(x') - d_n^{22} d_{n+1}^{22}(u_0) \\
 &= f_{n-1}^2 g_{n-1}^1(s) + g_{n-1}^2 f_{n-1}^1(s') - 0 \\
 &= g_{n-1}^2 f_{n-1}^1(s) + g_{n-1}^2 f_{n-1}^1(s') \\
 &= g_{n-1}^2 f_{n-1}^1(s + s').
 \end{aligned}$$

But  $g_{n-1}^2$  and  $f_{n-1}^1$  are one-to-one, so  $d_n^{11}(v) = s + s'$  as claimed. Hence,  $\bar{s} + \bar{s}' = 0$ .  $\square$

We can now prove the main result of this section.

**Theorem 9.22** *Suppose  $0 \rightarrow B \rightarrow B' \rightarrow B'' \rightarrow 0$  is short exact in  ${}_R\mathbf{M}$ .*

a) *Suppose  $0 \rightarrow A \rightarrow A' \rightarrow A'' \rightarrow 0$  is also short exact in  $\mathbf{M}_R$ . If connecting homomorphisms are as defined in Chapter 3, notationally,  $\delta_n : \text{Tor}_n(\bullet, B'') \rightarrow \text{Tor}_{n-1}(\bullet, B)$ , and  $\widehat{\delta}_n : \text{Tor}_n(A'', \bullet) \rightarrow \text{Tor}_{n-1}(A, \bullet)$ , then the diagram*

$$\begin{array}{ccc} \text{Tor}_{n+1}(A'', B'') & \xrightarrow{\delta_{n+1}} & \text{Tor}_n(A'', B) \\ \widehat{\delta}_{n+1} \downarrow & & \downarrow \widehat{\delta}_n \\ \text{Tor}_n(A, B'') & \xrightarrow{\delta_n} & \text{Tor}_{n-1}(A, B) \end{array}$$

*is commutative.*

b) *Suppose  $0 \rightarrow C \rightarrow C' \rightarrow C'' \rightarrow 0$  is also short exact in  ${}_R\mathbf{M}$ . If connecting homomorphisms are as defined in Chapter 3, notationally,  $\delta_n : \text{Ext}^{n-1}(B, \bullet) \rightarrow \text{Ext}^n(B'', \bullet)$ , and  $\bar{\delta}_n : \text{Ext}^{n-1}(\bullet, C'') \rightarrow \text{Ext}^n(\bullet, C)$ , then the diagram*

$$\begin{array}{ccc} \text{Ext}^{n-1}(B, C'') & \xrightarrow{\bar{\delta}_n} & \text{Ext}^n(B, C) \\ \delta_n \downarrow & & \downarrow \delta_{n+1} \\ \text{Ext}^n(B'', C'') & \xrightarrow{\bar{\delta}_{n+1}} & \text{Ext}^{n+1}(B'', C) \end{array}$$

*is commutative.*

**Proof:** In accordance with Proposition 6.5(a), construct a simultaneous projective resolution of  $0 \rightarrow B \rightarrow B' \rightarrow B'' \rightarrow 0$ :

$$\begin{array}{ccccccc} & & 0 & & 0 & & 0 \\ & & \downarrow & & \downarrow & & \downarrow \\ \cdots & \longrightarrow & P_1 & \longrightarrow & P_0 & \longrightarrow & B \longrightarrow 0 \\ & & \downarrow & & \downarrow & & \downarrow \\ \cdots & \longrightarrow & P'_1 & \longrightarrow & P'_0 & \longrightarrow & B' \longrightarrow 0 \\ & & \downarrow & & \downarrow & & \downarrow \\ \cdots & \longrightarrow & P''_1 & \longrightarrow & P''_0 & \longrightarrow & B'' \longrightarrow 0 \\ & & \downarrow & & \downarrow & & \downarrow \\ & & 0 & & 0 & & 0 \end{array}$$



Since each  $P_n''$  is projective, the vertical sequences split, and  $P_n' \approx P_n \oplus P_n''$  as in the statement of Proposition 6.5(a). For part (a), tensor this with  $0 \rightarrow A \rightarrow A' \rightarrow A'' \rightarrow 0$  (and prop it upright); the result is a post diagram.  $\widehat{\delta}_n$  stays the same, but the connecting homomorphisms  $\delta_n$  are replaced by  $\widetilde{\delta}_n = (-1)^n \delta_n$  in accordance with Proposition 6.12. We have that  $\widehat{\delta}_n \widetilde{\delta}_{n+1} = -\widetilde{\delta}_n \widehat{\delta}_{n+1}$  by Proposition 9.20, so that  $\widehat{\delta}_n \delta_{n+1} = (-1)^{n+1} \widehat{\delta}_n \widetilde{\delta}_{n+1} = -(-1)^{n+1} \widetilde{\delta}_n \widehat{\delta}_{n+1} = (-1)^n \widetilde{\delta}_n \widehat{\delta}_{n+1} = \delta_n \widehat{\delta}_{n+1}$ .

As for (b), apply  $\text{Hom}(\bullet, C) \rightarrow \text{Hom}(\bullet, C') \rightarrow \text{Hom}(\bullet, C'')$ , and appeal to Exercise 12, Chapter 6.  $\square$

A final comment. This is not just the answer to an obvious but pointless question. In the next section we shall use this (and the even more obscure Proposition 6.15) to put additional structure on Ext (and Tor).

## 9.5 The Ext Product

This section uses material from Chapters 1, 2, 3, and 6, as well as the result of the last section (Section 9.4).

There are various ways of introducing products into homological algebra. One involves algebras and is discussed in many texts. There is one product, however, that requires no additional structure; it exists for any ring. It is also not well known; there is some discussion of it in Bourbaki [9], but hardly any elsewhere. It therefore fits as an odd end here.

The Ext product is defined on Ext groups in the following manner. If  $R$  is a ring, and  $B, C, D \in {}_R\mathbf{M}$ , then the Ext product gives a function

$$\sqcup : \text{Ext}^n(C, D) \times \text{Ext}^m(B, C) \rightarrow \text{Ext}^{n+m}(B, D)$$

which has a number of properties. (We use the  $\sqcup$  notation because of the resemblance to the cup product  $\cup$  for cohomology in algebraic topology.) It seems best to list the properties first, since they are not independent, a fact usable in deriving them.

**Property LR (Linearity on the Right).** Given  $u \in \text{Ext}^n(C, D)$ , the maps  $u \sqcup \bullet : \text{Ext}^m(B, C) \rightarrow \text{Ext}^{m+n}(B, D)$  are homomorphisms.

**Property LL (Linearity on the Left).** Given  $v \in \text{Ext}^m(B, C)$ , the maps  $\bullet \sqcup v : \text{Ext}^n(C, D) \rightarrow \text{Ext}^{m+n}(B, D)$  are homomorphisms.

**Remark:** These two properties basically say that  $\sqcup$  is bilinear in  $\mathbf{Ab}$ . Alternatively, they assert a distributive law.

**Property NR (Naturality on the Right).** Given  $f : B \rightarrow B'$ , letting  $f^*$  generically denote the induced map from  $\text{Ext}^\bullet(B', \bullet) \rightarrow \text{Ext}^\bullet(B, \bullet)$ , then for all  $u \in \text{Ext}^n(C, D)$  and  $v \in \text{Ext}^m(B', C)$ ,  $f^*(u \sqcup v) = u \sqcup (f^*v)$ .

**Property NL (Naturality on the Left).** Given  $f : D \rightarrow D'$ , letting  $f_*$  generically denote the induced map from  $\text{Ext}^\bullet(\bullet, D)$  to  $\text{Ext}^\bullet(\bullet, D')$ , then for all  $u \in \text{Ext}^n(C, D)$  and  $v \in \text{Ext}^m(B, C)$ ,  $(f_*u) \sqcup v = f_*(u \sqcup v)$ .

**Property NC (Naturality in the Center).** Given  $f : C \rightarrow C'$ , letting  $f_*$  and  $f^*$  be defined generically as above, then for all  $u \in \text{Ext}^n(C', D)$  and  $v \in \text{Ext}^m(B, C)$ ,  $(f^*u) \sqcup v = u \sqcup (f_*v)$ .

**Remark:** It is easy to verify now, by taking  $n = m = 0$ , that the resulting map from  $\text{Ext}^0(C, D) \times \text{Ext}^0(B, C)$  to  $\text{Ext}^0(B, D)$ , that is, from  $\text{Hom}(C, D) \times \text{Hom}(B, C)$  to  $\text{Hom}(B, D)$ , is just functional composition, provided identity maps multiply as identity elements. (This is the reason for the ordering of the entries in  $\sqcup$ .) In fact, it is derivable from any one of NR, NL, or NC, given that  $\bullet \sqcup i_B : \text{Ext}^n(B, C) \rightarrow \text{Ext}^n(B, C)$  and  $i_C \sqcup \bullet : \text{Ext}^n(B, C) \rightarrow \text{Ext}^n(B, C)$  are identity maps. But this all follows from:

**Property ZR (Dimension Zero on the Right).** If  $f \in \text{Hom}(B, C) \approx \text{Ext}^0(B, C)$ , then for all  $u \in \text{Ext}^n(C, D)$ ,  $u \sqcup f = f^*(u)$ .

**Property ZL (Dimension Zero on the Left).** If  $f \in \text{Hom}(C, D) \approx \text{Ext}^0(C, D)$ , then for all  $v \in \text{Ext}^m(B, C)$ ,  $f \sqcup v = f_*(v)$ .

We also want connecting homomorphisms to behave well.

**Property CR (Connecting Homomorphisms on the Right).** If  $0 \rightarrow B \rightarrow B' \rightarrow B'' \rightarrow 0$  is short exact, with generic connecting homomorphisms  $\delta_m : \text{Ext}^{m-1}(B, \bullet) \rightarrow \text{Ext}^m(B'', \bullet)$ , and if  $u \in \text{Ext}^n(C, D)$  and  $v \in \text{Ext}^{m-1}(B, C)$ , then  $\delta_{m+n}(u \sqcup v) = u \sqcup \delta_m(v)$ .

**Property CL (Connecting Homomorphisms on the Left).** If  $0 \rightarrow D \rightarrow D' \rightarrow D'' \rightarrow 0$  is short exact, with generic connecting homomorphisms  $\bar{\delta}_n : \text{Ext}^{n-1}(\bullet, D'') \rightarrow \text{Ext}^n(\bullet, D)$ , and if  $u \in \text{Ext}^{n-1}(C, D'')$  and  $v \in \text{Ext}^m(B, C)$ , then  $\bar{\delta}_n(u) \sqcup v = \bar{\delta}_{n+m}(u \sqcup v)$ .

**Remark:** A bar is placed over the connecting homomorphisms in CL to distinguish them from the connecting homomorphisms in CR. The ability to use both at once is crucial to developing  $\sqcup$ ; the ability to distinguish between them is crucial to *reading* that development.

**Property A (Associativity).** If  $u \in \text{Ext}^n(D, E)$ ,  $v \in \text{Ext}^m(C, D)$ , and  $w \in \text{Ext}^l(B, C)$ , then  $u \sqcup (v \sqcup w) = (u \sqcup v) \sqcup w$ .

We can now formally define

$$\text{Ext}^*(B, C) = \bigoplus_{n=0}^{\infty} \text{Ext}^n(B, C).$$

Using the product  $\sqcup$ ,  $\text{Ext}^*(C, C)$  becomes a ring, with  $\text{Ext}^*(B, C)$  a left  $\text{Ext}^*(C, C)$ -module (and  $\text{Ext}^*(C, D)$  a right  $\text{Ext}^*(C, C)$ -module). Suggested

exercise: From the properties alone, show that  $\text{Ext}_{\mathbb{Z}_4}^*(\mathbb{Z}_2, \mathbb{Z}_2) \approx \mathbb{Z}_2[t]$ . ( $\text{Tor}_{\mathbb{Z}_4}^{\mathbb{Z}_2}(\mathbb{Z}_2, \mathbb{Z}_2)$  was computed as Example 9 in Chapter 3; a similar calculation shows that  $\text{Ext}_{\mathbb{Z}_4}^n(\mathbb{Z}_2, \mathbb{Z}_2) \approx \mathbb{Z}_2$  for all  $n$ . The “Bockstein sequence”  $0 \rightarrow \mathbb{Z}_2 \rightarrow \mathbb{Z}_4 \rightarrow \mathbb{Z}_2 \rightarrow 0$  works out the product.)

The above properties are not independent. Some of the relations are subtle, but some are more direct.

**Lemma 9.23** *Suppose  $\sqcup$  is a product satisfying ZR, ZL, and A. Then  $\sqcup$  satisfies NR, NL, and NC.*

**Remark:** In the proofs that follow, we adopt the notation of the property being verified.

**Proof:** For NR, note that

$$\begin{aligned} f^*(u \sqcup v) &= (u \sqcup v) \sqcup f && \text{(ZR)} \\ &= u \sqcup (v \sqcup f) && \text{(A)} \\ &= u \sqcup (f^*(v)) && \text{(ZR)} \end{aligned}$$

NL is similar. As for NC,

$$\begin{aligned} (f^*u) \sqcup v &= (u \sqcup f) \sqcup v && \text{(ZR)} \\ &= u \sqcup (f \sqcup v) && \text{(A)} \\ &= u \sqcup (f_*v) && \text{(ZL)} \end{aligned}$$

□

The surprising conclusion is that we get naturality (of all things) as a consequence of associativity (and dimension-zero regularity.) This lemma can also be run backward, using induction.

**Lemma 9.24** *Suppose  $\sqcup$  is a product satisfying ZR, NR, and CR. Then  $\sqcup$  satisfies A.*

**Proof:** Induction on  $\ell$ . The  $\ell = 0$  case is just NR and ZR:

$$\begin{aligned} u \sqcup (v \sqcup f) &= u \sqcup (f^*v) && \text{(ZR)} \\ &= f^*(u \sqcup v) && \text{(NR)} \\ &= (u \sqcup v) \sqcup f && \text{(ZR)} \end{aligned}$$

As for  $\ell - 1 \rightarrow \ell$ , we use CR. Choose a projective  $P$  and an epimorphism  $\pi : P \rightarrow B$  with kernel  $K$ . Then  $w = \delta_\ell(w')$  for some  $w' \in \text{Ext}^{\ell-1}(K, C)$ .

By the induction hypothesis,  $(u \sqcup v) \sqcup w' = u \sqcup (v \sqcup w')$ . We have

$$\begin{aligned}
 (u \sqcup v) \sqcup w &= (u \sqcup v) \sqcup \delta_\ell(w') && \text{(def.)} \\
 &= \delta_{\ell+m+n}((u \sqcup v) \sqcup w') && \text{(CR)} \\
 &= \delta_{\ell+m+n}(u \sqcup (v \sqcup w')) && \text{(ind. hyp.)} \\
 &= u \sqcup \delta_{\ell+m}(v \sqcup (w')) && \text{(CR)} \\
 &= u \sqcup (v \sqcup \delta_\ell(w')) && \text{(CR)} \\
 &= u \sqcup (v \sqcup w) && \text{(def.)}
 \end{aligned}$$

□

The above is prototypical as far as induction proofs go. At this point we introduce an auxiliary condition, which will be used in some proofs, then dropped. It could be stated for either the left or the right; we use the left for no particularly good reason.

**Condition WCL (Weak Connecting Homomorphisms on the Left)**  
 Given  $D \in {}_R\mathbf{M}$ , there is an injective  $E$  and an imbedding  $D \hookrightarrow E$  such that if  $\bar{\delta}_n : \text{Ext}^{n-1}(\bullet, E/D) \rightarrow \text{Ext}^n(\bullet, D)$  is the associated connecting homomorphism, then for all  $C, B \in {}_R\mathbf{M}$ ,  $u \in \text{Ext}^{n-1}(C, E/D)$ , and  $v \in \text{Ext}^m(B, C)$ , we have  $\bar{\delta}_n(u) \sqcup v = \bar{\delta}_{n+m}(u \sqcup v)$ .

Note that there is nothing “natural” about  $E$  (or  $E/D$ ); the only naturality comes from the fact that for any fixed  $D$ , the same  $E$  is used for  $C$  and  $B$  (the lefthand entries in  $\text{Ext}^*(\bullet, D)$ ), as well as the index  $n$ . This is enough.

**Lemma 9.25** *Suppose  $\sqcup$  is a product that satisfies ZL and WCL. Then  $\sqcup$  is unique with these properties, and  $\sqcup$  also satisfies LR, LL, ZR, NR, and CR. Similarly, any product satisfying ZR and CR necessarily satisfies CL (among others).*

**Proof:** All are by induction on  $n$ . First, LR, LL, and uniqueness, by induction on  $n$ . If  $n = 0$ , then  $u = f$ , and by ZL,  $f \sqcup v = f_*v$ . This is forced, and is bilinear. Next,  $n-1 \rightarrow n$ . If  $u \in \text{Ext}^n(C, D)$ , then  $u = \bar{\delta}_n(u')$  for some  $u' \in \text{Ext}^{n-1}(C, E/D)$ , and  $u \sqcup v = (\bar{\delta}_n(u')) \sqcup v = \bar{\delta}_{n+m}(u' \sqcup v)$  is forced (uniqueness) and is bilinear (if for  $u_1$  we choose  $u'_1$  and for  $u_2$  we choose  $u'_2$ , then for  $u_1 + u_2$  we can choose  $u'_1 + u'_2$ .)

The next induction is for ZR: We have  $f \in \text{Hom}(B, C)$ , and  $u \in \text{Ext}^n(C, D)$ . If  $n = 0$ , then by ZL,  $u \sqcup f = u_*f = u \circ f = f^*u$ , as required. As for  $n-1 \rightarrow n$ , write  $u = \bar{\delta}_n(u')$ , as before. Then  $u \sqcup f = (\bar{\delta}_n(u')) \sqcup f = \bar{\delta}_n(u' \sqcup f) = \bar{\delta}_n(f^*u') = f^*(\bar{\delta}_n(u')) = f^*(u)$  by naturality of connecting homomorphisms.

The next induction is for NR. If  $n = 0$ , then  $f^*(u \sqcup v) = f^*(u_*(v)) = u_*(f^*v) = u \sqcup f^*v$  using ZL and the fact that Ext is a bifunctor (Chapter



3, Exercise 2). As for  $n - 1 \rightarrow n$ , writing  $u = \bar{\delta}_n(u')$ ,

$$\begin{aligned}
 f^*(u \sqcup v) &= f^*((\bar{\delta}_n(u')) \sqcup v) \\
 &= f^*(\bar{\delta}_{n+m}(u' \sqcup v)) && \text{(WCL)} \\
 &= \bar{\delta}_{n+m}f^*(u' \sqcup v) && \text{(naturality of } \bar{\delta} \text{)} \\
 &= \bar{\delta}_{n+m}(u' \sqcup f^*(v)) && \text{(ind. hyp.)} \\
 &= (\bar{\delta}_n(u')) \sqcup f^*(v) && \text{(WCL)} \\
 &= u \sqcup f^*(v) && \text{(def.)}
 \end{aligned}$$

Finally, we need CR. If  $u \in \text{Hom}(C, D)$ , then  $\delta_m(u \sqcup v) = \delta_m(u_*(v)) = u_*\delta_m(v) = u \sqcup \delta_m(v)$  by naturality of  $\delta_m$  and ZL. For  $n - 1 \rightarrow n$ , write  $u = \bar{\delta}_n(u')$  as usual:

$$\begin{aligned}
 \delta_{m+n}(u \sqcup v) &= \delta_{m+n}(\bar{\delta}_n(u') \sqcup v) && \text{(def.)} \\
 &= \delta_{m+n}(\bar{\delta}_{m+n-1}(u' \sqcup v)) && \text{(WCL)} \\
 &= \bar{\delta}_{m+n}\delta_{m+n-1}(u' \sqcup v) && \text{(Theorem 9.22)} \\
 &= \bar{\delta}_{m+n}(u' \sqcup \delta_m(v)) && \text{(ind. hyp.)} \\
 &= (\bar{\delta}_n u') \sqcup \delta_m(v) && \text{(WCL)} \\
 &= u \sqcup \delta_m(v) && \text{(def.)}
 \end{aligned}$$

The proof that ZR plus CR implies CL is essentially like the above and is left to the reader.  $\square$

The weakness of WCL allows us to use it as a definition, leading to:

**Theorem 9.26** *There is a unique product  $\sqcup$  satisfying properties LR, LL, NR, NL, NC, ZR, ZL, CR, CL, and A.*

**Proof:** For each  $D \in {}_R\mathbf{M}$ , choose an injective extension  $E$  of  $D$ . Recursively (on  $n$ ) define  $u \sqcup v$  for  $u \in \text{Ext}^n(C, D)$  and  $v \in \text{Ext}^m(B, C)$  as follows: If  $n = 0$ , set  $u \sqcup v = u_*(v)$ . ZL is now satisfied. We recursively arrange that WCL is satisfied by setting  $\bar{\delta}_n(u) \sqcup v = \bar{\delta}_{n+m}(u \sqcup v)$ . Because WCL is so “unassuming,” the only thing we have to check is that  $\sqcup$  is well-defined. Since  $\bar{\delta}_n$  is an isomorphism for  $n > 1$ , this only requires looking at the  $n = 1$  case. We must show that if  $u_1, u_2 \in \text{Ext}^0(C, E/D)$ , then  $\bar{\delta}_1(u_1) = \bar{\delta}_1(u_2) \Rightarrow \bar{\delta}_{1+m}(u_1 \sqcup v) = \bar{\delta}_{1+m}(u_2 \sqcup v)$ , that is, (writing  $u = u_1 - u_2$ ) that  $\bar{\delta}_1(u) = 0 \Rightarrow \bar{\delta}_{1+m}(u_1 \sqcup v - u_2 \sqcup v) = 0$ . In view of ZL, we need that  $\bar{\delta}_1(u) = 0 \Rightarrow \bar{\delta}_{1+m}(u_*(v)) = 0$ .

If  $m = 0$ , we have that  $u_*(v) = u \circ v = v^*u$ , and  $\bar{\delta}_1(u_*(v)) = \bar{\delta}_1(v^*(u)) = v^*\bar{\delta}_1(u) = 0$  by naturality of connecting homomorphisms. Finally, if  $m > 0$ , we have from the long exact sequence for  $\text{Ext}^*(C, \bullet)$  that  $\bar{\delta}_1(u) = 0 \Rightarrow u = \pi_*(u')$  for  $u' \in \text{Hom}(C, E)$ . That is,  $u = \pi \circ u'$  for  $u' \in \text{Hom}(C, E)$ , and



$\pi : E \rightarrow E/D$  the quotient map. Thus,  $u_*(v) = \pi_* u'_*(v)$ , and  $u'_*(v) \in \text{Ext}^m(B, E) = 0$ , so already  $u'_*(v) = 0 \Rightarrow u_*(v) = 0 \Rightarrow \bar{\delta}_{1+m}(u_*(v)) = 0$ .

We now have, by definition, ZL and WCL. By Lemma 9.25,  $\sqcup$  is unique with these properties, and also satisfies LR, LL, ZR, NR, and CR. Also by Lemma 9.25,  $\sqcup$  satisfies CL (and not just WCL), since we have ZR and CR. By Lemma 9.24, we pick up A, and Lemma 9.23 then produces NL and NC.  $\square$

There is also a product resembling the cap product from algebraic topology which maps as follows ( $A \in \mathbf{M}_R; B, C \in {}_R\mathbf{M}$ ):

$$\sqcap : \text{Ext}^m(B, C) \times \text{Tor}_n(A, B) \rightarrow \text{Tor}_{n-m}(A, C).$$

$\sqcap$  is most easily defined using universality of Ext, Proposition 6.15, with  $F = A \otimes$ .  $\mathcal{L}_n F = \text{Tor}_n(A, \bullet)$ , and for all  $B$ ,

$$\text{Tor}_n(A, B) \approx \text{Nat}(\text{Ext}^n(B, \bullet), A \otimes).$$

If  $v \in \text{Ext}^m(B, C)$ , then

$$\bullet \sqcup v : \text{Ext}^{n-m}(C, \bullet) \rightarrow \text{Ext}^n(B, \bullet)$$

is a natural transformation by NL, so precomposition by  $\bullet \sqcup v$  yields a transformation  $(\bullet \sqcup v)^*$ :

$$\begin{array}{ccc} \text{Nat}(\text{Ext}^n(B, \bullet), A \otimes) & \xrightarrow{(\bullet \sqcup v)^*} & \text{Nat}(\text{Ext}^{n-m}(C, \bullet), A \otimes) \\ \cong & & \cong \\ \text{Tor}_n(A, B) & \xrightarrow{v \sqcap \bullet} & \text{Tor}_{n-m}(A, C) \end{array}$$

Note that by A, we have, with  $u \in \text{Ext}^\ell(C, D)$ :

$$\begin{array}{ccc} \text{Nat}(\text{Ext}^n(B, \bullet), A \otimes) & \xrightarrow{(\bullet \sqcup v)^*} & \text{Nat}(\text{Ext}^{n-m}(C, \bullet), A \otimes) \\ & \searrow & \downarrow (\bullet \sqcup u)^* \\ & & \text{Nat}(\text{Ext}^{n-m-\ell}(D, \bullet), A \otimes) \end{array}$$

The diagonal arrow sends  $\tau$  to

$$\begin{aligned} (\bullet \sqcup u)^*(\bullet \sqcup v)^* \tau &= \tau((\bullet \sqcup u) \sqcup v) \\ &= \tau(\bullet \sqcup (u \sqcup v)) \\ &= (\bullet \sqcup (u \sqcup v))^* \tau. \end{aligned}$$

This just says that for  $x \in \text{Tor}_n(A, B)$ ,  $u \sqcap (v \sqcap x) = (u \sqcup v) \sqcap x$ . The remaining properties of  $\sqcap$  (e.g., bilinearity) are left to the interested reader; most are straightforward.

## 9.6 The Jacobson Radical, Nakayama's Lemma, and Quasiloca! Rings

This section requires material from Chapters 1 through 5, and Section 9.1. The first half is actually pure ring theory, and has no prerequisites beyond the ring theory assumed throughout this book (except for a reference to Proposition 4.28, which can be read on its own).

The first subject for discussion is the Jacobson radical. It is not well known, but the Jacobson radical makes perfectly good sense for modules, at least when working with rings-with-unit. This actually gives a good setting for the preliminaries to Nakayama's lemma. This will be discussed as a unit (no pun intended), culminating in a bona-fide proposition (Proposition 9.26 below).

A very readable reference for this material is Farb and Dennis [18, Chapter 2]. (See also Lam [49, Chapter 2 and §19], especially about quasilo!al rings.)

First of all, let  $B \in {}_R\mathbf{M}$ . Given a subset  $S \subset B$ , write  $\langle S \rangle$  for the submodule generated by  $S$ ;  $\langle S, x_1, \dots, x_n \rangle$  for the submodule generated by  $S \cup \{x_1, \dots, x_n\}$ ; and so on. An element  $x \in B$  is called a *nongenerator* of  $B$  if for any subset  $S$  of  $B$ ,  $B = \langle S, x \rangle \Rightarrow B = \langle S \rangle$ . The set of nongenerators  $J(B)$  of  $B$  is the Jacobson radical of  $B$ .  $J(B)$  is the module analog of the Frattini subgroup in group theory. It is pretty easy to show that  $J(B)$  is a submodule of  $B$ , but we will shortly get that free of charge.

First of all, suppose  $x \in J(B)$ , and suppose  $M$  is a maximal submodule. Then  $x \notin M \Rightarrow B = \langle M, x \rangle$ , but  $B \neq \langle M \rangle$ , a contradiction. That means that  $J(B)$  is contained in every maximal submodule of  $B$ . On the other hand, if  $x \notin J(B)$ , say  $B = \langle S, x \rangle$  but  $B \neq \langle S \rangle$ , Proposition 4.28 says that  $S$  is contained in a maximal submodule  $M$  with  $x \notin M$ . Consequently, the intersection of the maximal submodules is exactly  $J(B)$ . This intersection is a submodule, so  $J(B)$  is a submodule.  $J(B) = B$  if  $B$  has no maximal submodules. (Example:  $J(\mathbb{Q}) = \mathbb{Q}$  as a  $\mathbb{Z}$ -module, a fact left as an exercise.)

The module form of Nakayama's lemma reads: If  $B$  is finitely generated, and  $C$  is a submodule with  $B = J(B) + C$ , then  $B = C$ . The reason is that if  $B$  is generated by  $\{b_1 + c_1, \dots, b_n + c_n\}$ ,  $b_j \in J(B)$  and  $c_j \in C$ , then  $B = \langle c_1, \dots, c_n, b_1, \dots, b_n \rangle = \langle c_1, \dots, c_n, b_1, \dots, b_{n-1} \rangle = \dots = \langle c_1, \dots, c_n \rangle \subset C$ .

One more definition, for  $R$  itself. If  $x \in R$ , then  $x$  is *left quasiregular* if  $1 + x$  has a left inverse. Writing the inverse as  $1 + y$ , the relevant equation is  $x + y + yx = 0$ .  $y$  is called a *left quasi-inverse*. Similarly,  $x$  is *right quasiregular* if  $1 + x$  has a right inverse. Set

$$Q_L = \{x \in R : rx \text{ is left quasiregular for all } r \in R\}$$

and

$$Q_R = \{x \in R : xr \text{ is right quasiregular for all } r \in R\}.$$

Example: If  $R$  is a field, then only  $-1$  fails to be left quasiregular, but "... for all  $r \in R$ " forces  $Q_L = 0$ .

If  $x \in J(R)$ , then  $x$  must be left quasiregular, since otherwise  $R(1+x) \neq R \Rightarrow R(1+x) \subset M$  for some maximal left ideal  $M$ . But already  $x \in M$ , so  $1+x, x \in M \Rightarrow 1 \in M$ , a contradiction. That is,  $J(R)$  consists of left quasiregular elements, so  $J(R) \subset Q_L$ . (Trivial exercise:  $Q_L$  contains any left ideal consisting of left quasiregular elements.)

We have one more thing to work out so everything will fall into place:  $Q_L \cdot B \subset J(B)$  for any  $B \in {}_R\mathbf{M}$ . To see this, suppose  $x \in Q_L$  and  $b \in B$ ; we must show that  $xb$  is a nongenerator of  $B$ . But if  $B = \langle S, xb \rangle$ , then  $b \in \langle S, xb \rangle \Rightarrow b = (\sum y_i s_i) + r \cdot xb$  for  $s_i \in S$ ,  $y_i \in R$ ,  $r \in R$ . But now  $(1 - rx) \cdot b = \sum y_i s_i$ , and  $x \in Q_L \Rightarrow (-r)x$  is left quasiregular  $\Rightarrow 1 - rx$  has a left inverse  $u$  so that  $b = u(1 - rx)b = \sum uy_i s_i \in \langle S \rangle$ . But now  $b \in \langle S \rangle \Rightarrow xb \in \langle S \rangle \Rightarrow \langle S \rangle = \langle S, xb \rangle = B$ .

The rest is observation. Set  $B = R$ :

$$J(R) \subset Q_L \subset Q_L \cdot R \subset J(R).$$

Hence, all these containments are equalities. Thus,

- a)  $J(R) = Q_L$ , in view of which
- b)  $J(R) \cdot R = J(R)$ , that is,  $J(R)$  is a right ideal, too.
- c) In general,  $J(R) \cdot B \subset J(B)$ .

Now suppose  $x \in J(R)$ . Then  $x$  has a left quasi-inverse  $y$  for which  $x + y + yx = 0$ . But then  $y = -x - yx \in J(R)$ , so  $y$  has a left quasi-inverse, too, call it  $z$ . Thus  $1 + x = ((1+z)(1+y))(1+x) = (1+z)((1+y)(1+x)) = 1 + z$ , and  $x = z$ . But *that* means that  $x$  is also right quasiregular. Since  $x$  was arbitrary and  $J(R)$  is a right ideal,  $J(R) \subset Q_R$ . So  $Q_L \subset Q_R$  in general. Looking in the opposite ring  $R^{\text{op}}$ ,  $Q_R \subset Q_L$ , so  $Q_R = Q_L = J(R)$ . Still looking in  $R^{\text{op}}$ ,  $J(R)$  is the Jacobson radical of  $R^{\text{op}}$ . We have proved:

**Proposition 9.27** *For any left  $R$ -module  $B$ , the Jacobson radical  $J(B)$  of  $B$ , that is, the set of nongenerators of  $B$ , is equal to the intersection of the maximal submodules of  $B$ . Furthermore, if  $B$  is finitely generated and  $C$  is a submodule with  $B = J(B) + C$ , then  $B = C$ . Also,  $J(R) \cdot B \subset J(B)$ . Finally,  $J(R)$  is a two-sided ideal which can be characterized in any of the following ways:*

- i)  $J(R)$  is the intersection of the maximal left ideals.
- ii)  $J(R)$  is the intersection of the maximal right ideals.

- iii)  $J(R)$  is the largest left ideal consisting of left quasiregular elements.
- iv)  $J(R)$  is the largest right ideal consisting of right quasiregular elements.

**Corollary 9.28 (Nakayama's Lemma)** *If  $B$  is a finitely generated left  $R$ -module,  $C$  is a submodule, and  $B = J(R)B + C$ , then  $B = C$ .*

**Proof:**  $J(R)B \subset J(B) \Rightarrow B = J(B) + C \Rightarrow B = C$ . □

**Corollary 9.29 (Nakayama's Lemma—Alternative Form)** *If  $B$  is a finitely generated left  $R$ -module for which  $B = J(R)B$ , then  $B = 0$ .*

**Proof:** Set  $C = 0$  in the preceding corollary. □

The material just developed is particularly useful for local rings, and much applies to quasilocal rings. A ring  $R$  is *quasilocal* provided  $R$  has a unique maximal left ideal  $M$ . The first point: The apparent left-right asymmetry is illusory. To see this, observe that  $M = J(R)$  is a two-sided ideal, and furthermore  $R/M$  has no nontrivial proper left ideals. By an old standby in undergraduate modern algebra,  $R/M$  is a division ring, so it has no nontrivial proper right ideals either. But  $J(R) = M$  is contained in every maximal right ideal of  $R$ , so  $M$  is the unique maximal right ideal, too. The structure we need is given by the following.

**Proposition 9.30** *Suppose  $R$  is a ring, and  $M$  is a left ideal. Then the following are equivalent:*

- i)  $R$  is quasilocal with maximal ideal  $M$ .
- ii) Every  $x \notin M$  has a left inverse.
- iii) Every  $x \notin M$  has a two-sided inverse.

**Proof:** (i)  $\Rightarrow$  (iii): Suppose (i). If  $x \in R$ , then  $Rx \neq R \Rightarrow Rx \subset$  some maximal left ideal, which must be  $M$ . That is,  $Rx \neq R \Rightarrow Rx \subset M \Rightarrow x \in M$ . Hence,  $x \notin M \Rightarrow Rx = R \Rightarrow x$  has a left inverse, call it  $y$ . Similarly,  $x \notin M \Rightarrow xR = R \Rightarrow x$  has a right inverse, call it  $z$ . Final step:  $y = y(xz) = (yx)z = z$  is a two-sided inverse.

(iii)  $\Rightarrow$  (ii) is trivial, so to prove (ii)  $\Rightarrow$  (i), assume (ii). If  $I$  is any left ideal, then  $I \not\subset M \Rightarrow \exists x \in I - M$ , for which  $R = Rx \subset I$ . That is,  $I \not\subset M \Rightarrow I = R$ , or  $I \neq R \Rightarrow I \subset M$ . Hence,  $M$  is a largest proper left ideal, so it is the unique maximal left ideal. □

If the Jacobson radical of a ring is known, quasilocality is easily checked:

**Corollary 9.31** *If  $R$  is a ring, then the following are equivalent:*



- i)  $R$  is quasilocal.
- ii) Every element of  $R - J(R)$  is invertible.
- iii)  $R/J(R)$  is a division ring.

**Proof:** (i)  $\Rightarrow$  (ii) follows from Proposition 9.30(iii). (ii)  $\Rightarrow$  (iii) is direct, since if  $x \notin J(R)$ , then  $x^{-1} + J(R)$  is an inverse to  $x + J(R)$  in  $R/J(R)$ . Finally, given (iii),  $R/J(R)$  has no nontrivial proper left ideals, so if  $M$  is a maximal left ideal, then  $J(R) \subset M$  by Proposition 9.27, so that  $J(R) = M$  by the Noether correspondence for ideals containing  $J(R)$ . Hence,  $J(R)$  is the unique maximal left ideal, and  $R$  is quasilocal.  $\square$

For the remainder of this section,  $R$  will denote a quasilocal ring. Suppose  $B$  is a finitely generated left  $R$ -module. A set  $\{x_1, \dots, x_n\} \subset B$  is a *minimal set of generators* if  $B$  is generated by  $\{x_1, \dots, x_n\}$  but is not generated by a proper subset of  $\{x_1, \dots, x_n\}$ .

**Proposition 9.32** *Suppose  $R$  is a quasilocal with maximal ideal  $M$ , and  $B$  is finitely generated as an  $R$ -module. Then  $\{x_1, \dots, x_n\}$  is a minimal set of generators of  $B$  if and only if  $\{x_1 + MB, \dots, x_n + MB\}$  is a basis of  $B/MB$  as a left vector space over the division ring  $R/M$ . In particular, the number  $n$  of generators is unique.*

**Proof:** This follows directly from a subclaim, that  $\{x_1, \dots, x_n\}$  generates  $B$  over  $R$  if and only if  $\{x_1 + MB, \dots, x_n + MB\}$  generates  $B/MB$  over  $R/M$ , the reason being that a basis of a left vector space over a division ring is just a minimal set of generators. As for the subclaim, observe that

$$\begin{aligned} \langle x_1 + MB, \dots, x_n + MB \rangle &= B/MB \\ &\Leftrightarrow \langle MB, x_1, \dots, x_n \rangle = B \\ &\Leftrightarrow B = MB + \langle x_1, \dots, x_n \rangle \\ &\Leftrightarrow B = \langle x_1, \dots, x_n \rangle, \end{aligned}$$

the last implication via Nakayama's lemma.  $\square$

Now for some homological algebra.

**Proposition 9.33** *Suppose  $R$  is quasilocal with maximal ideal  $M$ , and suppose  $\{x_1, \dots, x_n\}$  is a minimal set of generators for a finitely generated left  $R$ -module  $B$ . Let  $F$  be free on  $\{u_1, \dots, u_n\}$ , and let  $\pi : F \rightarrow B$  be defined by  $\pi(u_j) = x_j$ . Then  $MF \supset \ker \pi$ , and  $\pi : F \rightarrow B$  is a projective cover.*

**Proof:** If  $\sum r_i u_i \in \ker \pi$ , then all  $r_i \in M$ , since if some  $r_j \notin M$ , then

$$\begin{aligned} u_j + \sum_{i \neq j} r_j^{-1} r_i u_i \in \ker \pi &\Rightarrow x_j + \sum_{i \neq j} r_j^{-1} r_i x_i = 0 \\ &\Rightarrow x_j \in \langle x_1, \dots, x_{j-1}, x_{j+1}, \dots, x_n \rangle, \end{aligned}$$



contradicting minimality. Finally, if  $f : C \rightarrow F$  is such that  $\pi f$  is onto, then  $F = \ker \pi + \text{im}(f) \subset MF + \text{im}(f) \Rightarrow F = \text{im}(f)$  by Nakayama's lemma.  $\square$

**Corollary 9.34** *If  $R$  is a quasilocal ring, then any finitely generated projective left  $R$ -module is free.*

**Proof:** Construct  $F$  as above for a finitely generated projective  $P$ . There is an  $f : P \rightarrow F$  such that  $\pi f = i_P$  since  $P$  is projective; this implies that  $f$  is one-to-one, while Proposition 9.33 says that  $f$  is onto.  $\square$

Kaplansky [44] has shown that "finitely generated" can be omitted in this corollary.

In the next section, examples will be given of commutative quasilocal rings. A noncommutative example can be constructed as follows:

**Example 34** If  $k$  is a field of characteristic  $p$ , and  $G$  is a finite  $p$ -group, then the group ring  $k[G]$  is quasilocal. In particular, taking  $k$  finite and  $G$  noncommutative, there exist finite noncommutative quasilocal rings.

To see how this example works out, define  $\epsilon : k[G] \rightarrow k$  via  $\epsilon(\sum x_i g_i) = \sum x_i$ ;  $\epsilon$  is called the *augmentation map*, and is a ring homomorphism onto with kernel  $M = \{\sum x_i g_i : \sum x_i = 0\}$ . Now  $k[G]/M \approx k$  is a field, so it suffices to check that  $J(k[G]) = M$ . Since  $M$  is a maximal left ideal,  $M \supset J(k[G])$ , so to get  $M \subset J(k[G])$  it suffices to check that  $M$  consists of quasiregular elements. But  $k[G]$  is also a  $k$ -algebra, and  $M$  has a vector-space basis  $\{g - 1 : g \in G, g \neq 1\}$ , each element of which is nilpotent:  $|G| = p^n \Rightarrow (g - 1)^{p^n} = g^{p^n} - 1 = 0$  since  $k$  has characteristic  $p$ . A theorem of Wedderburn (see Herstein [32, pp. 56–58]) asserts that if an ideal in a finite-dimensional algebra over a field has a basis consisting of nilpotent elements, then the ideal must consist of nilpotent elements. But nilpotent elements are left quasiregular:

$$(1 - x + x^2 - x^3 + \cdots)(1 + x) = 1.$$

This example has all the Noetherian or Artinian properties one could want. In fact, without some kind of Noetherian condition we could not proceed systematically, but left Noetherian is enough to get the remaining results of this section. We need two lemmas.

**Lemma 9.35** *Suppose  $R$  is quasilocal with maximal ideal  $M$  and quotient division ring  $D = R/M$ . Suppose  $B$  is a finitely generated left  $R$  module, and  $\pi : F \rightarrow B$  is a projective cover as described in Proposition 9.33, with  $K = \ker \pi$ . Then*

$$\text{Tor}_1(D, B) \approx K/MK$$

and

$$\text{Ext}^1(B, D) \approx \text{Hom}(K, D).$$

**Proof:**  $0 \rightarrow K \rightarrow F \rightarrow B \rightarrow 0$  is short exact, so we have from the long exact sequence for Tor:

$$0 \rightarrow \text{Tor}_1(D, B) \rightarrow D \otimes K \rightarrow D \otimes F \rightarrow D \otimes B \rightarrow 0.$$

Now

$$D \otimes K = (R/M) \otimes K \approx K/MK$$

and

$$D \otimes F = (R/M) \otimes F \approx F/MF$$

by Proposition 2.2(b). But  $D \otimes K \rightarrow D \otimes F$  then becomes  $K/MK \rightarrow F/MF$ , which is zero since  $K \subset MF$  (Proposition 9.33). Hence,  $\text{Tor}_1(D, B) \approx K/MK$ .

As for  $\text{Ext}^1$ , we have from the long exact sequence for Ext:

$$0 \rightarrow \text{Hom}(B, D) \rightarrow \text{Hom}(F, D) \rightarrow \text{Hom}(K, D) \rightarrow \text{Ext}^1(B, D) \rightarrow 0.$$

If  $f \in \text{Hom}(F, D)$ , then for all  $m \in M$ ,  $f(mx) = mf(x) = 0$ , since  $mD = 0$ . That is, any  $f \in \text{Hom}(F, D)$  restricts to zero on  $MF \supset K$ , so  $\text{Hom}(F, D) \rightarrow \text{Hom}(K, D)$  is the zero map and  $\text{Ext}^1(B, D) \approx \text{Hom}(K, D)$ .  $\square$

The second lemma reinterprets the isomorphism for  $\text{Ext}^1$ . Recall that if  $V$  is a left vector space over a division ring  $D$ , then its dual  $\text{Hom}_D(V, D)$  is a *right* vector space over  $D$ .

**Lemma 9.36** *Suppose  $R$  is quasilocal with maximal ideal  $M$  and quotient division ring  $D = R/M$ . Then for any  $B \in {}_R\mathbf{M}$ ,  $\text{Hom}_R(B, D) \approx \text{Hom}_D(B/MB, D)$ .*

**Proof:** As in the proof of Lemma 9.35, if  $f \in \text{Hom}_R(B, D)$ , then for  $m \in M$ ,  $x \in B$ , we have  $f(mx) = mf(x) = 0$ , since  $f(x) \in R/M$ . Thus,  $f$  restricts to zero on  $MB$ , so restriction from  $\text{Hom}(B, D)$  to  $\text{Hom}(MB, D)$  is the zero map. Applying  $\text{Hom}(\bullet, D)$  to  $0 \rightarrow MB \rightarrow B \rightarrow B/MB \rightarrow 0$  yields exactness of

$$0 \rightarrow \text{Hom}_R(B/MB, D) \rightarrow \text{Hom}_R(B, D) \xrightarrow{0} \text{Hom}_R(MB, D),$$

so that  $\text{Hom}_R(B, D) \approx \text{Hom}_R(B/MB, D) = \text{Hom}_D(B/MB, D)$ , since  $B/MB$  and  $D$  are "really"  $D$ -modules.  $\square$

We can now apply this all inductively, after making our left-Noetherian assumption.

**Theorem 9.37 (Universality of D)** *Suppose  $R$  is quasilocal and left Noetherian with maximal ideal  $M$  and quotient division ring  $D = R/M$ . Let  $B$  be a nonzero finitely generated left  $R$ -module. Then  $\text{Tor}_n(D, B)$  is nonzero for  $0 \leq n \leq \text{P-dim}(B)$ , and the dual of  $\text{Tor}_n(D, B)$  as a left vector space over  $D$  is  $\text{Ext}^n(B, D)$ . In particular, the left global dimension of  $R$  is equal both to the flat dimension of  $D$  as a right  $R$ -module and the injective dimension of  $D$  as a left  $R$ -module.*

**Proof:** The claim is that if  $n \leq \text{P-dim } B$ , then  $\text{Tor}_n(D, B) \neq 0$  and the dual of  $\text{Tor}_n(D, B)$  as a left vector space over  $D$  is  $\text{Ext}^n(B, D)$ . This is by induction on  $n$ . The  $n = 0$  case is just

$$\text{Tor}_0(D, B) \approx (R/M) \otimes B \approx B/MB \neq 0$$

by Proposition 2.2(b) and Nakayama's lemma. Furthermore,

$$\text{Ext}^0(B, D) \approx \text{Hom}_R(B, D) \approx \text{Hom}_D(B/MB, D)$$

by Lemma 9.36.

For  $n > 0$ , let  $\pi : F \rightarrow B$  be a projective cover as described in Lemma 9.35. Then by Lemma 9.35, for  $\text{P-dim } B \geq 1$  we get  $K \neq 0$ , so that  $K/MK \neq 0$  by Nakayama's lemma. But then  $\text{Tor}_1(D, B) \neq 0$  and  $\text{Ext}^1(B, D)$  is its dual by Lemmas 9.35 and 9.36. As for the induction step  $n - 1 \mapsto n$ , when  $n > 1$  observe that

$$\text{Tor}_n(D, B) \approx \text{Tor}_{n-1}(D, K) \neq 0 \text{ for } n - 1 \leq \text{P-dim } K$$

by the long exact sequence for Tor and the induction hypothesis. But  $\text{P-dim } K = \text{P-dim } B - 1$  by Exercise 2, Chapter 4. Furthermore,  $\text{Ext}^n(B, D) \approx \text{Ext}^{n-1}(K, D)$  is the dual of  $\text{Tor}_{n-1}(D, K)$  by the long exact sequence for Ext and the induction hypothesis.

Finally, since  $\text{Tor}_n(D, B) \neq 0$  for all  $n \leq \text{P-dim } B$ , the flat dimension of  $D$  as a right  $R$ -module must be  $\geq \text{P-dim } B$ . Letting  $B$  float and using the global dimension theorem, the flat dimension of  $D$  as a right  $R$ -module is  $\geq \text{LG-dim } R = \text{W-dim } R$ . The situation for the injective dimension of  $D$  as a left  $R$ -module is similar.  $\square$

**Corollary 9.38** *Suppose  $R$  is quasilocal and left and right Noetherian with maximal ideal  $M$  and quotient division ring  $D = R/M$ . Then all dimensions (left/right and flat/projective/injective) of  $D$  are equal to the left global dimension of  $R$ , and  $\text{Tor}_n(D, D)$  and  $\text{Ext}^n(D, D)$  are nonzero for  $0 \leq n \leq \text{LG-dim } R$ .*

**Proof:** Theorem 9.37 applies on both sides, giving left/right, flat/injective dimensions =  $\text{LG-dim } R = \text{RG-dim } R = \text{W-dim } R$  by Corollary 4.21. Since

projective dimension = flat dimension by Proposition 4.20 itself, we have the dimensional result. The rest is now direct from Theorem 9.37.  $\square$

As an example of some of this, a definitive answer about projective dimension can be given in one unusual case.

**Proposition 9.39** *Suppose  $R$  is quasilocal and left Noetherian with maximal ideal  $M$ . Suppose  $\exists x \in M$  with  $x \neq 0$  but  $xM = 0$ . Then every finitely generated nonprojective left  $R$ -module has infinite projective dimension.*

**Proof:** Suppose not. Suppose some finitely generated  $B \in {}_R\mathbf{M}$  has finite projective dimension and is not projective. We can replace  $B$  with  $K$ , where  $F$  is free and  $0 \rightarrow K \rightarrow F \rightarrow B \rightarrow 0$  is short exact, reducing the dimension if  $n > 1$ , so without loss of generality we may assume that  $\text{P-dim } B = 1$ . Let  $\pi : F \rightarrow B$  be a projective cover as described in Proposition 9.33 with  $K = \ker \pi$ . Then  $\text{P-dim } B \leq 1 \Rightarrow K$  is projective by the projective dimension theorem, while  $\text{P-dim } B > 0 \Rightarrow K \neq 0$ . But  $K \subset MF$ , so  $xK \subset xMF = 0$ . But  $xK \neq 0$  when  $K$  is free and nonzero since  $0 \neq x \in xR$ , a contradiction since all projective left  $R$ -modules are free (Corollary 9.34).  $\square$

This proposition applies to the rings  $k[G]$ , where  $k$  has characteristic  $p$  and  $G$  is a nonzero  $p$ -group. The reason is this. If  $R$  is a left Artinian ring, then  $J(R)$  is actually nilpotent, that is,  $J(R)^n = 0$  for some  $n$  (see Hungerford [37, p. 430]). Setting  $R = k[G]$ , there is a smallest  $n$  for which any product  $x_1x_2 \dots x_n$  from the maximal ideal  $M$  is zero, and there is a product  $0 = x_1x_2 \dots x_n$  for which  $x = x_1x_2 \dots x_{n-1} \neq 0$ , since  $n$  is minimal. This  $x$  works, since if  $y \in M$ , then  $xy = x_1x_2 \dots x_{n-1}y = 0$ , being a product in  $M^n$ . This actually proves the following corollary to Proposition 9.39:

**Corollary 9.40** *Suppose  $R$  is quasilocal and left Noetherian, with maximal ideal  $M$ . If  $M$  is nilpotent, then every finitely generated left  $R$ -module has projective dimension zero or infinity; moreover, the dimension infinity case is taken on by  $M$  itself unless  $M = 0$  (in which case  $R \approx R/M$  is a division ring).*

In the next section, commutativity will be imposed. The situation is more definitive, but it requires more commutative algebra in the details than can be casually assumed, so that final section will be largely expository.

## 9.7 Local Rings and Localization Revisited (Expository)

This section requires material from Chapters 1 through 5, and Sections 9.1 and 9.6. It is primarily a continuation of the last section.



In this section we assume our ring  $R$  is commutative. A commutative, Noetherian, quasilocal ring is called a *local ring*. The last section showed what the (left) Noetherian and quasilocal conditions forced. Here we investigate the consequences of commutativity.

Local rings come in two varieties, regular and nonregular. This dichotomy is well illustrated by two examples.

**Example 35**  $k[[x]]$ , the ring of formal power series over a field.  $k[[x]]$  is a PID with one prime,  $x$ , that generates the maximal ideal. Also the Krull and global dimensions of  $k[[x]]$  are equal to one.

**Example 36**  $\mathbb{Z}_4$ . The Krull dimension is zero, and the global dimension is infinite. (This case is covered by Proposition 9.39.) Finally, the maximal ideal is generated by one element.

There are various ways of defining regularity. The simplest is the following. If  $R$  is a local ring with maximal ideal  $M$ , then the minimal number of generators of  $M$  is the dimension of  $M/M^2$  over  $R/M$  by Proposition 9.32.  $R$  is *regular* if this number equals the Krull dimension of  $R$ .

If  $R$  is any commutative ring, and if  $P$  is a prime ideal, then the *rank* of  $P$  is the supremum of the lengths of chains of prime ideals

$$P_0 \subsetneq P_1 \subsetneq P_2 \subsetneq \cdots \subsetneq P_n = P : \text{length} = n$$

descending from  $P$ . The Krull dimension is the supremum of the ranks of the prime ideals. In Noetherian rings, every prime ideal has finite rank, thanks to the generalized principal ideal theorem. See Kaplansky [46, pp. 110–111]; see also Nagata [59, p. 26], who calls this the altitude theorem of Krull:

*If  $R$  is a commutative Noetherian ring, and if  $I$  is an ideal generated by  $n$  elements, then the rank of any prime ideal minimal over  $I$  is less than or equal to  $n$ .*

If  $R$  is local, with maximal ideal  $M = \langle x_1, \dots, x_n \rangle$ , where  $n = \dim_{R/M}(M/M^2)$ , then  $M$  is minimal over itself, so  $M$  has rank  $\leq n$ . It's pretty clear that the rank of  $M$  is the Krull dimension of  $R$ , since any chain of prime ideals can be extended up to  $M$ . Thus, the Krull dimension of  $R$  is less than or equal to  $n$ , with equality occurring exactly when  $R$  is regular.

The big theorem about regular/nonregular local rings, due to Serre, is:

*Suppose  $R$  is a local ring. If  $R$  is regular, then the global dimension and the Krull dimension of  $R$  are equal. If  $R$  is not regular, then  $R$  has infinite global dimension.*



The proof that regular local rings have equal global and Krull dimensions can be found in Rotman [68, pp. 261–262] or Kaplansky [47, p. 183]; the relevant structural results about local rings are in Kaplansky [46, pp. 115–120]. Three different proofs that nonregular local rings have infinite global dimension can be found in Ausmus [3], Matsumura [55, pp. 131–139], and Kaplansky [47, pp. 183–185]. This is the hard part, since it is regular local rings that have the nice internal structure. The Krull dimension zero case is easy to do “by hand” using Corollary 9.40.

The consequences for an arbitrary commutative Noetherian ring  $R$  come through localization. First of all, the Krull dimension of  $R$  is the supremum of the ranks of the maximal ideals  $M$ . But for any prime ideal  $P$ , the rank of  $P$  is equal to the Krull dimension of the localization  $R_P$ , as can be read off from Hungerford [37, Theorem 4.10, p. 148]. Combining, the Krull dimension of  $R$  is equal to the supremum of the Krull dimensions of the localizations  $R_M$  of  $R$  at maximal ideals.

This looks suspiciously like Theorem 5.20. In fact, combining with Serre’s theorem yields:

**Theorem 9.41** *Suppose  $R$  is a commutative Noetherian ring. If every localization  $R_M$  of  $R$  at a maximal ideal is regular, then the global dimension of  $R$  is equal to the Krull dimension of  $R$ . If some localization  $R_M$  of  $R$  at a maximal ideal is not regular, then  $R$  has infinite global dimension. In particular,*

$$\text{LG-dim } R \geq \text{Krull dimension of } R$$

*with equality if LG-dim  $R$  is finite.*

We would like to be more definitive about the infinite case, but we can’t; commutative Noetherian rings *can* have infinite Krull dimension (Nagata [59, p. 203]) so  $\text{LG-dim } R = \infty$  does not force a localization to be nonregular.

What can be said if  $R$  is not Noetherian? Not much. Chapter 4 closed with an example having global dimension two and Krull dimension one. The ring of entire functions (Appendix B) has infinite Krull dimension and (granting the continuum hypothesis) finite global dimension. We close with an example with weak dimension one, global dimension two, and Krull dimension three.

**Example 37**  $\mathbb{R}$  = real numbers. Set

$$R = \{f(t, x, y) \in \mathbb{R}(t, x, y) : f(t, e^{-1/t^2}, e^{-1/t^4}) \text{ extends to a } C^\infty \text{ function near } 0\}.$$

$R$  is clearly an integral domain, being a subring of a field. To illuminate the structure further, note that for all  $n \in \mathbb{N}$ ,  $t^{-n}x \in R$ ,  $t^{-n}y \in R$ , and

$x^{-n}y \in R$ ; the first is a standard example in  $C^\infty$  function theory, and the others work the same way. These extend to zero at zero.

Suppose  $f(t, x, y) \in \mathbb{R}[t, x, y]$ , the polynomial ring, with  $f(t, x, y) \neq 0$ . There is a lowest power  $n$  of  $y$  that appears so that one may write

$$f(t, x, y) = y^n(g(t, x) + y\phi(t, x, y))$$

with  $g(t, x) \neq 0$ . There is a lowest power  $m$  of  $x$  that appears in  $g(t, x)$  so that one may write

$$g(t, x) = x^m(h(t) + x\psi(t, x))$$

with  $h(t) \neq 0$ . Finally,  $h(t) = t^l(a + t\theta(t))$  for some  $l$  and  $a \neq 0$ . Thus,

$$\begin{aligned} f(t, x, y) &= y^n(g(t, x) + y\phi(t, x, y)) \\ &= y^n(x^m(h(t) + x\psi(t, x)) + y\phi(t, x, y)) \\ &= y^n(x^m(t^l(a + t\theta(t)) + x\psi(t, x)) + y\phi(t, x, y)) \\ &= y^n x^m (t^l(a + t\theta(t)) + x\psi(t, x) + x^{-m}y\phi(t, x, y)) \\ &= y^n x^m t^l (a + t\theta(t) + t^{-l}x\psi(t, x) + t^{-l}x^{-m}y\phi(t, x, y)) \\ &= y^n x^m t^l \cdot U(t, x, y) \end{aligned}$$

where  $U(t, x, y)$  is a unit in  $R$ . Hence, by dividing, we get that any nonzero  $f(t, x, y) \in \mathbb{R}(t, x, y)$  can be written as  $f(t, x, y) = t^l x^m y^n \cdot U(t, x, y)$ ;  $l, m, n \in \mathbb{Z}$  and  $U(t, x, y)$  a unit in  $R$ . Thus,  $f(t, x, y) \in R$  if and only if one of the following holds:

- i)  $n > 0$ , or
- ii)  $n = 0$  and  $m > 0$ , or
- iii)  $n = m = 0$  and  $l \geq 0$ .

In particular, if  $f(t, x, y) \notin R$ , then  $f(t, x, y)^{-1} \in R$ , so  $R$  is a *valuation domain*, an integral domain in which, for all nonzero  $a$  and  $b$ , either  $a/b$  or  $b/a$  is defined in the ring, that is, either  $b|a$  or  $a|b$ . In any valuation domain, given nonzero elements  $\{a_1, \dots, a_n\}$ , one must divide all the others, so it will be a GCD of  $\{a_1, \dots, a_n\}$  and will generate  $Ra_1 + \dots + Ra_n$ . Hence any valuation domain is a Bezout domain, an integral domain in which all finitely generated ideals are principal. (See Section 4.4.)

In any valuation domain, the ideals are totally ordered, since if  $I$  and  $J$  are ideals with  $I \not\subset J$  and  $J \not\subset I$ , choosing  $a \in J - I$  and  $b \in I - J$  yields

$$a \in J, b \notin J \Rightarrow a \text{ does not divide } b,$$

and

$$b \in I, a \notin I \Rightarrow b \text{ does not divide } a,$$

a contradiction. Hence, a maximal ideal in a valuation domain is actually largest, so it is the unique maximal ideal. That is, any valuation domain is quasilocal. Here the maximal ideal is  $Rt$ . Since  $x \in \cap (Rt)^n$ ,  $R$  is not Noetherian. (See Hungerford [37, Corollary 4.7, p. 390].) Since the group of units has a countable number of  $R$ -orbits (indexed by  $(l, m, n)$  above), all ideals are countably generated, so by the discussion in Section 4.4,  $R$  has weak dimension one and global dimension two.

The reason  $R$  has Krull dimension three is that the prime ideals are exactly

$$\begin{aligned} P_0 &= \{0\} \\ P_1 &= \langle y, y/x, y/x^2, \dots \rangle \\ P_2 &= \langle x, x/t, x/t^2, \dots \rangle \\ P_3 &= \langle t \rangle. \end{aligned}$$

By the way,  $t^{-l}x^{-m}y = (t^{-l}x) \cdot (x^{-m-1}y) \in P_1$  for  $l, m \in \mathbb{N}$ . With this in mind, suppose  $f(t, x, y)$  is associated as above with  $(l, m, n)$ . Then

$$f \in P_1 \Leftrightarrow n > 0;$$

$$f \in P_2 \Leftrightarrow n > 0 \text{ or } n = 0 \text{ and } m > 0;$$

$$f \in P_3 \Leftrightarrow n > 0, \text{ or } n = 0 \text{ and } m > 0, \text{ or } n = m = 0 \text{ and } l > 0.$$

Since these exponents add when forming products, virtually by inspection  $P_1, P_2$ , and  $P_3$  are prime ideals. Since  $R/P_3 \approx \mathbb{R}$ ,  $P_3$  is maximal.

Suppose  $P$  is a nonzero prime ideal. Then  $P$  contains some  $t^l x^m y^n$ . We can now analyze  $P$  by examining the alternative possibilities for  $(l, m, n)$  described earlier.

i) If  $n > 0$  for all such expressions in  $P$ , then  $P \subset P_1$ . But then  $y^{n+1} = (t^{-l}x^{-m}y) \cdot (t^l x^m y^n) \in P \Rightarrow y \in P$ , since  $P$  is prime, and  $x^m \notin P \Rightarrow x^{-m}y \in P$  for all  $m$  (since  $x^m \cdot (x^{-m}y) \in P$ ), since  $P$  is prime. Thus,  $P = P_1$ .

ii) If  $P$  contains some  $t^l x^m$ , and if  $m > 0$  for all such expressions in  $P$ , then  $P \subset P_2$ . But then  $x^{m+1} = (t^{-l}x) \cdot (t^l x^m) \in P$ , so that  $x \in P$  since  $P$  is prime, and  $t^l \notin P \Rightarrow t^{-l}x \in P$  for all  $l$  (since  $t^l(t^{-l}x) \in P$ ), since  $P$  is prime. Thus,  $P = P_2$ .

iii) Finally, if  $P$  contains some  $t^l$ , then  $P = P_3$  directly.



# Appendix A

## GCDs, LCMs, PIDs, and UFDs

### Abbreviations:

GCD—Greatest Common Divisor

LCM—Least Common Multiple

PID—Principal Ideal Domain

UFD—Unique Factorization Domain

We start with the most basic properties of divisibility, GCDs, and LCMs, namely those that do not depend on the additive structure of the integral domain in question. If  $R$  is an integral domain, let  $U(R)$  denote the group of units of  $R$ , and  $R^*$  the nonzero elements of  $R$ . The quotient  $R^*/U(R)$  is a monoid, that is, a semigroup with unit, which has some special properties: It is commutative, has a cancellation law, and no nonidentity element is invertible. This internal structure is enough to start the discussion, identifying divisibility, GCDs, LCMs, irreducibles, primes, and even UFDs.

To see how this goes, let  $M$  be any commutative monoid (with unit 1) having a cancellation law, in which no nonidentity element is invertible. Write  $a|b$  when  $b = ac$  for some  $c \in M$ .  $c$  is unique by the cancellation law, and we write  $c = b/a$ . Observe that for any  $a, b$ , and  $c$ ,  $a|b \Leftrightarrow ac|bc$ , in which case  $c|(b/a) \Leftrightarrow ca|b$ , and  $c \cdot (b/a) = (cb)/a$ , etc. If  $a|b$  and also  $b|a$ , then  $a = bd$  for some  $d$ , so  $a \cdot 1 = a = bd = acd$ , and  $cd = 1$  by the



cancellation law. But now  $d = c^{-1}$  and  $c = d^{-1}$ , so  $c = d = 1$ , since no nonidentity element is invertible. Thus  $a = b$ .

Notice two things about the preceding (if you didn't doze off). First, the required properties are all there in  $M$ . Second, that "no nonidentity element is invertible" restriction made "divides" antisymmetric.

One example of an abstract monoid with the above properties is a free commutative monoid, that is, a free object in the category of commutative monoids. If  $\{u_1, u_2, \dots\}$ , say, are generators, then elements have a unique (up to a permutation) finite expression

$$u_1^{n_1} u_2^{n_2} u_3^{n_3} \cdots u_k^{n_k}.$$

A glance at this verifies that:

*An integral domain  $R$  is a UFD if and only if  $R^*/U(R)$  is a free commutative monoid.*

Now for the old familiar concepts and the basic connections. In the following,  $M$  is a commutative monoid (with unit 1) having a cancellation law, in which no nonidentity element is invertible.

**Definition A.1** *If  $p \in M$ , then  $p$  is irreducible if  $p \neq 1$ , and  $\forall a : a|p \Rightarrow a = 1$  or  $a = p$ .*

**Definition A.2** *If  $p \in M$ , then  $p$  is prime if  $p \neq 1$ , and  $\forall a, b : p|ab \Rightarrow p|a$  or  $p|b$ .*

**Definition A.3** *If  $a, b \in M$ , then  $d$  is a GCD of  $a$  and  $b$  if  $d|a$ ,  $d|b$ , and  $\forall c : (c|a \text{ and } c|b) \Rightarrow c|d$ .*

**Definition A.4** *If  $a, b \in M$ , then  $d$  is an LCM of  $a$  and  $b$  if  $a|d$ ,  $b|d$ , and  $\forall c : (a|c \text{ and } b|c) \Rightarrow d|c$ .*

Many of the familiar properties are immediate. For example, all primes are irreducible.

**Miniproof:** If  $a|p$ , say  $p = ab$ , then  $p|ab$ , so  $p|a$  or  $p|b$ . If  $p|a$ , then  $p = a$  by the earlier discussion since  $a|p$ . If  $p|b$ , then  $p = b$  (and  $a = 1$ ) by the earlier discussion too, since  $b|p$ .

Similarly, since any two GCDs must divide each other, a GCD is unique if it exists. If a GCD of  $a$  and  $b$  exists, it will be written as  $(a, b)$ . The LCM of  $a$  and  $b$  is similarly unique if it exists, in which case it will be written as  $[a, b]$ . The following result lists the basic properties that are not necessarily trivial, or necessarily familiar.

**Proposition A.5** *Suppose  $M$  is a commutative monoid satisfying a cancellation law, in which no nonidentity element is invertible. Suppose  $a, b, c \in M$ .*

- a) If  $(ac, bc)$  exists, then  $(a, b)$  exists, and  $(ac, bc) = (a, b) \cdot c$ .
- b)  $[ac, bc]$  exists if and only if  $[a, b]$  exists, and  $[ac, bc] = [a, b] \cdot c$ .
- c)  $[a, b]$  exists if and only if  $(ad, bd)$  exists for all  $d \in M$ , and  $(a, b) \cdot [a, b] = ab$ .
- d) If  $(a, b) = 1$ , and if  $(a, c)$  and  $(ac, bc)$  exist, then  $(a, bc) = (a, c)$ .

**Proof:** (a)  $c|ac$  and  $c|bc$ , so  $c|(ac, bc)$ . The claim is that  $(ac, bc)/c$  is a GCD for  $a$  and  $b$ . First of all,  $(ac, bc)|ac$ , so  $\{(ac, bc)/c\}|\{(ac)/c\}$ , or  $\{(ac, bc)/c\}|a$ . Similarly,  $\{(ac, bc)/c\}|b$ . Finally, if  $d|a$  and  $d|b$ , then  $dc|ac$  and  $dc|bc$ , so  $dc|(ac, bc)$ , giving  $d|\{(ac, bc)/c\}$ .

(d) The claim is that  $(a, c)$  is a GCD for  $a$  and  $bc$ . In the first place,  $(a, c)|c$ , so  $(a, c)|bc$ . Since also  $(a, c)|a$ , it only remains to show that if  $d|a$  and  $d|bc$ , then  $d|(a, c)$ . But for such a  $d$ ,  $d|ac$  too, so  $d|(ac, bc)$ . By (a),  $(ac, bc) = (a, b) \cdot c = c$ , so  $d|c$ . Since already  $d|a$ , we get that  $d|(a, c)$ , as required.

(b) and (c) are proven simultaneously by verifying the following three statements.

- (e) If  $[a, b]$  exists, then  $[ac, bc]$  exists, with  $[ac, bc] = [a, b] \cdot c$ .
- (f) If  $[a, b]$  exists, then  $(a, b)$  exists, with  $(a, b) = ab/[a, b]$ .
- (g) If  $(ad, bd)$  exists for all  $d \in M$ , then  $[a, b]$  exists.

These do give (b): The “if” part is (e), while also by (e), if  $[ac, bc]$  exists, then for all  $d \in M$ ,  $[acd, bcd]$  also exists. Hence, for all  $d \in M$ ,  $(acd, bcd)$  exists by (f), so that  $(ad, bd)$  exists by (a). But then (g) gives that  $[a, b]$  exists, since  $d$  is arbitrary.

These also give (c): The “if” part is (g) and the formula is from (f), while if  $[a, b]$  exists, then for all  $d \in M$ ,  $[ad, bd]$  exists by (e), whence  $(ad, bd)$  exists by (f).

**Proof of (e):** The claim is that  $[a, b] \cdot c$  is an LCM for  $ac$  and  $bc$ . Well,  $a|[a, b]$ , so  $ac|[a, b] \cdot c$ . Similarly,  $bc|[a, b] \cdot c$ . Finally, if  $ac|d$  and  $bc|d$ , then  $c|d$ , so that  $a|(d/c)$  and  $b|(d/c)$ , giving  $[a, b]|(d/c)$ , or  $\{[a, b] \cdot c\}|d$ .

**Proof of (f):** The claim is that  $ab/[a, b]$  is a GCD for  $a$  and  $b$ . In the first place,  $a|ab$  and  $b|ab$ , so  $[a, b]|ab$  and  $ab/[a, b]$  is defined. Also,  $a = (ab/[a, b]) \cdot ([a, b]/b)$ , so  $(ab/[a, b])|a$ . Similarly,  $(ab/[a, b])|b$ . Finally, if  $d|a$  and  $d|b$ , then  $ab/d = a \cdot (b/d)$ , so  $a|(ab/d)$ . Similarly,  $b|(ab/d)$ , so  $[a, b]|(ab/d)$ , or  $[a, b] \cdot d|ab$ , or  $d|(ab/[a, b])$ .

**Proof of (g):** Here we show that  $ab/(a, b)$  is an LCM of  $a$  and  $b$ .  $ab/(a, b) = a \cdot \{b/(a, b)\}$ , so  $a|\{ab/(a, b)\}$ . Similarly,  $b|\{ab/(a, b)\}$ . Finally, if  $a|d$  and  $b|d$ , then  $ab|ad$  (since  $b|d$ ) and  $ab|bd$  (since  $a|d$ ) so that  $ab|(ad, bd)$ . That is,  $ab|\{(a, b) \cdot d\}$  by (a), or  $\{ab/(a, b)\}|d$ .  $\square$

**Corollary A.6** *Suppose  $M$  is a commutative monoid satisfying a cancellation law, in which no nonidentity element is invertible. Then any two elements of  $M$  have a GCD if and only if any two elements of  $M$  have an LCM, in which case all irreducibles are prime.*

**Proof:** The “if and only if” statement follows directly from Proposition A.5(c). As for irreducibles being prime, suppose  $p$  is irreducible, and  $p|ab$  but  $p \nmid a$ . Then as a divisor of  $p$ ,  $(p, a) = 1$  or  $p$ , but can't be  $p$  since  $p \nmid a$ . Hence,  $(p, a) = 1$ , so by Proposition A.5(d),  $(p, ab) = (p, b)$ . But  $(p, ab) = p$  (since  $c|d \Rightarrow (c, d) = c$  always), so since  $(p, b)|b$ , we get that  $p|b$ .  $\square$

With that out of the way, we move on to integral domains, specifically GCD domains, UFDs, and PIDs. (A *GCD domain* is an integral domain in which any two nonzero elements have a GCD) In the first place, products of primes are unique by the usual business (see, e.g., Artin [2, pp. 390–395] or Isaacs [39, p. 239–240]). It is products of irreducibles that aren't. Nevertheless, in view of the preceding corollary, an integral domain is a UFD if and only if it is a GCD domain in which every nonzero element is a product of irreducibles.

The next result is easy, but fundamental.

**Proposition A.7** *Suppose  $R$  is an integral domain, with  $a$  and  $b$  nonzero in  $R$ . If  $a$  and  $b$  have a common divisor of the form  $d = \lambda a + \mu b$ , then  $d$  is a GCD for  $a$  and  $b$ .*

**Proof:** If  $c|a$  and  $c|b$ , then  $c|\lambda a$  and  $c|\mu b$ , so  $c|(\lambda a + \mu b)$ , or  $c|d$ .  $\square$

A *Bezout domain* is an integral domain in which every finitely generated ideal is principal.

**Corollary A.8** *Any Bezout domain is a GCD domain.*

**Proof:** A generator for  $Ra + Rb$  divides  $a$  and  $b$ , so it is a GCD for  $a$  and  $b$  by Proposition A.7.  $\square$

A bit more is needed for Bezout domains in Appendix B, as well as below.

**Proposition A.9** *A GCD domain is a Bezout domain if  $Ra + Rb = R$  whenever  $a$  and  $b$  are relatively prime (and nonzero).*

**Proof:** Suppose  $a$  and  $b$  are arbitrary nonzero elements of  $R$ . Set  $d = (a, b)$ ; then  $1 = (a/d, b/d)$  by Proposition A.5(a), so  $R(a/d) + R(b/d) = R$ , that is,  $1 = \lambda(a/d) + \mu(b/d)$  for some  $\lambda, \mu \in R$ . But now  $d = \lambda a + \mu b$ , so  $Ra + Rb \supset Rd$ . Since already  $d|a$  (giving  $Ra \subset Rd$ ) and  $d|b$  (giving  $Rb \subset Rd$ ), we get that  $Rd = Ra + Rb$ . That is,  $Ra + Rb$  is principal.

Now suppose  $a_1, \dots, a_n$  are nonzero in  $R$ . The claim is that  $Ra_1 + \dots + Ra_n$  is principal, and the proof is by induction on  $n$ .  $n = 1$  is trivial, and since  $Ra_{n-1} + Ra_n = Rd$ , where  $d = (a_{n-1}, a_n)$ , we get  $Ra_1 + \dots + Ra_n = Ra_1 + \dots + Ra_{n-2} + Rd$ , a principal ideal by the induction hypothesis.  $\square$

A note about LCMs: An LCM for  $a$  and  $b$  is just a generator for  $Ra \cap Rb$ . Consequently, in view of Corollary A.6, an integral domain is a GCD domain if and only if the intersection of any two principal ideals is principal.

Now for the identification of PIDs from among UFDs. Recall that any PID is a UFD. (See Hungerford [37, p. 138]). Also, a subset of a ring is a *multiplicative set* if it is closed under multiplication. Finally, if  $R$  is a UFD, and  $0 \neq a \in R$ , then writing  $a = u \cdot p_1 \cdot \dots \cdot p_k$ , where  $u$  is a unit and  $p_1, \dots, p_k$  are primes (perhaps not distinct), then  $k$  is the *length* of  $a$ , written  $\ell\{a\}$ . Observe that  $\ell\{a\} = 0$  if and only if  $a$  is a unit, and  $\ell\{(a, b)\} < \ell\{a\}$ , unless  $a|b$ . We need a lemma, which is quite general.

**Lemma A.10** *Suppose  $R$  is a ring, possibly without a unit, and suppose  $I$  is a right ideal. Then*

$$\{x \in R : I + Rx = R\}$$

*is a multiplicative set.*

**Proof:** Suppose  $I + Rx = R = I + Ry$ . Then

$$R = I + Ry = I + (I + Rx)y = I + Iy + Rxy = I + Rxy$$

since  $Iy \subset I$ .  $\square$

We now have what we need for our first PID identifier.

**Proposition A.11** *Suppose  $R$  is a UFD. Then the following are equivalent:*

- i)  $R$  is a PID.*
- ii)  $Rp + Rq = R$  whenever  $p$  and  $q$  are distinct (i.e., nonassociate) primes.*
- iii)  $R$  is a Bezout domain.*

**Proof:** (i)  $\Rightarrow$  (ii) is immediate, since  $Rp + Rq$  is principal, generated by  $(p, q) = 1$  by Proposition A.7.

(ii)  $\Rightarrow$  (iii). Suppose (ii), and suppose  $a$  and  $b$  are relatively prime. If  $p|a$ , then  $p$  is not a prime factor of  $b$ , and all prime factors of  $b$  belong to

$$\{x \in R : Rp + Rx = R\},$$



so  $b$  belongs to this set since it is a multiplicative set by Lemma A.10. But that means that all prime divisors of  $a$  belong to

$$\{x \in R : Rb + Rx = R\},$$

also a multiplicative set, so  $a$  belongs to this set. That is,  $Ra + Rb = R$ . Hence,  $R$  is a Bezout domain by Proposition A.9.

(iii)  $\Rightarrow$  (i). Suppose  $R$  is both a UFD and a Bezout domain. Let  $I$  be a nonzero ideal in  $R$ , and suppose  $a$  is a member of  $I$  having smallest length. If  $0 \neq b \in I$ , then  $Ra + Rb = Rd$  for  $d = (a, b)$  by Proposition A.7, so  $d \in Ra + Rb \subset I$ . But  $\ell\{d\} < \ell\{a\}$  unless  $a|b$ , and  $\ell\{a\}$  is smallest, so in fact  $a|b$  and  $b \in Ra$ . Since  $b \in I$  was arbitrary among nonzero elements,  $Ra \supset I$ . But  $a \in I \Rightarrow Ra \subset I$ , so  $I = Ra$  is principal.  $\square$

There is one more connection to make. The next lemma is an exercise in Hungerford [37, p. 140, Ex. 2] and a theorem in Cohn [14, p. 309] and Kaplansky [46, p. 4].

**Lemma A.12** *Suppose  $R$  is an integral domain. Then  $R$  is a UFD if and only if every nonzero prime ideal in  $R$  contains a nonzero principal prime ideal.*

**Proof:** First, suppose  $R$  is a UFD, and  $P$  is a nonzero prime ideal. Then there exists an  $a \in P$ ,  $a \neq 0$ . Since  $R$  is a UFD (and  $a$  is not a unit),  $a$  can be written as a product of primes:  $a = p_1 \cdots p_n$ . But  $p_1 \cdots p_n \in P \Rightarrow$  some  $p_j \in P$  since  $P$  is prime, giving  $P \supset Rp_j$ .

Next, suppose  $R$  is not a UFD. Let  $S$  denote the set of units together with the products of primes. If  $ab \in S$ , then  $a \in S$  and  $b \in S$  by induction on the length of  $ab$ : If  $ab$  is a unit (length zero), then so are both  $a$  and  $b$ . If  $ab = p_1 \cdots p_{n+1}$  is a product of  $n + 1$  primes, then  $p_{n+1}|ab$ , so  $p_{n+1}|a$  (and  $(a/p_{n+1}) \cdot b = p_1 \cdots p_n$ ) or  $p_{n+1}|b$  (and  $a \cdot (b/p_{n+1}) = p_1 \cdots p_n$ ), giving  $a, b \in S$ . (Observe that if  $x/p_{n+1} \in S$ , then  $x \in Sp_{n+1} \subset S$ .)

By assumption,  $R$  is not a UFD, so  $\exists a \notin S$ ,  $a \neq 0$ . If  $Ra \cap S \neq \emptyset$ , say  $ra \in S$ , then  $a \in S$  by the above, a contradiction. Hence,  $Ra \cap S = \emptyset$ . But now  $Ra$  is contained in an ideal  $P$  which is maximal among ideals in  $R - S$  by Zorn's lemma, and this ideal  $P$  is prime, since  $S$  is a multiplicative set (see Hungerford [37, p. 378]). But now  $P \cap S = \emptyset \Rightarrow P$  contains no primes, hence no principal prime ideals. But  $a \in P$ , and  $a \neq 0$ , so  $P \neq 0$ . Thus,  $R$  does not have a nonzero prime ideal, one that explicitly contains no nonzero principal prime ideal.  $\square$

Next, recall that the *Krull dimension* of any commutative ring is the supremum of the lengths

$$P_0 \subsetneq P_1 \subsetneq \cdots \subsetneq P_n : \text{length} = n$$



of chains of prime ideals. Since a nonzero prime ideal in a PID is maximal, any PID has Krull dimension one (unless it is actually a field, having Krull dimension zero). We need a lemma.

**Lemma A.13 (Variation on a Theme by Cohen [13])** *Suppose  $R$  is a commutative ring that is not a principal ideal ring. Let  $P$  be any ideal which is maximal with respect to the property of not being principal. Then  $P$  is prime. Also, such ideals exist.*

**Proof:** Suppose  $P$  is as above, and suppose  $ab \in P$ , but  $a \notin P$ ,  $b \notin P$ . Since  $a \notin P$ ,  $Ra + P \supsetneq P$ , so  $Ra + P = R\alpha$  for some  $\alpha$  by maximality of  $P$  among nonprincipal ideals. Set  $I = \{x \in R : x\alpha \in P\}$ . Then  $P \subset I$ , but also  $b \in I$ , since  $(Ra + P)b = Rab + Pb \subset P$ . That is,  $I \supsetneq P$ , so  $I = R\beta$  for some  $\beta$  again by maximality. Now  $p \in P \Rightarrow p \in R\alpha \Rightarrow p = r\alpha$  for some  $r \in R$ . But now  $r\alpha \in P \Rightarrow r \in I \Rightarrow r = s\beta$  for some  $s \in R$ , so that  $p = r\alpha = s\beta\alpha \in R\beta\alpha$ . Since  $p \in P$  was arbitrary,  $P \subset R\beta\alpha$ . But  $\beta \in I \Rightarrow \beta\alpha \in P$ , so in fact  $P = R\beta\alpha$  is principal after all, a contradiction.

Such ideals exist by Zorn's lemma. Let  $\mathcal{N}$  denote the set of nonprincipal ideals, partially ordered by set inclusion.  $\mathcal{N}$  is not empty since  $R$  is not a principal ideal ring. It suffices to show that if  $\{I_i : i \in \mathcal{I}\}$  is a nonempty chain of nonprincipal ideals, then  $\bigcup I_i$  is not principal. But if it were, say  $\bigcup I_i = Ra$ , then  $a \in I_j$  for a fixed  $j$ , where  $Ra = \bigcup I_i \supset I_j \supset Ra$ , giving  $I_j = Ra$  as a principal ideal, a contradiction.  $\square$

**Corollary A.14** *Suppose  $R$  is a commutative ring. If every prime ideal is principal, then  $R$  is a principal ideal ring.*

**Proof:** Immediate; contrapositive to Lemma A.13.  $\square$

Cohen's theorem states that a commutative ring is Noetherian when every prime ideal is finitely generated. Hungerford [37, pp. 379, 388, and 392] contains a nice discussion; see also Kaplansky [46, p. 5]. Lemma A.13 itself is due to Isaacs.

**Proposition A.15** *Suppose  $R$  is a UFD. Then  $R$  is a PID if and only if the Krull dimension of  $R$  is  $\leq 1$ .*

**Proof:** We show that if  $R$  is a UFD that is not a PID, then  $R$  contains a chain of prime ideals of length two. To start things, let  $P_2$  be a nonprincipal prime ideal, which must exist by Lemma A.13.  $P_2 \neq \{0\}$  since  $\{0\}$  is principal. Hence,  $P_2$  contains a nonzero principal prime ideal  $P_1$  by Lemma A.12.  $P_2 \supsetneq P_1$  since  $P_1$  is principal, but  $P_2$  is not. Finally, set  $P_0 = \{0\}$ .  $\square$

**Corollary A.16** *Suppose  $R$  is any ring consisting of algebraic integers. Then  $R$  is a UFD if and only if  $R$  is a PID*

**Proof:**  $R$  has Krull dimension one since it is integral over the PID  $\mathbb{Z}$ , and integrality preserves Krull dimension (see Kaplansky [46, p. 32]).  $\square$

Closing remarks. If  $R$  is the ring of integers of a number field  $K$  (i.e.,  $K$  is a finite extension of  $\mathbb{Q}$ ), then  $R$  is a PID iff  $R$  is a UFD iff the class number of  $K$  is one. This is a standard result from algebraic number theory (see Weiss [76, p. 146]). In fact, there's a generality (Krull dimension) behind it.

# Appendix B

## The Ring of Entire Functions

*And now for something completely different.*  
— *Monty Python*

The ring  $\mathcal{E}$  of entire functions is a most peculiar ring.

In some ways  $\mathcal{E}$  is quite nice. Granted the continuum hypothesis, it has finite global dimension. It is a GCD domain; in fact, *any* nonempty subset of  $\mathcal{E}^*$  has a GCD, just as if  $\mathcal{E}$  were a UFD. It also has lots of primes. In fact, most of what one expects of UFDs (e.g., being integrally closed) is true of  $\mathcal{E}$ .

But  $\mathcal{E}$  also has its dark side. Some ideals aren't even countably generated. And the Krull dimension of  $\mathcal{E}$  is infinite; in fact, the cardinal Krull dimension of  $\mathcal{E}$  is at least  $2^{\aleph_1}$ .

The Jekyll–Hyde nature of  $\mathcal{E}$  will emerge in due course. As should be expected, most proofs in this appendix are complex analytic proofs of algebraic facts.

The two primary sources of algebraic consequences are the Weierstrass product theorem and the Mittag–Leffler theorem. Versions of these theorems are valid for any region in  $\mathbb{C}$ , so every proposition in this appendix about  $\mathcal{E}$  is also valid for the ring of analytic functions on a region  $U$  in  $\mathbb{C}$ . We keep to  $\mathcal{E}$  to maintain some control on the analytic prerequisites. (Ahlfors [1, Chap. 5] or Rudin [70, Chaps. 13 and 15] will do.) Statements of these theorems are as follows:

**The Weierstrass Product Theorem** *Suppose  $\langle a_k \rangle$  is a sequence (finite or infinite) of distinct complex numbers with no accumulation point, while*

$n_k$  are positive integers. Then there exists an entire function that has zeros of order  $n_k$  at  $a_k$ , and no other zeros. (This function can be expressed as a product.)

**The Mittag-Leffler Theorem** Suppose  $\langle a_k \rangle$  is a sequence (finite or infinite) of distinct complex numbers with no accumulation point, while  $P_k(t)$  are nonzero polynomials without constant term. Then there exists a meromorphic function on  $\mathbb{C}$  whose poles occur exactly at the points  $a_k$  with the principal part at  $a_k$  being  $P_k(1/(z - a_k))$ .

The principal part at a pole is that part of the Laurent series having negative exponents.

Now a few things can be said about  $\mathcal{E}$  on more basic grounds. For example,  $\mathcal{E}$  is an integral domain, since if  $f$  and  $g$  are not identically zero, then they have a discrete set of zeros whose union can't be  $\mathbb{C}$ , that is,  $fg$  is not identically zero. Furthermore, divisibility is checked using an easy criterion:  $g|f$  iff  $f/g$  has only removable singularities, that is, every zero of  $g$  (of order  $n$ ) is a zero of  $f$  (of order  $\geq n$ ). Here,  $f$  and  $g$  are nonzero, by which we mean "not identically zero." Since this kind of thing can actually be arranged using the Weierstrass product theorem, we get:

**Proposition B.1**  $\mathcal{E}$  is a GCD domain. In fact, any nonempty set of nonzero entire functions has a GCD.

**Proof:** Let  $S$  be a nonempty set of nonzero entire functions. Set

$$\{a_k\} = \{z \in \mathbb{C} : f(z) = 0 \text{ for all } f \in S\} = \bigcap_{f \in S} f^{-1}(0),$$

a discrete set since  $S \neq \emptyset$ . Set

$$n_k = \min_{f \in S} (\text{order of zero of } f \text{ at } a_k).$$

If  $g \in \mathcal{E}$ , then  $g|f$  for all  $f \in S$  if and only if  $g^{-1}(0) \subset \{a_k\}$ , and each  $a_k$  is a zero of  $g$  of order  $\leq n_k$  (or not a zero at all); so a GCD is a function with a zero at  $a_k$  of order  $n_k$ , produced by the Weierstrass product theorem.  $\square$

By Corollary A.6 every irreducible in  $\mathcal{E}$  is prime. The irreducibles are the functions  $(z - a)$ ,  $a \in \mathbb{C}$  (and their associates). The units are the functions that are never zero. Functions like  $\sin z$  are divisible by infinitely many primes, but no function (except zero) is divisible infinitely often by a single prime. Also, divisibility is completely determined by prime divisors:

*If  $f$  and  $g$  are entire functions, not identically zero, then  $f|g$  if and only if for every prime  $p$  and natural number  $n$ ,  $p^n|f \Rightarrow p^n|g$ .*

This is left to the interested reader; it plays no role here. Also,  $\mathcal{E}$  is integrally closed (as are all GCD domains; see Kaplansky [46, p. 33]). It is easy to show analytically that a meromorphic function that is integral over  $\mathcal{E}$  must be entire.

A good deal more is true of  $\mathcal{E}$ ; this requires the Mittag-Leffler Theorem.

**Proposition B.2 (Helmer)**  *$\mathcal{E}$  is a Bezout domain, that is, every finitely generated ideal in  $\mathcal{E}$  is principal.*

**Proof:** Thanks to Proposition A.9, it suffices to show that if  $f$  and  $g$  are nonzero entire functions with no common zeros (i.e., are relatively prime), then there exist entire functions  $\lambda$  and  $\mu$  for which  $\lambda f + \mu g = 1$ . To this end, let  $\varphi$  be a meromorphic function with poles precisely at the zeros of  $g$  only, with the principal parts of  $\varphi$  at these zeros coinciding with the principal parts of  $(fg)^{-1}$ . Two things now happen.

1. The order of the pole of  $\varphi$  at any zero of  $g$  equals the order of the zero of  $fg$ , which equals the order of the zero of  $g$ , since  $f$  and  $g$  are relatively prime. Hence,  $\varphi g$  extends to an entire function,  $\lambda$ .
2.  $(fg)^{-1} - \varphi$  has only removable singularities at the zeros of  $g$ . But away from the zeros of  $f$  and  $g$ :

$$\left(\frac{1}{fg} - \varphi\right) f = \frac{1}{g} - \varphi f.$$

The expression on the left has removable singularities at the zeros of  $g$ , while the expression on the right is actually analytic at the zeros of  $f$ . Consequently, the expressions have only removable singularities, and extend to an entire function,  $\mu$ .

But now, away from the zeros of  $f$  and  $g$ ,

$$\begin{aligned} \lambda f + \mu g &= \varphi g f + \left(\frac{1}{g} - \varphi f\right) g \\ &= \varphi g f + 1 - \varphi f g = 1, \end{aligned}$$

an identity that persists to all of  $\mathbb{C}$  by continuity. □

**Corollary B.3** *Let  $I$  be any ideal in  $\mathcal{E}$ . Then  $I$  contains the GCD of any two of its elements.*

**Proof:** Read off from Proposition A.7. □

The next subject treats maximal and prime ideals. The following result is one of the purest interplays of analysis with algebra that one could ask for.



**Proposition B.4** *Suppose  $P$  is a prime ideal in  $\mathcal{E}$ . Then  $P$  is maximal if and only if  $P$  contains a function having no multiple zeros.*

**Proof:** First, suppose  $P$  is maximal. Since  $\{0\}$  is not maximal,  $P$  contains an entire function  $f$  which is not identically zero. Let  $\{a_n\}$  denote the zeros of  $f$ , and let  $g$  be an entire function with simple zeros at the points  $a_k$ , constructed using the Weierstrass product theorem. The claim is that  $g \in P$ .

Suppose not; suppose  $g \notin P$ . Then  $g+P$  is invertible in  $\mathcal{E}/P$ , since  $\mathcal{E}/P$  is a field ( $P$  being maximal). That is,  $\exists h \in \mathcal{E}$  such that  $1+P = (g+P) \cdot (h+P)$ , that is,  $1 - gh \in P$ . But at each  $a_k$ ,  $1 - gh$  has the value 1 since  $g(a_k) = 0$ . That is,  $1 - gh$  and  $f$  have no zeros in common. Thus  $1 - gh$  and  $f$  are relatively prime elements of  $P$ , from which  $P$  must contain their GCD, one, by Corollary B.3. This contradicts maximality.

Conversely, suppose  $P$  is a prime ideal that contains a function  $f$  having no multiple zeros. To show that  $P$  is maximal, we verify that  $\mathcal{E}/P$  is a field, that is, that if  $g \notin P$ , then for some  $\lambda \in \mathcal{E}$ ,  $1 - \lambda g \in P$  (so that  $(\lambda + P)(g + P) = 1 + P$ ). To this end, let  $\varphi$  denote a GCD of  $f$  and  $g$ ;  $\varphi$  has simple zeros at the zeros common to both  $f$  and  $g$ . Since  $\varphi$  divides  $g$ ,  $\varphi$  cannot be in  $P$  ( $\varphi \in P \Rightarrow g \in \mathcal{E}\varphi \subset P$ ). Let  $h$  denote an entire function (constructed using Weierstrass' theorem) with simple zeros at exactly the zeros of  $f$  that are *not* zeros of  $g$ ; then  $\varphi h$  is a unit times  $f$ , so that  $\varphi h \in P$ . But  $\varphi \notin P$ , so  $h \in P$ , since  $P$  is prime. But  $g$  and  $h$  are relatively prime, so by Proposition B.2, there exist entire functions  $\lambda$  and  $\mu$  such that  $1 = \lambda g + \mu h$ . But this gives  $1 - \lambda g = \mu h \in P$ .  $\square$

The condition hypothesized in Proposition B.4 is important. There is no standard term, but a nonzero ideal  $I$  in  $\mathcal{E}$  will be called "superradical" if it contains a function having no multiple zeros. The concept will eventually have an algebraic characterization. The terminology is explained by the next proposition.

**Proposition B.5** *Suppose  $I$  is a superradical ideal in  $\mathcal{E}$ . Then  $I$  is radical. Furthermore, if  $f \in I$ , and if  $g$  has the same zeros as  $f$ , then  $g \in I$ .*

**Proof:** The second part is best proved first. Suppose  $f \in I$ , and suppose  $g$  has the same zeros as  $f$ . Let  $h$  be a function in  $I$  having no multiple zeros. Let  $\varphi$  be a GCD for  $f$  and  $h$ ; then  $\varphi \in I$  by Corollary B.3. Since  $h$  has no multiple zeros, all zeros of  $\varphi$  are simple. Furthermore, all zeros of  $\varphi$  are zeros of  $f$ , hence of  $g$ . Combining,  $\varphi|g$  so that  $g \in \mathcal{E}\varphi \subset I$ .

Now for the radical part. Suppose  $f^n \in I$ . Since  $f$  and  $f^n$  have the same zeros, the part that was just proved shows that  $f \in I$ .  $\square$

If  $I$  is any nonzero ideal in  $\mathcal{E}$ , choose any nonzero  $f \in I$ , and let  $f_0$  denote any entire function having the same zeros as  $f$ , but all with multiplicity

one. Set

$$S(I) = I + \mathcal{E} \cdot f_0.$$

**Proposition B.6** *The preceding definition of  $S(I)$  is independent of the choice of  $f$ , and is the smallest superradical ideal containing  $I$ .*

**Proof:** Clearly  $S(I)$  is superradical since  $f_0 \in S(I)$ . Furthermore, since the starting  $f$  was in  $I$ , any superradical ideal containing  $I$  must also contain  $f_0$  by Proposition B.5. But *that* just means that  $S(I)$  is the smallest superradical ideal containing  $I$ , a concept which is uniquely determined.  $\square$

To go on, we need to introduce filters. A *filter*  $\mathbb{F}$  on a set  $S$  is a collection of subsets of  $S$  subject to:

- a) If  $A \in \mathbb{F}$ , and  $A \subset B \subset S$ , then  $B \in \mathbb{F}$ .
- b) If  $A, B \in \mathbb{F}$ , then  $A \cap B \in \mathbb{F}$ .
- c)  $\emptyset \notin \mathbb{F}$ .

If  $\mathbb{F}$  is a filter on  $S$ , then  $\mathbb{F}$  is an *ultrafilter* if  $\forall A \subset S$ , either  $A \in \mathbb{F}$  or  $S - A \in \mathbb{F}$ . Any filter is contained in an ultrafilter, thanks to the following considerations. Set  $E(\mathbb{F}) = \{B \subset S : B \cap A \neq \emptyset \text{ for all } A \in \mathbb{F}\}$ .

1.  $\mathbb{F} \subset E(\mathbb{F})$ , by property (b).
2. If  $B \notin E(\mathbb{F})$ , then  $\exists A \in \mathbb{F}$  for which  $A \cap B = \emptyset$ , that is,  $A \subset S - B$  so that  $S - B \in \mathbb{F}$ .
3. If  $B \in E(\mathbb{F})$ , then

$$\mathbb{F}' = \{C : C \supset A \cap B \text{ for some } A \in \mathbb{F}\}$$

is a (possibly larger) filter ((a) and (c) are direct, and (b) is easy) such that  $\mathbb{F} \subset \mathbb{F}'$  and  $B \in \mathbb{F}'$ .

4. The union of a nonempty chain (under set inclusion) of filters is a filter (again (a) and (c) are direct, and (b) is easy), so by Zorn's lemma any filter is contained in a maximal filter.
5. If  $\mathbb{F}_u$  is a maximal filter, then  $\mathbb{F}_u$  is an ultrafilter, since  $\mathbb{F}_u$  cannot be extended by the procedure described in (3) above: Necessarily  $E(\mathbb{F}_u) = \mathbb{F}_u$ ; but now (2) above says that  $\mathbb{F}_u$  is an ultrafilter.
6. Combining (4) and (5), every filter is contained in an ultrafilter. There's more: If  $C \notin \mathbb{F}$ , then by (2) applied to  $B = S - C$  we get that  $S - C \in E(\mathbb{F})$ , so that by (3) there is a filter  $\mathbb{F}' \supset \mathbb{F}$  with  $S - C \in \mathbb{F}'$ . But now  $\mathbb{F}'$  is contained in an ultrafilter  $\mathbb{F}_u$ , and we have that  $\mathbb{F} \subset \mathbb{F}_u$  and  $S - C \in \mathbb{F}_u$ , so that  $C \notin \mathbb{F}_u$ . Since  $C \notin \mathbb{F}$  was arbitrary, it follows that:

7.  $\mathbb{F}$  is the intersection of the ultrafilters which contain it, that is,

$$\mathbb{F} = \bigcap_{\substack{\mathbb{F}_u \text{ is an} \\ \text{ultrafilter} \\ \text{and } \mathbb{F} \subset \mathbb{F}_u}} \mathbb{F}_u$$

An ultrafilter  $\mathbb{F}$  is *principal* if  $\mathbb{F}$  contains a set  $\{a\}$ , in which case for all  $A \subset S$ :  $A \in \mathbb{F}$  if and only if  $a \in A$ . An ultrafilter is principal whenever it contains a finite set, as is easy to see by asking what a smallest member of an ultrafilter could look like.

The prototype of a filter is the set of (not necessarily open) neighborhoods of a point in a topological space. This will help us later. For now, suppose  $I$  is any nonzero ideal in  $\mathcal{E}$ . Set

$$\mathcal{F}(I) = \{A \subset \mathbb{C} : \exists f \in I \text{ with } f^{-1}(0) \subset A\}.$$

Our first point is that  $\mathcal{F}(I)$  is a filter on  $\mathbb{C}$ . In fact, it is an “admissible” filter on  $\mathbb{C}$ , that is, a filter on  $\mathbb{C}$  that contains a (necessarily countable) discrete set (thanks to the fact that  $I \neq 0$ ). To see this, run through the conditions:

- a) If  $A \in \mathcal{F}(I)$ , say  $A \supset f^{-1}(0)$ ; and if  $A \subset B \subset \mathbb{C}$ , then  $B \supset f^{-1}(0)$ .
- b) If  $A, B \in \mathcal{F}(I)$ , say  $A \supset f^{-1}(0)$  and  $B \supset g^{-1}(0)$ , with  $f, g \in I$ : Let  $h$  be a GCD of  $f$  and  $g$ ; then  $h^{-1}(0) = f^{-1}(0) \cap g^{-1}(0) \subset A \cap B$ , and  $h \in I$  by Corollary B.3.
- c)  $\emptyset \notin \mathcal{F}$ , since  $f^{-1}(0) \neq \emptyset$  for all  $f \in I$ . ( $I$  cannot contain a unit, and  $f^{-1}(0) = \emptyset \Leftrightarrow f$  is a unit.)

Conversely, if  $\mathbb{F}$  is an admissible filter on  $\mathbb{C}$ , set

$$\mathcal{I}(\mathbb{F}) = \{f \in \mathcal{E} : f^{-1}(0) \in \mathbb{F}\}.$$

Then  $\mathcal{I}(\mathbb{F})$  is a superradical ideal. To see this, observe the following:

- a) If  $f, g \in \mathcal{I}(\mathbb{F})$ , then  $(f + g)^{-1}(0) \supset f^{-1}(0) \cap g^{-1}(0) \in \mathbb{F}$ , so  $(f + g)^{-1}(0) \in \mathbb{F}$ .
- b) If  $f \in \mathcal{I}(\mathbb{F})$  and  $g \in \mathcal{E}$ , then  $(fg)^{-1}(0) \supset f^{-1}(0) \in \mathbb{F}$ , so  $(fg)^{-1}(0) \in \mathbb{F}$ .
- c)  $1 \notin \mathcal{I}(\mathbb{F})$ , since  $\emptyset \notin \mathbb{F}$ .
- d) If  $D \in \mathbb{F}$ , with  $D$  countable and discrete, then there is an entire function  $f$  with simple zeros at the points of  $D$ . Since  $f \in \mathcal{I}(\mathbb{F})$ ,  $\mathcal{I}(\mathbb{F})$  is superradical.

Some things are more or less obvious. First of all, if  $I$  is a nonzero ideal, and  $f \in I$ , then  $f^{-1}(0) \in \mathcal{F}(I)$ , from which  $f \in \mathcal{I}(\mathcal{F}(I))$ . That is,  $I \subset \mathcal{I}(\mathcal{F}(I))$ . Furthermore, if  $I \subset J$ , then  $\mathcal{F}(I) \subset \mathcal{F}(J)$ .

This looks a little like algebraic geometry. How about filters? Suppose  $\mathbb{F}$  is an admissible filter with  $D$  being a countable discrete member. If  $A \in \mathbb{F}$ , then there is an entire function  $f$  whose zero set is precisely  $A \cap D$ , from which  $f \in \mathcal{I}(\mathbb{F})$ . But  $f^{-1}(0) = A \cap D \subset A$  gives that  $A \in \mathcal{F}(\mathcal{I}(\mathbb{F}))$ . That is,  $\mathbb{F} \subset \mathcal{F}(\mathcal{I}(\mathbb{F}))$ . On the other hand, if  $A \in \mathcal{F}(\mathcal{I}(\mathbb{F}))$ , say  $A \supset f^{-1}(0)$ , with  $f \in \mathcal{I}(\mathbb{F})$ , then by definition  $f^{-1}(0) \in \mathbb{F}$ , so that  $A \in \mathbb{F}$ . That is, combining,  $\mathbb{F} = \mathcal{F}(\mathcal{I}(\mathbb{F}))$ . Furthermore (again more or less obviously)  $\mathbb{F} \subset \mathbb{F}' \Rightarrow \mathcal{I}(\mathbb{F}) \subset \mathcal{I}(\mathbb{F}')$ ; observe that  $\mathbb{F} \subset \mathbb{F}'$  means that  $\mathbb{F}'$  contains smaller sets than  $\mathbb{F}$  does.

This looks a *lot* like algebraic geometry.

**Proposition B.7 (Nullstellensatz)** *For any nonzero ideal  $I$  in  $\mathcal{E}$ ,  $\mathcal{I}(\mathcal{F}(I)) = S(I)$ .*

**Proof:** First of all,  $\mathcal{I}(\mathcal{F}(I))$  is a superradical ideal containing  $I$ , so  $\mathcal{I}(\mathcal{F}(I)) \supset S(I)$ . On the other hand, suppose  $f \in \mathcal{I}(\mathcal{F}(I))$ . Then  $f^{-1}(0) \in \mathcal{F}(I)$ , so there is a  $g \in I$  with  $f^{-1}(0) \supset g^{-1}(0)$ . Let  $g_0$  be an entire function with simple zeros at the points of  $g^{-1}(0)$ ; then  $g_0 \in S(I)$ . But  $g_0 | f$ , so  $f \in \mathcal{E}g_0 \subset S(I)$ .  $\square$

**Corollary B.8**  *$\mathcal{F}$  and  $\mathcal{I}$  set up an order-preserving one-to-one correspondence between admissible filters on  $\mathbb{C}$  and superradical ideals in  $\mathcal{E}$ .*

How about maximal ideals?

**Proposition B.9** *If  $\mathbb{F}$  is an admissible ultrafilter, then  $\mathcal{I}(\mathbb{F})$  is a maximal ideal. If  $P$  is a nonzero prime ideal, then  $\mathcal{F}(P)$  is an ultrafilter.*

**Proof:** Suppose  $\mathbb{F}$  is an admissible ultrafilter with  $D$  being a countable discrete member of  $\mathbb{F}$ . Suppose  $f \notin \mathcal{I}(\mathbb{F})$ . Then  $f^{-1}(0) \notin \mathbb{F}$ , so  $\mathbb{C} - f^{-1}(0) \in \mathbb{F}$ , since  $\mathbb{F}$  is an ultrafilter, giving  $D - f^{-1}(0) = D \cap (\mathbb{C} - f^{-1}(0)) \in \mathbb{F}$ . Let  $g$  be an entire function with zero set  $D - f^{-1}(0)$ ; then  $g \in \mathcal{I}(\mathbb{F})$ . Furthermore,  $g$  and  $f$  are relatively prime, so there exist entire functions  $\lambda$  and  $\mu$  for which  $\lambda f + \mu g = 1$ , giving  $1 - \lambda f = \mu g \in \mathcal{I}(\mathbb{F})$ . Thus,  $\mathcal{E}/\mathcal{I}(\mathbb{F})$  is a field, and  $\mathcal{I}(\mathbb{F})$  is maximal.

Now suppose  $P$  is a nonzero prime ideal, and suppose  $A \notin \mathcal{F}(P)$ . Let  $f$  be a nonzero entire function in  $P$ , and let  $g$  have zeros at  $f^{-1}(0) \cap A$  with multiplicity the same as  $f$ , and let  $h$  have zeros at  $f^{-1}(0) - A$  with multiplicity the same as  $f$ . Then  $gh$  is a unit times  $f$ , so  $gh \in P$ . Now  $g^{-1}(0) = f^{-1}(0) \cap A \notin \mathcal{F}(P)$ , since  $A \notin \mathcal{F}(P)$ . ( $A \supset f^{-1}(0) \cap A \in \mathcal{F}(P) \Rightarrow A \in \mathcal{F}(P)$ .) Hence,  $g \notin P$ . Since  $P$  is prime, it follows that  $h \in P$ , so  $f^{-1}(0) - A =$



$h^{-1}(0) \in \mathcal{F}(P)$ . Since  $\mathbb{C} - A \supset f^{-1}(0) - A$ , it follows that  $\mathbb{C} - A \in \mathcal{F}(P)$ .  $\square$

There are three corollaries.

**Corollary B.10 (Henriksen)** *Under the correspondence between admissible filters on  $\mathbb{C}$  and superradical ideals, maximal ideals correspond to ultrafilters. Principal maximal ideals correspond to principal ultrafilters.*

The next corollary gives an algebraic characterization of  $S(I)$ .

**Corollary B.11** *If  $I$  is a nonzero ideal in  $\mathcal{E}$ , then  $S(I)/I$  is the Jacobson radical of  $\mathcal{E}/I$ .*

**Proof:** The Jacobson radical of  $\mathcal{E}/I$  is the intersection of the maximal ideals in  $\mathcal{E}/I$ ; see Section 9.6. But the maximal ideals of  $\mathcal{E}/I$  are the ideals  $M/I$ , where  $M$  is a maximal ideal containing  $I$ , thanks to the Noether correspondence for ideals. It therefore suffices to show that  $S(I)$  is the intersection of the maximal ideals containing  $I$ . That is, we must show that  $I \subset M \Rightarrow S(I) \subset M$  whenever  $M$  is a maximal ideal, and  $f \notin S(I) \Rightarrow \exists M$  maximal such that  $I \subset M$ , but  $f \notin M$ .

Suppose  $M$  is a maximal ideal and  $I \subset M$ . Then  $\mathcal{F}(I) \subset \mathcal{F}(M)$ , and  $\mathcal{I}(\mathcal{F}(I)) \subset \mathcal{I}(\mathcal{F}(M))$ , that is,  $S(I) \subset S(M)$  by Proposition B.7. But  $S(M) = M$  by Proposition B.4, so  $S(I) \subset M$ .

Suppose  $f \notin S(I)$ . Then  $f \notin \mathcal{I}(\mathcal{F}(I))$  by Proposition B.7, so  $f^{-1}(0) \notin \mathcal{F}(I)$  by definition of  $\mathcal{I}(\bullet)$ . By item (6) on the list in the earlier discussion of ultrafilters, there exists an ultrafilter  $\mathbb{F}_u$  such that  $\mathbb{F}_u \supset \mathcal{F}(I)$  and  $f^{-1}(0) \notin \mathbb{F}_u$ . But now  $f \notin \mathcal{I}(\mathbb{F}_u)$ , while  $I \subset \mathcal{I}(\mathcal{F}(I)) \subset \mathcal{I}(\mathbb{F}_u)$ . Since  $\mathcal{I}(\mathbb{F}_u)$  is maximal by Proposition B.9, we are done.  $\square$

One more corollary, in which the analogy with algebraic geometry crashes and burns.

**Corollary B.12** *Every nonzero prime ideal in  $\mathcal{E}$  is contained in a unique maximal ideal.*

**Proof:** If  $P$  is nonzero and prime, it is only contained in  $S(P) = \mathcal{I}(\mathcal{F}(P))$ , a maximal ideal by Proposition B.9.  $\square$

In short, despite being an integral domain,  $\mathcal{E}$  behaves more like a ring of continuous functions when it comes to prime ideals; see Gillman and Jerison [22, p. 107].

The above tells us where to look for a prime ideal, but doesn't spell out how to manufacture one that isn't maximal. The next result does.



**Proposition B.13** *Let  $\mathbb{F}$  be an admissible ultrafilter, with  $D$  being a countable discrete member of  $\mathbb{F}$ . Let  $\sigma : D \rightarrow (0, \infty)$  be a function. Set*

$$P_\sigma = \{f \in \mathcal{E} : \exists A \in \mathbb{F}, A \subset D, \text{ and } \exists c > 0, \text{ s.t. } \forall z \in A, \\ f \text{ has a zero at } z \text{ of order } \geq c\sigma(z).\}$$

*Then  $P_\sigma$  is a prime ideal contained in  $\mathcal{I}(\mathbb{F})$ .*

**Proof:** Given  $f \in P_\sigma$ , if  $A$  and  $c$  are as in the definition, then  $f^{-1}(0) \supset A$ , so  $f^{-1}(0) \in \mathbb{F}$  and  $f \in \mathcal{I}(\mathbb{F})$ . That is,  $P_\sigma \subset \mathcal{I}(\mathbb{F})$

Suppose  $f, g \in P_\sigma$ . Suppose  $A, B \in \mathbb{F}$ ,  $A \subset D$ ,  $B \subset D$ , and  $c, d$  are positive such that

$$f \text{ has a zero of order } \geq c\sigma(z) \text{ at all } z \in A,$$

and

$$g \text{ has a zero of order } \geq d\sigma(z) \text{ at all } z \in B.$$

Then  $f + g$  has a zero of order  $\geq \min(c, d) \cdot \sigma(z)$  at all  $z \in A \cap B$ , so  $f + g \in P_\sigma$ . Furthermore, if  $h \in \mathcal{E}$ , then  $hf$  has a zero of order  $\geq c\sigma(z)$  at all  $z \in A$ , so  $hf \in P_\sigma$ . It follows that  $P_\sigma$  is an ideal.

Suppose  $fg \in P_\sigma$ , and  $A \in \mathbb{F}$ ,  $A \subset D$ , and  $c > 0$  satisfy

$$fg \text{ has a zero of order } \geq c\sigma(z) \text{ at each } z \in A.$$

Set

$$B = \{z \in A : \text{the order of the zero of } f \text{ at } z \\ \text{is } \geq \text{the order of the zero of } g \text{ at } z.\}$$

(The order of a zero of  $f$  at  $z$  is 0 if  $f(z) \neq 0$ .) Since  $\mathbb{F}$  is an ultrafilter, either  $B \in \mathbb{F}$  or  $\mathbb{C} - B \in \mathbb{F}$ . In the latter case,  $A \cap (\mathbb{C} - B) = A - B \in \mathbb{F}$ .

Suppose  $B \in \mathbb{F}$ . Then for any  $z \in B$ , the order of the zero of  $fg$  at  $z$  is equal to the sum of the orders of the zeros of  $f$  and  $g$ , which is  $\leq$  twice the order of the zero of  $f$  at  $z$  by definition of  $B$ : But now the order of the zero of  $fg$  at  $z$  is  $\geq (c/2)\sigma(z)$ . Thus,  $f \in P_\sigma$ . By a similar argument, if  $A - B \in \mathbb{F}$ , then  $g \in P_\sigma$ . Since one of these must happen,  $P_\sigma$  is prime.  $\square$

**Corollary B.14** *Every nonprincipal maximal ideal in  $\mathcal{E}$  is at the top of a chain of prime ideals in one-to-one order preserving correspondence with the nonpositive real numbers.*

**Proof:** Suppose  $M = \mathcal{I}(\mathbb{F})$  is nonprincipal and maximal, so that  $\mathbb{F}$  is a nonprincipal admissible ultrafilter. Let  $D = \{a_1, a_2, a_3, \dots\}$  be a countable discrete member of  $\mathbb{F}$ . Set  $\sigma_t(a_n) = n^{-t}$ , where  $t \in (-\infty, 0]$ . The chain is  $\{P_{\sigma_t}\}$ . Observe that  $t < s \Rightarrow \sigma_t \geq \sigma_s \Rightarrow P_{\sigma_t} \subset P_{\sigma_s}$ . More: If  $s \leq 0$ ,

let  $f$  have a zero at each  $a_n$  of order  $[n^{-s}]$ , where  $[\bullet]$  is the greatest integer function.  $f \in P_{\sigma_s}$  since  $[n^{-s}] \geq \frac{1}{2}n^{-s}$ . But if  $f \in P_{\sigma_t}$  for  $t < s$ , then  $\exists A \in \mathbb{F}$ ,  $A \subset D$ , and  $c > 0$  such that for all  $a_n \in A$ ,  $[n^{-s}] \geq cn^{-t}$ . Hence,  $n^{-s} \geq [n^{-s}] \geq cn^{-t}$ , so  $n^{t-s} \geq c$ . Since  $t - s < 0$ , this can hold for only finitely many  $n$ , from which  $A$  must be finite. But then  $\mathbb{F}$  would be principal. Hence if  $\mathbb{F}$  is not principal, then the  $\{P_{\sigma_t}\}$  are all distinct.  $\square$

This can be improved upon. Read on.

Once we know that nonprincipal admissible ultrafilters exist (and they do in abundance), then we will know that the Krull dimension (the supremum of the lengths of finite chains of prime ideals) of  $\mathcal{E}$  is infinite. Indeed, its *cardinal* Krull dimension (the cardinal supremum of the cardinality minus one of *all* chains of prime ideals) will at least be a continuum.

Both nonprincipal admissible ultrafilters and noncountably generated ideals can be manufactured using the same device. Let  $D$  be any countably infinite discrete subset of  $\mathbb{C}$ . Let  $*$  denote some point not in  $D$  (e.g.,  $\infty$  on the Riemann sphere), and somehow make  $D \cup \{*\}$  into a Hausdorff topological space in which  $*$  is an accumulation point (e.g. neighborhoods in the Riemann sphere). Define  $\mathbb{F}$  to be the admissible filter consisting of all  $A \subset \mathbb{C}$  such that  $\{*\} \cup (A \cap D)$  is a neighborhood of  $*$ . Since  $*$  is an accumulation point of  $D$ ,  $\mathbb{F}$  is a filter. Furthermore, for all  $p \in D$ ,  $D - \{p\} \in \mathbb{F}$ , so the intersection of the members of  $\mathbb{F}$  is empty. This holds for all larger filters, so any ultrafilter  $\mathbb{F}_u$  containing  $\mathbb{F}$  ( $\mathbb{F}_u$  is still admissible since  $D \in \mathbb{F}_u$ ) will have the same property and hence will not be principal. Such spaces  $D \cup \{*\}$  exist, so nonprincipal maximal ideals exist, and  $\mathcal{E}$  has infinite Krull dimension.

There's more. Suppose  $\mathcal{I}(\mathbb{F})$  is countably generated, with  $\mathbb{F}$  as above. As in Section 4.4,  $\mathcal{I}(\mathbb{F})$  can be generated by a sequence  $f_1, f_2, \dots$ , where  $f_{n+1} | f_n$ , and  $\mathcal{I}(\mathbb{F}) = \bigcup \mathcal{E} \cdot f_n$ . Suppose  $A \in \mathbb{F}$ ,  $A \subset D$ , that is,  $A \cup \{*\}$  is a neighborhood of  $*$ . Let  $g$  be a function whose zeros occur precisely on  $A$ . Then  $g \in \mathcal{I}(\mathbb{F})$ , so  $g \in \mathcal{E} \cdot f_n$  for some  $n$ , and so  $f_n^{-1}(0) \subset g^{-1}(0)$ , that is,  $f_n^{-1}(0) \subset A$ . That is,

$$\{\{*\} \cup f_n^{-1}(0) : n = 1, 2, \dots\}$$

is a base for the neighborhoods of  $\{*\}$ . If no such countable base exists, then  $\mathcal{I}(\mathbb{F})$  will not be countably generated.

An example in which there is no countable base at  $*$  can be constructed as follows. Let  $D = \{a_1, a_2, \dots\}$ , and let  $*$   $\in \beta D - D$ , where  $\beta D$  is the Stone-Ćech compactification of  $D$ . Give  $\{*\} \cup D$  the induced topology as a subspace of  $\beta D$ ;  $*$  is a cluster point of the sequence  $\langle a_n \rangle$ , since  $D$  is dense in  $\beta D$ . However, no subsequence of  $\langle a_n \rangle$  can converge to  $*$ : If  $\langle a_{n_k} \rangle$  is a subsequence of  $\langle a_n \rangle$ , then there is a bounded function  $f$  on  $D$  such that  $f(a_{n_k}) = (-1)^k$ , and  $f$  extends to a continuous function  $F$  on  $\beta D$  by the universal property defining  $\beta D$ . But  $a_{n_k} \rightarrow *$  implies  $F(*) = \lim F(a_{n_k}) = \lim (-1)^k$ , a contradiction. Since no subsequence of  $\langle a_n \rangle$  converges to  $*$

despite the fact that  $*$  is a cluster point of  $\langle a_n \rangle$ , it follows that there is no countable neighborhood base at  $*$ . The earlier construction now produces an ideal in  $\mathcal{E}$  which is not countably generated. By the way, it is an easy topological exercise to show that the filter produced by this example is an ultrafilter. Somewhat deeper is the fact that all admissible ultrafilters arise this way.

Before going on to global dimension, a few words about arbitrary prime ideals. Henriksen [30] has expanded on Proposition B.13 as follows. Fix the situation and notation as in Proposition B.13.

1. Given any two functions  $\sigma, \tau : D \rightarrow (0, \infty)$ , either  $P_\sigma \subset P_\tau$  or  $P_\sigma \supset P_\tau$ , depending on whether

$$\{z \in D : \sigma(z) \geq \tau(z)\}$$

or its complement belongs to  $\mathbb{F}$ . Consequently, the set of all ideals  $\{P_\sigma\}$  is actually totally ordered.

2. Given any nonzero prime ideal  $P \subset \mathcal{I}(\mathbb{F})$ ,  $P$  is the union of those  $P_\sigma$  which it contains. Specifically, if  $f \in P$ , one may define

$$\sigma_f(z) = \max\{1, \text{order of zero of } f \text{ at } z\}$$

on  $D$ ;  $f \in P_{\sigma_f}$  ( $c = 1$  on  $A = D \cap f^{-1}(0)$ ), while  $P_{\sigma_f} \subset P$  by the following reasoning. Fix  $g \in P_{\sigma_f}$ , say  $g$  has a zero of order  $\geq c \sigma_f(z)$  on  $A \subset D$ . Let  $h$  have zeros with orders matching those of  $f$  on  $f^{-1}(0) - A$ .  $h \notin P$  since  $h \notin \mathcal{I}(\mathbb{F})$  ( $h^{-1}(0) = f^{-1}(0) - A \notin \mathbb{F}$  since  $A \in \mathbb{F}$ ). But if  $\frac{1}{n} \leq c$ , then  $hg^n$  is a multiple of  $f$ , so  $hg^n \in \mathcal{E}f \subset P$ . Consequently,  $g \in P$  since  $P$  is prime.

3. Combining (1) and (2), the set of all nonzero prime ideals in  $\mathcal{I}(\mathbb{F})$  is totally ordered, and it corresponds to the set of Dedekind cuts in the set of all  $P_\sigma$ . (Recall that the union or intersection of a nonempty chain of prime ideals is prime.) This set is *large*. In fact:

4. Using an argument of Erdős and Gillman, Henriksen shows that the cardinal Krull dimension of  $\mathcal{E}$  is at least  $2^{\aleph_1}$ .

There remains the question of global dimension. This is a chapter in the relationship between cardinal arithmetic and global dimension. A nice discussion appears in Osofsky [63, pp. 54–70]. The primary result is Auslander's lemma, which relates ordinal arithmetic to projective dimension.

**Proposition B.15** *Suppose  $\alpha$  is an ordinal,  $B$  is a left  $R$ -module, and  $n$  is a nonnegative integer. Suppose that for all  $\beta < \alpha$ , there is a submodule  $B_\beta$  of  $B$  subject to*

$$i) \quad \gamma < \beta \Rightarrow B_\gamma \subset B_\beta$$

$$ii) \quad \bigcup_{\beta < \alpha} B_\beta = B$$

$$iii) \quad \forall \beta < \alpha : \text{P-dim} (B_\beta / \bigcup_{\gamma < \beta} B_\gamma) \leq n.$$



Then  $P\text{-dim } B \leq n$ .

**Proof:** The proof presented here is perhaps not the shortest, but it illuminates most clearly the role of the well-ordering of  $\alpha$ , namely the applicability of transfinite recursion.

Given  $C \in {}_R\mathbf{M}$ , we shall show that  $\text{Ext}^{n+1}(B, C) = 0$ . The first reduction is to take the  $n$ th cokernel  $D$  of an injective resolution of  $C$ . By Proposition 4.2(b),  $\text{Ext}^1(A, D) \approx \text{Ext}^{n+1}(A, C)$  for all  $A \in {}_R\mathbf{M}$ , so it suffices to show that for any  $D \in {}_R\mathbf{M}$ ,

$$(\forall \beta < \alpha : \text{Ext}^1(B_\beta / \bigcup_{\gamma < \beta} B_\gamma, D) = 0) \Rightarrow \text{Ext}^1(B, D) = 0.$$

To this end, imbed  $D$  in an injective  $E$ . Let  $\pi : E \rightarrow E/D$  denote the canonical projection. For any  $A \in {}_R\mathbf{M}$ , the long exact sequence for the second variable in  $\text{Ext}$  gives the exact sequence

$$0 \rightarrow \text{Hom}(A, D) \rightarrow \text{Hom}(A, E) \xrightarrow{\pi_*} \text{Hom}(A, E/D) \rightarrow \text{Ext}^1(A, D) \rightarrow 0,$$

since  $E$  is injective. Hence,  $\text{Ext}^1(A, D) = 0$  if and only if  $\pi_*$  is onto, that is, if and only if any  $f \in \text{Hom}(A, E/D)$  has a lifting  $g \in \text{Hom}(A, E)$  such that  $f = \pi g = \pi_*(g)$ . It therefore suffices to show that this happens when  $A = B$  provided it happens whenever  $A = B_\beta / \bigcup_{\gamma < \beta} B_\gamma$  for all  $\beta$ . Given

$f \in \text{Hom}(B, E/D)$ , a lifting  $g$  will be defined by transfinite recursion as a sequence  $g_\beta$  on  $B_\beta$  such that  $\pi g_\beta = f|_{B_\beta}$ , with  $\gamma < \beta \Rightarrow g_\gamma = g_\beta|_{B_\gamma}$  for consistency. The union of [the graphs of] the  $g_\beta$  will be our desired  $g$ .

Suppose we know all  $g_\gamma$ ,  $\gamma < \beta$ . These define a map  $\tilde{g}_\beta$  on  $\bigcup_{\gamma < \beta} B_\gamma$ , and  $\pi \tilde{g}_\beta$  agrees with  $f$  on  $\bigcup_{\gamma < \beta} B_\gamma$ . Since  $E$  is injective, there is a filler  $\bar{g}_\beta$

$$\begin{array}{ccc} 0 & \longrightarrow & \bigcup_{\gamma < \beta} B_\gamma & \longrightarrow & B_\beta \\ & & \downarrow \tilde{g}_\beta & \nearrow \bar{g}_\beta & \\ & & E & & \end{array}$$

for which it may be that  $f|_{B_\beta} \neq \pi \bar{g}_\beta$ . It nevertheless is the case that  $f|_{B_\beta} - \pi \bar{g}_\beta$  is zero on  $\bigcup_{\gamma < \beta} B_\gamma$ , so it induces a map  $F_\beta \in \text{Hom}(B_\beta / \bigcup_{\gamma < \beta} B_\gamma, E/D)$ ,

and this  $F_\beta$  is a composite  $F_\beta = \pi G_\beta$ , since  $\text{Ext}^1(B_\beta / \bigcup_{\gamma < \beta} B_\gamma, D) = 0$ .

Letting  $\pi_\beta : B_\beta \rightarrow B_\beta / \bigcup_{\gamma < \beta} B_\gamma$  denote the canonical projection, we have the equations

$$f|_{B_\beta} - \pi \bar{g}_\beta = F_\beta \pi_\beta$$

and

$$F_\beta = \pi G_\beta,$$

giving

$$f|_{B_\beta} = \pi \bar{g}_\beta + \pi G_\beta \pi_\beta.$$

Set  $g_\beta = \bar{g}_\beta + G_\beta \pi_\beta$ . Then  $\pi g_\beta = f|_{B_\beta}$ ;  $g_\beta = \bar{g}_\beta = \tilde{g}_\beta$  on  $\bigcup_{\gamma < \beta} B_\gamma$  as required.

Final step: Choose  $g_\beta$  as such an extension (axiom of choice).  $\square$

**Corollary B.16** *Suppose  $B$  is a left  $R$ -module which is generated by  $\aleph_m$  elements, and suppose that any finitely generated submodule of  $B$  has projective dimension  $\leq n$ . Then  $\text{P-dim } B \leq m + n + 1$ .*

**Proof:** Induction on  $m$ .  $m = 0$ : Write  $B = \bigcup_{k=1}^{\infty} B_k$ , where  $B_k$  are finitely generated by the first  $k$  elements in a countable generating set for  $B$ . From the exact sequence  $0 \rightarrow B_k \rightarrow B_{k+1} \rightarrow B_{k+1}/B_k \rightarrow 0$  and part (a) of Corollary 4.3, all  $B_{k+1}/B_k$  have projective dimension  $\leq n + 1$  (and  $B_1$  has projective dimension  $\leq n$ ), so this follows from Proposition B.15 with  $\alpha = \aleph_0$ .

As for  $m \rightarrow m + 1$ , suppose  $B$  is generated by  $\aleph_{m+1}$  elements. Set  $\alpha = \aleph_{m+1}$  and put a set of generators of  $B$  in one-to-one correspondence with  $\alpha$ . Let  $B_\beta$  be the submodule generated by the first  $\beta$  elements. Then for all  $\beta < \alpha$ ,  $|\beta| \leq \aleph_m$ , so by the induction hypothesis all  $B_\beta$  and all  $\bigcup_{\gamma < \beta} B_\gamma$  have projective dimension  $\leq m + n + 1$ . Hence, as above, using Corollary 4.3(a) on  $0 \rightarrow \bigcup_{\gamma < \beta} B_\gamma \rightarrow B_\beta \rightarrow B_\beta / \bigcup_{\gamma < \beta} B_\gamma \rightarrow 0$ , we have  $\text{P-dim } (B_\beta / \bigcup_{\gamma < \beta} B_\gamma) \leq m + n + 2$  for all  $\beta$ . Proposition B.15 then gives  $\text{P-dim } B \leq m + n + 2$ .  $\square$

**Corollary B.17** *Any Bezout domain of cardinality  $\aleph_m$  has global dimension  $\leq m + 2$ .*

**Proof:** By the preceding corollary, any ideal has projective dimension  $\leq m + 1$ , since it is generated by  $\leq \aleph_m$  elements, and since finitely generated submodules are principal ideals, hence are free (and projective:  $n = 0$  in the corollary). The result now follows from Corollary 4.10.  $\square$

**Corollary B.18** *Given the continuum hypothesis,  $\text{LG-dim } \mathcal{E} \leq 3$ .*



**Proof:** It suffices to check that  $|\mathcal{E}|$  is a continuum  $c$ , that is,  $\aleph_1$  in the presence of the continuum hypothesis. But  $|\mathcal{E}| \leq c^\omega$  ( $\omega = \aleph_0$ ), since  $\mathcal{E}$  imbeds in the ring of formal power series  $\mathbb{C}[[x]]$  (Taylor expansions at zero). Hence,  $|\mathcal{E}| \leq (2^\omega)^\omega = 2^{\omega \cdot \omega} = 2^\omega = c$ . But  $\mathbb{C} \subset \mathcal{E}$ , so  $|\mathcal{E}| \geq c$ .  $\square$

Some closing comments. Again, all results in this appendix apply to the ring of holomorphic functions on a region in  $\mathbb{C}$ . The big difference is in the structure of the group of units when the region is not simply connected (e.g. the unit disk minus the Cantor set). In fact, Kaplansky's Understatement [46, p. 72] applies even more:

“This [the ring of entire functions] is a good example to keep in mind if you are looking for a Prüfer domain<sup>5</sup> with unusual properties.”

---

<sup>5</sup>A Prüfer domain is an integral domain in which every nonzero finitely generated ideal is invertible. All Bezout domains are Prüfer domains.

# Appendix C

## The Mitchell–Freyd Theorem and Cheating in Abelian Categories

In working with Abelian categories, the verb “to cheat” has taken on a special meaning. A typical Abelian category isn’t even concrete, but in some circumstances one can play a game of “let’s pretend” and act as if morphisms were functions. There are three varieties of such cheating.

One variety is described in Section 7.4, and involves projectives. It is actually available for pre-Abelian categories, and is suitable for checking things like whether a morphism is monic or epic. It is unsuitable for defining things, although a variant (using quasiprojectives) can do this.

Another is described in, for example, MacLane [52, p. 200], using what he calls *members*. A member of an object  $B$  is a morphism into  $B$ . To keep a lid on things, two morphisms into  $B$ , say  $x \in \text{Hom}(A, B)$  and  $x' \in \text{Hom}(A', B)$ , are declared to be *equivalent* if there exists an object  $\bar{A}$  and epimorphisms  $u \in \text{Hom}(\bar{A}, A)$  and  $u' \in \text{Hom}(\bar{A}, A')$  such that  $xu = x'u'$ . This is an equivalence relation, thanks to the peculiar properties of Abelian categories; Proposition D.6 is the key result for transitivity. As an example of a nontrivial theorem (also based on Proposition D.6): If  $f : A \rightarrow B$  is a morphism in an Abelian category, then  $f$  is epic if and only if for every member  $y$  of  $B$  there exists a member  $x$  of  $A$  such that  $fx$  is equivalent to  $y$ .

This approach has three deficiencies. First, there are limits to the analogy; some things work and some don’t. Second, equivalence classes are typically proper classes, and so cannot belong to any class; this can be avoided by using the language of conglomerate theory (see Section 6.6) or by keeping the idea purely linguistic (as MacLane does). The third problem is that, strictly speaking, members don’t really correspond to elements; they corre-

respond to subobjects instead. For example, in  ${}_R\mathbf{M}$ , every equivalence class contains a unique inclusion  $A \hookrightarrow B$ . In particular, unelementlike properties, such as overlap (intersection of subobjects), raise their ugly heads.

The third method of cheating relies on the Mitchell–Freyd theorem, which goes as follows:

*Every small Abelian category is isomorphic under an exact functor to a full subcategory of  ${}_R\mathbf{M}$  for some ring  $R$ .*

Now most interesting categories are not small. The device for overcoming this is the following:

*If  $\mathbf{A}$  is an Abelian category, and  $S$  is a set of objects in  $\mathbf{A}$ , then  $\mathbf{A}$  has a full, small, exact Abelian subcategory  $\mathbf{A}_0(S)$  such that  $S \subset \text{obj } \mathbf{A}_0(S)$ .*

In this context, “exact” means that kernels and cokernels in  $\mathbf{A}_0(S)$  coincide with kernels and cokernels in  $\mathbf{A}$ , that is, the inclusion  $\mathbf{A}_0(S) \hookrightarrow \mathbf{A}$  is an exact functor. To prove this, if  $S$  is a set of objects in  $\mathbf{A}$ , define  $\Lambda(S)$  by choosing a kernel and cokernel (usual business with the Zermello hierarchy; see, e.g., the choice of projectives in Proposition 7.8) for each morphism between objects of  $S$ , then choosing biproducts of pairs of elements of  $S$ ; the resulting set (axiom of replacement) of objects is  $\Lambda(S)$ . By the way, zero objects arise directly as kernels of identity morphisms.  $\mathbf{A}_0(S) = \bigcup_n \Lambda^n(S)$  does the job (unless  $S = \emptyset$ ; if  $S = \emptyset$ , any singleton {zero object} will serve as  $\mathbf{A}_0(\emptyset)$ ).

Observe that since they are constructed from kernels and cokernels, exactness is preserved:

$$A \xrightarrow{f} B \xrightarrow{g} C$$

is exact if and only if

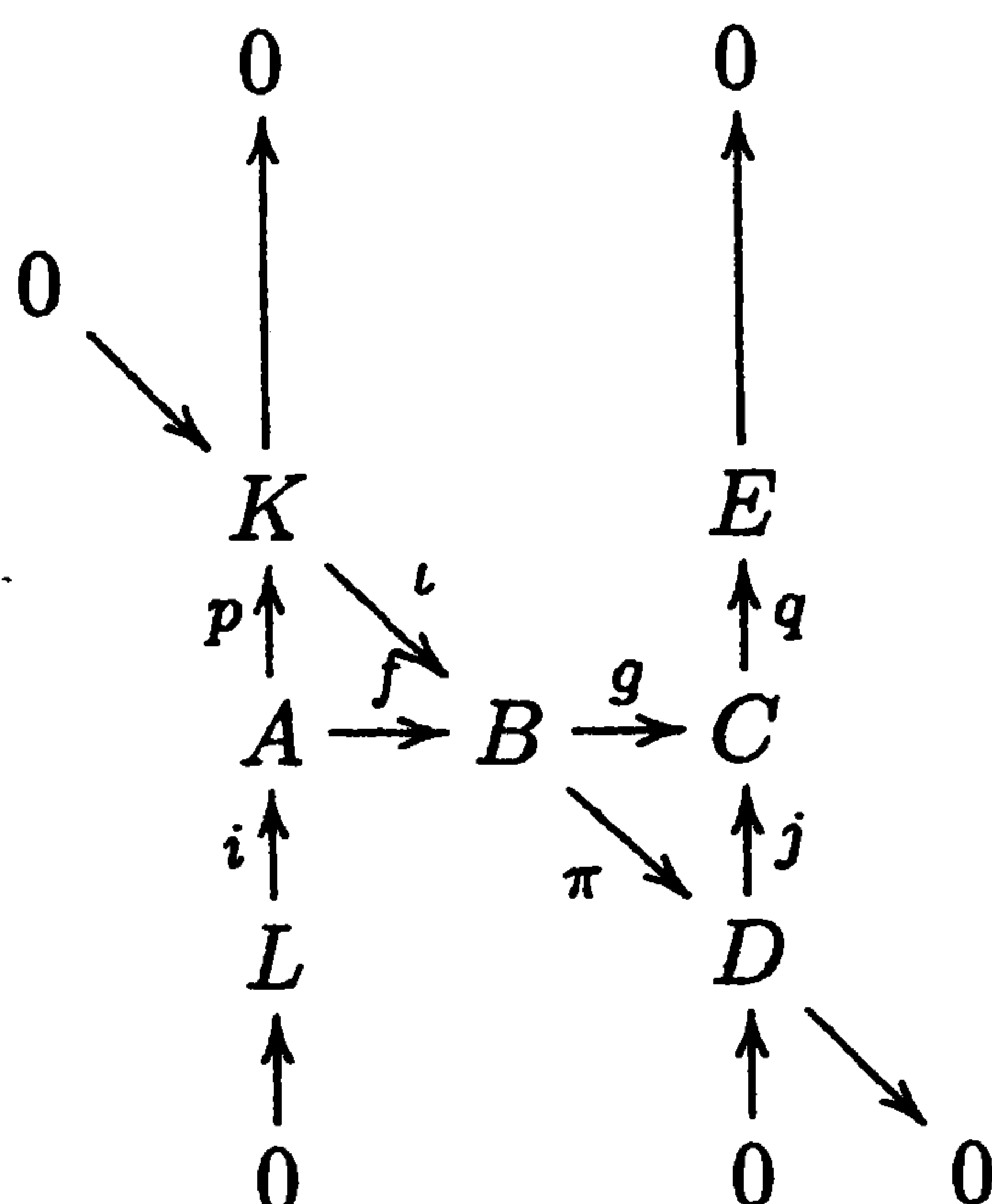

is short exact along the three legs of the capital  $N$ , where  $K = \ker g$ ,  $D = \operatorname{coker} f$ ,  $L = \ker p$ , and  $E = \operatorname{coker} j$ . Consequently, if  $F : \mathbf{A}_0(S) \rightarrow {}_R\mathbf{M}$  is the functor in the Mitchell–Freyd theorem, then

$$A \xrightarrow{f} B \xrightarrow{g} C \text{ is exact in } \mathbf{A}$$

iff

$$A \xrightarrow{f} B \xrightarrow{g} C \text{ is exact in } \mathbf{A}_0(S)$$

iff

$$F(A) \xrightarrow{F(f)} F(B) \xrightarrow{F(g)} F(C) \text{ is exact in } {}_R\mathbf{M}.$$

The last can be checked using elements.

Homology also behaves well, since it, too, is computed via exact sequences (see the diagram accompanying Exercise 9, Chapter 5), so  $F$  sends homology to homology. This all leads to an alternative approach to such things as long exact sequences in homology. However, it is *not* recommended. Abelian categories have their own flavor, and it is a good idea to get used to it as soon as possible. Living only with arrows has its own yoga.





# Appendix D

## Noether Correspondences in Abelian Categories

The Noether isomorphisms and correspondences that are familiar for modules actually hold in any Abelian category. Given the Mitchell–Freyd theorem, this is no surprise. However, they are actually fairly easy to set up, given the material in Chapter 7 together with pullbacks and pushouts from Chapter 8. We describe them here since those chapters are independent. However, this appendix does depend on knowledge of both the material in Chapter 7 and at least the discussion of pullbacks and pushouts from Chapter 8.

Pullbacks will be discussed first, since all but two applications use these. Assume, to begin with, that  $\mathbf{A}$  is a pre-Abelian category, and we have a diagram in  $\mathbf{A}$ :

$$\begin{array}{ccc} & & A_2 \\ & & \downarrow f_2 \\ A_1 & \xrightarrow{f_1} & B \end{array}$$

Let  $(A; \varphi_1, \varphi_2, \pi_1, \pi_2)$  denote a biproduct of  $A_1$  with  $A_2$  in  $\mathbf{A}$ . Let  $j : K \rightarrow A$  denote a kernel for  $f_1\pi_1 - f_2\pi_2$  so that  $(f_1\pi_1 - f_2\pi_2)j = 0$ , or

$f_1\pi_1j = f_2\pi_2j$ . The first claim is that

$$\begin{array}{ccc} K & \xrightarrow{\pi_2j} & A_2 \\ \pi_1j \downarrow & & \downarrow f_2 \\ A_1 & \xrightarrow{f_1} & B \end{array}$$

is a pullback square, which will certainly establish the existence of pullbacks in any pre-Abelian category. Well, the square is commutative, and given any commutative diagram

$$\begin{array}{ccc} & & C \\ & & \swarrow g_1 \\ & & K \xrightarrow{\pi_2j} A_2 \\ & & \downarrow \pi_1j \quad \downarrow f_2 \\ & & A_1 \xrightarrow{f_1} B \\ & & \nwarrow g_2 \\ & & C \end{array}$$

observe that

$$\begin{aligned} & (f_1\pi_1 - f_2\pi_2)(\varphi_1g_1 + \varphi_2g_2) \\ &= f_1\pi_1\varphi_1g_1 + f_1\pi_1\varphi_2g_2 - f_2\pi_2\varphi_1g_1 - f_2\pi_2\varphi_2g_2 \\ &= f_1g_1 + 0 - 0 - f_2g_2 \\ &= 0 \end{aligned}$$

so that  $\varphi_1g_1 + \varphi_2g_2$  factors through  $K$  as  $\varphi_1g_1 + \varphi_2g_2 = j\theta$ . Consider

$$\begin{array}{ccc} & & C \\ & & \swarrow g_1 \\ & & K \xrightarrow{\pi_2j} A_2 \\ & & \downarrow \pi_1j \quad \downarrow f_2 \\ & & A_1 \xrightarrow{f_1} B \\ & & \nwarrow g_2 \\ & & C \end{array}$$

$\theta$  (dashed arrow from  $C$  to  $K$ )

This diagram is commutative, since  $(\pi_2j)\theta = \pi_2(\varphi_1g_1 + \varphi_2g_2) = \pi_2\varphi_1g_1 + \pi_2\varphi_2g_2 = 0 + g_2$ ;  $(\pi_1j)\theta = g_1$  by a similar computation. Also,  $\theta$  is unique with this property, since if  $\pi_1j\theta' = g_1$  and  $\pi_2j\theta' = g_2$ , then

$$\begin{aligned} j\theta' &= (\varphi_1\pi_1 + \varphi_2\pi_2)j\theta' \\ &= \varphi_1\pi_1j\theta' + \varphi_2\pi_2j\theta' \\ &= \varphi_1g_1 + \varphi_2g_2 \\ &= j\theta, \end{aligned}$$



$\theta\rho = f_1\pi_1 + f_2\pi_2$ . This requires a bit of reinterpretation, largely to adjust the signs.

Consider the morphism  $f = f_1\pi_1 + f_2\pi_2 = \theta\rho$  from  $A$  to  $B$ , and the morphism  $\Theta = \varphi_1\pi_1 - \varphi_2\pi_2$  from  $A$  to itself. Observe that

$$\begin{aligned}\Theta^2 &= (\varphi_1\pi_1 - \varphi_2\pi_2)^2 \\ &= \varphi_1\pi_1\varphi_1\pi_1 - \varphi_1\pi_1\varphi_2\pi_2 - \varphi_2\pi_2\varphi_1\pi_1 + \varphi_2\pi_2\varphi_2\pi_2 \\ &= \varphi_1\pi_1 - 0 - 0 + \varphi_2\pi_2 \\ &= i_A\end{aligned}$$

so that  $\Theta$  is an isomorphism, and

$$\begin{aligned}f\Theta &= (f_1\pi_1 + f_2\pi_2)(\varphi_1\pi_1 - \varphi_2\pi_2) \\ &= f_1\pi_1\varphi_1\pi_1 - f_1\pi_1\varphi_2\pi_2 + f_2\pi_2\varphi_1\pi_1 - f_2\pi_2\varphi_2\pi_2 \\ &= f_1\pi_1 - 0 + 0 - f_2\pi_2\end{aligned}$$

so that  $j : K \rightarrow A$  is a kernel for  $f\Theta$ . It follows that  $\Theta j$  is a kernel for  $f$  by invariance of kernels under isomorphisms. (Or use Lemma 7.35:  $j = \Theta\Theta j$  is a kernel for  $f\Theta$ , so  $\Theta j$  is a kernel for  $f\Theta\Theta = f$ .)

Now  $\rho : A \rightarrow D$  is a cokernel for  $\varphi_1g_1 - \varphi_2g_2 = \varphi_1\pi_1j - \varphi_2\pi_2j = \Theta j$ , that is,  $\rho$  is a cokernel for a kernel of  $f$ . There's more:  $\theta\rho = f$ , so  $f = \theta\rho$  is the monic-after-epic factorization of  $f$  (see the proof of Proposition 7.6(b) in  $\mathbf{A}^{\text{op}}$ ). In particular,  $\theta$  is monic.  $\square$

**Corollary D.3** *Suppose that in an Abelian category  $\mathbf{A}$  we have a commutative square*

$$\begin{array}{ccc} K & \xrightarrow{g_2} & A_2 \\ g_1 \downarrow & & \downarrow f_2 \\ A_1 & \xrightarrow{f_1} & B \end{array} \quad (*)$$

*Suppose that  $(*)$  is a pullback square, and  $f_1$  is epic. Then  $(*)$  is also a pushout square.*

**Proof:** Complete the construction in the statement of Proposition D.2, producing  $D$  and  $\theta$ . Since  $f_1 = \theta h_1$  is epic,  $\theta$  is epic. But Proposition D.2 says that  $\theta$  is also monic, so  $\theta$  is an isomorphism since  $\mathbf{A}$  is balanced.  $\square$

**Remark:** By an argument similar to the corollary above, one can show that in an Abelian category, if  $(*)$  is a pullback square, then  $(*)$  is also a pushout square iff  $\forall \alpha : B \rightarrow E : (\alpha f_1 = 0 \text{ and } \alpha f_2 = 0) \Rightarrow \alpha = 0$ .

If one of the morphisms in a pullback is monic, then there is another construction available in an Abelian category  $\mathbf{A}$ . Suppose, for example,  $f_1$  is monic, with cokernel  $\pi$ :

$$\begin{array}{ccccc} & & A_2 & & \\ & & \downarrow f_2 & & \\ A_1 & \xrightarrow{f_1} & B & \xrightarrow{\pi} & C \end{array}$$

Let  $g_2 : K \rightarrow A_2$  denote a kernel for  $\pi f_2$ . Then  $\pi(f_2 g_2) = 0 \Rightarrow f_2 g_2$  factors through  $A_1$ :

$$\begin{array}{ccc} K & \xrightarrow{g_2} & A_2 \\ \downarrow g_1 & & \downarrow f_2 \\ A_1 & \xrightarrow{f_1} & B \xrightarrow{\pi} C \end{array}$$

since  $f_1$  is a kernel for  $\pi$  ( $\mathbf{A}$  being Abelian). The square above is also a pullback square. To see this, given

$$\begin{array}{ccccc} D & & & & \\ & \searrow h_2 & & & \\ & & K & \xrightarrow{g_2} & A_2 \\ & \searrow \theta & \downarrow g_1 & & \downarrow f_2 \\ & & A_1 & \xrightarrow{f_1} & B \xrightarrow{\pi} C \\ & \searrow h_1 & & & \end{array}$$

a filler  $\theta$  exists for which  $g_2 \theta = h_2$ , since  $\pi f_2 h_2 = \pi f_1 h_1 = 0 h_1 = 0$  and  $g_2$  is a kernel for  $\pi f_2$ . This diagram also commutes, since

$$f_1 g_1 \theta = f_2 g_2 \theta = f_2 h_2 = f_1 h_1$$

so that  $g_1 \theta = h_1$ , since  $f_1$  is monic. Finally,  $\theta$  is unique as a filler since if even  $g_2 \theta' = h_2$ , then  $g_2 \theta' = h_2 = g_2 \theta$  so that  $\theta = \theta'$  since  $g_2$  is monic.

The ability to carry out a construction in more than one way is always useful. Here, it shows that if  $f_1$  is monic then so is  $g_2$ , since  $g_2$  is manufactured here as a kernel. This is actually a lot more general.

**Proposition D.4** *Suppose  $\mathbf{A}$  is a pre-Abelian category in which*

$$\begin{array}{ccc} C & \xrightarrow{g_2} & A_2 \\ \downarrow g_1 & & \downarrow f_2 \\ A_1 & \xrightarrow{f_1} & B \end{array}$$



is a pullback square. Suppose  $j : K \rightarrow C$  is a kernel for  $g_2$ . Then  $g_1j : K \rightarrow A_1$  is a kernel for  $f_1$ .

**Proof:** Suppose  $\varphi : D \rightarrow A_1$  satisfies  $f_1\varphi = 0$ . Find a filler  $\theta$  for the commutative diagram

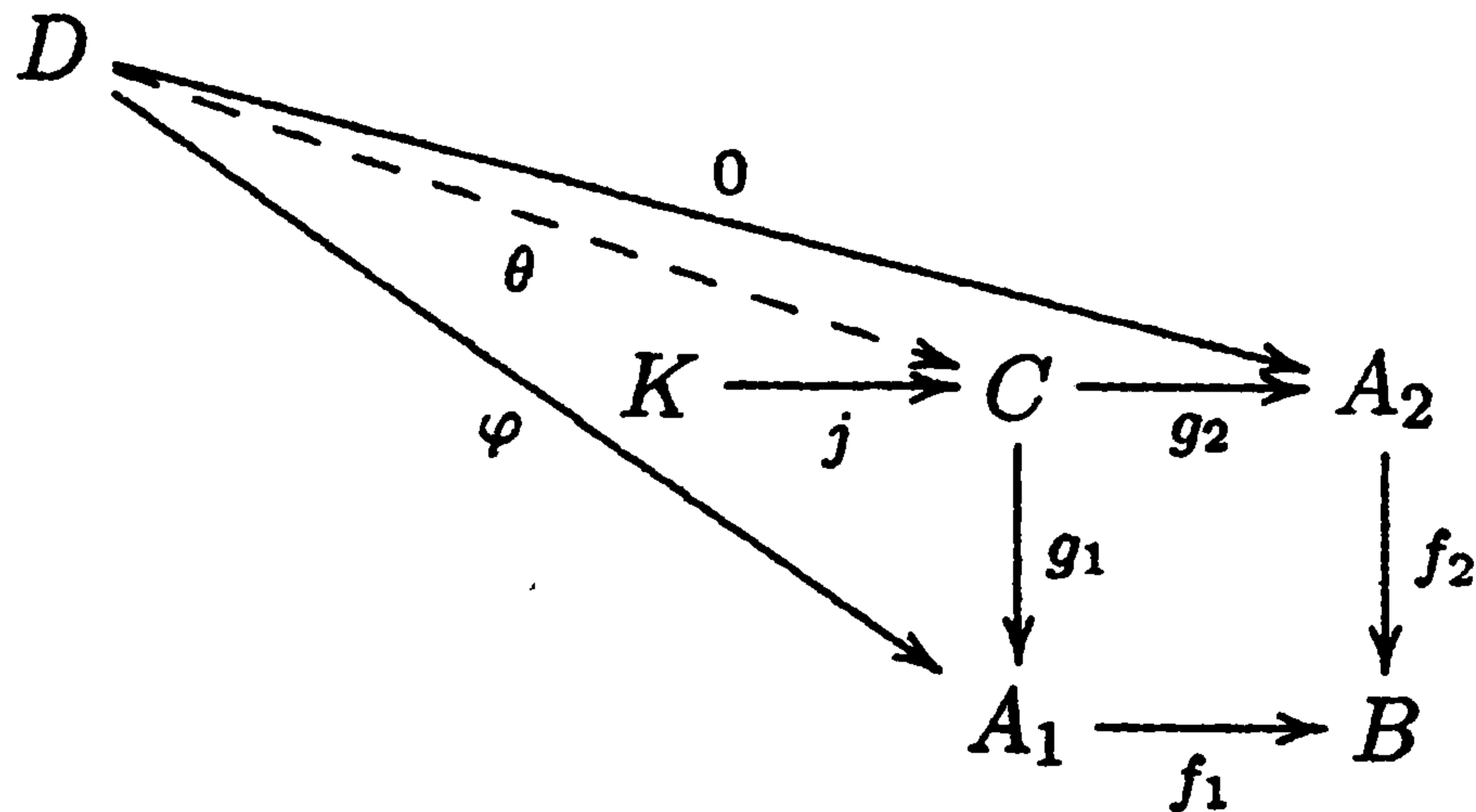

Since  $g_2\theta = 0$ ,  $\theta$  factors through  $K$ , giving  $\theta = j\psi$  where  $\psi : D \rightarrow K$ . But now  $\varphi = g_1\theta = g_1j\psi$ , as required.

This  $\psi$  is unique, since if  $\varphi = g_1j\psi'$ , then the diagram

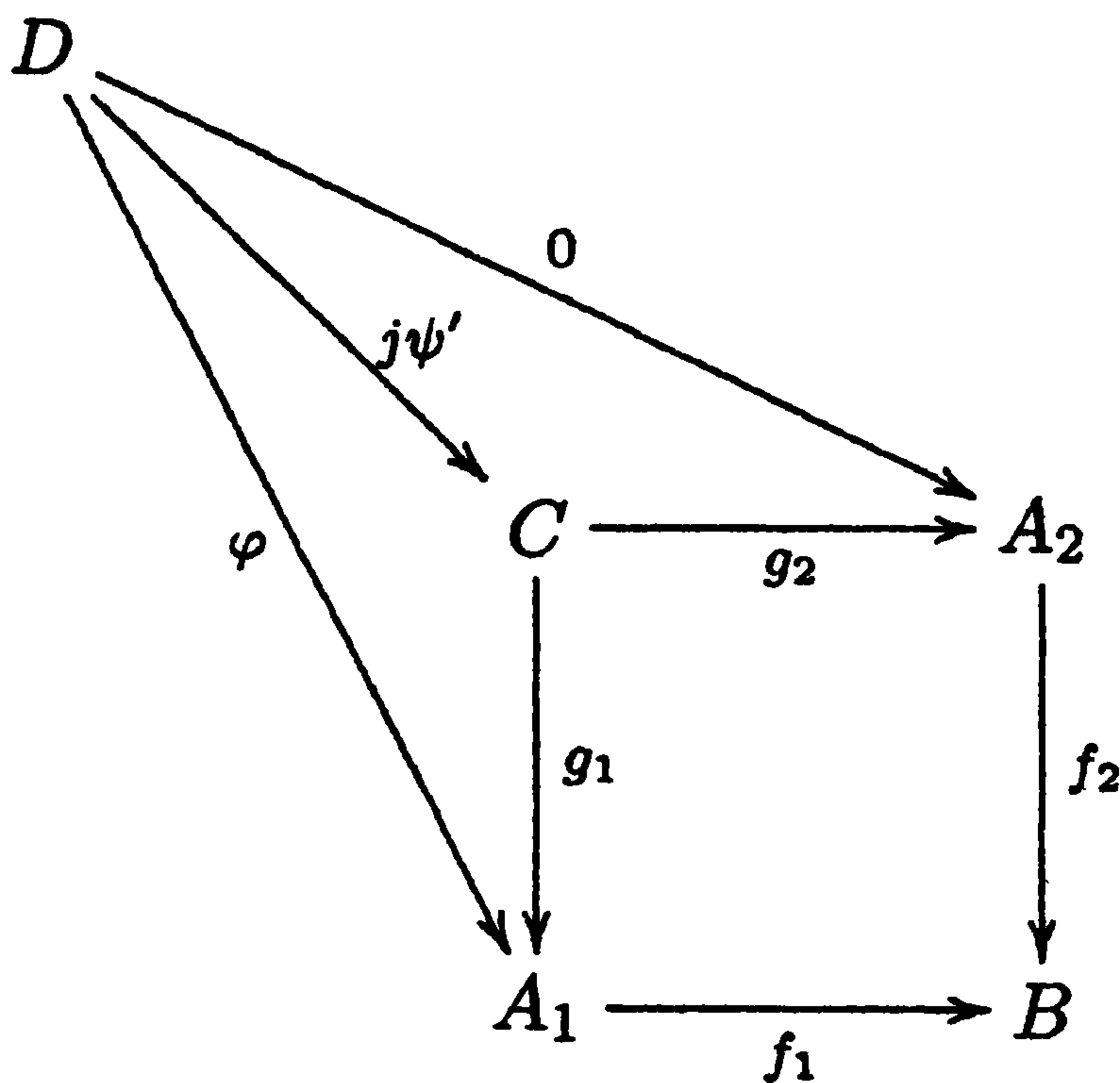

is commutative, so that uniqueness of fillers gives that  $j\psi' = \theta = j\psi$ . But then  $\psi = \psi'$ , since  $j$  is monic.  $\square$

**Corollary D.5** Suppose

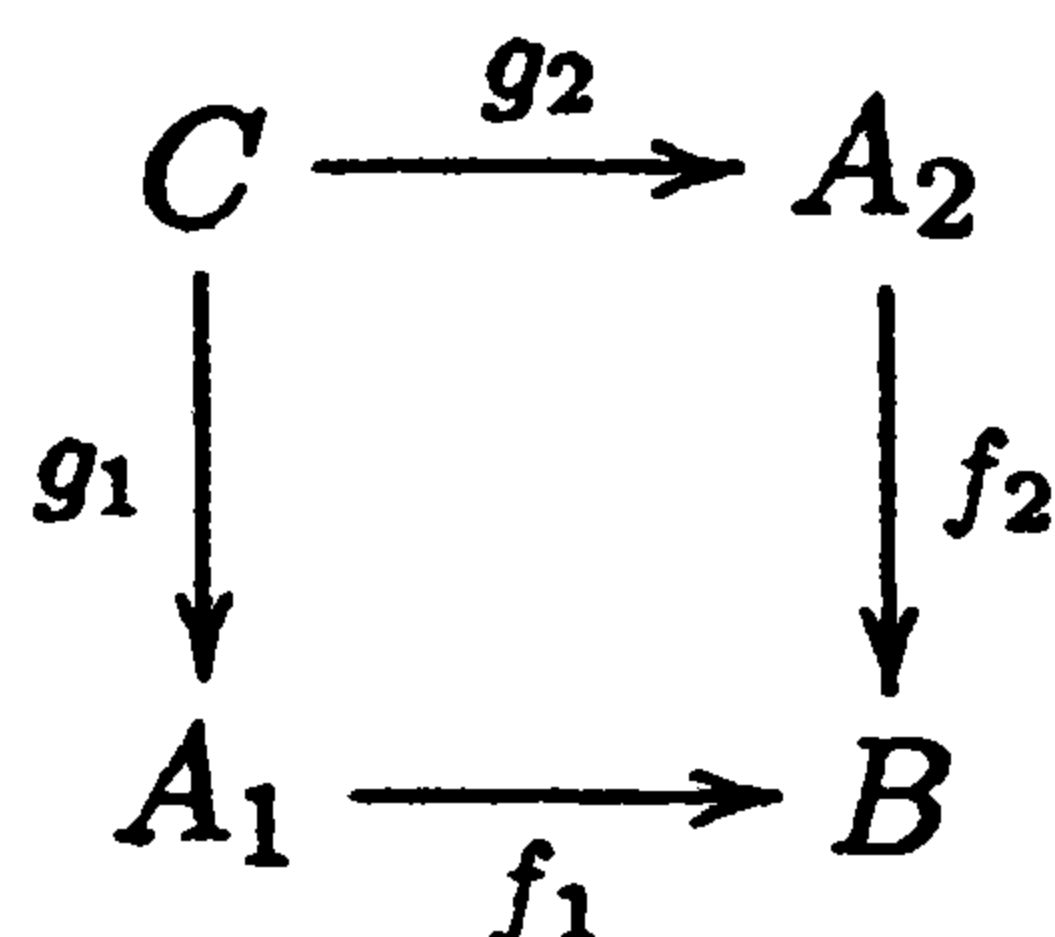

is a pullback square in a pre-Abelian category. Then  $g_2$  is monic if and only if  $f_1$  is monic.

**Proof:** Each happens if and only if the  $K$  in Proposition D.4 is zero.  $\square$

The next result combines several earlier results.

**Proposition D.6** *Suppose  $\mathbf{A}$  is an Abelian category in which*

$$\begin{array}{ccc} C & \xrightarrow{g_2} & A_2 \\ g_1 \downarrow & & \downarrow f_2 \\ A_1 & \xrightarrow{f_1} & B \end{array}$$

*is a pullback square, with  $f_1$  epic. Then  $g_2$  is also epic.*

**Proof:** By Corollary D.3, the above square is also a pushout square. Now use Proposition D.4 in  $\mathbf{A}^{\text{op}}$ : The square becomes a pullback square

$$\begin{array}{ccc} B & \xrightarrow{f_1^{\text{op}}} & A_1 \\ f_2^{\text{op}} \downarrow & & \downarrow g_1^{\text{op}} \\ A_2 & \xrightarrow{g_2^{\text{op}}} & C \end{array}$$

in which  $f_1^{\text{op}}$  is monic in  $\mathbf{A}^{\text{op}}$ . Thus  $g_2^{\text{op}}$  is monic in  $\mathbf{A}^{\text{op}}$  (and  $g_2$  is epic in  $\mathbf{A}$ ) by Corollary D.5.  $\square$

We now have all the machinery we need to derive the Noether isomorphisms and correspondences. They are (stated for left  $R$ -modules):

- I. If  $f : A \rightarrow B$  is onto, then  $B \approx A / \ker f$ .
- II. If  $K$  is a submodule of  $A$ , then the correspondence  $H \mapsto H/K$  sets up a bijection between the submodules of  $A$  containing  $K$  and the submodules of  $A/K$ .
- III. If  $H$  is a submodule of  $A$  and  $K$  is a submodule of  $H$ , then  $A/H \approx (A/K)/(H/K)$ .
- IV. If  $H$  and  $K$  are any two submodules of  $A$ , then  $(H + K)/K \approx H/H \cap K$ .

Exercise 21 of Chapter 7 does part of this; as in that exercise, a subobject is interpreted as a monomorphism. Finishing II is direct. We already have part of this from Proposition 7.37, which says that if

$$\begin{array}{ccccccc} 0 & \longrightarrow & A & \xrightarrow{j} & B & \xrightarrow{\pi} & C \longrightarrow 0 \\ & & \parallel & & \downarrow \psi & & \downarrow \eta \\ 0 & \longrightarrow & A & \xrightarrow{j'} & B' & \xrightarrow{\pi'} & C' \longrightarrow 0 \end{array}$$

is commutative with short exact rows, then  $\psi$  monic  $\Rightarrow \eta$  monic. We also know that  $\eta$  monic  $\Rightarrow \psi$  monic by the short 5-lemma, Proposition 7.34(a). Furthermore,  $\psi$  is uniquely determined by  $\eta$  thanks to Exercise 25, Chapter 7: It says that a cokernel for  $\psi$  is  $p\pi'$ , where  $p$  is a cokernel for  $\eta$ , and this implies that  $\psi$  is a kernel for  $p\pi'$ , since our category is Abelian. So: Given a subobject  $B$  of  $B'$  containing  $A$ , there exists a unique  $C$  (namely a cokernel for  $j$ ) which is a subobject of  $C'$  (replacing  $B'/A$  in the Noether correspondence). The only thing missing is that all subobjects  $\eta : C \rightarrow C'$  arise in this way, but that is exactly what Proposition D.6 produces.  $B$  is defined using

$$\begin{array}{ccc} B & \xrightarrow{\pi} & C \\ \psi \downarrow & & \downarrow \eta \\ B' & \xrightarrow{\pi'} & C' \end{array}$$

as a pullback square. We also have  $A$  as a kernel of  $\pi$  via Proposition D.4.

There remains IV, which requires an interpretation of  $H \cap K$  and  $H + K$ .  $H \cap K$  appears in Exercise 18, Chapter 7; it is defined using the pullback square

$$\begin{array}{ccc} H \cap K & \longrightarrow & H \\ \downarrow & & \downarrow \\ K & \longrightarrow & A \end{array}$$

thanks to the alternative pullback construction for monomorphisms. Observe that  $H \cap K \rightarrow H$  and  $H \cap K \rightarrow K$  are monic (i.e., subobjects) by Corollary D.5 (or directly from Exercise 18, Chapter 7). How about  $H + K$ ? That is more subtle; it is easier to just define  $H + K$  and then explain why it works.

$H + K$  is defined as the lower righthand corner of the pushout square

$$\begin{array}{ccc} H \cap K & \longrightarrow & H \\ \downarrow & & \downarrow \\ K & \longrightarrow & H + K \end{array}$$

Proposition D.2 says that the induced morphism  $H + K \rightarrow A$  is monic, that is,  $H + K$  is a subobject. Furthermore,  $H \rightarrow H + K$  and  $K \rightarrow H + K$  are monic by Proposition D.6 applied to  $\mathbf{A}^{\text{op}}$ . Finally, given any subobject

$L$  containing both  $H$  and  $K$ , we have a diagram

$$\begin{array}{ccccc}
 H \cap K & \longrightarrow & H & & \\
 \downarrow & & \downarrow & \searrow & \\
 K & \longrightarrow & H + K & \xrightarrow{\quad} & L \\
 & \searrow & \dashrightarrow & \swarrow & \\
 & & & & L
 \end{array}$$

which has a filler  $H + K \rightarrow L$ . This filler is monic since the composite  $H + K \rightarrow L \rightarrow A$  is monic. That is,  $H + K$  is a smallest subobject that includes both  $H$  and  $K$ .

How about the Noether isomorphism? That's just Proposition D.4 in  $\mathbf{A}^{\text{op}}$ :

$$\begin{array}{ccccccccc}
 0 & \longrightarrow & H \cap K & \longrightarrow & H & \longrightarrow & D & \longrightarrow & 0 \\
 & & \downarrow & & \downarrow & & \parallel & & \\
 0 & \longrightarrow & K & \longrightarrow & H + K & \longrightarrow & D & \longrightarrow & 0
 \end{array}$$

The top row interprets  $D$  as  $H/H \cap K$ , while the bottom row interprets this same  $D$  as  $(H + K)/K$ .

One last, *last* comment. In deriving IV, no morphisms were given names. This was deliberate. If the argument is basic enough (i.e., no formulas), this can be done routinely. Morphisms really *can* be visualized as arrows.





# Solution Outlines for Selected Exercises

## Chapter 2

1.  $\pi_1$  is defined as in the hint, and  $\pi_2$  is defined analogously. To see that  $\varphi_1\pi_1 + \varphi_2\pi_2$  is the same as  $i_A$ , one shows that both are fillers for

$$\begin{array}{ccccc}
 A_1 & \xrightarrow{\varphi_1} & A & \xleftarrow{\varphi_2} & A_2 \\
 & \searrow \varphi_1 & \vdots & \swarrow \varphi_2 & \\
 & & A & & 
 \end{array}$$

2. Without loss of generality,  $\varphi : A \rightarrow B$  is set inclusion and  $A = \ker \pi$ . One verifies that  $\pi(i_B - \psi\pi) = 0$  so that  $\eta = i_B - \psi\pi$  takes values in  $A$ .  $\eta$  is easily checked to be the identity on  $A$  since  $\pi|_A = 0$ .
3. Let  $\pi_j : \prod B_i \rightarrow B_j$  denote the projection. One has a homomorphism

$$\begin{aligned}
 \Phi : \text{Hom}(A, \prod B_i) &\rightarrow \prod \text{Hom}(A, B_i), \\
 \Phi(f) &= \langle \pi_i f \rangle.
 \end{aligned}$$

However, observe that an  $\mathcal{I}$ -tuple  $\langle f_i \rangle \in \prod \text{Hom}(A, B_i)$  is *precisely* the

data defining a filler

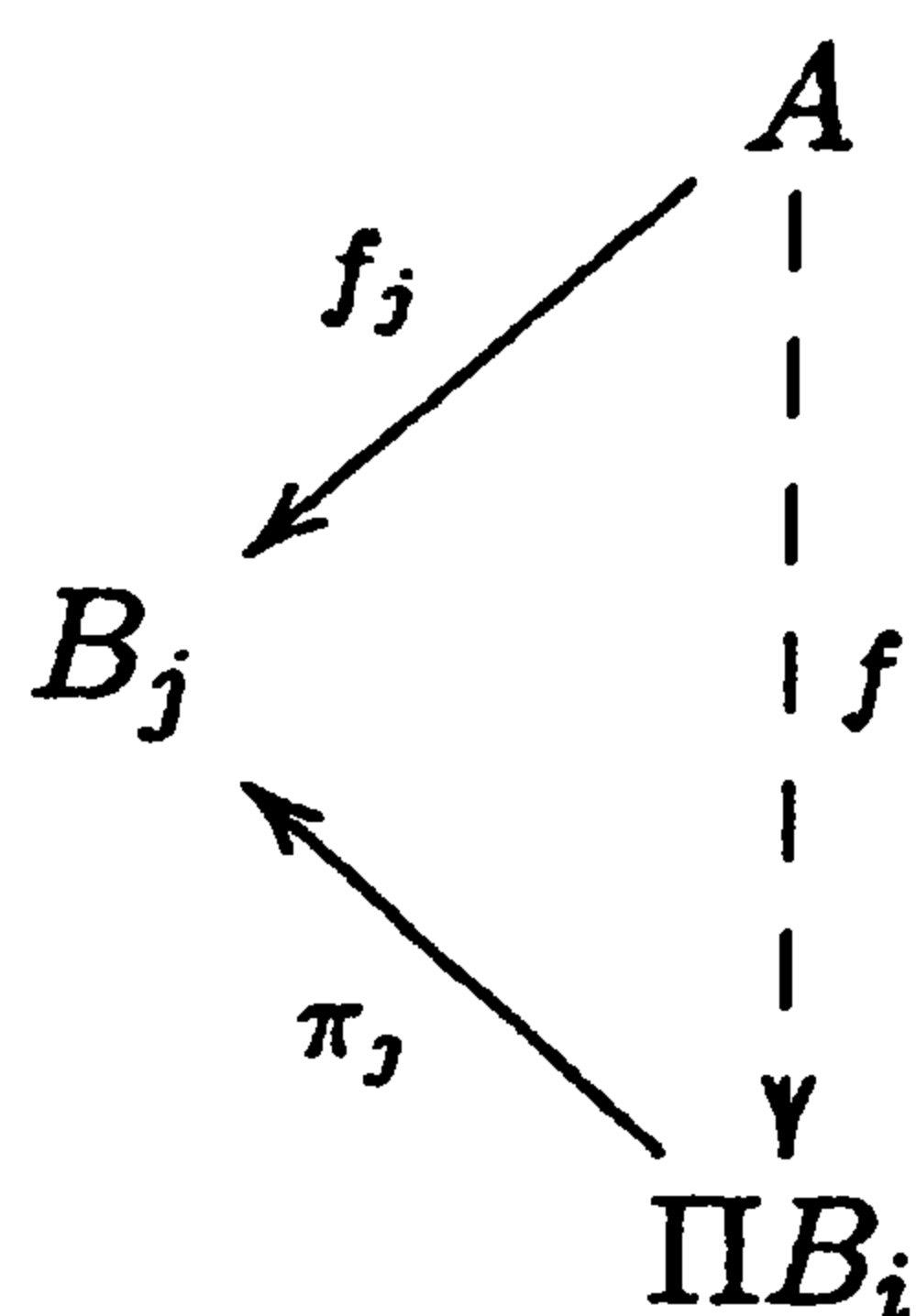

giving  $\Phi(f) = \langle f_i \rangle$ . Existence of fillers gives that  $\Phi$  is onto, and uniqueness of fillers gives that  $\Phi$  is one-to-one.

4. Any  $\sum r_i b_i \in IB$  is the image of  $\sum r_i \otimes b_i$ . If  $0 \neq x \in I \otimes B$  is mapped to zero, write  $x = \sum r_i \otimes b_i$ , and let  $J$  be the right ideal generated by the  $r_i$ . Let  $\bar{x} = \sum r_i \otimes b_i \in J \otimes B$ . (Warning: Even though the sum-and-tensor symbols for  $x$  and  $\bar{x}$  are the same,  $x$  and  $\bar{x}$  are not even in the same space. Furthermore, a different selection of the  $r_i$  and  $b_i$  could yield a different  $\bar{x}$ , but the same  $x$ .) Since  $\bar{x}$  maps to  $x$  in  $I \otimes B$ ,  $\bar{x} \neq 0$ .
5. Let  $K$  denote the kernel of  $B \rightarrow C$  and  $L$  the kernel of  $A \rightarrow B$ . We get the diagram

$$\begin{array}{ccccccc}
 & & L & & & & \\
 & & \downarrow & & & & \\
 & & A & & & & \\
 & & \downarrow & & & & \\
 0 & \longrightarrow & K & \longrightarrow & B & \longrightarrow & C \\
 & & \downarrow & & & & \\
 & & 0 & & & & 
 \end{array}$$

with exact row and column. Applying  $F$  and using its exactness yields the result.

9. Choose  $x \in G$  with prime order  $p$  dividing the order of  $h$ . (The convention here is that all primes divide  $\infty$ .) Define  $\psi(nh) = nx$ , and choose a filler  $\varphi$  for

$$\begin{array}{ccc}
 0 & \longrightarrow & \langle h \rangle \hookrightarrow H \\
 & & \downarrow \psi \quad \swarrow \varphi \\
 & & G
 \end{array}$$

10. Running the proof of Theorem 2.12 backward and using right exactness of  $A \otimes$ , it suffices to show that

$$0 \rightarrow H \rightarrow H' \text{ is exact if } \text{Hom}(H', G) \rightarrow \text{Hom}(H, G) \rightarrow 0 \text{ is exact,}$$

where  $H = A \otimes B$  and  $H' = A \otimes C$ . This is done by contradiction: If  $H \rightarrow H'$  is not one-to-one, choose  $0 \neq h \in \ker(H \rightarrow H')$ , and choose  $\varphi$  in accordance with Exercise 9. This  $\varphi$  cannot be in the image of  $\text{Hom}(H', G) \rightarrow \text{Hom}(H, G)$ .

11. For the difficult half, choose an injective coseparator  $G$ , such as  $\mathbb{Q}/\mathbb{Z}$ , and suppose  $A \otimes I \rightarrow AI$  is one-to-one for any finitely generated left ideal  $I$ . Then by Exercise 4 (reversed) the same holds for *any* left ideal  $I$ . Applying the proof of Theorem 2.12 to the short exact sequence  $0 \rightarrow I \rightarrow R \rightarrow R/I \rightarrow 0$  yields that

$$\text{Hom}_R(R, \text{Hom}_Z(A, G)) \rightarrow \text{Hom}_R(I, \text{Hom}_Z(A, G))$$

is onto. It follows that  $\text{Hom}_Z(A, G)$  is injective (injective test lemma), so that  $A$  is flat (Exercise 10).

13. A trilinear map from  $A \times B \times C$  to  $G \in \mathbf{Ab}$  is such that  $f(a, \bullet, \bullet)$  is  $S$ -bilinear on  $B \times C$  for all  $a \in A$ , and  $f(\bullet, \bullet, c)$  is  $R$ -bilinear on  $A \times B$  for all  $c \in C$ . For example, for the latter,  $f$  defines an  $S$ -module homomorphism from  $C$  to  $\text{Bil}(A, B; G) \approx \text{Hom}_Z(A \otimes_R B, G)$ . Letting  $T(A, B, C; G)$  denote the set of trilinear maps,

$$\begin{aligned} T(A, B, C; G) &\approx \text{Hom}_S(C, \text{Hom}_Z(A \otimes_R B, G)) \\ &\approx \text{Hom}_Z((A \otimes_R B) \otimes_S C, G). \end{aligned}$$

When interpreted properly, this says that  $(A \otimes_R B) \otimes_S C$  is a solution to the universal trilinear mapping problem. Now repeat, with  $a \mapsto f(a, \bullet, \bullet)$  from  $A$  to  $\text{Bil}(B, C; G)$ .

14. (a) If  $\psi(x) = 0$ , then  $0 = \pi' \psi(x) = \phi \pi(x)$ , so  $\pi(x) = 0$  and  $x = j(y)$  for some  $y$ . But  $\psi j(y) = 0$ , so  $j' \eta(y) = 0$  and  $y = 0$ .
- (b)  $\text{im} \psi \supset \text{im} \psi j = \text{im} j' \eta = \text{im} j' = \ker \pi'$ . If  $b' \in B'$ , then, since  $\phi \pi$  is onto,  $\pi'(b') = \phi \pi(b) = \pi' \psi(b)$  for some  $b \in B$ . But now  $b' - \psi(b) \in \ker \pi' \subset \text{im} \psi$ .
15. If  $f \in \text{Bil}(A, B; C)$ , then  $f$  corresponds to  $\bar{f} \in \text{Hom}_Z(A \otimes_R B, C)$  (where  $\bar{f}(a \otimes b) = f(a, b)$ ) and  $g \in \text{Hom}_R(B, \text{Hom}_Z(A, C))$  (where  $[g(b)](a) = f(a, b)$ ). One can check that  $\bar{f} \in \text{Hom}_S(A \otimes_R B, C)$  iff  $f(sa, b) = sf(a, b)$  for all  $s \in S$ ,  $a \in A$ ,  $b \in B$  iff  $g$  takes values in  $\text{Hom}_S(A, C)$ .

Chapter 3

2. One must check that, given  $\varphi : B \rightarrow B'$  and  $\psi : C \rightarrow C'$ , the diagram

$$\begin{array}{ccc}
 \text{Ext}^n(B, C) & \xleftarrow{\text{Ext}^n(\varphi, C)} & \text{Ext}^n(B', C) \\
 \text{Ext}^n(B, \psi) \downarrow & & \downarrow \text{Ext}^n(B', \psi) \\
 \text{Ext}^n(B, C') & \xleftarrow{\text{Ext}^n(\varphi, C')} & \text{Ext}^n(B', C')
 \end{array}$$

commutes. To establish this, take projective resolutions of  $B$  and  $B'$ :

$$\begin{array}{ccccccc}
 \cdots & \longrightarrow & P_2 & \longrightarrow & P_1 & \longrightarrow & P_0 \longrightarrow B \longrightarrow 0 \\
 & & \downarrow & & \downarrow & & \downarrow \\
 \cdots & \longrightarrow & P'_2 & \longrightarrow & P'_1 & \longrightarrow & P'_0 \longrightarrow B' \longrightarrow 0
 \end{array}$$

Delete  $B \rightarrow B'$  and apply  $\text{Hom}(\bullet, C) \rightarrow \text{Hom}(\bullet, C')$ , yielding the commutative diagram

$$\begin{array}{ccccccc}
 \cdots & \longleftarrow & \text{Hom}(P_n, C) & \longleftarrow & \text{Hom}(P_{n-1}, C) & \longleftarrow & \cdots \\
 & & \uparrow & & \uparrow & & \\
 \cdots & \longleftarrow & \text{Hom}(P_n, C') & \longleftarrow & \text{Hom}(P_{n-1}, C') & \longleftarrow & \cdots \\
 & & \downarrow & & \downarrow & & \\
 \cdots & \longleftarrow & \text{Hom}(P'_n, C) & \longleftarrow & \text{Hom}(P'_{n-1}, C) & \longleftarrow & \cdots \\
 & & \uparrow & & \uparrow & & \\
 \cdots & \longleftarrow & \text{Hom}(P'_n, C') & \longleftarrow & \text{Hom}(P'_{n-1}, C') & \longleftarrow & \cdots
 \end{array}$$

Taking homology yields commutativity of

$$\begin{array}{ccc}
 \text{Ext}^n(B, C) & & \\
 \uparrow & \searrow & \\
 \text{Ext}^n(B', C) & & \text{Ext}^n(B, C') \\
 \downarrow & \swarrow & \uparrow \\
 & & \text{Ext}^n(B', C')
 \end{array}$$

3. b)  $F_2 \otimes B \rightarrow F_1 \otimes B \rightarrow K \otimes B \rightarrow 0$  is exact. Let  $I$  denote the image of  $F_2 \otimes B \rightarrow F_1 \otimes B$ ; then  $K \otimes B \approx (F_1 \otimes B)/I$ . From Theorem

3.4(a),  $\text{Tor}_1(A, B)$  is isomorphic to the kernel of  $K \otimes B \rightarrow F_0 \otimes B$ , that is, the kernel of  $F_1 \otimes B/I \rightarrow F_0 \otimes B$ . This kernel is the homology at  $F_1 \otimes B$ .

4.  $\partial_{1,1}y_1 = d_{0,2}(y_2)$  for some  $y_2$ , and  $y_2 = \partial_{1,2}(z_1)$  for some  $z_1$  since  $\partial_{1,2}$  is onto. But now  $\partial_{1,1}(y_1 - d_{1,2}(z_1)) = 0$ , so that  $y_1 - d_{1,2}(z_1) = \partial_{2,1}(z_2)$  for some  $z_2$  by vertical exactness at  $C_{1,1}$ .
6. Suppose  $x_0 = d_{0,n-1}(z_0)$ .  $z_0$  must be extended to  $(z_0, \dots, z_{n-1})$  recursively: If  $x_j = d(z_j) + \partial(z_{j-1})$  (starting with  $z_{-1} = 0$ ) then  $d(x_{j+1} - \partial(z_j)) = 0$ , so  $x_{j+1} - \partial(z_j) = d(z_{j+1})$  for an appropriately chosen  $z_{j+1}$ . To show that  $x_n = \partial(z_{n-1})$  at the end, one checks that  $d_{n,0}(x_n) = d_{n,0}\partial(z_{n-1})$ . ( $d_{n,0}$  is one-to-one.)
7. The argument is a mirror image of Proposition 3.1, with  $\ker d_n$  replacing, for example,  $\text{imd}'_{n+1}$ , and arrows all reversed. For example, if  $x \in E_{n-1}$ , then recursively  $\varphi_n d_{n-1}(x) = d'_{n-1}\varphi_{n-1}(x) \in \text{imd}'_{n-1}$ , so that  $\varphi_n$  sends  $\text{imd}_{n-1}$  to  $\text{imd}'_{n-1}$ .
9. (a) From  $0 \rightarrow I \rightarrow R \rightarrow R/I \rightarrow 0$ , one gets  $\text{Tor}_n(R/J, R/I) \approx \text{Tor}_{n-1}(R/J, I)$  from a long exact sequence. From  $0 \rightarrow J \rightarrow R \rightarrow R/J \rightarrow 0$  one similarly gets  $\text{Tor}_{n-1}(R/J, I) \approx \text{Tor}_{n-2}(J, I)$ .
- (b) The first half of part (a) gives  $\text{Tor}_2(R/J, R/I) \approx \text{Tor}_1(R/J, I)$ , while  $0 \rightarrow J \rightarrow R \rightarrow R/J \rightarrow 0$  gives exactness of

$$0 \rightarrow \text{Tor}_1(R/J, I) \rightarrow J \otimes I \rightarrow R \otimes I.$$

But  $R \otimes I \approx I$ , and  $J \otimes I$  has image  $JI$ .

- (c) From  $0 \rightarrow I \rightarrow R \rightarrow R/I \rightarrow 0$  we get

$$0 \rightarrow \text{Tor}_1(R/J, R/I) \rightarrow (R/J) \otimes I \rightarrow (R/J) \otimes R$$

or

$$0 \rightarrow \text{Tor}_1(R/J, R/I) \rightarrow I/JI \rightarrow R/J.$$

The kernel of  $I/JI \rightarrow R/J$  is  $(J \cap I)/JI$ .

11. For (a), apply  $\text{Hom}(\oplus B_i, \bullet) \approx \prod \text{Hom}(B_i, \bullet)$  to an injective resolution of  $C$ . For (b), apply  $\text{Hom}(\bullet, \prod C_i) \approx \prod \text{Hom}(\bullet, C_i)$  to a projective resolution of  $B$ . For (c), apply  $\bullet \otimes (\oplus B_i) = \oplus(\bullet \otimes B_i)$  to a flat resolution of  $A$ . The latter, for example, yields

$$\begin{array}{ccccccc} \cdots & \longrightarrow & F_{n+1} \otimes (\oplus B_i) & \longrightarrow & F_n \otimes (\oplus B_i) & \longrightarrow & \cdots \\ & & \cong & & \cong & & \\ \cdots & \longrightarrow & \oplus(F_{n+1} \otimes B_i) & \longrightarrow & \oplus(F_n \otimes B_i) & \longrightarrow & \cdots \end{array}$$



and the homology of

$$\oplus A_i \rightarrow \oplus A'_i \rightarrow \oplus A''_i$$

is the direct sum of the homologies of  $A_i \rightarrow A'_i \rightarrow A''_i$ . (The same holds for direct products.)

12. Define  $\pi : B_1 \oplus B_2 \rightarrow B_1 + B_2$  by  $\pi((b_1, b_2)) = b_1 + b_2$ .  $\ker \pi \approx B_1 \cap B_2$  via  $b \mapsto (b, -b)$ . The result follows from Proposition 3.13, with Exercise 11(a) reinterpreting the middle terms.

## Chapter 4

2. If  $\text{P-dim } B > \text{P-dim } B'$ , then for  $n > \text{P-dim } B'$ ,  $\text{Ext}^n(B, C) \rightarrow \text{Ext}^{n+1}(B'', C)$  is an isomorphism for all  $C$ . Taking the supremum, over the  $n$  for which  $\text{Ext}^n(B, C) \neq 0$ , gives  $\text{P-dim } B'' = 1 + \text{P-dim } B$ .
10.  $A, B \cap C \subset (A + B) \cap C$ , so  $A + (B \cap C) \subset (A + B) \cap C$ . If  $a + b \in (A + B) \cap C$ , then  $b \in C$  and  $a + b \in A + (B \cap C)$ .
11. Apply Exercise 11(a) of Chapter 3, and take the supremum over the  $n$  and  $C$  for which either side is nonzero.
14. Apply Proposition 4.2(a) and take the supremum over the  $k > d = 0$  for which  $\text{Ext}^k(D, C) \approx \text{Ext}^{k+n}(D', C) \neq 0$ . This handles the case  $N > n$ ; the case  $N = n$  is covered by the projective dimension theorem.

## Chapter 5

3. (a)  $F(f_{s+t}) = F(f_s + f_t) = F(f_s) + F(f_t)$ , since  $F$  is additive. Hence,  $x(s + t) = xs + xt$ . Similarly,  $x(st) = F(f_{st})(x) = F(f_t)F(f_s)(x) = F(f_t)(xs) = (xs)t$ . Finally,  $(rx)s = F(f_s)(rx) = rF(f_s)(x) = r(xs)$ .
- (b)  $F(S) = A \approx A \otimes_S S$ , and since both sides are strongly additive,  $F(P) \approx A \otimes P$  for any free  $P$ . Given any  $B$ , choose  $P_1$  and  $P_0$  as part of a free resolution of  $B$ , so that  $P_1 \rightarrow P_0 \rightarrow B \rightarrow 0$  is exact. We have exactness of

$$\begin{array}{ccccccc} F(P_1) & \longrightarrow & F(P_0) & \longrightarrow & F(B) & \longrightarrow & 0 \\ & & \cong & & \cong & & \\ A \otimes_S P_1 & \longrightarrow & A \otimes_S P_0 & \longrightarrow & A \otimes_S B & \longrightarrow & 0 \end{array}$$

from which the isomorphism  $F(B) \approx A \otimes_S B$  follows. (Commutativity of this diagram must be checked.) Given  $B', \phi \in$

$\text{Hom}(B, B')$ , and  $P'_1 \rightarrow P'_0 \rightarrow B' \rightarrow 0$  part of a free resolution of  $B'$ , we have fillers  $\phi_1$  and  $\phi_0$

$$\begin{array}{ccccccc} P_1 & \longrightarrow & P_0 & \longrightarrow & B & \longrightarrow & 0 \\ | & & | & & \downarrow & & \\ \downarrow \phi_1 & & \downarrow \phi_0 & & \downarrow \phi & & \\ P'_1 & \longrightarrow & P'_0 & \longrightarrow & B' & \longrightarrow & 0 \end{array}$$

from Proposition 3.1, giving

$$\begin{array}{ccccccc} F(P_1) & \longrightarrow & F(P_0) & \longrightarrow & F(B) & \longrightarrow & 0 \\ \downarrow & \searrow \approx & \downarrow & \searrow \approx & \downarrow & \searrow \approx & \\ & A \otimes_S P_1 & \longrightarrow & A \otimes_S P_0 & \longrightarrow & A \otimes_S B & \longrightarrow 0 \\ \downarrow & \downarrow & \downarrow & \downarrow & \downarrow & \downarrow & \\ F(P'_1) & \longrightarrow & F(P'_0) & \longrightarrow & F(B') & \longrightarrow & 0 \\ \downarrow & \searrow \approx & \downarrow & \searrow \approx & \downarrow & \searrow \approx & \\ & A \otimes_S P'_1 & \longrightarrow & A \otimes_S P'_0 & \longrightarrow & A \otimes_S B' & \longrightarrow 0 \end{array}$$

The square containing  $B$  and  $B'$  commutes since the parts containing  $P_1, P'_1, P_0$ , and  $P'_0$  commute. Furthermore, setting  $B = B'$  and  $\phi = i_B$ , the isomorphism of  $F(B)$  with  $A \otimes_S B$  can be seen to be independent of the choice of free resolution. (The considerations are essentially those making Tor and Ext into functors.)

## Chapter 6

1. In the remark, if  $\pi : B \oplus B \rightarrow B$  is one of the projections, then  $i_B = \pi\varphi = 0$ , so  $B = 0$ . Since  $F(\text{zero object})$  has this property,  $F(\text{zero object}) = \text{zero object}$ .
6. Since the map from  $K'_n$  to  $K''_n$  kills  $(d_n(x), 0)$  (it only sees the second coordinate), the resulting diagram is commutative.  $d'_n$  is onto  $K'_n$  by the short 5-lemma.
7. Part (b) is related to part (a) in the same way that Exercise 7 of Chapter 3 is related to Proposition 3.1.
9. (ii)  $\Rightarrow$  (iii): If  $d'_1 = d_1 \oplus d''_1$ , then  $\text{imd}'_1 \approx \text{imd}_1 \oplus \text{imd}''_1$ , and  $P_0 \oplus P''_0 / \text{imd}'_1 \approx (P_0 / \text{imd}_1) \oplus (P''_0 / \text{imd}''_1) \approx B \oplus B''$ .
10.  $\pi\varphi'(0, x'') = \varphi''(x'')$  from the original diagram, while  $\varphi'(x, x'')$  will not agree with  $\varphi(x) = \varphi'(x, 0)$  unless  $\varphi'(0, x'') = 0$ .

Chapter 7

2. If  $O'$  is also a zero object, then

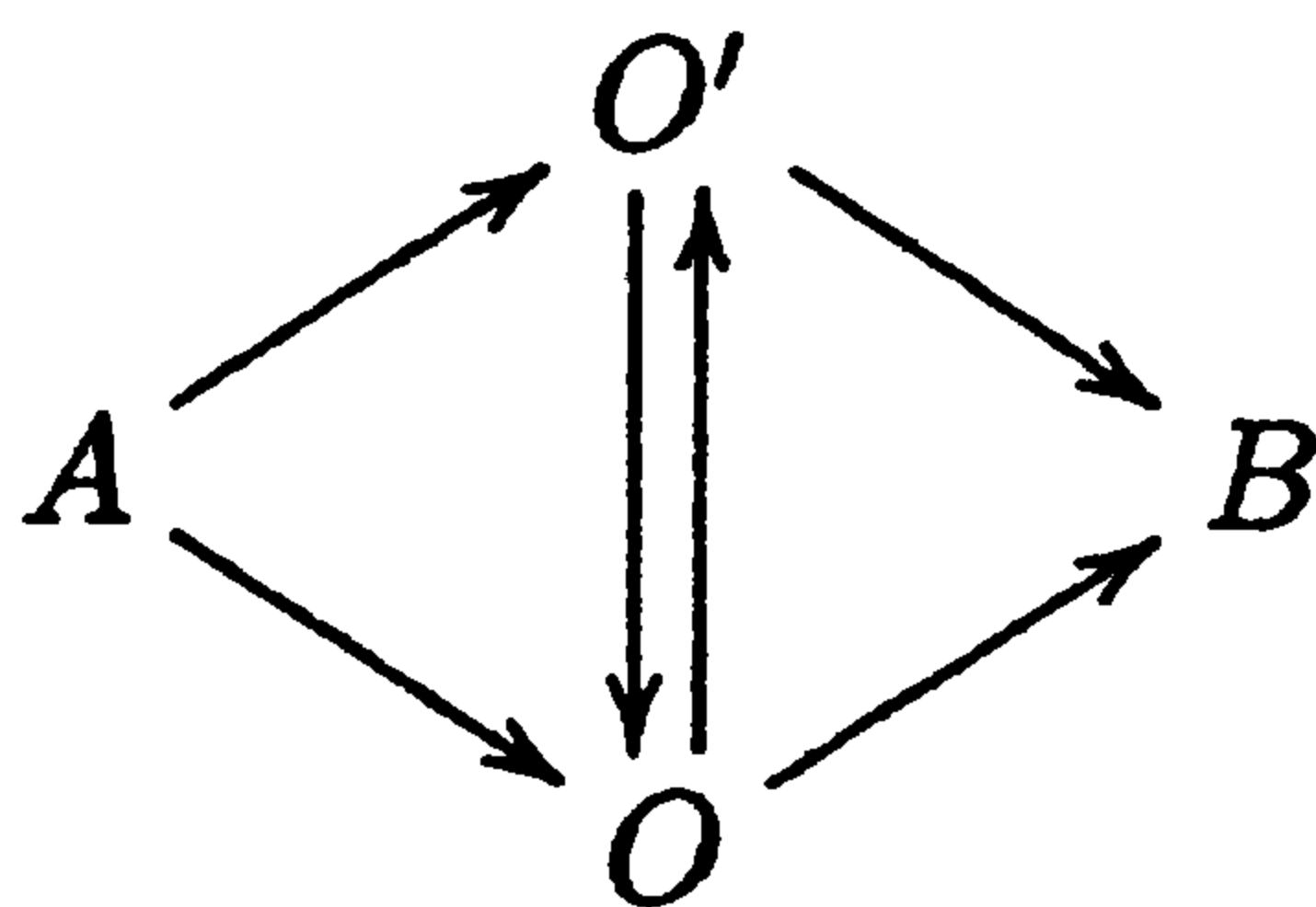

commutes.

9.  $0 \rightarrow A \rightarrow B$  is kernel-exact iff  $0 \rightarrow \ker(A \rightarrow B)$  is epic iff  $A \rightarrow B$  is monic iff  $0 \rightarrow A \rightarrow B$  is cokernel-exact.
10. Since  $\widehat{p}$  is epic,  $q$  is a cokernel for  $\widehat{j}$ , so that  $\widehat{j}$  is a kernel for  $q$  by Proposition 7.12(iv).
11. Suppose the composite of two kernels is a kernel. Then the proof of Proposition 7.11(b) works, so any  $f : A \rightarrow B$  factors  $f = jp$  with  $p$  being epic and  $j$  being a kernel. If  $f$  is monic, then so is  $p$ . If  $A$  is balanced, then  $p$  is an isomorphism, so  $f$  is now a kernel.
13. Suppose  $\varphi$  is a kernel for  $f : B \rightarrow C$ . Then  $f = g\pi$  for some  $g : D \rightarrow C$ . If  $\psi : E \rightarrow B$  satisfies  $\pi\psi = 0$ , then  $f\psi = g\pi\psi = 0$  as well, so that  $\psi = \varphi\bar{\psi}$  for a unique  $\bar{\psi}$ .

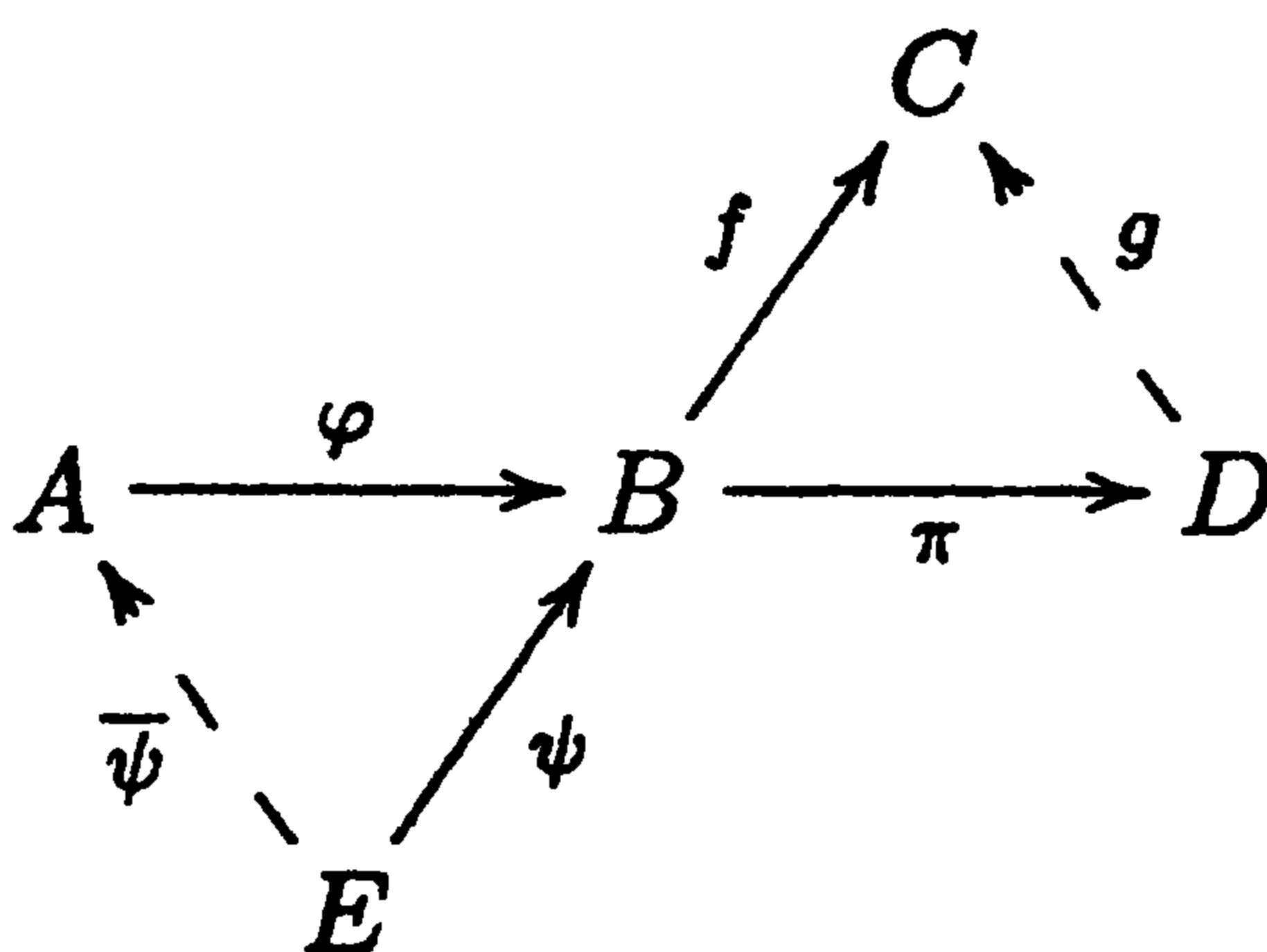

17. Let  $j : K \rightarrow A_2$  denote a kernel for  $\pi$ , and  $j' : K' \rightarrow B_2$  a kernel for  $\rho$ . We have a diagram,

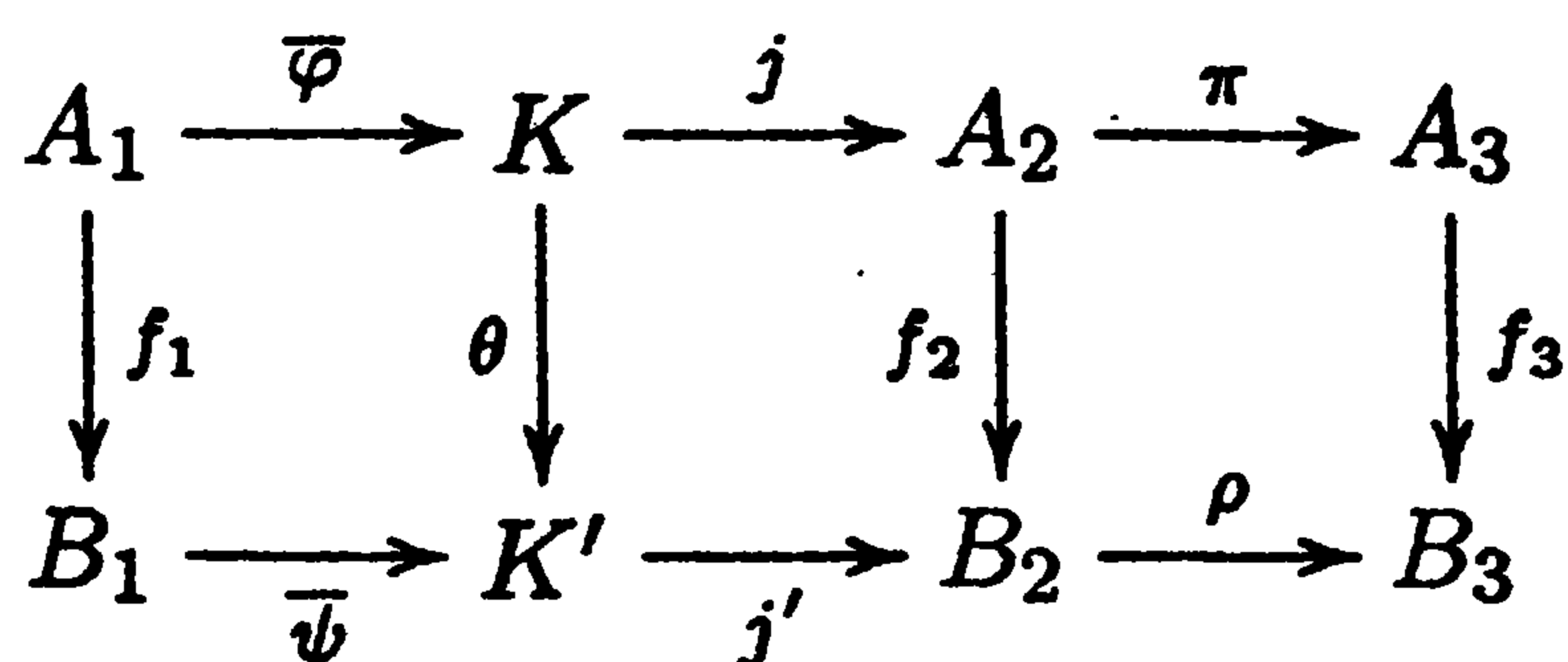

in which  $j'\theta = f_2j = (\psi D_2 + D_3\pi)j = \psi D_2j = j'\bar{\psi}D_2j$ , so  $\theta = \bar{\psi}D_2j$ . Hence, the induced morphism from  $K$  to  $\text{coker } \bar{\psi}$  (which is the homology of  $B_1 \rightarrow B_2 \rightarrow B_3$ ) is zero.

21a) Suppose  $\varphi_i : P_i \rightarrow P$  defines  $P$  as a coproduct of projective  $P_i$ . Given  $f : P \rightarrow B$  and an epimorphism  $\pi : A \rightarrow B$ , fillers  $g_i$  exist:

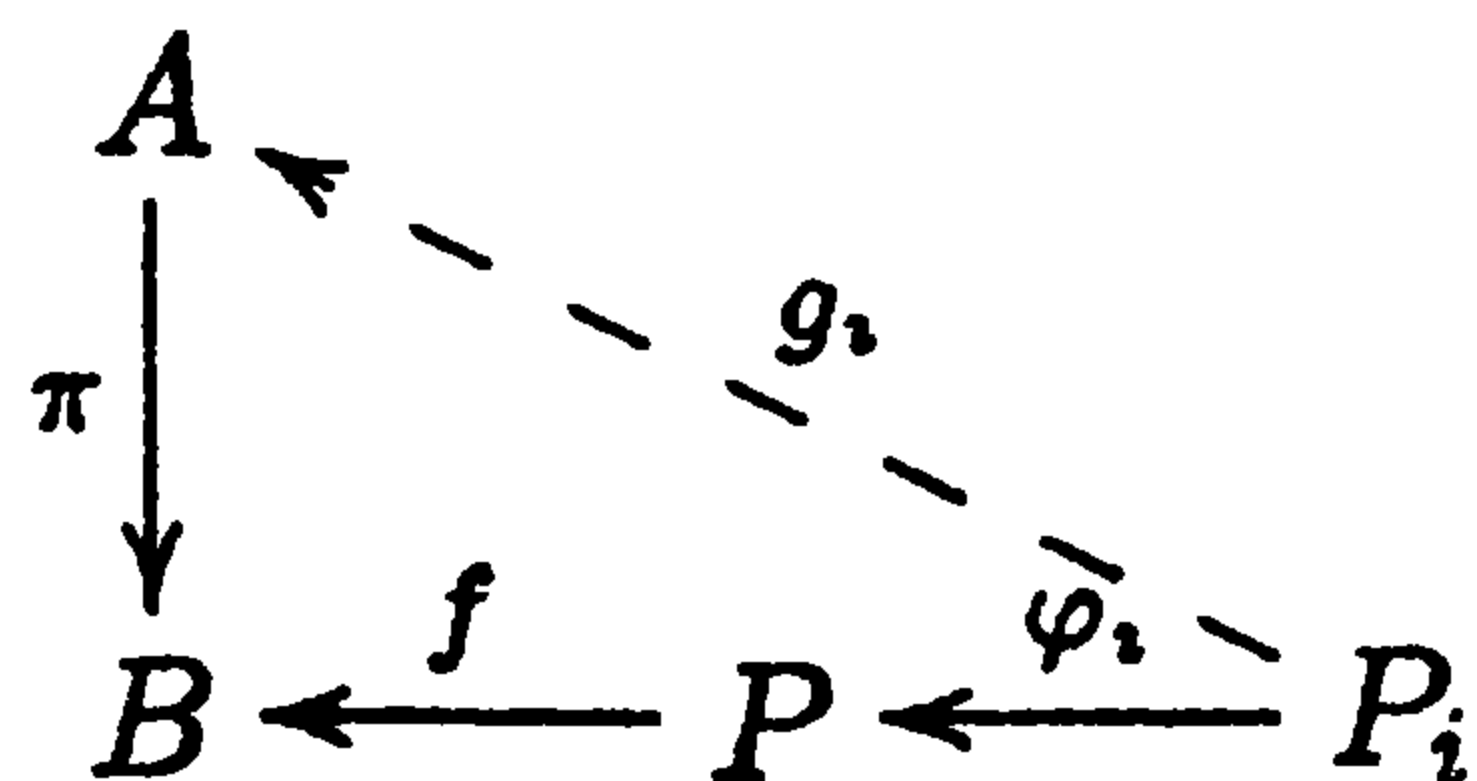

Also, a filler  $g$  exists for all diagrams

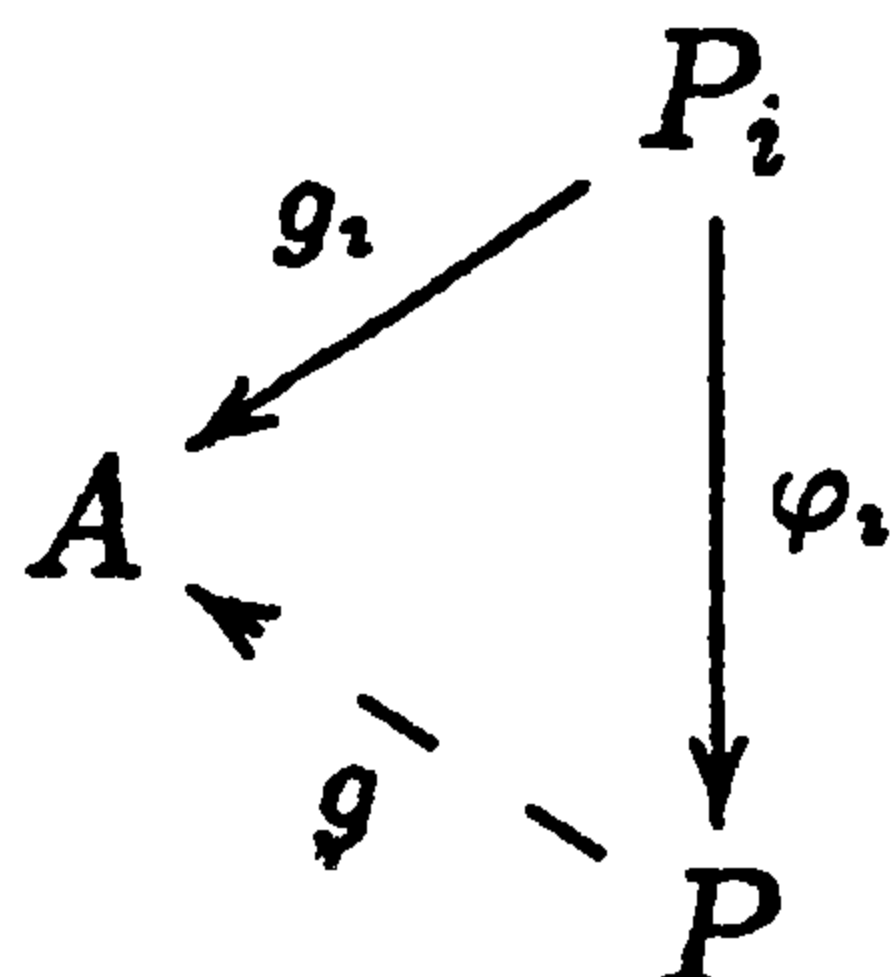

But now  $\pi g \varphi_i = \pi g_i = f \varphi_i$ , so both  $\pi g$  and  $f$  are fillers for all diagrams

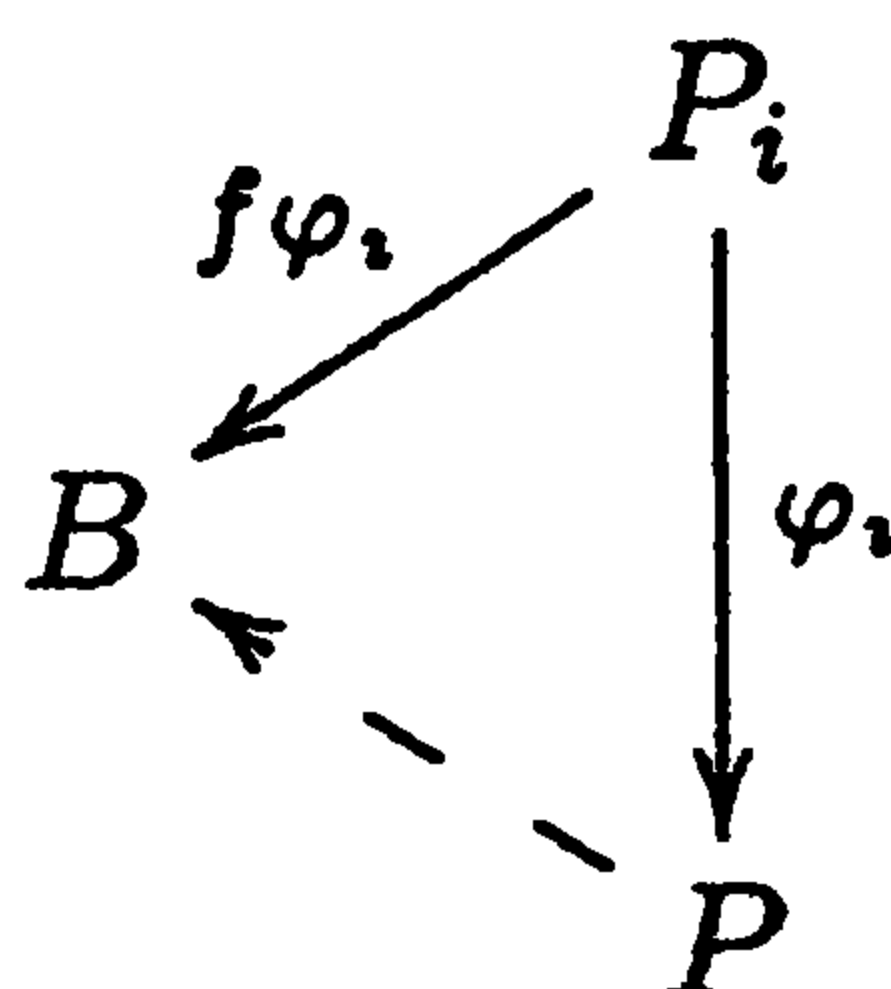

By uniqueness of fillers,  $\pi g = f$ , and  $g$  is a filler for

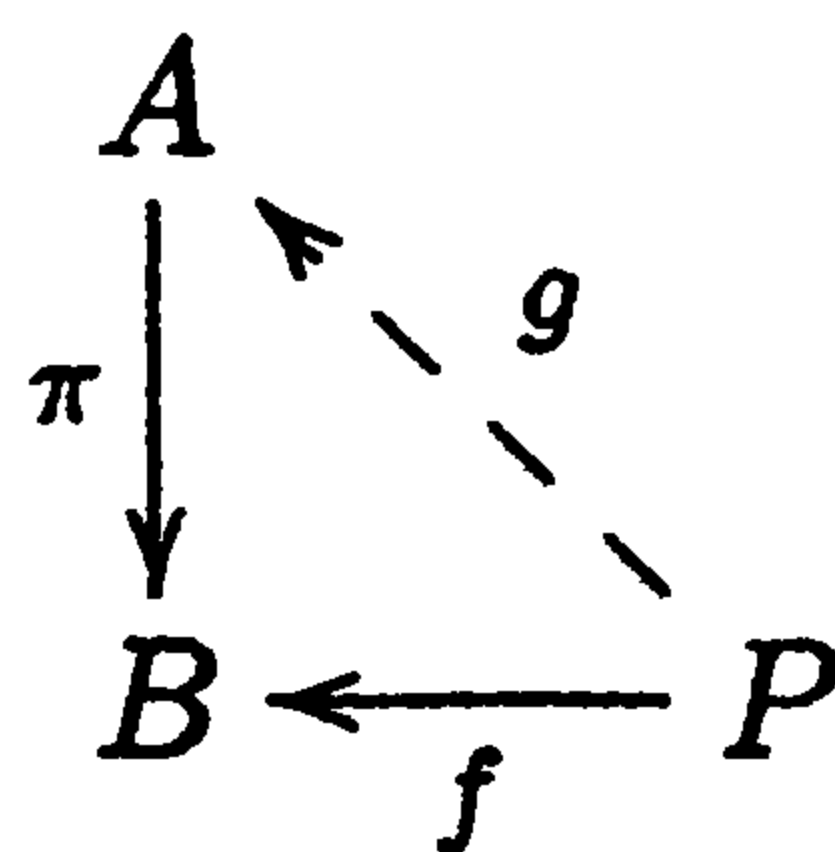

Part (b) is similar.

### Chapter 8

2. The subtle point is that  $F(0) = 0$ , since  $0 = \text{colim}_{\mathcal{I}} B_i$  when  $\mathcal{I} = \emptyset$ .

7. The diagram is

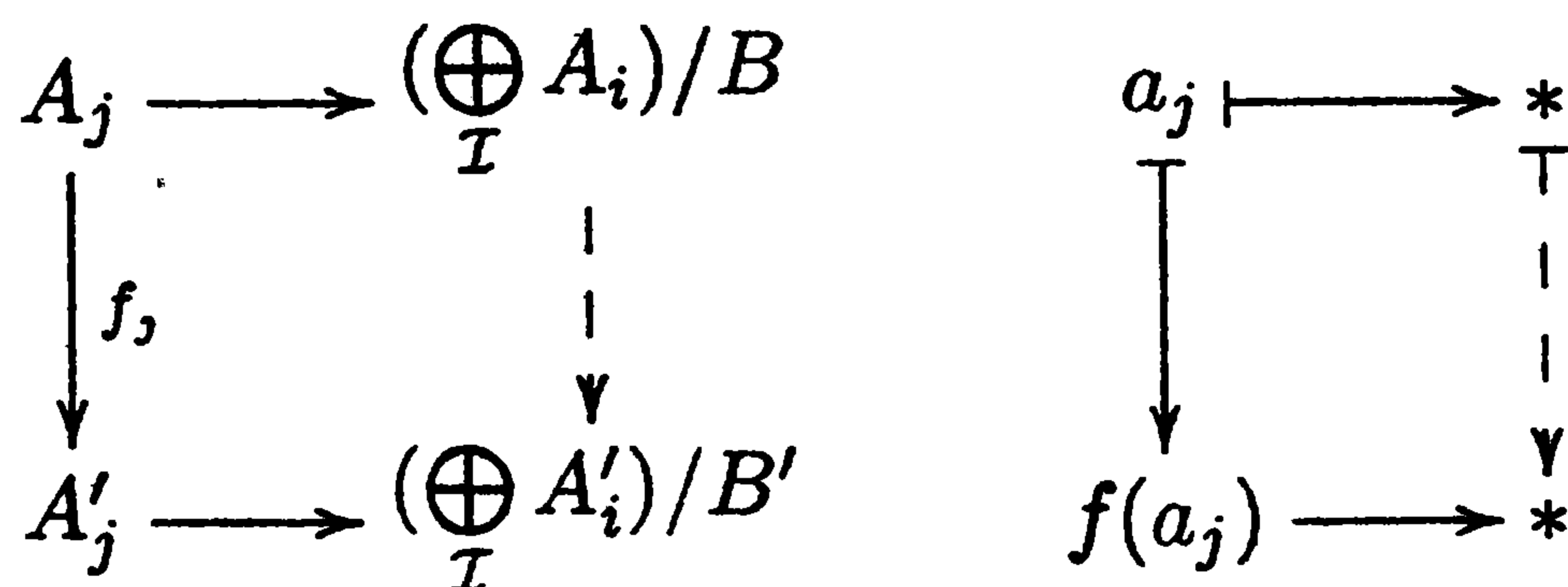





# References

- [1] Ahlfors, Lars. *Complex Analysis*, 3rd ed., New York: McGraw-Hill, 1979.
- [2] Artin, Michael. *Algebra*, Englewood Cliffs, NJ: Prentice Hall, 1991.
- [3] Ausmus, E.F. On the homology of local rings, *Ill. J. Math.* **3** 187–199, 1959.
- [4] Baer, Reinhold. Abelian groups that are direct summands of every containing Abelian group, *Bull. A. M. S.* **46** 800–806, 1940.
- [5] Bass, Hyman. *Global Dimension of Rings*, Ph.D. Thesis, U. Chi., 1959.
- [6] Bass, Hyman. Injective dimension in Noetherian rings, *TAMS* **102** 18–29, 1962.
- [7] Bkouche, R. Pureté, molesse et paracompacité, *Comptes Rendus Acad. Sci. Paris, Ser. A* **270**, 1653–1655, 1970.
- [8] Borceaux, Francis. *Handbook of Categorical Algebra*, 3 vols. Cambridge: Cambridge U. Press, 1994.
- [9] Bourbaki, N. *Algèbre—Chapitre 10: Algèbre homologique*, Paris: Masson, 1980.
- [10] Cartan, Henri, and Eilenberg, Samuel. *Homological Algebra*, Princeton: Princeton U. Press, 1956.

- [11] Chase, Stephen. Direct products of modules, *TAMS* **97**, 457–473, 1960.
- [12] Ciesielski, Krzysztof. *Set Theory for the Working Mathematician*, Cambridge: Cambridge U. Press, 1997.
- [13] Cohen, I.S. Commutative rings with restricted minimum condition, *Duke Math. J.* **17**, 27–42, 1950.
- [14] Cohn, P.M. *Algebra*, vol. 2, New York: John Wiley & Sons, 1989.
- [15] Devlin, Keith. *The Joy of Sets*, New York: Springer-Verlag, 1993.
- [16] Drake, Frank. *Set Theory—An Introduction to Large Cardinals*, Amsterdam: North-Holland, 1974.
- [17] Dummit, David, and Foote, Richard. *Abstract Algebra*, 2nd ed, Upper Saddle River, NJ: Prentice Hall, 1999.
- [18] Farb, Benson, and Dennis, R. Keith. *Noncommutative Algebra*, New York: Springer-Verlag, 1993.
- [19] Finney, Ross, and Rotman, Joseph. Paracompactness of locally compact Hausdorff spaces, *Michigan Math. J.* **17**, 359–361, 1970.
- [20] Freyd, Peter. *Abelian Categories*, New York: Harper & Row, 1964.
- [21] Gelfand, Sergei, and Manin, Yuri. *Methods of Homological Algebra*, New York: Springer-Verlag, 1996.
- [22] Gillman, Leonard, and Jerison, Meyer. *Rings of Continuous Functions*, Princeton: Van Nostrand, 1960.
- [23] Gilmer, Robert. *Multiplicative Ideal Theory*, New York: Marcel-Dekker, 1972.
- [24] Gilmer, Robert. Commutative rings in which each prime ideal is principal, *Math. Ann.* **183**, 151–158, 1969.
- [25] Goodearl, K.R., and Warfield, R.B. *An Introduction to Noncommutative Noetherian Rings*, Cambridge: Cambridge U. Press, 1989.
- [26] Greenberg, Marvin, and Harper, John. *Algebraic Topology—A First Course*, Reading, MA: Benjamin/Cummings, 1981.
- [27] Halmos, Paul. *Naive Set Theory*, New York: Springer-Verlag, 1970.
- [28] Helmer, Olaf. Divisibility properties of integral functions, *Duke Math. J.* **6**, 345–356, 1940.
- [29] Henriksen, Melvin. On the ideal structure of the ring of entire functions, *Pac. J. Math.* **2**, 179–184, 1952.

- [30] Henriksen, Melvin. On the prime ideals of the ring of entire functions, *Pac. J. Math.* **3**, 711–720, 1953.
- [31] Herrlich, Horst, and Strecker, George. *Category Theory, An Introduction*, Berlin: Heldermann, 1979.
- [32] Herstein, I.N. *Noncommutative Rings*, Menasha, WI: MAA, 1968.
- [33] Hilton, Peter. *Lectures in Homological Algebra*, Providence: AMS, 1971.
- [34] Hilton, Peter, and Stammbach, Urs. *A Course in Homological Algebra*, New York: Springer-Verlag, 1997.
- [35] Hodges, W. Six impossible rings, *J. Alg.* **31**, 218–244, 1974.
- [36] Hu, Sze-Tsen. *Introduction to Homological Algebra*, San Francisco: Holden-Day, 1968.
- [37] Hungerford, Thomas. *Algebra*, New York: Springer-Verlag, 1974.
- [38] Hutchins, Harry. *Examples of Commutative Rings*, Washington, NJ: Polygonal Publishing, 1981.
- [39] Isaacs, I. Martin. *Algebra—A Graduate Course*, Pacific Grove, CA: Brooks/Cole, 1994.
- [40] Jans, James. *Rings and Homology*, New York: Holt, Rinehart & Winston, 1964.
- [41] Just, Winfried, and Weese, Martin. *Discovering Modern Set Theory I: The Basics*, Providence: AMS, 1996.
- [42] Kanamori, Akihiro. *The Higher Infinite*, New York: Springer-Verlag, 1994.
- [43] Kaplansky, Irving. Elementary divisors and modules, *TAMS* **66**, 464–491, 1949.
- [44] Kaplansky, Irving. Projective modules, *Ann. Math.* **68**, 372–377, 1958.
- [45] Kaplansky, Irving. *Commutative Rings (Queen Mary Notes)*, London: Queen Mary College, 1968.
- [46] Kaplansky, Irving. *Commutative Rings*, Washington, NJ: Polygonal Publishing, 1974.
- [47] Kaplansky, Irving. *Fields and Rings*, Chicago: U. of Chicago Press, 1972.
- [48] Kelley, John L. *General Topology*, New York: Springer-Verlag, 1975.

- [49] Lam, T.Y. *A First Course in Noncommutative Rings*, New York: Springer-Verlag, 1991.
- [50] Lang, Serge. *Algebra*, 2nd ed., Menlo Park, CA: Addison-Wesley, 1984.
- [51] Lazard, Daniel. Sur les modules plats, *Comptes Rendus Acad. Sc. Paris* **258**, 6313–6316, 1964.
- [52] MacLane, Saunders. *Categories for the Working Mathematician*, New York: Springer-Verlag, 1971.
- [53] MacLane, Saunders. *Homology*, New York: Springer-Verlag, 1975.
- [54] Massey, William. *A Basic Course in Algebraic Topology*, New York: Springer-Verlag, 1991.
- [55] Matsumura, Hideyuki. *Commutative Algebra*, Reading, MA: Benjamin/Cummings, 1980.
- [56] McCoy, Neal. *Rings and Ideals*, Menasha, WI: MAA, 1948.
- [57] Mitchell, Barry. *Theory of Categories*, New York: Academic Press, 1965.
- [58] Müller, Gert, ed. *Sets and Classes*, Amsterdam: North-Holland, 1976.
- [59] Nagata, Masayoshi. *Local Rings*, New York: Wiley Interscience, 1962.
- [60] Northcott, D.G. *A First Course in Homological Algebra*, Cambridge: Cambridge U. Press, 1973.
- [61] Osofsky, Barbara. Global dimension of commutative rings with linearly ordered ideals, *J. London Math. Soc.* **44**, 183–185, 1969.
- [62] Osofsky, Barbara. A commutative local ring with finite global dimension and zero divisors, *TAMS* **141**, 377–384, 1969.
- [63] Osofsky, Barbara. *Homological Dimensions of Modules*, Providence: AMS, 1973.
- [64] Pareigis, Bodo. *Categories and Functors*, New York: Academic Press, 1970.
- [65] Papp, Zoltan. On algebraically closed modules, *Publ. Math. Debrecen* **6**, 311–327, 1959.
- [66] Popescu, Nicolae. *Abelian Categories with Applications to Rings and Modules*, New York: Academic Press, 1973.
- [67] Popescu, Nicolae, and Popescu, Liliana. *Theory of Categories*, Bucharest: Sijthoff and Noordhoff, 1979.

- [68] Rotman, Joseph. *An Introduction to Homological Algebra*, San Diego: Academic Press, 1979.
- [69] Rowan, Louis. *Ring Theory*, San Diego: Academic Press, 1991.
- [70] Rudin, Walter. *Real and Complex Analysis*, 3rd ed., New York: McGraw-Hill, 1987.
- [71] Small, Lance. An example in Noetherian rings, *Proc. N.A.S.* 54, 1035–1036, 1965.
- [72] Steen, L.A., and Seebach, J.A. *Counterexamples in Topology*, 2nd ed., New York: Springer-Verlag, 1978.
- [73] Vaught, Robert. *Set Theory—An Introduction*, Boston: Birkhäuser, 1985.
- [74] Watts, Charles. Intrinsic characterizations of some additive functors, *Proc. AMS* 11, 5–8, 1960.
- [75] Weibel, Charles. *An Introduction to Homological Algebra*, Cambridge: Cambridge U. Press, 1994.
- [76] Weiss, Edwin. *Algebraic Number Theory*, New York: McGraw-Hill, 1963.





# Symbol Index

- Ab**, 4
- ann, 83
- $\bullet(\rightarrow)$ , 202
- Bil, 21
- $B^*$ , 79
- $\sqcap$ , 323
- Ch**, 47
- $\sqcup$ , 318
- $\oplus$ , 12
- End, 85
- Ext, 45
- $\mathcal{F}(\bullet)$ , 350
- F-dim , 74
- Gr**, 3
- $\overline{H}$ , 221
- Haus**, 166
- Hom, 13, 169
- $\mathcal{I}(\bullet)$ , 350
- I-dim , 74
- $J(\bullet)$ , 324
- LG-dim , 74
- lim, 258
- $\mathcal{L}_n$ , 126, 224
- $\mathcal{L}^n$ , 128, 225
- $\langle \bullet_i, \bullet_{ij} \rangle$ , 258
- $M_n(\bullet)$ , 86
- Mor, 2
- ${}_R\mathbf{M}$ , 11
- $\mathbf{M}_R$ , 11
- ${}_R\mathbf{M}_S$ , 11
- Nat( $F, G$ ), 154
- $n$ th cokernel, 77
- $n$ th kernel, 76
- obj, 2
- $\bullet^{\text{OP}}$ , 3
- $\prod$ , 11
- P-dim , 74
- $Q\mathcal{L}^n$ , 244
- RG-dim , 74
- $\mathcal{R}_n$ , 128, 225

$\mathcal{R}^n$ , 128, 225

$R^{\text{op}}$ , 69

$S(\bullet)$ , 349

**Set**, 2

$R\text{Sh}$ , 140

**Sm**, 8

SP-dim , 100

$\bullet_*$ , 13

$\bullet^*$ , 13, 79

$\otimes$ , 15

**Top**, 3

**Top** $_*$ , 166

**Tor**, 43

$V_\alpha$ , 152

W-dim , 74

# Index

- $R^{\text{op}}$ , 69
- $\mathcal{I}$ -cotarget, 259
- $\mathcal{I}$ -target, 259
- F-dim , 74
- I-dim , 74
- LG-dim , 74
- P-dim , 74
- RG-dim , 74
- W-dim , 74
- $n$ th cokernel, 77
- $n$ th kernel, 76
- “hairy” sets, 10
- 5-Lemma, 191
- 5-lemma, 23
  - short, 215
- 9-lemma, 253
  
- Ab-epic, 182
- Ab-monic, 182
- Abelian, 182
- absolute continuity, 284
- absolute direct summand, 33
- additive, 123
- additive category, 169
- additivity, 41, 123
  - strong, 99
- adjoint, 265
- admissible filter, 350
- admissible multiplicative subset,
  - 110
- arrow category, 202
- Artin–Wedderburn Structure Theorem, 87
- augmented category, 169
- Auslander’s Lemma, 355
- axiom of replacement, 8
  
- balanced category, 166
- Bezout domain, 92, 340, 347
- bilinear, 14
- bimorphism, 165
- biproduct, 12, 171, 206
- Bockstein sequence, 320
  
- cardinal Krull dimension, 354
- categories
  - functor, 212
  - small, 8
- category, 2
  - additive, 169

- arrow, 202
- augmented, 169
- balanced, 166
- chain complex, 47
- chain map, 62
- cheating, 186
- class, 1
  - proper, 1
- cochain complex, 47
- cofinal, 260
- coimage, 184, 218
- cokernel, 174, 205
- cokernel<sup>\*</sup>, 243
- cokernel-exact, 178
- colimit, 259
- colimiting system, 259
- commutative diagram, 4, 5
- complex, 39
  - cochain, 47
- complex, chain, 47
- concrete, 3
- conglomerates, 151
- connecting homomorphism, 51
- contravariant functor, 7
- coproducts, 6, 12
- coseparating class of injectives, 168
- coseparator, 36
- covariant functor, 7
- cover, 290
  
- Dedekind domain, 82
- diagram chase, 24
- dimension
  - flat, 74
  - injective, 74
  - left global, 74
  - projective, 74
  - right global, 74
  - Supremal Projective, 100
  - weak, 74
- divisible, 32
- domain
  - Bezout, 92, 340, 347
  - GCD, 94, 340
- endomorphism ring, 85
- enough injectives, 32, 168
- enough projectives, 30, 168
- enough quasiprojectives, 242
- envelope
  - injective, 288
- epic, 205
- epimorphism, 165
- essential extension, 285
- exact, 22, 24, 186, 241
- exact sequence
  - Künneth, 301
  - Ker-Coker, 227
  - long, 235
  - long homology, 232
- Ext, 45
- Ext product, 318
- extension
  - essential, 285
  
- faithful, 264
- Fatou lemma, 284
- fillers, 6
- filter, 349
- final object, 166
- finitely presented, 80
- flat, 28
- flat dimension, 74
- Flat Dimension Theorem, 77
- flat resolution, 55
- Flat Test Lemma, 37
- forgetful functor, 8
- free, 4
- free modules, 12
- full, 8
- full subcategory, 8
- functor
  - contravariant, 7
  - covariant, 7
  - forgetful, 8
  - left derived, 126
  - left quasiderived, 244
  - right derived, 128
- functor categories, 212
- functors



- left derived, 224
- right derived, 225
- Fundamental Theorem of Tensor Products, 20
- GCD, 338
- GCD domain, 94, 340
- Global Dimension Theorem, 78
- greatest common divisor, 337
- half exact, 24, 125, 241
- hereditary
  - left, 78
- Hilbert's Syzygy Theorem, 110
- homology, 221
- homomorphism
  - connecting, 51
  - Künneth, 299
- homotopy, 40
- Horseshoe Lemma, 134
- image, 184, 218
- initial object, 166
- injective, 28, 167
- injective dimension, 74
- Injective Dimension Theorem, 77
- injective envelope, 288
- injective resolution, 63, 179
- Injective Test Lemma, 30
- injectives
  - enough, 32
- irreducible, 338
- isomorphism, 4
- isomorphisms
  - Noether, 369
- Künneth exact sequence, 301
- Künneth homomorphism, 299
- ker-coker exact sequence, 133, 227
- kernel, 173, 204
- kernel-exact, 178
- Krull dimension, 332, 342, 354
  - cardinal, 354
- Lazard's Theorem, 279
- LCM, 338
- least common multiple, 337
- left adjoint, 266
- left derived functor, 126, 224
- left exact, 24, 241
- left global dimension, 74
- left hereditary, 78
- left quasiderived functor, 244
- left quasiregular, 324
- limit, 258
- local, 116
- local ring, 332
- localization, 116
- long exact sequence, 235
- long homology exact sequence, 232
- map
  - chain, 62
- maximal, 83
- members, 359
- Mitchell-Freyd Theorem, 360
- modules
  - free, 12
- monic, 205
- monomorphism, 165
- morphisms, 2
- multiplicative set, 341
- multiplicative subset
  - admissible, 110
- Nakayama's Lemma, 326
- natural transformation, 151
- Noether isomorphisms, 369
- nongenerator, 324
- object
  - final, 166
  - initial, 166
  - zero, 166
- opposite category, 3
- opposite ring, 87
- PID, 31
- post, 311

- pre-Abelian, 175
- presented
  - finitely, 80
- prime, 338
- principal, 350
- principal ideal domain, 337
- product, 5
  - tensor, 15
- products, 11
- projective, 28, 167, 206
  - enough, 168
- Projective Basis Theorem, 80
- projective dimension, 74
- Projective Dimension Theorem, 76
- projective resolution, 41, 179
- proper class, 1
- pullback, 263
- pullback square, 263, 364
- pushout, 263
- pushout square, 264
- pushouts, 365
  
- quasilocal, 116, 326
- quasiprojective, 242
- quasiprojective resolution, 243
- quasiprojectives
  - enough, 242
  
- rank, 332
- regular, 90, 152, 332
- resolution
  - flat, 55
  - injective, 63, 179
  - projective, 41, 179
  - quasiprojective, 243
- resolutions
  - simultaneous, 197
- right adjoint, 266
- right derived functor, 128, 225
- right exact, 24, 241
- right global dimension, 74
- right quasiregular, 324
- ring
  - endomorphism, 85
  - local, 332
  - opposite, 87
- ring of quotients, 111
- Russell paradox, 1
  
- Schur's Lemma, 86
- section, 23
- semisimple, 83
- separating class of projectives, 168
- sequence
  - Bockstein, 320
  - ker-coker exact, 133
  - short exact, 47
- sets 1, 152
  - "hairy", 10
- short 5-lemma, 37, 215
- short exact, 22, 47
- short exact sequence, 47
- simple, 83
- Simultaneous Resolution Theorem, 134
- simultaneous resolutions, 197
- Small, 102
- small categories, 8
- splits, 23
- strong additivity, 99
- strongly inaccessible, 152
- subcategory, 8
  - full, 8
- subquotient system, 274
- supremal projective dimension, 100
  
- tensor product, 15
- tensor products
  - fundamental theorem of, 20
- The Mittag-Leffler Theorem, 346
- The Weierstrass Product Theorem, 345
- Tor, 43
- transformation
  - natural, 151
- ultrafilter, 349

underexact, 39  
underlying set, 3  
uniform, 9  
unique factorization domain, 337  
universal mapping construction,  
6

Watts' Theorem, 280  
weak dimension, 74  
Weak Dimension Theorem, 79  
Yoneda Lemma, 154  
zero object, 166



# Graduate Texts in Mathematics

(continued from page 11)

- 72 STILLWELL. Classical Topology and Combinatorial Group Theory. 2nd ed.
- 73 HUNGERFORD. Algebra.
- 74 DAVENPORT. Multiplicative Number Theory. 2nd ed.
- 75 HOCHSCHILD. Basic Theory of Algebraic Groups and Lie Algebras.
- 76 IITAKA. Algebraic Geometry.
- 77 HECKE. Lectures on the Theory of Algebraic Numbers.
- 78 BURRIS/SANKAPPANAVAR. A Course in Universal Algebra.
- 79 WALTERS. An Introduction to Ergodic Theory.
- 80 ROBINSON. A Course in the Theory of Groups. 2nd ed.
- 81 FORSTER. Lectures on Riemann Surfaces.
- 82 BOTT/TU. Differential Forms in Algebraic Topology.
- 83 WASHINGTON. Introduction to Cyclotomic Fields. 2nd ed.
- 84 IRELAND/ROSEN. A Classical Introduction to Modern Number Theory. 2nd ed.
- 85 EDWARDS. Fourier Series. Vol. II. 2nd ed.
- 86 VAN LINT. Introduction to Coding Theory. 2nd ed.
- 87 BROWN. Cohomology of Groups.
- 88 PIERCE. Associative Algebras.
- 89 LANG. Introduction to Algebraic and Abelian Functions. 2nd ed.
- 90 BRØNDSTED. An Introduction to Convex Polytopes.
- 91 BEARDON. On the Geometry of Discrete Groups.
- 92 DIESTEL. Sequences and Series in Banach Spaces.
- 93 DUBROVIN/FOMENKO/NOVIKOV. Modern Geometry—Methods and Applications. Part I. 2nd ed.
- 94 WARNER. Foundations of Differentiable Manifolds and Lie Groups.
- 95 SHIRYAEV. Probability. 2nd ed.
- 96 CONWAY. A Course in Functional Analysis. 2nd ed.
- 97 KOBLITZ. Introduction to Elliptic Curves and Modular Forms. 2nd ed.
- 98 BROCKER/TOM DIECK. Representations of Compact Lie Groups.
- 99 GROVE/BENSON. Finite Reflection Groups. 2nd ed.
- 100 BERG/CHRISTENSEN/RESSEL. Harmonic Analysis on Semigroups: Theory of Positive Definite and Related Functions.
- 101 EDWARDS. Galois Theory.
- 102 VARADARAJAN. Lie Groups, Lie Algebras and Their Representations.
- 103 LANG. Complex Analysis. 3rd ed.
- 104 DUBROVIN/FOMENKO/NOVIKOV. Modern Geometry—Methods and Applications. Part II.
- 105 LANG.  $SL_2(\mathbb{R})$ .
- 106 SILVERMAN. The Arithmetic of Elliptic Curves.
- 107 OLVER. Applications of Lie Groups to Differential Equations. 2nd ed.
- 108 RANGE. Holomorphic Functions and Integral Representations in Several Complex Variables.
- 109 LEHTO. Univalent Functions and Teichmüller Spaces.
- 110 LANG. Algebraic Number Theory.
- 111 HUSEMÖLLER. Elliptic Curves.
- 112 LANG. Elliptic Functions.
- 113 KARATZAS/SHREVE. Brownian Motion and Stochastic Calculus. 2nd ed.
- 114 KOBLITZ. A Course in Number Theory and Cryptography. 2nd ed.
- 115 BERGER/GOSTIAUX. Differential Geometry: Manifolds, Curves, and Surfaces.
- 116 KELLEY/SRINIVASAN. Measure and Integral. Vol. I.
- 117 SERRE. Algebraic Groups and Class Fields.
- 118 PEDERSEN. Analysis Now.
- 119 ROTMAN. An Introduction to Algebraic Topology.
- 120 ZIEMER. Weakly Differentiable Functions: Sobolev Spaces and Functions of Bounded Variation.
- 121 LANG. Cyclotomic Fields I and II. Combined 2nd ed.
- 122 REMMERT. Theory of Complex Functions. *Readings in Mathematics*
- 123 EBBINGHAUS/HERMES et al. Numbers. *Readings in Mathematics*
- 124 DUBROVIN/FOMENKO/NOVIKOV. Modern Geometry—Methods and Applications. Part III.
- 125 BERENSTEIN/GAY. Complex Variables: An Introduction.
- 126 BOREL. Linear Algebraic Groups. 2nd ed.
- 127 MASSEY. A Basic Course in Algebraic Topology.
- 128 RAUCH. Partial Differential Equations.
- 129 FULTON/HARRIS. Representation Theory: A First Course. *Readings in Mathematics*
- 130 DODSON/POSTON. Tensor Geometry.
- 131 LAM. A First Course in Noncommutative Rings.
- 132 BEARDON. Iteration of Rational Functions.
- 133 HARRIS. Algebraic Geometry: A First Course.
- 134 ROMAN. Coding and Information Theory.
- 135 ROMAN. Advanced Linear Algebra.



- 136 ADKINS/WEINTRAUB. Algebra: An Approach via Module Theory.
- 137 AXLER/BOURDON/RAMEY. Harmonic Function Theory.
- 138 COHEN. A Course in Computational Algebraic Number Theory.
- 139 BREDON. Topology and Geometry.
- 140 AUBIN. Optima and Equilibria. An Introduction to Nonlinear Analysis.
- 141 BECKER/WEISPFENNING/KREDEL. Gröbner Bases. A Computational Approach to Commutative Algebra.
- 142 LANG. Real and Functional Analysis. 3rd ed.
- 143 DOOB. Measure Theory.
- 144 DENNIS/FARB. Noncommutative Algebra.
- 145 VICK. Homology Theory. An Introduction to Algebraic Topology. 2nd ed.
- 146 BRIDGES. Computability: A Mathematical Sketchbook.
- 147 ROSENBERG. Algebraic  $K$ -Theory and Its Applications.
- 148 ROTMAN. An Introduction to the Theory of Groups. 4th ed.
- 149 RATCLIFFE. Foundations of Hyperbolic Manifolds.
- 150 EISENBUD. Commutative Algebra with a View Toward Algebraic Geometry.
- 151 SILVERMAN. Advanced Topics in the Arithmetic of Elliptic Curves.
- 152 ZIEGLER. Lectures on Polytopes.
- 153 FULTON. Algebraic Topology: A First Course.
- 154 BROWN/PEARCY. An Introduction to Analysis.
- 155 KASSEL. Quantum Groups.
- 156 KECHRIS. Classical Descriptive Set Theory.
- 157 MALLIAVIN. Integration and Probability.
- 158 ROMAN. Field Theory.
- 159 CONWAY. Functions of One Complex Variable II.
- 160 LANG. Differential and Riemannian Manifolds.
- 161 BORWEIN/ERDÉLYI. Polynomials and Polynomial Inequalities.
- 162 ALPERIN/BELL. Groups and Representations.
- 163 DIXON/MORTIMER. Permutation Groups.
- 164 NATHANSON. Additive Number Theory: The Classical Bases.
- 165 NATHANSON. Additive Number Theory: Inverse Problems and the Geometry of Sumsets.
- 166 SHARPE. Differential Geometry: Cartan's Generalization of Klein's Erlangen Program.
- 167 MORANDI. Field and Galois Theory.
- 168 EWALD. Combinatorial Convexity and Algebraic Geometry.
- 169 BHATIA. Matrix Analysis.
- 170 BREDON. Sheaf Theory. 2nd ed.
- 171 PETERSEN. Riemannian Geometry.
- 172 REMMERT. Classical Topics in Complex Function Theory.
- 173 DIESTEL. Graph Theory. 2nd ed.
- 174 BRIDGES. Foundations of Real and Abstract Analysis.
- 175 LICKORISH. An Introduction to Knot Theory.
- 176 LEE. Riemannian Manifolds.
- 177 NEWMAN. Analytic Number Theory.
- 178 CLARKE/LEDYAEV/STERN/WOLENSKI. Nonsmooth Analysis and Control Theory.
- 179 DOUGLAS. Banach Algebra Techniques in Operator Theory. 2nd ed.
- 180 SRIVASTAVA. A Course on Borel Sets.
- 181 KRESS. Numerical Analysis.
- 182 WALTER. Ordinary Differential Equations.
- 183 MEGGINSON. An Introduction to Banach Space Theory.
- 184 BOLLOBAS. Modern Graph Theory.
- 185 COX/LITTLE/O'SHEA. Using Algebraic Geometry.
- 186 RAMAKRISHNAN/VALENZA. Fourier Analysis on Number Fields.
- 187 HARRIS/MORRISON. Moduli of Curves.
- 188 GOLDBLATT. Lectures on the Hyperreals: An Introduction to Nonstandard Analysis.
- 189 LAM. Lectures on Modules and Rings.
- 190 ESMONDE/MURTY. Problems in Algebraic Number Theory.
- 191 LANG. Fundamentals of Differential Geometry.
- 192 HIRSCH/LACOMBE. Elements of Functional Analysis.
- 193 COHEN. Advanced Topics in Computational Number Theory.
- 194 ENGEL/NAGEL. One-Parameter Semigroups for Linear Evolution Equations.
- 195 NATHANSON. Elementary Methods in Number Theory.
- 196 OSBORNE. Basic Homological Algebra.
- 197 EISENBUD/HARRIS. The Geometry of Schemes.
- 198 ROBERT. A Course in  $p$ -adic Analysis.
- 199 HEDENMALM/KORENBLUM/ZHU. Theory of Bergman Spaces.
- 200 BAO/CHERN/SHEN. An Introduction to Riemann–Finsler Geometry.
- 201 HINDRY/SILVERMAN. Diophantine Geometry: An Introduction.
- 202 LEE. Introduction to Topological Manifolds.